

# Medium Voltage Fuses



## Section Contents

	Page
<b>Introduction</b> . . . . .	<b>100</b>
<b>E-Rated Fuses</b>	
For transformers & feeders . . . . .	101-104
<b>CL-14 &amp; bolt-in</b> . . . . .	<b>105-107</b>
For potential & small power transformers . . . . .	108-110
<b>PT fuses</b> . . . . .	<b>111</b>
<b>R-Rated fuses for motor circuit protection</b> . . . . .	<b>112-114</b>
<b>British IEC fuses for motor circuit protection</b> . . . . .	<b>115</b>
<b>DIN IEC fuses for transformer protection</b> . . . . .	<b>116</b>
<b>Expulsion Fuse Links</b> . . . . .	<b>117-118</b>
<b>EEL-NEMA Type K &amp; T and Type H &amp; N fuses</b> . . . . .	<b>119</b>
<b>Fuseclips for medium and high voltage fuses</b> . . . . .	<b>120</b>



Scan this tag to get the latest product information for Medium Voltage Fuses.

Medium Voltage Fuses

## Medium Voltage Fuses

### Worldwide Circuit Protection Solutions

Bussmann is a world-leading supplier of medium voltage fuses. Each product is backed by an efficient worldwide distribution network with unrivaled service and technical support. Bussmann circuit protection solutions comply with major international standards: ANSI, BS, DIN, IEC and UL.

#### Fuse Types

Medium voltage fuses generally fit into two categories – expulsion fuses and current limiting fuses. The definitions per ANSI C37.40 are:

**Expulsion Fuse:** “A vented fuse in which the expulsion effect of the gases produced by internal arcing, either alone or aided by other mechanisms results in current interruption.” Expulsion fuses will limit the duration of an overcurrent event, but they will not limit the magnitude of fault current.

**Current Limiting Fuse:** “A fuse unit that, when in its current-responsive element is melted by a current within the fuse’s specified current-limiting range, abruptly introduces a high resistance to reduce current magnitude and duration, resulting in subsequent current interruption.” A current limiting fuse will reduce the magnitude a fault current as well as limit the duration of the overcurrent event when operating in its current limiting range. Bussmann offers a broad range of current limiting fuses for protection of feeders, transformers and motor circuits designed to ANSI, BS, DIN and IEC standards.

#### Medium Voltage Current Limiting Fuses

Current limiting fuses are classified into three categories:

1. Full Range – defined by ANSI C37.40 as “a fuse capable of interrupting all currents from the maximum rated interrupting current down to the minimum continuous current that causes the melting of the fusible element(s), when the fuse is applied at the maximum ambient temperature specified by the manufacturer.” It is able to interrupt any current that will melt its element.
2. General Purpose – defined by ANSI C37.40 as “a fuse capable of interrupting all currents from the maximum rated interrupting current down to the current that causes melting of the fusible element(s) in one hour.” Not all currents fall

within this range. It is possible for the fuse to be exposed to an overcurrent lower than the value given by the one hour criteria. In that case, a different overcurrent protection device would be required to interrupt the overcurrent.

3. Back-up – defined by ANSI C37.40 as “a fuse capable of interrupting all currents from the maximum interrupting rating current down to the minimum interrupting current.” The minimum interrupting current is the lowest current that the fuse will be able to clear properly. This creates a need to place a low current interrupting device, such as motor overloads, in series with the back-up rated fuse.

#### E- and R-Rated Fuses

In North America, current limiting fuses typically fall into the category of E-Rated fuses and R-Rated fuses. Bussmann also offers a wide range of current limiting fuses designed to BS, DIN and IEC standards.

E-Rated fuses are used to protect feeder circuits, power transformers and potential transformers. E-Rated fuses have defined current response times specified by ANSI C37.46. E-Rated fuses 100A and below must melt in 300sec at an rms current within the range of 200% to 240% of the continuous current rating. E-Rated fuses above 100A must melt in 600sec at an rms current within the range of 240% to 264% of the continuous current rating of the fuse. Bussmann offers a wide variety of full range and general purpose E-Rated fuses from 2.4kV up to 38kV.

R-Rated fuses are back-up fuses that provide short-circuit protection for motor circuits. They are applied with MV motor starters which provide the overload protection for the circuit. R-Rated fuses also have defined current response times specified by ANSI C37.46. R-Rated fuses will melt in a range of 15 – 35sec at a current equal to 100 times the “R” rating. Bussmann offers 2.4kV, 5.08kV, 7.2kV and 8.3kV R-Rated fuses for motor circuit protection.



# E-Rated Fuses for Transformers and Feeders

## MV155

### Specifications

**Description:** E-rated medium, voltage current-limiting fuses for transformer and feeder protection.



**Dimensions:** See Catalog Numbers table.

**Construction:** Silver ribbon element surrounded by silica filler housed in a fiberglass tube and plated endcaps. An epoxy paint protects the fuse tube from the surrounding environment.

### Ratings:

Volts: — 15.5kV (5-200A)

Amps: — 5-200A (15.5kV)

IR: — 50kA Sym. Max

**Agency Information:** Meets E requirements per ANSI C37.46, Meets full range requirements per ANSI C37.40.

### Features and Benefits

- MV155 Standard clip center distance of 15 and 18 inches with 2 and 3 inch barrel diameters for retrofitting in existing hardware
- Open fuse indicator for ease in troubleshooting
- Full range rating with 50kA Interrupting Rating
- Double pulsed at 90% of minimum I<sup>2</sup>t to establish manufacturing reliability

### MV155 Typical Applications

- 15.0kV Transformer Primary Protection
- 15.0kV Feeder Circuit Protection
- 15.0kV Voltage Switches
- 15.0kV Metal-enclosed Switchgear

### Dimensions - in

Diagram 1

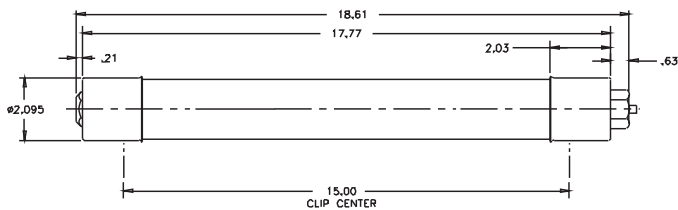
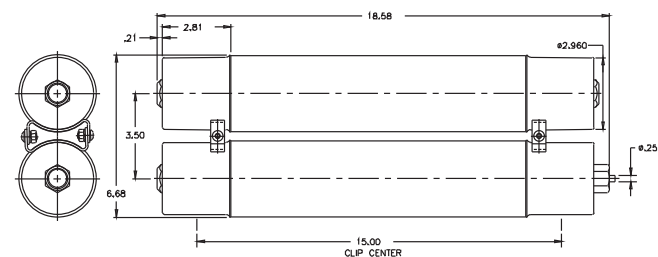

Diagram 2



### Data Sheet: 6700

### 15.5kV Catalog Numbers

Catalog Numbers	Amp Rating	Min Melt I <sup>2</sup> t	Max Clear I <sup>2</sup> t	Dimensions*			
				Length	Dia.	Clip Center	Barrels
MV155F1CBX5E	5	180	2,900	18.75	1	15	1
MV155F1CBX7E	7	850	8,000				
MV155F1CBX10E	10	850	8,000				
MV155F1CBX15E	15	2,070	12,000				
MV155F1CBX20E	20	2,370	23,000				
MV155F1CBX25E	25	4,650	31,000				
MV155F1CBX30E	30	9,490	45,000				
MV155F1DBX10E	10	850	8,000				
MV155F1DBX15E	15	2,070	12,000				
MV155F1DBX20E	20	2,370	23,000				
MV155F1DBX25E	25	4,650	31,000	21.75	2	18	2
MV155F1DBX30E	30	9,490	45,000				
MV155F1DBX40E	40	9,490	45,000				
MV155F1DBX50E	50	13,600	90,000				
MV155F1DBX65E	65	30,700	181,000				
MV155F1DBX80E	80	54,600	270,000				
MV155F1DBX100E	100	116,200	600,000				
MV155F2DBX125E	125	123,000	677,000				
MV155F2DBX150E	150	218,700	1,287,000				
MV155F2DBX175E	175	314,700	1,689,000				
MV155F2DBX200E	200	465,100	2,405,000	18	18	2	
MV155F1DCX65E	65	30,700	181,000				
MV155F1DCX80E	80	54,600	270,000				
MV155F1DCX100E	100	116,200	600,000				
MV155F2DCX125E	125	123,000	677,000				
MV155F2DCX150E	150	218,700	1,287,000				
MV155F2DCX175E	175	314,700	1,689,000	18	18	2	
MV155F2DCX200E	200	465,100	2,405,000				

\*1" = 25.4mm.

Recommended Fuse Clips - see page 120

### Data Sheet: 6701

## E-Rated Fuses for Transformer & Feeders

### JCX, JCY, JCU, JCZ and JDZ

#### Specifications

**Description:** Indoor/enclosure E-rated medium voltage, current-limiting fuses for feeders and power transformers with blown fuse indication.

**Dimensions:** See Catalog Numbers table.

**Construction:** plated ferrules.

#### Ratings:

Volts: — 2750-8300V - See Catalog Numbers table for details

Amps: — ½-750A

IR: — 40-63kA Sym

— 60-100kA ASYM

— See Catalog Numbers table for details

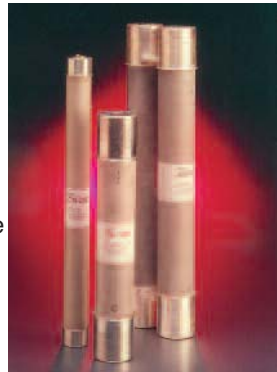

#### Features and Benefits

- Physically dimensioned for retrofitting in existing hardware
- Open fuse indicator for ease in troubleshooting
- Full range ANSI classification

#### Typical Applications

- Medium Voltage Transformer Primary Protection
- Medium Voltage Feeder Circuit Protection
- Medium Voltage Switches
- Medium Voltage Metal-enclosed Switchgear

#### Catalog Numbers

Catalog Numbers	Amp Rating	Maximum Design Voltage	Construction	Maximum Interrupting Capacity		Dimensions - in (mm)	
				Amps (Asym.)	Amps (Sym.)	Length	Diameter
<b>2400V; E-Rated; Indoor/Enclosure</b>							
JCX-1E	1	2750	Single	60,000	40,000	9.19 (233.38)	2 (50.8)
JCX-2E	2	2750	Single	60,000	40,000	9.19 (233.38)	2 (50.8)
JCX-3E	3	2750	Single	60,000	40,000	9.19 (233.38)	2 (50.8)
JCX-5E	5	2750	Single	60,000	40,000	9.19 (233.38)	2 (50.8)
JCX-7E	7	2750	Single	60,000	40,000	9.19 (233.38)	2 (50.8)
JCX-10E	10	2750	Single	60,000	40,000	9.19 (233.38)	2 (50.8)
JCX-15E	15	2750	Single	80,000	50,000	9.5 (241.3)	2.1 (53.34)
JCX-20E	20	2750	Single	80,000	50,000	9.5 (241.3)	2.1 (53.34)
JCX-25E	25	2750	Single	80,000	50,000	9.5 (241.3)	2.1 (53.34)
JCX-30E	30	2750	Single	80,000	50,000	10.81 (276.35)	3 (76.2)
JCX-40E	40	2750	Single	80,000	50,000	10.81 (276.35)	3 (76.2)
JCX-50E	50	2750	Single	80,000	50,000	10.81 (276.35)	3 (76.2)
JCX-65E	65	2750	Single	80,000	50,000	10.81 (276.35)	3 (76.2)
JCX-80E	80	2750	Single	80,000	50,000	10.81 (276.35)	3 (76.2)
JCX-100E	100	2750	Single	80,000	40,000	10.81 (276.35)	3 (76.2)
JCX-125E	125	2750	Single	80,000	50,000	10.81 (276.35)	3 (76.2)
JCX-150E	150	2750	Single	80,000	50,000	10.81 (276.35)	3 (76.2)
JCX-200E	200	2750	Single	80,000	50,000	10.81 (276.35)	3 (76.2)
JCX-225E	225	2750	Single	80,000	50,000	10.81 (276.35)	3 (76.2)
JCX-250E/280X	250/280	2750	Double	80,000	50,000	10.81 (276.35)	3 (76.2)
JCX-300E/325X	300/325	2750	Double	80,000	50,000	10.81 (276.35)	3 (76.2)
JCX-350X	350	2750	Double	80,000	50,000	10.81 (276.35)	3 (76.2)
JCX-400X	400	2750	Double	80,000	50,000	10.81 (276.35)	3 (76.2)
JCX-450X	450	2750	Double	80,000	50,000	10.81 (276.35)	3 (76.2)
<b>5500V; E-Rated; Indoor/Enclosure</b>							
JCY-½E	0.5	5500	Single	60,000	40,000	11.19 (284.18)	2 (50.8)
JCY-1E	1	5500	Single	60,000	40,000	11.19 (284.18)	2 (50.8)
JCY-2E	2	5500	Single	60,000	40,000	11.19 (284.18)	2 (50.8)
JCY-3E	3	5500	Single	60,000	40,000	11.19 (284.18)	2 (50.8)
JCY-5E	5	5500	Single	60,000	40,000	11.19 (284.18)	2 (50.8)
JCY-7E	7	5500	Single	60,000	40,000	11.19 (284.18)	2 (50.8)
JCY-10E	10	5500	Single	60,000	40,000	11.19 (284.18)	2 (50.8)
JCY-15E	15	5500	Single	60,000	40,000	11.19 (284.18)	2 (50.8)
JCY-20E	20	5500	Single	60,000	40,000	11.19 (284.18)	2 (50.8)
JCY-25E	25	5500	Single	60,000	40,000	11.19 (284.18)	2 (50.8)

Contact Bussmann for the latest product information on E-Rated fuses for transformer and feeder protection. Recommended fuseclips: see page 120 - 1A0065, 9078A67G04, A3354730



# E-Rated Fuses for Transformer & Feeders

## Catalog Numbers: E-Rated; Indoor/Enclosure

Catalog Numbers	Amp Rating	Maximum Design Voltage	Construction	Maximum Interrupting Capacity		Dimensions - in (mm)	
				Amps. (Asym.)	Amps. (Sym.)	Length	Diameter
<b>5500V; E-Rated; Indoor/Enclosure</b>							
JCU-10E	10	5500	Single	80,000	50,000	17.81 (452.4)	3 (76.2)
JCU-15E	15	5500	Single	80,000	50,000	12.88 (327.0)	2.1 (53.34)
JCU-20E	20	5500	Single	80,000	50,000	12.88 (327.0)	2.1 (53.34)
JCU-25E	25	5500	Single	80,000	50,000	12.88 (327.0)	2.1 (53.34)
JCU-30E	30	5500	Single	100,000	63,000	17.88 (454.15)	3 (76.20)
JCU-40E	40	5500	Single	100,000	63,000	17.88 (454.15)	3 (76.20)
JCU-50E	50	5500	Single	100,000	63,000	17.88 (454.15)	3 (76.20)
JCU-65E	60	5500	Single	100,000	63,000	17.88 (454.15)	3 (76.20)
JCU-80E	80	5500	Single	100,000	63,000	17.88 (454.15)	3 (76.20)
JCU-100E	100	5500	Single	100,000	63,000	17.88 (454.15)	3 (76.20)
JCU-125E	125	5500	Single	100,000	63,000	17.88 (454.15)	3 (76.20)
JCU-150E	150	5500	Single	100,000	63,000	17.88 (454.15)	3 (76.20)
JCU-175E	175	5500	Single	100,000	63,000	17.88 (454.15)	3 (76.20)
JCU-200E	200	5500	Single	100,000	63,000	17.88 (454.15)	3 (76.20)
JCU-250E	250	5500	Single	100,000	63,000	17.88 (454.15)	3 (76.20)
JCU-300E	300	5500	Double	100,000	63,000	17.88 (454.15)	3 (76.20)
JCU-350E	350	5500	Double	100,000	63,000	17.88 (454.15)	3 (76.20)
JCU-400E	400	5500	Double	100,000	63,000	17.88 (454.15)	3 (76.20)
JCU-450E	450	5500	Double	100,000	63,000	17.88 (454.15)	3 (76.20)
JCU-600E	600	5500	*	80,000	50,000	28.81 (731.77)	4 (101.60)
JCU-750E	750	5500	*	80,000	50,000	28.81 (731.77)	4 (101.60)
<b>8300V; E-Rated; Indoor/Enclosure</b>							
JCZ-15E	15	8300	Single	80,000	50,000	15.51 (393.95)	2.1 (53.34)
JCZ-20E	20	8300	Single	80,000	50,000	15.51 (393.95)	2.1 (53.34)
JCZ-25E	25	8300	Single	80,000	50,000	15.51 (393.95)	2.1 (53.34)
JCZ-30E	30	8300	Single	80,000	50,000	17.88 (454.15)	3 (76.2)
JCZ-40E	40	8300	Single	80,000	50,000	17.88 (454.15)	3 (76.2)
JCZ-50E	50	8300	Single	80,000	50,000	17.88 (454.15)	3 (76.2)
JCZ-65E	65	8300	Single	80,000	50,000	17.88 (454.15)	3 (76.2)
JCZ-80E	80	8300	Single	80,000	50,000	17.88 (454.15)	3 (76.2)
JCZ-100E	100	8300	Single	80,000	50,000	17.88 (454.15)	3 (76.2)
JCZ-125E	125	8300	Single	80,000	50,000	17.88 (454.15)	3 (76.2)
JCZ-150E	150	8300	Single	80,000	50,000	17.88 (454.15)	3 (76.2)
JCZ-200E	200	8300	Double	80,000	50,000	17.88 (454.15)	3 (76.2)
JDZ-20E	20	8300	Single	80,000	50,000	15.88 (403.2)	3 (76.2)
JDZ-25E	25	8300	Single	80,000	50,000	15.88 (403.2)	3 (76.2)
JDZ-30E	30	8300	Single	80,000	50,000	15.88 (403.2)	3 (76.2)
JDZ-40E	40	8300	Single	80,000	50,000	15.88 (403.2)	3 (76.2)
JDZ-50E	50	8300	Single	80,000	50,000	15.88 (403.2)	3 (76.2)
JDZ-65E	65	8300	Single	80,000	50,000	15.88 (403.2)	3 (76.2)
JDZ-80E	80	8300	Double	80,000	50,000	15.88 (403.2)	3 (76.2)
JDZ-100E	100	8300	Double	80,000	50,000	15.88 (403.2)	3 (76.2)
JDZ-125E	125	8300	Double	80,000	50,000	15.88 (403.2)	3 (76.2)

Recommended fuseclips: see page 120 - 1A0065, 9078A67G04, A3354730

General Notes:

1. All fuses are fitted with a striker pin which can be used for indication or tripping purposes.
2. The fuses are suitable for use either indoors or outdoors.
3. These fuses are interchangeable with corresponding fuses produced by most other leading North American manufacturers.

Contact Bussmann for the latest product information on E-Rated fuses for transformer and feeder protection.

\*Bolt on mounting

## E-Rated Fuses: CL-14 & Bolt-In

### ECL055

#### Specifications

**Description:** E-rated medium voltage, current-limiting fuses for transformer and feeder protection.

**Construction:** Filament wound, glass epoxy fuse tube, with silica filler, and silver-plated copper terminals and endcaps containing a silver element in a double concentric helical configuration.

#### Ratings:

Volts: — 5.5kV

Amps: — 10-900A

IR: — 63kA Sym. Max

**Agency Information:** Meets E requirements per ANSI C37.46, Meets General Purpose requirements per ANSI C37.40.

#### Features and Benefits

- Clip-lock and bolt-in style available in double and triple barrel fuse designs for application flexibility
- The filament wound, glass epoxy fuse tube provides moisture protection for the fuse. This makes Cooper Bussmann medium voltage fuses suitable for both indoor and outdoor application (outdoor applications require installation inside an appropriate enclosure)
- Open fuse indication (indicator travel distance is 16mm) easily integrates into automation schemes
- 50/60Hz operating frequency make these fuses applicable world-wide

#### Typical Applications

- 5.0kV Transformer Primary Protection
- 5.0kV Feeder Circuit Protection
- 5.0kV Voltage Switches
- 5.0kV Metal-enclosed Switchgear

#### Dimensions - in

##### Single Barrel

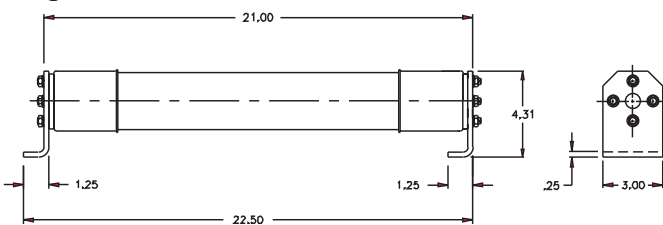

##### Double Barrel

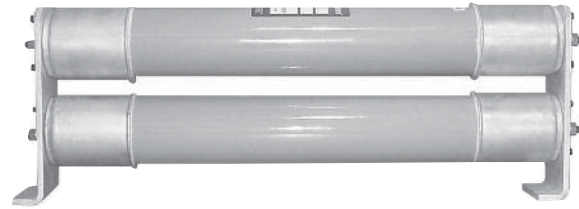
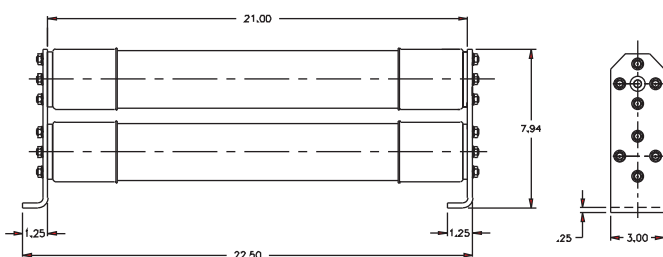

#### Catalog Numbers

Catalog Numbers	Amp Rating	Voltage	IR Max Sym.	# of Barrels	Style			
ECL055-10E	10	5.5kV	63kA	1	Clip-Lock			
ECL055-15E	15	—						
ECL055-20E	20	—						
ECL055-25E	25	—						
ECL055-30E	30	—						
ECL055-40E	40	—						
ECL055-50E	50	—						
ECL055-65E	65	—						
ECL055-80E	80	—						
ECL055-100E	100	—						
ECL055-125E	125	—						
ECL055-150E	150	—						
ECL055-200E	200	—						
ECL055-250E	250	—						
ECL055-300E	300	—						
ECL055-400E	400	—						
ECL055-450E	450	—						
ECL055-500E	500	—						
ECL055-600E	600	—						
ECL055-750E	750	—						
ECL055-900E	900	—						
					2	Clip-Lock		
							3	Bolt-In

#### Catalog Number Construction (Example)

Catalog Number	Voltage Rating	Amp Rating
ECL	055	500E
	055 = 5.5 kV	

#### Catalog Number Cross Reference

Bussmann Catalog Numbers	Mersen New Catalog #	Mersen Old Catalog #
ECL055-10E	A055C1DORO-10E	225-007-937
ECL055-15E	A055C1DORO-15E	225-007-938
ECL055-20E	A055C1DORO-20E	225-007-939
ECL055-25E	A055C1DORO-25E	225-007-940
ECL055-30E	A055C1DORO-30E	225-007-941
ECL055-40E	A055C1DORO-40E	225-007-942
ECL055-50E	A055C1DORO-50E	225-007-943
ECL055-65E	A055C1DORO-65E	225-007-944
ECL055-80E	A055C1DORO-80E	225-007-945
ECL055-100E	A055C1DORO-100E	225-007-946
ECL055-125E	A055C1DORO-125E	225-007-947
ECL055-150E	A055C1DORO-150E	225-007-948
ECL055-200E	A055C1DORO-200E	225-007-949
ECL055-250E	A055C1DORO-250E	225-007-950
ECL055-300E	A055C1DORO-300E	225-007-951
ECL055-400E	A055C1DORO-400E	225-007-952
ECL055-450E	A055C2DORO-450E	225-007-953
ECL055-500E	A055C2DORO-500E	225-007-954
ECL055-600E	A055C2DORO-600E	225-007-955
ECL055-750E	A055B3DORO-750E	A055X750E-4
ECL055-900E	A055B3DORO-900E	A055X900E-4

Data Sheet: 9002

# E-Rated Fuses: CL-14 & Bolt-In

## ECL083

### Specifications

**Description:** E-rated medium voltage, current-limiting fuses for transformer and feeder protection.

**Construction:** Filament wound, glass epoxy fuse tube, with silica filler, and silver-plated copper terminals and endcaps containing a silver element in a double concentric helical configuration.

### Ratings:

- Volts: — 8.3kV
- Amps: — 65-350A
- IR: — 50kA

**Agency Information:** Meets E requirements per ANSI C37.46, Meets General Purpose requirements per ANSI C37.40.

### Features and Benefits

- Clip-lock and bolt-in style available in double and triple barrel fuse designs for application flexibility
- The filament wound, glass epoxy fuse tube provides moisture protection for the fuse. This makes Cooper Bussmann medium voltage fuses suitable for both indoor and outdoor application (outdoor applications require installation inside an appropriate enclosure)
- Open fuse indication (indicator travel distance is 16mm) easily integrates into automation schemes
- 50/60Hz operating frequency make these fuses applicable world-wide

### Typical Applications

- 8.0kV Transformer Primary Protection
- 8.0kV Feeder Circuit Protection
- 8.0kV Voltage Switches
- 8.0kV Metal-enclosed Switchgear

### Dimensions - in

#### Single Barrel

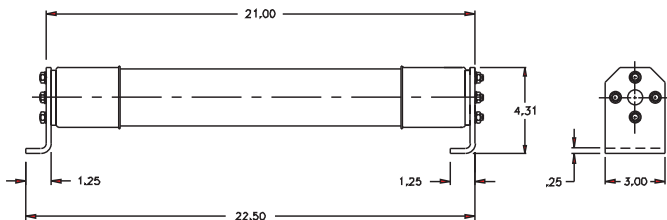

#### Double Barrel

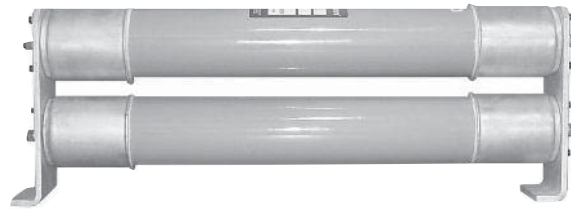
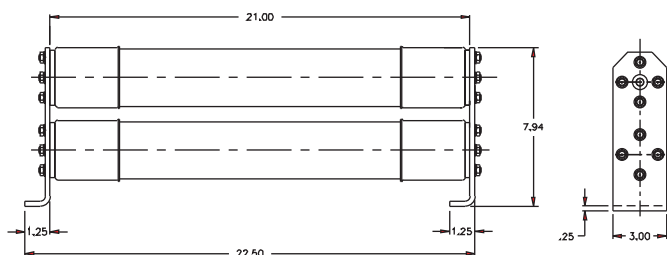

### Catalog Number Construction (Example)

Catalog Number	Voltage Rating	Amp Rating
ECL	083	300E
	083 = 8.3 kV	

### Electrical Characteristics

Part Number	Amps	Volts	IR Max Sym.	# of Barrels	Figure #	Style
ECL083-65E	65	8.3kV	50kA	1	1	Clip-Lock
ECL083-80E	80	8.3kV	50kA	1	1	Clip-Lock
ECL083-100E	100	8.3kV	50kA	1	1	Clip-Lock
ECL083-125E	125	8.3kV	50kA	1	1	Clip-Lock
ECL083-150E	150	8.3kV	50kA	1	1	Clip-Lock
ECL083-175E	175	8.3kV	50kA	1	1	Clip-Lock
ECL083-200E	200	8.3kV	50kA	2	2	Clip-Lock
ECL083-250E	250	8.3kV	50kA	2	2	Clip-Lock
ECL083-300E	300	8.3kV	50kA	2	2	Clip-Lock
ECL083-350E	350	8.3kV	50kA	2	2	Clip-Lock

### Catalog Number Cross Reference

Bussmann Catalog Numbers	Mersen New Catalog #	Mersen Old Catalog #
ECL083-65E	N/A	N/A
ECL083-80E	N/A	N/A
ECL083-100E	N/A	N/A
ECL083-125E	N/A	N/A
ECL083-150E	N/A	N/A
ECL083-175E	N/A	N/A
ECL083-200E	N/A	N/A
ECL083-250E	N/A	N/A
ECL083-300E	N/A	N/A
ECL083-350E	N/A	N/A

Data Sheet: 9007



# E-Rated Fuses: CL-14

## ECL155

### Specifications

**Description:** E-rated medium voltage, current-limiting fuses for transformer and feeder protection.

**Construction:** Filament wound, glass epoxy fuse tube, with silica filler, and silver-plated copper terminals and endcaps containing a silver element in a double concentric helical configuration.

### Ratings:

Volts: — 15.5kV

Amps: — 10-300A

IR: — 63kA Sym. (10-200A)

— 50kA Sym. (250-300A)

**Agency Information:** Meets E requirements per ANSI C37.46, Meets General Purpose requirements per ANSI C37.40.

### Features and Benefits

- Clip-lock double barrel fuse design assures positive installation
- The filament wound, glass epoxy fuse tube provides moisture protection for the fuse. This makes Cooper Bussmann medium voltage fuses suitable for both indoor and outdoor application (outdoor applications require installation inside an appropriate enclosure)
- Open fuse indication (indicator travel distance is 16mm) easily integrates into automation schemes
- 50/60Hz operating frequency make these fuses applicable world-wide

### Typical Applications

- 15.0kV Transformer Primary Protection
- 15.0kV Feeder Circuit Protection
- 15.0kV Voltage Switches
- 15.0kV Metal-enclosed Switchgear

### Dimensions - in

#### Single Barrel

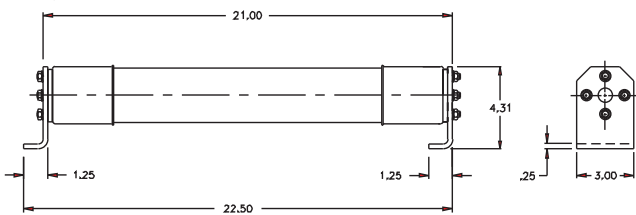

#### Double Barrel

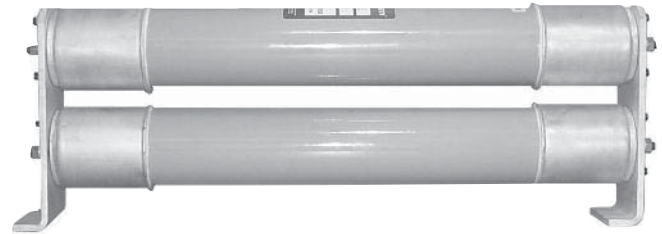
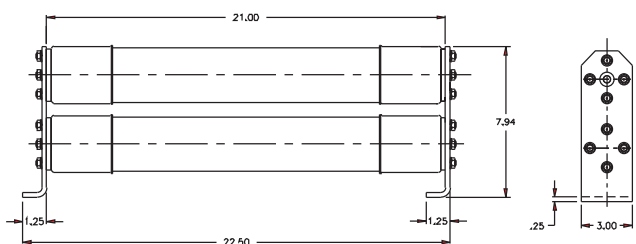

### Catalog Numbers

Catalog Numbers	Amp Rating	Voltage	IR Voltage Max Sym.	# of Barrels	Style
ECL155-10E	10	15.5kV	63kA	1	Clip-Lock
ECL155-15E	15				
ECL155-20E	20				
ECL155-25E	25				
ECL155-30E	30				
ECL155-40E	40				
ECL155-50E	50				
ECL155-65E	65				
ECL155-80E	80				
ECL155-100E	100				
ECL155-125E	125	50kA		2	
ECL155-150E	150				
ECL155-200E	200				
ECL155-250E	250				
ECL155-300E	300				

### Catalog Number Construction (Example)

Catalog Number	Voltage Rating	Amp Rating
ECL	155	300E
	155 = 15.5 kV	

### Catalog Number Cross Reference

Bussmann Catalog Numbers	Mersen New Catalog #	Mersen Old Catalog #
ECL155-10E	A155C1DORO-10E	225-007-967
ECL155-15E	A155C1DORO-15E	225-007-968
ECL155-20E	A155C1DORO-20E	225-007-969
ECL155-25E	A155C1DORO-25E	225-007-970
ECL155-30E	A155C1DORO-30E	225-007-971
ECL155-40E	A155C1DORO-40E	225-007-972
ECL155-50E	A155C1DORO-50E	225-007-973
ECL155-65E	A155C1DORO-65E	225-007-974
ECL155-80E	A155C1DORO-80E	225-007-975
ECL155-100E	A155C1DORO-100E	225-007-976
ECL155-125E	A155C2DORO-125E	225-007-977
ECL155-150E	A155C3DORO-150E	225-007-978
ECL155-200E	A155C3DORO-200E	225-007-979
ECL155-250E	A155C3DORO-250E	225-007-980
ECL155-300E	A155C3DORO-300E	225-007-981

Data Sheet: 9004

# E-Rated Fuses for Potential & Small Power Transformers

## AB, AD, AM and CAV



### Ratings:

- Volts: — 5.5-38kV
- Amps: — 0.5-15A
- IR: — 40kA-80kA Sym.
- See Catalog Numbers table for details

### Features and Benefits

- Sized for retrofitting in existing hardware
- Space saving size

### Typical Applications

- Primary protection of medium voltage potential transformers
- Primary protection of small medium voltage service transformers
- Primary protection of small medium voltage control transformers

### Specifications

**Description:** Indicating and non-indicating E-Rated medium voltage, current-limiting fuses for potential and small power transformers.

**Dimensions:** See Catalog Numbers table.  
Dimension Illustration on the following page

## Catalog Numbers: E-Rated PT Fuses, Indicating & Non-Indicating

### 3.6kV; E-Rated PT Fuse; Non-indicating

Catalog Number	Amp Rating	Rated Voltage	IR RMS Sym.	Dimensions			Spare Parts (Clips)
				Length	Diameter	Clip Centers	
3.6CAV2	2	3.6kV	50kA	8.66 (220)	1.63 (41.3)	7.46 (189.48)	1A0835
3.6ABWNA3.15	3.15	3.6kV	50kA	5.6 (142.2)	1 (25.4)	4.42 (112.2)	A3354705
3.6ABWNA6.3	3.15	3.6kV	50kA	5.6 (142.2)	1 (25.4)	4.42 (112.2)	A3354705
3.6ABCNA3.15	3.15	3.6kV	50kA	7.69 (195.3)	1 (25.4)	6.51 (165.3)	A3354705
3.6ABCNA6.3	6.3	3.6kV	50kA	7.69 (195.3)	1 (25.4)	6.51 (165.3)	A3354705
3.6ABCNA10	10	3.6kV	50kA	7.69 (195.3)	1 (25.4)	6.51 (165.3)	A3354705

### 5.5kV; E-Rated PT Fuse; Indicating & Non-indicating

Catalog Number	Amp Rating	Rated Voltage	IR RMS Sym.	Dimensions			Spare Parts (Clips)
				Length	Diameter	Clip Centers	
5.5CAVH0.5E	0.5	5.5kV	63kA	7.375 (187.3)	1.63 (41.3)	6.18 (156.84)	1A0835
5.5CAVH1E	1	5.5kV	63kA	7.375 (187.3)	1.63 (41.3)	6.18 (156.84)	1A0835
5.5CAVH2E	2	5.5kV	63kA	7.375 (187.3)	1.63 (41.3)	6.18 (156.84)	1A0835
5.5CAV15E	15	5.5kV	63kA	7.375 (187.3)	1.63 (41.3)	6.18 (156.84)	1A0835
5.5ABWNA0.5E	0.5	5.5kV	50kA	5.6 (142.2)	1 (25.4)	4.42 (112.2)	A3354705
5.5ABWNA1E	1	5.5kV	50kA	5.6 (142.2)	1 (25.4)	4.42 (112.2)	A3354705
5.5ABWNA2E	2	5.5kV	50kA	5.6 (142.2)	1 (25.4)	4.42 (112.2)	A3354705
5.5ABWNA3E	3	5.5kV	50kA	5.6 (142.2)	1 (25.4)	4.42 (112.2)	A3354705
5.5ABWNA5E	5	5.5kV	50kA	5.6 (142.2)	1 (25.4)	4.42 (112.2)	A3354705
5.5AMWNA0.5E	0.5	5.5kV	50kA	5.6 (142.2)	0.81 (20.6)	4.79 (121.6)	1A1837
5.5AMWNA1.0E	1	5.5kV	50kA	5.6 (142.2)	0.81 (20.6)	4.79 (121.6)	1A1837
5.5AMWNA2.0E	2	5.5kV	50kA	5.6 (142.2)	0.81 (20.6)	4.79 (121.6)	1A1837
5.5AMWNA3.0E	3	5.5kV	50kA	5.6 (142.2)	0.81 (20.6)	4.79 (121.6)	1A1837
5.5AMWNA4.0E	4	5.5kV	50kA	5.6 (142.2)	0.81 (20.6)	4.79 (121.6)	1A1837
5.5AMWNA5.0E	5	5.5kV	50kA	5.6 (142.2)	0.81 (20.6)	4.79 (121.6)	1A1837

Type CAVH are fitted with a striker pin for indication

### 7.2kV; E-Rated PT Fuse; Non-indicating

Catalog Number	Amp Rating	Rated Voltage	IR RMS Sym.	Dimensions			Spare Parts (Clips)
				Length	Diameter	Clip Centers	
7.2CAV2	2	7.2kV	63kA	8.66 (220)	1.63 (41.3)	7.46 (189.48)	1A0835
7.2CAV4	4	7.2kV	63kA	8.66 (220)	1.63 (41.3)	7.46 (189.48)	1A0835
7.2CAV6	6	7.2kV	63kA	8.66 (220)	1.63 (41.3)	7.46 (189.48)	1A0835
7.2CAV10	10	7.2kV	63kA	8.66 (220)	1.63 (41.3)	7.46 (189.48)	1A0835
7.2ABWNA3.15	3.15	7.2kV	45kA	5.6 (142.2)	1 (25.4)	4.42 (112.2)	A3354705
7.2ABWNA6.3	6.3	7.2kV	45kA	5.6 (142.2)	1 (25.4)	4.42 (112.2)	A3354705
7.2ABCNA3.15	3.15	7.2kV	45kA	7.69 (195.3)	1 (25.4)	6.51 (165.3)	A3354705
7.2ABCNA6.3	6.3	7.2kV	45kA	7.69 (195.3)	1 (25.4)	6.51 (165.3)	A3354705
7.2AMWNA0.5E	0.5	7.2kV	50kA	5.6 (142.2)	0.81 (20.6)	4.79 (121.6)	1A1837
7.2AMWNA1.0E	1	7.2kV	50kA	5.6 (142.2)	0.81 (20.6)	4.79 (121.6)	1A1837
7.2AMWNA2.0E	2	7.2kV	50kA	5.6 (142.2)	0.81 (20.6)	4.79 (121.6)	1A1837
7.2AMWNA3.0E	3	7.2kV	50kA	5.6 (142.2)	0.81 (20.6)	4.79 (121.6)	1A1837
7.2AMWNA4.0E	4	7.2kV	50kA	5.6 (142.2)	0.81 (20.6)	4.79 (121.6)	1A1837
7.2AMWNA5.0E	5	7.2kV	50kA	5.6 (142.2)	0.81 (20.6)	4.79 (121.6)	1A1837

# E-Rated Fuses for Potential & Small Power Transformers

## Dimension Illustration

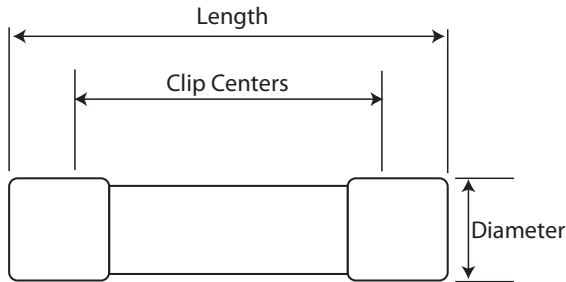

## Catalog Numbers: E-Rated PT Fuses, Indicating & Non-Indicating

### 12kV; E-Rated PT Fuse; Non-indicating

Catalog Number	Amp Rating	Rated Voltage	IR RMS Sym.	Dimensions			Spare Parts (Clips)
				Length	Diameter	Clip Centers	
12CAV2	2	12kV	40kA	8.66 (220)	1.63 (41.3)	7.46 (189.48)	1A0835
12ABCNA3.15	3.15	12kV	45kA	7.69 (195.3)	1 (25.4)	6.51 (165.3)	A3354705

### 15.5kV; E-Rated PT Fuse; Indicating & Non-indicating

Catalog Number	Amp Rating	Rated Voltage	IR RMS Sym.	Dimensions			Spare Parts (Clips)
				Length	Diameter	Clip Centers	
15.5CAV(H)0.5E	0.5	15.5kV	80kA	12.87 (326.9)	1.63 (41.3)	1.2 (30.5)	1A0835
15.5CAV(H)1E	1	15.5kV	80kA	12.87 (326.9)	1.63 (41.3)	1.2 (30.5)	1A0835
15.5CAV(H)2E	2	15.5kV	80kA	12.87 (326.9)	1.63 (41.3)	1.2 (30.5)	1A0835
15.5CAV3E	3	15.5kV	80kA	12.87 (326.9)	1.63 (41.3)	1.2 (30.5)	1A0835
15.5CAV5E	5	15.5kV	80kA	12.87 (326.9)	1.63 (41.3)	1.2 (30.5)	1A0835
15.5CAV7E	7	15.5kV	80kA	12.87 (326.9)	1.63 (41.3)	1.2 (30.5)	1A0835

Type CAVH are fitted with a striker pin for indication

### 17.5kV; E-Rated PT Fuse; Non-indicating

Catalog Number	Amp Rating	Rated Voltage	IR RMS Sym.	Dimensions			Spare Parts (Clips)
				Length	Diameter	Clip Centers	
17.5CAV2	2	17.5kV	40kA	8.66 (220)	1.63 (41.3)	7.46 (189.48)	1A0835
17.5CAV4	4	17.5kV	40kA	8.66 (220)	1.63 (41.3)	7.46 (189.48)	1A0835
17.5CAV6	6	17.5kV	40kA	8.66 (220)	1.63 (41.3)	7.46 (189.48)	1A0835
17.5CAV10	10	17.5kV	40kA	8.66 (220)	1.63 (41.3)	7.46 (189.48)	1A0835
17.5ABGNA3.15	3.15	17.5kV	35kA	14.13 (358.9)	1 (25.4)	12.95 (328.9)	A3354705

### 24kV; E-Rated PT Fuse; Non-indicating

Catalog Number	Amp Rating	Rated Voltage	IR RMS Sym.	Dimensions			Spare Parts (Clips)
				Length	Diameter	Clip Centers	
24CAV2	2	24kV	40kA	13.39 (340.1)	1.63 (41.3)	12.19 (309.62)	1A0835
24CAV3	3	24kV	40kA	13.39 (340.1)	1.63 (41.3)	12.19 (309.62)	1A0835
24CAV4	4	24kV	40kA	13.39 (340.1)	1.63 (41.3)	12.19 (309.62)	1A0835
24ABGNA3.15	3.15	24kV	25kA	14.13 (358.9)	1 (25.4)	12.95 (328.9)	A3354705

### 36kV; E-Rated PT Fuse; Non-indicating

Catalog Number	Amp Rating	Rated Voltage	IR RMS Sym.	Dimensions			Spare Parts (Clips)
				Length	Diameter	Clip Centers	
36CAV2	2	36kV	40kA	17.32 (439.9)	1.63 (41.3)	16.12 (409.44)	1A0835
36CAV4	4	36kV	40kA	17.32 (439.9)	1.63 (41.3)	16.12 (409.44)	1A0835
36ABGNA3.15	3.15	36kV	31.5kA	14.13 (358.9)	1 (25.4)	12.95 (328.9)	A3354705

### 38kV; E-Rated PT Fuse; Indicating & Non-indicating

Catalog Number	Amp Rating	Rated Voltage	IR RMS Sym.	Dimensions			Spare Parts (Clips)
				Length	Diameter	Clip Centers	
38CAVH0.5E	0.5	38kV	40kA	17.32 (439.9)	1.63 (41.3)	16.12 (409.44)	1A0835
38CAVH1E	1	38kV	40kA	17.32 (439.9)	1.63 (41.3)	16.12 (409.44)	1A0835
38CAVH2E	2	38kV	40kA	17.32 (439.9)	1.63 (41.3)	16.12 (409.44)	1A0835
38CAV4E	4	38kV	40kA	17.32 (439.9)	1.63 (41.3)	16.12 (409.44)	1A0835

# E-Rated, PT Fuses for Potential & Small Power Transformers

## JCD, JCW, JCQ, JCI & JCT

### Specifications

**Description:** Indicating and non-indicating E-rated medium voltage, current-limiting fuses for potential and small power transformers.

**Dimensions:** See Catalog Numbers table.

**Construction:** Plated ferrules.

### Ratings:

Volts: — 2.4-15.5kV (See Catalog Numbers table for details)

Amps: — ½-10A

IR: — 25-80kA Sym

— 40-130kA ASYM

— See Catalog Numbers table for details



### Features and Benefits

- Sized for retrofitting in existing hardware
- Space saving size

### Typical Applications

- Primary protection of medium voltage potential transformers
- Primary protection of small medium voltage service transformers
- Primary protection of small medium voltage control transformers

### 2.4kV; E-Rated PT Fuse; Non-indicating

Catalog Number	Amp Rating	Rated Voltage	IR RMS Sym.	Dimensions			Spare Parts (Clips)
				Length	Diameter	Clip Centers	
JCD-1-2E	0.5	2.4kV	63kA	4.49 (114)	0.8 (20)	3.86 (98)	1A1837
JCD-1E	1	2.4kV	40kA	4.49 (114)	0.8 (20)	3.86 (98)	1A1837
JCD-2E	2	2.4kV	40kA	4.49 (114)	0.8 (20)	3.86 (98)	1A1837
JCD-5E	5	2.4kV	25kA	4.49 (114)	0.8 (20)	3.86 (98)	1A1837

### 2.4/5.5kV; E-Rated PT Fuse; Non-indicating

Catalog Number	Amp Rating	Rated Voltage	IR RMS Sym.	Dimensions			Spare Parts (Clips)
				Length	Diameter	Clip Centers	
JCW-1/2E	0.5	2.4kV/5.5kV	40kA	7.31 (185)	1.56 (39.7)	5.93 (150.6)	1A0835
JCW-1E	1	2.4kV/5.5kV	40kA	7.31 (185)	1.56 (39.7)	5.93 (150.6)	1A0835
JCW-2E	2	2.4kV/5.5kV	40kA	7.31 (185)	1.56 (39.7)	5.93 (150.6)	1A0835
JCW-3E	3	2.4kV/5.5kV	40kA	7.31 (185)	1.56 (39.7)	5.93 (150.6)	1A0835
JCW-4E	4	2.4kV/5.5kV	40kA	7.31 (185)	1.56 (39.7)	5.93 (150.6)	1A0835
JCW-5E	5	2.4kV/5.5kV	40kA	7.31 (185)	1.56 (39.7)	5.93 (150.6)	1A0835

### 5.5kV; E-Rated PT Fuse; Indicating

Catalog Number	Amp Rating	Rated Voltage	IR RMS Sym.	Dimensions			Spare Parts (Clips)
				Length	Diameter	Clip Centers	
JCQ-3E	3	5.5kV	130kA	9.5 (241.3)	1.6 (40.6)	8.12 (206)	1A0835
JCQ-5E	5	5.5kV	130kA	9.5 (241.3)	1.6 (40.6)	8.12 (206)	1A0835
JCQ-10E	10	5.5kV	130kA	9.5 (241.3)	1.6 (40.6)	8.12 (206)	1A0835

### 8.3kV; E-Rated PT Fuse; Indicating

Catalog Number	Amp Rating	Rated Voltage	IR RMS Sym.	Dimensions			Spare Parts (Clips)
				Length	Diameter	Clip Centers	
JCI-3E	3	8.3kV	80kA	12.88 (327)	1.6 (40.6)	11.5 (292)	1A0835
JCI-5E	5	8.3kV	80kA	12.88 (327)	1.6 (40.6)	11.5 (292)	1A0835
JCI-10E	10	8.3kV	80kA	12.88 (327)	1.6 (40.6)	11.5 (292)	1A0835

### 15.5kV; E-Rated PT Fuse; Indicating

Catalog Number	Amp Rating	Rated Voltage	IR RMS Sym.	Dimensions			Spare Parts (Clips)
				Length	Diameter	Clip Centers	
JCT-3E	3	15.5kV	80kA	17.5 (444.5)	1.6 (40.6)	16.12 (409.4)	1A0835
JCT-5E	5	15.5kV	80kA	17.5 (444.5)	1.6 (40.6)	16.12 (409.4)	1A0835
JCT-10E	10	15.5kV	80kA	17.5 (444.5)	1.6 (40.6)	16.12 (409.4)	1A0835

Data Sheet: 6002

## PT Fuses

HVA, HVB,  
HVJ, HVL,  
HVR, HVT,  
HVU, HVW &  
HVX



### Specifications

**Description:** Medium voltage, non-time delay, fast-acting fuses.

**Dimensions:** See Basic Catalog Numbers table.

### Ratings:

Volts: — 1-10kV (See Basic Catalog Numbers table)

Amps: — 1/6-10A (See Basic Catalog Numbers table)

### Features and Benefits

- Physical size varies with electrical rating of fuse to prevent over-fusing.
- Space saving size.

### Typical Applications

- Medium Voltage Instrument Protection
- Medium Voltage Circuit Protection

### Test Specifications

Basic Catalog Numbers	Load / Opening Time
HVA, HVB, HVJ, HVL	110% / 4 Hours (min) 135% / 1 Hour (max)
HVR, HVT, HVU, HVW, HVX	100% / 4 Hours (min) 150% / 1 Hour (max)

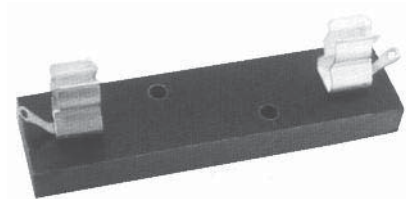

**Fuse blocks:** 4528, 4529

**Voltage Rating:** 1000 to 10,000V

Basic Catalog Numbers	Fuse Block Catalog Number	Fuse Clip Catalog Number
HVA, HVR	4528	5960
HVB, HVT	4529	5960
HVJ, HVU	N/A	4180
HVL, HVX	N/A	4180

Use #8 screws on blocks 4528 and 4529.

Basic Catalog Number	kV	Amp Ratings	Maximum S.C.	Dimensions - in (mm)	
				Diameter	Length
HVA	1	1/6, 1/10, 1/8, 3/10, 1/4, 3/16, 1/2, 3/8, 1, 1 1/2, 2, 3, 4, 6, 10	20kW DC/30kVA AC	0.41 (10.4)	3 (76.1)
HVB	2.5	1/2, 3/4, 1, 1 1/2, 2, 3	20kW DC/30kVA AC	0.41 (10.4)	4.5 (114.2)
HVJ	5	1/6, 1/8, 1/4, 1/2, 3/4, 1 1/2, 2, 4, 6, 10	20kW DC/30kVA AC	0.81 (20.6)	5 (126.9)
HVL	10	1/6, 1/8, 1/4, 1/2, 1, 1 1/2, 2, 3	20kW DC/30kVA AC	0.81 (20.6)	10 (254)
HVR	1	1/2, 1, 2, 3, 4, 5	kVA-500 AC only	0.41 (10.4)	3 (76.2)
HVW	1.2	1, 2, 3, 4, 5, 8	kVA-12,000 AC only	0.41 (10.4)	2.25 (57.1)
HVT	2.5	1/2, 1, 2, 3, 5	kVA-1250 AC only	0.41 (10.4)	4.5 (114.2)
HVU	5	1/2, 1, 2, 3, 4, 5	kVA-2500 AC only	0.81 (20.6)	5 (126.9)
HVX	10	1/2, 1, 3, 5	kVA-5,000 AC only	0.41 (10.4)	10.0 (253.8)

### Catalog Number Build-A-Code

Basic Catalog Number          Amps

---

---



# R-Rated Fuses for Motor Circuit Protection

**JCG, JCH, JCK,  
JCK-A, JCK-B, JCL,  
JCL-A, JCL-B, JCR-A,  
& JCR-B**

**Specifications**

**Description:** Indoor/enclosure R-Rated medium voltage, current-limiting fuses for motor circuit protection.

**Dimensions:** See Dimensions illustrations.

**Ratings:**

- Volts: — 2.4-7.2kV (See Catalog Numbers table for details)
- Amps: — 25-450A (See Catalog Numbers table for details)
- IR: — 50kA Sym
- 80kA ASYM
- See Catalog Numbers table for details



**Agency Information:** UL Recognized: 2540Vac — JCK, JCK-A, 5080Vac — JCL, JCL-A, UL Recognized (Guide #MSSS2, File #E96676).

**Features and Benefits**

- Physically dimensioned for retrofitting in existing hardware
- Open fuse indicator for ease in troubleshooting
- Available with optional Cutler Hammer® hookeye for ease of insertion and removal
- Classified as back-up fuses for current-limited protection of medium voltage motor controllers

**Typical Applications**

- Medium Voltage Motor Controllers

**Dimensions - mm (in)**

**Figure 1**

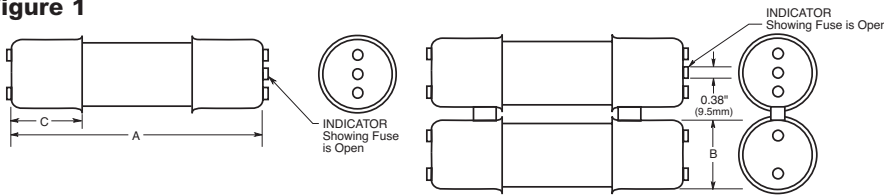

**Figure 2**

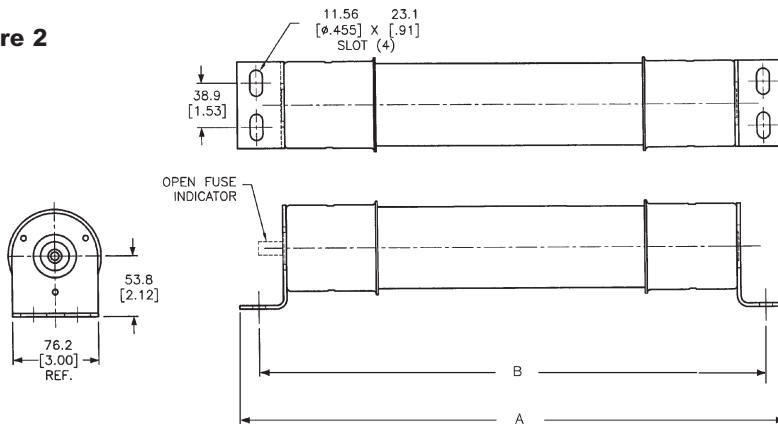

**Figure 3**

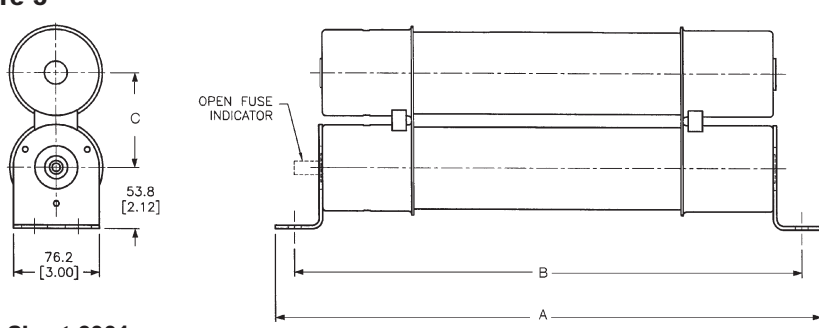

Data Sheet 6001

# R-Rated Fuses for Motor Circuit Protection

## Catalog Numbers: R-Rated; Indoor/Enclosure

Catalog Numbers	Amp Ratings	Maximum Design Voltage	Dimensions - in (mm)*			Construction	Max Int. Cap. Amps (Asym.)	Amps (Sym.)	Min Int. Cap. Amps (Sym.)
			A	B	C				
<b>2400V (See Figure 1)</b>									
JCK-2R	70	2540	11.24 (285.5)	3.0 (76.2)	3.0 (76.2)	Single	80,000	50,000	165
JCK-3R	100	2540	11.24 (285.5)	3.0 (76.2)	3.0 (76.2)	Single	80,000	50,000	220
JCK-4R	130	2540	11.24 (285.5)	3.0 (76.2)	3.0 (76.2)	Single	80,000	50,000	320
JCK-5R	150	2540	11.24 (285.5)	3.0 (76.2)	3.0 (76.2)	Single	80,000	50,000	410
JCK-6R	170	2540	11.24 (285.5)	3.0 (76.2)	3.0 (76.2)	Single	80,000	50,000	480
JCK-9R	200	2540	11.24 (285.5)	3.0 (76.2)	3.0 (76.2)	Single	80,000	50,000	720
JCK-12R	230	2540	11.24 (285.5)	3.0 (76.2)	3.0 (76.2)	Single	80,000	50,000	970
JCK-18R	390	2540	11.24 (285.5)	3.0 (76.2)	3.0 (76.2)	Double	80,000	50,000	1,430
JCK-24R	450	2540	11.24 (285.5)	3.0 (76.2)	3.0 (76.2)	Double	80,000	50,000	1,880

## 2400V — With Westinghouse Ampguard Hookeye (See Figure 1)

JCK-A-2R	70	2540	11.24 (285.5)	3.0 (76.2)	3.0 (76.2)	Single	80,000	50,000	165
JCK-A-3R	100	2540	11.24 (285.5)	3.0 (76.2)	3.0 (76.2)	Single	80,000	50,000	220
JCK-A-4R	130	2540	11.24 (285.5)	3.0 (76.2)	3.0 (76.2)	Single	80,000	50,000	320
JCK-A-5R	150	2540	11.24 (285.5)	3.0 (76.2)	3.0 (76.2)	Single	80,000	50,000	410
JCK-A-6R	170	2540	11.24 (285.5)	3.0 (76.2)	3.0 (76.2)	Single	80,000	50,000	480
JCK-A-9R	200	2540	11.24 (285.5)	3.0 (76.2)	3.0 (76.2)	Single	80,000	50,000	720
JCK-A-12R	230	2540	11.24 (285.5)	3.0 (76.2)	3.0 (76.2)	Single	80,000	50,000	970
JCK-A-18R	390	2540	11.24 (285.5)	3.0 (76.2)	3.0 (76.2)	Double	80,000	50,000	1,430
JCK-A-24R	450	2540	11.24 (285.5)	3.0 (76.2)	3.0 (76.2)	Double	80,000	50,000	1,880

## 2400V — Bolt-On (See Figures 2 & 3)

JCK-B-30	25	2540	14.18 (360.2)	12.81 (325.4)	-	Single	80,000	50,000	90
JCK-B-2R	70	2540	14.18 (360.2)	12.81 (325.4)	-	Single	80,000	50,000	170
JCK-B-3R	100	2540	14.18 (360.2)	12.81 (325.4)	-	Single	80,000	50,000	245
JCK-B-4R	130	2540	14.18 (360.2)	12.81 (325.4)	-	Single	80,000	50,000	340
JCK-B-5R	150	2540	14.18 (360.2)	12.81 (325.4)	-	Single	80,000	50,000	430
JCK-B-6R	170	2540	14.18 (360.2)	12.81 (325.4)	-	Single	80,000	50,000	500
JCK-B-9R	200	2540	14.18 (360.2)	12.81 (325.4)	-	Single	80,000	50,000	1,000
JCK-B-12R	230	2540	14.18 (360.2)	12.81 (325.4)	-	Single	80,000	50,000	1,250
JCK-B-18R	390	2540	14.18 (360.2)	12.81 (325.4)	3.56 (90.4)	Double	80,000	50,000	1,700
JCK-B-24R	450	2540	14.18 (360.2)	12.81 (325.4)	3.56 (90.4)	Double	80,000	50,000	1,210

## 2400V — Hermetically Sealed, For Use with Ampguard Motor Starters (See Figure 1)

JCH-30	25	2540	10.81 (275.6)	3.0 (76.2)	3.0 (76.2)	Single	80,000	50,000	90
JCH-2R	70	2540	10.81 (275.6)	3.0 (76.2)	3.0 (76.2)	Single	80,000	50,000	170
JCH-3R	100	2540	10.81 (275.6)	3.0 (76.2)	3.0 (76.2)	Single	80,000	50,000	245
JCH-4R	130	2540	10.81 (275.6)	3.0 (76.2)	3.0 (76.2)	Single	80,000	50,000	340
JCH-5R	150	2540	10.81 (275.6)	3.0 (76.2)	3.0 (76.2)	Single	80,000	50,000	430
JCH-6R	170	2540	10.81 (275.6)	3.0 (76.2)	3.0 (76.2)	Single	80,000	50,000	500
JCH-9R	200	2540	10.81 (275.6)	3.0 (76.2)	3.0 (76.2)	Single	80,000	50,000	1,000
JCH-12R	230	2540	10.81 (275.6)	3.0 (76.2)	3.0 (76.2)	Single	80,000	50,000	1,250
JCH-18R	390	2540	10.81 (275.6)	3.0 (76.2)	3.0 (76.2)	Double	80,000	50,000	1,700
JCH-24R	450	2540	10.81 (275.6)	3.0 (76.2)	3.0 (76.2)	Double	80,000	50,000	2,100

## 4800V (See Figure 1)

JCL-2R	70	5080	15.76 (400.3)	3.0 (76.2)	3.0 (76.2)	Single	80,000	50,000	165
JCL-3R	100	5080	15.76 (400.3)	3.0 (76.2)	3.0 (76.2)	Single	80,000	50,000	220
JCL-4R	130	5080	15.76 (400.3)	3.0 (76.2)	3.0 (76.2)	Single	80,000	50,000	320
JCL-5R	150	5080	15.76 (400.3)	3.0 (76.2)	3.0 (76.2)	Single	80,000	50,000	410
JCL-6R	170	5080	15.76 (400.3)	3.0 (76.2)	3.0 (76.2)	Single	80,000	50,000	480
JCL-9R	200	5080	15.76 (400.3)	3.0 (76.2)	3.0 (76.2)	Single	80,000	50,000	720
JCL-12R	230	5080	15.76 (400.3)	3.0 (76.2)	3.0 (76.2)	Single	80,000	50,000	970
JCL-18R	390	5080	15.76 (400.3)	3.0 (76.2)	3.0 (76.2)	Double	80,000	50,000	1,430
JCL-24R	450	5080	15.76 (400.3)	3.0 (76.2)	3.0 (76.2)	Double	80,000	50,000	1,880

\* See previous page Figure 2 for single construction and Figure 3 for double construction information.  
Recommended fuseclips: see page 120 - 1A0065, A3354730, 9078A67G04.

# R-Rated Fuses for Motor Circuit Protection

## Catalog Numbers: R-Rated; Indoor/Enclosure

Catalog Numbers	Amp Ratings	Maximum Design Voltage	Dimensions - in (mm)			Construction	Max Int. Cap. Amps (Asym.)	Amps (Sym.)	Min Int. Cap. Amps (Sym.)
			A	B	C				
<b>4800V — With Westinghouse Ampguard Hookey (See Figure 1)</b>									
JCL-A-2R	70	5080	15.76 (400.3)	3.0 (76.2)	3.0 (76.2)	Single	80,000	50,000	165
JCL-A-3R	100	5080	15.76 (400.3)	3.0 (76.2)	3.0 (76.2)	Single	80,000	50,000	220
JCL-A-4R	130	5080	15.76 (400.3)	3.0 (76.2)	3.0 (76.2)	Single	80,000	50,000	320
JCL-A-5R	150	5080	15.76 (400.3)	3.0 (76.2)	3.0 (76.2)	Single	80,000	50,000	410
JCL-A-6R	170	5080	15.76 (400.3)	3.0 (76.2)	3.0 (76.2)	Single	80,000	50,000	480
JCL-A-9R	200	5080	15.76 (400.3)	3.0 (76.2)	3.0 (76.2)	Single	80,000	50,000	720
JCL-A-12R	230	5080	15.76 (400.3)	3.0 (76.2)	3.0 (76.2)	Single	80,000	50,000	970
JCL-A-18R	390	5080	15.76 (400.3)	3.0 (76.2)	3.0 (76.2)	Double	80,000	50,000	1,430
JCL-A-24R	450	5080	15.76 (400.3)	3.0 (76.2)	3.0 (76.2)	Double	80,000	50,000	1,880

## 4800V — Bolt-On (See Figures 2 & 3)

JCL-B-30	30	5080	19.25 (488.9)	17.88 (454.1)	-	Single	80,000	50,000	95
JCL-B-2R	70	5080	19.25 (488.9)	17.88 (454.1)	-	Single	80,000	50,000	180
JCL-B-3R	100	5080	19.25 (488.9)	17.88 (454.1)	-	Single	80,000	50,000	270
JCL-B-4R	130	5080	19.25 (488.9)	17.88 (454.1)	-	Single	80,000	50,000	350
JCL-B-5R	150	5080	19.25 (488.9)	17.88 (454.1)	-	Single	80,000	50,000	450
JCL-B-6R	170	5080	19.25 (488.9)	17.88 (454.1)	-	Single	80,000	50,000	540
JCL-B-9R	200	5080	19.25 (488.9)	17.88 (454.1)	-	Single	80,000	50,000	700
JCL-B-12R	230	5080	19.25 (488.9)	17.88 (454.1)	-	Single	80,000	50,000	1,000
JCL-B-18R	390	5080	19.25 (488.9)	17.88 (454.1)	3.31 (84.1)	Double	80,000	50,000	1,450
JCL-B-24R	450	5080	19.25 (488.9)	17.88 (454.1)	3.31 (84.1)	Double	80,000	50,000	2,000

## 4800V — Hermetically Sealed, For Use with Ampguard Motor Starters (See Figure 1)

JCG-30	30	5080	15.91 (404.1)	3.0 (76.2)	3.0 (76.2)	Single	80,000	50,000	95
JCG-2R	70	5080	15.91 (404.1)	3.0 (76.2)	3.0 (76.2)	Single	80,000	50,000	180
JCG-3R	100	5080	15.91 (404.1)	3.0 (76.2)	3.0 (76.2)	Single	80,000	50,000	270
JCG-4R	130	5080	15.91 (404.1)	3.0 (76.2)	3.0 (76.2)	Single	80,000	50,000	350
JCG-5R	150	5080	15.91 (404.1)	3.0 (76.2)	3.0 (76.2)	Single	80,000	50,000	450
JCG-6R	170	5080	15.91 (404.1)	3.0 (76.2)	3.0 (76.2)	Single	80,000	50,000	540
JCG-9R	200	5080	15.91 (404.1)	3.0 (76.2)	3.0 (76.2)	Single	80,000	50,000	700
JCG-12R	230	5080	15.91 (404.1)	3.0 (76.2)	3.0 (76.2)	Single	80,000	50,000	1,000
JCG-A-18R	390	5080	15.91 (404.1)	3.0 (76.2)	3.0 (76.2)	Double	80,000	50,000	1,450
JCG-A-24R	450	5080	15.91 (404.1)	3.0 (76.2)	3.0 (76.2)	Double	80,000	50,000	2,000

## 7200V — With Ampguard Hookey (See Figure 1)

JCR-A-2R	70	8300	15.85 (402.6)	3.0 (76.2)	3.0 (76.2)	Single	80,000	50,000	160
JCR-A-3R	100	8300	15.85 (402.6)	3.0 (76.2)	3.0 (76.2)	Single	80,000	50,000	250
JCR-A-4R	130	8300	15.85 (402.6)	3.0 (76.2)	3.0 (76.2)	Single	80,000	50,000	325
JCR-A-5R	150	8300	15.85 (402.6)	3.0 (76.2)	3.0 (76.2)	Single	80,000	50,000	390
JCR-A-6R	170	8300	15.85 (402.6)	3.0 (76.2)	3.0 (76.2)	Single	80,000	50,000	500
JCR-A-9R	200	7200	15.85 (402.6)	3.0 (76.2)	3.0 (76.2)	Single	80,000	50,000	750
JCR-A-12R	230	7200	15.85 (402.6)	3.0 (76.2)	3.0 (76.2)	Single	80,000	50,000	1,000
JCR-A-18R	390	7200	15.85 (402.6)	3.0 (76.2)	3.0 (76.2)	Double	80,000	50,000	1,450
JCR-A-24R	450	7200	15.85 (402.6)	3.0 (76.2)	3.0 (76.2)	Double	80,000	50,000	2,500

## 7200V — Bolt-On (See Figures 2 & 3)

JCR-B-2R	70	8300	19.25 (488.9)	17.88 (454.1)	-	Single	80,000	50,000	160
JCR-B-3R	100	8300	19.25 (488.9)	17.88 (454.1)	-	Single	80,000	50,000	250
JCR-B-4R	130	8300	19.25 (488.9)	17.88 (454.1)	-	Single	80,000	50,000	325
JCR-B-5R	150	8300	19.25 (488.9)	17.88 (454.1)	-	Single	80,000	50,000	390
JCR-B-6R	170	8300	19.25 (488.9)	17.88 (454.1)	-	Single	80,000	50,000	500
JCR-B-9R	200	7200	19.25 (488.9)	17.88 (454.1)	-	Single	80,000	50,000	750
JCR-B-12R	230	7200	19.25 (488.9)	17.88 (454.1)	-	Single	80,000	50,000	1,000
JCR-B-18R	390	7200	19.25 (488.9)	17.88 (454.1)	3.31 (84.1)	Double	80,000	50,000	1,450
JCR-B-24R	450	7200	19.25 (488.9)	17.88 (454.1)	3.31 (84.1)	Double	80,000	50,000	2,500

Recommended fuseclips: see page 120 - 1A0065, A3354730, 9078A67G04.

## British Standard Dimensioned IEC Fuses for Motor Circuit Protection

The Bussmann range of motor fuses are designed to meet the specific requirements necessary for motor protection. During the starting cycle of direct on-line motors, the fuse elements will reach a considerably higher temperature than during normal operation; (this is due to the high amount of current the motor will draw as it starts, typically, six times its normal load current value). This results in expansion and contraction of the fuse elements and could cause premature operation of the fuse.

Bussmann motor fuses encompass an advanced design to minimize this effect. This therefore, negates the need to over specify the fuse rating due to high values of motor starting current.

Bussmann motor fuses operate extremely quickly under heavy fault currents, resulting from the time / current characteristic. Low power dissipation ensures low temperature rise, important in multi-tier starters for example. Switching (arc), voltages are lower than permitted values, therefore, 5.5kV fuses are also suitable for 4.8kV and 2.4kV circuits.

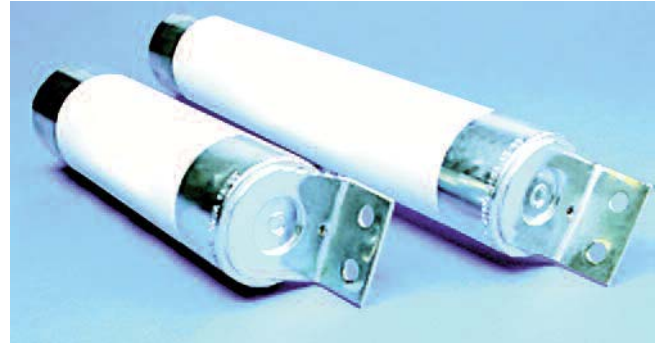

Table of Ratings

Basic Cat. Number	Volts	Breaking Capacity	Amp Ratings	Dimensions - in (mm)		Dimensional Standard
				Length	Diameter	
3.6WJON6	3.6kV	50kA	5, 6.3, 10, 16, 20, 25, 31.5, 40, 50	7.56 (192)	1.4 (35.6)	BS 2692 (TA1) Interchangeable with GEC Type K2 PA
3.6WDOH6	3.6kV	50kA	50, 63, 80, 100, 125	7.56 (192)	2 (50.8)	BS 2692 (TA1) or DIN 43625
3.6WFOH6	3.6kV	50kA	160, 200	7.56 (192)	3 (76.2)	BS 2692 (TA1) or DIN 43625
3.6WDLSJ	3.6kV	50kA	50, 63, 80, 100, 125	11.5 (292.1)	2 (50.8)	DIN 43625
3.6WFLSJ	3.6kV	50kA	160, 200	11.5 (292.1)	3 (76.2)	DIN 43625
3.6WDFHO	3.6kV	50kA	50, 63, 80, 100, 125	10 (254)	2 (51)	BS 2692 (TA2)
3.6WFFHO	3.6kV	50kA	160, 200	10 (254)	3 (76.2)	BS 2692 (TA2)
3.6WKFHO	3.6kV	50kA	250, 315, 355, 400	10 (254)	3 (76.2)	BS 2692 (TA2)
5.5VFNHA	5.5kV	60kA	2R-6R	15.86 (402.8)	3 (76.2)	ANSI R-Rated
5.5VKNHA	5.5kV	60kA	9R-24R	15.86 (402.8)	3 (76.2)	ANSI R-Rated
7.2WFNHO	7.2kV	40kA	25, 31.5, 40, 50, 63, 80, 100, 125, 160	15.86 (402.8)	3 (76.2)	BS 2692 (TA4)
7.2WKNHO	7.2kV	40kA	200, 224, 250, 315	15.86 (402.8)	3 (76.2)	BS 2692 (TA4)
7.2WFMSJ	7.2kV	63kA	25, 31.5, 40, 50, 63, 80, 125, 160	17.40 (442)	3 (76.2)	DIN 43625
7.2WKMSJ	7.2kV	63kA	200, 224, 250, 315, 355	17.40 (442)	3 (76.2)	DIN 43625

Catalog Number Build-A-Code

kV      Basic Catalog Number      Amps  
 ---      ---      ---

Medium Voltage Fuses

# DIN Dimensioned IEC Fuses for Transformer Protection

## DIN Dimension Fuses

To Spec. DIN 43625



### Specifications

**Catalog Symbol:** See Basic Catalog Numbers table.

**Description:** DIN dimension fuses to Specification DIN 43625 covering current-limiting fuses with performance in compliance with IEC 60282-1. These are in accordance with the R10 and, in some cases, the R20 series of preferred numbers.

**Dimensions:** See Catalog Numbers table.

Volts: — See voltage associated with the Basic Catalog Numbers in the table.

Amps: — See amp rating associated with the Basic Catalog Numbers in the table.

IR: — See IR associated with the Basic Catalog Numbers in the table.

**Agency Information:** Comply with DIN dimensional standard DIN 43625, VDE 0670 part 4, VDE 0670 part 40Z and with IEC 60282-1 (2005).

### Features and Benefits

- DIN dimensioned for retrofitting in existing hardware
- Open fuse indicator for ease in troubleshooting
- Designed for use in IEC equipment

### Typical Applications

- Medium Voltage IEC designed equipment

### Catalog Number Build-A-Code

kV      Basic Catalog Number      Amps  
 ---      ---      ---

## Catalog Numbers

kV	Catalog Numbers	Amp Ratings	Dimensions - in (mm) Diameter x Length	IR RMS Sym
3.6	3.6ADOSJ(amp)	6.3, 10, 16, 20, 25, 31.5, 40	2.00 x 7.56 (51 x 192)	50kA
	3.6WDOSJ(amp)	50, 63, 80, 100, 125	2.00 x 7.56 (51 x 192)	
	3.6WFOSJ(amp)	160, 200	3.00 x 7.56 (76 x 192)	
	3.6ADLSJ(amp)	25, 40	2.00 x 11.50 (51 x 292)	
	3.6WDLSJ(amp)	50, 63, 80, 100, 125	2.00 x 11.50 (51 x 292)	
	3.6WFLSJ(amp)	160, 200	3.00 x 11.50 (76 x 292)	
	3.6WKLSJ(amp)	250, 315, 400	3.00 x 11.50 (76 x 292)	
7.2	7.2DLSJ(amp)	6.3, 10, 16, 20, 25, 31.5, 40, 50, 63	2.00 x 11.50 (51 x 292)	40kA
	7.2FLSJ(amp)	80, 100, 125, 160	3.00 x 11.50 (76 x 292)	
	7.2WKMSJ(amp)	200, 225, 250, 315, 355	3.00 x 17.41 (76 x 442)	
12	12DLEJ(amp)	6.3, 10, 16, 20, 25, 31.5, 40, 50, 63	2.00 x 11.50 (51 x 292)	63kA
	12HLEJ(amp)	80, 100	2.52 x 11.50 (64 x 292)	
	12KLEJ(amp)	125	3.00 x 11.50 (76 x 292)	
	12TXLEJ(amp)*	160, 200	3.50 x 11.50 (88 x 292)	
17.5	17.5DLSJ(amp)*	6.3, 10, 16, 20, 25, 31.5, 40	2.00 x 11.50 (51 x 292)	35.5kA
	17.5FLSJ(amp)*	50	3.00 x 11.50 (76 x 292)	
	17.5DMEJ(amp)	6.3, 10, 16, 20, 25, 31.5, 40, 50, 63	2.00 x 17.41 (51 x 442)	50kA
	17.5HMEJ(amp)	80, 100	2.52 x 17.41 (64 x 442)	
	17.5KMEJ(amp)	125	3.00 x 17.41 (76 x 442)	
24	24DMEJ(amp)	6.3, 10, 16, 20, 25, 31.5, 40, 50	2.00 x 17.41 (51 x 442)	50kA
	24HMEJ(amp)	63	2.52 x 17.41 (64 x 442)	
	24TFMEJ(amp)	80, 100* <sup>1</sup>	3.00 x 17.41 (76 x 442)	31.5kA
	24TXMEJ(amp)*	125 <sup>2</sup> , 160	3.46 x 17.41 (88 x 442)	
36	36DQSJ(amp)	3.15 <sup>3</sup> , 6.3, 10, 16, 20, 25	2.00 x 21.16 (51 x 537)	35.5kA
	36TQSJ(amp)	31.5, 40, 50	3.00 x 21.16 (76 x 537)	
	36TXQEJ(amp)*	63	3.46 x 21.16 (88 x 537)	20kA

Recommended fuseclips for DIN style fuses – 270303, A3354745 see page 120.

\*Not compliant with VDE 0670, part 402.

<sup>1</sup>-IR RMS Sym is 63kA

<sup>2</sup>-IR RMS Sym is 40kA

<sup>3</sup>-IR RMS Sym is 20kA

### Dimensions - In (mm)

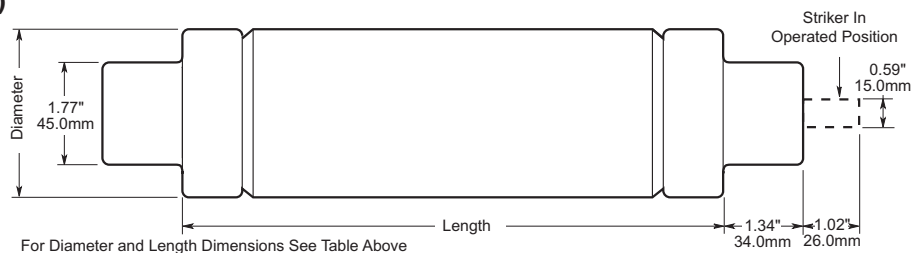



# Expulsion Fuse Links for Use in High Voltage Distribution Cut-Outs

## Specifications

**Description:** Expulsion fuse links available in a wide range of options from 15kV to 72kV in ANSI T&K characteristics.

### Ratings:

Volts: — 15 to 72kV

Amps: — 1 to 100A

Breaking Capacity: depends on voltage but is approximately 8kA

### Agency Information:

Type T: complies with ANSI C37-42

Type K: complies with ANSI C37-42

### Features and Benefits

- Wide range of options available from 15kV to 72kV in ANSI T & K characteristics.
- Extra rapid option also available.

### Packaging:

Up to and including 50A: 25 in a carton

From 60A to 100A: 10 in a carton

To avoid incorrect replacement the fuse links have colour coded labels:

Pink label: Type XA

Yellow label: Type K

Green label: Type T



### Typical Applications:

- Primary side transformer protection
- Feeder protection
- Capacitor bank protection

### Use of Application

Expulsion fuse links current ratings should be selected on the basis of maximum expected transient no damage currents rather than on full load current. In addition, the selection of higher current ratings will reduce the possibility of supply interruption due to transient surges such as those due to lightning strikes.

Links should be handled with a reasonable degree of care when installing. Excessively rough handling may damage the element.

It is normal, under certain fault conditions, for arc extinguishing material and/or metal particles to be expelled from the fuse assembly. It is therefore recommended that reasonable precautions be taken to prevent the installation being approached by unauthorised persons.

## How to order - Parts Referencing System

Rated Voltage (kV)	1st Letter Type of Current Characteristics	2nd Letter Type of Termination	Rated Current (A)
15 25 46 72	<p><b>T</b> = complies with ANSI C 37-42 requirements for slow acting T characteristics</p> <p><b>K</b> = complies with ANSI C 37-42 requirements for fast acting K characteristics</p> <p><b>XA</b> = this type of expulsion fuse link has an extra rapid characteristic. It is suitable for applications where a high degree of system protection is required at the expense of discrimination</p> <p><b>S</b> = Solid links rated at 100A are also available in both button head and universal versions for fitting into expulsion fuse carriers where required. These can be ordered in a similar way using the abbreviation S, e.g. 15SB, etc</p>	<p><b>B</b> = a fixed NEMA button head link</p> <p><b>U</b> = a universal link, with double tail and slip off NEMA button head</p> <p><b>D</b> = double tailed link without NEMA button head</p> <p><b>BR</b> = as pattern B but the button head is attached via a 1/4 UNF thread to allow use of an extension rod.</p> <p>See outline drawings opposite page for reference</p>	1, 2, 3, 4, 5, 6, 7.5, 8, 10, 12, 15, 20, 25, 30, 40, 50, 60, 65, 75, 80, 100

Thus a typical ordering reference for a 15kV NEMA Type K, button head 30A fuse link would be 15KB30 expulsion fuse link.

The fuse link assembly for a given range is standard to all rated voltages. The exception is that the tail length is varied to suit the dimensions of expulsion carrier of different ratings.

# Expulsion Fuse Links for Use in High Voltage Distribution Cut-Outs

## Dimensions - mm (in)

Type kV	A
15kV	533 (21")
25kV	660 (26")
46kV	787 (31")
72kV	1016 (40")

Notes: Type BR is similar to button head shown, except that the button head is attached via a ¼ UNF thread. Tails can be cut to any length.

### 1-50A

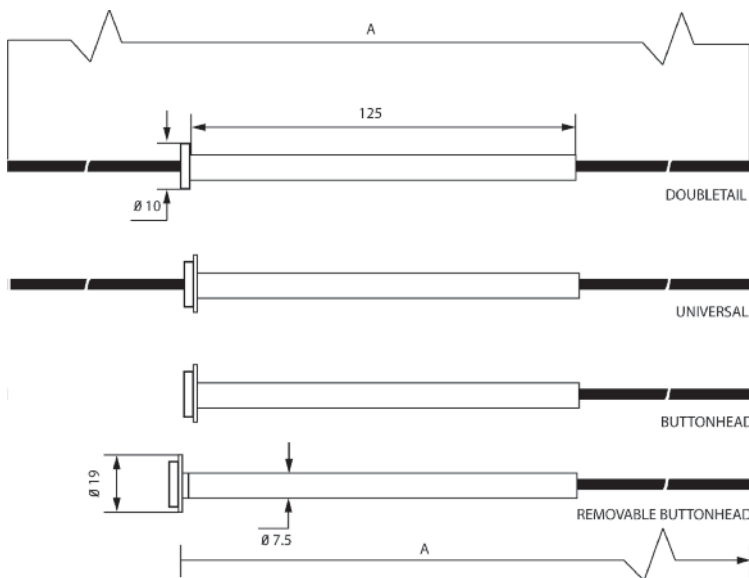

### 60-100A

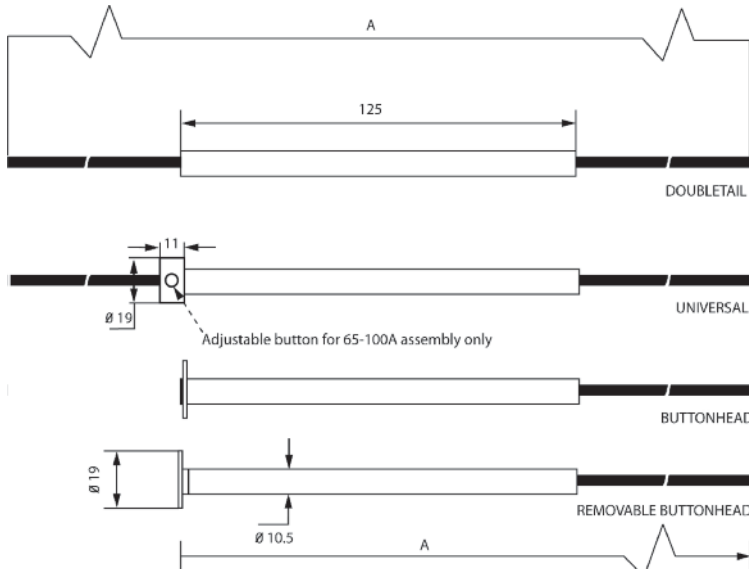

# EEI-NEMA Type K & T and Type H & N

## FL: Type H and EEI-NEMA Type K & T Fuses



### Specifications

**Description:** Medium voltage fuses: Type H (high surge), EEI-NEMA Type K (fast-acting), EEI-NEMA Type T (slow-acting).

### Ratings:

Amps: — 1-200A  
(See Catalog Numbers tables)

### Features and Benefits

- Wide range of EEI-NEMA type fuse links for use in open fuse cutouts
- Voltage ratings up to 27kV.
- Can be coordinated with other overcurrent protective devices for sectionalizing to isolate feeder branches.

### Typical Applications

- Medium Voltage Fused Cutouts

### High-Surge Type H Fuses

High-surge, Type H fuses are manufactured in ratings of 1, 2, 3, 5, and 8A. They have been developed principally for primary fusing of small-sized transformers. Type H links are manufactured in the universal buttonhead design.

### Type N Fuses

Type N fuses conform to previous NEMA standards and have been superseded by Type K and T links. Type N fuses are manufactured in the universal button design in ratings of 5 through 200A for use in NEMA standard dimensioned cutouts rated through 27kV.

## Catalog Numbers

### EEI-NEMA and High-Surge Universal Tin Element

#### Fuses for Cutouts — Rated to 27kV

Non-Removable Button-Head For Standard Open or Enclosed Cutouts

Catalog Numbers			
Type H (High Surge)	EEI-NEMA Type K (Fast)	EEI-NEMA Type T (Slow)	Amps
FL11H1	FL11K1	FL11T1	1
FL11H2	FL11K2	FL11T2	2
FL11H3	FL11K3	FL11T3	3
FL11H5	FL11K5	FL11T5	5
—	FL11K6	FL11T6	6
FL11H8	FL11K8	FL11T8	8
—	FL11K10	FL11T10	10
—	FL11K12	FL11T12	12
—	FL11K15	FL11T15	15
—	FL11K20	FL11T20	20
—	FL11K25	FL11T25	25
—	FL11K30	FL11T30	30
—	FL11K40	FL11T40	40
—	FL11K50	FL11T50	50
—	FL11K65	FL11T65	65
—	FL11K80	FL11T80	80
—	FL11K100	FL11T100	100
—	FL11K140	FL11T140	140
—	FL11K200	FL11T200	200

Removable Button-Head For Cutouts Requiring Removable-Button Links

### Catalog Numbers

EEI-NEMA Type K (Fast)	EEI-NEMA Type T (Slow)	Amps
FL3K1	FL3T1	1
FL3K2	FL3T2	2
FL3K3	FL3T3	3
FL3K5	FL3T5	5
FL3K6	FL3T6	6
FL3K8	FL3T8	8
FL3K10	FL3T10	10
FL3K12	FL3T12	12
FL3K15	FL3T15	15
FL3K20	FL3T20	20
FL3K25	FL3T25	25
FL3K30	FL3T30	30
FL3K40	FL3T40	40
FL3K50	FL3T50	50
FL3K65	FL3T65	65
FL3K80	FL3T80	80
FL3K100	FL3T100	100
FL3K140	FL3T140	140
FL3K200	FL3T200	200

Adapter-type removable-button links with ferrule adapter to convert to double-leader links are available in K and T types. Order by description.

### EEI-NEMA Type K Universal Silver-Element Fuses

#### for Cutouts — Rated through 27kV

Non-Removable Button-Head For Standard Open or Enclosed Cutouts

Catalog Numbers	
EEI-NEMA Type K	Amps
FL12K8	8
FL12K10	10
FL12K12	12
FL12K15	15
FL12K25	25
FL12K50	50

# Fuseclips for Medium & High Voltage Fuses

## Recommended Fuseclips for Medium Voltage Fuses

Catalog Numbers	Fuse Diameter - in (mm)	Clip Dimensions (in)						
		A	B	C	D	E	F	G
A3354710	2 (50.8)	3.749	1.979	2.009	1.189	4.539	1.509	0.399
A3354730	3 (76)	4.139	2.449	3.009	1.189	5.639	1.509	0.399
A3354745	1.77 (45)	3.50	2.50	1.77	1.19	4.50	1.50	0.38

Fuseclips are for single barrel applications only. Are not sold in pairs.

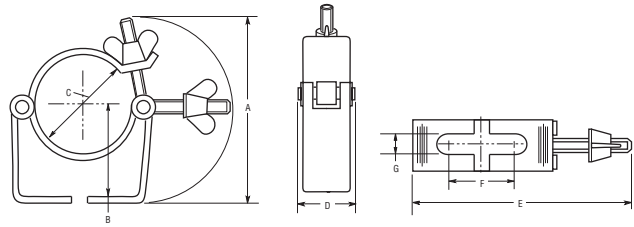

### 1A0065 3" Diameter Clip

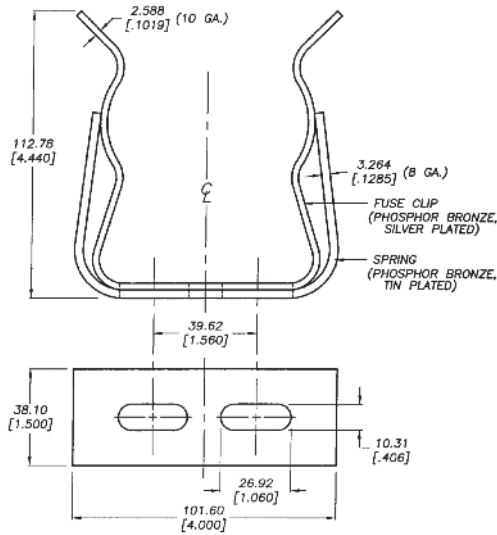

2 CLIP ASSEMBLIES PER PACKAGE.  
DIMENSIONS SHOWN ARE FOR REFERENCE ONLY.

### 270303 DIN Fuseclip

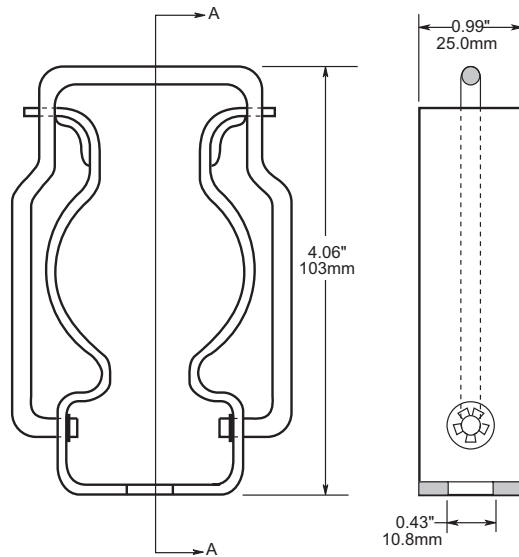

### 9078A67G04 3" Diameter Clip

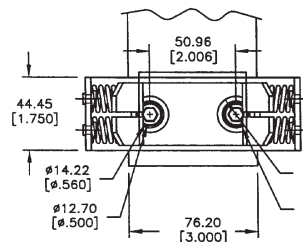
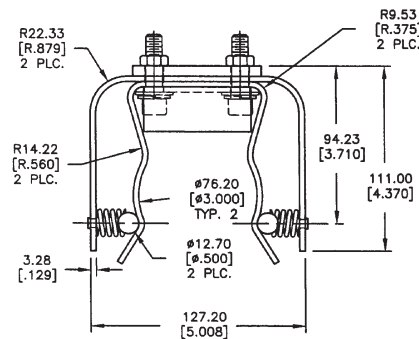

2 Cup assemblies per package.  
Dimensions shown are for reference only.