

Electronic Trip Insulated Case Circuit Breakers

Class 603



CONTENTS

Description	Pages
Introduction	3, 4
General Information	4-8
MICROLOGIC® Trip System	9-12
Circuit Breaker Specifics	13-21
Accessories	22-28
Glossary	29-31



SQUARE D
GROUPE SCHNEIDER

What Are Electronic Trip Insulated Case Circuit Breakers?

Electronic trip insulated case circuit breakers are designed to protect electrical systems from damage caused by overloads, short circuits and ground faults. All circuit breakers are designed to open and close a circuit by nonautomatic means, and to open the circuit automatically on a predetermined overcurrent. Insulated case circuit breakers can also

- enhance coordination by their adjustability
- provide integral ground-fault protection
- provide capacity for future growth
- provide zone-selective interlocking for increased selectivity in the electrical system

Electronic trip insulated case circuit breakers manufactured by Square D use the MICROLOGIC® electronic trip system to sense overcurrents and trip the circuit breaker. All electronic trip insulated case circuit breakers are manufactured with a full-function trip system.

Part 1 of this catalog, General Information, provides an overview of electronic trip insulated case circuit breakers. Part 2 – MICROLOGIC Trip System provides information about the electronic trip system used in these circuit breakers. Part 3 – Sensor/Ampere Ratings describes the insulated case circuit breakers available from Square D. Part 4 – Accessories lists the accessories available for use with electronic trip insulated case circuit breakers.

For information on other types of molded case circuit breakers manufactured by Square D, see the publications *Thermal-Magnetic and Magnetic Only Molded Case Circuit Breakers Catalog, Class 601*, and *Electronic Trip Molded Case Circuit Breakers, Class 602*, which are also available from Square D.

Standards

Square D electronic trip molded case circuit breakers are manufactured and tested in accordance with the following standards:

- UL Standard 489
- NEMA Standard AB1
- CSA Standard C22.2, No. 5.1 (SEF and SEHF)
- Federal Specification W-C-375B/GEN as Class 25a

Circuit breakers are applied according to guidelines detailed in the National Electrical Code (NEC) and other local electrical wiring codes.

Why Use Electronic Trip Insulated Case Circuit Breakers?

MICROLOGIC electronic trip circuit breakers provide the same basic functions as standard thermal-magnetic circuit breakers. Both types of circuit breakers

- provide overload and short-circuit protection
- are true rms sensing devices
- provide means to manually disconnect power to the circuit
- meet UL, CSA and NEMA standards

MICROLOGIC Trip Unit Features

Full-function Circuit Breakers

- 100% rated
- True root-mean-square (rms) sensing
- 80-4000 A continuous current ratings
- LI, LIG, LS(I), LS(I)G trip configurations
- Interchangeable rating plugs
- Overload indicating light
- Short-time withstand rating
- Defeatable instantaneous feature option (on LS trip only)
- Integral ground-fault protection and testing option
- Integral ground-fault alarm (no trip) option
- Zone-selective interlocking
- Local electronic trip indicator
- Local current meter
- Universal test set available
- Neutral current transformer for 4-wire systems available
- POWERLOGIC® communications

However, MICROLOGIC electronic trip circuit breakers offer a variety of benefits in addition to these basic functions. MICROLOGIC circuit breakers can

- provide adjustability for enhanced coordination
- provide integral ground-fault protection or alarm
- measure and report inherent ground-fault leakage current on a system
- provide capacity for future growth using
 - rating plugs
 - long-time pickup switch
 - 100% rated full-function trip system
- provide zone-selective interlocking to reduce fault stress on the electrical system
- be provided with power monitoring communications

What do these benefits mean to a customer?

MICROLOGIC circuit breakers give the customer more versatility to achieve coordination with features such as adjustable pickup and delay points, interchangeable rating plugs and withstand ratings.

Features such as universally interchangeable rating plugs, adjustable long-time pickups and 100% ratings provide capacity for future growth.

Integral ground-fault sensing capabilities mean that there are fewer parts and pieces to buy, mount and wire. Square D offers products with integral ground-fault protection which trip when a ground-fault is detected as well as products with integral ground-fault alarm which do not trip but send an alarm that a ground fault is detected.

MICROLOGIC full-function circuit breakers also offer the customer true power management system solutions through communications. The full-function trip units can communicate



Introduction/General Information

with other circuit breakers in the system and also with a power monitoring system.

Communication between circuit breakers allows zone-selective interlocking (ZSI) between circuit breakers at different levels in the system. ZSI reduces fault stress by allowing the upstream circuit breaker closest to the fault to ignore its preset delay time and trip without any intentional delay on a short circuit or ground fault. For more information on ZSI, see Application Guide 0600SC9102R6/95, *Reducing Fault Stress with Zone-selective Interlocking*.

Communication with a power monitoring system through a POWERLOGIC® communications link allows a ground fault to be reported without interrupting power to the system. It also allows the power monitoring system to remotely report power usage, current flow and trip history. For more information on POWERLOGIC system capabilities, see publication 3050SM9101R11/91, *POWERLOGIC® Product Interface for MICROLOGIC® Circuit Breakers*.

Specifications

Electronic trip insulated case circuit breakers have a molded case made of a glass-reinforced insulating material that provides high dielectric strength. These circuit breakers

- have a true, 2-step, stored energy closing mechanism
- have fixed or drawout mounting
- have mechanical PUSH-TO-OPEN and PUSH-TO-CLOSE buttons
- have normal power and control power terminations
- have position indication for contacts and closing springs
- share common tripping of all poles
- can be mounted and operated in any position
- meet the requirements of NEC Section 240-6 by providing a means to seal the rating plug and trip unit adjustments
- are equipped with an externally accessible test port for use with a universal test set
- are fully tested, UL Listed and CSA Certified for reverse connection without restrictive LINE or LOAD markings.

Circuit Breaker Ratings

Voltage Ratings

Voltage ratings indicate the maximum voltage for the electrical system on which the circuit breaker can be applied. All Square D electronic trip insulated case circuit breakers are designed to be applied on systems rated 600 Vac or less. They are not designed for use on dc systems.

Ampere Rating

The ampere rating of an electronic trip circuit breaker is the maximum current that a circuit breaker can carry. It is determined by the mathematical equation:

$$\text{Ampere Rating (P)} = \frac{\text{Sensor Size (S)}}{\text{Rating Plug \%}} \times \text{Rating Plug \%}$$

- The circuit breaker sensor size is the maximum ampere rating possible for a *specific* circuit breaker. This value is based on the size of the current sensor inside the circuit breaker. (Current sensors are an integral part of the circuit breaker and cannot be removed or replaced.)

NOTE: The maximum ampere rating a circuit breaker *family* can carry is called the frame size. Sensor size is less than or equal to frame size.

- The rating plug varies the circuit breaker ampere rating as a function of its sensor size. (The rating plug catalog number is ARPXXX, with XXX being the multiplier value.) This multiplier value is printed on the faceplate of the rating plug along with the mathematical equation used to obtain the ampere rating.

Continuous Current Rating

The continuous current rating of an electronic trip circuit breaker is determined by the mathematical equation:

$$\text{Continuous Current Rating} = \frac{\text{Ampere Rating (P)}}{\text{Long-time Setting}}$$

- The circuit breaker ampere rating (P) is found by multiplying the circuit breaker sensor size by the rating plug multiplier.
- The long-time pickup switch varies the circuit breaker continuous current rating as a multiple of the ampere rating. Switch positions are adjustable from 0.5 to 1.0.

Frequency Rating

Electronic trip circuit breakers are recommended for applications only on systems at 50/60 Hz. These circuit breakers have not been evaluated at any other frequency.

Interrupting Rating

The interrupting rating is the highest current at rated voltage the circuit breaker is designed to safely interrupt under standard test conditions. Circuit breakers must be selected with interrupting ratings equal to or greater than the available short-circuit current at the point where the circuit breaker is applied in the system (unless it is a branch device in a series rated combination). Interrupting ratings are shown on the faceplate of the circuit breaker.

Circuit Breaker	Interrupting Ratings		
	UL Listed Interrupting Rating★ (rms symmetrical amperes)		
	240 Vac	480 Vac	600 Vac
SEF, SED	150,000	100,000	85,000
SEHF, SEHD	200,000	150,000	100,000

★ Interruption rating is value shown or interruption rating of switchboard, whichever is **lower**.



Withstand Rating

The short-time withstand rating of a circuit breaker is the level of rms symmetrical current that a circuit breaker can carry with the contacts in a closed position for a stated period of time (usually 30 cycles).

The withstand rating is used to improve coordination by maximizing the current level at which the circuit breaker trips with no intentional delay. For more information on coordination using withstand ratings, see Application Guide SD354R2, *Circuit Breaker Characteristic Trip Curves and Coordination*. Square D recommends a system coordination study be done for optimum circuit breaker coordination.

30 Cycle Withstand Ratings	
Circuit Breaker	Withstand Rating at 600 V
SEF, SED	50 kA
SEHF, SEHD	65 kA

100% Rating

The full-function electronic trip insulated case circuit breakers are UL Listed to be applied at up to 100% of their continuous current rating.

Because of the additional heat generated when applying circuit breakers at 100% of continuous current rating, the use of specially designed enclosures and 90°C rated conductors is required.

Minimum Enclosure Size for 100% Rating	
Circuit Breaker	Enclosure Size★
SEF 400-1600	29.5 H x 30 W in, min. vol. 31,860 in ³ 749 H x 762 W mm, min. vol. 809,244 mm ³
SED 400-1600	29.5 H x 30 W in, min. vol. 42,480 in ³ 749 H x 762 W mm, min. vol. 1,078,992 mm ³
SEF 2000-3000	29.5 H x 36 W in, min. vol. 38,232 in ³ 749 H x 914 W mm, min. vol. 971,093 mm ³
SED 2000-3000	29.5 H x 36 W in, min. vol. 50,976 in ³ 749 H x 914 W mm, min. vol. 1,294,790 mm ³
SEF, D 4000	90 H x 42 W x 48 D in, 3PH3W 2286 H x 1067 W x 1219 D mm, 3PH3W 90 H x 48 W x 48 D in, 3PH4W 2286 H x 1219 W x 1219 D mm, 3PH4W

★ Additional width is required for neutral bussing if 3PH4W service entrance is used. Additional width and/or height is required if the enclosure is front accessible only and/or accessories are included.

It is recommended that tests be conducted per UL891 if any one or combination of the following exist:

1. More than one device is mounted in a single section.
2. The section width is less than the standard.
3. The compartment height is less than the standard.
4. The volume is less than the standard.

Markings on the circuit breaker indicate minimum enclosure size and ventilation specifications required. The 90°C wire must be sized according to the ampacities of the 75°C wire column in the NEC.

Circuit breakers with 100% ratings can also be used in applications requiring only 80% continuous loading.

Ambient Temperature Rating

To meet the requirements of UL Standard 489, molded case circuit breakers are designed, built and calibrated for use on 50/60 Hz ac systems. Electronic trip circuit breakers, however, are designed to react only to the magnitude of the current flowing through the circuit breaker. MICROLOGIC electronic trip circuit breakers are inherently ambient insensitive in the range of -5°C to +60°C.

Trip System

The trip system causes the circuit breaker to open automatically under overload, short-circuit or ground-fault conditions. The MICROLOGIC trip system consists of the current sensors, a microprocessor-based trip unit, and a tripping coil. The tripping coil is a flux transfer solenoid which requires no external power source. All MICROLOGIC protective functions are completely fault powered. The trip system operation and adjustments are fully described in Part 2 of this catalog.

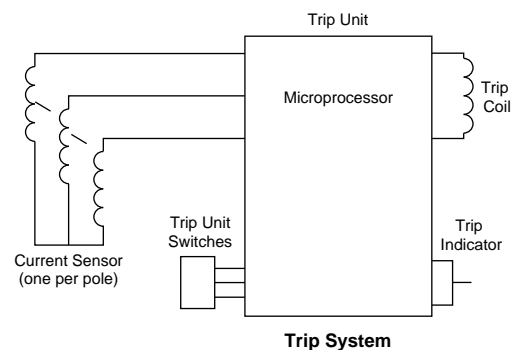

Two-Step Energy Closing Mechanism

Square D insulated case circuit breakers include a two-step stored energy mechanism that provides a maximum closing time of five cycles. Two-steps refers to the two distinct operations required to close the circuit breaker:

- Electrically or manually charging the closing springs.
- Pressing the PUSH-TO-CLOSE button to release the closing mechanism and close the contacts.

As the mechanism closes, the opening springs are automatically charged so that the circuit breaker may be opened by pressing the PUSH-TO-OPEN button.



Charging the Closing Springs



SE Charging Handle and Label

The closing springs may be charged electrically or manually.

The charging handle that pivots out from the front of the circuit breaker is used to manually charge the closing springs. The handle must be moved up and down about 25 times until it disengages and moves freely.

At this time, the closing springs indicator reads CHARGED and the charging handle may be returned to the stored position.

Excessive force should not be necessary to operate the circuit breaker's manual charging handle. If a problem occurs contact your local Square D sales office or Square D Field Services Division at **1-800-634-2003** for assistance.

Electrical charging of the closing springs is accomplished using a spring charging motor. The spring charging operation, which takes approximately seven seconds, is initiated automatically whenever the closing springs are discharged and power is supplied to the charging motor. When the springs are completely charged, the motor is disconnected and CHARGED appears in the window of the closing spring's indicator. A manual charging handle is provided as an integral part of electrically-operated circuit breakers for manual charging, if necessary.

Closing the Circuit Breaker Contacts

After the closing springs have been charged, the circuit breaker contacts may be closed locally using the PUSH-TO-CLOSE button, or remotely using a shunt close auxiliary device. Once the circuit breaker contacts have been closed, DISCHARGED appears in the closing spring's indicator window, and the contact opening springs are automatically charged.

The entire circuit breaker closing operation may be accomplished from a remote location using the following auxiliary components:

1. The spring charging motor charges the closing springs from a remote signal (factory installable, field replaceable).
2. The shunt trip device opens the circuit breaker contacts from a remote signal (factory installable, field replaceable).
3. The shunt close device closes the circuit breaker contacts from a remote signal (factory installable, field replaceable).

Fixed Mount Construction

Fixed mount SE insulated case circuit breakers are intended for use in equipment requiring stationary mounting of circuit breakers. Power connections are bolted directly to the terminals or extensions of the circuit breaker. Control power connections for accessories are made through terminal blocks on the side of the circuit breaker.

The face of a fixed mounted circuit breaker fits through an opening in the switchboard cell door to provide access to the circuit breaker controls when the cell door is closed. Optional interlocks prevent the circuit breaker from closing when the cell door is open.

Drawout Construction

Drawout construction of SE insulated case circuit breakers provides easy installation and inspection of the circuit breaker. Power connections are made using plug-on pressure connections. Control power wiring is done with a control power connector (control power supply side) and terminal blocks (control power load side) mounted on the drawout carriage.

The circuit breaker can be easily racked into and out of its cell using the drawout crank (Catalog Number SEDC). A position indicator on the front of the circuit breaker indicates the circuit breaker's position within the cell. The position indicator shows one of the following positions:

DISC—Indicates that the circuit breaker is not retained in the cell and can be manually rolled into and out of the cell. All control and power connections are disengaged.

TEST—Indicates that the circuit breaker is retained in the cell, but the power connectors are disengaged. The control power connectors are connected.

CONN—Indicates that all control and power connectors are engaged. The circuit breaker is ready for service.

The face of a standard drawout SED circuit breaker fits through an opening in the switchboard cell door and allows access to the circuit breaker controls when the cell door is closed. Optional interlocks prevent the circuit breaker from being drawn into the carriage when the cell door is open.

Push-To-Open and Push-To-Close Buttons

Each SE insulated case circuit breaker can be manually opened and closed. For ease of operation, the PUSH-TO-OPEN and PUSH-TO-CLOSE buttons are located on the face of each insulated case circuit breaker. These buttons meet the requirements of NEC Section 240-80, which requires the manual operation of circuit breakers.

When the closing springs have been charged, SE circuit breakers may be closed using the PUSH-TO-CLOSE button. The opening springs are automatically charged when the circuit breaker is closed. On electrically-operated circuit breakers, the closing springs are recharged by the spring charging motor immediately after closing.

An optional cover limits access to the PUSH-TO-CLOSE button and inhibits accidental manual closing of the circuit breaker contacts. In an emergency, the circuit breaker may be manually closed by inserting a small screwdriver through the hole in the cover and depressing the PUSH-TO-CLOSE button.

The PUSH-TO-OPEN button is used to manually open the circuit breaker. This button can be used to exercise the tripping mechanism and test any electrical accessories, except alarm



switches. The alarm switch will only actuate when the circuit breaker has been tripped from the internal tripping coil. The alarm switch will not indicate if the circuit breaker has been opened manually or by the use of a shunt trip. Since all operating parts are exercised when operated in this manner, the use of the PUSH-TO-OPEN button verifies that the circuit breaker mechanism is operable. Also, this button can be used to check emergency circuit and motor sequencing operations, and to diagnose electrical problems. Square D recommends that the circuit breaker tripping mechanism be exercised at least annually.

In keeping with the intent of NEC Section 240-80, Square D does not recommend restricting access to the PUSH-TO-OPEN button. A PUSH-TO-OPEN padlock attachment is available to hold the circuit breaker mechanism in the open position.

Contact Position Indicator

All SE insulated case circuit breakers are equipped with a contact position indicator. This indicator reads OPEN when the circuit breaker has been turned off or has tripped, and CLOSED when the circuit breaker is on.

If the circuit breaker has tripped, the trip indicator (located on the face of the trip unit) identifies the type of fault (overload, short circuit, or ground fault) that opened the circuit breaker.

Interlocks

The SE insulated case circuit breaker includes interlocks to deter unsafe or incorrect operation. The interlock features are provided to minimize the possibility of contact with energized parts or exposure to hazardous conditions. Certain interlocks may be bypassed on a de-energized system. Consult the SE circuit breaker instruction manual for information on bypassing these interlocks.

All SE circuit breakers are equipped with an auxiliary cover interlock and trip unit interlock. Depending on the mounting construction (fixed or drawout), several optional interlocks may be used.

Instantaneous OFF Feature

Full-function circuit breakers with adjustable long-time, short-time and instantaneous (LS[I]) trip units provide the unique ability to turn the instantaneous tripping function OFF. Turning OFF the instantaneous trip function increases the current level at which the circuit breaker will trip with no intentional delay to the level of the short-time withstand rating. This current level is typically much higher than any of the pickup levels provided by the adjustable instantaneous feature.

In other words, using the “instantaneous OFF” feature improves coordination by allowing the user to take advantage of the circuit breaker withstand rating.

Testing Requirements

The UL label on a Square D insulated case circuit breaker indicates that the circuit breaker meets the requirements of UL Standard 489 and that the manufacturer's production procedure is monitored by UL Field Representatives to ensure continuing conformance to UL performance requirements. These requirements include the following tests:

Limited Available Fault Current Tests

- 200% Overload Calibration – each pole of the circuit breaker must trip within a specified time limit when carrying 200% of its continuous current rating.
- 135% Overload Calibration – with all poles loaded equally, the circuit breaker must trip within a specified time limit while carrying 135% of its continuous current rating.
- Overload – the circuit breaker must make and break 600% of its continuous current rating at rated voltage. Circuit breaker frame sizes through 1600 A must perform 50 operations at 600%. Circuit breaker frame sizes over 1600 A through 2500 A must perform 25 operations at 600%. Circuit breaker frame sizes 3000 A and 4000 A complete three operations at 600% and 25 operations at 200%.
- Temperature Rise – while carrying 100% of rated current and mounted in an enclosure, temperature rise on a wiring terminal must be within specified limits.
- Endurance – the circuit breaker must complete the following number of operations:

Frame Size	Operations With Current	Operations Without Current
4000	400	1100

- Calibration Retest – both the 200% and 135% overload calibration tests are repeated.
- Short Circuit – the circuit breaker must interrupt the current while maintaining the integrity of the circuit breaker. Three-pole circuit breakers receive two short-circuit tests per pole and one short-circuit test on three poles for a total of seven short-circuit tests.
- Trip Out – the 200% thermal calibration test is repeated following the short-circuit tests.
- Dielectric – the circuit breaker must withstand, for one minute, twice its rated voltage plus 1000 V:
 - Between line and load terminals with the circuit breaker in the tripped and in the OFF positions.
 - Between terminals of opposite polarity with the circuit breaker closed.
 - Between live parts and the overall enclosure with the circuit breaker both open and closed.

No conditioning of the circuit breaker can take place during or between tests and all functional parts of the circuit breaker must be operational at the conclusion of the sequences.



General Information

High Available Fault Current Tests

After qualifying a set of circuit breakers to the standard tests, a manufacturer can have additional circuit breaker samples tested on higher than standard available fault currents. The following performance requirements apply:

- 200% Overload Calibration – each pole of the circuit breaker must trip within a specified time limit when carrying 200% of its continuous current rating.
- Short-circuit Test – with the load side terminals connected with specified bus, the circuit breaker is exposed to a short-circuit current for a set time interval. After safe interruption, the circuit breaker is reset and closed on the short circuit.
- 250% Overload Calibration – each pole of the circuit breaker must trip within a specified time limit when carrying 250% of its continuous current rating.
- Dielectric Withstand – the circuit breaker is subjected to twice its rated voltage, but not less than 900 V.
 - Between line and load terminals with the circuit breaker in the tripped and in the OFF positions.
 - Between terminals of opposite polarity with the circuit breaker closed.
 - Between live parts and the overall enclosure with the circuit breaker both open and closed.

When the sample circuit breakers pass these tests, circuit breakers of the same construction can be marked or labeled with the higher current interrupting rating.

Maintenance and Testing

Insulated case circuit breakers require little maintenance, but an inspection and maintenance procedure should be established from the time of installation. The service life of electronic trip insulated case circuit breakers depends on proper application, correct installation, suitable environmental conditions, and preventive maintenance. The guide most frequently used as a basis for field testing requirements is NEMA Standard AB4, *Guidelines for Inspections and Preventive Maintenance of Molded Case Circuit Breakers Used in Commercial and Industrial Applications*.

Square D recommends that insulated case circuit breakers be inspected and tested during the normal annual maintenance of electrical systems. If operating or environmental conditions are severe, more frequent inspections are recommended.

Note: Square D insulated case circuit breakers must not be disassembled. Doing so would void the UL Listing and the Square D warranty.

Inspection and Preventive Maintenance

Inspection procedures check items that may indicate a potential problem. For information on inspection and preventive maintenance, see Square D Circuit Breaker Application Guide 0600SC9401, *Field Testing and Maintenance: MICROLOGIC and Industrial Molded Case Circuit Breakers*.

Performance and Verification Testing

Performance tests such as insulation resistance tests, watts loss tests and electronic tripping function trip tests can be performed to verify that the circuit breaker is able to perform its basic functions.

Use secondary injection testing or primary injection testing to check the trip system. A Square D Universal Test Set (Catalog Number UTS3) is available for secondary injection testing.

If additional information or assistance is needed, contact your local Square D Field Sales Office. For on-site service, contact Square D Field Services, 24 hours a day, at 1-800-634-2003.

Catalog Numbers

When ordering Square D insulated case circuit breakers, include the circuit breaker family, description, poles, voltage rating, ampere rating and suffix.

The following figure shows the catalog number broken down by component. For example, SEHD36800LSG, a typical catalog number, can be broken down as follows:

SEH	Circuit breaker family
D or F	Indicates how the circuit breaker is constructed
3	Number of poles requested
6	Voltage rating specified
800	Continuous current ampere rating (handle rating) range specified
LSG	Available trip unit option



General

Square D electronic trip insulated case circuit breakers are equipped with the MICROLOGIC Full-function Trip System. This trip system provides adjustable tripping functions and characteristics using true root-mean-square (rms) current sensing.



Full-function Trip Unit

MICROLOGIC trip systems use a set of current transformers (called CTs or sensors) to sense current, a full-function trip unit to evaluate the current, and a tripping solenoid to trip the circuit breaker. Adjustable rotary switches on the trip unit allow the user to set the proper overcurrent or ground current protection required in the electrical system. If current exceeds a set value for longer than its set time delay, the trip system opens the circuit breaker.

Circuit breakers are shipped with the long-time pickup switch set at 1.0 and all other trip unit adjustments set at their lowest settings. Actual settings required for a specific application must be determined by a qualified consultant or plant engineer. A coordination study is recommended to provide coordination between all circuit breakers in the distribution system.

RMS Sensing

The sensing system on an electronic trip insulated case circuit breaker responds to the flow of current through the circuit breaker. Electronic trip circuit breakers are limited to ac systems because the electronic trip system uses current transformers to sense the current.

The MICROLOGIC trip system samples the current waveform 33 times per cycle on a 60 Hz system. It then uses this data to calculate the true rms current through the 13th harmonic.

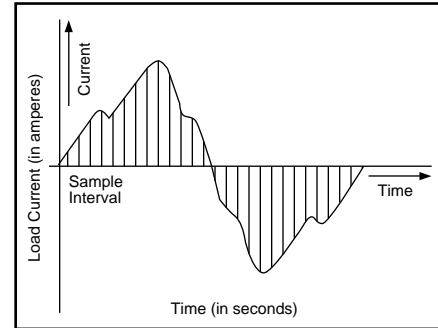

Trip System Current Sensing

This true rms sensing gives accurate values for the magnitude of a non-sinusoidal waveform. Therefore, the heating effects of harmonically distorted waveforms are accurately evaluated.

Electronic trip circuit breakers with MICROLOGIC trip systems can be used on 50/60 Hz systems with alternating current (ac) to direct current (dc), dc to ac, and ac to ac converters. This includes applications that use silicon-controlled rectifiers (SCRs) and adjustable frequency controls.

Rating Plugs

Rating plugs are used to determine the circuit breaker ampere rating (P) according to the following equation:

$$\text{Ampere Rating (P)} = \text{Sensor Size (S)} \times \text{Rating Plug \%}$$

The ampere rating and the long-time pickup switch are then combined to determine the circuit breaker continuous current rating. For example:

$$\text{Continuous Current Rating} = \text{Sensor Size (S)} \times \text{Rating Plug \%} \times \text{Long-time Setting}$$

$$225 = 600 \times 0.75 \times 0.5$$

Rating plugs are available with multiplier values ranging from 0.40 to 1.00. If the rating plug is not installed, the circuit breaker will operate safely, but the trip unit will default to a rating plug multiplier of 0.40.



Rating Plug

Rating plugs and ammeter/trip indicators are subject to damage from static charge. Internal damage can result if these devices are handled by their contacts. If either device is removed from the trip unit, it must be held against grounded metal, such as the metal circuit breaker enclosure, for at least two seconds before reinstalling.



MICROLOGIC® Trip Systems

Each MICROLOGIC circuit breaker is shipped with a rating plug factory installed. The label on the circuit breaker marked “Configuration as Shipped” gives the circuit breaker configuration as it left the factory. Field-installable rating plug kits are also available. See Part 3 – Accessories for available field-installable rating plug kits.

Ground-fault pickup values are based on the sensor size of the circuit breaker and are not affected by changing the rating plug.

Ammeter/Trip Indicator

The ammeter/trip indicator is a troubleshooting tool used to identify the type of fault if an overcurrent condition occurs, and to find potential overcurrent situations.



Ammeter/Trip Indicator

The ammeter/trip indicator displays current in phases A, B and C, and the peak ground-fault current flowing in the circuit. Each value can be viewed one at a time using the phase select/indicator reset button. (Phase values are displayed in true rms. Ground-fault current values are displayed in calculated rms based on measured peak current.) A bar graph is provided indicating the level of operating current as a percentage of the programmed ampere rating of the circuit breaker.

The ammeter/trip indicator window displays “OVERLOAD,” “SHORT CIRCUIT,” or “GROUND FAULT” when the circuit breaker trips from an overcurrent. The indicator must be manually reset by pushing the phase select/indicator reset button.

The ammeter can also be used as a rough guide when setting the ground-fault pickup when a coordination study is not available. Selecting the GF screen under normal operating conditions will display the ground-fault leakage current under those conditions. In order to protect against abnormal conditions, the ground-fault pickup should be set somewhat higher than the GF value displayed on the screen.

The phase select/indicator reset button can be pressed at any time to test the ammeter/trip indicator battery condition. The window will display a battery symbol. If this does not occur, contact Square D for a replacement ammeter/trip indicator.

The ammeter/trip indicator is factory installed on the full-function circuit breaker. It can be installed in or removed from the trip unit without tripping the circuit breaker.

Memory Feature

MICROLOGIC trip systems feature a memory circuit for intermittent overload or ground-fault conditions. This allows the circuit breaker to respond to a series of ON and OFF overload or ground-fault conditions which could cause conductor overheating, but go undetected in a conventional electronic trip device.

If the circuit breaker trips due to an overcurrent condition, wait at least one minute before resetting the circuit breaker. This allows the memory to clear itself sufficiently for the circuit breaker to be turned ON. If checking trip times, wait fifteen minutes after the circuit breaker trips before resetting to allow memory to reset completely to zero (or use a memory reset module, Cat. No. MTMB).

Ground-fault Detection

Full-function circuit breakers are available with integral ground-fault *detection* to provide either ground-fault protection (trip) or alarm (no trip) on solidly grounded systems. These circuit breakers utilize a residual sensing scheme for ground-fault detection.

Full-function circuit breakers are also available with integral equipment ground-fault *protection*.

Full-function circuit breakers are also available with integral ground-fault *alarm* (no trip) to monitor the flow of ground-fault current and signal an alarm condition through the POWERLOGIC® system. This feature meets NEC Sections 700-7(d) and 700-26 for emergency systems. Circuit breakers with the ground-fault alarm trip system DO NOT provide ground-fault protection (do not trip).

Ground-fault *protection* trip units include both ground-fault pickup and delay adjustments. Ground-fault *alarm* (no trip) trip units include only ground-fault pickup adjustments.

Circuit breakers with either ground-fault protection or alarm (no trip) trip systems are equipped with an internal ground-fault push-to-test feature. The ground-fault push-to-test is built into the circuit breaker and eliminates the need for any additional test equipment, such as monitor panels. The ground-fault push-to-test requires 120 Vac control power.

Zone-selective Interlocking

Zone-selective interlocking (ZSI, also called zone restraint) is used to reduce the stress on electrical distribution equipment during fault conditions while maintaining coordination.

ZSI allows electronic trip devices to communicate with each other so that a short circuit or ground fault will be isolated and cleared by the nearest upstream circuit breaker with no intentional time delay. Devices in all other areas of the system (including upstream) remain closed to maintain service to unaffected loads.



ZSI limits fault stress on the power distribution system by reducing the time it takes to clear the fault, while maintaining system coordination between overcurrent protective devices.

ZSI is a standard feature on MICROLOGIC full-function circuit breakers. In order to have a functional ZSI system, Square D electronic trip devices require interconnect wiring between their terminal strips using a twisted pair of #14 or #18 AWG conductors.

For more information on zone-selective interlocking, see Application Guide 0600SC9102R6/95, *Reducing Fault Stress With Zone-selective Interlocking*.

Trip Characteristics

MICROLOGIC trip units provide a full range of adjustable tripping characteristics using a programmable microcomputer that constantly monitors the line currents. The overcurrent or ground-fault current pickup and delay levels are set using adjustable rotary switches on the face of the trip unit. If the line current exceeds the trip settings, the microcomputer signals the circuit breaker to trip.

Adjustable Tripping Characteristics for Electronic Trip Circuit Breakers	
Full-function Trip Unit	
Long-time pickup	
Long-time delay	
Short-time pickup	
Short-time delay (I ² t IN and I ² t OUT)	
Instantaneous pickup	
Instantaneous OFF	
Ground-fault pickup	
Ground-fault delay (I ² t IN and I ² t OUT)	
Ground-fault alarm	

Trip settings are used to obtain a coordinated system in which a downstream circuit breaker will trip before an upstream circuit breaker.

Properly adjusting the MICROLOGIC trip settings will result in a circuit breaker trip curve that falls above and to the right of the branch circuit breaker trip curve. Under overcurrent conditions, the branch circuit breaker will trip first.

Square D recommends that a system coordination study be done to find the proper trip unit settings to optimize coordination with other devices.

I²t out delay is a “constant time” characteristic in that the delay time does not change as the current increases.

Full-function Trip Unit Functions

The full-function trip unit trip curve drawing, which follows, shows the various parts of a typical trip curve affected by the adjustments on a full-function trip unit.

Adjusting the trip unit switches will shift that area of the trip curve.

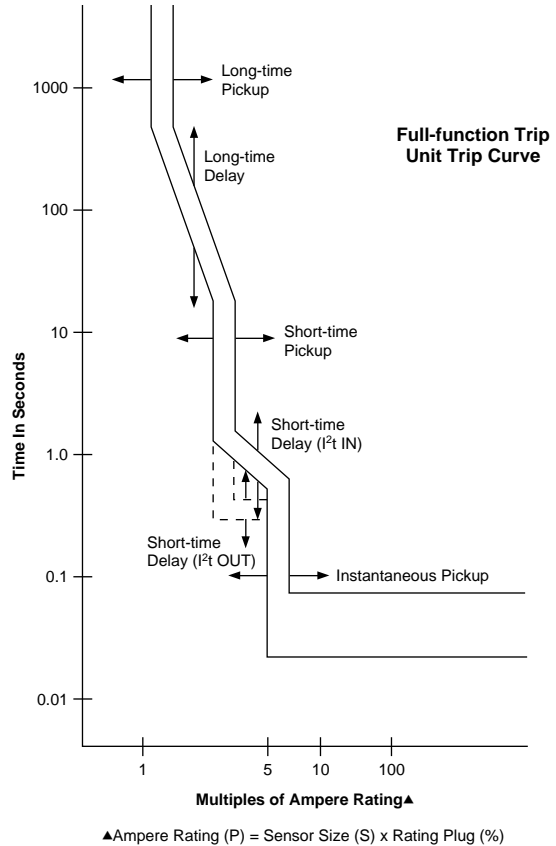

Long-time Trip Function

LONG-TIME PICKUP Switch — Switch value (multiplied by the ampere rating) sets the maximum current level which the circuit breaker will carry continuously. If the current exceeds this value for longer than the long-time delay time, the circuit breaker will trip.

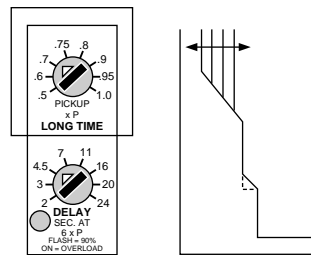

LONG-TIME DELAY Switch — Sets length of time that the circuit breaker will carry a sustained overload before tripping.

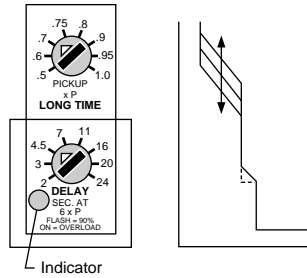

Delay bands are labeled in seconds of overcurrent at six times the ampere rating. For maximum coordination, there are eight delay bands.

Long-time delay is an "inverse time" characteristic in that the delay time decreases as the current increases.

Indicator — the trip unit includes an indicator that will flash when the current reaches 90% of the LONG-TIME PICKUP setting and will be lit continuously when the current is above 100% of the pickup setting.

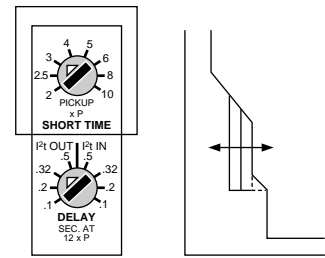

Short-time Trip Function

SHORT-TIME PICKUP Switch — Switch value (multiplied by the ampere rating) sets the short-circuit current level at which the circuit breaker will trip after the set SHORT-TIME DELAY.

SHORT-TIME DELAY Switch

— Sets length of time the circuit breaker will carry a short circuit within the short-time pickup range. The delay (based on 12 times the ampere rating, P) can be adjusted to four positions of I^2t ramp operation (I^2t IN) or four positions of fixed time delays (I^2t OUT).

I^2t IN delay is an "inverse time" characteristic in that the delay time decreases as the current increases.

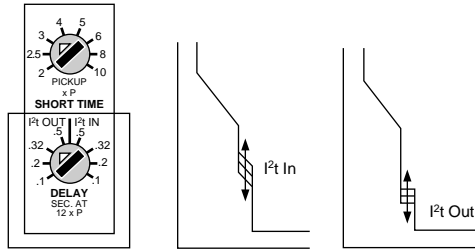

I^2t Out Instantaneous Trip Function

INSTANTANEOUS PICKUP Switch — switch value (multiplied by the ampere rating) sets the short-circuit current level at which the circuit breaker will trip with no intentional time delay.

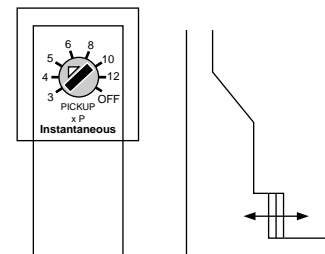

The instantaneous function will override the short-time function if the INSTANTANEOUS PICKUP is adjusted at the same or lower

setting than the SHORT-TIME PICKUP.

In full-function trip units with both adjustable short-time and instantaneous trip functions, the adjustable instantaneous trip can be disabled by setting INSTANTANEOUS PICKUP to OFF.

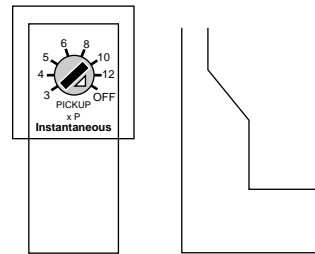

Even when the instantaneous pickup is turned OFF, an instantaneous override occurs at the circuit breaker short-time withstand rating.

Ground-fault Trip Function

GROUND-FAULT PICKUP Switch — switch value (multiplied by the sensor size) sets the current level at which the circuit breaker will trip after the set GROUND-FAULT DELAY.

Ground-fault pickup values are based on circuit breaker sensor size only, not on the rating plug multiplier. Changing the rating plug multiplier has no effect on ground-fault pickup values.

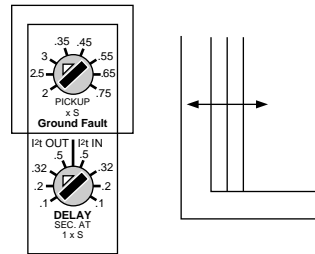

GROUND-FAULT DELAY Switch — sets length of time the circuit breaker will carry ground-fault current which exceeds the GROUND-FAULT PICKUP level before tripping. Delay can be adjusted to four positions of I^2t ramp operation (I^2t IN) or four positions of fixed time delays (I^2t OUT).

I^2t IN delay is an "inverse time" characteristic in that the delay time decreases as the current increases.

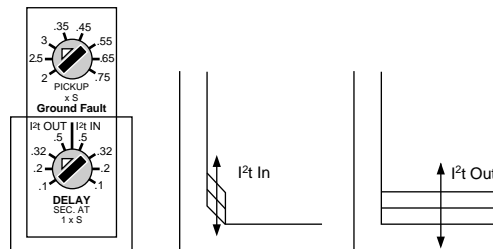

I^2t Out Ground-fault Alarm Function

GROUND-FAULT ALARM Switch — switch value (multiplied by the sensor size) sets the current level at which the circuit breaker will signal the POWERLOGIC system that a ground fault is present.

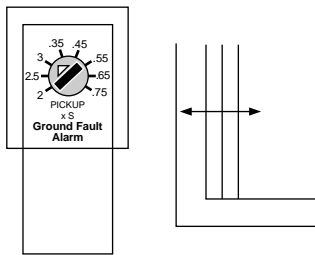

This part describes the insulated case circuit breakers available from Square D.

Description

SE/SEH – 400 A sensor, 800 A sensor, 1200 A sensor, 1600 A sensor, 2000 A sensor, 2500 A sensor, 3000 A sensor and 4000 A sensor

SE – 600 Vac, 50/60 Hz, 3-pole electronic trip circuit breaker with the full-function MICROLOGIC® trip system, includes a true two-step, stored energy closing mechanism, with a maximum 5 cycle closing time. Available in fixed or drawout construction.

SEH – 600 Vac, 50/60 Hz, 3-pole, high interrupting electronic trip circuit breaker with the full-function MICROLOGIC trip system. Includes a true two-step, stored energy closing mechanism, with a maximum 5 cycle closing time. Available in fixed or drawout construction.

Applications

SE/SEH circuit breakers are UL Listed to be applied at 100% of their continuous current rating when applied in an intended enclosure.

SE/SEH circuit breakers may be mounted and operated in any position, and are not limited to vertical or horizontal mounting.

600 Vac Short-time Withstand Rating

Sensor (Frame) Size	
SE	50 kA
SEH	65 kA

Neutral Current Transformers

Catalog Number	Sensor	Where Used
SE04NCT	400	SE, SEH
SE12NCT	800	SE, SEH
SE12NCT	1200	SE, SEH
SE30NCT	1600	SE, SEH
SE30NCT	2000	SE, SEH
SE30NCT	2500	SE, SEH
SE30NCT	3000	SE, SEH
SE40NCT	4000	SE, SEH

UL Listed Interrupting Ratings (In RMS Symmetrical Amperes)

Fixed Construction

	Voltage	Sensor Rating 400–4000 A
Standard Interrupting (SEF)	240 Vac 480 Vac 600 Vac	150 kA 100 kA 85 kA
High Interrupting (SEHF)	240 Vac 480 Vac 600 Vac	200 kA 150 kA 100 kA

Drawout Construction in QED Switchboards

	Voltage	Sensor Rating 400–4000 A
Standard Interrupting (SED)	240 Vac 480 Vac 600 Vac	150 kA 100 kA 85 kA
High Interrupting (SEHD)	240 Vac 480 Vac 600 Vac	150 kA 100 kA 85 kA

Drawout Construction in OEM Applications Only

	Voltage	Sensor Rating 400–4000 A
Standard Interrupting (SED)	240 Vac 480 Vac 600 Vac	150 kA 100 kA 85 kA
High Interrupting (SEHD)	240 Vac 480 Vac 600 Vac	200 kA 150 kA 100 kA

Field-installable Rating Plug Kits

Catalog Number	Multiplier
ARP040	0.400
ARP050	0.500
ARP056	0.563
ARP058	0.583
ARP060	0.600
ARP063	0.625
ARP067	0.667
ARP070	0.700
ARP075	0.750
ARP080	0.800
ARP083	0.833
ARP088	0.875
ARP090	0.900
ARP100	1.000

The following pages provide selection data, dimensions and tripping curves relating to 4000 A frame Square D electronic trip insulated case circuit breakers.



Circuit Breaker Specifics

Sensors/Ampere Ratings

Selection Data for 4000 A Frame

Sensor Rating	Ampere Rating	Drawout (Standard Interrupting Rating)				Drawout (High Interrupting Rating)				Rating Plug Installed
		Catalog Number				Catalog Number				
		Long-Time Instantaneous	Long-Time Short-Time Instantaneous	Long-Time Instantaneous w/Ground-Fault Protection	Long-Time Short-Time, Instantaneous w/Ground-Fault Protection★	Long-Time Instantaneous	Long-Time Short-Time Instantaneous	Long-Time Instantaneous w/Ground-Fault Protection★	Long-Time Short-Time, Instantaneous w/Ground-Fault Protection	
400 A	200	SED36200LI	SED36200LS	SED36200LIG	SED36200LSG	SEHD36200LI	SEHD36200LS	SEHD36200LIG	SEHD36200LSG	ARP050
	250	SED36250LI	SED36250LS	SED36250LIG	SED36250LSG	SEHD36250LI	SEHD36250LS	SEHD36250LIG	SEHD36250LSG	ARP063
	300	SED36300LI	SED36300LS	SED36300LIG	SED36300LSG	SEHD36300LI	SEHD36300LS	SEHD36300LIG	SEHD36300LSG	ARP075
	350	SED36350LI	SED36350LS	SED36350LIG	SED36350LSG	SEHD36350LI	SEHD36350LS	SEHD36350LIG	SEHD36350LSG	ARP088
	400	SED36400LI	SED36400LS	SED36400LIG	SED36400LSG	SEHD36400LI	SEHD36400LS	SEHD36400LIG	SEHD36400LSG	ARP100
800 A	600	SED36600LI	SED36600LS	SED36600LIG	SED36600LSG	SEHD36600LI	SEHD36600LS	SEHD36600LIG	SEHD36600LSG	ARP075
	800	SED36800LI	SED36800LS	SED36800LIG	SED36800LSG	SEHD36800LI	SEHD36800LS	SEHD36800LIG	SEHD36800LSG	ARP100
1200 A	1000	SED361000LI	SED361000LS	SED361000LIG	SED361000LSG	SEHD361000LI	SEHD361000LS	SEHD361000LIG	SEHD361000LSG	ARP083
	1200	SED361200LI	SED361200LS	SED361200LIG	SED361200LSG	SEHD361200LI	SEHD361200LS	SEHD361200LIG	SEHD361200LSG	ARP100
1600 A	1400	SED361400LI	SED361400LS	SED361400LIG	SED361400LSG	SEHD361400LI	SEHD361400LS	SEHD361400LIG	SEHD361400LSG	ARP088
	1600	SED361600LI	SED361600LS	SED361600LIG	SED361600LSG	SEHD361600LI	SEHD361600LS	SEHD361600LIG	SEHD361600LSG	ARP100
2000 A	1800	SED361800LI	SED361800LS	SED361800LIG	SED361800LSG	SEHD361800LI	SEHD361800LS	SEHD361800LIG	SEHD361800LSG	ARP090
	2000	SED362000LI	SED362000LS	SED362000LIG	SED362000LSG	SEHD362000LI	SEHD362000LS	SEHD362000LIG	SEHD362000LSG	ARP100
2500 A	2500	SED362500LI	SED362500LS	SED362500LIG	SED362500LSG	SEHD362500LI	SEHD362500LS	SEHD362500LIG	SEHD362500LSG	ARP100
3000 A	3000	SED363000LI	SED363000LS	SED363000LIG	SED363000LSG	SEHD363000LI	SEHD363000LS	SEHD363000LIG	SEHD363000LSG	ARP100
4000 A	3200	SED363200LI	SED363200LS	SED363200LIG	SED363200LSG	SEHD363200LI	SEHD363200LS	SEHD363200LIG	SEHD363200LSG	ARP080
	4000	SED364000LI	SED364000LS	SED364000LIG	SED364000LSG	SEHD364000LI	SEHD364000LS	SEHD364000LIG	SEHD364000LSG	ARP100

★ Substitute (A) in place of (G) for ground-fault alarm (pick-up indication only).

Continued on next page



Circuit Breaker Specifics Sensors/Ampere Ratings

Selection Data for 4000 A Frame – Continued

Sensor Rating	Ampere Rating	Fixed Mount (Standard Interrupting Rating)				Fixed Mount (High Interrupting Rating)				Rating Plug Installed
		Catalog Number				Catalog Number				
		Long-Time Instantaneous	Long-Time Short-Time Instantaneous	Long-Time Instantaneous w/Ground-Fault Protection	Long-Time Short-Time, Instantaneous w/Ground-Fault Protection★	Long-Time Instantaneous	Long-Time Short-Time Instantaneous	Long-Time Instantaneous w/Ground-Fault Protection	Long-Time Short-Time, Instantaneous w/Ground-Fault Protection★	
400 A	200	SEF36200LI	SEF36200LS	SEF36200LIG	SEF36200LSG	SEHF36200LI	SEHF36200LS	SEHF36200LIG	SEHF36200LSG	ARP050
	250	SEF36250LI	SEF36250LS	SEF36250LIG	SEF36250LSG	SEHF36250LI	SEHF36250LS	SEHF36250LIG	SEHF36250LSG	ARP063
	300	SEF36300LI	SEF36300LS	SEF36300LIG	SEF36300LSG	SEHF36300LI	SEHF36300LS	SEHF36300LIG	SEHF36300LSG	ARP075
	350	SEF36350LI	SEF36350LS	SEF36350LIG	SEF36350LSG	SEHF36350LI	SEHF36350LS	SEHF36350LIG	SEHF36350LSG	ARP088
	400	SEF36400LI	SEF36400LS	SEF36400LIG	SEF36400LSG	SEHF36400LI	SEHF36400LS	SEHF36400LIG	SEHF36400LSG	ARP100
800 A	600	SEF36600LI	SEF36600LS	SEF36600LIG	SEF36600LSG	SEHF36600LI	SEHF36600LS	SEHF36600LIG	SEHF36600LSG	ARP075
	800	SEF36800LI	SEF36800LS	SEF36800LIG	SEF36800LSG	SEHF36800LI	SEHF36800LS	SEHF36800LIG	SEHF36800LSG	ARP100
1200 A	1000	SEF361000LI	SEF361000LS	SEF361000LIG	SEF361000LSG	SEHF361000LI	SEHF361000LS	SEHF361000LIG	SEHF361000LSG	ARP083
	1200	SEF361200LI	SEF361200LS	SEF361200LIG	SEF361200LSG	SEHF361200LI	SEHF361200LS	SEHF361200LIG	SEHF361200LSG	ARP100
1600 A	1400	SEF361400LI	SEF361400LS	SEF361400LIG	SEF361400LSG	SEHF361400LI	SEHF361400LS	SEHF361400LIG	SEHF361400LSG	ARP088
	1600	SEF361600LI	SEF361600LS	SEF361600LIG	SEF361600LSG	SEHF361600LI	SEHF361600LS	SEHF361600LIG	SEHF361600LSG	ARP100
2000 A	1800	SEF361800LI	SEF361800LS	SEF361800LIG	SEF361800LSG	SEHF361800LI	SEHF361800LS	SEHF361800LIG	SEHF361800LSG	ARP090
	2000	SEF362000LI	SEF362000LS	SEF362000LIG	SEF362000LSG	SEHF362000LI	SEHF362000LS	SEHF362000LIG	SEHF362000LSG	ARP100
2500 A	2500	SEF362500LI	SEF362500LS	SEF362500LIG	SEF362500LSG	SEHF362500LI	SEHF362500LS	SEHF362500LIG	SEHF362500LSG	ARP100
3000 A	3000	SEF363000LI	SEF363000LS	SEF363000LIG	SEF363000LSG	SEHF363000LI	SEHF363000LS	SEHF363000LIG	SEHF363000LSG	ARP100
4000 A	3200	SEF363200LI	SEF363200LS	SEF363200LIG	SEF363200LSG	SEHF363200LI	SEHF363200LS	SEHF363200LIG	SEHF363200LSG	ARP080
	4000	SEF364000LI	SEF364000LS	SEF364000LIG	SEF364000LSG	SEHF364000LI	SEHF364000LS	SEHF364000LIG	SEHF364000LSG	ARP100

★ Substitute (A) in place of (G) for ground-fault alarm (pick-up indication only).



Circuit Breaker Specifics

Dimensions

SEF Circuit Breaker Mounted Dimensions

Sensor Sizes 400 A through 1200 A (SEF, SEHF)

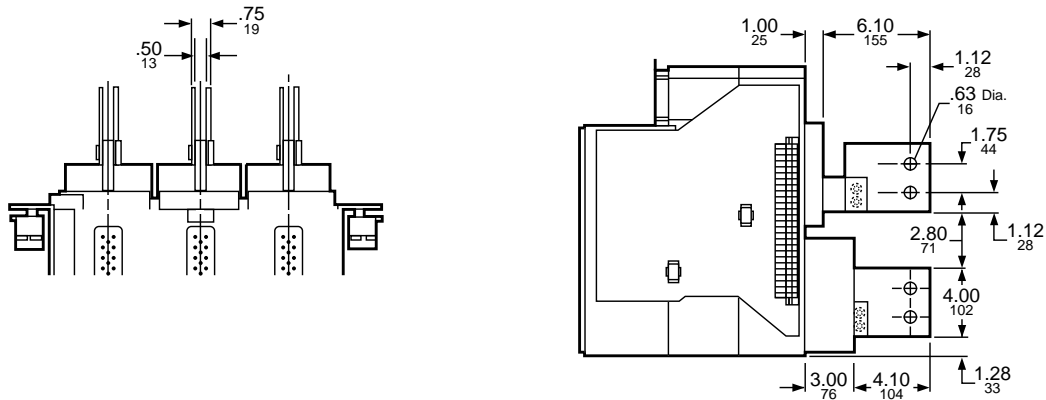

Sensor Sizes 1600 A through 4000 A (SEF, SEHF)

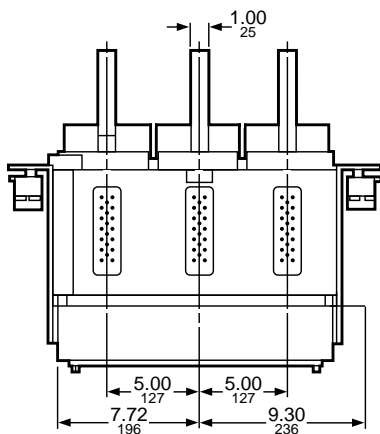

Power Connector and C.T. Dimensions

Sensor	Dim. "E"		Dim. "F"		Dim. "G"		Dim. "H"		Dim. "J"		Dim. "K"		Dim. "L"	
	IN	mm	IN	mm	IN	mm	IN	mm	IN	mm	IN	mm	IN	mm
1600 A through 3000 A	6.10	155	1.12	29	1.75	45	1.12	29	1.75	45	3.00 (Max.)	76	4.10	104
4000 A	8.10	206	1.50	38	2.00	51	1.20	31	1.60	41	3.50	89	5.35	136

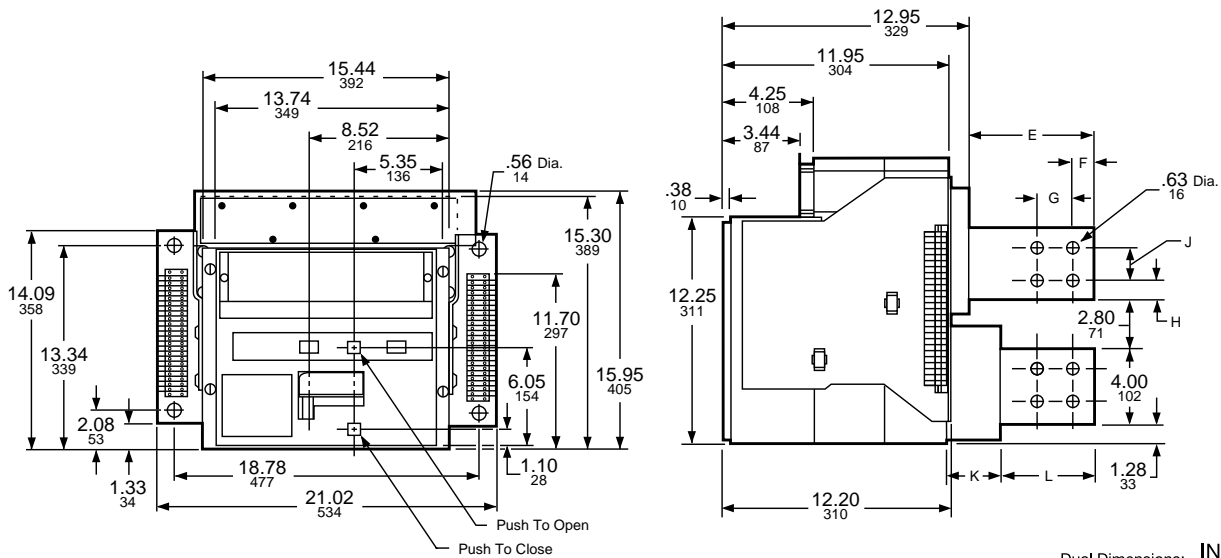

Dual Dimensions: INCHES
Millimeters



SED/SEHD Circuit Breaker Drawout Dimensions

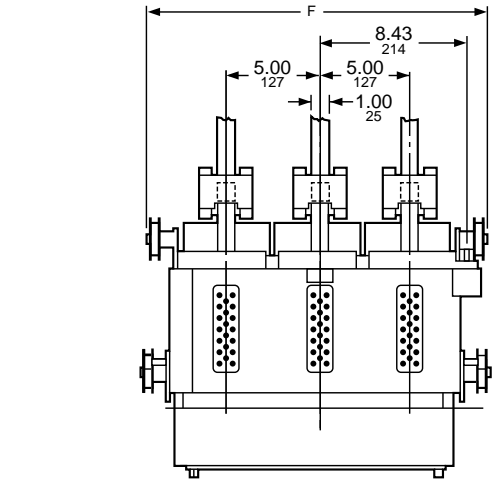

Dimensions for SED Drawout Breakers

Frame	Dim. "A"		Dim. "B"		Dim. "C"		Dim. "D"		Dim. "E"		Dim. "F"	
	IN	mm	IN	mm	IN	mm	IN	mm	IN	mm	IN	mm
SED 400 A through 1200 A	17.32	440	12.96	329	3.00	76	0.98	25	2.75	70	18.44	468
SED 3000 A	17.32	440	12.96	329	3.00	76	0.98	25	4.00	102	18.44	468
SED 4000 A	18.32	465	13.96	355	3.50	89	0.98	25	4.00	102	18.84	479

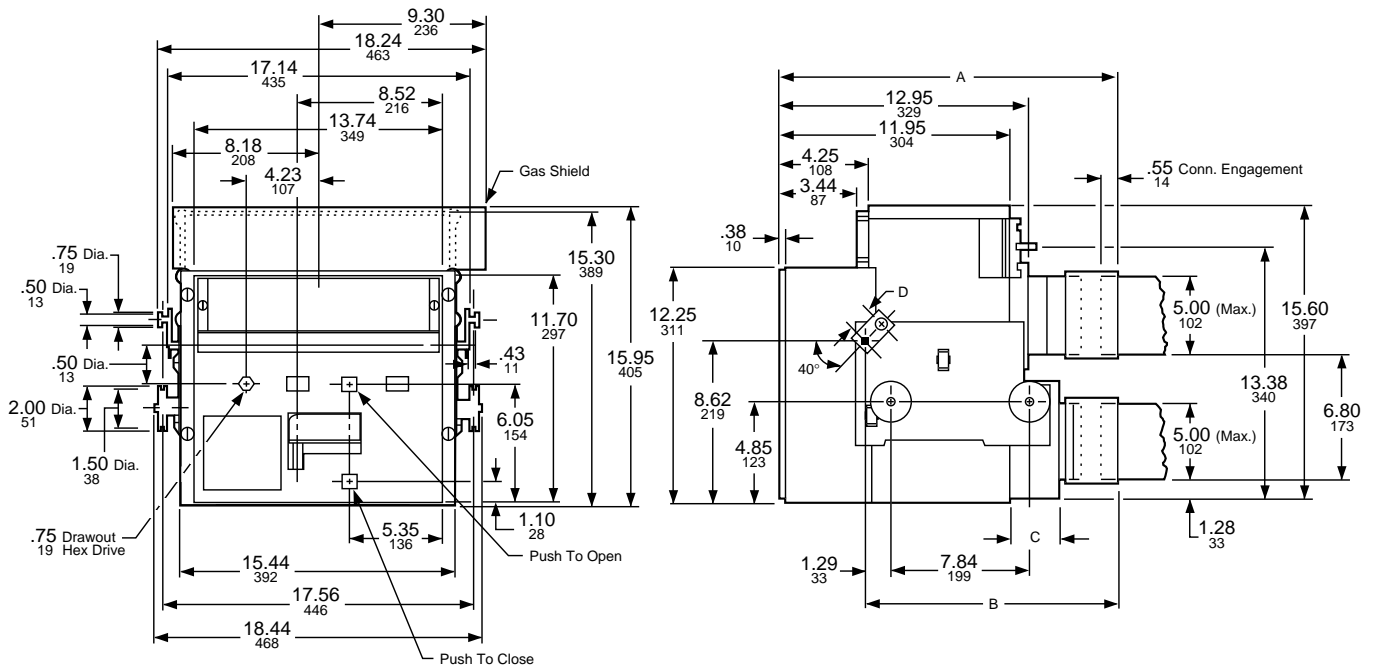

Neutral Current Transformers

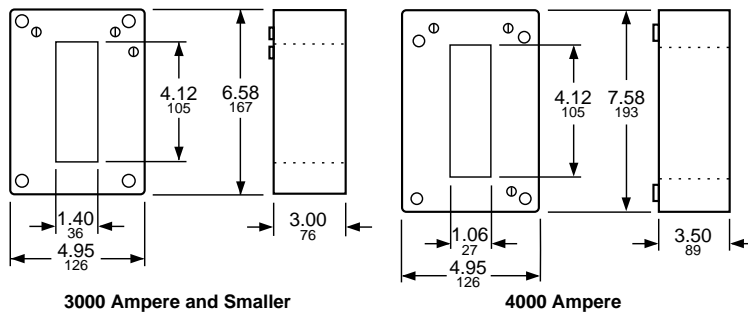

Dual Dimensions: INCHES
Millimeters



Circuit Breaker Specifics

Tripping Curves

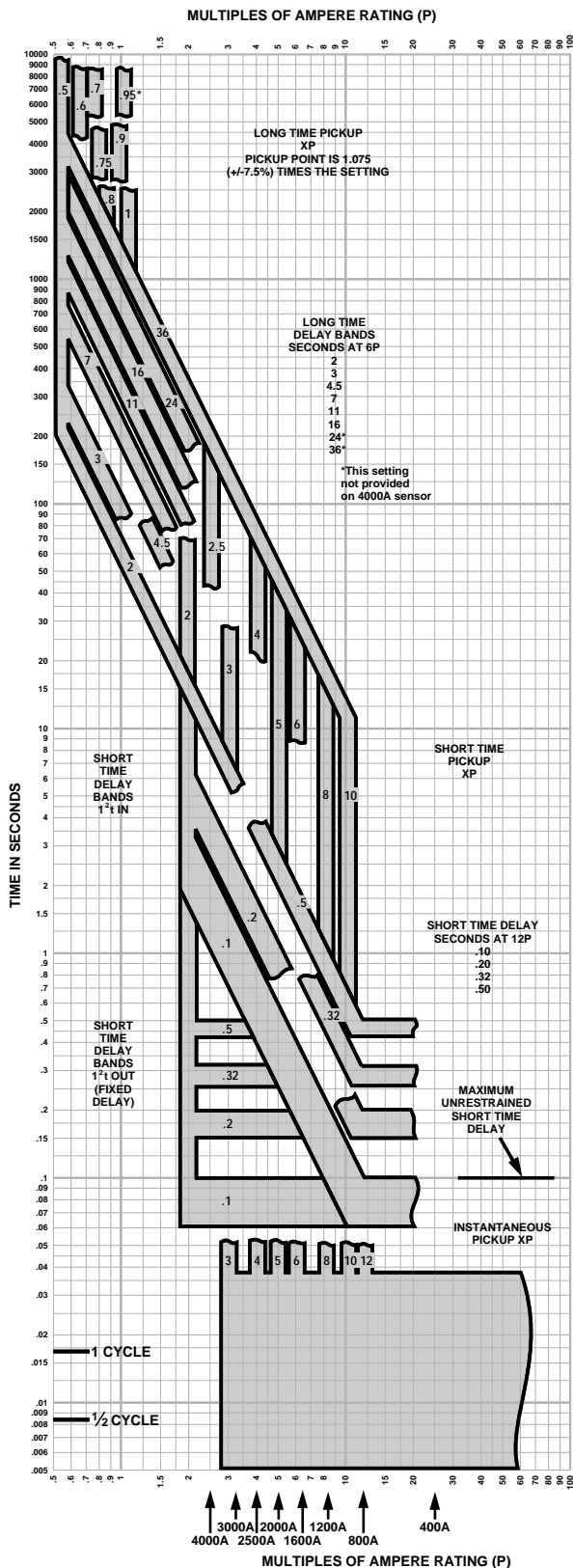

SE ELECTRONIC TRIP INSULATED CASE CIRCUIT BREAKERS LS (LSI) CHARACTERISTIC TRIP CURVE NO. 678-10

MICROLOGIC® trip unit with adjustable long time pickup and delay; short time pickup and delay; instantaneous pickup.

CIRCUIT BREAKER INFORMATION			
Sensor (S)	Ampere Rating (P)	Suitable Rating Plug Catalog No.	Multiplier (%)
400	300	RP075	75
	350	RP088	88
	400	RP100	100
800	450	RP056	56
	500	RP063	63
	600	RP075	75
	700	RP088	88
1200	800	RP100	100
	800	RP050	50
	700	RP058	58
	800	RP067	67
1600	900	RP075	75
	1000	RP083	83
	1200	RP100	100
	1400	RP088	88
2000	1600	RP100	100
	1800	RP090	90
2500	2000	RP100	100
	2500	RP100	100
3000	3000	RP100	100
	3000	RP100	100
4000	3200	RP080	80
	4000	RP100	100

NOTE: Ampere rating (P) = Sensor (S) x rating plug multiplier (%).
The EZ-AMP overlay feature at the bottom of the page should be used during coordination studies.

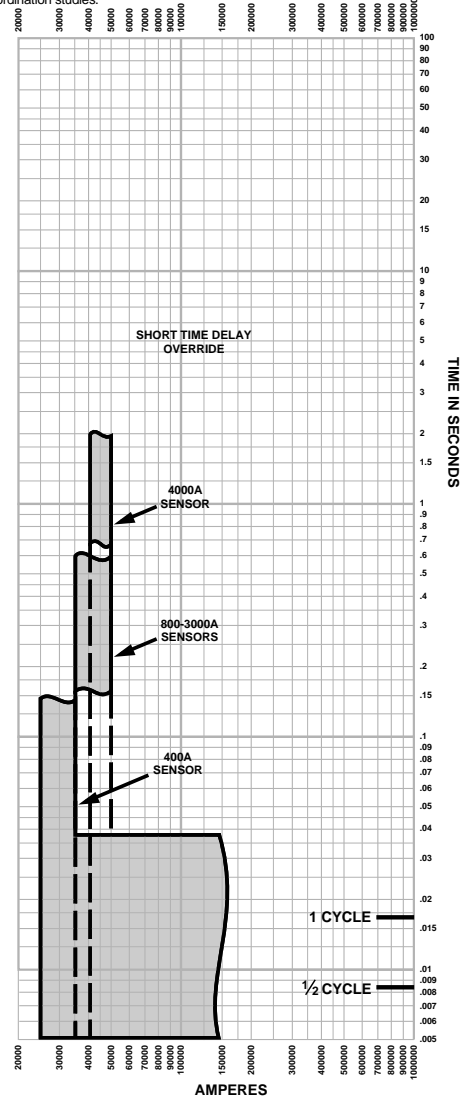

Tripping curves for coordination studies are available upon request.



Circuit Breaker Specifics Tripping Curves

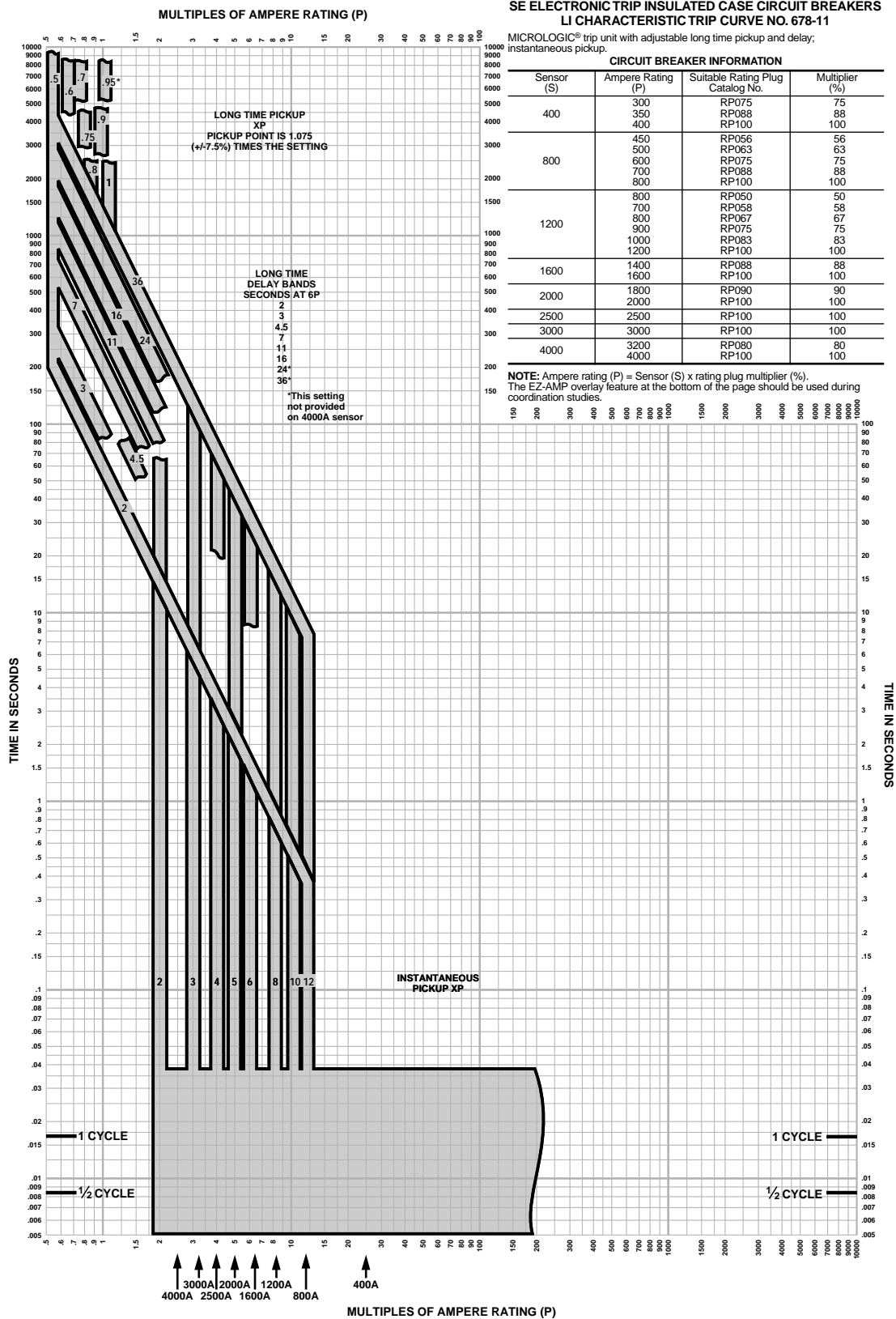

Tripping curves for coordination studies
are available upon request.



Circuit Breaker Specifics

Tripping Curves

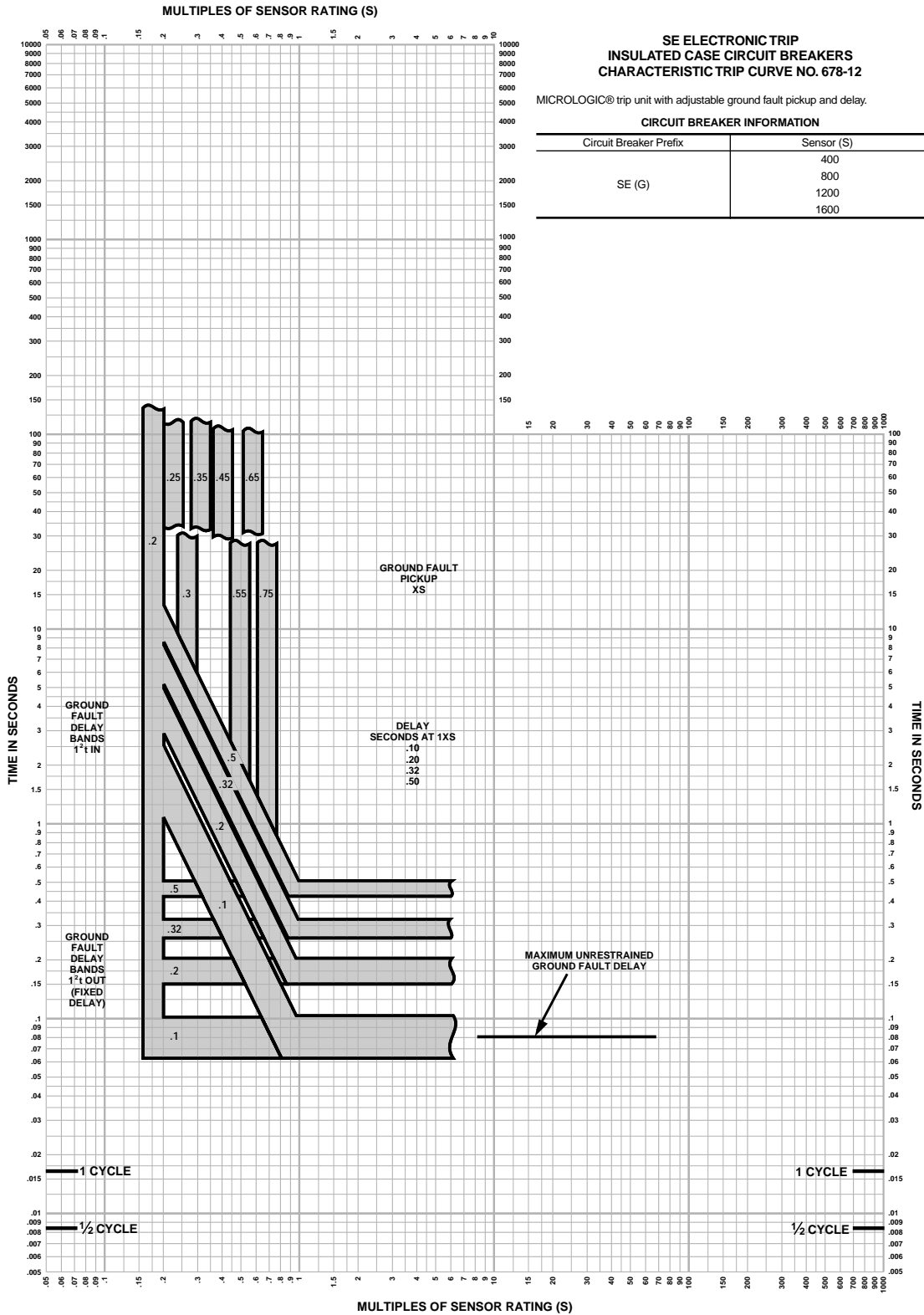

Tripping curves for coordination studies are available upon request.



Circuit Breaker Specifics Tripping Curves

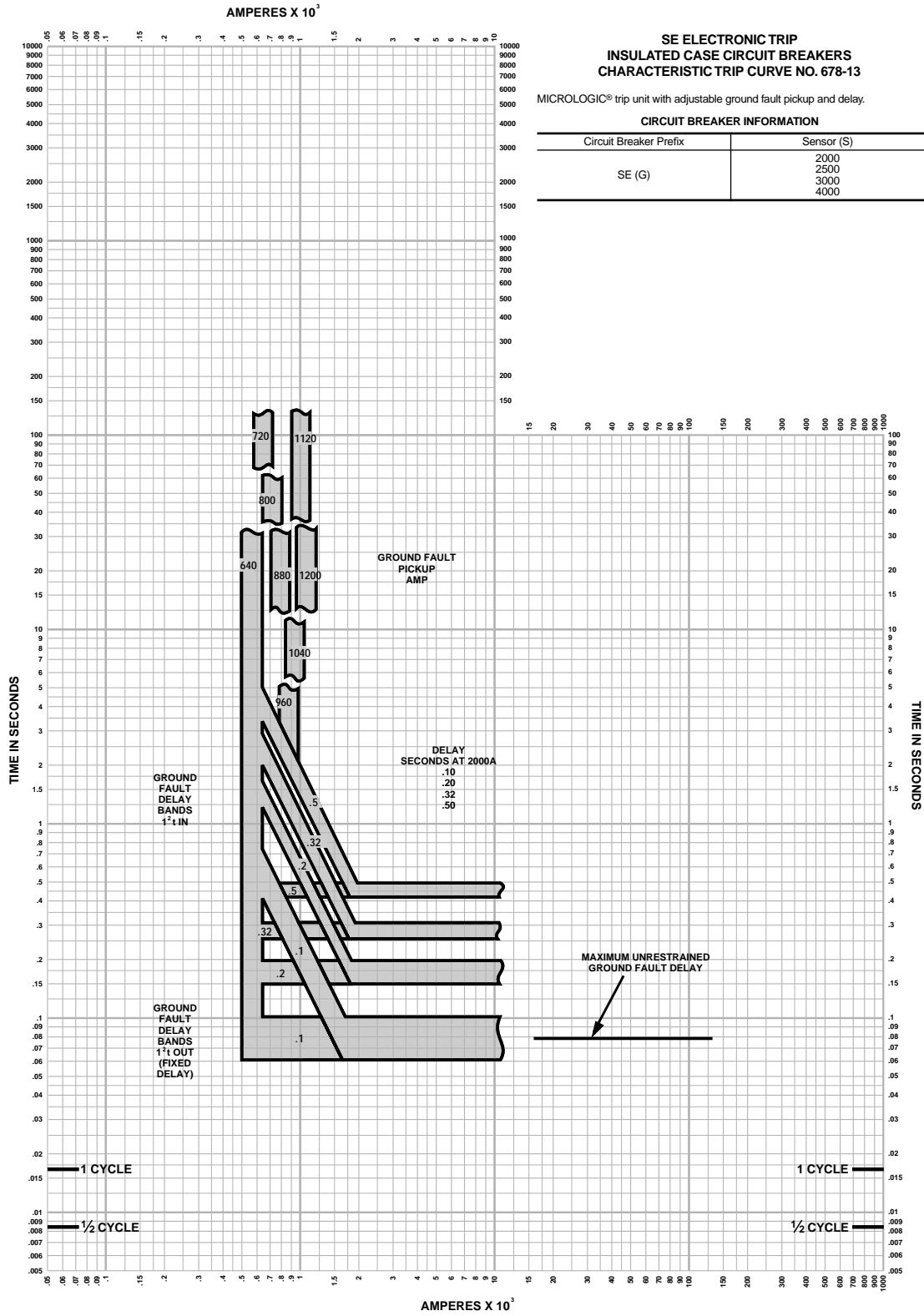

Tripping curves for coordination studies are available upon request.



Accessories

The following describes the UL Listed accessories available for Square D electronic trip (MICROLOGIC®) insulated case circuit breakers. These accessories increase application versatility and meet the demands of modern electrical distribution systems.

Electric Joint Compound

SED/SEHD circuit breakers are supplied with joint compound on the drawout power connectors. The compound contributes to the overall performance of the connection.

If removed, the joint compound should be reapplied. A 2-ounce container of compound (Catalog Number PJC-8311) is available.

Electronic Accessories

Many accessories are available that are specific to electronic trip circuit breakers. These devices include rating plugs, trip unit seals, neutral current transformers, electronic trip indicators, electronic circuit breaker test equipment.

Rating Plugs

Rating plugs are used on full-function electronic trip circuit breakers to establish the circuit breaker's maximum continuous current rating. The rating plug varies the circuit breaker's continuous current rating as a function of the circuit breaker sensor size. Rating plugs are factory installed in full-function circuit breakers and are also available in field-installable kits.

Interchangeable Rating Plug Kits

Catalog Number	Multiplier
ARP040	0.400
ARP050	0.500
ARP056	0.563
ARP058	0.583
ARP060	0.600
ARP063	0.625
ARP067	0.667
ARP070	0.700
ARP075	0.750
ARP080	0.800
ARP083	0.833
ARP088	0.875
ARP090	0.900
ARP100	1.000

Trip Unit Seals

Trip unit seals are available for electronic trip insulated case circuit breakers and limit access to the tripping characteristics adjustment switches.

Trip unit seals (Catalog Number TUSEAL) are provided in quantities of 100 per box.

Neutral Current Transformers

Current transformers are available for applications requiring ground-fault protection on three-phase, four-wire systems.

Neutral current transformers are not required on non-ground fault circuit breakers, or on three-phase, three-wire systems.

Field-installable Neutral Current Transformers Selection Data

Catalog Number	Sensor	Where Used
SE04NCT	400	SE, SEH
SE12NCT	800	SE, SEH
SE12NCT	1200	SE, SEH
SE30NCT	1600	SE, SEH
SE30NCT	2000	SE, SEH
SE30NCT	2500	SE, SEH
SE30NCT	3000	SE, SEH
SE40NCT	4000	SE, SEH

Local Ammeter/Trip Indicator

The local ammeter/trip indicator is a standard feature on SE insulated case circuit breakers and is field replaceable. This device functions as a 2% accurate ammeter under normal conditions (when the current level reaches 20% of the circuit breaker ampere rating) and as a trip indicator after the circuit breaker trips. The ammeter does not display at the same time as the trip indicator. The LCD trip indicator continues to display until the trip indicator is reset. No external power source is needed for this device.

The ammeter displays rms current in phases A, B and C, and the inherent system ground-fault leakage current. Each of these values can be viewed one at a time using the Phase Select/Indicator Reset button. A bar graph is provided indicating the level of the operating current as a function of the circuit breaker's ampere rating.



Ammeter/Trip Indicator

The ammeter/trip indicator is a separate module that plugs into a port on the trip unit face. This device can be removed without tripping the circuit breaker or exposing energized parts.

The local ammeters can be ordered using Catalog Number ALAM.



Restraint Interface Module

The restraint interface module, Catalog Number RIM32, is required for zone-selective interlocking when

- the distance between any two circuit breakers in the restraint system exceeds 1000 ft (305 mm) and/or
- trip units of the circuit breakers and/or ground-fault modules to be interlocked are not the same series.



RIM Module

Universal Test Set

The Universal Test Set, Catalog Number UTS3, is available to test Square D circuit breakers with MICROLOGIC trip units. It runs trip unit tests automatically or manually with prompts to the user for initial information. Testing can be done with the circuit breaker installed in the switchboard, following the directions shipped with the test set.

A test module stores data necessary for automatic tests for each frame, MICROLOGIC Series 3B trip units require test module CBTMB, which is included with the Universal Test Set. If an older Universal Test Set is used that does not contain a CBTMB test module, a CBTMB test module must be obtained.



Universal Test Set

Communications Adapter

The field-installable communications adapter, Catalog Number CIM3F, allows a full-function circuit breaker trip unit to communicate with a Square D POWERLOGIC Communications Network. This allows full-function circuit breakers to be networked in a POWERLOGIC system. The communications adapter cannot be used with standard function circuit breakers.

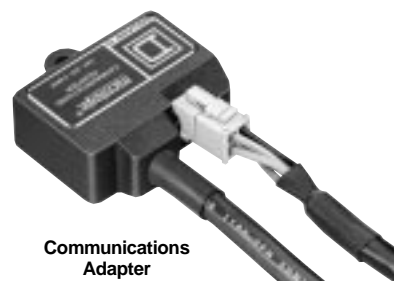

Communications Adapter

SE Field-replaceable Accessory Kits

SE insulated case circuit breakers with integral ground-fault protection or existing electrical accessories are configured to accept field replaceable accessories. The spring charging motor and shunt close device are factory installed on the circuit breaker, and cannot be added in the field.

Note: SE circuit breakers not meeting this criteria will not accept any field-installed electrical accessories.

Contact the local Square D Sales Office for more information on field accessibility and replacement.

Spring Charging Motor

A spring charging motor charges the closing springs of the stored energy mechanism. A manual charging handle is provided should manual charging be necessary.

The spring charging operation, which takes approximately seven seconds, is initiated automatically when the closing springs are discharged and power is supplied to the spring charging motor. When the springs are completely charged, the motor is disconnected and CHARGED appears in the window of the closing springs indicator.

When the closing springs have been charged, they can only be discharged by closing the circuit breaker contacts with the Push-To-Close button or a shunt (remote) close device. The closing springs cannot be discharged without closing the circuit breaker contacts.

The spring charging motor is factory installed on the circuit breaker, and cannot be added in the field.

Note: The spring charging motor is field replaceable by qualified personnel only.



Accessories

The factory-installed device combinations are shown in the following tables.

Spring Charging Field-replaceable Accessory Kits

Catalog Number Suffix	Accessory Kit Number	Motor Rating	
		Voltage	Amperage
ES1, EV1	S3MOT120AC2	120 Vac	1.00
ES2	S3MOT024DC2	24 Vdc	2.75
ES3	S3MOT048DC2	48 Vdc	2.75
ES4	S3MOT125DC2	125 Vdc	2.75

Factory-installed Suffixes For Electrical Operation

Devices	Control Voltages			
	120 Vac	24 Vdc	48 Vdc	125 Vdc
Shunt Trip	S1	S2	S3	S4
Spring Charging Motor and Shunt Close with Shunt Trip	ES1	ES2	ES3	ES4
Undervoltage Release	V1
Spring Charging Motor and Shunt Close with Undervoltage Trip	EV1

Factory-installed Suffixes For Accessory Combinations: Undervoltage Trip (120 Vac Only) Spring Charging Motor, Shunt Close and Shunt Trip

Spring Charging Motor and Shunt Close Control Voltage	Shunt Trip Control Voltage			
	120 Vac	24 Vdc	48 Vdc	125 Vdc
120 Vac	ET1	ES8★†
	...	ES5★	ES6★	ES7★
24 Vdc	...	ET2
48 Vdc	...	ES9	ET3	...
125 Vdc	ET4
120 Vac	...	ET5
120 Vac	ET6	...
120 Vac	ET7
None Included (S/T & UVR Only)	T1	T2	T3	T4

★ Does not include undervoltage trip accessory.
† 24 Vdc shunt close.

The minimum size control power transformer required for each spring charging motor, shunt trip, shunt close or undervoltage trip is as follows:

For circuit breakers without electrical accessories 150 VA but with the ground-fault option.

For circuit breakers with electrical accessories, with 500 VA or without the ground-fault option.

For two or three circuit breaker throw-over systems. 1000 VA

Shunt (Remote) Close Replacement Kit

The shunt close device closes the circuit breaker contacts from a remote location.

This device is activated by a switch, pushbutton or a control relay in the same way as a shunt trip device. The shunt close mechanism also includes a coil clearing switch that automatically disconnects power to the shunt close coil when the circuit breaker contacts have closed.

Field-replaceable Accessory Kits

Description		Field-replaceable Kit Catalog Number
Shunt Close Replacement Kit	120 Vac	S3SC120AC2
	24 Vdc	S3SC024DC2
	48 Vdc	S3SC048DC2
	125 Vdc	S3SC125DC2

Shunt Trip Replacement Kit

The shunt trip device opens the circuit breaker contacts from a remote location.

Field-replaceable Accessory Kits

Description		Field-replaceable Kit Catalog Number
Shunt Trip Replacement Kit	120 Vac	S3ST120AC2
	24 Vdc	S3ST024DC2
	48 Vdc	S3ST048DC2
	125 Vdc	S3ST125DC2

Undervoltage Trip Replacement Kit

When the monitored voltage drops below 35% to 70% of nominal voltage, the undervoltage trip device opens the circuit breaker. The undervoltage trip holds the circuit breaker contacts open until the supply voltage rises above 85% (+5%) of nominal voltage.

The undervoltage trip has an integral adjustable time delay feature. The time delay adjustment is located on the undervoltage trip unit and can be adjusted with a screwdriver. The time delay is adjustable from 0.1 to 1 seconds.

Field-replaceable Accessory Kits

Description		Field-replaceable Kit Catalog Number
Undervoltage Trip Replacement Kit	120 Vac	S3UVR120AC2

A Class 8430 phase failure relay used with a circuit breaker with an undervoltage trip provides undervoltage protection on all three phases.

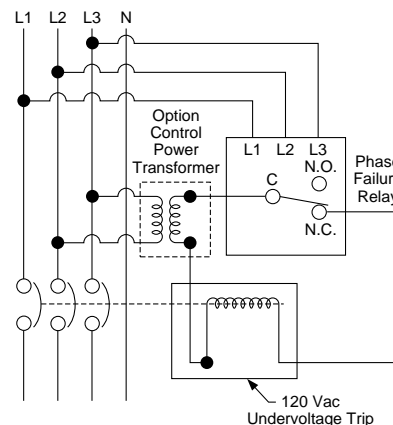

Note: For supply voltages other than 120 Vac, a control power transformer must be used to power up the 120 Vac undervoltage trip.

Undervoltage Trip/Phase Failure Relay Wiring Diagram



Auxiliary Switch Replacement Kit

Auxiliary switches are used with control circuits and indicator lights to provide remote indication of the circuit breaker contact status (i.e., open or closed).

Auxiliary switches have one “A” contact and one “B” contact. The “A” contact is open when the circuit breaker contacts are open and closed when the circuit breaker contacts are closed. The “B” contact is closed when the circuit breaker contacts are open and open when the circuit breaker contacts are closed. Auxiliary switches can be reconfigured in the field to combinations of A and B contacts. See instruction manual, *Field-replaceable Accessories For SE Electronic Trip Circuit Breakers* for details.

Auxiliary Switch Ratings

AC/DC Auxiliary Switches

SWITCH RATINGS:

(1 ampere minimum)

10 A 120 Vac 50/60 Hz

10 A 125 Vdc

1/4 hp 120 Vac 50/60 Hz

1/4 hp 125 Vdc

AC Auxiliary Switches

SWITCH RATINGS:

(0.04 A Minimum)

10 A 120 Vac 50/60 Hz

1/4 hp 120 Vac 50/60 Hz

Auxiliary Switch Accessory Kits

Description		Field-replaceable Kit Catalog Number
Auxiliary Switch Replacement Kit	4 ac/dc 4 ac/dc add on 4 ac only 8 ac only	S34DCB2 S34DCT2 S34AC2 S38AC2

Factory-installed auxiliary switches are provided with a bell alarm. Factory-installed auxiliary switches and alarm switches are not sold separately.

The available factory-installed auxiliary and alarm switch combinations are shown in the table below.

Factory-installed Auxiliary/Alarm Switch Combinations

Auxiliary Switches with Bell Alarms	AC Rated Auxiliary Switches	AC/DC Rated Switches
2A2B with 1 NO/NC 2 NO 2 NC	A4 B4 C4	D4 E4 F4
4A4B with 1 NO/NC 2 NO 2 NC	A8 B8 C8	D8 E8 F8

Alarm Switch Replacement Kit

An alarm switch is used with control circuits and indicator lights to show that the circuit breaker contacts have been opened because of any automatic tripping action or an undervoltage trip. Opening the circuit breaker manually (pressing the Push-To-Open button) or a shunt trip will not activate the alarm.

Alarm Switch Accessory Kit

Description		Field-replaceable Kit Catalog Number
Alarm Switch Replacement Kit	2 ac only	S3AS2

Alarm switch replacement kits (Catalog Number S3AS2) have one A and one B alarm switch per kit. Alarm switches (used on the SE circuit breaker only) can be reconfigured in the field to combinations of A and B contacts. See instruction manual, *Field-replaceable Accessories For SE Electronic Trip Circuit Breakers* for details.

Alarm Switch Ratings

(0.04 A minimum)

10 A, 120/240 Vac, 50/60 Hz

1/4 hp, 120 Vac, 50/60 Hz

Push-To-Open Padlock Attachment

The padlock attachment (Catalog Number SE2PA) permits the padlocking of the SE circuit breaker in the OPEN position. This attachment is available as a field installable accessory only.

The SE padlock attachment holds the Push-To-Open button in the depressed position and prevents the SE circuit breaker from being closed. This attachment accepts up to three 3/8 inch diameter shackle padlocks.

Close Button Cover

The close button cover (Catalog Number SE1CBC) is used to inhibit manual closing of SE circuit breakers. This attachment is available as a field installable accessory only.

The close button cover is mounted directly to the SE circuit breaker face, over the Push-To-Close button. In an emergency situation the circuit breaker can be closed by inserting a small screwdriver through the hole in the close button cover and pushing the button with the screwdriver.

Primary Injection Test Plug

The primary injection test plug (Catalog Number SEPITK2) is used with Series 2, 3, 3A, and 3B circuit breakers in primary injection testing on drawout SE insulated case circuit breakers with integral ground-fault protection. This device is available as a field-installable accessory only.

SED insulated case circuit breakers with the internal ground-fault protection feature must have certain terminals jumpered (or wired) to connect the secondary sensing wiring. The primary injection test plug makes it easier to complete these connections.



SE Drawout Crank

The drawout crank (Catalog Number SEDC) operates an SE circuit breaker drawout mechanism. It is required to rack an SED or an SEM into or out of the drawout cell.

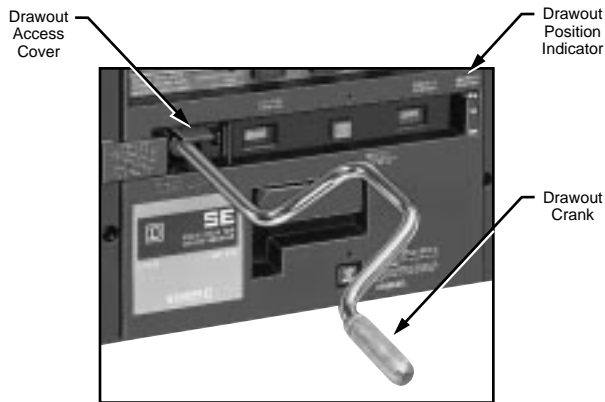

SE Circuit Breaker with Drawout Crank

Interlocks

The SE insulated case circuit breaker has mechanical interlocks to deter incorrect operation. Interlocks minimize the possibility of contact with energized parts or exposure to a hazardous condition. The interlock features are described below.

Key Interlocks (Optional)



SEF Circuit Breaker with Key Interlock

Key interlocks mechanically interlock the operation of the circuit breaker (FOR SEF CIRCUIT BREAKER ONLY) with the operation of other keyed devices.

Note: Key interlock devices are not supplied by Square D and must be ordered separately.

A bracket must be used to mount a key interlock device on an SE circuit breaker. Key interlock mounting brackets (Catalog Number SE1KI) are available as field-installable accessories when used on fixed mounted SE circuit breakers. On drawout SE circuit breakers, the mounting

bracket must be ordered as a part of the carriage assembly and is not field installable on the drawout carriage.

Undervoltage/Close Button Interlock

This optional accessory prevents the closing of the circuit breaker's contacts during a low-voltage condition. The undervoltage/close button interlock mechanically interferes with the operation of the Push-To-Close button. If an undervoltage trip accessory is installed in the circuit breaker, it must be energized before the circuit breaker can be closed either manually or electrically.

This interlock is a function of the undervoltage trip device. This is a field-replaceable accessory.

If the undervoltage trip has been factory installed, it can be changed in the field.

The undervoltage trip must be electrically energized prior to closing the circuit breaker contacts. An attempt to close the circuit breaker electrically without energizing the undervoltage trip opens the fuse on the shunt close. Consult the circuit breaker instruction manual (48040-495) for specifications of replacement fuses.

Contact your local Square D Sales Office or the Square D Field Services Division for more information on field accessibility and replaceability.

Auxiliary Cover Interlock

All SE insulated case circuit breakers have an auxiliary cover that restricts access to any internally-mounted accessories. The auxiliary cover interlock prevents the removal of the auxiliary cover when the circuit breaker contacts are closed, or when the drawout mechanism is in any but the disconnected position.

The auxiliary cover is held in place by retaining screws. If it is not properly installed, the auxiliary cover interlock will prevent the circuit breaker from being closed.

Trip Unit Interlock

If the electronic trip unit is removed, the trip unit interlock prevents the circuit breaker from being closed. During certain auxiliary device replacement procedures (such as auxiliary switch replacement) the trip unit must be removed. The interlock accessory verifies that the trip unit has been correctly reinstalled.

Cell Door Interlock

The cell door interlock minimizes the possibility of contact with energized parts or exposure to hazardous conditions.



Access Cover Interlock

Drawout SE insulated case circuit breakers have a sliding cover that permits (or restricts) access to the drawout racking mechanism.

Note: This device is factory installed and is not field replaceable.



SE Circuit Breaker with Drawout Access Cover

The access cover interlock prevents the following:

1. Closing the circuit breaker contacts while the access cover is open.
2. Opening the access cover while the circuit breaker contacts are closed. In this case, the circuit breaker trips and opens the access cover.

The drawout access cover is held open if the circuit breaker drawout mechanism is between the connected and test/disconnected positions.

Drawout Mechanism Lockout

This accessory prevents access to the drawout mechanism. This device accepts up to three padlocks with a maximum shackle diameter of 3/8 inch.

The drawout mechanism lockout can be used to lock the circuit breaker in the connected or test position. It can also prevent the circuit breaker from being closed by holding the drawout access cover open.



Padlocked Drawout Mechanism

Drawout Carriage Padlock Hasp



Padlocked Drawout Carriage Hasp

This accessory, used with a padlock, prevents a drawout circuit breaker from being connected in a drawout cell. A padlock installed on the padlock hasp interferes with the movement of the circuit breaker on the carriage rails.

OEM Drawout Carriage Assemblies

The drawout carriage assembly contains the hardware necessary to mount an SE insulated case circuit breaker in a piece of OEM end-use equipment. The assembly includes drawout rails, a secondary connector on the end of a 96-inch cord and terminal blocks for user secondary wiring.

Note: The drawout carriage assembly can be ordered with provisions to accept a key interlock. The key interlock mounting bracket must be ordered as a part of the OEM carriage assembly and is not field installable on the drawout carriage. Key interlock devices are not supplied by Square D and must be ordered separately.

Drawout Carriage Assemblies

Description	Catalog Number	Control Voltage of Cooling Fan (4000 A Only)
96 in Umbilical Cord		
2000 Ampere	SE3CR22000	...
2000 Ampere with Key Interlock	SE3CR2K2000	...
3000 Ampere	SE3CR23000	...
3000 Ampere with Key Interlock	SE3CR2K3000	...
4000 Ampere	SE3CR240001	120/208 V
4000 Ampere with Key Interlock	SE3CR2K40001	120/208 V
4000 Ampere	SE3CR240002	240 V
4000 Ampere with Key Interlock	SE3CR2K40002	240 V
4000 Ampere	SE3CR240003	480 V
4000 Ampere with Key Interlock	SE3CR2K40003	480 V
4000 Ampere	SE3CR240004	600 V
4000 Ampere with Key Interlock	SE3CR2K40004	600 V

Fan cooling system provided as standard with circuit breaker (to be mounted in 4000 A cradle only).

SE 4000 A Circuit Breaker Cooling Fan

This accessory is a feature of the 4000 A drawout SE insulated case circuit breaker. It produces air flow around the circuit breaker and carriage connections as the circuit breaker nears full load. The catalog number for the 4000 A drawout carriage specifies the control voltage of the cooling fan.



Accessories

The fan is automatically turned on as the current passing through the circuit breaker nears 4000 A. A set of thermal limit switches in each pole of the circuit breaker regulate fan operation. The fan cooling circuit contains an integral self-test feature, operated by a Push-To-Test button on the circuit breaker's face.

The SED 4000 A circuit breaker with fan cooling also provides a high temperature backup to protect the circuit breaker from damage due to excessive heat. This system also uses three thermal sensors, one in each pole. If the temperature of any one of the three line terminals reaches the allowable UL material index thermal limits that sensor will open and send a signal to the MICROLOGIC® trip unit to open the circuit breaker. This condition will only occur if the current is over 3500 A and the cooling fan fails to operate.



SE Cooling Fan Push-To-Test Feature

According to the voltage specified by the drawout carriage assembly catalog number, fan control power must be supplied from an additional power source.

Additional interlocks are provided with the SED 4000 ampere breaker and cradle to insure that a lower rated circuit breaker will not operate in a 4000 A compartment. The interlocks also prevent a 4000 A circuit breaker from fitting into a lower rated cradle.



Glossary

accessory (device) = an electrical or mechanical device that performs a secondary or minor function apart from overcurrent protection.

AIC = see AIR

AIR = amps interrupting rating.

alarm switch (bell alarm) = a mechanically-operated switch which indicates when a circuit breaker has tripped due to overcurrent conditions.

ambient temperature rating = the temperature of the air immediately surrounding the circuit breaker which can affect the thermal (overload) tripping characteristics of thermal-magnetic circuit breakers. Electronic trip circuit breakers, however, are insensitive to normal (-20° to 50°C) ambient conditions.

ammeter/trip indicator (local current meter/trip indicator) = a module that mounts directly to the circuit breaker trip unit. The ammeter (current meter) reports rms phase and ground-fault current values as seen by the trip unit. Current values are displayed one phase at a time. The trip indicator displays whether the circuit breaker tripped due to an overload, short-circuit or ground-fault condition.

auxiliary cover = the removable cover on the front of an SE insulated case circuit breaker. The trip unit and all electrical accessories are mounted behind the auxiliary cover.

auxiliary switch = a switch mechanically operated by the main device for signaling, interlocking, or other purposes.

bell alarm = see alarm switch.

branch circuit = the circuit conductor between the final overcurrent device protecting the circuit and the outlet(s).

circuit breaker = a device designed to open and close a circuit by non-automatic means and to open the circuit automatically on an overcurrent without damage to itself when properly applied within its rating.

circuit breaker frame = the circuit breaker housing which contains the current carrying components, the current sensing components, and the tripping and operating mechanism.

coil clearing switch = a mechanically-operated switch in series with the coil of a shunt trip device which breaks the coil current when the circuit breaker opens.

continuous current rating (handle rating) = the designated rms alternating current in amperes which a device or assembly will carry continuously in free air without tripping or exceeding temperature limits.

continuous load = a load where the maximum current on the circuit is expected to continue for three hours or more.

CSA = Canadian Standards Association.

CT = current transformer.

current path (of a circuit breaker) = the current-carrying conductors within a circuit breaker between, and including, line and load terminations.

current transformer (current sensor) (CT) = an instrument to measure current, encircling a conductor carrying the current to be measured or controlled.

drawout mounting circuit breaker = an assembly of a circuit breaker with a supporting structure so constructed that the circuit breaker is supported and can be moved to either the main circuit connected or disconnected position without removing connections or mounting supports.

drawout mechanism = a mechanism which engages the drawout carriage assembly and draws the circuit breaker into or out of the switchboard. The drawout mechanism assembly includes the following components: 1) Drawout mechanism operator shaft 2) Drawout levering device arms 3) Drawout position indicator.

drawout position indicator = an indication means which shows the position of the circuit breaker in the drawout carriage (connected or disconnected.)

drawout shaft cover = a shutter which allows or restricts access to the drawout shaft.

electrical operator (motor operator) = an electrical controlling device which is used to open and close a circuit breaker or switch and reset a circuit breaker.

electronic trip circuit breaker = a circuit breaker which uses current sensors and electronic circuitry to sense, measure and respond to current levels.

fixed mounting = a circuit breaker mounted such that it cannot be removed without removing primary and sometimes secondary connections or mounting supports.

frame size = a group of circuit breakers of similar physical configuration. Frame size is expressed in amperes, corresponding to the largest ampere rating available in the group.

frequency = the number of cycles per second for an alternating current system.

frequency rating = the range of frequencies within which a product can be applied.

ground fault = an unintentional current path, through ground, back to the source.

ground-fault delay = the length of time the circuit breaker trip unit will delay before initiating a trip signal to the circuit breaker after a ground fault has been detected.

ground-fault pickup = the level of ground-fault current at which the trip system begins timing.

IEC = International Electrotechnical Commission.

IEEE = Institute of Electrical and Electronics Engineers.



Glossary

instantaneous pickup = the current level at which the circuit breaker will trip with no intentional time delay.

instantaneous trip = (as applied to circuit breakers) a qualifying term indicating that no delay is purposely introduced in the tripping action of the circuit breaker during short-circuit conditions.

insulated case circuit breaker = a term to describe UL Standard 489 Listed non-fused molded case circuit breakers which utilize a two-step, stored energy mechanism, and an electronic trip system.

integral ground-fault protection = equipment ground-fault protection on grounded neutral systems provided by components internal to the circuit breaker.

interchangeable trip unit = a trip unit which can be interchanged by a user among circuit breaker frames of the same design.

interrupting rating = the highest current at rated voltage available at the incoming terminals of the circuit breaker. When the circuit breaker can be used at more than one voltage, the interrupting rating will be shown on the circuit breaker for each voltage level. The interrupting rating of a circuit breaker must be equal to or greater than the available short-circuit current at the point at which the circuit breaker is applied to the system.

inverse time = a qualifying term indicating there is purposely introduced a delay in the tripping action of the circuit breaker, which delay decreases as the magnitude of the current increases.

I²t = let-through.

I²t IN = an inverse time delay characteristic.

I²t OUT = a constant time delay characteristic.

let-through (I²t) = an expression related to energy (measured in ampere-squared seconds) which passes through an overcurrent protective device during an interruption.

levering device arm = an arm which engages a slot in the drawout carriage assembly and which, when rotated, draws the circuit breaker into or out of the switchboard.

LI (dual trip device) = a combination of adjustable trip functions including long-time ampere rating, long-time delay, and instantaneous pickup.

LIG (dual with ground trip device) = a combination of adjustable trip functions including long-time ampere rating, long-time delay, instantaneous pickup, ground-fault pickup and ground-fault delay.

local current meter = ammeter/trip indicator.

long-time ampere rating = an adjustment which, in combination with the installed rating plug, establishes the continuous current rating of an electronic trip circuit breaker.

long-time delay = the length of time the circuit breaker will

carry a sustained overload (greater than the long-time pickup) before initiating a trip signal.

long-time pickup = the current level at which the circuit breaker long-time delay function begins timing.

LS (LSI) = a combination of adjustable trip functions including long-time ampere rating, long-time delay, short-time pickup, short-time delay and a defeatable instantaneous pickup.

LSG (LSIG) = a combination of adjustable trip functions including long-time ampere rating, long-time delay, short-time pickup, short-time delay, defeatable instantaneous pickup, ground-fault pickup and ground-fault delay.

MICROLOGIC = the Square D family of electronic trip systems available on molded case circuit breakers, insulated case circuit breakers and low-voltage power circuit breakers.

molded case circuit breakers = a circuit breaker which is assembled as an integral unit in a supportive and enclosed housing of insulating material.

neutral current transformer = a current transformer which encircles the neutral conductor; required for use with circuit breakers with integral ground-fault protection, when applied on a grounded system.

operating mechanism = an internal mechanical system which opens and closes the circuit breaker contacts.

overcurrent = any current in excess of the rated continuous current of electrical equipment or the ampacity of a conductor.

overcurrent trip element = a device that detects an overcurrent and transmits the energy necessary to open the circuit breaker automatically.

overcurrent trip switch = see alarm switch.

overload delay = the length of time the circuit breaker will carry a sustained low-level overcurrent before initiating a trip signal.

peak current sensing = a method of determining the current flowing in a circuit by measuring the peak amplitude of the current wave each half cycle, then calculating the effective rms. (The effective rms value is assumed to equal 0.707 times the measured peak. This results in accurate rms values on pure sinusoidal waveforms *only*.)

peak let-through = the maximum peak current in a circuit during an overcurrent condition.

PUSH-TO-CLOSE button = a button for manually closing the circuit breaker.

PUSH-TO-OPEN button = a button for manually opening the circuit breaker.

rating plug = a component which plugs into the trip unit, establishing the ampere rating of the circuit breaker.



residual sensing = a means of checking for current imbalance by using a current sensor across each current-carrying conductor to check the magnitude of current flowing in each conductor, then summing all current sensors to check for a current imbalance.

restraint interface module (RIM) = a component which allows zone-selective interlocking communication between Square D full-function electronic trip systems, add-on ground-fault modules and zero-sequence ground-fault relays.

RIM = restraint interface module.

rms = root-mean-square.

rms current sensing = a method of determining the true rms current of sinusoidal and non-sinusoidal waveforms by sampling the current waveform a number of times per cycle, then calculating the true rms value. (Square D circuit breakers sample 33 times per cycle.)

root mean square = the square root of the arithmetic mean of the squares of a set of numbers.

sensor = current sensing element within a circuit breaker frame. The sensor has a current rating less than or equal to the frame size and provides the sensing function for a specific group of current ratings within the frame size.

short-time (short-circuit) delay = the length of time the circuit breaker will carry a short circuit (current greater than the short-time pickup) before initiating a trip signal.

short-time (short-circuit) pickup = the current level at which the circuit breaker short-time delay function begins timing.

shunt trip = an accessory which trips the circuit breaker from a remote location using an external voltage source.

STD = short-time delay.

terminal block = the connections for control wiring.

thermal-magnetic circuit breaker = a general purpose term for circuit breakers that use bimetals and electromagnetic assemblies to provide both overload and short-circuit protection.

trip indicator = a module that mounts directly to the circuit breaker trip unit that displays whether the circuit breaker tripped due to an overload, a short-circuit or a ground-fault condition.

trip indicator reset = a button on the trip indicator module used to reset the trip indicator.

trip system = a system which consists of a MICROLOGIC trip unit, current transformers, and trip coil.

trip unit = a programmable microprocessor-based device which measures and times current flowing through the circuit breaker and initiates a trip signal when appropriate.

UL = Underwriters Laboratories Inc.

undervoltage trip (UVR) = an accessory which trips the circuit breaker automatically when the monitored circuit voltage falls below a predetermined percentage of its specified value.

UVR = undervoltage trip release.

withstand rating = the level of rms symmetrical current that a circuit breaker can carry with the contacts in a closed position for a stated period of time (usually described as the number of cycles).

zero-sequence sensing = a means of sensing the current flowing on a circuit by using one current sensor surrounding all current-carrying conductors, then checking for current imbalance in the currents flowing in all directions.

zone-selective interlocking (ZSI) = a communication capability between electronic trip systems and ground-fault relays which permits a short circuit or ground fault to be isolated and cleared by the nearest upstream device with no intentional time delay.

zone-selective interlocking = zone-selective interlocking (ZSI, also called zone restraint) is used to reduce the stress on electrical distribution equipment during fault conditions while maintaining coordination.

ZSI allows electronic trip devices to communicate with each other so that a short circuit or ground fault will be isolated and cleared by the nearest upstream circuit breaker with no intentional time delay. Devices in all other areas of the system (including upstream) remain closed to maintain service to unaffected loads.

ZSI limits faults stress on the power distribution system by reducing the time it takes to clear the fault, while maintaining system coordination between overcurrent protective devices.

ZSI is a standard feature on MICROLOGIC full-function circuit breakers. In order to have a functional ZSI system, Square D electronic trip devices require interconnect wiring between their terminal strips using a twisted pair of #14 or #18 AWG conductors.

For more information on zone-selective interlocking, see Application Guide 0600SC9102R6/95, *Reducing Fault Stress with Zone-selective Interlocking*.

ZSI = zone-selective interlocking.



MICROLOGIC, POWERLOGIC, SQUARE D, and  are
Registered Trademarks of Square D Company.

Order No. 0603CT9201R12/95 Aug 97 FPC Printed in U.S.A.
(Replaces 0603CT9201)



SQUARE D
GROUPE SCHNEIDER

© 1997 Square D All Rights Reserved