

# Terminal Blocks NEMA Type

Class 9080

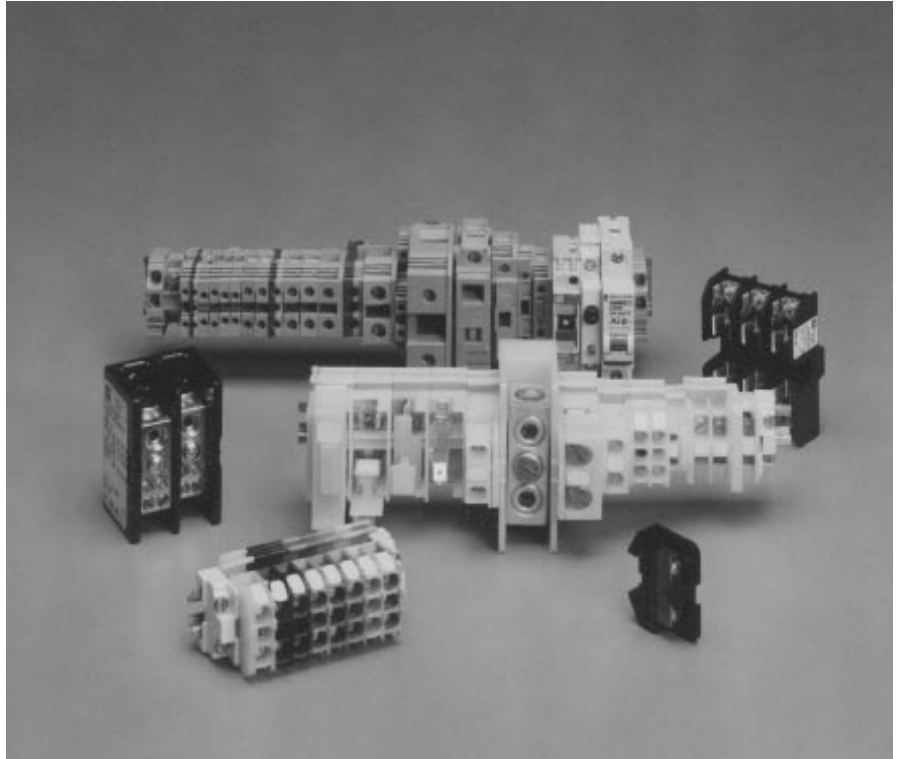

## CATALOG CONTENTS

Description.....	Page
Quick Selector .....	1
Box Lug Termination .....	2-3
Other Terminations .....	4
Other Blocks .....	5
Supplementary Protectors.....	6-7
Mounting Track.....	8
Accessories .....	9
Standard and Custom Assemblies .....	10
Open Style Phenolic Blocks.....	11-13
Accessories .....	14
Approximate Dimensions.....	15-19

# NEMA Type Terminal Blocks



FAMILY	DESCRIPTION
 <p>CLASS 9080 TYPE G (Pages 2-10)</p>	<p style="text-align: center;"><b>NEMA TYPE TERMINAL BLOCKS</b></p> <p>This family of blocks and accessories offers a wide variety of features like DIN 3 track mounting, colored blocks, terminal screws shipped backed out, captive screws and higher density to save you both money and time. This line also includes a direct mount block that can be panel or track mounted. Standard track comes in common lengths and breakoff styles. All blocks are UL component recognized and CSA approved.</p>
 <p>CLASS 9080 TYPE M</p>	<p style="text-align: center;"><b>IEC TYPE TERMINAL BLOCKS</b></p> <p>This family of blocks and accessories is accepted around the world. These blocks mount on 35mm (DIN 3) track, making it convenient when other IEC type products are being used in a control panel. Blocks like the grounding block, the thermocouple block, the glass fuse holder and the stripless box lug block make this a very complete line. The newest additions to this family are the 5mm blocks, the miniature blocks and the direct mount blocks. Most blocks are UL component recognized and CSA approved.</p> <p>REFER to Catalog 9080CT9602.</p>
 <p>CLASS 9080 TYPE FB</p>	<p style="text-align: center;"><b>FUSE HOLDERS</b></p> <p>This family of fuse holders will accept Types H, R, CC, M and J fuses up to 200 amperes. Both 250 V and 600 V versions are available. All Class H, R and J fuses are supplied as standard with reinforced fuse clips to provide long reliable service. All fuse holders are UL Listed and CSA approved.</p> <p>REFER to Catalog 9080CT9603.</p>
 <p>CLASS 9080 TYPE LB</p>	<p style="text-align: center;"><b>POWER DISTRIBUTION BLOCKS</b></p> <p>These power distribution and splicer blocks are available in one, two and three pole versions, with either aluminum or copper lugs, which are available in a wide variety of sizes. Whatever your application is, this family should have a block to meet your needs. A wide selection of covers makes this family complete. All these power distribution blocks are UL component recognized and CSA approved.</p> <p>REFER to Catalog 9080CT9603.</p>
 <p>CLASS 9080 TYPE K (Pages 11-14)</p>	<p style="text-align: center;"><b>OPEN STYLE NEMA TYPE TERMINAL BLOCKS</b></p> <p>These blocks are ideal for those applications with high ambient temperatures or where it is desirable to have easy accessibility to the lugs. Some of the blocks are UL component recognized and CSA approved.</p>
 <p>CLASS 9080 TYPE GCB GB2 (Pages 6-7)</p>	<p style="text-align: center;"><b>CIRCUIT PROTECTORS</b></p> <p>There are two families of circuit protectors. One will be right for your application. The Class 9080 Type GCB thermal magnetic product is available from 0.1 amp through 15 amp and offers high density. The Telemecanique GB2 thermal magnetic product is available from 0.5 amp through 12 amp and is available world wide.</p>
<p>(Pages 15-19)</p>	<p style="text-align: center;">DIMENSIONS</p>





# NEMA Type Terminal Blocks Quick Selector

All Square D terminal blocks are:

- 600V rated (except the 9080 GT6 transient voltage suppressor, which is 120V)
- Track mountable (an exception is the 9080GK6, which can be either directly mounted to a panel or on a track)

Termination	Box Lug										
Block Material	Nylon							Phenolic			
Wire Range	#10 - #22	#8 - #22	#8 - #22	#10 - #22	#4 - #18	1/0 - #12	250 kcmil - #6	#8 - #18	#4 - #14	1/0 - #10	
Maximum Amperage*	UL	30	60	60	70	110	180	255	35	70	150
	CSA	30	60	60	40	85	170	280	35	70	150
Sections per foot	51	34	34	34	28	17	10	28	19	16	
Temperature Rating	-40 to 257°F -40 to 125°C							-40 to 300°F -40 to 150°C			
Flammability Rating	UL94V2							UL94V-0			
Listings	 File E60616 Guide XCFR2							 File LR62144 Class 6228 01			-
Catalog Number	GM6	GR6	GR6T	GK6	GC6	GD6	GE6	KCA1	KD1	KE1	
Page	2	2	2	3	3	3	3	11	12	12	





\* These maximum current values assume the use of insulated copper conductors with 75° C temperature rating, and are calculated based on NEC Article 310, Table 310-16. In most cases this value is the maximum ampacity of that wire or combination of wires (as listed in the above table) which has the greatest current carrying capacity. The actual allowable current for a particular application is dependent upon the number, size, insulation class and other characteristics of the wires used.

Termination	Flat Screw	Pressure Wire	Slip-On	Fuse Block	Circuit Isolating Switch	Transient Voltage Suppressor	Flat Screw	Pressure Wire	Tin Plated Screw	Fuse Block	Slip-On	Slip-On/Pressure Wire	Circuit Isolating Switch	
Block Material	Nylon						Phenolic							
Wire Range	#12 - #22	#12 - #18	#12 - #22	#10 - #18	#10 - #18	#10 - #18	#10 - #22	#10 - #22	#10 - #22	#10 - #22	#14 - #18	#10 - #22	#10 - #22	
Maximum Amperage	UL	40	40	20	30	30	NA	30	25	30	30	15	30	30
	CSA	40	40	20	30	30	NA	30	25					
Sections per foot	32	32	16	16	16	24	19	19	19	16	19	19	16	
Temperature Rating	-40 to 257°F -40 to 125°C						-40 to 300°F -40 to 150°C							
Flammability Rating	UL94V2						UL94V-0							
Listings	 File E60616 Guide XCFR2						 File LR62144 Class 6228 01				-			
Catalog Number	GA6	GP6	GS6	GF6	GG6	GT6	KCB1	KC1	KCBT1	KH1	KCS1	KCPS1	KS1	
Page	4	4	4	5	5	5	11	11	13	12	13	13	13	



# NEMA Type Terminal Blocks

## Box Lug Termination





CLASS 9080		TYPE GM6	TYPE GR6	TYPE GR6T
		 High Density Block	 Without Test Probe Adapter	 With Test Probe Adapter
Maximum Voltage Rating		600	600	600
Maximum Amperage Ratingv *	UL	30	60	60
	CSA	30	60	60
Wire Range		#22 to #10 AWG	#22 to #8 AWG	#22 to #8 AWG
Maximum Wire Combination		1 - #10                      1 or 2 - #18 1 - #12                      1 to 5 - #20 1 - #14                      1 to 8 - #22 1 or 2 - #16	1 - #8                              1 to 4 - #16 1 - #10                            1 to 5 - #18 1 to 3 - #12                      1 to 8 - #20 1 to 4 - #14                      1 to 10 - #22	1 - #8                              1 to 4 - #16 1 - #10                            1 to 5 - #18 1 to 3 - #12                      1 to 8 - #20 1 to 4 - #14                      1 to 10 - #22
Wire Type		Solid or Stranded Copper Wire	Solid or Stranded Copper Wire	Solid or Stranded Copper Wire
Density - Sections per foot		51	34	34
Approx. Dimensions (D)x(H)x(W)		1.72 x 1.82 x .235 inches 44 x 46 x 6 mm	1.72 x 1.82 x .35 inches 44 x 46 x 9 mm	1.72 x 1.82 x .35 inches 44 x 46 x 9 mm
Block Material		Nylon		
Busbar Material		Tin Plated Brass	N/A	N/A
Screw Material		Steel with Zinc Plating and Chromate Film		
Box Lug Material		Zinc Plated Steel	Copper	
Temperature Rating		-40 to 257° F -40 to 125° C	-40 to 257° F -40 to 125° C	-40 to 257° F -40 to 125° C
Flammability Rating		UL94V2	UL94V2	UL94V2
Recommended Screw Tightening Torque		7-8 lbf-in 0.8-0.9 N-m	18-20 lbf-in 2.1-2.3 N-m	18-20 lbf-in 2.1-2.3 N-m
Listings		 File E60616    Guide XCFR2	 File LR62144    Class 6228 01	
FINGERSAFE® per DIN 57470		YES	YES	YES
Block: Natural (White)		GM6	GR6	GR6T
Black		GMB6	GRB6	
Blue		GML6	GRL6	
Green		GMG6	GRG6	
Grey		GME6	GRE6	
Orange		GMS6	GRS6	
Red		GMR6	GRR6	
Yellow		GMY6	GRY6	
End Barrier		GM6B	GM6B	GM6B
6 Foot Assembly		GM6296BC	GR6204BC	
Mounting Track: ▲				
DIN 3 :	0.5 meter long	MH320	MH320	MH320
	1.0 meter long	MH339	MH339	MH339
	2.0 meter long	MH379	MH379	MH379
Standard:	3 Foot Long	GH136	GH136	GH136
Snap-Off:	3 Foot Long	GH236	GH236	GH236
High Rise:	3 Foot Long	GH336	GH336	GH336
End Clamps:	Screw-in	GH10	GH10	GH10
	Slip-in	GH11	GH11	GH11
	DIN 3 End Clamp	MHA10	MHA10	MHA10
Jumpers: 2 pole		GH700	GH72	GH72
	6 pole	GH710	GH73	GH73
Fanning Strip		GH52	GH52	
Cover		GH62	GH62	
Vinyl Marking Strip		GH220	GH220	
Sheets of Blank Marking Tabs		GH200	GH200	
Sheets of Marked Tabs		GH210	GH210	
Marking Strip End Plug		GH60	GH60	

▲ For additional mounting track, see page 8.

\* These maximum current values assume the use of insulated copper conductors with 75° C temperature rating, and are calculated based on NEC Article 310, Table 310-16. In most cases this value is the maximum ampacity of that wire or combination of wires (as listed in the above table) which has the greatest current carrying capacity. The actual allowable current for a particular application is dependent upon the number, size, insulation class and other characteristics of the wires used.







# NEMA Type Terminal Blocks Box Lug Termination

TYPE GK6	TYPE GC6	TYPE GD6	TYPE GE6
			
Mounts on Channel or Directly to a Panel			
600	600	600	600
70	110	180	255
40	85	170	280
#22 to #10 AWG	#18 to #4 AWG	#12 to #1/0 AWG	#6 AWG to 250 kcmil
1 - #10            1 or 5 - #18 1 or 2 - #12      1 to 8 - #20 1 or 2 - #14      1 to 10 - #22 1 to 4 - #16	1 - #4                1 or 5 - #12 1 - #6                1 to 6 - #14 1 or 2 - #8          1 to 6 - #16 1 to 4 - #10        1 to 8 - #18	1 - #1/0            1 to 3 - #6 1 - #1                1 to 5 - #8 1 - #2                1 to 6 - #10 1 or 2 - #4          1 to 7 - #12	1 - 250 kcmil      1 - #1/0 1 - #4/0            1 - #1 1 - #3/0            1 - #2 1 - #2/0            1 - #4 or #6
Solid or Stranded Copper Wire	Solid or Stranded Copper Wire	Solid or Stranded Copper Wire	Copper or Aluminum Wire
35	28	17	10
1.40 x 1.39 x .35 inches 36 x 35 x 9 mm	1.99 x 2.13 x .43 inches 50 x 54 x 11 mm	2.12 x 2.71 x .70 inches 54 x 69 x 18 mm	3.32 x 2.34 x 1.17 inches 84 x 59 x 30 mm
Nylon			
N/A	Tin Plated Brass	Tin Plated Copper	N/A
Steel with Zinc Plating and Chromate Film			Aluminum with Tin Plating
Copper	Zinc Plated Steel	Tin Plated Steel	Tin Plated Aluminum
-40 to 257° F -40 to 125° C	-40 to 257° F -40 to 125° C	-40 to 257° F -40 to 125° C	-40 to 257° F -40 to 125° C
UL94V2	UL94V2	UL94V2	UL94V2
11-12 lbf-in 1.2-1.4 N-m	32-35 lbf-in 3.6-4.0 N-m	45-50 lbf-in 5.0-5.6 N-m	225-250 lbf-in 25.4-28.2 N-m
 File E60616      Guide XCFR2		 File LR62144      Class 6228 01	
NO	NO	NO	NO
GK6	GC6	GD6	GE6
GKB6			
GKL6			
GKG6			
GKE6			
GKS6			
GKR6			
GKY6			
GK6B	GC6B	GD6B	Not Required
	GC6166BC		
	MH320	MH320	MH320
	MH339	MH339	MH339
	MH379	MH379	MH379
GH136	GH136	GH136	GH136
GH236	GH236	GH236	GH236
GH336	GH336	GH336	GH336
GH10	GH10	GH10	GH10
---	GH11	GH11	---
	MHA10	MHA10	MHA10
GH72	GH74	GH76	Not Available
GH73	GH75	GH77	Not Available
GH52			
GH220	GH220	GH220	GH220
		GH200	
		GH210	
GH60	GH60	GH60	GH60



# NEMA Type Terminal Blocks

## Other Terminations

CLASS 9080		TYPE GA6	TYPE GP6	TYPE GS6
		 Flat Terminal Connectors	 Pressure Wire Connectors	 Slip-on Connectors
Maximum Voltage Rating		600	600	600
Maximum Amperage Rating *	UL	40	40	20
	CSA	40	40	20
Wire Range		#22 to #12 AWG	#18 to #12 AWG	#22 to #12 AWG
Maximum Wire Combination		Ring or Spade Connectors 1 or 2 - #12    1 or 2 - #18 1 or 2 - #14    1 or 2 - #20 1 or 2 - #16    1 or 2 - #22	1 or 2 - #12 1 or 2 - #14 1 or 2 - #16 1 or 2 - #18	.250 x .032" Slip-on Connectors 1 or 2 - #12    1 or 2 - #18 1 or 2 - #14    1 or 2 - #20 1 or 2 - #16    1 or 2 - #22
Wire Type		Solid or Stranded Copper Wire	Solid or Stranded Copper Wire	Solid or Stranded Copper Wire
Density - Sections per foot		32	32	16
Approx. Dimensions (D)x(H)x(W)		1.80 x 1.48 x .37 inches 46 x 38 x 10 mm	1.80 x 1.48 x .37 inches 46 x 38 x 10 mm	2.19 x 1.69 x .75 inches 56 x 43 x 19 mm
Block Material		Nylon		
Busbar Material		Tin Plated Brass		
Screw Material		Steel with Zinc Plating and Chromate Film		N/A
Box Lug Material		N/A	N/A	N/A
Temperature Rating		-40 to 257° F -40 to 125° C	-40 to 257° F -40 to 125° C	-40 to 257° F -40 to 125° C
Flammability Rating		UL94V2	UL94V2	UL94V2
Recommended Screw Tightening Torque		18-20 lbf-in 2.1-2.3 N-m	18-20 lbf-in 2.1-2.3 N-m	N/A
Listings		 File E60616	Guide XCFR2	 File LR62144    Class 6228 01
FINGERSAFE® per DIN 57470		YES	NO	NO
Block: Natural (White)		GA6	GP6	GS6
Black				
Blue				
Green				
Grey				
Orange				
Red				
Yellow				
End Barrier		GP6B	GP6B	GF6B
6 Foot Assembly		GA6188BC	GP6188BC	
Mounting Track: ▲				
DIN 3 :	0.5 meter long	MH320	MH320	MH320
	1.0 meter long	MH339	MH339	MH339
	2.0 meter long	MH379	MH379	MH379
Standard:	3 Foot Long	GH136	GH136	GH136
Snap-Off:	3 Foot Long	GH236	GH236	GH236
High Rise:	3 Foot Long	GH336	GH336	GH336
End Clamps:	Screw-in	GH10	GH10	GH10
	Slip-in	GH11	GH11	GH11
	DIN 3 End Clamp	MHA10	MHA10	MHA10
Jumpers: 2 pole		GH78	GH78	
	6 pole	GH79	GH79	
Fanning Strip		GH51	GH53	
Cover				
Vinyl Marking Strip		GH220	GH220	
Sheets of Blank Marking Tabs				GH200
Sheets of Marked Tabs				GH210
Marking Strip End Plug		GH60	GH60	





▲ For additional mounting track, see page 8.

\* These maximum current values assume the use of insulated copper conductors with 75° C temperature rating, and are calculated based on NEC Article 310, Table 310-16. In most cases this value is the maximum ampacity of that wire or combination of wires (as listed in the above table) which has the greatest current carrying capacity. The actual allowable current for a particular application is dependent upon the number, size, insulation class and other characteristics of the wires used.



# NEMA Type Terminal Blocks

## Other Blocks

CLASS 9080	TYPE GF6	TYPE GG6	TYPE GT6
	 Fuse Block	 Circuit Isolating Switch	 Transient Voltage Suppressor
Maximum Voltage Rating	600	600	120
Maximum Amperage Rating *	UL 30	30	N/A
	CSA 30	30	
Wire Range	#18 to #10 AWG	#18 to #10 AWG	#18 to #10 AWG
Maximum Wire Combination	1 - #10            1 to 4 - #16 1 - #12            1 to 4 - #18 1 - #14	1 - #10            1 to 4 - #16 1 - #12            1 to 4 - #18 1 - #14	1 - #10            1 or 2 - #16 1 - #12            1 to 4 - #18 1 - #14
Wire Type	Solid or Stranded Copper Wire	Solid or Stranded Copper Wire	Solid or Stranded Copper Wire
Density - Sections per foot	16	16	24
Approx. Dimensions (D)x(H)x(W)	2.19 x 2.33 x .75 inches 56 x 59 x 19 mm	2.19 x 2.07 x .76 inches 56 x 53 x 19 mm	2.16 x 2.55 x .50 inches 55 x 65 x 13 mm
Block Material	Nylon		
Busbar Material	Tin Plated Copper		
Screw Material	Steel with Zinc Plating and Chromate		
Box Lug Material	-	-	Copper
Temperature Rating	-40 to 221° F -40 to 105° C	-40 to 257° F -40 to 125° C	-40 to 257° F -40 to 125° C
Flammability Rating	UL94V2	UL94V2	UL94V2
Recommended Screw Tightening Torque	18-20 lbf-in 2.1-2.3 N-m	18-20 lbf-in 2.1-2.3 N-m	18-20 lbf-in 2.1-2.3 N-m
Listings	 File E60616    Guide XCFR2	 File LR62144    Class 6228 01	
FINGERSAFE® per DIN 57470	YES	NO	YES
Block: Natural (White)	GF6	GG6	GT6
Black			
Blue			
Green			
Grey			
Orange			
Red			
Yellow			
End Barrier	GF6B	GF6B	GT6B
6 Foot Assembly	GF694BC		
Mounting Track: ▲			
DIN 3 :    0.5 meter long	MH320	MH320	MH320
1.0 meter long	MH339	MH339	MH339
2.0 meter long	MH379	MH379	MH379
Standard: 3 Foot Long	GH136	GH136	GH136
Snap-Off: 3 Foot Long	GH236	GH236	GH236
High Rise: 3 Foot Long	GH336	GH336	GH336
End Clamps: Screw-in	GH10	GH10	GH10
Slip-in	GH11	GH11	GH11
DIN 3 End Clamp	MHA10	MHA10	MHA10
Blown Fuse Indicator: 120-240 V	GLP3		
Blown Fuse Indicator: 277-600 V	GLP6		
Replacement Fuse Puller	GH63		
Vinyl Marking Strip		GH220	GH220
Sheets of Blank Marking Tabs	GH200	GH200	GH200
Sheets of Marked Tabs	GH210	GH210	GH210
Marking Strip End Plug			GH60

▲ For additional mounting track, see page 8.

\* These maximum current values assume the use of insulated copper conductors with 75° C temperature rating, and are calculated based on NEC Article 310, Table 310-16. In most cases this value is the maximum ampacity of that wire or combination of wires (as listed in the above table) which has the greatest current carrying capacity. The actual allowable current for a particular application is dependent upon the number, size, insulation class and other characteristics of the wires used.



# NEMA Type Terminal Blocks Supplementary Protectors One Pole Thermal-Magnetic Control Circuit Protectors

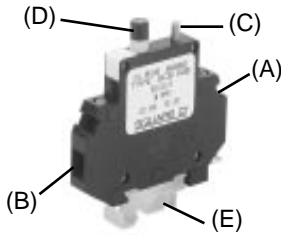

## Single Pole Type GCB Circuit Protector Blocks

- A. Thermal-Magnetic circuit protector
- B. 14 different stock current ratings – 0.1 to 15 Amp
- C. On - Off switch
- D. Visible trip indication
- E. Mounts on Class 9080 Type GH track and on DIN mounting track

The 9080GCB... have solderless box lugs.  
They accept 1 #10 -16 Cu AWG wire.

### Technical Data:

Dielectric Strength	1500 Vac
Insulation Resistance	100 MΩ
Weight	approx. 2.2 oz.
Terminals:	Box lug type
Recommended tightening torque	8-10 lbf-in (0.9 - 1.1 N-m)
Approvals	File E152841 CCN QVNU2 File LR25490 YES



FINGERSAFE® per DIN 57470

## Type GCB Circuit Protector Application Data

### Technical Data:

Maximum voltage rating  
250VAC/65VDC (GCB01 through 70)  
125VAC/65VDC (GCB100 and 150)

Maximum interrupting rating 200 Amperes, but  
not exceeding 10,000% (100 times) rated current

### Selection:

In order to properly select a Class 9080 Type GCB circuit protector, follow the following steps:

1. Determine the inrush correction factor from Table A at right.
2. Determine the temperature correction factor from Table B at right.
3. Determine the sealed current of the load that is being protected.
4. Multiply the sealed current by the two correction factors and choose the closest circuit protector.

**Note:** Choosing a circuit protector with a value lower than the calculated value might cause nuisance tripping, while choosing the larger might provide a protector that will not properly protect the load.

**Example:** Solenoid with sealed current of .75 Amps, an inrush ratio of 1:6 and in an ambient temperature of 85°F.

$$0.75 \times 1.5 \times 1.05 = 1.18$$

Choose the 1.2 Amp protector

The 9080GCB... circuit protectors come standard with the track adapter for mounting on 9080GH track (replacement adapter is 9080GH64). Removal of this adapter permits mounting on 9080MH2xx, MH3xx, and AM1 track. See page 8 for complete listing of available tracks. Use the 9080MH62 (see page 9) mounting adapter for the 9080MH1xx DIN 1 track.

Maximum Current *	Internal Resistance Ω	Maximum Voltage	Single Pole Type	
0.1	133	250VAC 65VDC	GCB01	
0.5	6.6		GCB05	
0.8	2.55		GCB08	
1.0	1.97		GCB10	
1.2	1.22		GCB12	
1.5	.86		GCB15	
2.0	.49		GCB20	
2.5	.31		GCB25	
3.0	.20		GCB30	
4.0	.10		GCB40	
5.0	.08		GCB50	
7.0	.03		GCB70	
10.0	<0.02		125VAC	GCB100
15.0	<0.02		65VDC	GCB150

\* These maximum current values assume the use of insulated copper conductors with 75°C temperature rating, and are calculated based on NEC Article 310, Table 310-16. In most cases this value is the maximum ampacity of that wire or combination of wires (as listed in the above table) which has the greatest current carrying capacity. The actual allowable current for a particular application is dependent upon the number, size, insulation class and other characteristics of the wires used.

**Table A  
Inrush Ration Correction Table**

Inrush Ratio	1:1 to 1:4	1:5	1:6	1:7	1:8
Factor	1.3	1.4	1.5	1.6	1.7

**Table B  
Ambient Temperature Correction Table**

Ambient Temperature	70°F (21.1°C)	100°F (37.8°C)	120°F (48.9°C)	140°F (60°C)	160°F (71.1°C)	180°F (82.2°C)	200°F (93.3°C)
Factor	1.0	1.1	1.2	1.3	1.4	1.5	1.6

### Tripping Time:

Tripping time of the circuit protector is determined from Table C below. Divide the circuit protector value by the temperature correction factor from Table B above to determine actual rated current referenced in Table C.

**Table C  
Tripping times in seconds at 70°F (21.1°C)**

Percent rated current	100%	200%	300%	400%	500%	600%	1000%	2000% and greater
Tripping Time (seconds)	no trip	10-40	38	1.5-9	.8-6	.003-4	.003-2	Max. .02

**Note:** When several protectors are channel mounted adjacent to each other, the "no trip" current will be 80% of rated current at 70°F.





# NEMA Type Terminal Blocks Supplementary Protectors One Pole Thermal-Magnetic Control Circuit Protectors



GB2-CB06

## Specifications

Conformity to standards	UL file # E164873 Guide QVNU2 tested per UL standard 1077 supplemental protectors CSA Class 3215 01 IEC 157-1 VDE 0660
Protective treatment	Tropical climate finish
Enclosure rating	IP 201 conforming to IEC 144 finger safe terminals
Ambient temperature	-4 to 140°F (-20 to 60°C) mounted in open air
Operating position	± 30° from the vertical plane

## Technical characteristics

Rated insulation voltage	300 Vac max								
Thermal ratings	0.5A, 1A, 2A, 3A, 4A, 5A, 6A, 8A, 10A, 12A								
Rating selection according to average ambient temperature Factor	Average ambient temperature in °C								
	-20	-10	0	+10	+20	+30	+40	+50	+60
	1.2	1.15	1.1	1.05	1.0	.95	.90	.85	.80
Breaking capacity	1.5 kA/220V conforming to IEC 157-1 (P1)								
Operating current of magnetic trips	12 to 16 times thermal rating								
Mechanical life	8,000 operations								
Maximum wire sizes	Number of conductors		1		2				
	Standard wire		4mm <sup>2</sup> (12AWG)		1 to 2.5mm <sup>2</sup> (16AWG)				
Recommended tightening torque	11 lbf-in (1.2 N-m)								
Mounting	35 mm Din 3 or Din 1								









Description	Thermal Rating (A)	Standard Pack *	Catalog Number
One pole Thermal Magnetic Control Circuit Protector 	0.5	6	GB2 CB05
	1	6	GB2 CB06
	2	6	GB2 CB07
	3	6	GB2 CB08
	4	6	GB2 CB09
	5	6	GB2 CB10
	6	6	GB2 CB12
	8	6	GB2 CB14
	10	6	GB2 CB16
	12	6	GB2 CB20

Description	Thermal Rating (A)	Standard Pack*	Catalog Number
Two pole Thermal Magnetic Control Circuit Protector 	0.5	6	GB2-CD05
	1	6	GB2-CD06
	2	6	GB2-CD07
	3	6	GB2-CD08
	4	6	GB2-CD09
	5	6	GB2-CD10
	6	6	GB2-CD12
	8	6	GB2-CD14
	10	6	GB2-CD16
	12	6	GB2-CD20

\*Must order in multiples of Standard Pack









# NEMA Type Terminal Blocks Mounting Track



Description	Length – meters (inches)	Catalog Number	
<b>IEC Type Mounting Track:</b>			
DIN 3  AM1-ED200 15 mm depth, 1 mm steel, zinc chromated 	2 m (78.74")	AM1ED200	
DIN 3  AM1-DE200 15 mm depth, 1.5 mm steel, zinc chromated 	2 m (78.74")	AM1DE200	
DIN 3  AM1-DP200 7.5 mm depth, 1 mm steel, zinc chromated 	2 m (78.74")	AM1DP200	
DIN 3    Symmetrical rail 35 x 7.5 mm (1.38" x .295") in compliance with EN 50022 standard (DIN 46277-3). Available in shorter length. Consult with Square D Field Office.	Galvanized steel, (no mounting holes)	0.5 m (19.68")	9080 MH220
	Galvanized steel, prepunched	1 m (39.37")	9080 MH239
	Galvanized steel, prepunched	2 m (78.74")	9080 MH279
	Galvanized steel, prepunched	0.5 m (19.68")	9080 MH320
	Galvanized steel, prepunched	1 m (39.37")	9080 MH339
	Galvanized steel, prepunched	2 m (78.74")	9080 MH379
DIN 1    Asymmetrical 32 mm (1.26") G rail in compliance with EN 50035 standard (DIN 46277-1). Biochromated zinc steel (no mounting holes). Can only be used with GB2 circuit protectors.	Galvanized steel, (no mounting holes)	0.5 m (19.68")	9080 MH120
	Galvanized steel, prepunched	1 m (39.37")	9080 MH139
	Galvanized steel, prepunched	2 m (78.74")	9080 MH179
<b>Nema Type Mounting Track:</b>			
Standard Channel    Made of galvanized steel.  Supplied with prepunched holes to make installation easy.	Galvanized steel, (no mounting holes)	0.08 m (3")	9080 GH103
	Galvanized steel, prepunched	0.10 m (4")	9080 GH104
	Galvanized steel, prepunched	0.13 m (5")	9080 GH105
	Galvanized steel, prepunched	0.15 m (6")	9080 GH106
	Galvanized steel, prepunched	0.18 m (7")	9080 GH107
	Galvanized steel, prepunched	0.20 m (8")	9080 GH108
	Galvanized steel, prepunched	0.23 m (9")	9080 GH109
	Galvanized steel, prepunched	0.25 m (10")	9080 GH110
	Galvanized steel, prepunched	0.28 m (11")	9080 GH111
	Galvanized steel, prepunched	0.30 m (12")	9080 GH112
	Galvanized steel, prepunched	0.33 m (13")	9080 GH113
	Galvanized steel, prepunched	0.36 m (14")	9080 GH114
	Galvanized steel, prepunched	0.38 m (15")	9080 GH115
	Galvanized steel, prepunched	0.41 m (16")	9080 GH116
	Galvanized steel, prepunched	0.43 m (17")	9080 GH117
Galvanized steel, prepunched	0.46 m (18")	9080 GH118	
Galvanized steel, prepunched	0.91 m (36")	9080 GH136	
Galvanized steel, prepunched	1.22 m (48")	9080 GH148	
Galvanized steel, prepunched	1.83 m (72")	9080 GH172	
Snap-Off Channel    Made of galvanized steel with serrated segments, spaced approximately 5/16 inch apart. Supplied with prepunched holes to make installation easy.	Galvanized steel, prepunched	0.91 m (36")	9080 GH236
	Galvanized steel, prepunched	1.22 m (48")	9080 GH248
	Galvanized steel, prepunched	1.83 m (72")	9080 GH272
High Rise Channel    Made of extruded aluminum. Supplied with prepunched holes to make installation easy.	Galvanized steel, prepunched	0.91 m (36")	9080 GH336

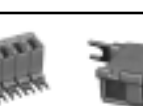

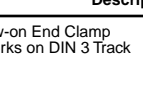
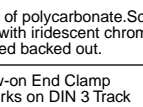
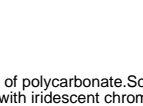



# NEMA Type Terminal Blocks Accessories

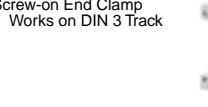





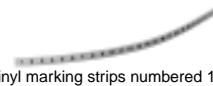

Description	Catalog Number
Jumpers-6 pole jumpers can be snapped off to provide 3, 4 or 5 pole jumpers Material is CDA Alloy 110 Copper	
	2 pole jumper for 9080 GM6 9080 GH700
	6 pole jumper for 9080 GM6 9080 GH710
	2 pole jumper for 9080 GK6, GR6 9080 GH72
	6 pole jumper for 9080 GK6, GR6 9080 GH73
	2 pole jumper for 9080 GC6 9080 GH74
	6 pole jumper for 9080 GC6 9080 GH75
	2 pole jumper for 9080 GD6 9080 GH76
	6 pole jumper for 9080 GD6 9080 GH77
	2 pole jumper for 9080 GA6, GP6 9080 GH78
	6 pole jumper for 9080 GA6, GP6 9080 GH79

### Fanning Strip

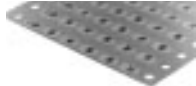
	Snap-together fanning strip section for 9080 GA6.	9080 GH51
	Snap-together fanning strip section for 9080 GK6, GR6	9080 GH52
	Snap-together fanning strip section for 9080 GP6.	9080 GH53

### End Clamps

Description	Type
Screw-on End Clamp Works on DIN 3 Track 	MHA10
Made of polycarbonate.Screws are zinc plated steel with iridescent chromate film. Screws are shipped backed out.	
Screw-on End Clamp Works on DIN 3 Track 	MH10
Made of polycarbonate.Screws are zinc plated steel with iridescent chromate film.	
Screw-on End Clamp for 9080GH Track 	9080 GH10 Not recommended with Snap-off channel.
Made of polycarbonate.Screws are zinc plated steel with iridescent chromate film. Screws are shipped backed out.	
Slip-in End Clamp for 9080GH Track 	9080 GH11 Not to be used with 9080 GE6 or 9080 GK6.
Made of Spring Steel with an iridescent chromate film	

Description	Catalog Number
	25 ft. blank vinyl marking strip 9080 GH220
	For 9080 GK6, GR6 9080 GH21
	For 9080 GA6, GP6 9080 GH22
	For 9080 GM6 9080 GH230
30 adhesive backed strips, 11 in. long 	For 9080 GM6 9080 GH300
	For 9080 GA6, GK6, GP6, GR6 9080 GH31
	For 9080 GC6, GD6 9080 GH32
	Blank pin-feed marking tabs - 6x20 (total 120) marking tabs for 9080 GR6, GD6, AND GT6 9080 GH200
	Pre-marked 2 times 01 to 50 plus 20 various marking tabs (total 120 marking tabs) for 9080 GR6, GD6, AND GT6 9080 GH210
	Marking pen with permanent, fine line black ink 9080 GH40
	Marking strip end plug for 9080 GK6, GR6, GM6, GA6, GP6, GC6, GD6, GE6, GT6 9080 GH60
	Transition barrier between 9080 GK6 and all other G or K sections 9080 GH61
	Cover for 9080 GR6 and 9080 GR6T 9080 GH62
	Banana test plug for 9080 GR6T 9080 GH90
	Test plug adapter for 9080 GR6T (included as standard with 9080 GR6T) 9080 GH91

### Miscellaneous Accessories

Description	Type
Stacking Bridge Kit Includes 2 brackets as shown. 	9080 GH81
Angle Bracket Kit Includes 2 brackets and hardware for mounting track to the brackets. 	9080 MH82
Track adapter to mount 9080 GCB circuit breakers on 9080 MH1XX track or DIN 1 track. 	9080 MH62



# NEMA Type Terminal Blocks Standard and Custom Assemblies

## Standard Terminal Block Assemblies

Standard Terminal Block assemblies consist of 6 feet (two 3 foot lengths packaged together) of various styles of terminal blocks. The terminal blocks are mounted on 3 foot lengths of snap off channel. The snap off channel can be easily broken every 5/16th of an inch to build a terminal block assembly of desired length. By adding an end barrier and slip in end clamps, the terminal block strip is ready for installation. Every tenth terminal block on the standard assembly is marked to aid in the counting off of the number of sections needed.

## Custom Terminal Block Assemblies

Custom Terminal Block Assemblies are also available. You can order an assembly the way you need it. Any style Class 9080 Type G terminal block, on either standard or snap-off channel can be made to order. Other options include blank marking strip, pre-marked marking strip (1 to 25 only), and assemblies of mixed block styles. There are two ways of ordering Class 9080 Type G custom assemblies:

- One terminal block type:** Add to the end of the desired terminal block style the desired number of sections. An assembly of 25 9080GR6's would be 9080GR625. For a direct mount assembly of 9080GK6's, add "D" to the end of the type number, i.e., a direct mount assembly of 25 9080GK6's would be 9080GK625D.
  - To mount the blocks on DIN 3 mounting track, add a "T" to the end of the type number, i.e., 9080GR613T
  - To add blank vinyl marking strip, add "M" to the end of the type number, i.e., 9080GR625M.
  - To add pre-marked (1-25 only) marking strip, add "MPO" to the end of the type number, i.e., 9080GR625MPO.
  - To substitute slip-in end clamps for screw on end clamps, add "C" to the end of the type number, i.e., 9080GR625C.
  - To substitute snap-off channel for standard, add "B" to the end of the type number, i.e., 9080GR625B.

**Note:** The 9080GH10 screw-on end clamp is not recommended for use with snap off channel. It is recommended that the 9080GH11 slip-in end clamp be used with snap-off channel.

- More than one terminal block type in an assembly:** A detailed drawing or sketch of the desired assembly must accompany the order.

**Note:** Unless it is indicated on a drawing or sketch with the order, all assemblies will be assembled on the assembly length's next larger inch increment of standard track.

Description	Type
Assembly of 188 Type GA6	GA6188BC
Assembly of 204 Type GA6	GR6204BC
Assembly of 166 Type GC6	GC6166BC
Assembly of 94 Type GF6	GF694BC
Assembly of 296 Type GM6	GM6296BC
Assembly of 188 Type GP6	GP6188BC

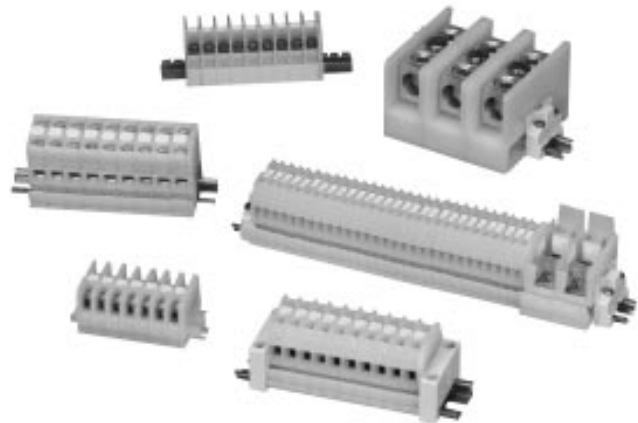

## How to Order:

To Order Specify	Catalog Number	
<ul style="list-style-type: none"> <li>Class Number</li> <li>Type Number</li> </ul>	Class 9080	Type GA612



# NEMA Type Terminal Blocks

## Open Style Phenolic Blocks

CLASS 9080		TYPE KCA1	TYPE KC1	TYPE KCB1
				
		Block Lug Connector	Pressure Wire Connector	Flat Terminal Connector
Maximum Voltage Rating		600	600	600
Maximum Amperage Rating *	UL	35	25	30
	CSA	35	25	30
Wire Range		#18 to #8 AWG	#18 to #8 AWG	#22 to #10 AWG
Maximum Wire Combination		1 - #8                      1 - #16 1 - #10                    1 - #18 1 - #12 1 - #14	1 - #8                      1 - #16 1 - #10                    1 - #18 1 - #12 1 - #14	1 - #10                    1 - #18 1 - #12                    1 - #20 1 - #14                    1 - #22 1 - #16
Wire Type		Solid or Stranded Copper Wire	Solid or Stranded Copper Wire	Solid or Stranded Copper Wire
Density - Sections per foot		28	19	19
Approx. Dimensions (D)x(H)x(W)		1.45 x 1.75 x .42 inches 37.1 x 44.5 x 10.7 mm	1.45 x 1.75 x .63 inches 37.3 x 44.5 x 16.0 mm	1.47 x 1.75 x .63 inches 37.3 x 44.5 x 16.0 mm
Block Material		Phenolic		
Busbar Material		N/A	Cad Plated Steel	Zinc Plated Steel
Screw Material		Steel with Zinc Plating and Chromate		
Box Lug Material		Copper	N/A	N/A
Temperature Rating		-40 to 300° F -40 to 150° C	-40 to 300° F -40 to 150° C	-40 to 300° F -40 to 150° C
Flammability Rating		UL 94 V-O	UL 94 V-O	UL 94 V-O
Recommended Screw Tightening Torque		20 lbf-in 2.3 N-m	20 lbf-in 2.3 N-m	20 lbf-in 2.3 N-m
Listings		 File E60616    Guide XCFR2	 File LR62144    Class 6228 01	
Block:		9080 KCA1	9080 KC1	9080 KCB1
End Barrier		9080 KH21	9080 KH21	9080 KH21
Guide Block		9080 KH24	9080 KH24	9080 KH24
Assemblies:				
5 blocks		9080 CA5	9080 C5	9080 CB5
10 blocks		9080 CA10	9080 C10	9080 CB10
15 blocks		9080 CA15	9080 C15	9080 CB15
Mounting Track: (1)				
Standard: 3 Foot Long (2)		9080 GH136	9080 GH136	9080 GH136
4 Foot Long (2)		9080 GH148	9080 GH148	9080 GH148
6 Foot Long (2)		9080 GH172	9080 GH172	9080 GH172
Snap-Off: 3 Foot Long (2)		9080 GH236	9080 GH236	9080 GH236
4 Foot Long (2)		9080 GH248	9080 GH248	9080 GH248
6 Foot Long (2)		9080 GH272	9080 GH272	9080 GH272
End Clamp		9080 KH20	9080 KH20	9080 KH20
Jumpers: 2 pole		9080 JCA2		
6 pole		9080 JCA6		
Vinyl Marking Strip		9080 MS6	9080 MS6	9080 MS6
Marking Strip End Plug		9080 KH25	9080 KH25	9080 KH25

(1) Additional 9080 GH track can be found on page 8.

(2) When terminal block length exceeds 12 inches, guide blocks (9080KH24) maintain terminal block rigidity.

\* These maximum current values assume the use of insulated copper conductors with 75° C temperature rating, and are calculated based on NEC Article 310, Table 310-16. In most cases this value is the maximum ampacity of that wire or combination of wires (as listed in the above table) which has the greatest current carrying capacity. The actual allowable current for a particular application is dependent upon the number, size, insulation class and other characteristics of the wires used.



# NEMA Type Terminal Blocks

## Open Style Phenolic Blocks

CLASS 9080		TYPE KD1	TYPE KE1	TYPE KH1
		 Block Lug Connector	 Box Lug Connector	 Fuse Holder
Maximum Voltage Rating		600	600	600
Maximum Amperage Rating *	UL	70	150	30
	CSA	70		
Wire Range		#14 to #4 AWG	#10 to 1/0 AWG	#18 to #8 AWG
Maximum Wire Combination		1 - #4                      1 - #12 1 - #6                      1 - #14 1 - #8 1 - #10	1 - 1/0                      1 - #8 1 - #2                      1 - #10 1 - #4 1 - #6	1 - #8                      1 - #16 1 - #10                      1 - #18 1 - #12 1 - #14
Wire Type		Solid or Stranded Copper Wire	Solid or Stranded Copper Wire	Solid or Stranded Copper Wire
Density - Sections per foot		19	16	16
Approx. Dimensions (D)x(H)x(W)		1.47 x 1.75 x .63 inches 37.3 x 44.5 x 16.0 mm	1.66 x 2.84 x .74 inches 42.2 x 72.1 x 18.8 mm	1.66 x 2.84 x .74 inches 42.2 x 72.1 x 18.8 mm
Block Material		Phenolic		
Busbar Material		N/A	N/A	Tin Plated Steel
Screw Material		Steel with Zinc Plating and Chromate Film	Tin Plated Steel	Steel with Zinc Plating and Chromate Film
Box Lug Material		Copper		
Temperature Rating		-40 to 300° F -40 to 150° C	-40 to 300° F -40 to 150° C	-40 to 300° F -40 to 150° C
Flammability Rating		UL 94 V-O	UL 94 V-O	UL 94 V-O
Recommended Screw Tightening Torque		35 lbf-in 3.9 N-m	50 lbf-in 5.6 N-m	20 lbf-in 2.3 N-m
Listings		 File E60616 Guide XCFR2	 File LR62144 Guide 6228 01	-
Block:		9080 KD1	9080 KE1	9080 KH1
End Barrier		9080 KH21	9080 KH22	9080 KH22
Guide Block		9080 KH24	9080 KH24	9080 KH24
Assemblies:				
5 blocks		9080 D5	9080 E5	9080 H5
10 blocks		9080 D10	9080 E10	9080 H10
15 blocks		9080 D15	9080 E15	9080 H15
Mounting Track: (1)				
Standard: 3 Foot Long (2)		9080 GH136	9080 GH136	9080 GH136
4 Foot Long (2)		9080 GH148	9080 GH148	9080 GH148
6 Foot Long (2)		9080 GH172	9080 GH172	9080 GH172
Snap-Off: 3 Foot Long (2)		9080 GH236	9080 GH236	9080 GH236
4 Foot Long (2)		9080 GH248	9080 GH248	9080 GH248
6 Foot Long (2)		9080 GH272	9080 GH272	9080 GH272
End Clamp		9080 KH20	9080 KH20	9080 KH20
Vinyl Marking Strip		9080 MS6	9080 MS6	9080 MS6
Marking Strip End Plug		9080 KH25	9080 KH25	9080 KH26

(1) Additional 9080 GH track can be found on page 8.





(2) When terminal block length exceeds 12 inches, guide blocks (9080 KH24) maintain terminal block rigidity.

\* These maximum current values assume the use of insulated copper conductors with 75° C temperature rating, and are calculated based on NEC Article 310, Table 310-16. In most cases this value is the maximum ampacity of that wire or combination of wires (as listed in the above table) which has the greatest current carrying capacity. The actual allowable current for a particular application is dependent upon the number, size, insulation class and other characteristics of the wires used.



# NEMA Type Terminal Blocks

## Open Style Phenolic Blocks

CLASS 9080	TYPE KCBT1	TYPE KCS1	TYPE KCPS1	TYPE KS1
	 Tin Plated Terminals for Aluminum Wire	 Slip-on Connect Block (3)	 Slip-on Connect/Pressure Wire Connector Block (3)	 Circuit Isolating Switch
Maximum Voltage Rating	600	600	600	600
Maximum Amperage Rating *	30	15	30	30
Wire Range	#22 to #10 AWG	#18 to #14 AWG	#18 to #8 AWG	#18 to #8 AWG
Maximum Wire Combination	1 - #10 1 - #12 1 - #14 1 - #16	1 - #14 1 - #16 1 - #18	1 - #8 1 - #10 1 - #12 1 - #14	1 - #16 1 - #18 1 - #12 1 - #14
Wire Type	Solid or Stranded Copper Wire	Solid or Stranded Copper Wire	Solid or Stranded Copper Wire	Solid or Stranded Copper Wire
Density - Sections per foot	19	19	19	16
Approx. Dimensions (D)x(H)x(W)	1.47 x 1.75 x .63 inches 37.3 x 44.5 x 16.0 mm	1.47 x 1.75 x .63 inches 37.3 x 44.5 x 16.0 mm	1.47 x 1.75 x .63 inches 37.3 x 44.5 x 16.0 mm	2.99 x 2.95 x .74 inches 25.9 x 74.9 x 18.8 mm
Block Material	Phenolic			
Busbar Material	Tin Plated Steel	Cad Plated Steel		Plated Brass
Screw Material	Tin Plated Steel	N/A	Steel with Zinc Plating and Chromate Film	
Temperature Rating	-40 to 300° F -40 to 150° C	-40 to 300° F -40 to 150° C	-40 to 300° F -40 to 150° C	-40 to 300° F -40 to 150° C
Flammability Rating	UL 94 V-O	UL 94 V-O	UL 94 V-O	UL 94 V-O
Recommended Screw Tightening Torque	20 lbf-in 2.3 N-m	N/A	20 lbf-in 2.3 N-m	20 lbf-in 2.3 N-m
Listings	-			
Block:	9080 KCBT1	9080 KCS1	9080 KCPS1	9080 KS1
End Barrier	9080 KH21	9080 KH21	9080 KH21	9080 KH22
Guide Block	9080 KH24	9080 KH24	9080 KH24	9080 KH24
Assemblies:				
5 blocks	9080 CBT5	9080 CS5	9080 CPS5	
10 blocks	9080 CBT10	9080 CS10	9080 CPS10	
15 blocks	9080 CBT15	9080 CS15	9080 CPS15	
20 Blocks	9080 CBT20	9080 CS20	9080 CPS20	
25 Blocks	9080 CBT25	9080 CS25	9080 CPS25	
30 Blocks	9080 CBT30	9080 CS30	9080 CPS30	
Mounting Track: (1)				
Standard: 3 Foot Long (2)	9080 GH136	9080 GH136	9080 GH136	9080 GH136
4 Foot Long (2)	9080 GH148	9080 GH148	9080 GH148	9080 GH148
6 Foot Long (2)	9080 GH172	9080 GH172	9080 GH172	9080 GH172
Snap-Off: 3 Foot Long (2)	9080 GH236	9080 GH236	9080 GH236	9080 GH236
4 Foot Long (2)	9080 GH248	9080 GH248	9080 GH248	9080 GH248
6 Foot Long (2)	9080 GH272	9080 GH272	9080 GH272	9080 GH272
End Clamp	9080 KH20	9080 KH20	9080 KH20	9080 KH20
Vinyl Marking Strip	9080 MS6	9080 MS6	9080 MS6	9080 MS6
Marking Strip End Plug	9080 KH25	9080 KH25	9080 KH25	9080 KH26

(1) Additional 9080 GH track can be found on page 8.

(2) When terminal block length exceeds 12 inches, guide blocks (9080 KH24) maintain terminal block rigidity.

(3) For use with 0.25 inch wide slip-on connectors.







\* These maximum current values assume the use of insulated copper conductors with 75° C temperature rating, and are calculated based on NEC Article 310, Table 310-16. In most cases this value is the maximum ampacity of that wire or combination of wires (as listed in the above table) which has the greatest current carrying capacity. The actual allowable current for a particular application is dependent upon the number, size, insulation class and other characteristics of the wires used.





# NEMA Type Terminal Blocks

## 9080 Type K Block

### Accessories

Description	Type
<b>Assembly Kit – Includes:</b>  1 - End Barrier KH-21  2 - End Clamps KH-20  1 - 24 Circuit Marking Strip ▲  2 - Marking Strip End Plugs KH-25  2 - Guide Blocks ◆ KH-24	K1
<b>Kit Includes:</b>  1 - Marking Strip End Plug KH-26  1 - End Barrier KH-22	KH2**
White Vinyl Marking Strip - 50" Length	MS6
Adhesive Backed Marking Strip Sheet - 20 Strips - 11" Length	MS1
End Clamp Assembly for 9080 GH track	KH20
End Barrier (for all Type K blocks, except the KE1, KS1, and KH1)	KH21
End Barrier (for KE1, KS1 and KH1 blocks)	KH22
Guide Blocks ◆	KH24
Marking Strip End Plug (for all Type K blocks, except KH1 and KS1)	KH25
Marking Strip End Plug (for Type KH1 and KS1)	KH26

#### Accessories:

Jumpers for Use with Type KCA1 Blocks	No. of Ckts.	Type
	 	2
	6	JCA6

◆ When terminal block length exceeds 12 inches, a guide block (9080 GH24) should be used every 6 inches to maintain terminal block rigidity.  
 \*\* Includes parts required in addition to Type K1 kit when Types KH1, KE1, or KS1 blocks are used. KH26 end plug used only on KH1 and KS1.  
 ▲ 30 circuit when used with Type KCA1 and 20 circuits with KH1 or KE1.





# NEMA Type Terminal Blocks

## Type G Block

### Approximate Dimensions

Dual Dimensions:  $\frac{\text{Inches}}{\text{Millimeters}}$

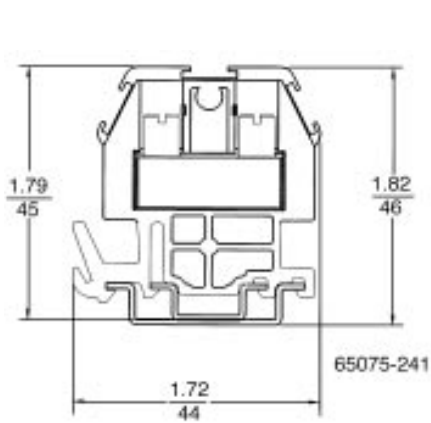

GR6  
GR6T

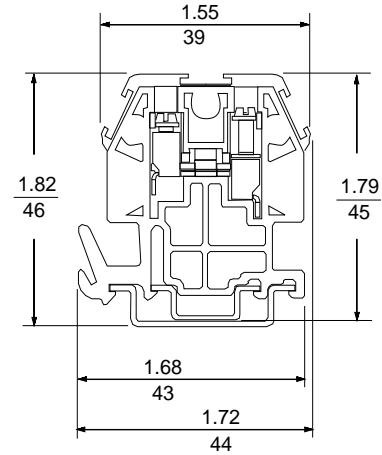

GM6

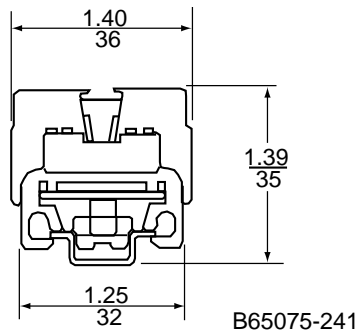

Type GK6

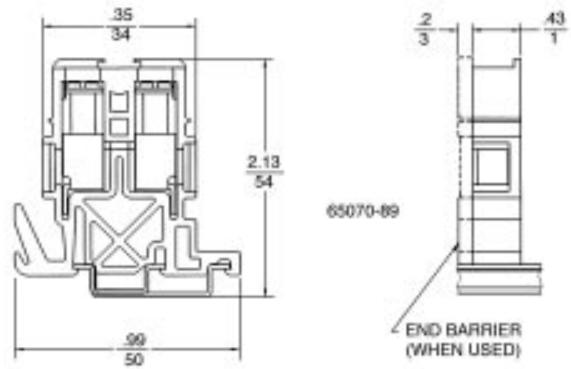

Type GC6

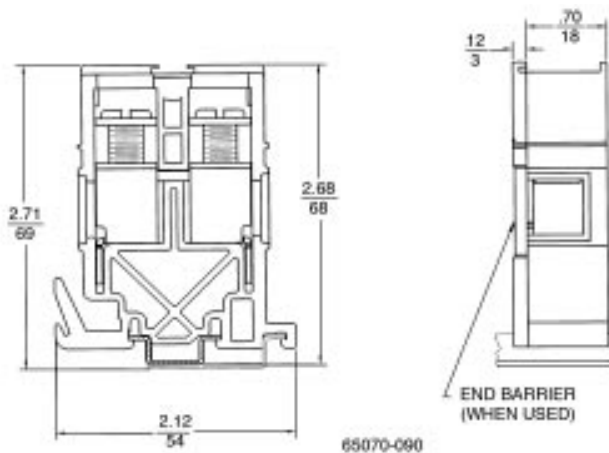

Type GD6

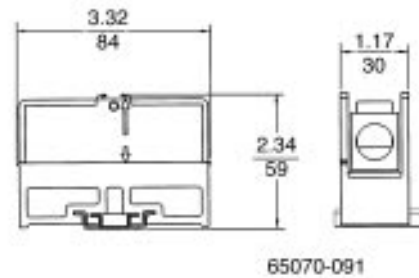

Type GE6



# NEMA Type Terminal Blocks

## Type G Block

### Approximate Dimensions

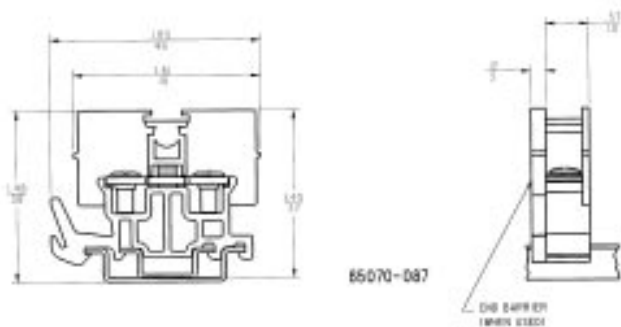

Type GA6

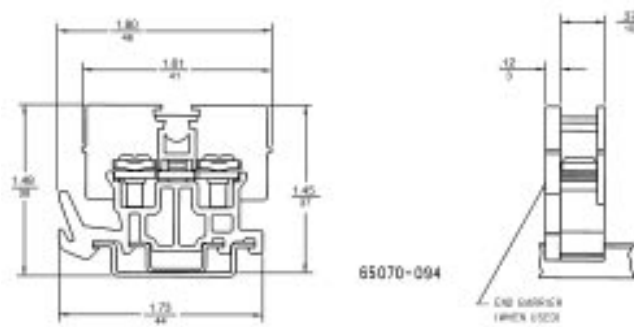

Type GP6

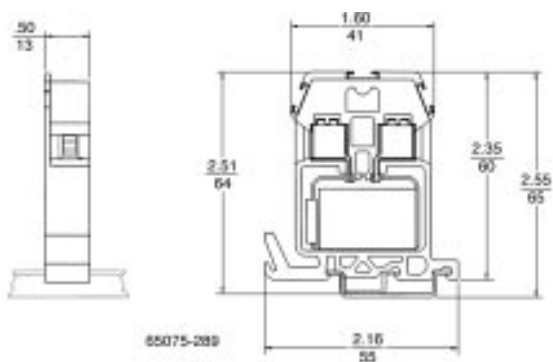

Type GT6

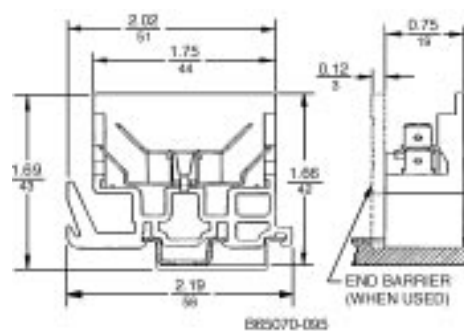

Type GS6

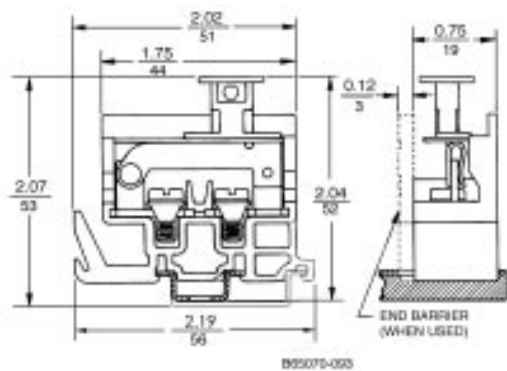

GG6

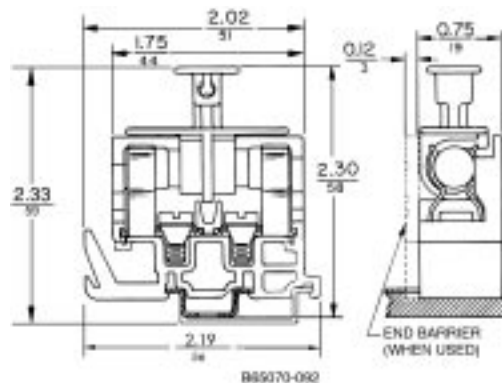

GF6 with fusepuller

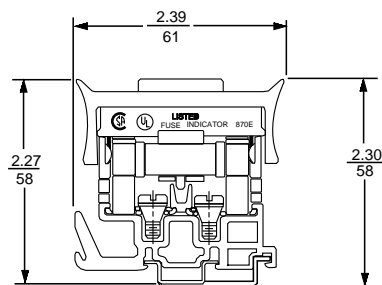

GF6, with blown fuse indicator

Dual Dimensions:  $\frac{\text{Inches}}{\text{Millimeters}}$



NEMA Type Terminal Blocks  
**Type K Block**  
**Approximate Dimensions**

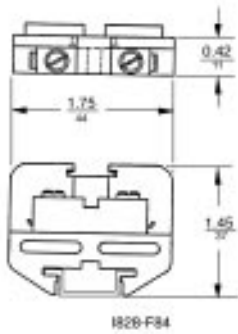

KCA1

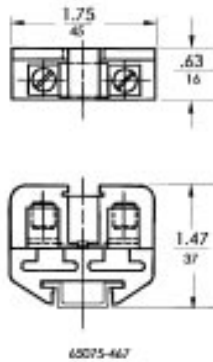

KD1

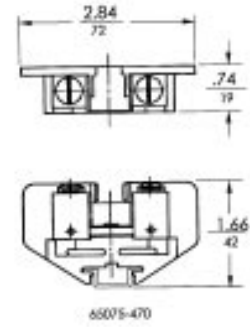

KE1

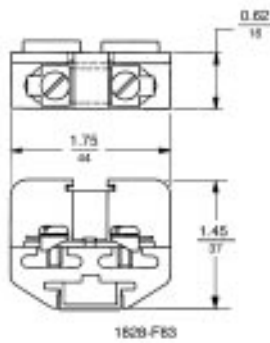

KC1

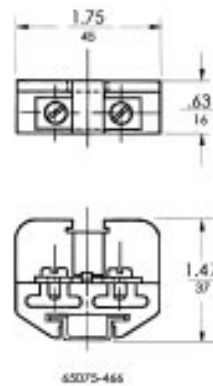

KCB1, KCBT1

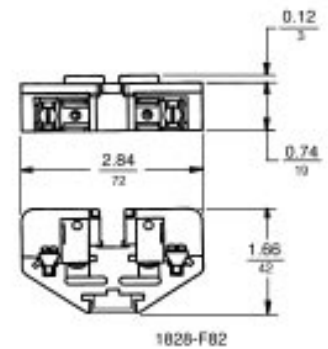

KH1

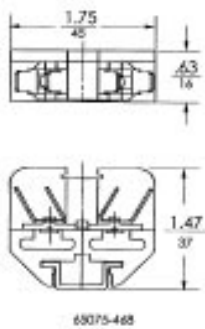

KCS1

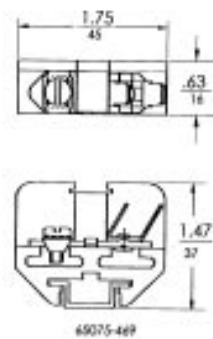

KCPS1

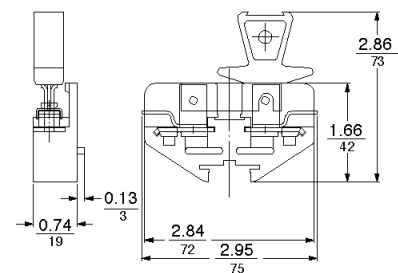

51077060

KS1

Dual Dimensions:  $\frac{\text{Inches}}{\text{Millimeters}}$



# NEMA Type Terminal Blocks Circuit Protectors and Assemblies Approximate Dimensions

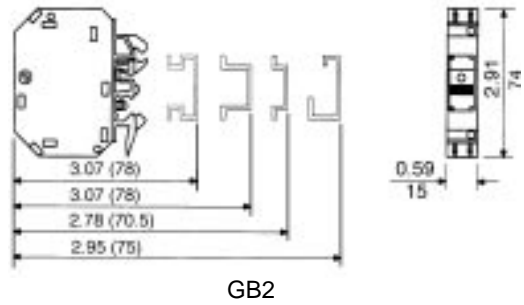
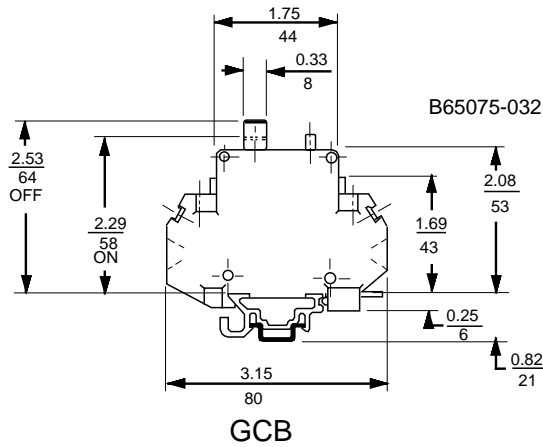

Dual Dimensions: Inches / Millimeters

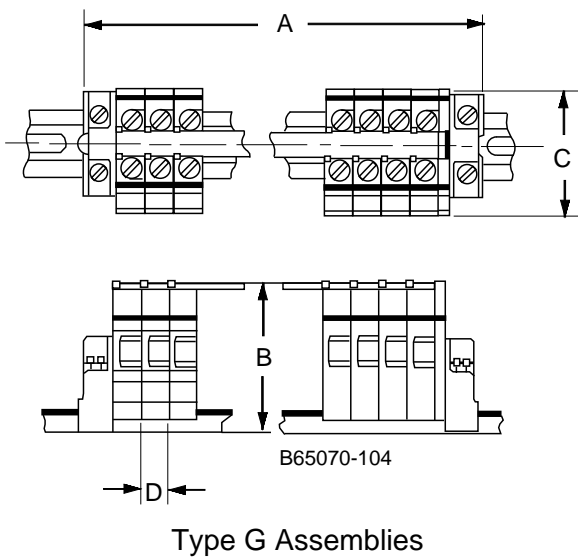

Type G Assemblies

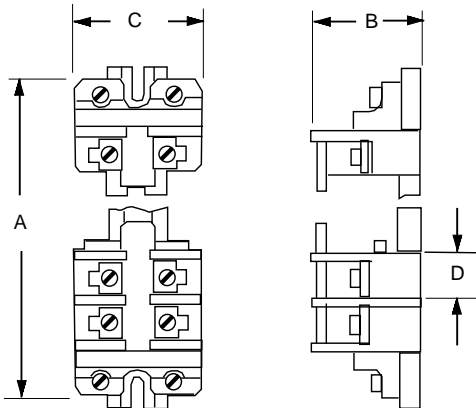

Type K Assemblies

CLASS 9080 TYPE	Dim. A ▲ inches (mm)	Dim. B ◆ inches (mm)	Dim. C inches (mm)	Dim. D inches (mm)	Max. Sect. (Nominal) per foot (mm)
GA6	.37 N + .93 (9.4 N + 23.6)	1.48 (37.6)	1.80 (45.7)	0.37 (9.4)	32 (106)
GC6	.43 N + .93 (10.9 N + 23.6)	2.13 (54.1)	1.99 (50.5)	0.43 (10.9)	28 (91)
GD6	.70 N + .93 (17.8 N + 23.6)	2.71 (68.8)	2.12 (53.8)	0.70 (17.8)	17 (56)
GE6	1.17 N + .93 (29.7 N + 23.6)	2.34 (59.4)	3.32 (84.3)	1.17 (29.7)	10 (33)
GF6 (with extractor)	.75 N + .93 (19.1 N + 23.6)	2.33 (59.2)	2.19 (55.6)	0.75 (19.1)	16 (52)
GF6 (with blown fuse indicator)	.75 N + .80 (19.1 N + 23.6)	2.39 (60.7)	2.30 (58.4)	0.75 (19.1)	16 (52)
GG6	.75 N + .93 (19.1 N + 23.6)	2.07 (52.6)	2.19 (55.6)	0.75 (19.1)	16 (52)
GK6	.35 N + .93 (8.9 N + 23.6)	1.39 (35.3)	1.40 (35.6)	0.35 (8.9)	34 (112)
GM6	.24 N + .93 (6.0 N + 23.6)	1.82 (46.2)	1.72 (43.7)	0.24 (6.0)	51 (164)
GP6	.37 N + .93 (9.5 N + 23.6)	1.48 (37.6)	1.80 (45.7)	0.37 (9.5)	32 (106)
GR6	.35 N + .93 (8.9 N + 23.6)	1.82 (46.2)	1.72 (43.7)	0.35 (8.9)	34 (112)
GS6	.75 N + .93 (19.1 N + 23.6)	1.69 (42.9)	2.19 (55.6)	0.75 (19.1)	16 (52)
GT6	.50 N + .93 (12.7 N + 23.6)	2.55 (64.8)	2.16 (54.9)	0.50 (12.7)	24 (78)
GCB	.50 N + .93 (12.7 N + 23.6)	3.38 (85.9)	3.15 (80.0)	.50 (12.7)	24 (78)

CLASS 9080 TYPE	Dim. A* inches (mm)	Dim. B inches (mm)	Dim. C inches (mm)	Dim. D inches (mm)	Max. Sect. (Nominal) per foot (mm)
KCA1	.42 N + 1.38 (10.7 N + 35.1)	1.45 (37.1)	1.75 (44.5)	0.42 (10.7)	28 (93)
KC1, KCB1, KCBT1 KCS1, KCPS1, KD1	.63 N + 1.38 (16.0 N + 35.1)	1.47 (37.3)	1.75 (44.5)	0.63 (16.0)	19 (62)
KE1 & KH1	.74 N + 1.38 (18.8 N + 35.1)	1.66 (42.2)	2.84 (72.1)	0.74 (18.8)	16 (53)
KS1	.74 N + 1.38 (18.8 N + 35.1)	2.99 (75.9)	2.95 (74.9)	0.74 (18.8)	16 (53)

▲ Where N is the total number of blocks in the assembly.  
If slip-in end clamps (9080 GH11) are used, subtract 0.8 inches (20.3 mm). Slip-in clamps cannot be used with 9080 GK6, GE6 or K blocks.  
◆ Dimension shown is based on DIN3 track being used, except for the 9080 GK6 block.

**Note:** Mounting dimension of factory assembled blocks may vary slightly from results above due to difference in actual length of channel used.



# NEMA Type Terminal Blocks Mounting Track and End Clamps Approximate Dimensions

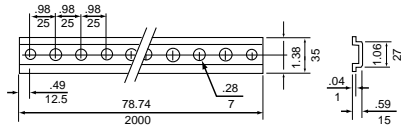

AM1DP200

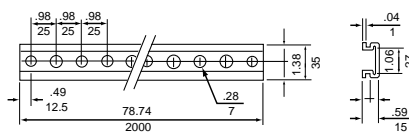

AM1ED200

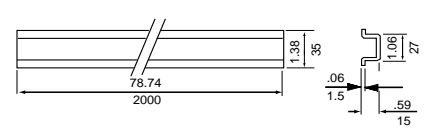

AM1DE200

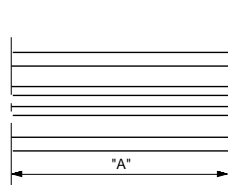

9080MH2\*\*

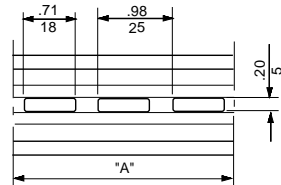
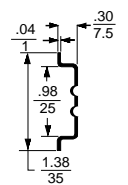

9080MH3\*\*

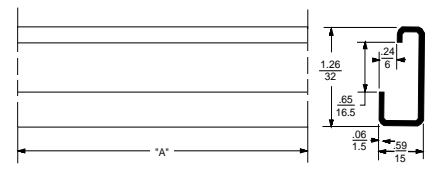

9080MH1\*\*

If the last two digits of the catalog number is 20, then "A" is equal to 1/2 m (19.7 in).  
If the last two digits of the catalog number is 39, then "A" is equal to 1 m (39.4 in).  
If the last two digits of the catalog number is 79, then "A" is equal to 2 m (78.7 in).

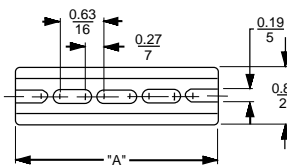

9080GH1\*\*

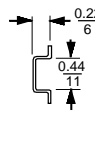

65075-290

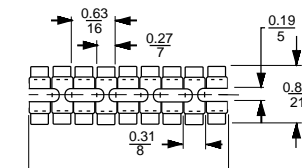

9080GH2\*\*

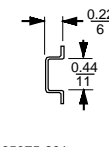

65075-291

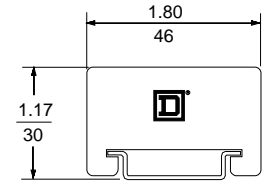

9080MHA10

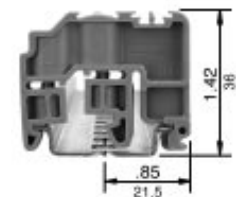

9080MH10 on  
9080MH2\*\* or AM1DP200 track

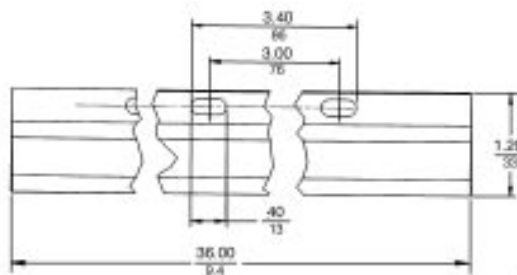

9080GH336

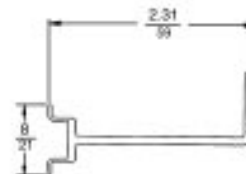

65075-485

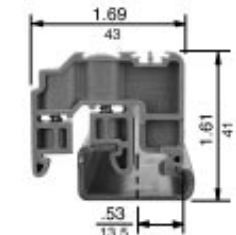

9080MH10 on  
9080MH1\*\* track

Dual Dimensions:  $\frac{\text{Inches}}{\text{Millimeters}}$



NEMA Type Terminal Blocks  
**Notes**





---

SQUARE D

Square D Company  
P.O. Box 27446  
Raleigh, N.C. 27611, USA

FINGERSAFE® is a registered trademark of Square D Company  
UL is a registered trademark of Underwriters Laboratory  
CSA is a registered Trademark of Canadian Standard Association

