

# 3 Port Solenoid Valve

## Series V100

Rubber Seal

*Power consumption 0.1 W (with power saving circuit)*



VV061

**V100**

S070

VQD

VKF

VK

VT

VS

Coil temperature rises: 1°C (with power saving circuit)

Sonic conductance C: 0.037 (Standard)/C: 0.076 (Large flow capacity)

Series		Flow characteristics		
		C[dm <sup>3</sup> /(s·bar)]	b	Cv
Standard	V1□4	0.037	0.11	0.008
Large flow capacity	V1□4A	0.076	0.070	0.016

### Variations

Series		Type of actuation	Operating pressure range (MPa)	Power consumption (W)	
				Standard	With power saving circuit
Standard	V114	N.C.	0 to 0.7	0.35	0.1
	V124	N.O.	0 to 0.7	0.35	0.1
Large flow capacity	V114A	N.C.	0 to 0.7	1	—
	V124A	N.O.	0 to 0.7	1	—

# 3 Port Solenoid Valve/Direct Operated

# Series V100

## Rubber Seal

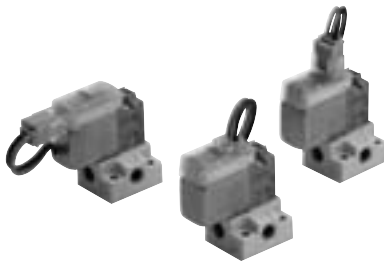

### Specifications

Fluid	Air
Ambient and fluid temperature (°C)	-10 to 50 (No freezing)
Response time (DC) (ms) <sup>Note 1)</sup>	ON: 5 or less OFF: 4 or less
Max. operating frequency (Hz)	20
Manual override	Non-locking push, Locking slotted
Lubrication	Not required
Mounting position	Unrestricted
Impact/Vibration resistance (m/s <sup>2</sup> ) <sup>Note 2)</sup>	150/30
Enclosure	Dust proof



Note 1) Based on dynamic performance test JIS B8374-1981 (standard type: at coil temperature of 20°C, with rated voltage, without surge voltage suppressor)

Note 2) Impact resistance: No malfunction resulted in an impact test using a drop impact tester. The test was performed one time each in the axial and right angle directions of the main valve and armature, for both energized and de-energized states. (Value in the initial stage)

Vibration resistance: No malfunction resulted in 45 to 2000 Hz, a one-sweep test performed in the axial and right angle directions of the main valve and armature for both energized and de-energized states. (Value in the initial stage)

### Solenoid Specifications

Series	V114/V124	V114A/V124A	
Electrical entry	Grommet (G)/(H), L plug connector(L) M plug connector (M)		
Coil rated voltage (V)	DC	24, 12, 6, 5, 3	
	AC <sup>50/60</sup> Hz	100, 110, 200, 220	
Allowable voltage fluctuation	-10 to 10% *		
Power consumption (W)	DC	Standard: 0.35 (with light: 0.4) With power saving circuit 0.1	
	AC	1 W (with light: 1.1)	
Apparent power (VA)	AC	100 V	0.78 (with light: 0.81)
		110 V [115 V]	0.86 (with light: 0.89) [0.94 (with light: 0.97)]
		200 V	1.18 (with light: 1.22)
		220 V [230 V]	1.30 (with light: 1.34) [1.42 (with light: 1.46)]
Surge voltage suppressor	Refer to page 1527.		
Indicator light	LED		



\* Can be used for 110 VAC and 115 VAC, 220 VAC and 230 VAC in common.

\* For 115 VAC and 230 VAC, the allowable voltage fluctuation will be -15% to 5% of the coil rated voltage.

\* The voltage drop will occur due to the internal circuit of S, Z and T types (with energy saving circuits). Allowable voltage fluctuations should be within the range below.

S and Z types 24 VDC: -7% to +10%

12 VDC: -4% to +10%

T type 24 VDC: -8% to +10%

12 VDC: -6% to +10%

### JIS symbol

V114(A)

V124(A)

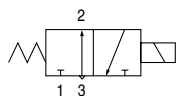
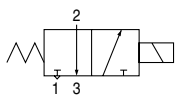

## Specifications

Valve model	Type of actuation	Model	Operating pressure range (MPa)	Vacuum specification (MPa)		Port size		Mass (g) <sup>Note 2)</sup>	
				Port 1	Port 3	Port 1, 3	Port 2	Grommet	L plug connector M plug connector
V114	N.C.	Standard	0 to 0.7	-100 kPa to 0.6	-100 kPa to 0	M5 x 0.8	M5 x 0.8	V1□4:13(27) V1□4A:16(30)	Plug connector V1□4:12(26) V1□4A:15(29)
V114A	N.C.	Large flow capacity	0 to 0.7	-100 kPa to 0.6	-100 kPa to 0	M5 x 0.8	M5 x 0.8		
V124 <sup>Note 1)</sup>	N.O.	Standard	0 to 0.7	-100 kPa to 0	-100 kPa to 0.6	M5 x 0.8	M5 x 0.8		
V124A <sup>Note 1)</sup>	N.O.	Large flow capacity	0 to 0.7	-100 kPa to 0	-100 kPa to 0.6	M5 x 0.8	M5 x 0.8		

Valve model	Flow characteristics					
	1→2			2→3		
	C[dm <sup>3</sup> /(s·bar)]	b	Cv	C[dm <sup>3</sup> /(s·bar)]	b	Cv
V114	0.037	0.11	0.008	0.054	0.35	0.015
V114A	0.076	0.07	0.016	0.099	0.23	0.024
V124 <sup>Note 1)</sup>	0.054	0.35	0.015	0.037	0.11	0.008
V124A <sup>Note 1)</sup>	0.099	0.23	0.024	0.076	0.07	0.016

Note 1) For both V124 and V124A, pressure from port 3 and exhaust from port 1.  
 Note 2) The values shown in ( ) are for values with sub-plate.

## Construction

V114(A)

V124(A)

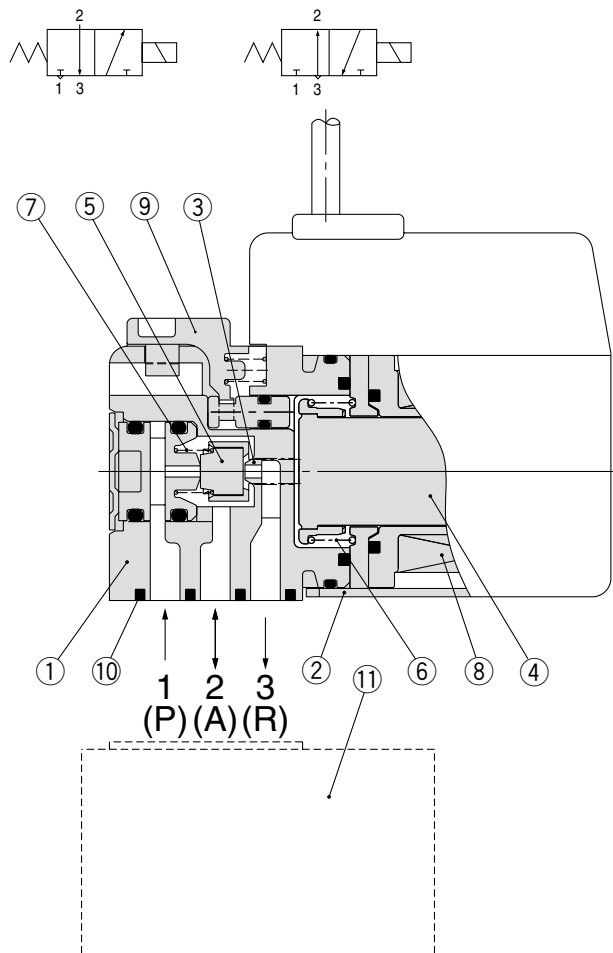

### Component Parts

No.	Description	Material
1	Body	Resin
2	Cover	Stainless steel
3	Push rod	Resin
4	Armature assembly	Stainless steel, Resin
5	Poppet	FKM
6	Return spring	Stainless steel
7	Poppet spring	Stainless steel
8	Coil assembly	—
9	Manual override	Resin

### Replacement Parts

No.	Description	Part no.	Material	Note
10	Gasket assembly	V100-31-1A	FKM, Steel	Gasket, 2 screws
11	Sub-plate	V100-74-1	Aluminum die-cast	—

### How to Order Connector Assembly

For DC: **SY100-30-4A** -

For 100 VAC: **SY100-30-1A** -

For 200 VAC: **SY100-30-2A** -

For other voltages of AC: **SY100-30-3A** -

Without lead wire:  
(with connector and 2 sockets) **SY100-30-A** ● **Lead wire length**

Nil	300 mm
6	600 mm
10	1000 mm
15	1500 mm
20	2000 mm
25	2500 mm
30	3000 mm
50	5000 mm

VV061

V100

S070

VQD

VKF

VK

VT

VS

## How to Order

### Standard type

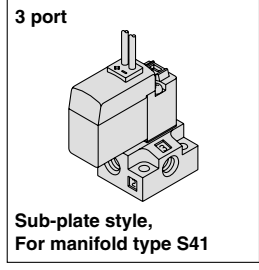
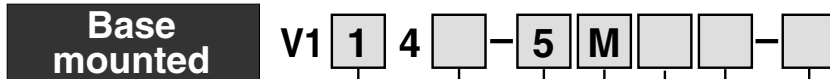

**Type of actuation**

1	Normally closed
2	Normally open

**Coil specification**

Nil	0.35 W
T	0.1 W (with power saving circuit) (24 VDC, 12 VDC only)

\* All the types with power saving circuit are with light and surge voltage suppressor "Z".

**Rated voltage**

For DC	
5	24 VDC
6	12 VDC
V	6 VDC
S	5 VDC
R	3 VDC
For AC (50/60 Hz)	
1	100 VAC
2	200 VAC
3	110 VAC [115 VAC]
4	220 VAC [230 VAC]

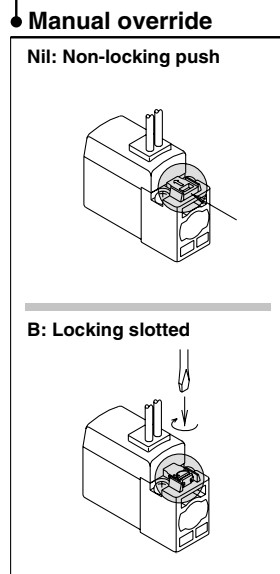
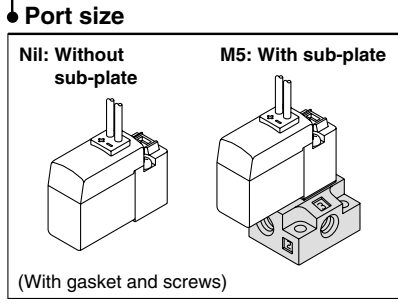

**Electrical entry**

24 V, 12 V, 6 V, 5 V, 3 VDC/100 V, 110 V, 200 V, 220 VAC			
Grommet	L plug connector	M plug connector	
G: 300 mm lead wire H: 600 mm lead wire	L: With 300 mm lead wire	M: With 300 mm lead wire	MN: Without lead wire
	LN: Without lead wire	LO: Without connector	MO: Without connector

**Indicator light and surge voltage suppressor**

Nil	Without indicator light or surge voltage suppressor	For DC, AC
S	With surge voltage suppressor	For DC
Z	With indicator light and surge voltage suppressor	For DC, AC
R	With surge voltage suppressor (Non-polar)	For DC
U	With indicator light and surge voltage suppressor (Non-polar)	

\* Only "Z" is available for the types with power saving circuit.

\* LN and MN types are with 2 sockets.  
\* Refer to page 1526 for the different lead wire lengths of L and M plug connectors.  
\* Refer to page 1527 for the connector assembly with a dustproof cover for L and M plug connectors.

## How to Order

### Large flow type

**Base mounted**

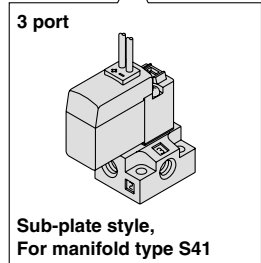

V1 **1** 4 A — **5** M — — —

#### Type of actuation

1	Normally closed
2	Normally open

#### Large flow capacity

#### Rated voltage

For DC	
5	24 VDC
6	12 VDC
V	6 VDC
S	5 VDC
R	3 VDC

#### Port size

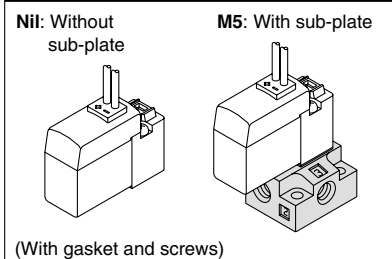

#### Manual override

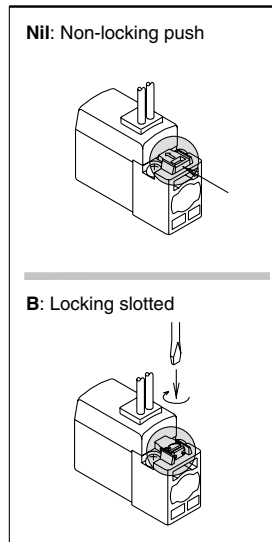

#### Electrical entry

24 V, 12 V, 6 V, 5 V, 3 VDC			
Grommet	L plug connector	M plug connector	
<b>G:</b> 300 mm lead wire	<b>L:</b> With 300 mm lead wire	<b>M:</b> With 300 mm lead wire	<b>MN:</b> Without lead wire
<b>H:</b> 600 mm lead wire			
	<b>LN:</b> Without lead wire	<b>LO:</b> Without connector	<b>MO:</b> Without connector

#### Indicator light and surge voltage suppressor

Nil	Without indicator light or surge voltage suppressor	For DC
R	With surge voltage suppressor	
U	With indicator light and surge voltage suppressor	



- \* LN and MN types are with 2 sockets.
- \* Refer to page 1526 for the different lead wire lengths of L and M plug connectors.
- \* Refer to page 1527 for the connector assembly with a dustproof cover for L and M plug connectors.

VV061

V100

S070

VQD

VKF

VK

VT

VS

# Series V100

Note [ ] : AC

< > : values for the large flow type (A)

## Base Mounted (With sub-plate)

### Grommet (G), (H): V1<sub>2</sub><sup>1</sup>4(A)-□<sup>G</sup><sub>H</sub>□□-M5

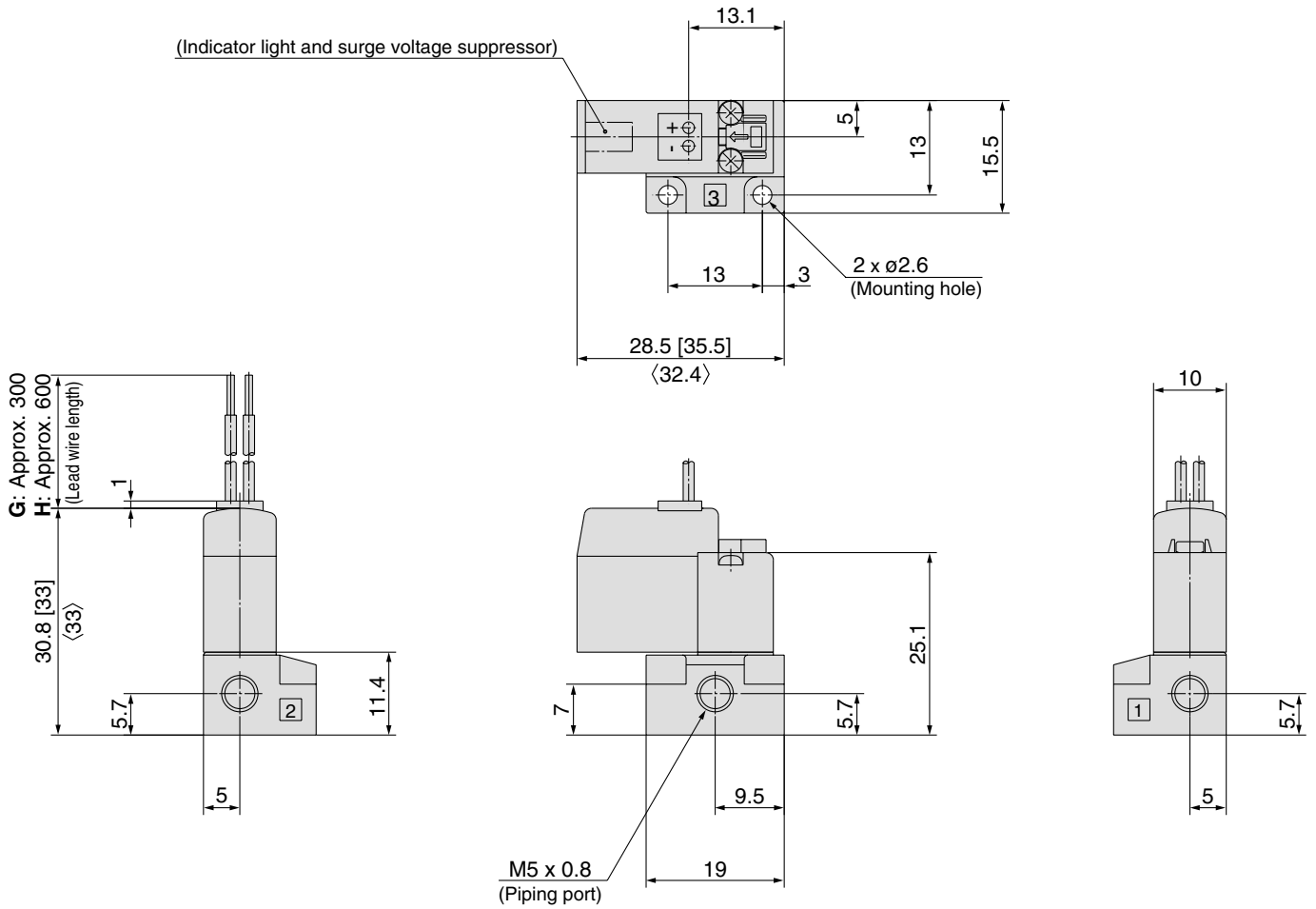

### L plug connector (L): V1<sub>2</sub><sup>1</sup>4(A)-□L□□-M5

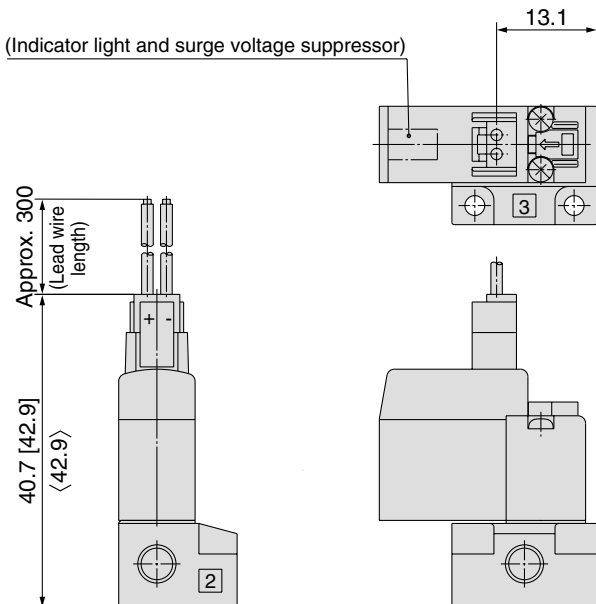

\* Other dimensions are same as the grommet type.

1522

### M plug connector (M): V1<sub>2</sub><sup>1</sup>4(A)-□M□□-M5

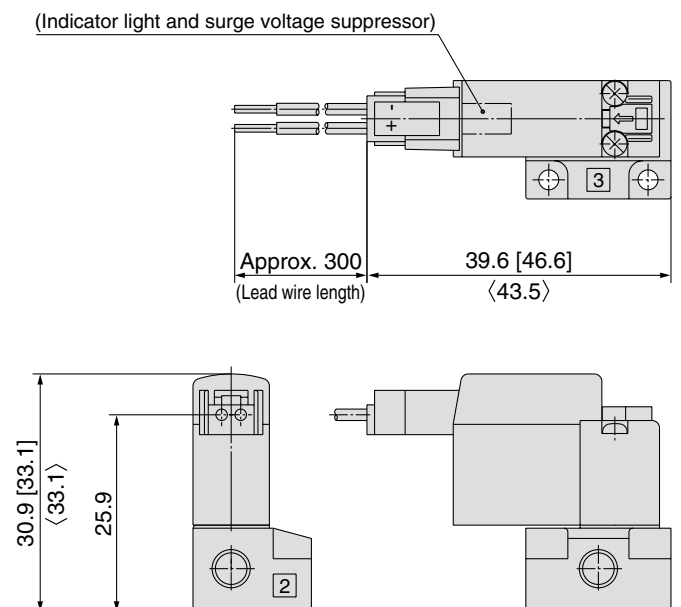

\* Other dimensions are same as the grommet type.



# 3 Port Solenoid Valve Series V100 Manifold Specifications

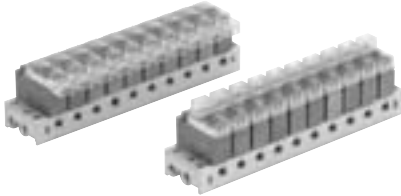

## Manifold Specifications

Model		Type S41
Manifold		Single base style/B mount
P (SUP)/R (EXH) style		Common SUP/Common EXH
Valve stations		2 to 20 stations
Output port porting specifications	Location	Base
	Direction	Side
Port size	Port 1, 2, 3	M5 x 0.8

Note 1) V114(A) and V124(A) cannot be mounted to the same manifold.  
Note 2) For V124(A), pressure from port 3 and exhaust from port 1.

## Flow Characteristics

Manifold		Port size Port 1, 2, 3	Flow characteristics					
			1→2			2→3		
Type VV100-S41	V114	M5 x 0.8	C[dm <sup>3</sup> /(s·bar)]	b	Cv	C[dm <sup>3</sup> /(s·bar)]	b	Cv
	V114A		0.032	0.13	0.007	0.050	0.26	0.012
	V124		0.070	0.10	0.016	0.085	0.16	0.020
	V124A		0.050	0.26	0.012	0.032	0.13	0.007
	V124A		0.085	0.16	0.020	0.070	0.10	0.016

Note) Values when mounted on the manifold base (5 stations).

## How to Order Valve Manifold Assembly (Example)

### Ordering example

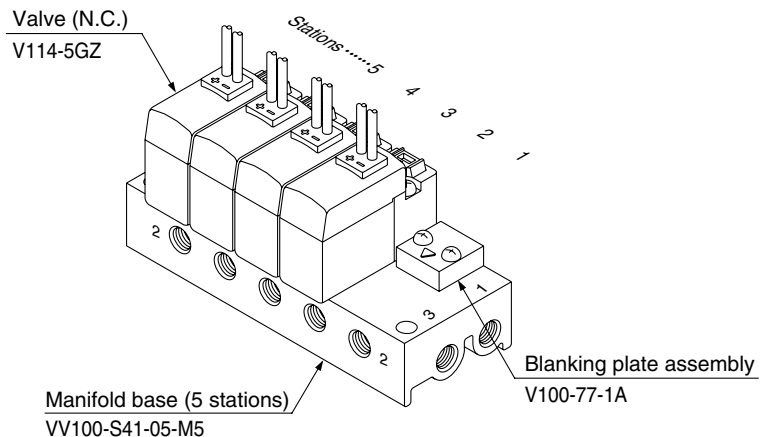

**VV100-S41-05-M5** ..... 1 set (Type S41, 5 station manifold base part no.)

\***V100-77-1A** ..... 1 set (Blanking plate assembly part no.)

\***V114-5GZ** ..... 4 sets (Valve)

\*The asterisk (\*) is used when referring to assembly.

Enter the asterisk at the beginning of individual component part numbers.

Beneath the manifold base part number, enter the valve and option part numbers to be mounted.

VV061

V100

S070

VQD

VKF

VK

VT

VS

# Series V100

## Common SUP/Common EXH

### Type S41

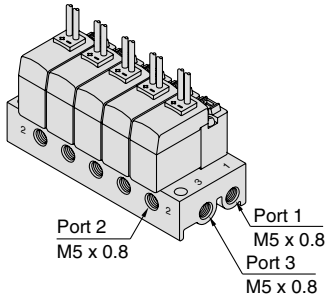

### How to Order

**VV100 - S41 - 05 - M5**

Stations	
02	2 stations
⋮	⋮
20	20 stations

2 port size	
M5	M5 x 0.8

### Applicable solenoid valve <sup>Note)</sup>

V114-□□□□  
 V114A-□□□□  
 V124-□□□□  
 V124A-□□□□

Applicable blanking plate assembly  
 V100-77-1A



Note) V114(A) and V124(A) cannot be mounted to the same manifold.

## Gasket Assembly

Part No. V100-31-1A

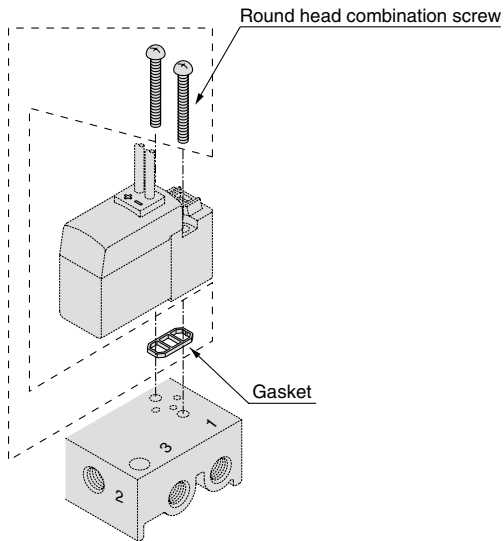

### Applicable base

- Sub-plate
- Type VV100-S41 manifold base

## Blanking Plate Assembly

Part No. V100-77-1A

Place the notch mark on a blanking plate to the port 2 side when assembling.

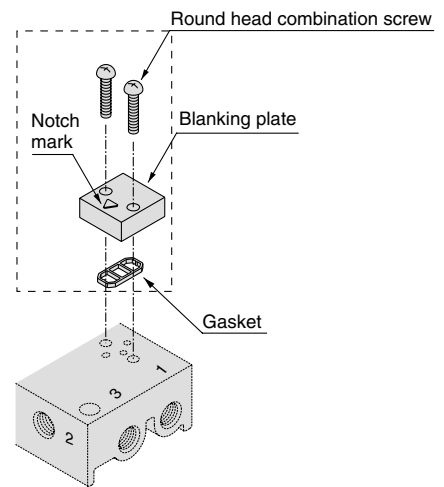

### Applicable base

- Sub-plate
- Type VV100-S41 manifold base

## ⚠ Caution

Mounting screw tightening torques M2: 0.12 N·m



## Type S41 Manifold: Side Ported/VV100-S41-Stations-M5

Note) [ ] : AC

< > : values for the large flow type (A)

### Grommet (G), (H)

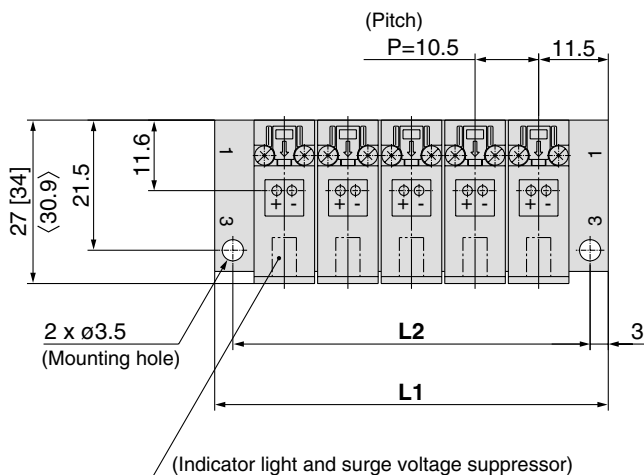

G: Approx. 300

H: Approx. 600

(Lead wire length)

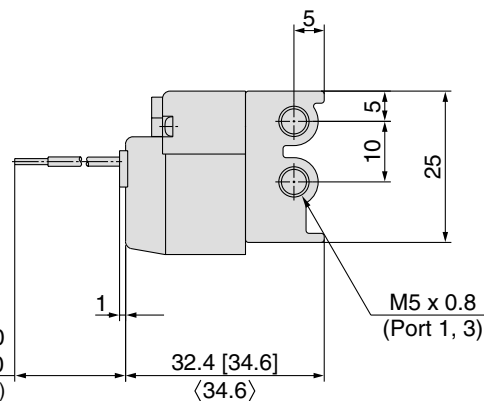

(n station) ----- (1 station)

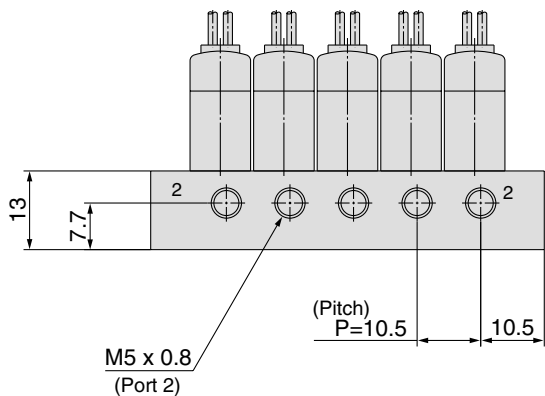

VV061

V100

S070

VQD

VKF

VK

VT

VS

### L plug connector (L)

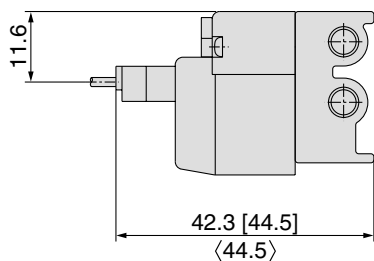

 \* Other dimensions are same as the grommet type.

### M plug connector (M)

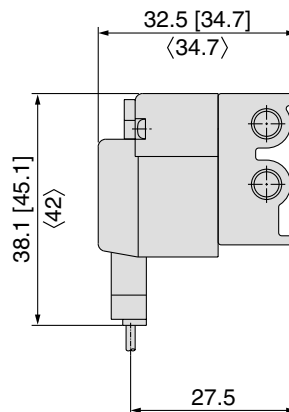

 \* Other dimensions are same as the grommet type.

Station	2 stations	3	4	5	6	7	8	9	10	11	12	13	14	15	16	17	18	19	20 stations
L1	33.5	44	54.5	65	75.5	86	96.5	107	117.5	128	138.5	149	159.5	170	180.5	191	201.5	212	222.5
L2	27.5	38	48.5	59	69.5	80	90.5	101	111.5	122	132.5	143	153.5	164	174.5	185	195.5	206	216.5



# Series V100

## Specific Product Precautions 1

Be sure to read before handling.

Refer to front matters 58 and 59 for Safety Instructions and pages 3 to 7 for 3/4/5 Port Solenoid Valve Precautions.

### Warning

#### Manual Override Operation

Since connected equipment will be actuated when the manual override is operated, first confirm that conditions are safe.

#### Non-locking push type [Standard type]

Press in the direction of the arrow

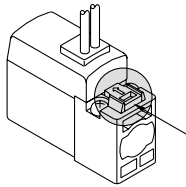

#### Locking slotted type [B type]

Turn in the direction of arrow.

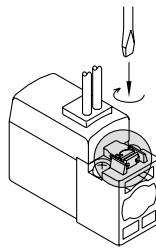

#### Caution

When operating with a screw driver, turn it gently using a watchmakers' screw driver. [Torque: less than 0.1Nm]

### Caution

#### How to Use of Plug Connector

##### 1. Attaching and detaching connectors

- To attach a connector, hold the lever and connector unit between your fingers and insert straight onto the pins of the solenoid valve so that the lever's pawl is pushed into the groove and locks.
- To detach a connector, remove the pawl from the groove by pushing the lever downward with your thumb, and pull the connector straight out.

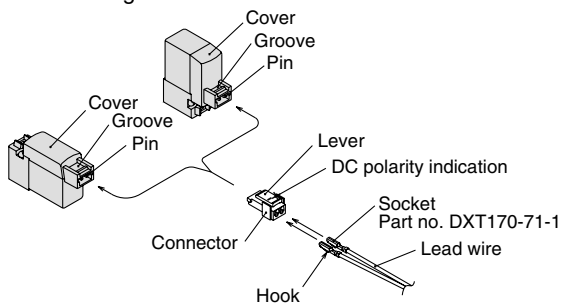

##### 2. Crimping of lead wires and sockets

Strip 3.2 to 3.7 mm at the end of the lead wires, insert the ends of the core wires evenly into the sockets, and then crimp with a crimping tool. When this is done, take care that the coverings of the lead wires do not enter the core wire crimping area.

Use special tool when crimping. (Consult with SMC for the crimping tool.)

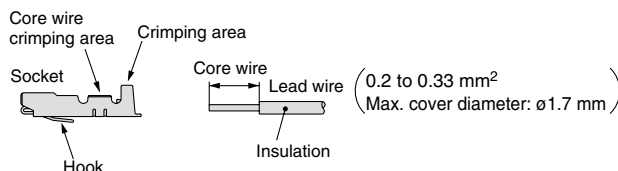

### Caution

#### How to Use a Plug Connector

##### 3. Attaching and detaching lead wires with sockets

###### Attaching

Insert the sockets into the square holes of the connector (+, - indication), and continue to push the sockets all the way in until they lock by hooking into the seats in the connector. (When they are pushed in, their hooks open and they are locked automatically.) Then confirm that they are locked by pulling lightly on the lead wires.

###### Detaching

To detach a socket from a connector, pull out the lead wire while pressing the socket's hook with a stick having a thin tip (about 1 mm). If the socket will be used again, first spread the hook outward.

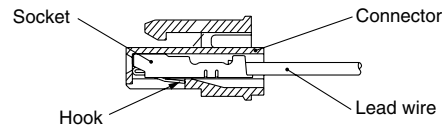

#### Plug Connector Lead Wire Length

Standard length is 300 mm, but the following length is also available.

#### How to Order Connector Assembly

For DC: **SY100-30-4A-** [ ]

For 100 VAC: **SY100-30-1A-** [ ]

For 200 VAC: **SY100-30-2A-** [ ]

For other voltages of AC: **SY100-30-3A-** [ ]

Without lead wire: **SY100-30-A**  
(with connector and 2 sockets)

#### How to Order

To order a valve with lead wire length of other than 300 mm, indicate part numbers of the valve without connector and the required connector assembly separately.

<Example> Lead wire length 2000 mm

For DC	For AC
V114-5LO	V114A-1LO
SY100-30-4A-20	SY100-30-1A-20

#### Lead wire length

Nil	300 mm
6	600 mm
10	1000 mm
15	1500 mm
20	2000 mm
25	2500 mm
30	3000 mm
50	5000 mm



# Series V100

## Specific Product Precautions 2

Be sure to read before handling.

Refer to front matters 58 and 59 for Safety Instructions and pages 3 to 7 for 3/4/5 Port Solenoid Valve Precautions.

### Surge Voltage Suppressor

<For DC>

Grommet, L and M Plug Connector

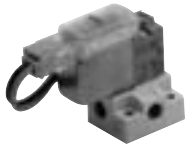

#### Standard type (with polarity) With surge voltage suppressor (□S)

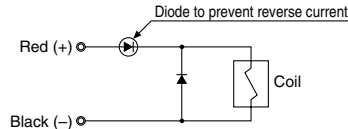

#### Indicator light and surge voltage suppressor (□Z)

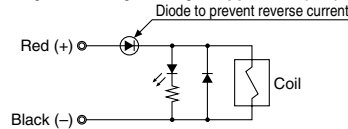

#### Non-polar type With surge voltage suppressor (□R)

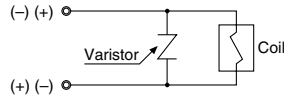

#### Indicator light and surge voltage suppressor (□U)

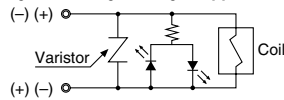

- Please connect correctly the lead wires to + (positive) and - (negative) indications on the connector.
- For DC voltages other than 12, 24 VDC, incorrect wiring will cause damage to the surge voltage suppressor circuit since a diode to prevent reverse current is not provided. (Wrong polarity will cause trouble.)
- Solenoids, whose lead wires have been pre-wired: positive side red and negative side black.

#### With power saving circuit

Power consumption is reduced by approximately 75% compared with the standard product by eliminating the need for electrical current for holding. (Effective after more than 62 ms energized and 24 VDC rated voltage applied.)

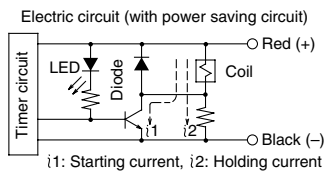

### Operating Principle

The electrical circuit as shown above, allows reduced holding current consumption and measures power saving. Refer to the electric waveform on the right.

- Please be careful not to reverse the polarity, since a diode to prevent the reversed current is not provided for the power saving circuit.

<Electric waveform in power saving, in the case of V1<sub>2</sub>4T>

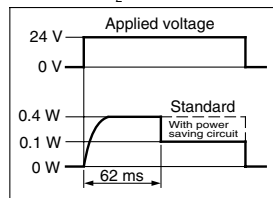

<For AC>

Grommet, L and M Plug Connector

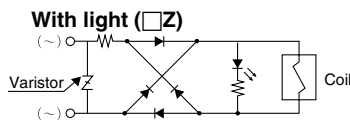

### Caution

In the case of varistor surge voltage suppressor, note the surge voltage to be suppressed at controller side as there will be a residual voltage according to the protective element and rated voltage.

Moreover, the residual voltage of the diode is approximately 1 V.

### Connector Assembly with Cover

Connector assembly with protective cover enhances dust protection

- Effective in preventing possible short circuit problems due to contaminants in contact with connector section.
- Cover material is chloroprene rubber which has excellent weatherability and electric insulation properties. However, be careful not to allow contact with cutting oil, etc.
- Round cord provides neat appearance.

### How to Order

SY100-68-A

Lead wire length (L)

Nil	300 mm
6	600 mm
10	1000 mm
15	1500 mm
20	2000 mm
25	2500 mm
30	3000 mm
50	5000 mm

### Connector Assembly with Cover/Dimensions

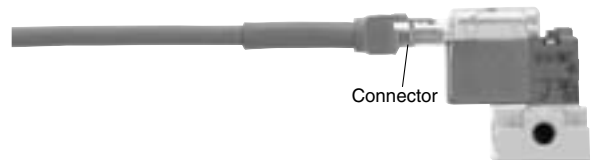
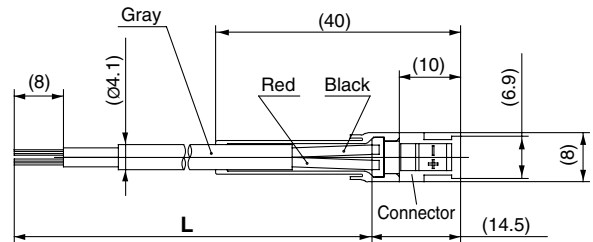

#### How to Order

Indicate part number of connector assembly with cover in addition to the solenoid valve part number without connector of the plug connector.

<Example 1> Lead wire length: 2000 mm

V114-5LOZ-M5

SY100-68-A-20

<Example 2> Lead wire length: 300 mm (Standard)

V114-5Lpz-M5

Symbol for a connector assembly with cover

\* No need to indicate the part number for a connector assembly with cover in this case.