

Genius I/O

Genius bus from GE Fanuc is a proven I/O bus and communications network. It can handle large I/O and data transfers.

Features and benefits:

- Robust for superior data integrity and noise immunity
- Deterministic
- Supports redundant configurations (both cable and I/O)
- Available on a variety of GE Fanuc products

Supported by many third-party interfaces: variable frequency drives, operator interfaces, human machine interfaces, etc.

Genius I/O, 470 Cable Specifications

- Cable that Meets the Requirements of Genius I/O Systems and Communications Standard
- This is a Twin Axial Cable with 100 Ohm Impedance

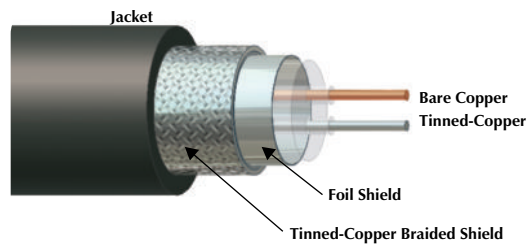

Max Bus Length:

7500 feet with 16 devices at 38.4 Kbaud
 3500 feet with 32 devices at 153.6 Kbaud

Type	Approvals	Data Pair		Outer Jacket	Shields	Bulk Cable Part Number / Weight/300 M
		AWG Color Code	DCR (/1000 feet) Insulation	Material Color Nominal O.D.	Type Drain Wire	
470 75°C 300 Volts	NEC CMG CL2 CEC CMG	2/20 AWG Natural, Natural	9.5 Ohms PE	PVC Black 8.4 mm (.330 in)	Foil/Braid	RB51153-*M 68 lbs.

* Indicates length in Meters.









Standard cable lengths are 1.0, 2.0, 4.0, 6.0, 10....15 Meters. Consult factory for other lengths.

Genius I/O is a registered trademark of GE.

TURCK

Network Media Products

Genius I/O, 470 Communication Cable and Cordset Selection Matrix

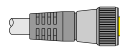
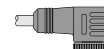
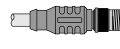
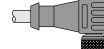
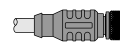
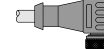

		<i>minifast</i> [®]				<i>eurofast</i> [®]
		Pin (Male)		Socket (Female)		Pin (Male)
		1 	2 	3 	4 	5 
		RSM	WSM	RKM	WKM	RSC
		RSM 470-*M	WSM 470-*M	RKM 470-*M	WKM 470-*M	RSC 470-*M
<i>minifast</i>	Pin (Male)					
	1 	RSM RSM 470-*M	RSM WSM 470-*M	RSM RKM 470-*M	RSM WKM 470-*M	RSM RSC 470-*M
	2 		WSM WSM 470-*M	WSM RKM 470-*M	WSM WKM 470-*M	WSM RSC 470-*M
	3 			RKM RKM 470-*M	RKM WKM 470-*M	RKM RSC 470-*M
Socket (Female)	4 				WKM WKM 470-*M	WKM RSC 470-*M
	5 					RSC RSC 470-*M
<i>eurofast</i>	Pin (Male)					
	6 					
	7 					
	8 					

See pages K5 - K6 for dimensional drawings.

* Indicates length in meters.

Standard cable lengths are 1.0, 2.0, 4.0, 6.0, 10...15 Meters. Consult factory for other lengths.

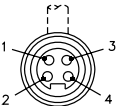
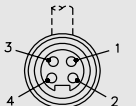
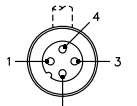
For stainless steel coupling nuts change part number RSM... to RSV, WSM... to WSV.

<i>minifast</i>		Pinouts	<i>eurofast</i>	
Male	Female		Male	Female
		1. Silver 2. Copper 3. N/C 4. Drain		

Genius I/O, 470 Communication Cable and Cordset Selection Matrix

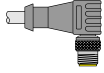
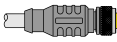
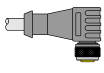
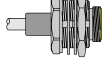
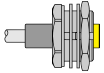
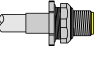
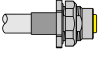
<i>euofast</i> [®]			<i>minifast</i> [®] Bulkhead		<i>euofast</i> Bulkhead (thin only)	
Pin (Male)	Socket (Female)		Pin (Male)	Socket (Female)	Pin (Male)	Socket (Female)
6 	7 	8 	9 	10 	11 	12 
WSC	RKC	WKC	RSFP	RKFP	FSFD	FKFD
WSC 470-*M	RKC 470-*M	WKC 470-*M	RSFP 470-*M	RKFP 470-*M	FSFD 470-*M	FKFD 470-*M
RSM WSC 470-*M	RSM RKC 470-*M	RSM WKC 470-*M	RSM RSFP 470-*M	RSM RKFP 470-*M	RSM FSFD 470-*M	RSM FKFD 470-*M
WSM WSC 470-*M	WSM RKC 470-*M	WSM WKC 470-*M	WSM RSFP 470-*M	WSM RKFP 470-*M	WSM FSFD 470-*M	WSM FKFD 470-*M
RKM WSC 470-*M	RKM RKC 470-*M	RKM WKC 470-*M	RKM RSFP 470-*M	RKM RKFP 470-*M	RKM FSFD 470-*M	RKM FKFD 470-*M
WKM WSC 470-*M	WKM RKC 470-*M	WKM WKC 470-*M	WKM RSFP 470-*M	WKM RKFP 470-*M	WKM FSFD 470-*M	WKM FKFD 470-*M
RSC WSC 470-*M	RSC RKC 470-*M	RSC WKC 470-*M	RSC RSFP 470-*M	RSC RKFP 470-*M	RSC FSFD 470-*M	RSC FKFD 470-*M
WSC WSC 470-*M	WSC RKC 470-*M	WSC WKC 470-*M	WSC RSFP 470-*M	WSC RKFP 470-*M	WSC FSFD 470-*M	WSC FKFD 470-*M
	RKC RKC 470-*M	RKC WKC 470-*M	RKC RSFP 470-*M	RKC RKFP 470-*M	RKC FSFD 470-*M	RKC FKFD 470-*M
		WKC WKC 470-*M	WKC RSFP 470-*M	WKC RKFP 470-*M	WKC FSFD 470-*M	WKC FKFD 470-*M

Genius I/O, minifast® Cordset and Receptacle Connector Dimensions

Specifications

Housing:	PUR (polyurethane)
Coupling Nut:	Nickel-Plated CuZn or Stainless Steel
Contact Carrier:	TPU (polyurethane)
Contacts:	Gold-Plated CuZn
Protection:	NEMA 1, 3, 4, 6P and IEC IP 68
Rated Voltage:	300 V
Rated Current:	9 A
Ambient Temperature:	-30°C to +75°C

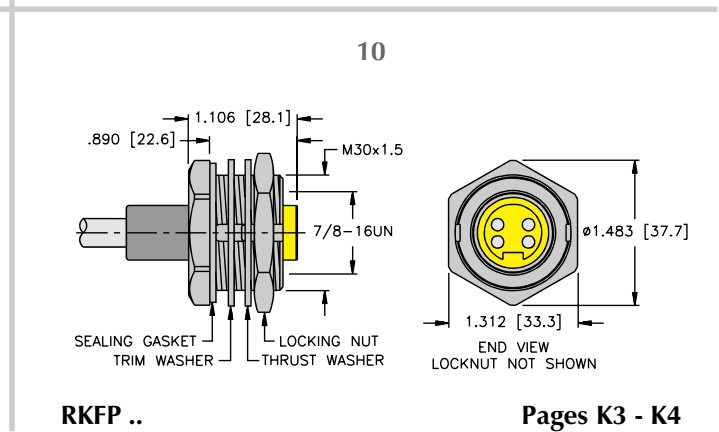
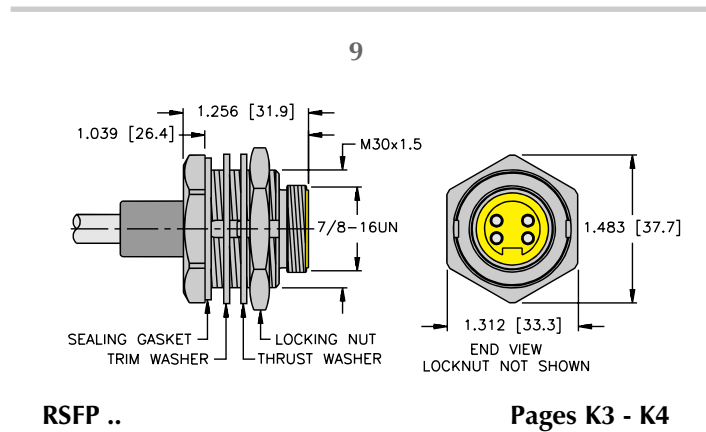
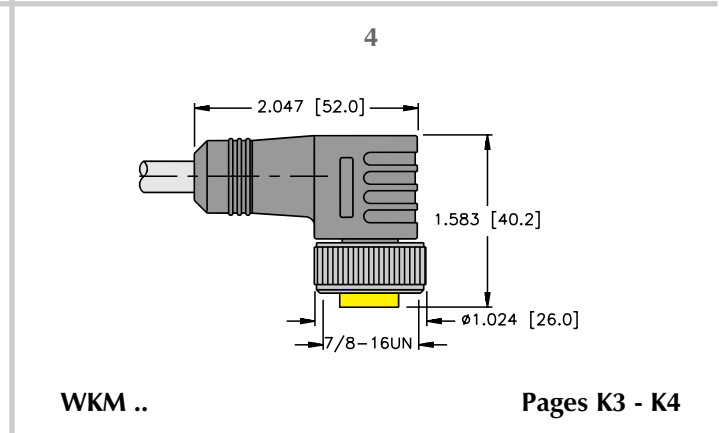
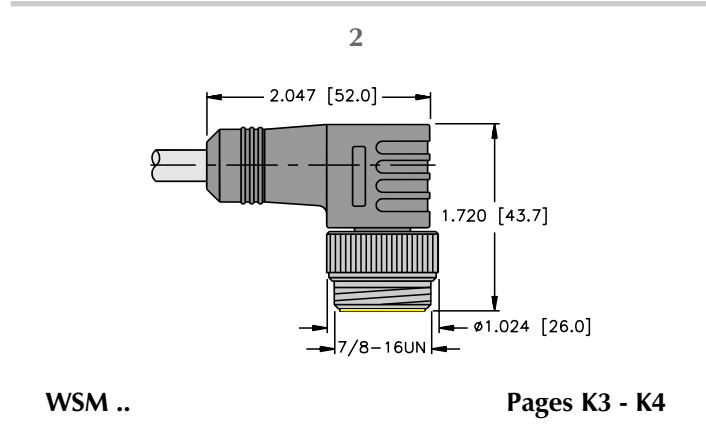
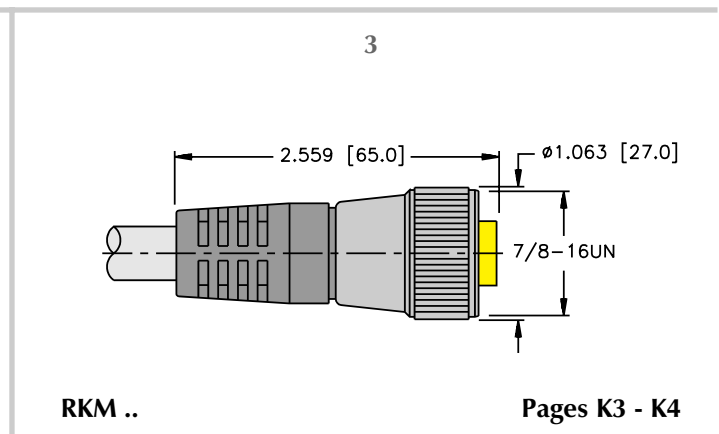
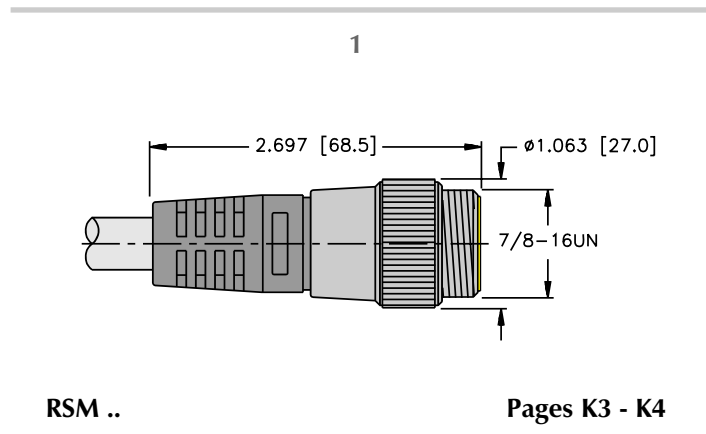

Genius I/O, eurofast® Cordset and Receptacle Connector Dimensions

Specifications

Housing:	PUR (polyurethane)
Coupling Nut:	Nickel-Plated CuZn or Stainless Steel
Contact Carrier:	TPU (polyurethane) or POM (Nylon)
Contacts:	Gold-Plated CuZn
Protection:	NEMA 1, 3, 4, 6P and IEC IP 68
Rated Voltage:	250 V
Rated Current:	4 A
Ambient Temperature:	-30°C to +75°C

5

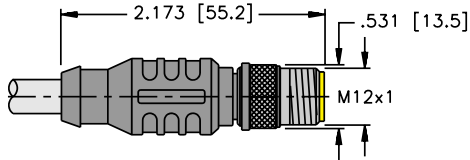

RSC ..

Pages K3 - K4

7

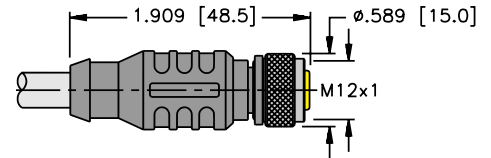

RKC ..

Pages K3 - K4

6

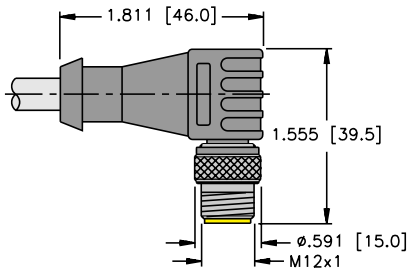

WSC ..

Pages K3 - K4

8

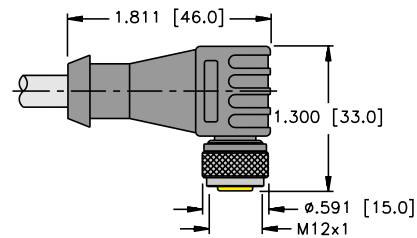

WKC ..

Pages K3 - K4

11

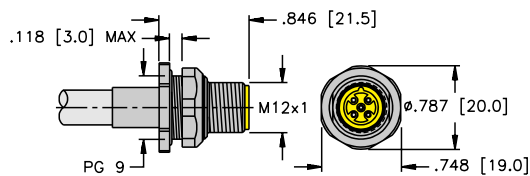

FSFD ..

Pages K3 - K4

12

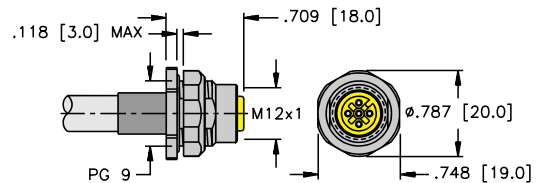

FKFD ..

Pages K3 - K4