

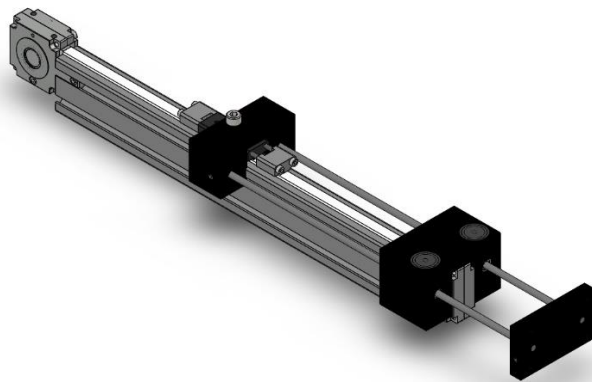

MSA-BT1 Actuator



Features

- Durable, cost-effective alternative to unreliable pneumatic and hydraulic cylinders and expensive rod style actuators
- Zero backlash belt to pulley design
- Extruded base profile allows multiple side mounting and attachment of elements using T-slot nut fasteners
- Designed for fast, easy replacement of spare parts
- Open design does not retain contaminants and debris
- MACReady versions available - ready to run out of the box with motor and controls

Specifications

Motion	Horizontal/Vertical
Maximum Thrust Force lbs (N)	100 [45]
Minimum Travel (mm)	150
Maximum Travel (mm)	1500
Travel Increment (mm)	25
Maximum Speed (mm/s)	2000
Maximum Acceleration (g 's)	5
Repeatability (mm)	±0.025
Positional Accuracy (mm/m of travel)	±0.4
Corrosion Resistant Options Available	

Macron Solutions Since 1987

MACRON DYNAMICS, INC

100 Phyllis Drive

Croydon, PA 19021

© 2015 MACRON DYNAMICS, INC

1-800-MACRON-1 (1-800-622-7661)

Phone: 267-557-3590

Fax: 215-443-0981

Macron Guarantee

All Macron actuators and belt drives are covered by our

1-Year Warranty