

D

**GENERAL**

**ACME®  
TRANSFORMER™  
GENERAL  
INFORMATION**

**Design Figures, Wiring Diagrams,  
Accessories, Specification  
Guides, Industry Standards and  
Alphanumerical Catalog  
Number Index**

Design Figures.....	122
Wiring Diagrams .....	123-132
Transformer Accessories .....	133-134
Specification Guides .....	135-138
Industry Standards .....	139
Alphanumerical Catalog Number Index .....	140-144

H

# Design Figures

## Sections I, II, III & IV

These drawings are for reference only.  
Contact factory for certified drawings.

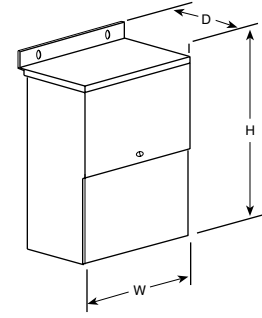

Design A

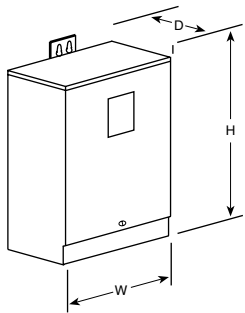

Design B

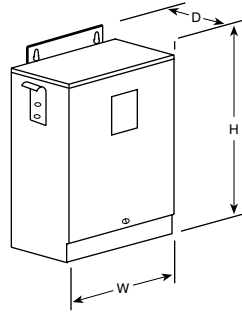

Design C

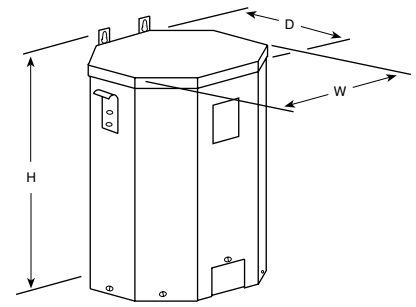

Design D

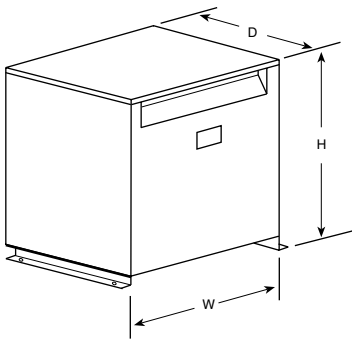

Design E

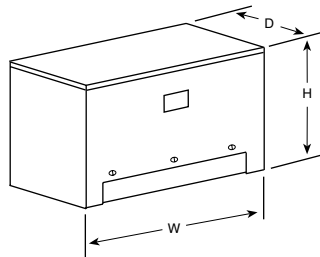

Design F

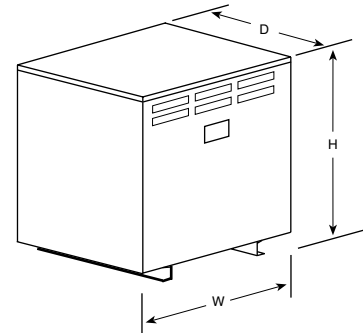

Design G

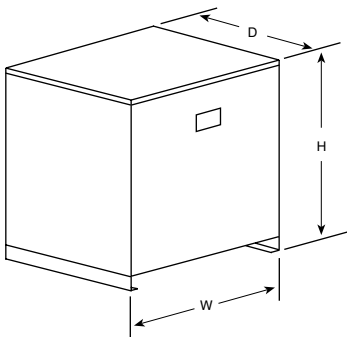

Design H

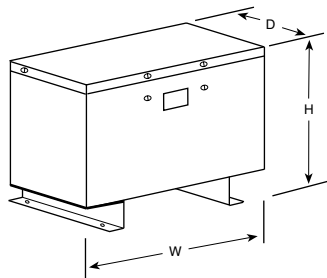

Design I

# Wiring Diagrams Sections I, II, III & IV

**1** PRIMARY: 240 X 480  
SECONDARY: 120/240  
TAPS: None

Primary Volts	Connect Primary Lines To	Inter-Connect	Connect Secondary Lines To
480	H1-H4	H2 to H3	
240	H1-H3 & H2-H4		

**Secondary Volts**

Secondary Volts	Inter-Connect	Connect Secondary Lines To
240	X2 to X3	X1-X4
120/240	X2 to X3	X1-X2-X4
120	X1 to X3 X2 to X4	X1-X4

**2** PRIMARY: 240 X 480  
SECONDARY: 120/240  
TAPS: None

Primary Volts	Connect Primary Lines To	Inter-Connect	Connect Secondary Lines To
480	H1-H4	H2 to H3	
240	H1-H3 & H2-H4		

**Secondary Volts**

Secondary Volts	Inter-Connect	Connect Secondary Lines To
240	X2 to X3	X1-X4
120/240	X2 to X3	X1-X2-X4
120	X1 to X3 X2 to X4	X1-X4

**3** PRIMARY: 240 X 480  
SECONDARY: 120/240  
TAPS: 2, 2 1/2% ANFC, 2, 2 1/2% BNFC

Primary Volts	Connect Primary Lines To	Inter-Connect	Connect Secondary Lines To
252	H1-H8	H1 to H5 H4 to H8	
240	H1-H7	H1 to H5 H3 to H7	
228	H1-H6	H1 to H5 H2 to H6	
504	H1-H8	H4 to H5	
492	H1-H8	H3 to H5	
480	H1-H7	H3 to H5	
468	H1-H7	H2 to H5	
456	H1-H6	H2 to H5	

**Secondary Volts**

Secondary Volts	Inter-Connect	Connect Secondary Lines To
240	X2 to X3	X1-X4
120/240	X2 to X3	X1-X2-X4
120	X1 to X3 X2 to X4	X1-X4

**4** PRIMARY: 240 X 480  
SECONDARY: 120/240  
2, 2 1/2% ANFC, 4, 2 1/2% BNFC

Primary Volts	Connect Primary Lines To	Inter-Connect	Connect Secondary Lines To
216	H1-H10	H1 to H9 H10 to H2	
228	H1-H10	H1 to H8 H10 to H3	
240	H1-H10	H1 to H7 H10 to H4	
252	H1-H10	H1 to H6 H10 to H5	
432	H1-H10	H2 to H9	
444	H1-H10	H3 to H9	
456	H1-H10	H3 to H8	
468	H1-H10	H4 to H8	
480	H1-H10	H4 to H7	
492	H1-H10	H5 to H7	
504	H1-H10	H5 to H6	

**Secondary Volts**

Secondary Volts	Inter-Connect	Connect Secondary Lines To
240	X2 to X3	X1-X4
120/240	X2 to X3	X1-X3-X4
120	X1 to X3 X2 to X4	X1-X4

**5** PRIMARY: 240 X 480  
SECONDARY: 120/240  
TAPS: 2, 2 1/2% ANFC, 2, 2 1/2% BNFC

Primary Volts	Connect Primary Lines To	Inter-Connect	Connect Secondary Lines To
216	H1-H4	H1, H3, 8 & H2, H4, 1	
228	H1-H4	H1, H3, 7 & H2, H4, 2	
240	H1-H4	H1, H3, 6 & H2, H4, 3	
252	H1-H4	H1, H3, 5 & H2, H4, 4	
432	H1-H4	H2, 1 & H3, 8	
444	H1-H4	H2, 2 & H3, 8	
456	H1-H4	H2, 2 & H3, 7	
468	H1-H4	H2, 3 & H3, 7	
480	H1-H4	H2, 3 & H3, 6	
492	H1-H4	H2, 4 & H3, 6	
504	H1-H4	H2, 4 & H3, 5	

**Secondary Volts**

Secondary Volts	Inter-Connect	Connect Secondary Lines To
240	X2 to X3	X1-X4
120/240	X2 to X3	X1-X2-X4
120	X1 to X3 X2 to X4	X1-X4

**6** PRIMARY: 208  
SECONDARY: 120/240  
TAPS: 2, 5% BNFC

Primary Volts	Connect Primary Lines To	Inter-Connect	Connect Secondary Lines To
208	H1 & H4		
198	H1 & H3		
187	H1 & H2		

**Secondary Volts**

Secondary Volts	Inter-Connect	Connect Secondary Lines To
240	X2 to X3	X1-X4
120/240	X2 to X3	X1-X2-X4
120	X1 to X3 X2 to X4	X1-X4

**7** PRIMARY: 277  
SECONDARY: 120/240  
TAPS: 2, 5% BNFC

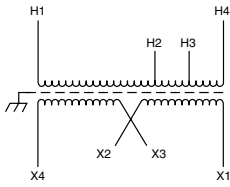

Primary Volts	Connect Primary Lines To	Inter-Connect	Connect Secondary Lines To
277	H1 & H4		
263	H1 & H3		
250	H1 & H2		

**Secondary Volts**

Secondary Volts	Inter-Connect	Connect Secondary Lines To
240	X2 to X3	X1-X4
120/240	X2 to X3	X1-X2-X4
120	X1 to X3 X2 to X4	X1-X4

**8** PRIMARY: 600  
SECONDARY: 120/240  
TAPS: None

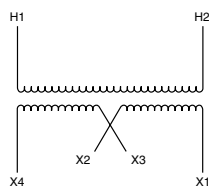

Primary Volts	Connect Primary Lines To	Inter-Connect	Connect Secondary Lines To
600	H1-H2		

**Secondary Volts**

Secondary Volts	Inter-Connect	Connect Secondary Lines To
240	X2 to X3	X1-X4
120/240	X2 to X3	X1-X2-X4
120	X1 to X3 X2 to X4	X1-X4

**9** PRIMARY: 600  
SECONDARY: 120/240  
TAPS: None

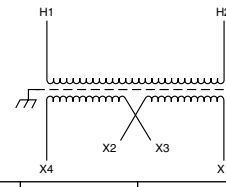

Primary Volts	Connect Primary Lines To	Inter-Connect	Connect Secondary Lines To
600	H1-H2		

**Secondary Volts**

Secondary Volts	Inter-Connect	Connect Secondary Lines To
240	X2 to X3	X1-X4
120/240	X2 to X3	X1-X2-X4
120	X1 to X3 X2 to X4	X1-X4

**10** PRIMARY: 600  
SECONDARY: 120/240  
TAPS: 2, 5% BNFC

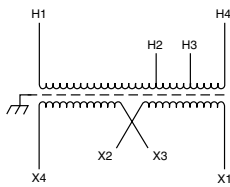

Primary Volts	Connect Primary Lines To	Inter-Connect	Connect Secondary Lines To
600	H1-H4		
570	H1-H3		
540	H1-H2		

**Secondary Volts**

Secondary Volts	Inter-Connect	Connect Secondary Lines To
240	X2 to X3	X1-X4
120/240	X2 to X3	X1-X2-X4
120	X1 to X3 X2 to X4	X1-X4

**11** PRIMARY: 600  
SECONDARY: 120/240  
TAPS: 2, 2 1/2% ANFC, 4, 2 1/2% BNFC

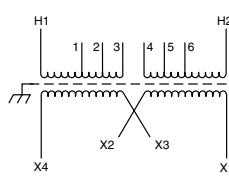

Primary Volts	Connect Primary Lines To	Inter-Connect	Connect Secondary Lines To
540	H1-H2	1-6	
555	H1-H2	1-5	
570	H1-H2	2-6	
585	H1-H2	2-5	
600	H1-H2	3-5	
615	H1-H2	2-4	
635	H1-H2	3-4	

**Secondary Volts**

Secondary Volts	Inter-Connect	Connect Secondary Lines To
240	X2 to X3	X1-X4
120/240	X2 to X3	X1-X2-X4
120	X1 to X3 X2 to X4	X1-X4

**12** PRIMARY: 240  
SECONDARY: 120/240  
TAPS: None

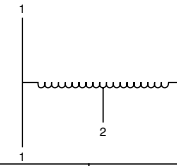

Primary Volts	Connect Primary Lines To	Inter-Connect	Connect Secondary Lines To
240	1-3		

**Secondary Volts**

Secondary Volts	Inter-Connect	Connect Secondary Lines To
240		1-3
120		1-2 or 2-3
120/240		1-2-3

**13** PRIMARY: 120 x 240  
SECONDARY: 120/240  
TAPS: None

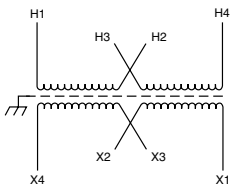

Primary Volts	Connect Primary Lines To	Inter-Connect	Connect Secondary Lines To
240	H1-H4	H2 to H3	
120	H1-H3 & H2-H4		

**Secondary Volts**

Secondary Volts	Inter-Connect	Connect Secondary Lines To
240	X2 to X3	X1-X4
120/240	X2 to X3	X1-X2-X4
120	X1 to X3 X2 to X4	X1-X4

**14** EXPORT MODEL  
PRIMARY: 190-220 x 380-440  
SECONDARY: 120/240

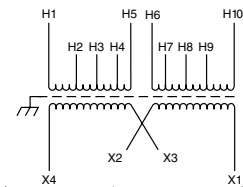

Primary Volts	Connect Primary Lines To	Inter-Connect	Connect Secondary Lines To
190	H1 & H7	H1 to H6 H2 to H7	
200	H1 & H8	H1 to H6 H3 to H8	
208	H1 & H9	H1 to H6 H4 to H9	
220	H1 & H10	H1 to H6 H5 to H10	
380	H1 & H7	H2 & H6	
400	H1 & H8	H3 & H6	
416	H1 & H9	H4 & H6	
440	H1 & H10	H5 & H6	

**Secondary Volts**

Secondary Volts	Inter-Connect	Connect Secondary Lines To
240	X2 to X3	X1-X4
120/240	X2 to X3	X1-X2-X4
120	X1 to X3 X2 to X4	X1-X4

**15 EXPORT MODEL**  
**PRIMARY: 190-220 x 380-440**  
**SECONDARY:120/240**

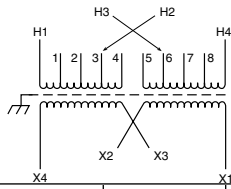

Primary Volts	Connect Primary Lines To	Inter-Connect	Connect Secondary Lines To
190	H1 & H4	H1, H3, 8 & H2, H4, 1	
200	H1 & H4	H1, H3, 7 & H2, H4, 2	
208	H1 & H4	H1, H3, 6 & H2, H4, 3	
220	H1 & H4	H1, H3, 5 & H2, H4, 4	
380	H1 & H4	H2, H3, 1, 8	
400	H1 & H4	H2, H3, 2, 7	
416	H1 & H4	H2, H3, 3, 6	
440	H1 & H4	H2, H3, 4, 5	
<b>Secondary Volts</b>			
240		X2 to X3	X1-X4
120/240		X2 to X3	X1-X2-X4
120		X1 to X3 X2 to X4	X1-X4

**18 PRIMARY: 240 Volts Delta**  
**SECONDARY: 208Y/120 Volts**  
**TAPS: 2, 5% BNFC**

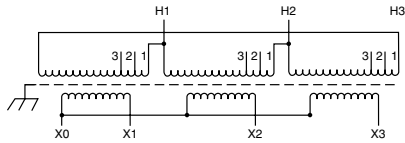

Primary Volts	Connect Primary Lines To	Inter-Connect	Connect Secondary Lines To
240	H1, H2, H3	1	
228	H1, H2, H3	2	
216	H1, H2, H3	3	
<b>Secondary Volts</b>			
208			X1, X2, X3
120 1 phase			X1 to X0 X2 to X0 X3 to X0

**16 POWER LINE CONDITIONER**

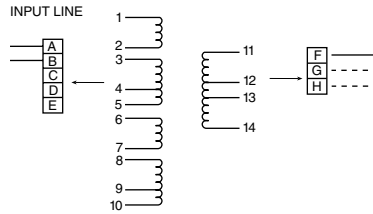

Input Connections Insulate		& Isolate
Volts	Connect	
120	1, 3, 6, 8 to A 2, 5, 7, 10 to B	4, 9
208	1, 6 to A 4, 9 to B 2, 3 to C 7, 8 to D	5, 10
240	1, 6 to A 5, 10 to B 2, 3 to C 7, 8 to D	4, 9
480	1 to A 10 to B 2, 3 to C 5, 6 to D 7, 8 to E	4, 9
Output Connections		Output Lines To
Volts	Connect	
120	11 to F 12 to G 14 to H	F, G
120/240	11 to F 12 to G 14 to H	F, G, H
208	11 to F 12 to G 13 to H	F, H
240	11 to F 12 to G 14 to H	F, H

**NOTE:** To prevent externally shorting, all leads marked "INSULATE" must be individually capped with wire nuts or equivalent. Insulate leads individually!

**19 PRIMARY: 240 Volts Delta**  
**SECONDARY: 208Y/120 Volts**  
**TAPS: 2, 2 1/2% ANFC, 2, 2 1/2% BNFC**

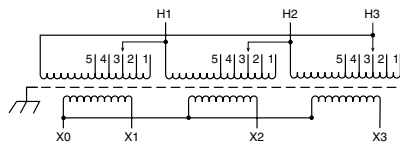

Primary Volts	Connect Primary Lines To	Inter-Connect	Connect Secondary Lines To
252	H1, H2, H3	1	
246	H1, H2, H3	2	
240	H1, H2, H3	3	
234	H1, H2, H3	4	
228	H1, H2, H3	5	
<b>Secondary Volts</b>			
208			X1, X2, X3
120 1 phase			X1 to X0 X2 to X0 X3 to X0

**17 PRIMARY: 208 Volts**  
**SECONDARY: 120/240 Volts**  
**TAPS:**

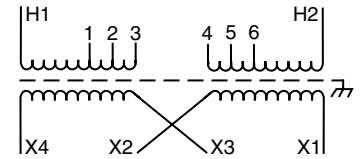

Primary Volts	Connect Primary Lines To	Inter-Connect	Connect Secondary Lines To
218	H1 & H2	3 to 4	
213	H1 & H2	2 to 4	
208	H1 & H2	3 to 5	
203	H1 & H2	2 to 5	
198	H1 & H2	1 to 5	
192	H1 & H2	2 to 6	
187	H1 & H2	1 to 6	
<b>Secondary Volts</b>			
240		X2 to X3	X1-X4
120/240		X2 to X3	X1-X2-X4
120		X1 to X3 X2 to X4	X1-X4

**20 PRIMARY: 380 Volts Delta**  
**SECONDARY: 220Y/127 Volts**  
**TAPS: 2, 2 1/2% ANFC, 4, 2 1/2% BNFC**

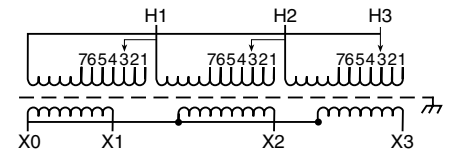

Primary Volts	Connect Primary Lines To	Inter-Connect	Connect Secondary Lines To
399	H1, H2, H3	1	
390	H1, H2, H3	2	
380	H1, H2, H3	3	
371	H1, H2, H3	4	
361	H1, H2, H3	5	
352	H1, H2, H3	6	
342	H1, H2, H3	7	
<b>Secondary Volts</b>			
220			X1, X2, X3
127 1 phase			X1 to X0 X2 to X0 X3 to X0

**21** PRIMARY: 480 Volts Delta  
SECONDARY: 208Y/120 Volts  
TAPS: 2, 5% BNFC

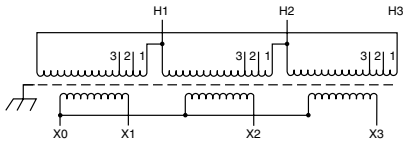

Primary Volts	Connect Primary Lines To	Inter-Connect	Connect Secondary Lines To
480	H1, H2, H3	1	
456	H1, H2, H3	2	
432	H1, H2, H3	3	
<b>Secondary Volts</b>			
208			X1, X2, X3
120 1 phase			X1 to X0 X2 to X0 X3 to X0

**24** PRIMARY: 380 Volts Delta  
SECONDARY: 220Y/127 Volts  
TAPS: 2, 5% BNFC

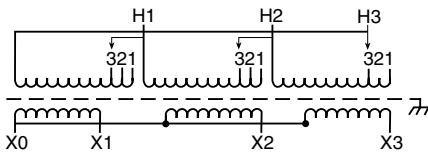

Primary Volts	Connect Primary Lines To	Inter-Connect	Connect Secondary Lines To
380	H1, H2, H3	1	
361	H1, H2, H3	2	
342	H1, H2, H3	3	
<b>Secondary Volts</b>			
220			X1, X2, X3
127 1 phase			X1 to X0 X2 to X0 X3 to X0

**27** PRIMARY: 480 Volts Delta  
SECONDARY: 240 Volts Delta/120 Volts  
TAPS: 2, 2 1/2% ANFC, 4, 2 1/2% BNFC

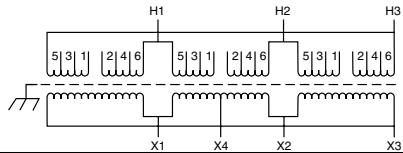

Primary Volts	Connect Primary Lines To	Inter-Connect	Connect Secondary Lines To
504	H1, H2, H3	1 to 2	
492	H1, H2, H3	2 to 3	
480	H1, H2, H3	1 to 4	
468	H1, H2, H3	3 to 4	
456	H1, H2, H3	1 to 6	
444	H1, H2, H3	3 to 6	
432	H1, H2, H3	5 to 6	
<b>Secondary Volts</b>			
240			X1, X2, X3
120			X1, X4 or X2, X4

**22** PRIMARY: 480 Volts Delta  
SECONDARY: 208Y/120 Volts  
TAPS: 2, 2 1/2% ANFC, 4, 2 1/2% BNFC

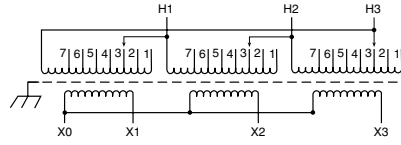

Primary Volts	Connect Primary Lines To	Inter-Connect	Connect Secondary Lines To
504	H1, H2, H3	1	
492	H1, H2, H3	2	
480	H1, H2, H3	3	
468	H1, H2, H3	4	
456	H1, H2, H3	5	
444	H1, H2, H3	6	
432	H1, H2, H3	7	
<b>Secondary Volts</b>			
208			X1, X2, X3
120 1 phase			X1 to X0 X2 to X0 X3 to X0

**25** PRIMARY: 480 Volts Delta  
SECONDARY: 240 Volts Delta/120 Volts  
TAPS: 2, 5% BNFC

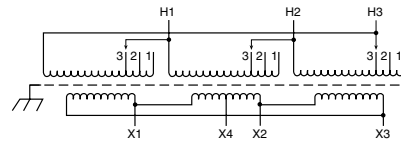

Primary Volts	Connect Primary Lines To	Inter-Connect	Connect Secondary Lines To
480	H1, H2, H3	1	
456	H1, H2, H3	2	
432	H1, H2, H3	3	
<b>Secondary Volts</b>			
240			X1, X2, X3
120			X1, X4 or X2, X4

**28** PRIMARY: 600 Volts Delta  
SECONDARY: 208Y/120 Volts  
TAPS: 2, 5% BNFC

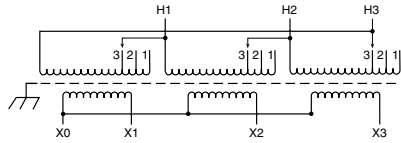

Primary Volts	Connect Primary Lines To	Inter-Connect	Connect Secondary Lines To
600	H1, H2, H3	1	
570	H1, H2, H3	2	
540	H1, H2, H3	3	
<b>Secondary Volts</b>			
208			X1, X2, X3
120 1 phase			X1 to X0 X2 to X0 X3 to X0

**23** PRIMARY: 120/208/240/277 Volts  
SECONDARY: 120/240 Volts

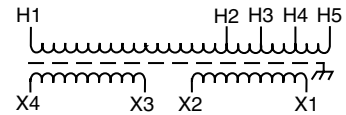

Primary Volts	Connect Primary Lines To	Inter-Connect	Connect Secondary Lines To
277	H1, H5		
240	H1, H4		
208	H1, H3		
120	H1, H2		
<b>Secondary Volts</b>			
120		X1 to X3 X2 to X4	X1-X4
120/240		X2 to X3	X1-X2-X4
240		X2 to X3	X1-X4

**26** PRIMARY: 480 Volts Delta  
SECONDARY: 240 Volts Delta/120 Volts  
TAPS: 2, 2 1/2% ANFC, 4, 2 1/2% BNFC

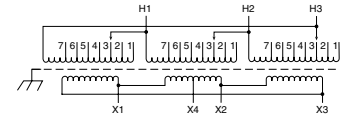

Primary Volts	Connect Primary Lines To	Inter-Connect	Connect Secondary Lines To
504	H1, H2, H3	1	
492	H1, H2, H3	2	
480	H1, H2, H3	3	
468	H1, H2, H3	4	
456	H1, H2, H3	5	
444	H1, H2, H3	6	
432	H1, H2, H3	7	
<b>Secondary Volts</b>			
240			X1, X2, X3
120			X1, X4 or X2, X4

**29** PRIMARY: 600 Volts Delta  
SECONDARY: 208Y/120 Volts  
TAPS: 2, 2 1/2% ANFC, 4, 2 1/2% BNFC

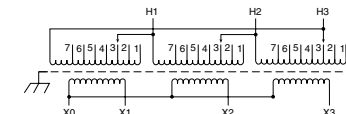

Primary Volts	Connect Primary Lines To	Inter-Connect	Connect Secondary Lines To
630	H1, H2, H3	1	
615	H1, H2, H3	2	
600	H1, H2, H3	3	
585	H1, H2, H3	4	
570	H1, H2, H3	5	
555	H1, H2, H3	6	
540	H1, H2, H3	7	
<b>Secondary Volts</b>			
208			X1, X2, X3
120 1 phase			X1 to X0 X2 to X0 X3 to X0

**30** PRIMARY: 600 Volts Delta  
SECONDARY: 208Y/120 Volts  
TAPS: 2, 2 1/2% ANFC, 4, 2 1/2% BNFC

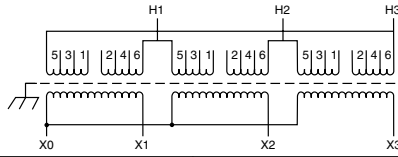

Primary Volts	Connect Primary Lines To	Inter-Connect	Connect Secondary Lines To
630	H1, H2, H3	1 to 2	
615	H1, H2, H3	2 to 3	
600	H1, H2, H3	1 to 4	
585	H1, H2, H3	3 to 4	
570	H1, H2, H3	1 to 6	
555	H1, H2, H3	3 to 6	
540	H1, H2, H3	5 to 6	

**Secondary Volts**

208			X1, X2, X3
120			X1 to X0 X2 to X0 X3 to X0
1 phase			

**31** PRIMARY: 480 Volts Delta  
SECONDARY: 480Y/277 Volts  
TAPS: 2, 2 1/2% ANFC, 4, 2 1/2% BNFC

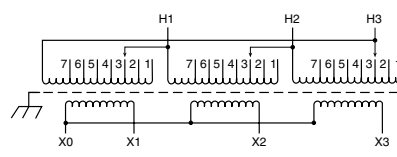

Primary Volts	Connect Primary Lines To	Inter-Connect	Connect Secondary Lines To
504	H1, H2, H3	1	
492	H1, H2, H3	2	
480	H1, H2, H3	3	
468	H1, H2, H3	4	
456	H1, H2, H3	5	
444	H1, H2, H3	6	
432	H1, H2, H3	7	

**Secondary Volts**

480			X1, X2, X3
277			X1 to X0 X2 to X0 X3 to X0
1 phase			

**32** PRIMARY: 480 Volts Delta  
SECONDARY: 480Y/277 Volts  
TAPS: 2, 2 1/2% ANFC, 4, 2 1/2% BNFC

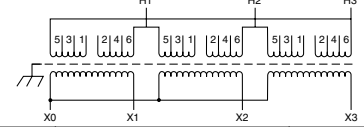

Primary Volts	Connect Primary Lines To	Inter-Connect	Connect Secondary Lines To
504	H1, H2, H3	1 to 2	
492	H1, H2, H3	2 to 3	
480	H1, H2, H3	1 to 4	
468	H1, H2, H3	3 to 4	
456	H1, H2, H3	1 to 6	
444	H1, H2, H3	3 to 6	
432	H1, H2, H3	5 to 6	

**Secondary Volts**

480			X1, X2, X3
277			X1 to X0 X2 to X0 X3 to X0
1 phase			

**33** PRIMARY: 380 Volts Delta  
SECONDARY: 208/120 Volts  
TAPS: 2-2 1/2% ANFC and BNFC

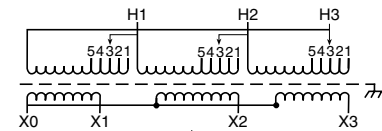

Primary Volts	Connect Primary Lines To	Inter-Connect	Connect Secondary Lines To
399	H1, H2, H3	1	
390	H1, H2, H3	2	
380	H1, H2, H3	3	
371	H1, H2, H3	4	
361	H1, H2, H3	5	

**Secondary Volts**

208			X1, X2, X3
120			X1 to X0 X2 to X0 X3 to X0
1 phase			

**34** PRIMARY: 460 Volts Delta  
SECONDARY: 460Y/266 Volts  
TAPS: 1-5% ANFC and BNFC

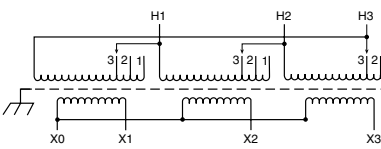

Primary Volts	%	Connect Leads to Tap No.
483	105	1
460	100	2
437	95	3

**Secondary Volts**

460		X1, X2, X3
266		X1 & X0 X2 & X0 X3 & X0
1 phase		

**35** PRIMARY: 460 Volts Delta  
SECONDARY: 460Y/266 Volts  
TAPS: 2-2 1/2% ANFC and BNFC

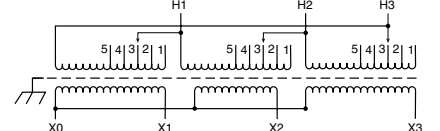

Primary Volts	%	Connect Leads to Tap No.
483	105	1
472	102.5	2
460	100	3
449	97.5	4
437	95	5

**Secondary Volts**

460		X1, X2, X3
266		X1 & X0 X2 & X0 X3 & X0
1 phase		

**36** PRIMARY: 460 Volts Delta  
SECONDARY: 460Y/266 Volts  
TAPS: 2-2 1/2% ANFC and BNFC

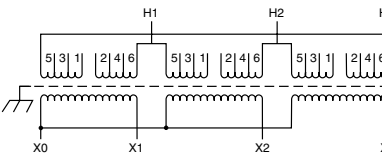

Primary Volts	%	Connect Leads to Tap No.
483	105	1 to 2
472	102.5	2 to 3
460	100	1 to 4
449	97.5	3 to 4
437	95	4 to 5

**Secondary Volts**

460		X1, X2, X3
266		X1 & X0 X2 & X0 X3 & X0
1 phase		

**37** PRIMARY: 460 Volts Delta  
SECONDARY: 230Y/133 Volts  
TAPS: 1-5% ANFC and BNFC

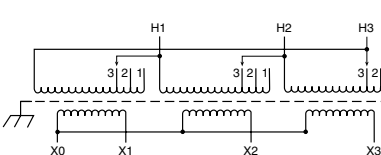

Primary Volts	%	Connect Leads to Tap No.
483	105	1
460	100	2
437	95	3

**Secondary Volts**

230		X1, X2, X3
133		X1 & X0 X2 & X0 X3 & X0
1 phase		

**38** PRIMARY: 460 Volts Delta  
SECONDARY: 230Y/133 Volts  
TAPS: 2-2 1/2% ANFC and BNFC

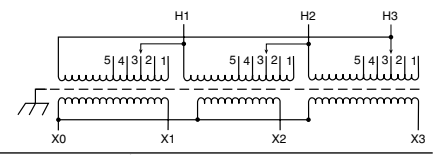

Primary Volts	%	Connect Leads to Tap No.
483	105	1
472	102.5	2
460	100	3
449	97.5	4
437	95	5

**Secondary Volts**

230		X1, X2, X3
133		X1 & X0 X2 & X0 X3 & X0
1 phase		

**39** PRIMARY: 460 Volts Delta  
SECONDARY: 230Y/133 Volts  
TAPS: 2-2 1/2% ANFC and BNFC

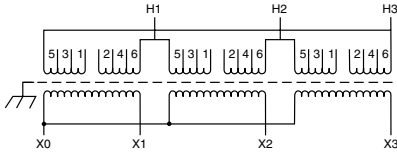

Primary Volts	%	Connect Leads to Tap No.
483	105	1 to 2
472	102.5	2 to 3
460	100	1 to 4
449	97.5	3 to 4
437	95	4 to 5

Secondary Volts		
230		X1, X2, X3
133 1 phase		X1 & X0 X2 & X0 X3 & X0

**40** PRIMARY: 575 Volts Delta  
SECONDARY: 230Y/133 Volts  
TAPS: 1-5% ANFC and BNFC

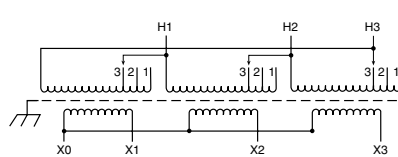

Primary Volts	%	Connect Leads to Tap No.
604	105	1
575	100	2
546	95	3

Secondary Volts		
230		X1, X2, X3
133 1 phase		X1 & X0 X2 & X0 X3 & X0

**41** PRIMARY: 575 Volts Delta  
SECONDARY: 230Y/133 Volts  
TAPS: 2-2 1/2% ANFC and BNFC

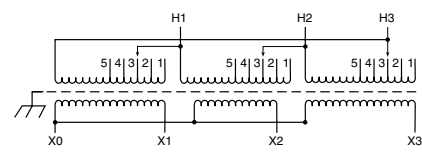

Primary Volts	%	Connect Leads to Tap No.
604	105	1
589	102.5	2
575	100	3
561	97.5	4
546	95	5

Secondary Volts		
230		X1, X2, X3
133 1 phase		X1 & X0 X2 & X0 X3 & X0

**42** PRIMARY: 575 Volts Delta  
SECONDARY: 230Y/133 Volts  
TAPS: 2-2 1/2% ANFC and BNFC

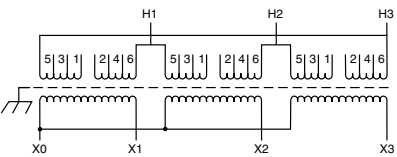

Primary Volts	%	Connect Leads to Tap No.
604	105	1 to 2
589	102.5	2 to 3
575	100	1 to 4
561	97.5	3 to 4
546	95	4 to 5

Secondary Volts		
230		X1, X2, X3
133 1 phase		X1 & X0 X2 & X0 X3 & X0

**43** PRIMARY: 575 Volts Delta  
SECONDARY: 460Y/266 Volts  
TAPS: 1-5% ANFC and BNFC

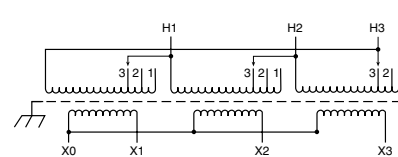

Primary Volts	%	Connect Leads to Tap No.
604	105	1
575	100	2
546	95	3

Secondary Volts		
460		X1, X2, X3
266 1 phase		X1 & X0 X2 & X0 X3 & X0

**44** PRIMARY: 575 Volts Delta  
SECONDARY: 460Y/266 Volts  
TAPS: 2-2 1/2% ANFC and BNFC

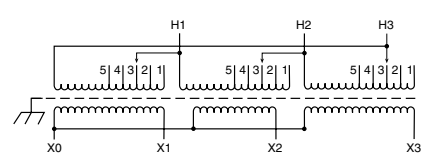

Primary Volts	%	Connect Leads to Tap No.
604	105	1
589	102.5	2
575	100	3
561	97.5	4
546	95	5

Secondary Volts		
460		X1, X2, X3
266 1 phase		X1 & X0 X2 & X0 X3 & X0

**45** PRIMARY: 575 Volts Delta  
SECONDARY: 460Y/266 Volts  
TAPS: 2-2 1/2% ANFC and BNFC

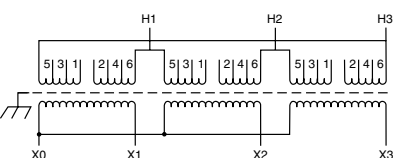

Primary Volts	%	Connect Leads to Tap No.
604	105	1 to 2
589	102.5	2 to 3
575	100	1 to 4
561	97.5	3 to 4
546	95	4 to 5

Secondary Volts		
460		X1, X2, X3
266 1 phase		X1 & X0 X2 & X0 X3 & X0

**46** PRIMARY: 208 Volts Delta  
SECONDARY: 480Y/277 Volts  
TAPS: 2, 2 1/2% ANFC, 2, 2 1/2% BNFC

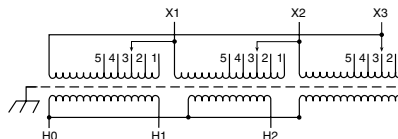

Primary Volts	Connect Primary Lines To	Inter-Connect	Connect Secondary Lines To
218	X1, X2, X3	1	
213	X1, X2, X3	2	
208	X1, X2, X3	3	
203	X1, X2, X3	4	
198	X1, X2, X3	5	

Secondary Volts		
480		H1, H2, H3
277 1 phase		H1 to H0 H2 to H0 H3 to H0

**47** PRIMARY: 416 Volts Delta  
SECONDARY: 208Y/120 Volts  
TAPS: 2, 2 1/2% ANFC, 2, 2 1/2% BNFC

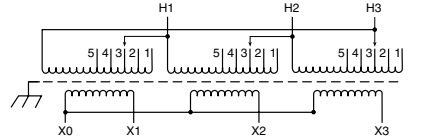

Primary Volts	Connect Primary Lines To	Inter-Connect	Connect Secondary Lines To
437	H1, H2, H3	1	
426	H1, H2, H3	2	
416	H1, H2, H3	3	
406	H1, H2, H3	4	
395	H1, H2, H3	5	

Secondary Volts		
208		X1, X2, X3
120 1 phase		X1 to X0 X2 to X0 X3 to X0



**48** PRIMARY: 208 Volts Delta  
SECONDARY: 480Y/277 Volts  
TAPS: 2, 5% BNFC

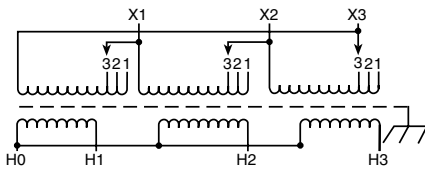

Primary Volts	Connect Primary Lines To	Inter-Connect	Connect Secondary Lines To
208	X1, X2, X3	1	
198	X1, X2, X3	2	
187	X1, X2, X3	3	

**Secondary Volts**

480			H1, H2, H3
277 1 phase			H1 to H0 H2 to H0 H3 to H0

**51** PRIMARY: 600 Volts Delta  
SECONDARY: 480Y/277 Volts  
TAPS: 2, 2 1/2% ANFC, 4, 2 1/2% BNFC

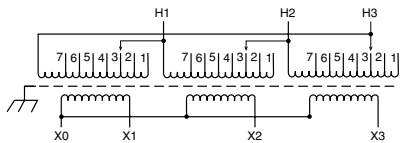

Primary Volts	Connect Primary Lines To	Inter-Connect	Connect Secondary Lines To
630	H1, H2, H3	1	
615	H1, H2, H3	2	
600	H1, H2, H3	3	
585	H1, H2, H3	4	
570	H1, H2, H3	5	
555	H1, H2, H3	6	
540	H1, H2, H3	7	

**Secondary Volts**

480			X1, X2, X3
277 1 phase			X1 to X0 X2 to X0 X3 to X0

**54** PRIMARY: 600 Volts Delta  
SECONDARY: 600Y/347 Volts  
TAPS: 2, 5% BNFC

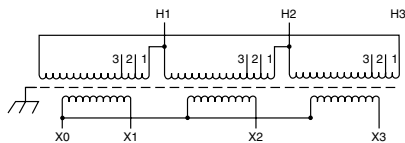

Primary Volts	Connect Primary Lines To	Inter-Connect	Connect Secondary Lines To
600	H1, H2, H3	1	
570	H1, H2, H3	2	
540	H1, H2, H3	3	

**Secondary Volts**

600			X1, X2, X3
347 1 phase			X1 to X0 X2 to X0 X3 to X0

**49** PRIMARY: 600 Volts Delta  
SECONDARY: 208Y/120 Volts  
TAPS: 2, 2 1/2% ANFC, 2, 2 1/2% BNFC

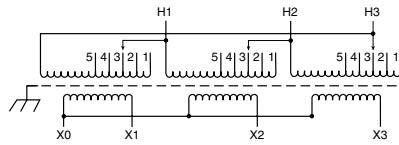

Primary Volts	Connect Primary Lines To	Inter-Connect	Connect Secondary Lines To
630	H1, H2, H3	1	
615	H1, H2, H3	2	
600	H1, H2, H3	3	
585	H1, H2, H3	4	
570	H1, H2, H3	5	

**Secondary Volts**

208			X1, X2, X3
120 1 phase			X1 to X0 X2 to X0 X3 to X0

**52** PRIMARY: 600 Volts Delta  
SECONDARY: 600Y/347 Volts  
TAPS: 2, 2 1/2% ANFC, 4, 2 1/2% BNFC

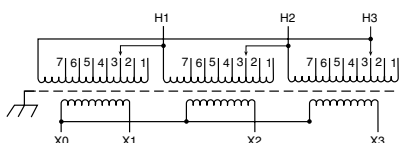

Primary Volts	Connect Primary Lines To	Inter-Connect	Connect Secondary Lines To
630	H1, H2, H3	1	
615	H1, H2, H3	2	
600	H1, H2, H3	3	
585	H1, H2, H3	4	
570	H1, H2, H3	5	
555	H1, H2, H3	6	
540	H1, H2, H3	7	

**Secondary Volts**

600			X1, X2, X3
347 1 phase			X1 to X0 X2 to X0 X3 to X0

**55** PRIMARY: 600 Volts Delta  
SECONDARY: 480Y/277 Volts  
TAPS: 2, 5% BNFC

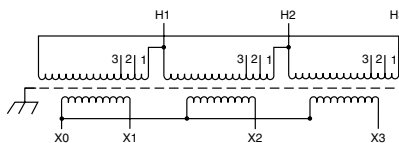

Primary Volts	Connect Primary Lines To	Inter-Connect	Connect Secondary Lines To
600	H1, H2, H3	1	
570	H1, H2, H3	2	
540	H1, H2, H3	3	

**Secondary Volts**

480			X1, X2, X3
277 1 phase			X1 to X0 X2 to X0 X3 to X0

**50** PRIMARY: 600 Volts Delta  
SECONDARY: 380Y/220 Volts  
TAPS: 2, 2 1/2% ANFC, 4, 2 1/2% BNFC

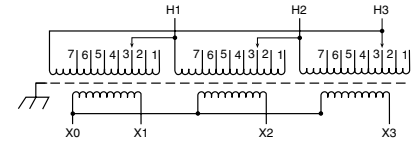

Primary Volts	Connect Primary Lines To	Inter-Connect	Connect Secondary Lines To
630	H1, H2, H3	1	
615	H1, H2, H3	2	
600	H1, H2, H3	3	
585	H1, H2, H3	4	
570	H1, H2, H3	5	
555	H1, H2, H3	6	
540	H1, H2, H3	7	

**Secondary Volts**

380			X1, X2, X3
220 1 phase			X1 to X0 X2 to X0 X3 to X0

**53** PRIMARY: 600 Volts Delta  
SECONDARY: 380Y/220 Volts  
TAPS: 2, 5% BNFC

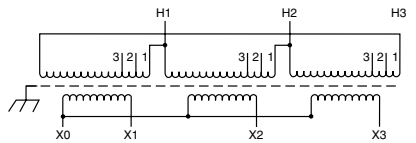

Primary Volts	Connect Primary Lines To	Inter-Connect	Connect Secondary Lines To
600	H1, H2, H3	1	
570	H1, H2, H3	2	
540	H1, H2, H3	3	

**Secondary Volts**

380			X1, X2, X3
220 1 phase			X1 to X0 X2 to X0 X3 to X0

**56** PRIMARY: 600 Volts  
SECONDARY: 480 Volts  
TAPS: 2, 5% BNFC

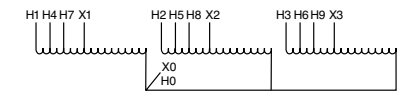

Primary Volts	Alt Rating	Connect Primary Lines To	Inter-Connect	Connect Secondary Lines To
600	480	H1, H2, H3		
570	456	H4, H5, H6		
540	432	H7, H8, H9		

**Secondary Volts**

480	380			X1, X2, X3
277 1 phase	220 1 phase			X1 to X0 X2 to X0 X3 to X0

**57** PRIMARY: 600 Volts  
SECONDARY: 480 Volts  
TAPS: 2, 5% BNFC

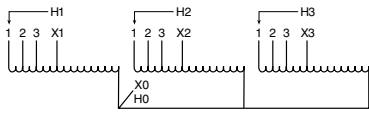

Primary Volts	Alt Rating	Connect Primary Lines To	Inter-Connect	Connect Secondary Lines To
600	480	H1, H2, H3	1	
570	456	H1, H2, H3	2	
540	432	H1, H2, H3	3	
Secondary Volts				
480	380			X1, X2, X3
277 1 phase	220 1 phase			X1 to X0 X2 to X0 X3 to X0

**60** PRIMARY: 208 Volts Delta  
SECONDARY: 208Y/120 Volts  
TAPS: 2-5% BNFC

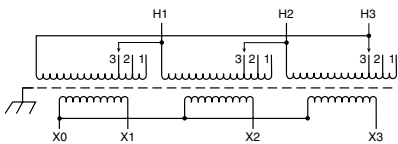

Primary Volts	%	Connect Leads to Tap No.
208	100	1
198	95	2
187	90	3
Secondary Volts		
208		X1, X2, X3
120 1 phase		X1 & X0 X2 & X0 X3 & X0

**63** PRIMARY: 120/208/240/277 Volts  
SECONDARY: 120/240 Volts

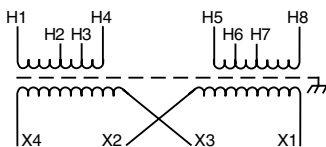

Primary Volts	Connect Primary Lines To	Inter-Connect	Connect Secondary Lines To
120	H1 & H8	H1 to H6 H3 to H8	
208	H1 & H8	H2 to H7	
240	H1 & H8	H3 to H6	
277	H1 & H8	H4 to H5	
Secondary Volts			
240		X2 to X3	X1 & X4
120/240		X2 to X3	X1, X3, X4
120		X1 to X3 X2 to X4	X1 & X4

**58** PRIMARY: 208 Volts  
SECONDARY: 120/240 Volts  
TAPS: 2, 5% BNFC

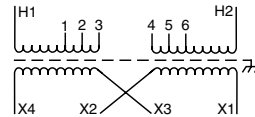

Primary Volts	Connect Primary Lines To	Inter-Connect	Connect Secondary Lines To
208	H1 & H2	3 to 4	
198	H1 & H2	2 to 5	
187	H1 & H2	1 to 6	
Secondary Volts			
240		X2 to X3	X1-X4
120/240		X2 to X3	X1-X2-X4
120		X1 to X3 X2 to X4	X1-X4

**61** PRIMARY: 208 Volts Delta  
SECONDARY: 208Y/120 Volts  
TAPS: 2-2 1/2% ANFC and 2-2 1/2% BNFC

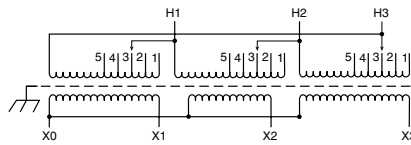

Primary Volts	%	Connect Leads to Tap No.
218	105	1
213	102.5	2
208	100	3
203	97.5	4
198	95	5
Secondary Volts		
208		X1, X2, X3
120 1 phase		X1 & X0 X2 & X0 X3 & X0

**64** PRIMARY: 190/208/220/240 x  
380/416/440/480 Volts  
SECONDARY: 120/240 Volts

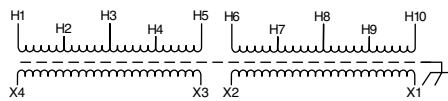

Primary Volts	Connect Primary Lines To	Inter-Connect	Connect Secondary Lines To
190	H1 & H7	H1 to H6 H2 to H7	
208	H1 & H8	H1 to H6 H3 to H8	
220	H1 & H9	H1 to H6 H4 to H9	
240	H1 & H10	H1 to H6 H5 to H10	
380	H1 & H7	H2 to H6	
416	H1 & H8	H3 to H6	
440	H1 & H9	H4 to H6	
480	H1 & H10	H5 to H6	
Secondary Volts			
240		X2 to X3	X1 - X4
120/240		X2 to X3	X1- X2 - X4
120		X1 to X3 X2 to X4	X1 - X4

**59** PRIMARY: 230 Volts Delta  
SECONDARY: 230Y/133 Volts  
TAPS: 2-2 1/2% ANFC and 2-2 1/2% BNFC

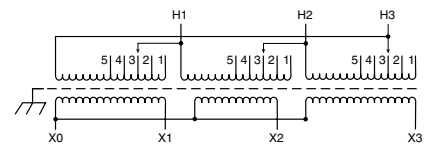

Primary Volts	%	Connect Leads to Tap No.
242	105	1
236	102.5	2
230	100	3
224	97.5	4
219	95	5
Secondary Volts		
230		X1, X2, X3
133 1 phase		X1 & X0 X2 & X0 X3 & X0

**62** PRIMARY: 230 Volts Delta  
SECONDARY: 230Y/133 Volts  
TAPS: 1-5% ANFC and 1-5% BNFC

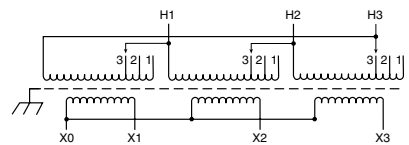

Primary Volts	%	Connect Leads to Tap No.
241	105	1
230	100	2
218	95	3
Secondary Volts		
230		X1, X2, X3
133 1 phase		X1 & X0 X2 & X0 X3 & X0

**65** PRIMARY: 190/200/208/220 x  
380/400/416/440 Volts  
SECONDARY: 110/220 Volts

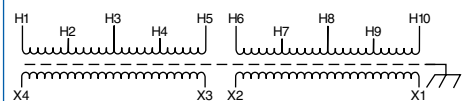

Primary Volts	Connect Primary Lines To	Inter-Connect	Connect Secondary Lines To
190	H1 & H7	H1 to H6 H2 to H7	
200	H1 & H8	H1 to H6 H3 to H8	
208	H1 & H9	H1 to H6 H4 to H9	
220	H1 & H10	H1 to H6 H5 to H10	
380	H1 & H7	H2 to H6	
400	H1 & H8	H3 to H6	
415	H1 & H9	H4 to H6	
440	H1 & H10	H5 to H6	
Secondary Volts			
220		X2 to X3	X1-X4
110/220		X2 to X3	X1-X2-X4
110		X1 to X3 X2 to X4	X1-X4

**66** PRIMARY: 416 Volts Delta  
SECONDARY: 208Y/120 Volts  
TAPS: 2, 5% BNFC

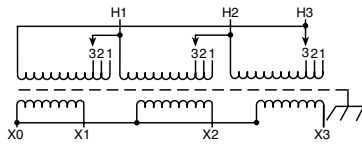

Primary Volts	Connect Primary Lines To	Inter-Connect	Connect Secondary Lines To
437	H1, H2, H3	1	
416	H1, H2, H3	2	
395	H1, H2, H3	3	

**Secondary Volts**

208		X1, X2, X3
120		X1 to X0 X2 to X0 X3 to X0
1 phase		

**69** PRIMARY: 600 Volts Delta  
SECONDARY: 240 Delta/120 Volts  
TAPS: 2, 2 1/2% ANFC, 4, 2 1/2% BNFC

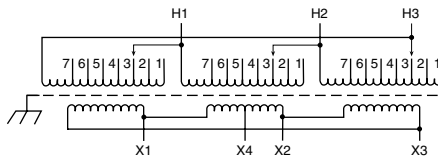

Primary Volts	%	Connect Leads to Tap No.
630	105	1
615	102.5	2
600	100	3
585	97.5	4
570	95	5
555	92.5	6
540	90	7

**Secondary Volts**

240		X1, X2, X3
120		X1, X4, or X2, X4

**72** PRIMARY: 380 Volts Delta  
SECONDARY: 208Y/120 Volts  
TAPS: 2, 2 1/2% ANFC, 4, 2 1/2% BNFC

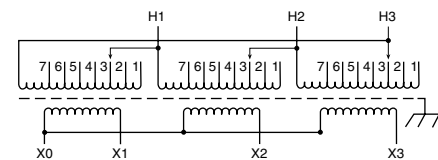

Primary Volts	%	Connect Leads to Tap No.
399	105	1
390	102.5	2
380	100	3
371	97.5	4
361	95	5
352	92.5	6
342	90	7

**Secondary Volts**

208		X1, X2, X3
120		X1 to X0 X2 to X0 X3 to X0
1 phase		

**67** PRIMARY: 480 Volts Delta  
SECONDARY: 208Y/120 Volts  
TAPS: 2-2 1/2% ANFC, 4, 2 1/2% BNFC

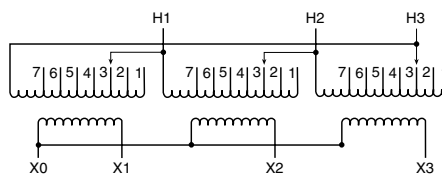

Primary Volts	Connect Primary Lines To	Inter-Connect	Connect Secondary Lines To
504	H1, H2, H3	1	
492	H1, H2, H3	2	
480	H1, H2, H3	3	
468	H1, H2, H3	4	
456	H1, H2, H3	5	
444	H1, H2, H3	6	
432	H1, H2, H3	7	

**Secondary Volts**

208		X1, X2, X3
120		X1 to X0 X2 to X0 X3 to X0
1 phase		

**70** PRIMARY: 240 Volts Delta  
SECONDARY: 480Y/277 Volts  
TAPS: 2, 5% BNFC

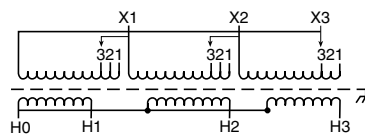

Primary Volts	%	Connect Leads to Tap No.
240	100	1
228	95	2
216	90	3

**Secondary Volts**

480		H1, H2, H3
277		H1 to H0 H2 to H0 H3 to H0
1 phase		

**73** PRIMARY: 440 Volts Delta  
SECONDARY: 220Y/127 Volts  
TAPS: 2, 5% ANFC & BNFC

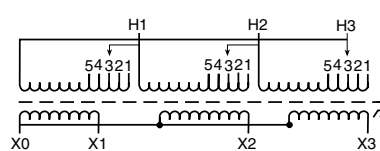

Primary Volts	%	Connect Leads to Tap No.
484	110	1
462	105	2
440	100	3
418	95	4
396	90	5

**Secondary Volts**

220		X1, X2, X3
127		X1 to X0 X2 to X0 X3 to X0
1 phase		

**68** PRIMARY: 480 Volts Delta  
SECONDARY: 240 Volts Delta/120 Volts  
TAPS: 2, 2 1/2% ANFC, 4, 2 1/2% BNFC

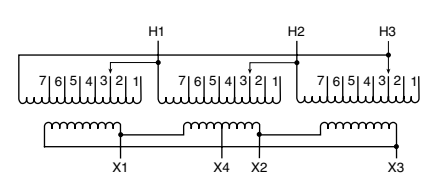

Primary Volts	Connect Primary Lines To	Inter-Connect	Connect Secondary Lines To
504	H1, H2, H3	1	
492	H1, H2, H3	2	
480	H1, H2, H3	3	
468	H1, H2, H3	4	
456	H1, H2, H3	5	
444	H1, H2, H3	6	
432	H1, H2, H3	7	

**Secondary Volts**

240		X1, X2, X3
120		X1, X4, or X2, X4

**71** PRIMARY: 240 Volts Delta  
SECONDARY: 480Y/277 Volts  
TAPS: 2, 2 1/2% ANFC & BNFC

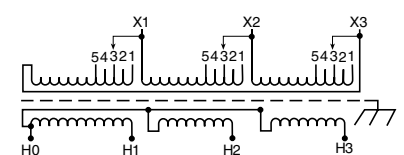

Primary Volts	Connect Primary Lines To	Inter-Connect	Connect Secondary Lines To
252	X1, X2, X3	1	
246	X1, X2, X3	2	
240	X1, X2, X3	3	
234	X1, X2, X3	4	
228	X1, X2, X3	5	

**Secondary Volts**

480		H1, H2, H3
277		H1 to H0 H2 to H0 H3 to H0
1 phase		

**74** PRIMARY: 190/200/210/220/  
230/240 Volts Delta  
SECONDARY: 400Y/231 Volts

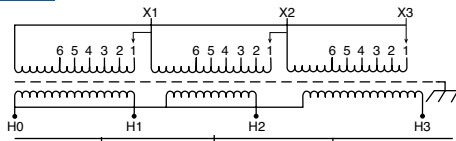

Primary Volts	Connect Primary Lines To	Inter-Connect	Connect Secondary Lines To
240	X1, X2, X3	1	
230	X1, X2, X3	2	
220	X1, X2, X3	3	
210	X1, X2, X3	4	
200	X1, X2, X3	5	
190	X1, X2, X3	6	

**Secondary Volts**

400			H1, H2, H3
231 1 phase			H1 to H0 H2 to H0 H3 to H0

**77** PRIMARY: 400 Volts Delta  
SECONDARY: 240 Delta/120 Volts  
TAPS: 2, 2 1/2% ANFC, 4, 2 1/2% BNFC

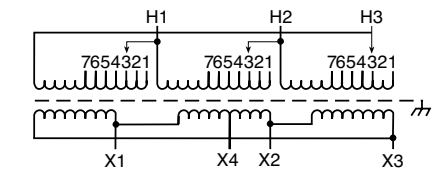

Primary Volts	Connect Primary Lines To	Inter-Connect	Connect Secondary Lines To
420	H1, H2, H3	1	
410	H1, H2, H3	2	
400	H1, H2, H3	3	
390	H1, H2, H3	4	
380	H1, H2, H3	5	
370	H1, H2, H3	6	
360	H1, H2, H3	7	

**Secondary Volts**

240			X1, X2, X3
120			X1 to X4 or X2 to X4

**80** PRIMARY: 480 Volts Delta  
SECONDARY: 208Y/120 Volts  
TAPS: 1-5% ANFC & 1-5% BNFC

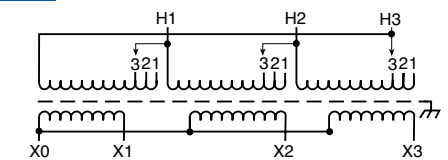

Primary Volts	Connect Primary Lines To	Inter-Connect	Connect Secondary Lines To
504	H1, H2, H3	1	
480	H1, H2, H3	2	
456	H1, H2, H3	3	

**Secondary Volts**

208			X1, X2, X3
120 1 phase			X1 to X0 X2 to X0 X3 to X0

**75** PRIMARY: 190/200/210/220/  
230/240 Volts Delta  
SECONDARY: 400Y/231 Volts

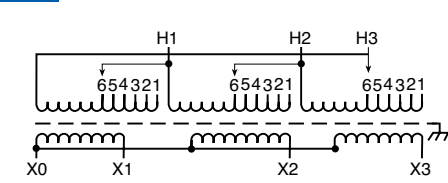

Primary Volts	Connect Primary Lines To	Inter-Connect	Connect Secondary Lines To
240	H1, H2, H3	1	
230	H1, H2, H3	2	
220	H1, H2, H3	3	
210	H1, H2, H3	4	
200	H1, H2, H3	5	
190	H1, H2, H3	6	

**Secondary Volts**

400			X1, X2, X3
231 1 phase			X1 to X0 X2 to X0 X3 to X0

**78** PRIMARY: 277/480 Volts  
SECONDARY: 208/277 Volts  
TAPS: NONE

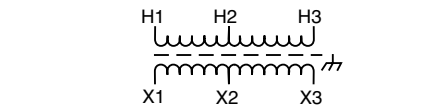

Primary Volts	Connect Primary Lines To	Inter-Connect	Connect Secondary Lines To
277	H1 & H2		
480	H1 & H3		

**Secondary Volts**

208			X1 to X2
277			X1 to X3

**81** PRIMARY: 480 Volts Delta  
SECONDARY: 208Y/120 Volts  
TAPS: 2, 2 1/2% ANFC, 2, 2 1/2% BNFC

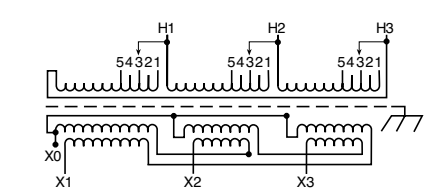

Primary Volts	Connect Primary Lines To	Inter-Connect	Connect Secondary Lines To
504	H1, H2, H3	1	
492	H1, H2, H3	2	
480	H1, H2, H3	3	
468	H1, H2, H3	4	
456	H1, H2, H3	5	

**Secondary Volts**

208			X1, X2, X3
120 1 phase			X1 to X0 X2 to X0 X3 to X0

**76** PRIMARY: 400 Volts Delta  
SECONDARY: 240 Volts Delta/120 Volts  
TAPS: 2, 5% BNFC

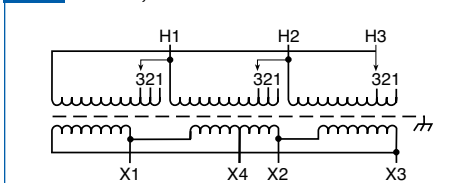

Primary Volts	Connect Primary Lines To	Inter-Connect	Connect Secondary Lines To
400	H1, H2, H3	1	
380	H1, H2, H3	2	
360	H1, H2, H3	3	

**Secondary Volts**

240			X1, X2, X3
120			X1 to X4 or X2 to X4

**79** PRIMARY: 277/480 Volts  
SECONDARY: 208/277 Volts  
TAPS: NONE

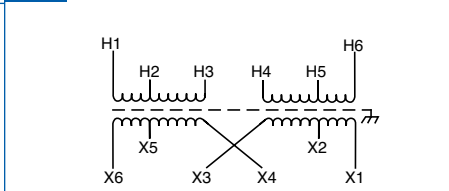

Primary Volts	Connect Primary Lines To	Inter-Connect	Connect Secondary Lines To
277	H1 - H5	H2 to H4	
480	H1 - H6	H3 to H4	

**Secondary Volts**

208		X2 to X4	X1 - X5
277		X3 to X4	X1 - X6

**82** PRIMARY: 380 Volts Delta  
SECONDARY: 208Y/120 Volts  
TAPS: 2-2 1/2% ANFC and 2-2 1/2% BNFC

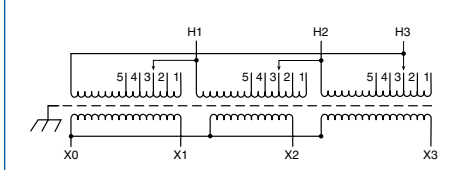

Primary Volts	%	Connect Leads to Tap No.
399	105	1
390	102.5	2
380	100	3
371	97.5	4
361	95	5

**Secondary Volts**

208		X1, X2, X3
120 1 phase		X1 to X0 X2 to X0 X3 to X0

## Wall Mounting Brackets

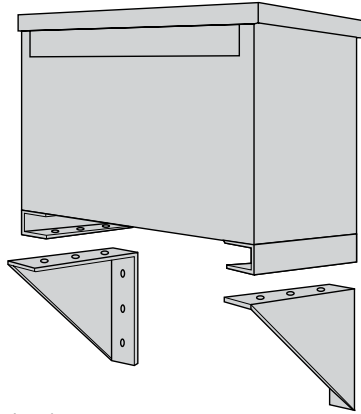

Required on:

**Ventilated Units:**

1Ø, 37.5 and 50 kVA  
3Ø, 30, 45 and 75 kVA

**Catalog Number: PL-79912**

**Encapsulated Units:**

3Ø dit., 11 kVA — 20 kVA  
3Ø std. distribution — 15 kVA

**Catalog Number: PL-79911**

Wall mounting brackets are not required on:

1Ø units — 25 kVA and below  
3Ø units — 9 kVA and below

## Standard Taps

The catalog number suffix provides tap information as outlined in chart below:

If the catalog number has no suffix, there are no taps available.

**EXAMPLE: T-2-53019-3S**

The suffix 3S indicates the unit has two 2.5% (+) ANFC taps and four 2.5% (-) BNFC taps.

Suffix	Tap Arrangement
- 1S	Two 5% (-) BNFC Taps
- 2S	One 5% (+) ANFC Tap and One 5% (-) BNFC Tap
- 3S	Two 2-1/2% (+) ANFC Taps and Four 2-1/2% (-) BNFC Taps
- 4S	Two 2-1/2% (+) ANFC Taps and Two 2-1/2% (-) BNFC Taps
- 5S	Two 5% (+) ANFC Taps and Two 5% (-) BNFC Taps

## Thermal Switch Kits

Acme Thermal Switch Kits are designed for use with single and three phase drive isolation and distribution transformers. Thermal switch kits are available for one or three sensor systems.

Thermal sensors can be field or factory installed in the transformer winding ducts to detect abnormal temperatures. The thermal sensors are a normally closed contact that opens at 200°C ± 10°C and has a current capacity of 5 amps @ 120V or 2.5 amps @ 240V. This contact can activate any number of different types of alarms or mechanisms that could warn of a potential failure.

**Catalog Number: PL-79900**

kVA	Mounting Position	Illustration
27.0 – 220.0	Bottom of the case	Figure 1
275.0 – 750	Top Flange of the Core Bracket	Figure 2

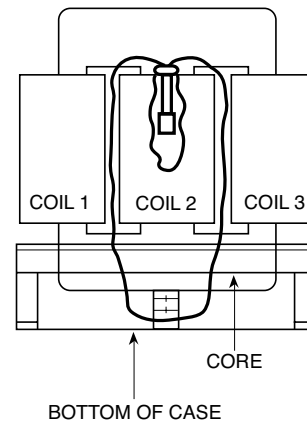

Figure 1

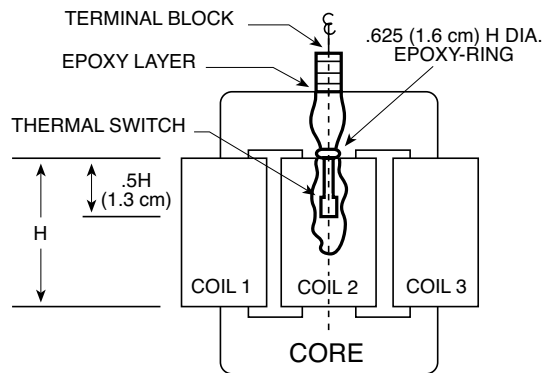

Figure 2

## Lug Kits

Acme's mechanical transformer lug kits contain all of the hardware necessary to provide satisfactory transformer terminations. Lug kits are available in sizes from 27 kVA to 660 kVA.

Acme lugs are of the dual rated single pole solderless type, made from high strength aluminum alloy. To provide the best in low contact resistance, all lugs in these kits are plated.

Catalog No.	Transformer kVA Size	Kit Contains			
		Wire Range Al or Cu	Qty	Nuts & Bolts	Qty
Lug 1	37 1/2 1-phase	2 - 14	8	1/4 - 20 x 3/4	8
	27 - 45 3-phase	250 mcm - 6	4		
Lug 2	50 - 75 1-phase	250 mcm - 6	12	1/4 - 20 x 3/4	8
	51 - 118 3-phase			1/4 - 20 x 1 3/4	8
Lug 3	100 - 167 1-phase	250 mcm - 6	3	1/4 - 20 x 3/4	3
	145 - 300 3-phase	600 mcm - 2	22	3/8 - 16 x 2	16
Lug 4	440 - 660 3-phase	600 mcm - 2	29	3/8 - 16 x 2	8

## Weather Shields

Catalog No.	Approx. Ship Weight Lbs. (Kg.)
WSA1	6 (2.7)
WSA2	7 (3.2)
WSA3	8 (3.6)
WSA4	8 (3.6)
WSA5	10 (4.5)
WSA6	10 (4.5)
WSA8	7 (3.2)
WSB3	30 (13.6)
WSB4	32 (14.5)

## Spare Parts

### TOP COVER

CATALOG NO.	APPROX. SHIP WEIGHT Lbs. (Kg.)
SA1701319	14 (6.4)
SA2701319	16 (7.3)
SA3701319	20 (9.1)
SA4701319	34 (15.4)
SA6701319	17 (7.7)

### FRONT/REAR PANEL

CATALOG NO.	APPROX. SHIP WEIGHT Lbs. (Kg.)
SA1701321	13 (5.9)
SA2701321	15 (6.8)
SA3701321	21 (9.5)
SA4701321	35 (15.9)
SA7701321	16 (7.3)

### SIDE PANEL

CATALOG NO.	APPROX. SHIP WEIGHT Lbs. (Kg.)
SA1701320	11 (5.0)
SA2701320	13 (5.9)
SA3701320	19 (8.6)
SA4701320	34 (15.4)

## Specification Guide for Dry Type Distribution Transformers

### 1.0 Dry Type Transformers:

- 1.0.0** The following information should be utilized only by trained technical personnel. If you need assistance, please contact Acme's Technical Services Department at 800-334-5214.
- 1.0.1** Provide dry type, enclosed and ventilated transformers as indicated herein. Transformers shall be Acme or approved equal.
- 1.0.2** Transformers shall be designed, constructed and rated in accordance with UL, CSA, NEMA, ANSI, IEEE, and OSHA standards.
- 1.0.3** Transformers rated 27 kVA and larger, single and three phase shall be the ventilated type, incorporating a 220 degree C insulation system and designed not to exceed 150 degree C temperature rise above a 40 degree C ambient under full load conditions. Taps are to be provided on the primary side of the transformer as follows:
- (a) 2 - 2.5% above normal full capacity.  
4 - 2.5% below normal full capacity.  
-or-
  - (b) 2 - 2.5% above normal full capacity.  
2 - 2.5% below normal full capacity.
- Alternate 1:** 115 degree C rise transformers shall incorporate a 220 degree C insulation system and be designed not to exceed 115 degree C temperature rise above a 40 degree C ambient under full load conditions. In addition, the transformer shall have the ability to carry a continuous 15% overload without exceeding a 150 degree C rise above ambient.
- Alternate 2:** 80 degree C rise Transformers shall incorporate a 220 degree C insulation system and be designed not to exceed 80 degree C temperature rise above a 40 degree C ambient under full load conditions. In addition, the transformer shall have the ability to carry a continuous 30% overload without exceeding a 150 degree C rise above ambient.
- 1.0.4** Transformer enclosure finish must be ASA 61 gray powder polyurethane paint. Transformer enclosure temperature shall not exceed 50 degrees C plus the ambient under any condition of loading at any specified temperature rise at or below 150 degrees C.
- 1.0.5** Transformer enclosure shall be UL/NEMA Type 2 and UL 3R Listed with the addition of a weather shield and shall be so marked on the transformer.
- 1.0.6** Transformer shall incorporate an electrostatic shield for the attenuation of voltage spikes, line noise, and transients.
- 1.0.7** Single phase transformers and three phase transformers terminate in copper or aluminum bus bar.
- 1.0.8** Transformer coils designed and manufactured for increased insulation life, cooler operation, and lower losses.
- 1.0.9** Transformers must operate at audible sound levels below NEMA Standard ST-20. Sound levels will not exceed the following:
- |               |       |
|---------------|-------|
| 30 - 50 kVA   | 45 db |
| 51 - 150 kVA  | 50 db |
| 151 - 300 kVA | 55 db |
| 301 - 500 kVA | 60 db |
| 501 - 750 kVA | 65 db |
- Transformers must incorporate vibration isolation pads in their construction located between the transformer core and coil assembly and the transformer case. External vibration isolation pads will not be used as they tend to increase audible noise. Transformers shall be floor mounted on a concrete pad. All connections to the transformer will be made by means of flexible metallic conduit.
- 1.0.10** Transformer enclosure shall be grounded per the National Electric Code.
- 1.0.11** Transformers shall be dry-type 600 volt class, kVA rating as indicated. Contractor to provide all necessary lugs for all transformers.
- 1.0.12** Complete shop drawings must be submitted for approval on all dry type transformers.
- 1.0.13** Typical performance data must be submitted for approval on all transformers. Factory tests must be made in accordance with the latest revisions of ANSI Test Code C57.12.91 for Dry Type Transformers. Performance data provided must contain but not be limited to:
- (a) No load losses.
  - (b) Full load losses.
  - (c) Polarity and phase rotation.
  - (d) Impedance at reference temperature.
  - (e) Efficiencies at 25, 50, 75, and 100% load.
  - (f) Regulation at 100% and 80% power factor.
  - (g) Audible sound level.
  - (h) Dimensions and weight.
  - (i) Applied potential test.
  - (j) Induced potential test.
  - (k) Excitation current.
  - (l) IR, IX, and IZ percentages.
  - (m) Reference and ambient temperature.
- 1.0.14** Warranty: Transformers must be warranted against defects in materials, workmanship, and performance for ten years from date of manufacture.

## Specification Guide for Single & Three Phase Encapsulated Transformers

### 1.0 Dry Type Transformers:

**1.0.0** The following information should be utilized only by trained technical personnel. If you need assistance, please contact Acme's Technical Services Department at 800-334-5214.

**1.0.1** Provide dry type, enclosed, epoxy encapsulated transformers as indicated and specified herein. Transformers must be Acme or approved equal.

**1.0.2** Transformers must be designed, constructed and rated in accordance with UL, CSA, NEMA, ANSI, IEEE, and OSHA standards.

**1.0.3** Transformers 3.0 - 75 kVA shall be compound filled, incorporating a 180 degree C insulation system and designed not to exceed a 115 degree C temperature rise above a 40 degree C ambient under full load conditions. Taps are to be provided on the primary side of the transformer. The catalog number suffix will provide the tap information outlined below:

#### SUFFIX TAP ARRANGEMENT

- 1S	2-5% BNFC
- 2S	1-5% ANFC & 1-5% BNFC
- 3S	2-2.5% ANFC & 4-2.5% BNFC
- 4S	2-2.5% ANFC & 2-2.5% BNFC
- 5S	2-5% ANFC & 2-5% BNFC

**1.0.4** Transformer enclosure finish must be ASA 61 gray powder polyurethane paint.

**1.0.5** Transformer enclosure temperature shall not exceed 65 degrees C plus the ambient.

**1.0.6** Transformer enclosure shall be UL/NEMA Type 3R and so marked on the transformer.

**1.0.7** Transformer shall incorporate an electrostatic shield for the attenuation of voltage spikes, line noise and transients.

**1.0.8** Transformer coils are typically wound with aluminum or copper for increased insulation life, cooler operation and lower losses.

**1.0.9** All primary tap connections and both primary and secondary phase conductors must be either copper wire or copper bus bar.

**1.0.10** Transformers must operate at audible sound levels below ANSI/NEMA Standard ST-20. Sound levels will not exceed the following:

Up to 9 kVA	40 db
10 - 50 kVA	45 db
51 - 150 kVA	50 db

**1.0.11** Transformer enclosures shall be grounded per the National Electric Code.

**1.0.12** Complete shop drawings must be submitted for approval on all Dry Type Transformers.

**1.0.13** Typical performance data must be submitted for approval on all transformers. Factory tests must be made in accordance with the latest revisions of ANSI Test Code C57.12.91 for Dry Type Transformers. Performance data must contain but not be limited to:

- (a) No load losses.
- (b) Full load losses.
- (c) Polarity and phase rotation.
- (d) Impedance at reference temperature.
- (e) Efficiencies at 25, 75, and 100% load.
- (f) Regulation at 100% and 80% power factor.
- (g) Audible sound level.
- (h) Insulation class and rated temperature rise.
- (i) Dimensions and weight.
- (j) Applied potential test.
- (k) Induced potential test.
- (l) Excitation current.
- (m) IR, IX, and IZ percentages.
- (n) Reference and ambient temperature.

**1.0.14** Warranty: Transformer must be warranted against defects in materials, workmanship and performance for ten years from date of manufacture.



## Specification Guide for Non-Linear Load Isolation® Transformers

### 1.0 Dry Type Transformers:

- 1.0.0** The following information should be utilized only by trained technical personnel. If you need assistance, please contact Acme's Technical Services Department at 800-334-5214.
- 1.0.1** Provide dry type, enclosed, and ventilated transformers as indicated and specified herein. Transformers must be Acme or approved equal. Transformers must be UL listed for non-sinusoidal current loads of a specified K Factor (UL Standard 1561), CSA certified and labeled as such.
- 1.0.2** For sizes 15 kVA and larger, low voltage dry transformers will be ventilated type, incorporating a 220 degree C insulation system and designed not to exceed 150 degree C temperature rise above a 40 degree C ambient under full load conditions. Taps will be provided on the primary side of the transformer. There will be 2, 2.5% taps above normal full capacity and 4, 2.5% taps below normal full capacity.
- Alternate 1:** 115 degree C rise Transformers shall incorporate a 220 degree C insulation system and be designed not to exceed 80 degree C temperature rise above a 40 degree C ambient under full load conditions. In addition, the transformer shall have the ability to carry a continuous 15% overload without exceeding a 150 degree C rise above ambient.
- Alternate 2:** 80 degree C rise Transformers shall incorporate a 220 degree C insulation system and be designed not to exceed 80 degree C temperature rise above a 40 degree C ambient under full load conditions. In addition, the transformer shall have the ability to carry a continuous 30% overload without exceeding a 150 degree C rise above ambient.
- 1.0.3** Transformers shall incorporate an electrostatic shield for the attenuation of voltage spikes, line noise, and transients.
- 1.0.4** Transformers must be designed to handle non-linear loads and the adverse effects of harmonics. Transformer coils will be wound with foil to minimize the heating effects caused by harmonic currents.
- 1.0.5** Transformers must be able to power non-linear loads with a K-Factor as high as 20.
- 1.0.6** Transformers must operate at audible sound levels below NEMA ST-20. Sound levels will not exceed the following:
- |               |        |
|---------------|--------|
| 30 - 50 kVA   | 45 db* |
| 51 - 150 kVA  | 50 db* |
| 151 - 300 kVA | 55 db* |
| 301 - 500 kVA | 60 db* |
- 1.0.7** Enclosed, ventilated transformers must incorporate vibration dampening pads in their construction, located between the transformer core and coil assembly and the transformer case. External vibration dampening pads will not be used on enclosed, ventilated designs as they tend to increase audible noise. Transformers 15 kVA and larger shall be floor mounted on a concrete pad. All connections to the transformer will be made by means of flexible metallic conduit.
- 1.0.7** Transformers shall incorporate a neutral conductor sized at 2 times rated phase current. Transformer cases shall be grounded per the National Electric Code.
- 1.0.8** Transformers shall be 60 Hz, 480 or 600 volts delta primary, 208Y/120 volt secondary. kVA rating as indicated. Contractor to provide all necessary lugs for all transformers. Transformer enclosures shall be Type 2 and UL-3R listed with the addition of a weather shield.
- 1.0.9** Complete shop drawings must be submitted for approval on all dry type transformers.
- 1.0.10** Typical performance data must be submitted for approval on all transformers. Factory tests must be made in accordance with the latest revisions of ANSI Test Code C57.12.91 for Dry Type Transformers. Performance data must contain but not be limited to:
- (a) No load losses.
  - (b) Full load losses.
  - (c) Polarity and phase rotation.
  - (d) Impedance at reference temperature.
  - (e) Efficiencies at 25, 75, 50 and 100% load.
  - (f) Regulation at 100% and 80% power factor.
  - (g) Audible sound level.
  - (h) Insulation class and rated temperature rise.
  - (i) Dimensions and weight.
  - (j) Applied potential test.
  - (k) Induced potential test.
  - (l) Excitation current.
  - (m) IR, IX, and IZ percentages.
  - (n) Reference and ambient temperature.
- 1.0.11** Warranty: Transformers must be warranted against defects in materials, workmanship and performance for ten years from date of manufacture.

\* Sound levels are based on transformers with a K-Factor of 4 and a temperature rise of 150 degrees centigrade.

## Specification Guide for Drive Isolation Transformers

### 1.0 Dry Type Transformers:

**1.0.0** The following information should be utilized only by trained technical personnel. If you need assistance, please contact Acme's Technical Services Department at 800-334-5214.

**1.0.1** Provide dry type, enclosed, epoxy encapsulated transformers as indicated and specified herein. Transformers shall be designed for use with AC/DC Drive applications and labeled as such.

**1.0.2** Transformers shall be designed, constructed and rated in accordance with UL, CSA, NEMA, ANSI, IEEE, and OSHA standards.

**1.0.3** Transformers 7.5 - 20 kVA shall be three phase, compound filled, incorporating a 180 degree C insulation system and designed not to exceed a 115 degree C temperature rise above a 40 degree C ambient under full load conditions. Taps are provided on the primary side of the transformer as follows:

(a) 1-5% above normal full capacity.

(b) 1-5% below normal full capacity.

Transformers 27 - 750 kVA shall be the ventilated type, incorporating a 220 degree C insulation system and designed not to exceed a 150 degree C temperature rise above a 40 degree C maximum ambient under full load conditions. Taps are to be provided on the primary side of the transformer as follows:

(a) 2 - 2.5% above normal full capacity.

(b) 2 - 2.5% below normal full capacity.

**Alternate 1:** 115 degree C rise transformers shall incorporate a 220 degree C insulation system and be designed not to exceed a 115 degree C temperature rise above a 40 degree C maximum ambient under full load conditions.

**Alternate 2:** 80 degree C rise transformers shall incorporate a 220 degree C insulation system and be designed not to exceed 80 degree C temperature rise above a 40 degree C maximum ambient under full load conditions.

**1.0.4** Transformer enclosure finish must be ASA 61 gray powder polyurethane paint. Ventilated transformer enclosure temperature shall not exceed 50 degrees C plus the ambient. Compound filled transformer enclosure temperature shall not exceed 65 degrees C, plus the ambient.

**1.0.5** Compound filled transformer enclosure shall be UL/NEMA Type 3R and so marked on the transformer (7.5 - 20 kVA). No weather shield is required. Ventilated transformer enclosure shall be UL/NEMA Type 2 and UL-3R listed with the addition of a weather shield and shall be so marked on the transformer (27 - 750 kVA).

**1.0.6** Transformers shall incorporate an electrostatic shield for the attenuation of voltage spikes, line noise, and transients.

**1.0.7** Transformers up to 220 kVA shall terminate in copper bus bar or copper wire.

**1.0.8** Transformer coils must be wound with aluminum strip conductors for increased insulation life, cooler operation and lower losses.

**1.0.9** Transformers must operate at audible sound levels below NEMA standard ST-20. Sound levels will not exceed the following:

up to 9kVA 40 db

10 - 50 kVA 45 db

51 - 150 kVA 50 db

151 - 300 kVA 55 db

301 - 500 kVA 60 db

501 - 750 kVA 65 db

Transformers must incorporate vibration isolation pads in their construction located between the transformer core and coil assembly and the transformer case, (27 - 750 kVA).

External vibration pads should not be used as they tend to increase audible noise. Transformers shall be floor mounted on a concrete pad. All connections to the transformer will be made by means of flexible metallic conduit.

**1.0.10** Transformer enclosure shall be grounded per the National Electrical Code.

**1.0.11** Transformer voltages shall be as follows:

(a) 460 Delta - 460Y/266

(b) 460 Delta - 230Y/133

(c) 575 Delta - 230Y/133

(d) 575 Delta - 460Y/266

(e) 230 Delta-230Y/133

(f) Other

Transformer shall be 60 Hz. kVA rating as indicated. Contractor to provide all necessary lugs for all transformers.

**1.0.12** Complete shop drawings must be submitted for approval on all dry type transformers.

**1.0.13** Typical performance data must be submitted for approval on all transformers. Factory tests must be made in accordance with the latest revisions of ANSI Test Code C57.12.91 for Dry Type Transformers. Performance data provided must contain, but not be limited to:

(a) No load losses.

(b) Full load losses.

(c) Polarity and phase rotation.

(d) Impedance at reference temperature.

(e) Efficiencies at 25, 75, 50 and 100% load.

(f) Regulation at 100% and 80% power factor.

(g) Audible sound level.

(h) Insulation class and rated temperature rise.

(i) Dimensions and weight.

(j) Applied potential test.

(k) Induced potential test.

(l) Excitation current.

(m) IR, IX, and IZ percentages.

(n) Reference and ambient temperature.

**1.0.14** Warranty: Transformers must be warranted against defects in materials, workmanship and performance for ten years from date of manufacture.

# Transformer Industry Standards

Underwriters' Laboratories, Inc. is an independent not for profit organization which tests products for safety.

Acme's transformers are designed and manufactured to comply with UL Standard 506, 1561, 1012, or 1062 and carry the applicable UL Listing Label. Because of the continuous product evolutions at Acme, it is best that you contact the factory for the current file and guide numbers associated with the listings.

The Canadian Standards Association is the Canadian counterpart to Underwriters' Laboratories. Acme's transformers are also constructed and rated to comply with

CSA Standards C22.2-47 and C22.2-66 and carry the CSA Certification Label.

All of Acme's transformers are manufactured to meet National Electrical Code requirements.

Other Agencies and Standards:

National Electrical Manufacturers Association (NEMA)

ST-20 1992 (R1978)

American National Standards Institute (ANSI)

OSHA

IEEE

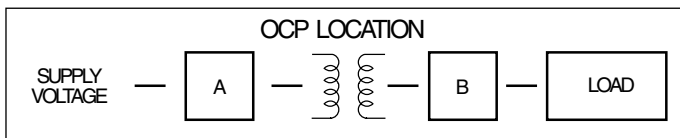

## How to overcurrent protect (OCP) 600 volt class transformers and associated wiring

... in accordance with the '99 National Electric Code (Articles 450-3(b) and 240-3 (i))

Case	Type of Supply Voltage	Phase	Number of Wires on Secondary	Protection Required	OCP Location	Primary		Secondary	
						Current (AMPS)	OCP (% of rating)	Current (AMPS)	OCP (% of rating)
1	Main	1Ø	2	Primary Only	A	≥9 <9, ≥2 <2	125 ① 167 max. 300 max.	Not Required	
2	Main	1Ø 3Ø	More than 2 Not Applicable	Primary & Secondary ②	A & B	≥9 <9, ≥2 <2	125 ① 167 max. 300 max.	≥9 <9	125 ① 167 max.
3	Feeder Circuit with OCP	1Ø	2	None on Either	—		Not Required	Not Required	
4	Feeder Circuit with OCP	1Ø 3Ø	More than 2 Not Applicable	Secondary Only ②	B		Not Required	9 <9	125 ① 167 max.

## Acme® Transformer™ Products vs. U/L Insulation Systems & U/L Standards

Acme Construction Style	Acme Catalog Product Name	U/L Standard	U/L Product Category	U/L File Number	U/L Listed Control #	U/L Insulation Number	Insulation System Temp./C	kVA Single Phase	kVA Three Phase
Enclosed	General Purpose and Buck-Boost	506	XPTQ	E79947V1	50B8	B3223	130	.050-150	N/A
Compound Filled (Encapsulated)	General Purpose Buck-Boost & DIT	506	XPTQ	E79947V1	50B8	X3221 H3221	155 180	.25-5.0 7.5-25.0	3.0-6.0 7.5-75.0
	Panel Tran®	1062	YEFR	E56936V1	N/A	H3180 H3221	180 180	5.0 7.5-25.0	N/A 9.0-30.0
	Swim Pool & Spa	379	HDGV	E111069V1	N/A	H3180	180	0.10-.30	N/A
	Hardwired CVR	1012	QQFU	E86492V1	6B81	B3223 X3221	130 155	.25-3.0 5.0-15.0	N/A N/A
	Portable PLC	1012	QQFU	E86492V1	60B1	B3223	130	.25-2.0	N/A
Open Core & Coil	Industrial Control	506	XPTQ	E79947V1	50B8	B3223	130	.050-5.0	N/A
Air Cooled Ventilated & Non Ventilated	General Purpose Opti-Miser® & DIT	1561	XQNX	E12547V3	542B	C3222	220	37.5-250.0	25-1000
Enclosed	Air Conditioning and Refrigeration Appliance	NONE	NONE	NONE	N/A	NONE	130	.085-2.0	N/A

① % of rated current (or next higher standard rating).

② In cases where the secondary is overcurrent protected, the primary overcurrent protection rating can be no more than 250% (2.5 times) full load amps (shown on above chart). For example, if a 10 kVA, single phase transformer has a 480V primary and a 120/240 secondary, and the secondary is overcurrent protected, maximum primary overcurrent protection rating is 20.8 amps (full load current) x 2.5 (250%) = 52. Therefore, use a standard 50 amp fuse or breaker selected from NEC Section 240-6 (below).

**Section 240-6 of the 1999 National Electrical Code.** The standard ampere ratings for fuses and inverse time circuit breakers shall be considered 15, 20, 25, 30, 35, 40, 45, 50, 60, 70, 80, 90, 100, 110, 125, 150, 175, 200, 225, 250, 300, 350, 400, 450, 500, 600, 700, 800, 1000, 1200, 1600, 2000, 2500, 3000, 4000, 5000 and 6000 amperes. **Exception:** Additional standard ratings for fuses shall be considered 1, 3, 6, 10, and 601. "Extracted by permission from ANSI/NFPA 70-1999, National Electrical Code®, Copyright®, 1999, National Fire Protection Association, Boston, MA."

**Acme Electric—Power Distribution Products Division has never used polychlorinated biphenyls (PCBs) in the manufacture of our quality products.**

## Alphanumerical Catalog Number Index

This alphanumerical listing of catalog numbers has been prepared to help you locate the appropriate page, when only

the catalog number is known. It is arranged in alphanumerical order according to the first letter of the catalog number.

CATALOG NO.	PAGE NO.	CATALOG NO.	PAGE NO.	CATALOG NO.	PAGE NO.	CATALOG NO.	PAGE NO.
AE010050.....	70	ALRB025TBC.....	50	CE030075.....	72	DTGA0142S.....	46
AE010075.....	70	ALRB027TBC.....	50	CE030100.....	72	DTGA01454S.....	46
AE010100.....	70	ALRB035TBC.....	50	CE030150.....	72	DTGA01754S.....	46
AE010150.....	70	ALRB045TBC.....	50	CE030250.....	72	DTGA0202S.....	46
AE010250.....	70	ALRB055TBC.....	50	CE030350.....	72	DTGA02204S.....	46
AE010350.....	70	ALRB080TBC.....	50	CE030500.....	72	DTGA0274S.....	46
AE010500.....	70	ALRB110CBC.....	50	CE030750.....	72	DTGA03304S.....	46
AE020050.....	70	ALRB130CBC.....	50	CE040050.....	73	DTGA0344S.....	46
AE020075.....	70	ALRB160CBC.....	50	CE040100.....	73	DTGA0404S.....	46
AE020100.....	70	ALRB200CBC.....	50	CE040150.....	73	DTGA0514S.....	46
AE020150.....	70	ALRB250CBC.....	50	CE040250.....	73	DTGA0634S.....	46
AE020250.....	70	ALRB300CBC.....	50	CE040350.....	73	DTGA0754S.....	46
AE020300.....	70	ALRB360CBC.....	50	CE040500.....	73	DTGA0934S.....	46
AE020350.....	70	ALRB420CBC.....	50	CE040750.....	73	DTGA72S.....	46
AE020500.....	70	ALRB480CBC.....	50	CE050050.....	73	DTGB002754S.....	46
AE020750.....	70	ALRC002TBC.....	50	CE050150.....	73	DTGB008804S.....	46
AE030050.....	70	ALRC003TBC.....	50	CE050250.....	73	DTGB0112S.....	46
AE030075.....	70	ALRC004TBC.....	50	CE050350.....	73	DTGB01184S.....	46
AE030100.....	70	ALRC006TBC.....	50	CE050500.....	73	DTGB0142S.....	46
AE030150.....	70	ALRC008TBC.....	50	CE050750.....	73	DTGB01454S.....	46
AE030250.....	70	ALRC012TBC.....	50	CE060050.....	73	DTGB01754S.....	46
AE030350.....	70	ALRC016TBC.....	50	CE060075.....	73	DTGB0202S.....	46
AE030500.....	70	ALRC025TBC.....	50	CE060100.....	73	DTGB02204S.....	46
AE030750.....	70	ALRC027TBC.....	50	CE060150.....	73	DTGB0274S.....	46
AE060050.....	71	ALRC035TBC.....	50	CE060250.....	73	DTGB03304S.....	46
AE060075.....	71	ALRC045TBC.....	50	CE060300.....	73	DTGB0344S.....	46
AE060100.....	71	ALRC055TBC.....	50	CE060350.....	73	DTGB0404S.....	46
AE060150.....	71	ALRC080TBC.....	50	CE060500.....	73	DTGB04404S.....	46
AE060250.....	71	ALRC110CBC.....	50	CE060750.....	73	DTGB0514S.....	46
AE060350.....	71	ALRC130CBC.....	50	CMT533124S.....	35	DTGB05504S.....	46
AE060500.....	71	ALRC160CBC.....	50	CMT533134S.....	35	DTGB0634S.....	46
AE060750.....	71	ALRC200CBC.....	50	CMT533144S.....	35	DTGB06604S.....	46
AE070050.....	71	ALRC250CBC.....	50	CMT533154S.....	35	DTGB0754S.....	46
AE070100.....	71	ALRC300CBC.....	50	CMT533164S.....	35	DTGB07704S.....	46
AE070150.....	71	ALRC360CBC.....	50	CMT533174S.....	35	DTGB0934S.....	46
AE070250.....	71	ALRC420CBC.....	50	DTFA0112S.....	47	DTGB72S.....	46
AE070350.....	71	ALRC480CBC.....	50	DTFA01184S.....	47	DTGB9902S.....	46
AE070500.....	71	ALRC600CBC.....	50	DTFA0142S.....	47	DTHA002754S.....	46
AE070750.....	71	CE010050.....	72	DTFA01454S.....	47	DTHA0112S.....	46
AE120050.....	71	CE010075.....	72	DTFA01754S.....	47	DTHA01184S.....	46
AE120100.....	71	CE010100.....	72	DTFA0202S.....	47	DTHA0142S.....	46
AE120150.....	71	CE010150.....	72	DTFA02204S.....	47	DTHA01454S.....	46
AE120250.....	71	CE010250.....	72	DTFA0274S.....	47	DTHA0202S.....	46
AE120350.....	71	CE010350.....	72	DTFA0344S.....	47	DTHA0274S.....	46
AE120500.....	71	CE010500.....	72	DTFA0404S.....	47	DTHA03304S.....	46
AE120750.....	71	CE020050.....	72	DTFA0514S.....	47	DTHA0344S.....	46
ALRB002TBC.....	50	CE020100.....	72	DTFA0634S.....	47	DTHA0404S.....	46
ALRB003TBC.....	50	CE020150.....	72	DTFA0754S.....	47	DTHA0514S.....	46
ALRB004TBC.....	50	CE020250.....	72	DTFA0934S.....	47	DTHA0634S.....	46
ALRB006TBC.....	50	CE020350.....	72	DTFA72S.....	47	DTHA0754S.....	46
ALRB008TBC.....	50	CE020500.....	72	DTGA002754S.....	46	DTHA0934S.....	46
ALRB012TBC.....	50	CE020750.....	72	DTGA0112S.....	46	DTHA72S.....	46
ALRB016TBC.....	50	CE030050.....	72	DTGA01184S.....	46	DTHB002754S.....	46

CATALOG NO.	PAGE NO.	CATALOG NO.	PAGE NO.	CATALOG NO.	PAGE NO.	CATALOG NO.	PAGE NO.
DTHB006604S	46	LUG1	134	PTBA3150015SS	99	T179624S	84
DTHB0112S	46	LUG2	134	PTBA3150022LS	99	T179625S	84
DTHB01184S	46	LUG3	134	PTBA3150022SS	99	T179629S	84
DTHB0142S	46	LUG4	134	PTBA3150030LS	99	T179630S	84
DTHB01454S	46	PL112600	64	PTBA3150030SS	99	T179631S	84
DTHB01754S	46	PL112601	64	T111683	94, 97, 100	T181047	85, 94, 97, 100
DTHB0202S	46	PL112602	64	T111684	94, 97, 100	T181048	85, 94, 97, 100
DTHB02204S	46	PL112603	64	T111685	94, 97, 100	T181049	85, 94, 97, 100
DTHB0274S	46	PL112700	64	T111686	94, 97, 100	T181050	85, 94, 97, 100
DTHB03304S	46	PL112701	64	T111687	94, 97, 100	T181051	85, 94, 97, 100
DTHB0344S	46	PL112702	64	T113073	95, 98, 100	T181052	85, 94, 97, 100
DTHB0404S	46	PL112703	64	T113074	95, 98, 100	T181054	95, 98, 100
DTHB04404S	46	PL112704	64	T113075	95, 98, 100	T181055	95, 98, 100
DTHB0514S	46	PL112705	64	T113076	95, 98, 100	T181056	95, 98, 100
DTHB05504S	46	PL112706	64	T113077	95, 98, 100	T181057	95, 98, 100
DTHB0634S	46	PL112707	64	T137920	96, 99, 100	T181058	95, 98, 100
DTHB0754S	46	PL79900	133	T137921	96, 99, 100	T181059	95, 98, 100
DTHB0934S	46	PL79905	78	T137922	96, 99, 100	T181061	96, 99, 100
DTHB72S	46	PL79906	78	T137923	96, 99, 100	T181062	96, 99, 100
FS1100	77	PL79907	78	T137924	96, 99, 100	T181063	96, 99, 100
FS11000	77	PL79908	78	T153004	17	T181064	96, 99, 100
FS1150	77	PL79911	133	T153005	17	T181065	96, 99, 100
FS1250	77	PL79912	133	T153006	17	T181066	96, 99, 100
FS1350	77	PL79920	75	T153104	19	T181217	67
FS150	77	PL79921	75	T153105	19	T181219	67
FS1500	77	PL79922	75	T153106	19	T181220	67
FS175	77	PL79923	75	T153929	67	T181221	67
FS1750	77	PL79924	75	T153930	67	T181223	67
FS2100	77	PL79924	64, 75	T153931	67	T211688	85, 94, 97, 100
FS21000	77	PL79925	75	T160830	112	T211689	85, 94, 97, 100
FS2150	77	PL79926	75	T160831	112	T213078	95, 98, 100
FS21500	77	PL79927	75	T160832	112	T213079	95, 98, 100
FS22000	77	PL79928	75	T160833	112	T243570	96, 99, 100
FS2250	77	PL79928	64, 75	T160834	112	T243571	96, 99, 100
FS2300	77	PL79929	75	T160835	112	T2527031	29
FS23000	77	PL79929	64, 75	T169430	115	T2527051	29
FS2350	77	PL79930	75	T169431	115	T2527071	29
FS250	77	PL79930	64, 75	T169432	115	T253007S	17
FS2500	77	PL79931	75	T169433	115	T253007SS	17
FS275	77	PL79931	64, 75	T169434	115	T253008S	17
FS2750	77	PLC85000	115	T169435	115	T253008SS	17
FS31000	77	PLC85001	115	T169436	115	T253009S	17
FS3150	77	PLC85002	115	T169437	115	T253009SS	17
FS31500	77	PLC85003	115	T169438	115	T253010S	17
FS32000	77	PLC85004	115	T169439	115	T253010SS	17
FS3250	77	PT061150005LS	106	T179600S	84	T253011S	17
FS33000	77	PT061150005SS	106	T179603S	84	T253011SS	17
FS3350	77	PT061150007LS	106	T179604S	84	T253012S	17
FS350	77	PT061150007SS	106	T179605S	84	T253012SS	17
FS3500	77	PT061150010LS	106	T179608S	84	T2530134S	17
FS3750	77	PT061150010SS	106	T179609S	84	T253013S	17
GP1210000S	22	PT061150015LS	106	T179615S	84	T253013SS	17
GP121000S	22	PT061150015SS	106	T179618S	84	T2530144S	17
GP1215000S	22	PT061150025LS	106	T179619S	84	T253014S	17
GP12250S	22	PT061150025SS	106	T179620S	84	T253014SS	17
GP123000S	22	PTBA3150009LS	99	T179621S	84	T253060	20
GP125000S	22	PTBA3150009SS	99	T179622S	84	T253061	20
GP12500S	22	PTBA3150015LS	99	T179623S	84	T253062	20

CATALOG NO.	PAGE NO.	CATALOG NO.	PAGE NO.	CATALOG NO.	PAGE NO.	CATALOG NO.	PAGE NO.
T253063	20	T2A795523S	28	TA83314	64	TB83212	64
T253064	20	T2A795533S	28	TA83315	64	TB83213	64
T253065	20	T2A795543S	28	TA83316	64	TB83215	64
T253066	20	T2A795553S	28	TB181141	59	TB83218	64
T253067	20	T335000153S	26	TB181142	59	TB83219	64
T253108S	19	T3527101	29	TB181143	59	TB83220	64
T253109S	19	T3533111S	23	TB181144	59	TC533111S	23
T253110S	19	T353311SS	25	TB181146	59	TC535153S	18
T253111S	19	T3533411S	25	TB181148	59	TC535163S	18
T253112S	19	T3533611S	22	TB181149	59	TC535173S	18
T2531131S	19	T379083S	29	TB181150	59	TC535183S	18
T2531141S	19	T3792711S	27	TB181151	59	TE1530223S	18
T2535153S	17	T3793123S	24	TB32403	62	TE2530193S	18
T253515SS	17	T379312SS	25	TB32404	62	TE2530203S	18
T2535163S	17	T3793133S	24	TB32405	62	TE2A530213S	18
T253516SS	17	T379313SS	25	TB32406	62	TF217437S	21
T2535173S	17	T3793143S	24	TB32669	62	TF217439S	21
T253517SS	17	T379314SS	25	TB54523	62	TF220105S	28
T2535183S	17	T3793331S	26	TB54524	62	TF220155S	28
T253518SS	17	T3793671S	22	TB81000	60	TF220255S	28
T2536151S	19	T3795191S	27	TB81001	60	TF220505S	28
T2536161S	19	T3795511S	28	TB81002	60	TF249873S	21
T2536171S	19	T3796931S	27	TB81003	60	TF252520S	21
T2536181S	19	TA253929	60	TB81004	60	TF252794S	21
T279740S	20	TA253930	60	TB81005	60	TF252795S	21
T279741S	20	TA253931	60	TB81006	60	TF252796S	21
T279742S	20	TA254525	62	TB81007	60	TF252797S	21
T279743S	20	TA254535	62	TB81009	60	TF279260S	21
T279744S	20	TA254536	62	TB81020	60	TF279261S	21
T279745S	20	TA254537	62	TB81200	59	TF279262S	21
T279746S	20	TA254538	62	TB81201	59	TF279263S	21
T279747S	20	TA254539	62	TB81210	59	TF279264S	21
T279748S	20	TA281008	60	TB81211	59	TF279265S	21
T2A527121	29	TA281197	62	TB81212	59	TF279266S	21
T2A527131	29	TA281202	62	TB81213	59	TF279267S	21
T2A527151	29	TA281203	62	TB81214	59	TF279300S	21
T2A527171	29	TA281205	62	TB81215	59	TF279301S	21
T2A527181	29	TA281218	60	TB81216	59	TF279302S	21
T2A527191	29	TA281219	60	TB81217	59	TF279303S	21
T2A533081S	23	TA281220	60	TB81301	61	TF279304S	21
T2A53308SS	25	TA281221	60	TB81302	61	TP131023S	26
T2A533091S	23	TA281240	62	TB81303	61	TP131033S	26
T2A53309SS	25	TA281241	62	TB81304	61	TP131043S	26
T2A533101S	23	TA83221	64	TB81305	61	TP131423S	27
T2A53310SS	25	TA83222	64	TB81306	61	TP131433S	27
T2A533281S	25	TA83223	64	TB81307	61	TP131443S	27
T2A533291S	25	TA83224	64	TB81308	61	TP131053S	26
T2A533401S	25	TA83300	63	TB81309	61	TP131063S	26
T2A533601S	22	TA83301	63	TB81321	61	TP131073S	26
T2A792681S	27	TA83302	63	TB81322	61	TP130993S	26
T2A792691S	27	TA83303	63	TB81323	61	TP131123S	26
T2A792701S	27	TA83304	63	TB81324	61	TP131133S	26
T2A793301S	26	TA83305	63	TB81325	61	TP135000453S	26
T2A793311S	26	TA83306	63	TB81326	61	TP1533173S	23
T2A793321S	26	TA83310	64	TB81327	61	TP1533213S	23
T2A795161S	27	TA83311	64	TB81328	61	TP1533222S	23
T2A795171S	27	TA83312	64	TB81329	61	TP1533423S	25
T2A795181S	27	TA83313	64	TB83210	64	TP1533433S	25

CATALOG NO.	PAGE NO.	CATALOG NO.	PAGE NO.	CATALOG NO.	PAGE NO.	CATALOG NO.	PAGE NO.
TP1533443S	25	TP793684S	22	TPNS01533143S	40		
TP1533453S	25	TP793694S	22	TPNS01533151S	41		
TP1533463S	25	TP793704S	22	TPNS01533153S	40		
TP1533473S	25	TP793714S	22	TPNS01533161S	41		
TP1533483S	25	TP793724S	22	TPNS01533163S	40		
TP1533493S	25	TP793734S	22	TPNS01533173S	40		
TP1533503S	25	TP793744S	22	TPNS01792714S	41		
TP35000303S	26	TP795203S	27	TPNS01792724S	41		
TP35000753S	26	TP795213S	27	TPNS01792734S	41		
TP35001123S	26	TP795223S	27	TPNS01792744S	41		
TP35001503S	26	TP795233S	27	TPNS02533113S	40		
TP35002253S	26	TP795243S	27	TPNS02533123S	40		
TP35003003S	26	TP796944S	27	TPNS02533133S	40		
TP530193S	17	TP796954S	27	TPNS02533143S	40		
TP530203S	17	TP796964S	27	TPNS02533153S	40		
TP530213S	17	TP796974S	27	TPNS02533163S	40		
TP530223S	17	TP796984S	27	TPNS02533173S	40		
TP530233S	17	TPC530193S	18	WSA1	134		
TP530243S	17	TPC530203S	18	WSA2	134		
TP531193S	19	TPC533123S	23	WSA3	134		
TP531203S	19	TPC533133S	23	WSA4	134		
TP531213S	19	TPC533143S	23	WSA5	134		
TP531223S	19	TPC533153S	23	WSA6	134		
TP531233S	19	TPC533163S	23	WSA8	134		
TP533121S	24	TPC533173S	23	WSB3	134		
TP533123S	23	TPC533183S	23	WSB4	134		
TP533128S	24	TPC533193S	23				
TP533131S	24	TPC3533111S	120				
TP533133S	23	TPC3533113S	120				
TP533138S	24	TPC3533121S	120				
TP533141S	24	TPC3533123S	120				
TP533143S	23	TPC3533131S	120				
TP533148S	24	TPC3533133S	120				
TP533151S	24	TPC3533141S	120				
TP533153S	23	TPC3533143S	120				
TP533158S	24	TPC3533151S	120				
TP533161S	24	TPC3533153S	120				
TP533163S	23	TPC3533161S	120				
TP533168S	24	TPC3533163S	120				
TP533171S	24	TPC3533171S	120				
TP533181S	24	TPC3533173S	120				
TP533183S	23	TPC3533181S	120				
TP533191S	24	TPC3533183S	120				
TP533624S	22	TPC3533191S	120				
TP533634S	22	TPC3533193S	120				
TP533644S	22	TPNS00533113S	40				
TP533654S	22	TPNS00533123S	40				
TP533664S	22	TPNS00533133S	40				
TP533674S	22	TPNS00533143S	40				
TP536491S	19	TPNS00533153S	40				
TP536503S	19	TPNS00533163S	40				
TP536513S	19	TPNS00533173S	40				
TP79085S	29	TPNS01533113S	40				
TP79087S	29	TPNS01533121S	41				
TP79088S	29	TPNS01533123S	40				
TP792724S	27	TPNS01533131S	41				
TP792734S	27	TPNS01533133S	40				
TP792744S	27	TPNS01533141S	41				

## General Purpose Transformers

For over eighty-eight years, Acme Electric has been manufacturing Power Conditioning Equipment for use in industrial, commercial and OEM applications. Built on a reputation for superior service, quality and technical expertise in the transformer market, Acme is regarded as a true industry leader.

### Dry Type General Purpose Transformers

Acme Electric is a full line manufacturer of low voltage (600V and below) dry type distribution transformers using both copper and aluminum conductor, offering an array of products between 0.05 -1000 KVA.

All Acme products are designed, constructed and rated to meet or exceed the standards established by NEMA, ANSI and IEEE. With few exceptions, all ACME transformers are UL Listed.

### K-Factor Transformers

Non-sinusoidal harmonic currents are created by much of today's electronic equipment. In fact, the switch mode power supply found in desktop computers, data processors and other office equipment is a major source of harmonic currents. Other sources include electronic ballasts, variable frequency drives, heating controls and rectifier circuits.

These non-linear loads can cause the transformer's neutral conductor to overheat, requiring special transformer design. Acme's non-linear load isolation transformers use special winding techniques to minimize the eddy current losses generated by harmonic currents. A double-sized neutral conductor handles the excessive neutral current found in non-linear load applications, preventing the transformer from overheating.

### Harmonic Mitigating Transformers

Harmonic currents can sometimes cause equipment to malfunction, motors to burn out, circuit breakers to trip, and fuses to blow. In such a case, there is an advantage to specifying a transformer that treats the harmonic anomalies versus simply tolerating them. Acme's Harmonic Mitigating Transformers offer the best solution for combating harmonics associated with non-linear loads.

These foil wound transformers will, by nature, be smaller, more efficient, and have lower eddy current losses than their wire wound counterparts. Acme's Harmonic Mitigating Transformers utilize a time proven zig-zag connection in the secondary circuit that results in a phase shift of the triplen harmonics and causes them to cancel one another. This technology not only results in cooler operation and "cleaner power", but also provides a more energy efficient means of dealing with harmonic problems.

### CSL-3 / NEMA Premium Transformers

The Acme POWERWISE C3 sets a new standard for efficiency and reliability. Due to the use of more efficient core material and higher-grade electrical steel, POWERWISE C3 transformers are the most efficient commercially available transformers. With a 30% increase in efficiency performance over standard TP-1 transformers, these energy-efficient units exceed the requirements of the US Department of Energy Candidate Standard Level (CSL) 3 performance standard. POWERWISE C3 transformers achieve the lowest life cycle costs by reducing annual energy costs. Depending on the size of the transformer, this can mean thousands of dollars saved per transformer. And, because they generate lower losses, they reduce power drawn from generating stations, resulting in lower greenhouse gas emissions and less smog.

Acme POWERWISE C3 transformers are copper wound, 3-phase common-core, dry-type ventilated isolation transformers. Each transformer is meticulously constructed to ANSI/IEEE Standards and is UL and CSA listed. The POWERWISE C3 transformer is a perfect choice for K through 12, college, university, healthcare, governmental and commercial buildings where the total life cycle cost of the facility and its electrical system is a priority.

