

Installation and Operating Instructions for BK8 Flange Mount Gearbox Coupling

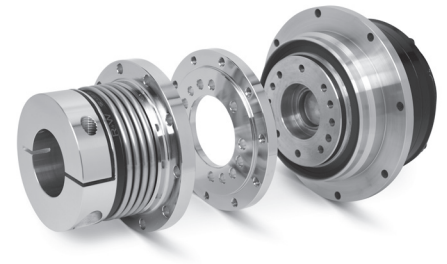

Please carefully and completely read the following installation, operation and maintenance procedures for R+W couplings. Failure to comply with these procedures may result in poor performance and / or failure of the coupling. Installation of the bellows coupling should be performed by a qualified technician.

General Function



R+W bellows couplings are flexible shaft couplings. The flexible and torsionally rigid stainless steel bellows provides backlash free transmission of torque. The metal bellows compensates for lateral, axial and angular misalignment, with very low restoring forces.

Mounting an ISO Flange Output Gearbox to a Linear Motion Axis

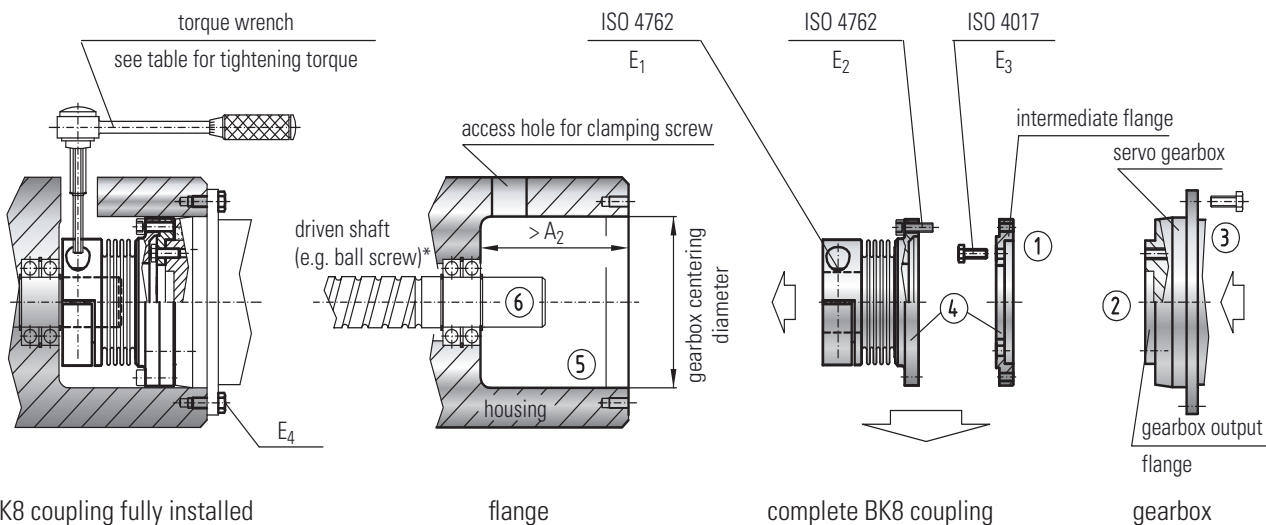

BK8 coupling fully installed

flange

complete BK8 coupling

gearbox

Mounting

First the intermediate flange (1) is placed onto the output flange (2) of the servo gearbox (3) and the screws (E3) are tightened.

Next, the bellows coupling is placed onto the intermediate flange (4) and tightly bolted together with the supplied screws (E2) ISO 4762.

The complete gearbox and coupling assembly is now installed into the housing (5) to the correct axial position, and screws (E4) are tightened. After ensuring that there is no binding of the clamping hub and that the bellows has remained in a relaxed state, the clamping screw (E1) is then tightened to the torque value specified in the table.

Dismounting

Loosen mounting screws (E4) and (E1).

The gearbox, complete with assembled coupling, can now be pulled away from the housing (5).

Disassembly of the coupling from the gear box is completed in the opposite sequence of the mounting instructions.

Maximum Shaft Misalignment

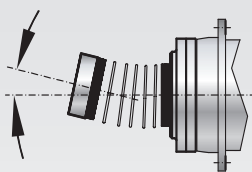

angular misalignment ΔK_w

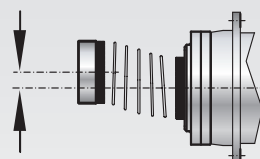

lateral misalignment ΔK_r

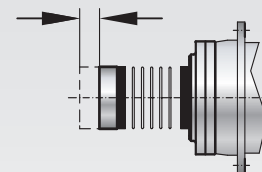

axial misalignment ΔK_r



Caution! Lateral misalignment has a negative effect on the service life of the bellows. Exact alignment of the R+W bellows coupling considerably increases its service life. Reducing or eliminating lateral misalignment also reduces radial loads placed on adjacent bearings, and has a positive influence on the entire drive system.

Mounting Preparation

When mounting and dismounting, the bellows may only be deformed by 1.5x the maximum permissible misalignment values specified in the catalog. It is important to avoid any excessive force when handling the coupling. All mounting surfaces, including shafts, keys, bores and keyways must be clean and free of burrs, nicks and dents. Inspect shaft diameters, coupling bores, key and keyway dimensions and tolerances. All R+W coupling bores are machined to ISO tolerance H7. The overall clearance between the hub and shaft should



be held within 0.01-0.05mm. A light coating of machine oil is recommended to ease the mounting process and will not affect the clamping force of the hub.

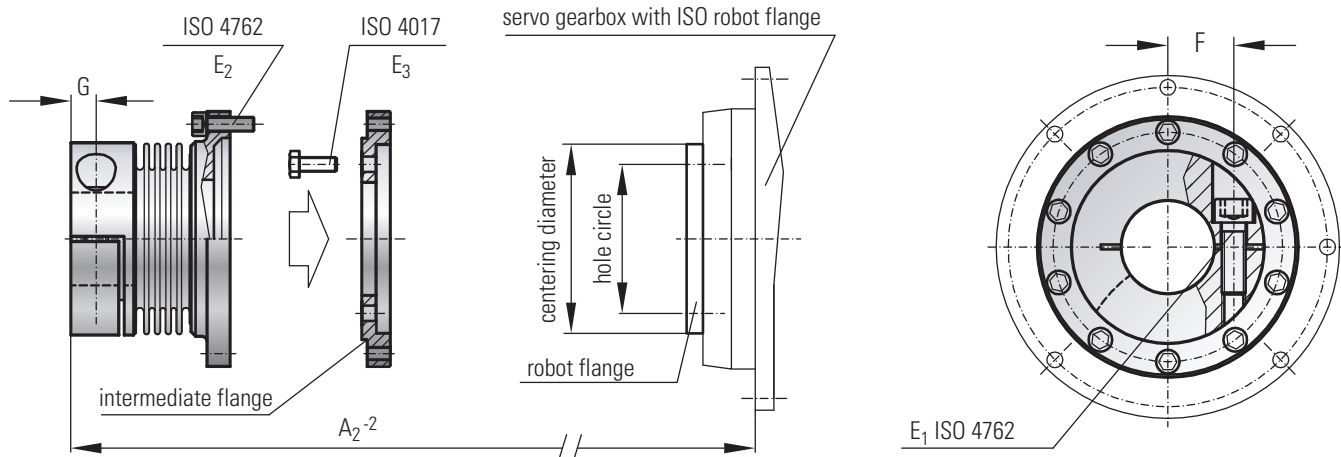

Caution! Oils and greases containing molybdenum disulphide or other high pressure additives should not be used.

Screw Tightening Torque / Technical Values



Coupling model	Series					
	15	60	150	300	1500	
Gearbox flange centering diameter (mm)	40 h7	63 h7	80 h7	100 h7	160 h7	
Gearbox flange bolt circle diameter / thread size (mm)	31.5 / 8xM5	50 / 8xM6	63 / 12xM6	80 / 12xM8	125 / 12xM10	
Length for installation (mm)	A ₂	68	97	101	128	190
Nominal torque (Nm)	T _{KN}	28	90	200	400	1500
Emergency stop torque (Nm)	T _{KN}	40	110	300	550	2000
Screw ISO 4762 (mm)	E ₁	1x M5	1x M8	1x M10	1x M12	2x M20
Tightening torque (Nm)	E ₁	8	40	75	120	470
Screw ISO 4762 (mm)	E ₂	10x M4x12	10x M5x16	10x M6x20	12x M6x20	16x M8x20
Tightening torque (Nm)	E ₂	4.6	8	14	14	35
Screw ISO 4017 (mm)	E ₃	8x M5x16	8x M6x16	12x M6x16	12x M8x25	12x M10x30
Tightening torque (Nm)	E ₃	8	15	14	40	75
Distance (mm)	G	6.5	9.5	11	13	22.5
Distance (mm)	F	17.5	23	27	39	45
Lateral  (mm)	max. values	0.25	0.25	0.25	0.25	0.25
Angular  (degree)		1°	1°	1°	1°	1°
Axial  (mm)		1	1.5	2	2.5	3

Maintenance

R+W bellows couplings are maintenance free as long as they are properly mounted and the maximum misalignment and torque values are not exceeded. Couplings should be inspected at regular maintenance intervals.