

INSTALLATION AND OPERATING INSTRUCTIONS FOR R+W LINE SHAFTS MODEL ZA / ZAE / ZAL

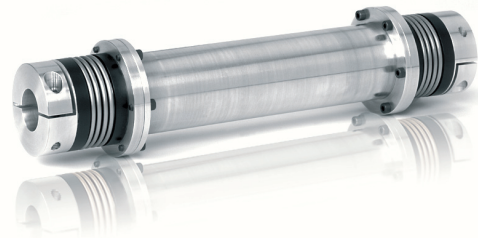

GENERAL FUNCTIONING

The proper installation and maintenance of the R+W line shaft coupling is essential to insure maximum service life. Failure to do so may void the warranty and cause premature failure of the coupling.



Installation should be performed by a trained technician and only after reading this document.

SAFETY INSTRUCTIONS



These couplings can rotate at very high speeds which can cause serious personal injury if touched during operation. Extreme care must be taken to properly construct and assemble safety guards and shields. Safety

lock-out procedures must also be used on the machines during the installation of the coupling to prevent the accidental startup of the machine causing potential injury to the installation technician.

MANUFACTURER'S DECLARATION

Manufacturer's declaration according to EG guidelines for machinery 2006/42/EG Appendix IIB. In the sense of machine guidelines (MR) shaft couplings are no machines, but compo-

nents for the installation in machines. Their putting into operation is subject to the fulfillment of all requirements of machine guidelines by or after integration in the final product.

TRANSPORT

R+W line shaft couplings are delivered ready for installation. Prior to installation the line shaft should be stored in their original packaging to ensure that they are properly protected. This

installation instruction sheet should be available to the technician at the time of installation.

FUNCTION

R+W line shafts are flexible shaft couplings for spanning longer shaft distances. They consist of two metal bellow coupling hubs (1) and one intermediate tube (2). The metal bellows are made of corrugated stainless steel and compensate for lateral, axial and angular shaft misalignment (Fig. 1). Torque transmission is backlash free and torsionally rigid (no wind-up). In horizontal applications the weight of the intermediate tube is supported by gim-

bals (3) within the metal bellow coupling hubs relieving excessive strain on the bellows. In vertically installed applications (Fig. 2) the intermediate tube is supported (5) with special hubs to again relieve compressive strain on the bellows.



R+W line shafts may only be applied in accordance with the technical data of the catalog

PREPARATION FOR INSTALLATION

When mounting or dismounting the couplings, the metal bellow can be deformed by 1.5 times the maximum misalignment values as stated in the ZA/ZAE Line Shaft catalog. Care must be taken not to exert excessive forces on the stainless steel bellows causing permanent deformation. The shaft and hub bores must be free of dirt and any burrs. Prior to installing check the shaft and bore dimensions and tolerances. The hub bores are produced to an ISO bore tolerance H7. The clearance be-

tween the shaft and hub bore should not exceed 0.01 to 0.05 mm (0.0004 to 0.002 inches). To aid in the assembly process the shaft can be slightly oiled without affecting the clamping strength.



CAUTION! Do not use oils and greases containing molybdenum disulphide or other high pressure additives.

SHAFT HUB CONNECTION

Clamping hubs

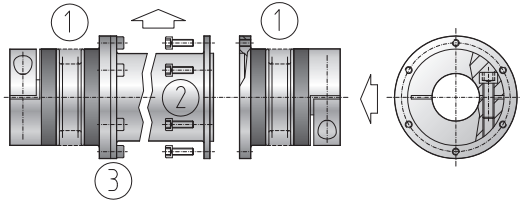

Split hubs

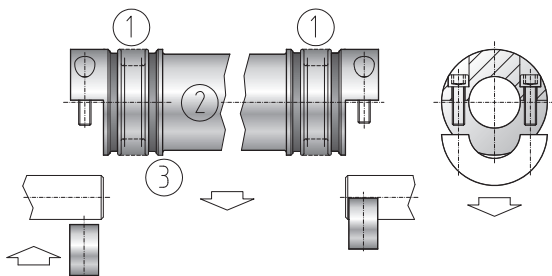

Tapered bushings

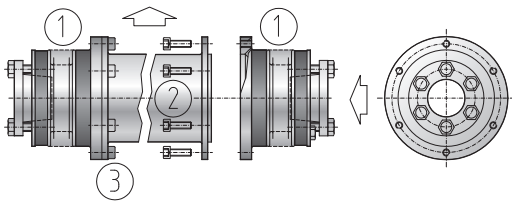

ALIGNMENT

R+W line shaft couplings are available in length up to 6 meters (19.7 feet) without intermediate support bearings. To insure maximum life proper alignment is necessary. We recommend laser alignment whenever possible. Other alignment techniques are also appropriate as long as the maximum permissible misalignment values are not exceeded. Table 1 shows maximum

Types of misalignments

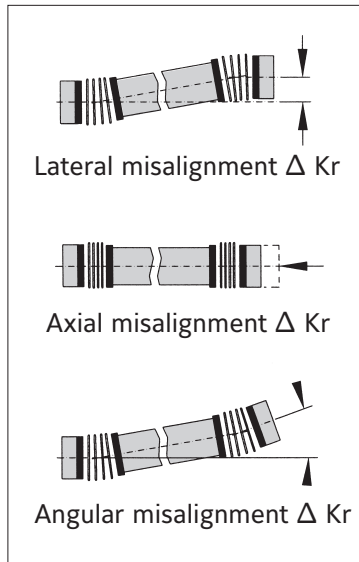

Figure 1

Vertical installation

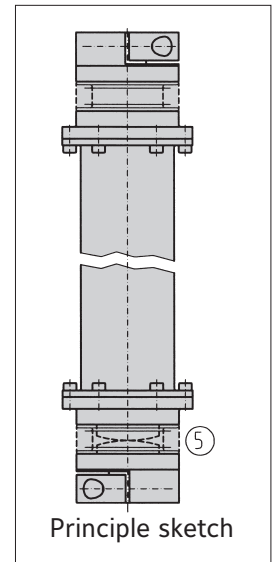
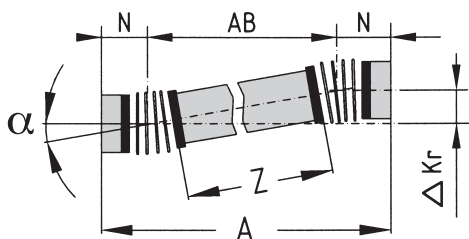

Figure 2



permissible misalignment values, tightening torques and important mounting dimensions. R+W line shafts compensates for lateral, axial, and angular shaft misalignment (Fig. 1). The lateral misalignment depends on the intermediate tube length. It can be calculated according to the formula in Figure 3.

$$\Delta Kr = \tan \alpha \cdot AB$$

$$AB = A - 2 \times N$$

Figure 3

AXIAL MISALIGNMENTS

SERIES			10	30	60	150	200	300	500	800	1500	4000
Lateral misalignment (mm)	ΔKr	Depending on the intermediate shaft length (Figure 3)										
Angular misalignment (degree)	ΔKw	2x1° for all sizes										
Axial misalignment ± (mm)	ΔKa	2	2	3	4	4	4	5	6	4	4	
Joint center dimension (mm)	N	25	34	41	47	52	56	66	64	56	61	
Clamping length split hub (mm)	G	11.5	17	21	24	27	30	35	40	-	-	
Fastening screws (Nm)	E*	M4	M6	M8	M10	M12	M12	M16	M16	M12	M16	
Tightening Torque (Nm)		5	15	40	70	110	130	200	250	70	120	
Assembly screws (Nm)	J	M4	M4	M5	M6	M6	M8	M8	M8	M10	M12	
Tightening Torque (Nm)		3	4	7	10	12	30	30	40	70	120	

* up to series 800 ISO 4762 screws
series 1500-4000 ISO 4017 screws

Table 1

CLAMPING HUB CONNECTION

Model ZA (series 10 - 800 Nm)

Mounting:

Loosen Screw E and slide the metal bellow coupling segments onto each shaft end. Now insert the intermediate tube and assemble onto both metal bellow coupling segments using the assembly screws J. Tighten the assembly screws J to the correct torque indicated in the specification table. Center the entire line shaft coupling onto the shaft ends and tighten screw E using a torque wrench to the correct torque as indicated in the specification table.

Dismounting:

Loosen Screw E on one end of the line shaft coupling. Remove assembly screws J on both ends of the line shaft coupling and remove the intermediate tube. Be sure to support the intermediate tube during removal. Depending on length this may require two people. Loosen Screw E on the second metal bellow coupling segment and slide both segments off.

Model ZA (series 10 - 800 Nm)

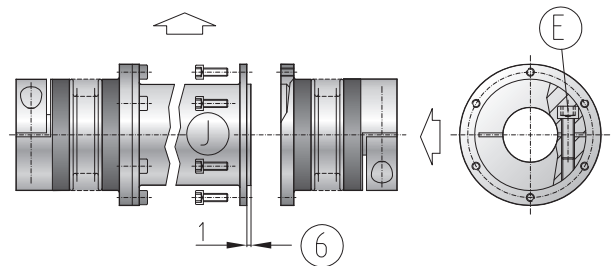

Figure 4

Model ZAE / ZAL (series 10-800 Nm)

Mounting:

First make sure that the distance between shaft ends exceeds the dimension P.

$$\text{Length P} = \text{length A} - (2 \times 0) \text{ mm}$$

Insert the line shaft coupling and assemble the split hubs with assembly screws E. Using a torque wrench tighten screws E the correct torque indicated in the specifications table.

Dismounting:

Remove the split hubs by removing the assembly screws E. Lift the line shaft coupling off the shaft ends.

Model ZAE / ZAL (series 10-800 Nm)

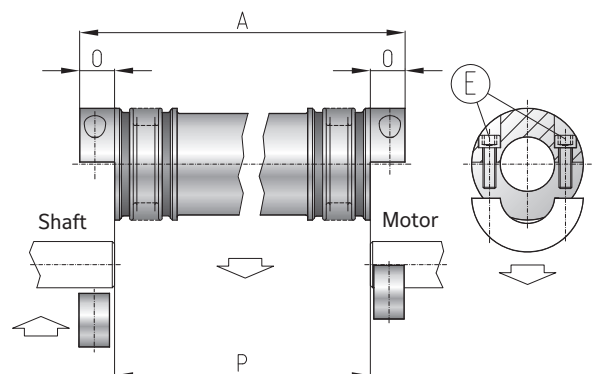

Figure 5

TAPERED BUSHING CONNECTION

Model ZA (Series 1500 - 4000)

Mounting:

Loosen Screws E (Do not remove!) and slide the metal bellow coupling segments onto each shaft end. Now insert the intermediate tube and assemble onto both metal bellow coupling segments using the assembly screws J. Tighten the assembly screws J to the correct torque indicated in the specification table. Center the entire line shaft coupling onto the shaft ends and evenly tighten screws E using a torque wrench to the correct torque as indicated in the specification table. Even tightening of screws E is critical to ensure that the shaft and metal bellow coupling segment are parallel.



CAUTION! Over tightening of the Screws E may destroy the tapered bushing connection. Do not exceed the tightening torque as specified in the specification table.

Dismounting:

Loosen Screws E on one side of the line shaft coupling. Using the three jack screws F loosen the tapered segment so that it slides freely on the shaft. Remove the assembly screws J from both sides of the coupling and remove the intermediate tube. Be careful to support the tube during removal. Depending on the length of the tube this may require two people. Repeat the earlier procedure to remove the second metal bellow coupling segment.

Model ZA (Series 1500 - 4000)

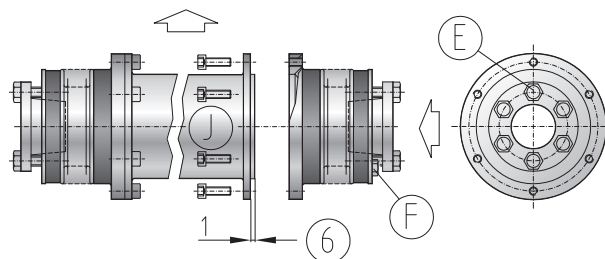

CAUTION: Be sure to turn back the jack screws F before reassembly.

MAINTENANCE

R+W couplings are maintenance free. Visual inspections are recommended periodically to insure proper operation.