

Multi-connector with One-touch Fittings

Series DMK

No. of Connecting Tubes: 6, 12

RoHS

Multi-connector with One-touch fittings provide quick and easy installation and removal of multiple tubing (nylon, soft nylon, and polyurethane) when connecting to a panel of a device.

A unique positioning mechanism allows accurate installation and removal of tubing with ease even in a hard-to-see locations, while preventing piping errors when reconnecting.

Built-in One-touch fittings

Applicable to nylon, soft nylon, and polyurethane tubes.

Saves installation time

Unlike the use of multiple bulkhead unions for panel, Series DMK with built-in One-touch fittings significantly reduces the piping time.

Secure tube connection

Tubes are easily and securely connected to the multi-connector with built-in One-touch fittings.

No. of connecting tubes:

2 types of multi-connectors are available: 6 tubes and 12 tubes.



DMK6



DMK12

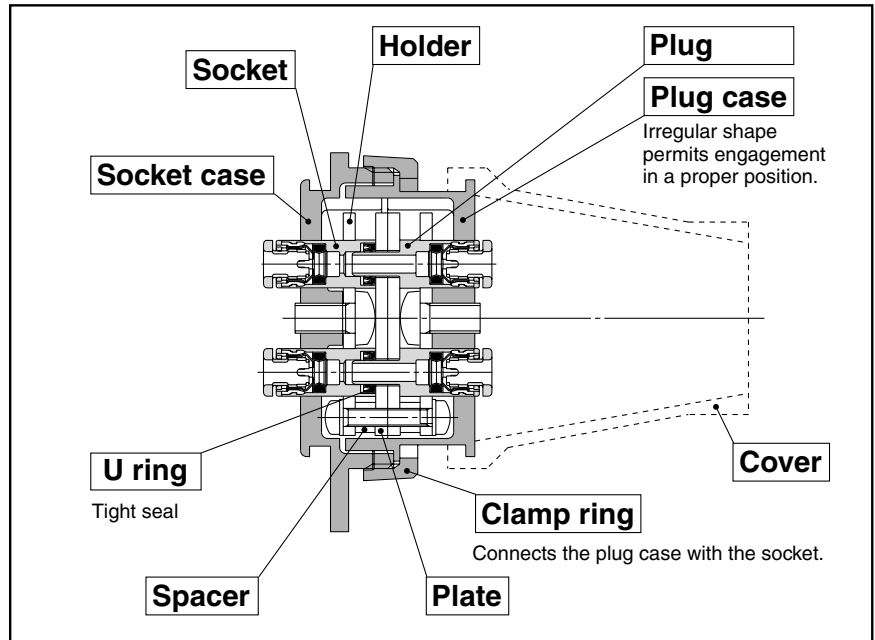

Model

No. of connecting tubes	Model			Replacement parts no.	
	Multi-connector	Plug side only	Socket side only	Cover	Clamp ring
6	DMK6-23	DMK6P-23	DMK6S-23	DMK-C-6	DMK6-P01
	DMK6-04	DMK6P-04	DMK6S-04		
12	DMK12-23	DMK12P-23	DMK12S-23	DMK-C-12	DMK12-P01
	DMK12-04	DMK12P-04	DMK12S-04		

Specifications

Applicable tubing materials	Nylon, Soft nylon, Polyurethane
Applicable tubing O.D. (mm)	ø3.2, ø4
Fluid	Air
Maximum operating pressure	1 MPa
Ambient and fluid temperature	-5 to 60°C (No freezing)

Principal Parts Material

	DMK6	DMK12
Socket case, Plug case Clamp ring	ADC12, White half-polished finish	
Plate	SPCC, Chromated	
Holder	SPCC, Zinc chromated	A5052, Hard anodized
Socket, Plug	C3604 Electroless nickel plated, POM, Stainless steel 304	
U ring	NBR	
Cover	Silicon rubber	
Round head phillips screw	SWRM, Nickel plated	
Round head phillips screw with flat washer	SWRM, Zinc chromated	
Spacer	SPC, Zinc chromated	

How to Order

DMK **6** **04**

Number of connecting tubes

6	6
12	12

Style

Nil	Multi-connector
P	Plug side only
S	Socket side only

Accessory (Option)

Nil	None
C1	Cover single side 1 pc.
C2	Cover both sides 2 pcs.

Tubing O.D.

23	ø3.2
04	ø4

- K
- M
- H
- KK
- D
- MS
- LQ
- MQR
- T

⚠ Precautions

Be sure to read before handling.
 Refer to front matters 58 and 59 for Safety Instructions and pages 13 to 16 for Fittings and Tubing Precautions.

How to Use

⚠ Caution Disassembly

- Loosen clamp ring A and disassemble the connector into the plug case and socket case.

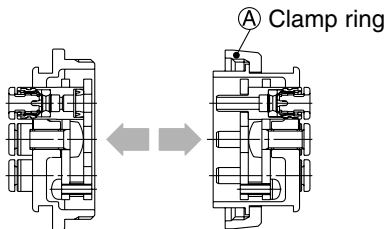

Connection

- Turn the cases while pressing them against each other until the plug case slides into the socket case at a proper position.
- Align at mark B of the plug and socket cases and turn them against each other to connect the two cases.
- Screw in the clamp ring to complete the connection.

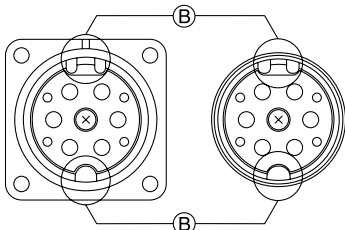

Installation of cover

- The cover can be installed on both the plug case or socket case.
- Stretch the cover to install on the cover installation latch.

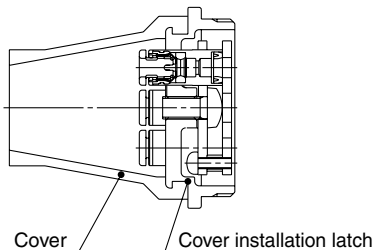

⚠ Caution

Please do not attach metal rods or metal pipes. Metal rods or pipes cannot be secured and the fittings will shoot out. Also, if tubes are attached after metal rods or pipes have been attached, the tubes will not hold and may come loose.

Installation and Removal of One-touch Mini Fittings

⚠ Caution

Installation of tubing

- Cut the tube perpendicularly, using caution not to damage its surface. (Use tube cutter TK-1, 2 or 3. Do not cut the tube with cutting pliers, nippers, scissors, etc.)
- Grasp the tube, then slowly push it until it comes to a stop.
- Then, pull it back gently to make sure that it does not come out.

Removal of tubing

- While pushing down on the rim of the release button, pull out the tube in the direction of the arrow (see illustration.) The release button can also be pushed down with a flat-head screwdriver. However, be careful not to break or damage the release button.
- To reuse the released tube, cut off the damaged portion of the tube.

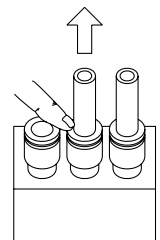

Series DMK

Dimensions

DMK6

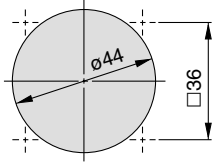

Panel mounting hole
(Socket side: With a cover)

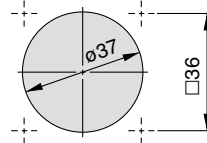

Panel mounting hole

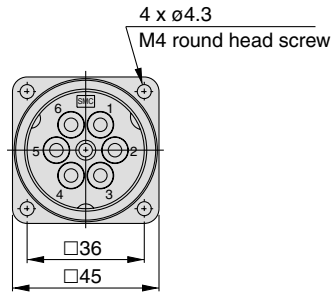
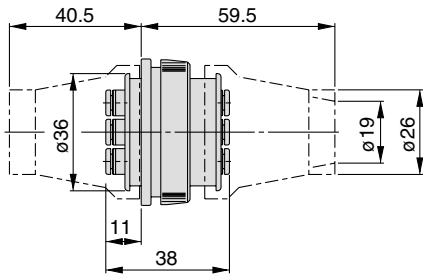

DMK12

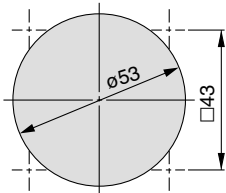

Panel mounting hole
(Socket side: With a cover)

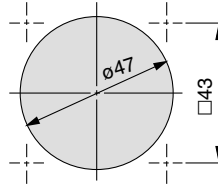

Panel mounting hole

