

Brass One-touch Fittings

Series *KQB*

- Fluid temperature: **-5 to 150°C**
- **Grease-free**
- Applicable tubing material: • **FEP • PFA • Nylon**
• **Soft nylon • Polyurethane**
• **Polyolefin**
- Electroless nickel plated
(Brass parts): **Made to Order (-X2)**

- K
- M
- H
- KK
- D
- MS
- LQ
- MQR
- T

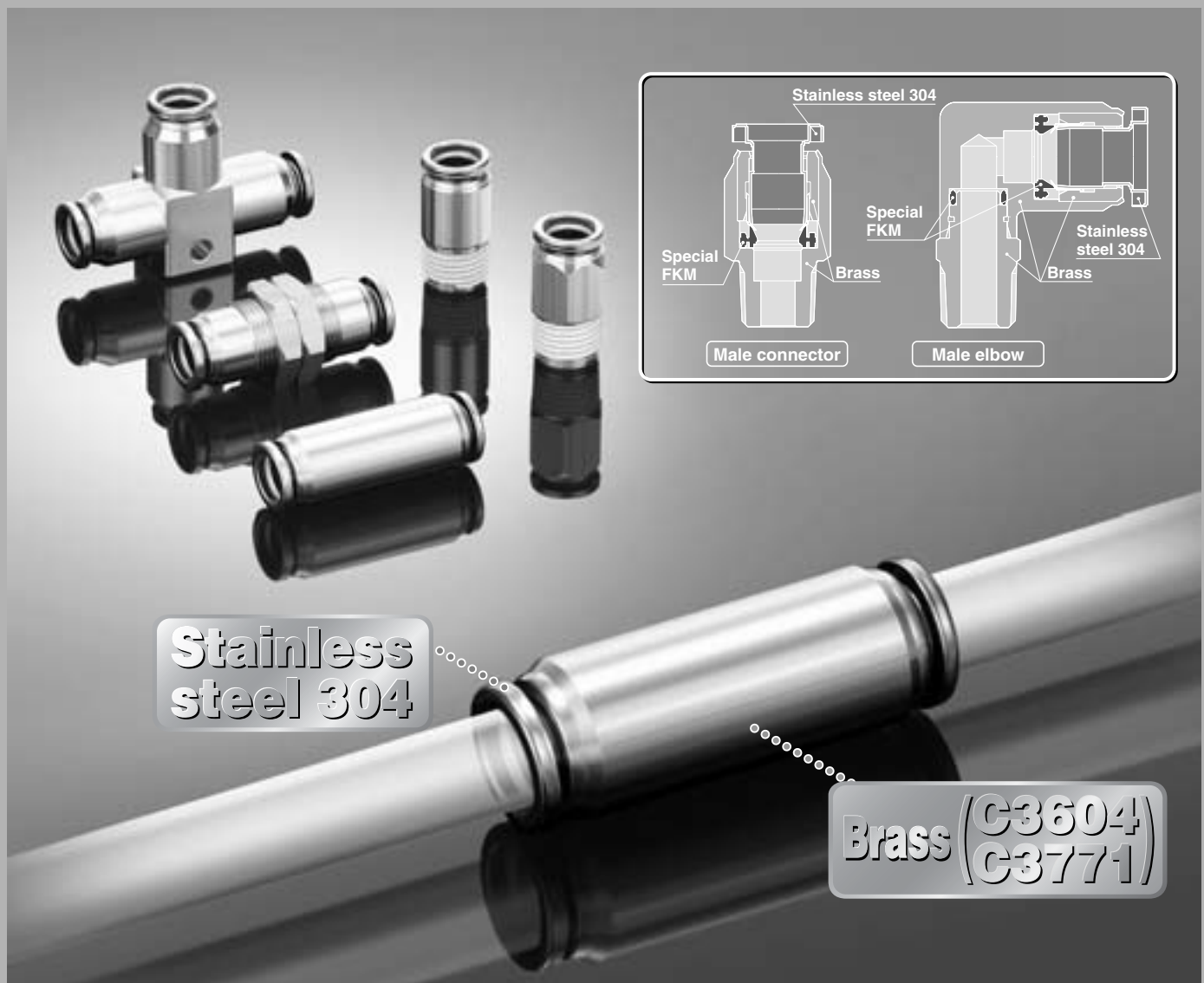

Male Connector

Applicable tubing O.D. (mm)	Connection thread	Model
ø4	M5	KQBH04-M5
	R1/8	KQBH04-01S
ø6	M5	KQBH06-M5
	R1/8	KQBH06-01S
	R1/4	KQBH06-02S
ø8	R1/8	KQBH08-01S
	R1/4	KQBH08-02S
	R3/8	KQBH08-03S
ø10	R1/4	KQBH10-02S
	R3/8	KQBH10-03S
ø12	R3/8	KQBH12-03S
	R1/2	KQBH12-04S



Hexagon Socket Head Male Connector

Applicable tubing O.D. (mm)	Connection thread	Model
ø4	M5	KQBS04-M5
	R1/8	KQBS04-01S
ø6	M5	KQBS06-M5
	R1/8	KQBS06-01S
	R1/4	KQBS06-02S
ø8	R1/8	KQBS08-01S
	R1/4	KQBS08-02S
	R3/8	KQBS08-03S
ø10	R1/4	KQBS10-02S
	R3/8	KQBS10-03S
ø12	R3/8	KQBS12-03S
	R1/2	KQBS12-04S



Straight Union

Applicable tubing O.D. (mm)	Model
ø4	KQBH04-00
ø6	KQBH06-00
ø8	KQBH08-00
ø10	KQBH10-00
ø12	KQBH12-00



Male Elbow

Applicable tubing O.D. (mm)	Connection thread	Model
ø4	M5	KQBL04-M5
	R1/8	KQBL04-01S
ø6	M5	KQBL06-M5
	R1/8	KQBL06-01S
	R1/4	KQBL06-02S
ø8	R1/8	KQBL08-01S
	R1/4	KQBL08-02S
	R3/8	KQBL08-03S
ø10	R1/4	KQBL10-02S
	R3/8	KQBL10-03S
ø12	R3/8	KQBL12-03S
	R1/2	KQBL12-04S



Union Elbow

Applicable tubing O.D. (mm)	Model
ø4	KQBL04-00
ø6	KQBL06-00
ø8	KQBL08-00
ø10	KQBL10-00
ø12	KQBL12-00



Male Branch Tee

Applicable tubing O.D. (mm)	Connection thread	Model
ø4	M5	KQBT04-M5
	R1/8	KQBT04-01S
ø6	M5	KQBT06-M5
	R1/8	KQBT06-01S
	R1/4	KQBT06-02S
ø8	R1/8	KQBT08-01S
	R1/4	KQBT08-02S
	R3/8	KQBT08-03S
ø10	R1/4	KQBT10-02S
	R3/8	KQBT10-03S
ø12	R3/8	KQBT12-03S
	R1/2	KQBT12-04S



Union Tee

Applicable tubing O.D. (mm)	Model
ø4	KQBT04-00
ø6	KQBT06-00
ø8	KQBT08-00
ø10	KQBT10-00
ø12	KQBT12-00



Union "Y"

Applicable tubing O.D. (mm)	Model
ø4	KQBU04-00
ø6	KQBU06-00
ø8	KQBU08-00
ø10	KQBU10-00
ø12	KQBU12-00



Bulkhead Union

Applicable tubing O.D. (mm)	Model
ø4	KQBE04-00
ø6	KQBE06-00
ø8	KQBE08-00
ø10	KQBE10-00
ø12	KQBE12-00



One-touch Fittings Series **KQB**



Applicable Tubing

Tubing material	FEP, PFA, Nylon, Soft nylon ^{Note 1)} , Polyurethane ^{Note 2) Note 3)} , Polyolefin
Tubing O.D.	ø4, ø6, ø8, ø10, ø12

Specifications

Fluid	Air, Water
Operating pressure range ^{Note 1)}	-100 kPa to 1 MPa
Proof pressure	3.0 MPa
Ambient and fluid temperature ^{Note 2)}	-5 to 150°C (No freezing)
Lubricant	Grease-free specification
Seal on the threads	With sealant

Note 1) For soft nylon tubing, water cannot be used.

Note 2) The pulling strength of polyurethane tube is as follows. The pulling load of the tube used for verifying the mounting of the tube within the fitting should be the values as shown or less in the table below. As reference, the thrust force occurring between the tube and the fitting at 0.8 MPa is shown on the table below.

Pulling Strength

Model	TU0425	TU0604	TU0805	TU1065	TU1208
Without inner sleeve	50 N	80 N	110 N	140 N	140 N
With inner sleeve	160 N	180 N	250 N	450 N	500 N

Reference: Thrust Force Occurring at 0.8 MPa

Model	TU0425	TU0604	TU0805	TU1065	TU1208
Load	10 N	25 N	40 N	65 N	90 N

Note 3) Please consult with SMC regarding applicable tube separately.

Note 4) Please avoid using in a vacuum holding application such as a leak tester, since there is leakage.

Note 5) It is recommended that you use the inner sleeve in the following conditions:

- When using in an environment where the fluid temperature changes drastically.
- When using at a high temperature.

Temperature Conditions

Operating tube	Temperature
FEP tubing/TH series	80°C or more
PFA tubing/TL series	120°C or more



Made to Order

(Refer to page 104 for details.)

Spare Parts

Description	Model	Material
Gasket	M-5G3	Stainless steel 316, Special FKM
Bulkhead nut	KQB04-P01	C3604
	KQB06-P01	
	KQB08-P01	
	KQB10-P01	
	KQB12-P01	

O.D.	Tube size	Tubing model (Material)				Applicable inner sleeve	
		Model	TU (Polyurethane)	TUS (Soft polyurethane)	TH (FEP)	TL (PFA)	Model
ø4	0402	—	—	●	—	TJ-0402	18
	0425	●	●	●	—	TJ-0425	18
	0403	—	—	—	●	TJ-0403	18
ø6	0604	●	●	●	●	TJ-0604	19
	0805	●	●	—	—	TJ-0805	20.5
ø8	0806	—	—	●	●	TJ-0806	20.5
	1065	●	●	—	—	TJ-1065	23
ø10	1075	—	—	●	—	TJ-1075	23
	1008	—	—	●	●	TJ-1208	24
	1208	●	●	—	—		
ø12	1209	—	—	●	—	TJ-1209	24
	1210	—	—	●	●	TJ-1210	24

Construction

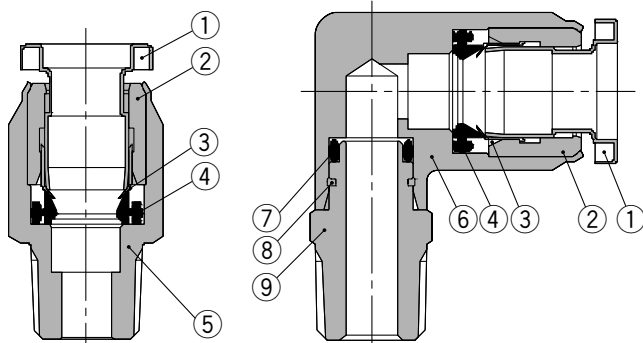

No.	Description	Material	Note
1	Release button	Stainless steel 304	
2	Guide	C3604	
3	Chuck	Stainless steel 304	
4	Seal	Special FKM	Fluoro coated
5	Male connector body	C3604	
6	Male elbow body	C3771	
7	O-ring	Special FKM	Fluoro coated
8	Stopper ring	Stainless steel 316	
9	Stud	C3604	

Series KQB

Dimensions

Male Connector: KQBH



Applicable tubing O.D. (mm)	Connection thread R	Model	H (Width across flats)	Note 1) ϕD	L	A*	M	Effective area ^{Note 2)} (mm ²)	Mass (g)
$\phi 4$	M5	KQBH04-M5	10	10	22.3	19.3	18	4	7.7
	1/8	KQBH04-01S			24	20		5.6	10
$\phi 6$	M5	KQBH06-M5	12	12	24.1	21.1	18.8	4	12
	1/8	KQBH06-01S			24.3	20.3		10.4	12
	1/4	KQBH06-02S			25.8	19.8		19	
$\phi 8$	1/8	KQBH08-01S	14	14	30.5	26.5	20.9	26.1	19
	1/4	KQBH08-02S			28.5	22.5			19
	3/8	KQBH08-03S			24	17.7			25
$\phi 10$	1/4	KQBH10-02S	17	17	35.5	29.5	23	41.5	30
	3/8	KQBH10-03S			31	24.7			30
$\phi 12$	3/8	KQBH12-03S	19	19	32.8	26.5	24.8	58.3	32
	1/2	KQBH12-04S			22	24.6			53

(In case of M5)

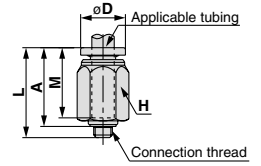

(In case of R)

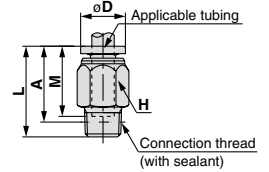

* Reference dimensions after installation of R thread
 Note 1) ϕD is maximum diameter.
 Note 2) Figures shown when using FEP tubing

Hexagon Socket Head Male Connector: KQBS



Applicable tubing O.D. (mm)	Connection thread R	Model	H (Width across flats)	Note 1) ϕD	L	A*	M	Effective area ^{Note 2)} (mm ²)	Mass (g)
$\phi 4$	M5	KQBS04-M5	2	10	25	22	18	4	9
	1/8	KQBS04-01S	3			21		4.1	10
$\phi 6$	M5	KQBS06-M5	2	12	25.8	22.8	18.8	4	13
	1/8	KQBS06-01S	4			21.8		9.9	13
	1/4	KQBS06-02S	19.8			10		21	
$\phi 8$	1/8	KQBS08-01S	5	14	30.5	26.5	20.9	17.2	18
	1/4	KQBS08-02S	6			28.5		22.5	19
	3/8	KQBS08-03S	30.1			23.8		37	
$\phi 10$	1/4	KQBS10-02S	8	17	35.5	29.5	23	39	29
	3/8	KQBS10-03S			31	24.7			30
$\phi 12$	3/8	KQBS12-03S	10	19	32.8	26.5	24.8	60	31
	1/2	KQBS12-04S			22	24.6			56

(In case of M5)

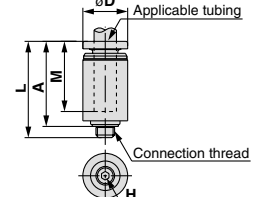

(In case of R)

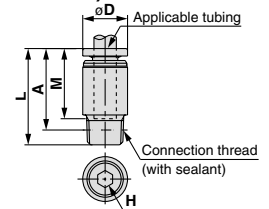

* Reference dimensions after installation of R thread
 Note 1) ϕD is maximum diameter.
 Note 2) Figures shown when using FEP tubing

Straight Union: KQBH



Applicable tubing O.D. (mm)	Model	Note 1) ϕD	L	M	Effective area ^{Note 2)} (mm ²)	Mass (g)
$\phi 4$	KQBH04-00	11	37	18	5.6	17
$\phi 6$	KQBH06-00	13	38.6	18.8	13.1	23
$\phi 8$	KQBH08-00	15	42.8	20.9	26.1	32
$\phi 10$	KQBH10-00	19	47	23	41.5	56
$\phi 12$	KQBH12-00	21	50.6	24.8	58.3	69

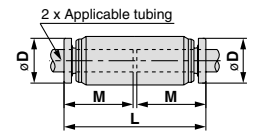

Note 1) ϕD is maximum diameter.
 Note 2) Figures shown when using FEP tubing

Male Elbow: KQBL



Applicable tubing O.D. (mm)	Connection thread R	Model	H (Width across flats)	Note 1) ϕD	L ₁	L ₂	A*	M	Effective area ^{Note 2)} (mm ²)	Mass (g)
$\phi 4$	M5	KQBL04-M5	10	11.6	20.5	16	18.8	18	3.5	19
	1/8	KQBL04-01S				19.5	21.3		4.2	21
$\phi 6$	M5	KQBL06-M5	14	14	22.1	17	21	18.8	3.5	26
	1/8	KQBL06-01S				20.5	23.5		9	27
	1/4	KQBL06-02S				24.5	25.5		37	
$\phi 8$	1/8	KQBL08-01S	14	15	24.9	21.9	25.7	20.9	21.6	39
	1/4	KQBL08-02S				25.9	27.7		47	
	3/8	KQBL08-03S				27.9	29.4		59	
$\phi 10$	1/4	KQBL10-02S	17	18	27.8	27.7	30.9	23	35.2	72
	3/8	KQBL10-03S				29.7	32.6		76	
$\phi 12$	3/8	KQBL12-03S	22	20.8	31.3	30.7	35.3	24.8	50.2	98
	1/2	KQBL12-04S				34.7	37.4		127	

(In case of M5)

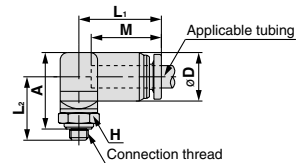

(In case of R)

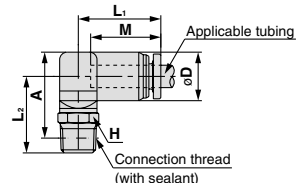

* Reference dimensions after installation of R thread
 Note 1) ϕD is maximum diameter.
 Note 2) Figures shown when using FEP tubing

Dimensions

Union Elbow: KQBL



Applicable tubing O.D. (mm)	Model	Note 1) ϕD	L	A	Q ₁	Q ₂	M	ϕN	Effective area Note 2) (mm ²)	Mass (g)
$\phi 4$	KQBL04-00	11.6	20.6	27.3	2.8	3.7	18	3.2	4.2	22
$\phi 6$	KQBL06-00	14	22.4	29.4	4	4	18.8		9	33
$\phi 8$	KQBL08-00	15.6	25.5	35.1	3.8	5.6	20.9	4.2	21.6	51
$\phi 10$	KQBL10-00	18.4	28.6	38.8	5.2	6.2	23		35.2	79
$\phi 12$	KQBL12-00	21.2	31.4	42	6.6	6.6	24.8	50.2	113	

Note 1) ϕD is maximum diameter.
Note 2) Figures shown when using FEP tubing

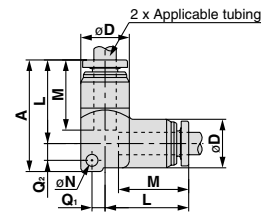

Male Branch Tee: KQBT



Applicable tubing O.D. (mm)	Connection thread R	Model	H (Width across flats)	Note 1) ϕD	L ₁	L ₂	A*	M	Effective area Note 2) (mm ²)	Mass (g)
$\phi 4$	M5	KQBT04-M5	10	11.6	20.5	18	23.1	18	4.5	27
	1/8	KQBT04-01S				21.5	25.6		6	28
$\phi 6$	M5	KQBT06-M5	14	14	22.1	19	25	18.8	4.5	41
	1/8	KQBT06-01S				22.5	27.5		11	43
	1/4	KQBT06-02S				26.5	29.5		52	
$\phi 8$	1/8	KQBT08-01S	12	15.6	24.9	23.9	30.7	20.9	26.3	64
	1/4	KQBT08-02S	14			27.9	32.7			73
	3/8	KQBT08-03S	17			29.9	34.4			87
$\phi 10$	1/4	KQBT10-02S	17	18.4	27.8	29.7	35.7	23	40.8	101
	3/8	KQBT10-03S				31.7	37.4			106
$\phi 12$	3/8	KQBT12-03S	22	21.2	31.3	32.7	39.5	24.8	57.2	139
	1/2	KQBT12-04S				36.7	41.6			166

* Reference dimensions after installation of R thread
Note 1) ϕD is maximum diameter.
Note 2) Figures shown when using FEP tubing

(In case of M5)

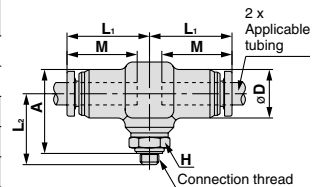

(In case of R)

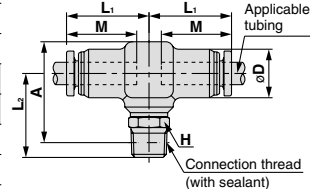

Union Tee: KQBT



Applicable tubing O.D. (mm)	Model	Note 1) ϕD	L	A	Q	M	ϕN	Effective area Note 2) (mm ²)	Mass (g)
$\phi 4$	KQBT04-00	11.6	20.6	28.7	4.1	18	3.2	6.4	29
$\phi 6$	KQBT06-00	14	22.4	31.4	4.9	18.8		10.6	44
$\phi 8$	KQBT08-00	15.6	25.5	36.3	6.1	20.9	4.2	25.6	60
$\phi 10$	KQBT10-00	18.4	28.6	40.6	7.1	23		40	99
$\phi 12$	KQBT12-00	21.2	31.4	44.5	8.1	24.8	57.4	135	

Note 1) ϕD is maximum diameter.
Note 2) Figures shown when using FEP tubing

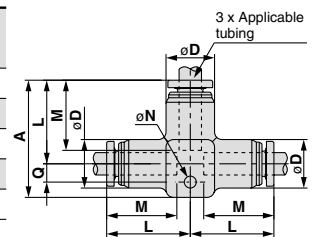

Union "Y": KQBU



Applicable tubing O.D. (mm)	Model	Note 1) ϕD	W	L ₁	L ₂	P	M ₁	M ₂	ϕN	Effective area Note 2) (mm ²)	Mass (g)
$\phi 4$	KQBU04-00	11.6	22.2	41.2	16.8	10.6	18	17	3.2	2.9	37
$\phi 6$	KQBU06-00	14	27	43.1	17	13	18.8	17.8		7.4	56
$\phi 8$	KQBU08-00	15.6	30.6	47.9	18.7	15	20.9	19.9	4.2	17.9	78
$\phi 10$	KQBU10-00	18.4	36.4	53	20.5	18	23	22		28	119
$\phi 12$	KQBU12-00	21.2	42.2	58	21.9	21	24.8	23.8	40.2	183	

Note 1) ϕD is maximum diameter.
Note 2) Figures shown when using FEP tubing

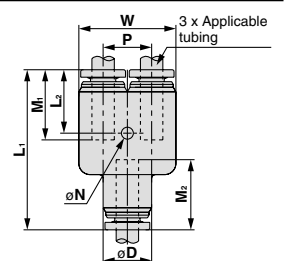

Bulkhead Union: KQBE



Applicable tubing O.D. (mm)	Model	T (M)	H (Width across flats)	L	Mounting hole	M	Effective area Note 2) (mm ²)	Mass (g)
$\phi 4$	KQBE04-00	M12X1	14	37	13	18	5.6	22
$\phi 6$	KQBE06-00	M14X1	17	38.6	15	18.8	10.4	30
$\phi 8$	KQBE08-00	M16X1	19	42.8	17	20.9	26.1	42
$\phi 10$	KQBE10-00	M20X1	24	47	21	23	41.5	74
$\phi 12$	KQBE12-00	M22X1	27	50.6	23	24.8	58.3	99

Note) Figures shown when using FEP tubing

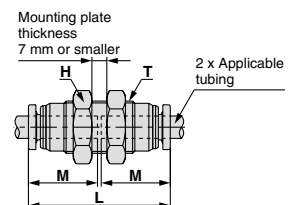

- K
- M
- H
- KK
- D
- MS
- LQ
- MQR
- T

Series *KQB* Made to Order

Please contact SMC for detailed dimensions, specifications, and lead times.



1 Electroless Nickel Plated

Symbol

-X2

All brass parts are electroless nickel plated.

Example) **KQBH04-01S-X2**

• Electroless nickel plated



Series KQB Specific Product Precautions

Be sure to read before handling. Refer to front matters 58 and 59 for Safety Instructions and pages 13 to 16 for Fittings and Tubing Precautions.

Selection

⚠ Caution

1. The pulling strength of polyurethane tube is as follows. The pulling load of the tube used for verifying the mounting of the tube within the fitting should be the values as shown or less in the table below. As reference, the thrust force occurring between the tube and the fitting at 0.8 MPa is shown on the table below.

Pulling Strength

Model	TU0425	TU0604	TU0805	TU1065	TU1208
Without inner sleeve	50 N	80 N	110 N	140 N	140 N
With inner sleeve	160 N	180 N	250 N	450 N	500 N

Reference: Thrust Force Occurring at 0.8 MPa

Model	TU0425	TU0604	TU0805	TU1065	TU1208
Load	10 N	25 N	40 N	65 N	90 N

2. If using water, it is recommended to use an inner sleeve. (Tube may release due to pressure pulsation or water hammer effect.)
3. If using a fluoro-resin tube in an environment where the fluid temperature changes drastically, it is recommended to use an inner sleeve. Otherwise, air leakage may occur or the tube may release from fitting due to deformation of the tube.

Mounting

⚠ Caution

1. The union elbow, union tee and union “Y” should be fixed through the mounting hole.
Otherwise, air leakage or breaking can occur due to a pulling force or moment load created by the product's weight.

Installation and Removal of Tubing

⚠ Caution

1. Installation of tubing

- 1) Grease is not used for the KQB series, therefore a greater insertion force is required when the tubing is installed. In particular, polyurethane tubing may fold when inserted due to its softness. Hold the end of the tubing, and insert it all the way in slowly and securely. Refer to dimension “M” in the dimension drawings for guidance on the insertion depth of tubing.

2. Removal of tubing

- 1) For tubing used at a high temperature or for an extended period of time, there is a possibility that it will not fit into a one-touch fitting again due to an enlarged O.D. Dispose of the tubing and replace it with a new one.

K

M

H

KK

D

MS

LQ

MQR

T