

Building Automation System BAS-2000 Series

BAS-2000 Series	Building Automation System Overview	17-2
BAS-2000 Series	System Configuration	17-4
BAS-2000 Series	BACnet & Modbus Communication	17-5
KW SoftLogic & BA Function Library	IEC 61131 Softlogic Digital Control programming software & function library	17-6
BAS-2520/2514 Series (New)	DOS-based Softlogic Digital Controller	17-8
BAS-2020/2014 Series (New)	20/14-ch Universal Input/Output modules	17-10
BAS-4022T (New)	Dual Loop Thermistor PID Controller	17-12

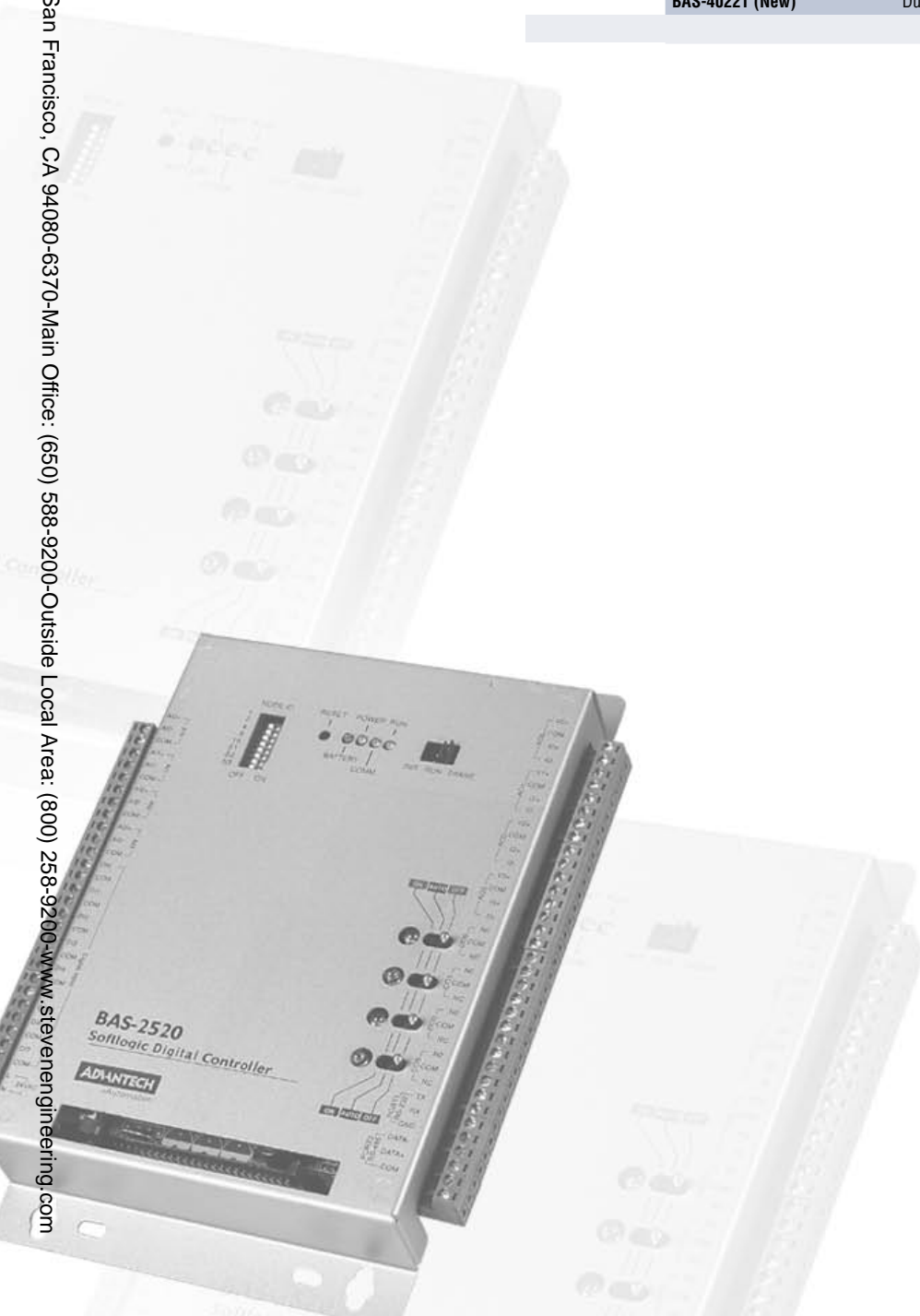

BAS-2000 Series

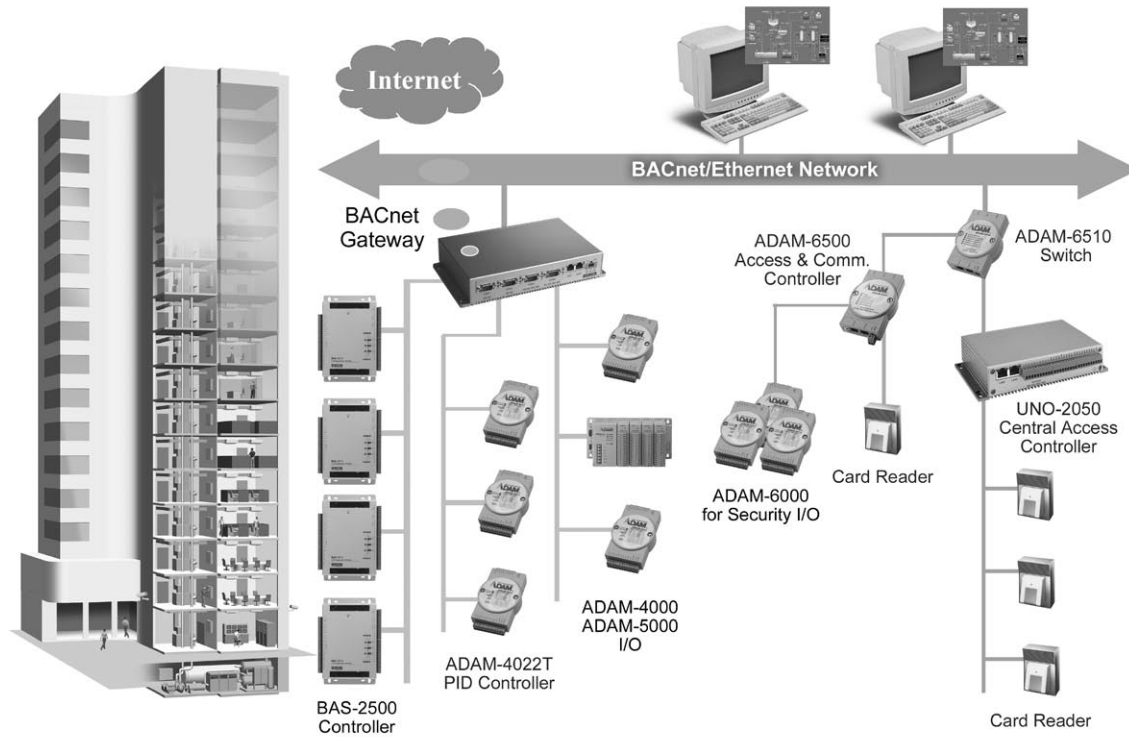

Market Overview

Based on ARC's survey for the worldwide Building Automation market, there is strong growth. They estimate the total market revenue will be grow from 20.4 billions in 2004 to 21.5 billions in 2005 to 24.4 billions in 2006.

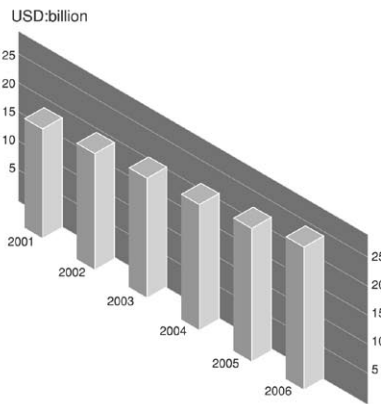

A building automation system includes: HVAC-DDC, Security Access, Fire Alarms, Lighting and others miscellaneous equipment. The HVAC system uses about 60% of the energy consumption for a building, so HVAC control would be the most important system for BAS applications. If we look at the total cost of a BAS system, the HVAC system will represent 55%.

BAS Business by System Type (Percent of Revenues)

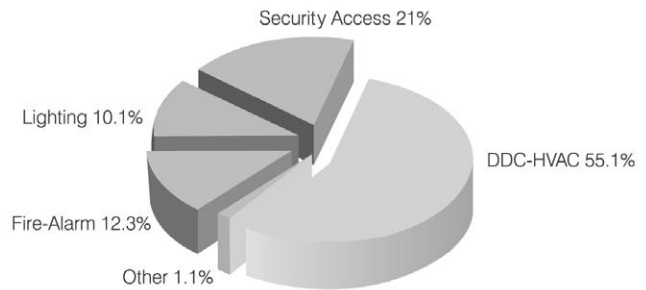

	DDC System	PLC System
Control Model	Stand-alone control	Stand-alone control
I/O Type	Universal I/O design	Specific I/O design
Networking	RS-485 or RS-232	Serial or Ethernet
Programming Tool	Easy parameter setting	Ladder / Functional block
HMI Software	Device-oriented environment	Object-oriented environment
Integration Capacity w/HMI	Allows integration with proprietary HMI only	Allows Integration with most HMI software

Building Automation System Overview

Controller for Building Automation

A Building Automation system is a different purposed application from typical industrial automation applications. It is designed for commercial building requirements, not for industrial environment requirements. So the controller should be designed for this purpose.

The DDC (Direct Digital Controller) is a controller dedicated to Building Automation applications. The DDC controller must be a stand-alone operating unit, and in order to satisfy the requirements of building I/O and control applications, the I/O design of DDC is universal. Because of wiring costs and wiring installation environments, RS-485 is the major physical layer of the network. Most importantly, the DDC must be a stand-alone operation. Please refer to the table on the previous page for a comparison of the DDC and typical PLC control systems.

System Network

Because of the lower wiring costs and simpler installation, RS-485 is the standard network protocol in the control and device layer of building automation system networks.

Power Supply Requirements

The power supply requirements of typical BAS devices are quite different from industrial equipment. Most industrial controllers and devices are designed with 110/220 V AC or 24 V DC power supply, while most BAS controllers use 24 V AC.

Communication Protocol

BA system networks have their own standards. There are two major standards for BAS networks: BACnet and LonWorks. BACnet (Building Automation Control network) was defined by ASHRAE (American Society of Heating, Refrigerating and Air-conditioning Engineers), the major institute of HVAC vendors in the world. Because it was defined by ASHRAE, it is widely used and accepted for HVAC equipment. LonWorks was defined by Echelon, which is a private company. The basic system architectures of these two standards are different. The BACnet system architecture is quite similar to a typical industrial control system network, so it is more suitable for BA systems in commercial buildings. It has therefore gained the position of almost becoming the de-facto standard for BA systems in commercial buildings. The Advantech BAS-2000 system is designed with this protocol as its standard communication protocol, and for compatibility with 3rd party devices, MODBUS/RTU is also supported.



Special Control Functions for BAS

BA systems must be designed for the behavior of the people inside the building, and since the operators and users are unlikely to be engineers or familiar with BA systems, the BAS controls must be designed to be as simple as possible.

For example, a commercial building can be used for offices, hotels and apartments simultaneously. To save energy and operating costs, some parts of the building may be scheduled to reduce/increase the temperature to a level closer to the outside temperature. A schedule function is therefore very important for building automation systems.

HVAC is usually the major control system used in buildings and air-conditioning is a major part of HVAC. Air-conditioning is an industry with much technology know-how, but it has traditionally been the domain of mechanical engineers. Most programmers have difficulties making a solid control program for such applications. So building automation control software must have many built-in HVAC control functions.

Advantech BAS-2000 products have built-in these control functions into a function block library for easy access and development.

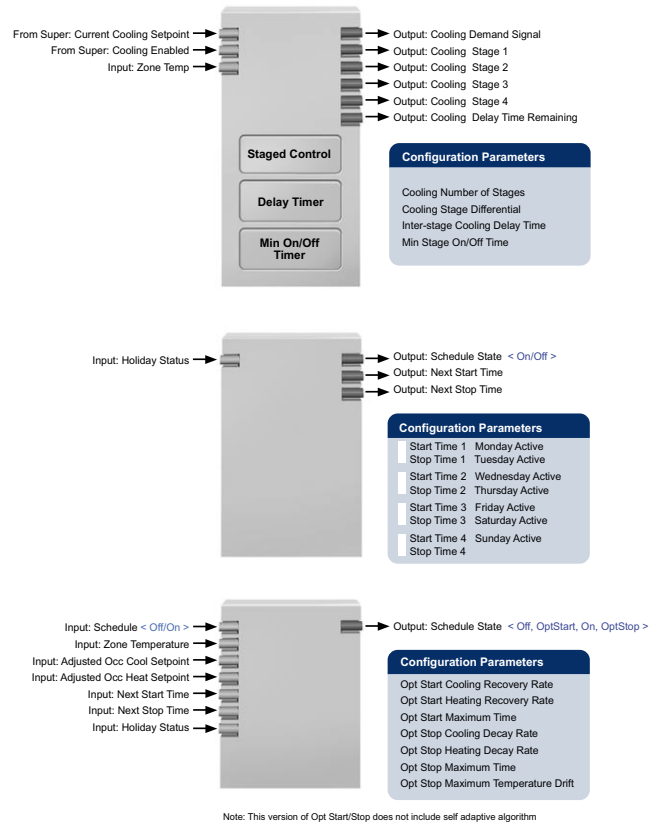

1	Software
2	IPPC
3	TPC
4	FPM
5	ATM & AWS
6	DA&C
7	cPCI
8	ADAM-3000
9	Motion Control
10	ICOM
11	eConnectivity
12	UNO
13	ADAM-4000
14	ADAM-5000
15	ADAM-6000
16	ADAM-8000
17	BAS

BAS-2000 Series

Building Automation System Configuration

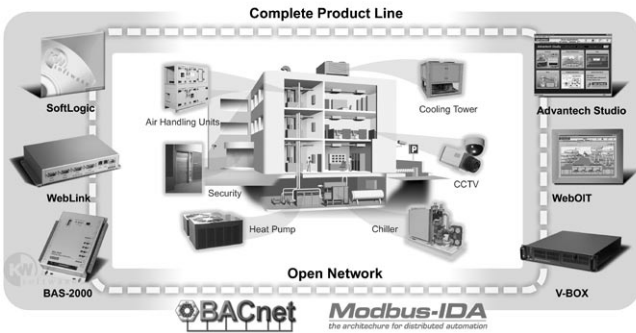

Introduction

Advantech offers a total solution for Building Automation systems including facility management (HVAC, water treatment, power, etc.), security (access control, door/window alarm, etc.) and CCTV systems. Equipped with Advantech's BAS-2000, UNO, VBox and ADAM modules, system integrators can easily create powerful and flexible BAS applications.

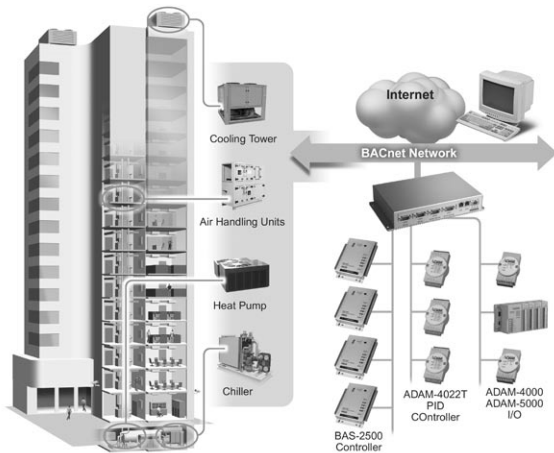

Advantech BAS Facility Management Solution

The facility management system includes the control of :

- Chiller Plants
- Water Pumps
- Waste Water Treatment
- Cooling Towers
- Heat Pumps
- Other HVAC Equipment
- Environment Monitoring System (Temperature, Humidity, etc.)
- Other Facility Control/Monitoring Applications

For facility control applications like chiller plant automation, water pump control and cooling tower control, the BAS-2000 system with KW's BA function block library can help build a powerful control system. For distributed zone temperature control, the BAS-4022T dual-loop PID controller would be a perfect selection, and the ADAM-4000 and ADAM-5000 I/O data acquisition modules can be used for facility and environment monitoring systems.

Security System

The scope of a typical security system can include :

- Access Control
 - Card reader for system access
 - Access history record
- Illegal access monitoring/alarm system

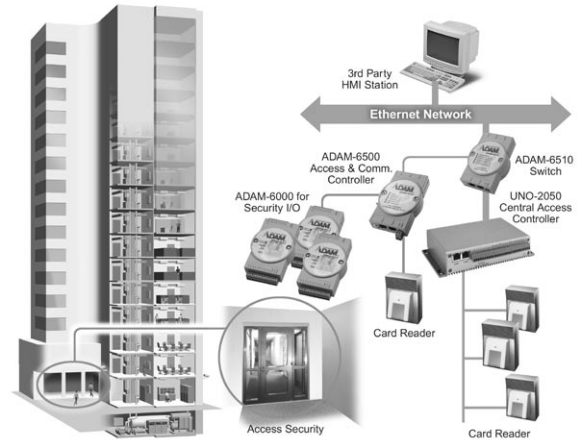

For access control systems, the UNO-2000 series and ADAM-6500 PC-based platform would be an ideal choice. The ADAM-6000 DI/O module with an event trigger function via the UDP protocol can be a real-time response to start security alarms.

Video System

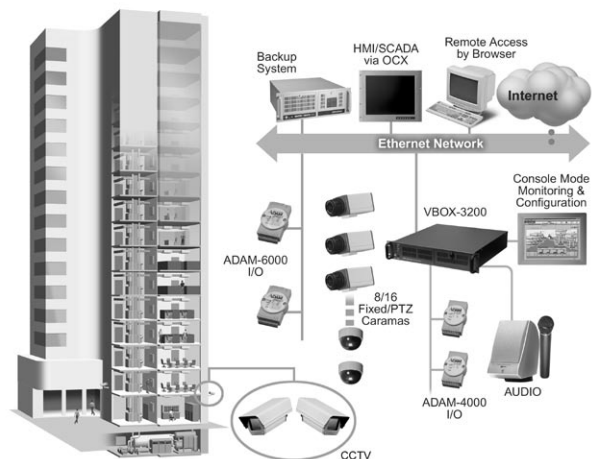

The VBOX-3200 series is the CCTV system platform for Advantech's BA solution. It supports the MPEG-4 compression algorithm, up to 480 FPS video display and 120 FPS recording capacity, web-enabled remote monitoring, playback function and motion detection plus much more. By equipping it with ADAM I/O modules as a security interlock I/O it can satisfy any requirement for CCTV and security applications.

BAS-2000 Series

BACnet & Modbus Communication

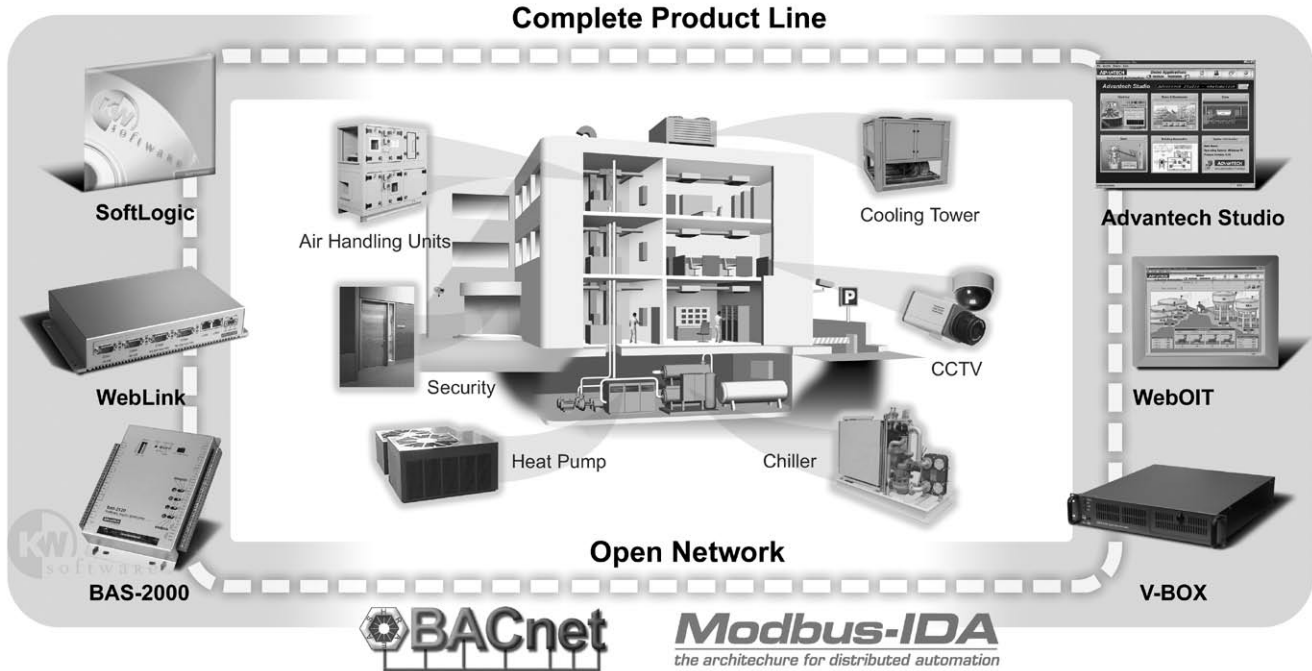

Introduction

The BAS-2000 series supports both BACnet and Modbus protocols. Selection of protocol can be done with software. For the BACnet protocol, BAS-2000 supports the format of BACnet MS/TP. For the Modbus protocol, MODBUS/RTU is the format supported.

Why BACnet

BACnet (Building Automation Control network) protocol is developed by the ASHRAE (American Society of Heating, Refrigeration and Air Conditioning Engineers). It has become the most popular Building Automation network standard worldwide, and most BAS devices and HVAC equipment has been built with this protocol now. Because the main physical layer of the network in the BAS controller layer is RS-485, the format of the BACnet protocol being used in RS-485 is BACnet MS/TP. This is a good reason why the BAS-2000 series use the BACnet MS/TP as its default protocol.

Why Modbus

Modbus is the most popular protocol in automation systems so far. Almost all traditional control systems or equipment support or is compatible with this protocol. It is widely used in general-purpose devices and equipment.

In a typical building there are power systems, water supply systems, HVAC systems, water treatment systems and so on. These systems require quite a lot of machinery, and most of this machinery is not designed for building automation systems. They are designed for both building and industrial applications, and therefore do not support the BACnet protocol. But the Modbus protocol can usually be found in these machines.

For a complete building automation system, all equipment should be controlled by one system. The easiest method to implement this is by using a BAS DDC controller. But most traditional DDC controllers don't support this feature. The BAS-2000 series controllers supports Modbus, which means you can create Modbus compatible building automation control systems and control all equipment in a building with one system.

1	Software
2	IPPC
3	TPC
4	FPM
5	ATM & AWS
6	DA&C
7	cPCI
8	ADAM-3000
9	Motion Control
10	ICOM
11	eConnectivity
12	UNO
13	ADAM-4000
14	ADAM-5000
15	ADAM-6000
16	ADAM-8000
17	BAS

KW SoftLogic & BA Function Library

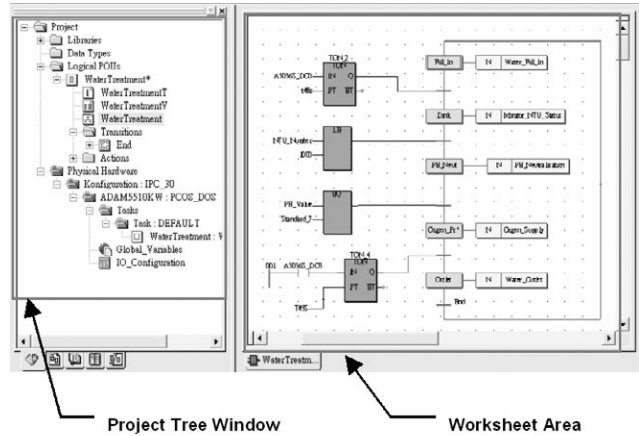

Project Tree Window

Worksheet Area

Introduction

To make it easier for system integrators to approach the building automation market, the BAS-2000 series is not only embedded with KW SoftLogic software, Advantech has also developed several function blocks that are especially made for building automation applications. These function blocks were developed by experienced BAS consultants in USA. The 30+ building automation function blocks are bundled with the BAS-2000 series, so the control programming work on the BAS-2000 series is the same as a typical DDC. There is no need to create control programs by complicated basic functions such as block and ladder assembly. Just pull the required BA function block into the KW programming worksheet for the specific building control application. It will save programming time, and by using the qualified BA function block, it can reduce potential programming errors for the controller application.

Flexible Expansion

The BAS-2000 series use KW SoftLogic as its control engine. KW SoftLogic opens the function block editing interface for Advantech, that is, new function blocks can be added into the BAS-2000 series controllers at any time. You can use C programming to make a control application program, then compile it to become a function block for KW SoftLogic. Advantech will continuously develop and collect more value-adding building automation function blocks for the BAS-2000 system. Compared with traditional DDCs, the BAS-2000 series of controllers will be much more powerful in the future.

Function Block Libraries

Unitary Zone Temperature-Based Function Blocks

Stage Cooling Control

Provides control of up to four mechanical cooling stages based on the HVAC unit's zone temperature. The Device Supervisor block enables or disables the mechanical cooling section.

Modulating Cooling Control

Provides control of any modulating cooling device such as a valve or damper based on the HVAC unit's zone temperature. The Device Supervisor block enables or disables the mechanical cooling section.

Staged Heating Control

Provides control of up to four heating stages based on the HVAC unit's zone temperature. The Device Supervisor block enables or disables the heating section.

Modulating Heating Control

Provides control of any modulating heating device such as a valve or damper based on the HVAC unit's zone temperature. The Device Supervisor block enables or disables the heating section.

Heat Pump Reversing Valve Control

Provides control of Heat Pump points based on outputs from Staged Cooling and Heating Control Blocks and the values of the listed configuration parameters.

Economizer Control

Enthalpy Calculation

Calculates the Total Heat Content for one zone or air stream. Typically two zones or air streams are compared and the air stream with the least total heat content is identified as the lowest cost cooling source.

Single Speed Fan Control

Provides On/Off control of a single speed fan. The Device Supervisor block sets the Occupancy Mode and HVAC Mode.

VFD Fan Control

Provides control of a Fan Start/Stop point and Fan Speed based on the HVAC unit's Supply Air Static Pressure. The Device Supervisor block sets the Occupancy Mode and HVAC Mode.

Return Fan Tracking

Provides control of Return Fan Start/Stop and Return Fan Speed based on either a percentage of Supply Fan speed, or a fixed CFM offset in the Return Air-stream versus that of the Supply Air-stream.

Sliding Window Smoothing

Smooths out fluctuating values by performing a sliding window average of a number of separate readings of the same value using the parameters listed.

CFM Calculation

Converts measured Velocity Pressure into CFM airflow, using the parameters listed.

Device Supervisor Control "Super"

The Device Supervisor reads in all building-wide information pertaining to the status of Schedules, Holidays, Free Cooling, Electrical Demand, Emergency and other conditions. It also contains all zone-specific setpoints and settings for how to respond to changes in the building-wide values.

IEC 61131 Softlogic Digital Control programming software & function library

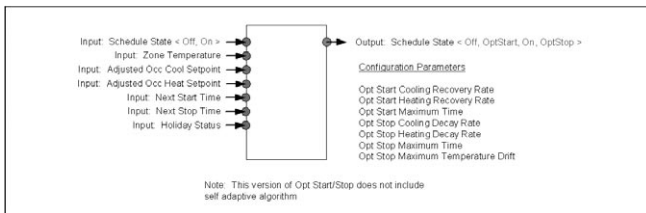
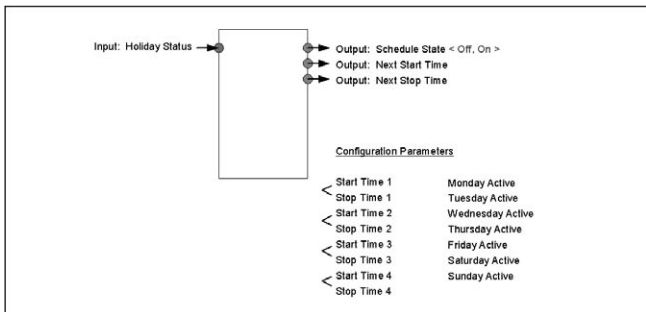
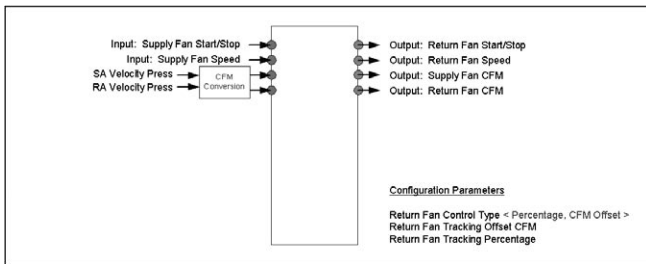
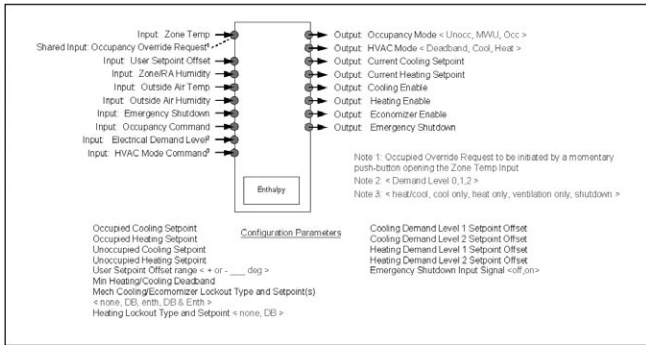
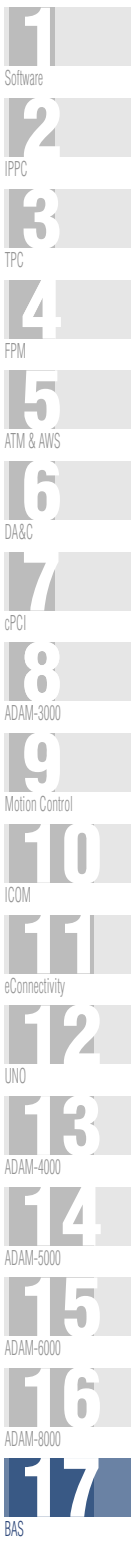

Schedule

Provides scheduling capabilities within the unitary controller. The user may enter up to 4 start and stop time pairs, and identify which days of the week those times apply to. Multiple schedules may be used to handle different start and stop times on different days of the week.

Optimum Start/Optimum Stop

Calculates the amount of Early Start Time required to achieve Adjusted Occupied Cooling or Heating zone setpoint at the Next Start Time (from schedule), and the amount of Early Stop Time permissible (which will result in no more temperature drift from setpoint than that specified in Opt Stop Maximum Temperature Drift) by the Next Stop Time. The Schedule State Output will take the Schedule and Optimum Start/Stop times into account and set the integrated Schedule State accordingly.

Alarm

Provides High and Low Zone temperature Alarming capabilities during Occupied periods, based on user entries. Enable Delay sets the amount of time to hold off alarms upon first transitioning to Occupied for the day (this will allow for warm-up, etc.). Alarm Delay sets the amount of time the Zone Temperature may be outside of the safe range before an Alarm is generated. This type of delay is helpful to reduce nuisance alarms, etc.

Minimum Timer

Minimum On Satisfied will be set on once the Monitored Value has been on at least the amount of time specified in Min On Time. Similarly, the Minimum Off Satisfied will be set on once the Monitored Value has been off at least the amount of time specified in Min Off Time.

Delay Timer

On Delay Wait Satisfied will be set on once the Monitored Value has been on at least the amount of time specified in On Delay Wait Time. Off Delay Hold Active will be set on when the Monitored Value goes on. It will stay on until the Monitored Value has transitioned to off, and has been off at least the amount of time specified in Off Delay Hold Time.

“Generic” Function Blocks to add built up Air Handler and other additional functionality

Modulating Control/Modulating Control with Reset

Provides control of any modulating device such as a cooling or heating valve or damper, or a pressure controlled VFD, based on the Control Input. The Enable Input enables or disables the block. When disabled, the Demand Signal Output will be set to 0.0%.

Staged Control/Staged Control with Reset

Provides control of up to eight stages of heating, cooling, pressure, etc., based on the Control Input. The Enable Input enables or disables the block. When disabled, the Demand Signal output will be set to 0.0% and all stages will be set off.

General Alarm Signal Inversion

BAS-2520

20-Channel Softlogic Digital Controller

NEW



Features

- Stand-alone programmable controller
- Pre-built BA Control Function Blocks
- Supports IEC61131-3 control languages
- Supports Modbus/RTU and BACnet protocols
- Up to 115.2 kbps communication speed
- Max. I/O expansion up to 80 points for unique controller
- Built-in Watchdog Timer
- Wall mounting panel case

Introduction

BAS-2520 is a 20-channel stand-alone controller for building automation control applications. Designed as a typical DDC (Direct Digital Controller), but customized for use in buildings, it is designed with universal I/O, a thin wall mountable case, and comes with embedded control algorithms for HVAC, lighting, security and other algorithms that are used in building automation applications.

SoftLogic Programming

This powerful, stand-alone controller is intuitive and easy to use. All controllers in the BAS-2000 series use KW SoftLogic for their programming, which is fully compatible with the IEC61131-3 standard. You can use multiple languages such as: Function Block Diagram (FBD), Sequential Flow Chart (SFC), Ladder Diagram (LD), Structure Text (ST) and Instruction List (IL) for control function configuration. This reduces engineering efforts, as there is no need to learn proprietary programming languages, and development time can be drastically reduced.

Open Modbus/RTU Protocol

The controllers of the BAS-2000 series use the Modbus/RTU protocol, which is the most popular and cost effective solution for field data communication, with transmission speeds up to 115.2 kbps. By using the Modbus/RTU protocol, it is much easier to integrate control data between a BAS-2000 series controller and field machinery such as compressors, chillers, inverters and power panels. The BACnet MS/TP protocol will be an optional protocol in the near future.

Specifications

- **Channels** 20
- **Communication** Port 1 : RS-232 for programming,
Port 2 : RS-485 for Network
Max. Communication Distance : 4000 feet (1.2 km)
Speed : 1200, 2400, 9600, 19200, 38.4 k, 57.6 k,
115.2 kbps Up to 256 node in network
- **I/O Type** On-board 4 AI, 8 DI, 4 AO and 4 DO
(Local Bus for I/O expansion up to total 80 points)
- **Analog Input** 4 ~ 20 mA, 0 ~ 20 mA, 0 ~ 10 V_{DC}, RTD
(PT100/PT1000, Thermistor (software configurable))
- **Digital Input** Dry Contact Logic level 1 : close
Logic level 0 : open
Wet Contact Logic level 1 : +10 ~ 30 V_{DC}
Logic level 0 : +3 V_{DC} max.
- **Analog Output** 4 ~ 20 mA, 0 ~ 20 mA, 0 ~ 10 V_{DC}
(software configurable)
- **Digital Output** Dry Contact (Rating : 240 V_{AC}, 3 A), LED indicator,
manual switch for ON/AUTO/OFF selection
- **LED Indicators** Battery, Power, Communication (for RS-485)

- **Built-in Watchdog Timer**

- **Power Requirement** 24 V_{AC}

- **Power Consumption** 15 W

- **Environment** Operating Temp. : -10 ~ 60 °C (14 ~ 140 °F)
Storage Temp. : -25 ~ 85 °C (-13 ~ 185 °F)
Humidity : 5 ~ 95% non-condensing

Ordering Information

- **BAS-2520** 20-Channel Softlogic Digital Controller

BAS-2514

14-Channel Softlogic Digital Controller

- 1 Software
- 2 IPPC
- 3 TPC
- 4 FPM
- 5 ATM & AWS
- 6 DA&C
- 7
- 8 cPCI
ADAM-3000
- 9 Motion Control
- 10 ICOM
- 11 eConnectivity
- 12 UNO
- 13 ADAM-4000
- 14 ADAM-5000
- 15 ADAM-6000
- 16 ADAM-8000
- 17 BAS

NEW



Features

- Stand-alone programmable controller
- Pre-built BA Control Function Block
- Support IEC61131-3 control languages
- Supports Modbus/RTU and BACnet protocols
- Up to 115.2 kbps communication speed
- Max. I/O expansion up to 74 points for unique controller
- Built-in Watchdog Timer
- Wall mounting panel case

Introduction

BAS-2514 is a 14-channel stand-alone controller for building automation control applications. Designed as a typical DDC (Direct Digital Controller), but customized for use in buildings. It is designed with universal I/O, a thin wall mountable case, and comes with embedded control algorithms for HVAC, lighting, security and other algorithms that are used in building automation applications.

SoftLogic Programming

This powerful, stand-alone controller is intuitive and easy to use. All controllers in the BAS-2000 series use KW SoftLogic for their programming, which is fully compatible with the IEC61131-3 standard. You can use multiple languages such as: Function Block Diagram (FBD), Sequential Flow Chart (SFC), Ladder Diagram (LD), Structure Text (ST) and Instruction List (IL) for control function configuration. This reduces engineering efforts, as there is no need to learn proprietary programming languages, and development time can be drastically reduced.

Open Modbus/RTU Protocol

The controllers of the BAS-2000 series use the Modbus/RTU protocol, which is the most popular and cost effective solution for field data communication, with transmission speeds up to 115.2 kbps. By using the Modbus/RTU protocol, it is much easier to integrate control data between a BAS-2000 series controller and field machinery such as compressors, chillers, inverters and power panels.

Specifications

- **Channels** 14
- **Communication** Port 1 : RS-232 for programming,
Port 2 : RS-485 for Network
Max. Communication Distance : 4000 feet (1.2 km)
Speed : 1200, 2400, 9600, 19200, 38.4 k, 57.6 k,
115.2 kbps
Up to 256 nodes in network
- **I/O Type** On-board 4 AI, 4 DI, 3 AO and 3 DO (Local Bus for I/O
expansion up to total 74 points)
- **Analog Input** 4 ~ 20 mA, 0 ~ 20 mA, 0 ~ 10 V_{DC}, RTD
(PT100/PT1000, Thermistor (software configurable))
- **Digital Input** Dry Contact Logic level 1 : close
Logic level 0 : open
Wet Contact Logic level 1 : +10 to 30 V_{DC}
Logic level 0 : +3 V_{DC} max.
- **Analog Output** 4 ~ 20 mA, 0 ~ 20 mA, 0 ~ 10 V_{DC}
(software configurable)
- **Digital Output** Dry Contact (Rating : 240 V_{AC}, 3A), LED indicator,
manual switch for ON/AUTO/OFF selection
- **LED Indicators** Battery, Power, Communication (for RS-485)
- **Built-in Watchdog Timer**
- **Power Requirement** 24 V_{AC}

- **Power Consumption** 15 W
- **Environment** Operating Temp. : -10 ~ 60 °C (14 ~ 140 °F)
Storage Temp. : -25 ~ 85 °C (-13 ~ 185 °F)
Humidity : 5 ~ 95% non-condensing

Ordering Information

- **BAS-2514** 14-Channel Softlogic Digital Controller

BAS-2020

20-Channel I/O Expansion Module



Features

- 20-channel I/O Expansion Module for BAS-2514 and BAS-2520
- Local Bus Connection with BAS-2514 and BAS-2520
- Up to 2 meters expansion
- Power Supplied by BAS-2514 and BAS-2520 through Local Bus Cable, no External Power Supply Required
- Wall Mounting panel case

Introduction

BAS-2020 is a 20-channel expansion module for a BAS-2000 system. The I/O capacity of a BAS-2000 system can easily be expanded by cost-effective I/O expansion modules. Up to three expansion modules can be added to the controller, so you can get the number of I/O points you need. Combine a controller with different expansion modules for: 28, 34, 40, 42, 48, 54, 56, 60, 62, 68, 74 or 80 I/O points.

No External Power Required

To reduce wiring costs and make the modules easier to configure, the BAS expansion modules were designed to be powered by the connected BAS-2000 controller. The required power for the I/O expansion module is transferred through the local bus from the BAS-2000 controller. No additional power supply module or power wiring is required.

Specifications

- **Channels** 20
- **I/O Type** On-board 4 AI, 8 DI, 4 AO and 4 DO
- **Analog Input** 4 ~ 20 mA, 0 ~ 20 mA, 0 ~ 10 V_{DC}, RTD (PT100/PT1000, Thermistor (software configurable))
- **Digital Input**
 - Dry Contact Logic level 1 : close
Logic level 0 : open
 - Wet Contact Logic level 1 : +10 to 30 V_{DC}
Logic level 0 : +3 V_{DC} max.
- **Analog Output** 4 ~ 20 mA, 0 ~ 20 mA, 0 ~ 10 V_{DC} (software configurable)
- **Digital Output** Dry Contact (Rating : 240 V_{DC}, 3 A), LED indicator, manual switch for ON/AUTO/OFF selection
- **LED Indicators** Power
- **Built-in Watchdog Timer**
- **Power Requirement** No External Power Supply Required (The I/O Expansion Module is powered by Controller through Local Bus)
- **Power Consumption** 15 W
- **Environment** Operating Temp. : -10 ~ 60 °C (14 ~ 140 °F)
Storage Temp. : -25 ~ 85 °C (-13 ~ 185 °F)
Humidity : 5 ~ 95% non-condensing

Ordering Information

- **BAS-2020** 20-Channel I/O Expansion Module

BAS-2014

14-Channel I/O Expansion Module



Features

- 14-channel I/O Expansion Module for BAS-2514 and BAS-2520
- Local Bus Connection with BAS-2514 and BAS-2520
- Up to 2 meters Expansion Length
- Power Supplied by BAS-2514 and BAS-2520 through Local Bus Cable, no External Power Supply Required
- Wall Mounting panel case

Introduction

BAS-2014 is a 14-channel expansion module for a BAS-2000 system. The I/O capacity of a BAS-2000 system can easily be expanded by cost-effective I/O expansion modules. Up to three expansion modules can be added to the controller, so you can get the number of I/O points you need. Combine a controller with different expansion modules for: 28, 34, 40, 42, 48, 54, 56, 60, 62, 68, 74 or 80 I/O points.

No External Power Required

To reduce wiring costs and make the modules easier to configure, the BAS expansion modules were designed to be powered by the connected BAS-2000 controller. The required power for the I/O expansion module is transferred through the local bus from the BAS-2000 controller. No additional power supply module or power wiring is required.

Specifications

- **Channels** 14
- **I/O Type** On-board 4 AI, 4 DI, 3 AO and 3 DO
- **Analog Input** 4 ~ 20 mA, 0 ~ 20 mA, 0 ~ 10 V_{DC}, RTD (PT100/PT1000, Thermistor (software configurable))
- **Digital Input**
 - Dry Contact Logic level 1 : close
Logic level 0 : open
 - Wet Contact Logic level 1 : +10 to 30 V_{DC}
Logic level 0 : +3 V_{DC} max.
- **Analog Output** 4 ~ 20 mA, 0 ~ 20 mA, 0 ~ 10 V_{DC} (software configurable)
- **Digital Output** Dry Contact (Rating : 240 V_{AC}, 3 A), LED indicator, manual switch for ON/AUTO/OFF selection
- **LED Indicators** Power
- **Built-in Watchdog Timer**
- **Power Requirement** No External Power Supply Required (The I/O Expansion Module is powered by Controller through Local Bus)
- **Power Consumption** 15 W
- **Environment** Operating Temp. : -10 ~ 60 °C (14 ~ 140 °F)
Storage Temp. : -25 ~ 85 °C (-13 ~ 185 °F)
Humidity : 5 ~ 95% non-condensing

Ordering Information

- **BAS-2014** 14-Channel I/O Expansion Module

- 1 Software
- 2 IPCC
- 3 TPC
- 4 FPM
- 5 ATM & AWS
- 6 DA&C
- 7 cPCI
- 8 ADAM-3000
- 9 Motion Control
- 10 ICOM
- 11 eConnectivity
- 12 UNO
- 13 ADAM-4000
- 14 ADAM-5000
- 15 ADAM-6000
- 16 ADAM-8000
- 17 BAS

BAS-4022T

Dual Loop PID Controller



Features

- 2 loop PID control algorithms built in one package
- 2 Analog Input/1 Analog Output/1 Digital Input/1 Digital Alarm Output for 1 PID loop
- Analog Input Signal : 4 ~ 20 mA, 0 ~ 10 V_{DC}, 3 k & 10 k Thermistor
- Analog Output Signal : 0 ~ 10 V_{DC}, 0 ~ 20 mA, 4 ~ 20 mA
- Heating/Cooling (Direct/Reverse) Action Mode
- Loop Open/Close (PID Disable/Enable) and Analog Output Manual Control Modes
- 512 KB Prog. Memory
- First Order Filter
- System Emergency Shutdown
- Modbus/RTU Protocol Support

Introduction

Temperature PID controllers have been widely used in HVAC systems in building automation. Advantech offers the compact dual loop controller BAS-4022T. In addition to dual-loop design for economic reasons, BAS-4022T can be applied to various signals in the field such as: 4-20 mA, 0-10 V_{DC}, 3k and 10k thermistor. BAS-4022T also supports the Modbus/RTU protocol. HMI software can be used to easily access the module to monitor I/O data and change the control parameters through a Modbus interface, Modbus driver or Modbus OPC server.

Built-in PID Loop Control Algorithms

BAS-4022T has been built with 2 PID control loops. There are two analog inputs, one analog output, one digital input and one digital output for I/O control parameters for each loop. For the two analog input signals, AI#1 is for Pv1, and AI#2 is for Pv2. The analog output signal is for the Mv output value. Digital input can be used for the emergency shutdown input signal. It could remotely stop the PID loop action if there is an emergency situation. One digital output is then designed to be an alarm output if the analog input/output signal value is over its limit and action is required.

Built-in Watchdog Timer

The watchdog timer is designed to automatically reset the CPU if the system fails.

Specifications

- **Channels** 2 loop PID Controller
- **Analog Input** 4 Channel Differential Input
Effective resolution : 16-bit
Input type : 4 ~ 20 mA, 0 ~ 10 V_{DC}, 3 k & 10 k Thermistor
- **Analog Output** 2 Channels
Effective resolution : 12-bit
Output type : 0 ~ 10 V, 0 ~ 20 mA, 4 ~ 20 mA
- **Digital Input** 2 Channels
Protected by photocouple
Support Dry/Wet Contact
- **Digital Output** 2 Channels
Open Collect Output
30 V_{DC}/max, 100 mA
Isolation Voltage : 2000 V_{DC}
- **Input Impedance** 10 Ω
- **Accuracy** ± 0.15% or better
- **Zero Drift** ± 6 mV/ °C
- **Span Drift** ± 25 ppm/ °C
- **CMR @ 50/60 Hz** 92 dB
- **Built-in Watchdog Timer**
- **Individual Wire Burn-Out Detection**
- **Power Requirements** Unregulated +10 ~ +30 V_{DC}
- **Power Consumption** 2 W/Typical, 3 W/Max

Environment

- **Operating Temperature** -10 ~ 60° C
- **EMI** Meets FCC Class A
- **Storage Temperature** -25 ~ 85 °C
- **Humidity** 5 ~ 95% non-condensing

Ordering Information

- **BAS-4022T-A** Dual Loop PID Controller for Building Automation