



Pushing Performance

HARTING Outdoor Solutions



People | Power | Partnership

Transforming customer wishes into concrete solutions



Headquartered in Espelkamp in East Westphalia, Germany, the HARTING Technology Group develops tailored solutions and products revolving around electrical and electronic connector technologies. These offerings focus on power and data transmission applications, as well as on network solutions. Founded in 1945 in Minden, HARTING is currently employing a workforce of more than 3,200 members of staff worldwide.

In today's increasingly knowledge and information shaped societies, the capability to network and integrate with customers and suppliers, as well as technology and business partners is playing the decisive role.

And this applies to national as well as international levels. With 40 Subsidiary companies and Representatives in 27 countries, HARTING is committed to maintaining close proximity to markets and customers. Always at hand on location, HARTING is able to rapidly record market impulses and respond flexibly.



WE ASPIRE TO TOP PERFORMANCE.

Connectors ensure functionality. As core elements of electrical and optical wiring, connection and infrastructure technologies, they are essential in enabling the modular construction of devices, machines and systems across a very wide range of industrial applications. Their reliability is a crucial factor guaranteeing smooth functioning in the manufacturing area, in telecommunications, applications in medical technology – in fact, connectors are at work in virtually every conceivable application area. Thanks to the consistent further development of our technologies, customers enjoy investment security and benefit from durable, long term functionality.

ALWAYS AT HAND, WHEREVER OUR CUSTOMERS MAY BE.

Increasing industrialization is creating growing markets characterized by widely diverging demands and requirements. The search for perfection, increasingly efficient processes and reliable technologies is a common factor in all sectors across the globe.

HARTING is providing these technologies – in Europe, America and Asia. The **HARTING** professionals at our international subsidiaries engage in close, partnership based interaction with our customers, right from the very early product development phases, in order to realize customer demands and requirements in the best possible manner.

Our people on location form the interface to the centrally coordinated development and production departments. In this way, our customers can rely on consistently high, superior product quality – worldwide.

OUR CLAIM: PUSHING PERFORMANCE.

HARTING provides more than optimally attuned components.

In order to serve our customers with the best possible solutions, **HARTING** is able to contribute a great deal more and play a closely integrative role in the value creation process.

From ready assembled cables through to control racks or ready-to-go control desks: Our aim is to generate the maximum benefits for our customers – without compromise!

QUALITY CREATES RELIABILITY – AND WARRANTS TRUST.

The **HARTING** brand stands for superior quality and reliability – worldwide. The standards we set are the result of consistent, stringent quality management that is subject to regular certifications and audits.

EN ISO 9001, the EU Eco-Audit and ISO 14001:2004 are key elements here. We take a proactive stance to new requirements, which is why **HARTING** ranks among the first companies worldwide to have obtained the new IRIS quality certificate for rail vehicles.

HARTING TECHNOLOGY CREATES ADDED VALUE FOR CUSTOMERS.

Technologies by HARTING are at work worldwide. HARTING's presence stands for smoothly functioning systems, powered by intelligent connectors, smart infrastructure solutions and mature network systems. In the course of many years of close, trust-based cooperation with its customers, the HARTING Technology Group has advanced to one of the worldwide leading specialists for connector technology. Extending beyond the basic functionalities demanded, we offer individual customers specific and innovative solutions. These tailored solutions deliver sustained effects, provide investment security and enable customers to achieve strong added value.

OPTING FOR HARTING OPENS UP AN INNOVATIVE, COMPLEX WORLD OF CONCEPTS AND IDEAS.

In order to develop connectivity and network solutions serving an exceptionally wide range of connector applications and task scopes in a professional and cost optimized manner, HARTING not only

commands the full array of conventional tools and basic technologies. Over and beyond these capabilities, HARTING is constantly harnessing and refining its broad base of knowledge and experience to create new solutions that ensure continuity at the same time. In securing this know-how lead, HARTING draws on a wealth of sources from both in-house research and the world of applications alike.

Salient examples of these sources of innovative knowledge include microstructure technologies, 3D design and construction technology, as well as high temperature or ultrahigh frequency applications that are finding use in telecommunications or automation networks, in the automotive industry, or in industrial sensor and actuator applications, RFID and wireless technologies, in addition to packaging and housing made of plastics, aluminum or stainless steel.

HARTING SOLUTIONS EXTEND ACROSS TECHNOLOGY BOUNDARIES.

Drawing on the comprehensive resources of the group's technology pool, HARTING devises

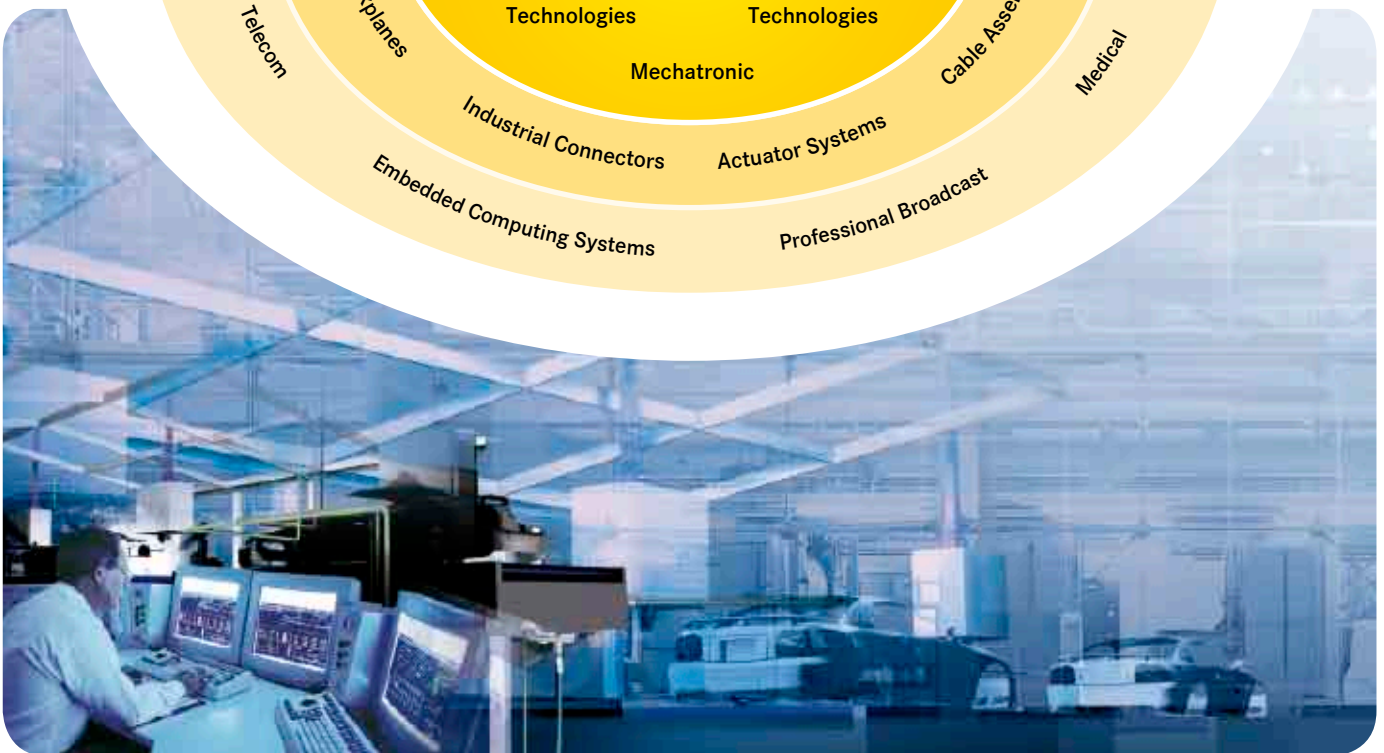
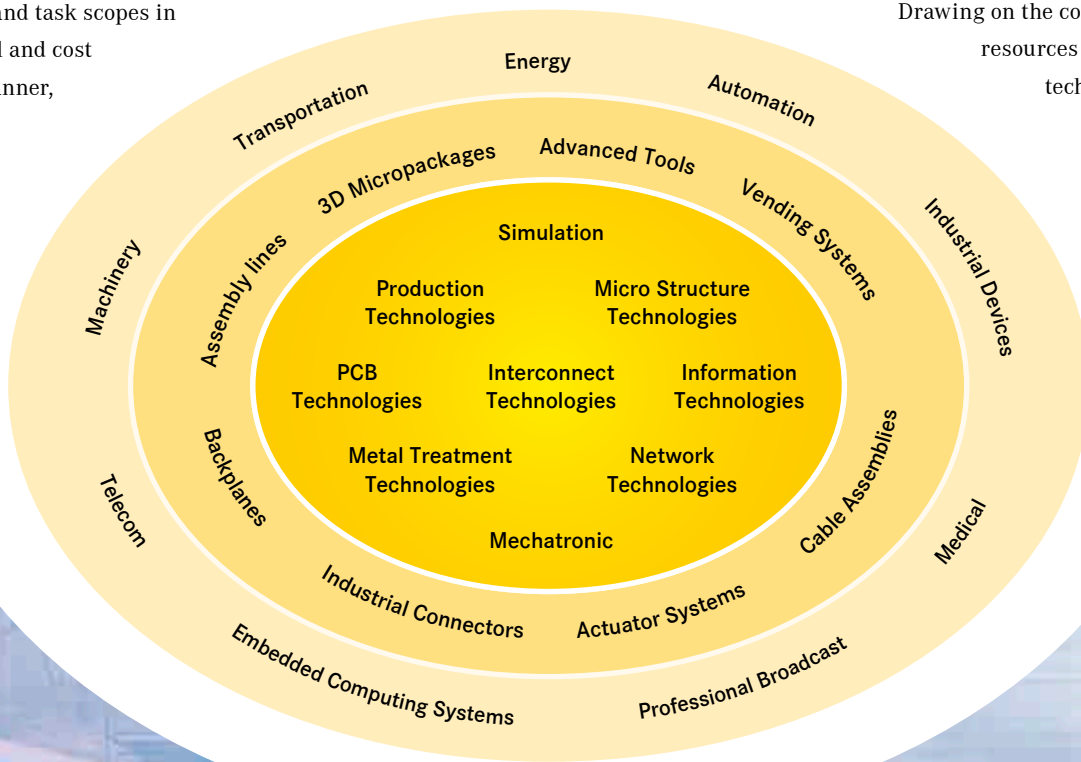

practical solutions for its customers. Whether this involves industrial networks for manufacturing automation, or hybrid interface solutions for wireless telecommunication infrastructures, 3D circuit carriers with microstructures, or cable assemblies for high-temperature applications in the automotive industry - **HARTING** technologies offer far more than components, and represent mature, comprehensive solutions attuned to individual customer requirements and wishes. The range covers ready-to-use cable configurations, completely assembled backplanes and board system carriers, as well as fully wired and tested control panels.

In order to ensure the future proof design of RF- and EMC-compatible interface solutions, the central **HARTING** laboratory (certified to EN 45001) provides simulation tools, as well as experimental, testing and diagnostics facilities all the way through to scanning electron microscopes. In the selection of materials and processes, lifecycle and environmental aspects play a key role, in addition to product and process capability considerations.

HARTING KNOWLEDGE IS PRACTICAL KNOW-HOW GENERATING SYNERGY EFFECTS.

HARTING commands decades of experience with regard to the applications conditions of connectors in telecommunications, computer and network technologies and medical technologies, as well as industrial automation technologies, such as the mechanical engineering and plant engineering areas, in addition to the power generation industry or the transportation sector. **HARTING** is highly conversant with the specific application areas in all of these technology fields.

The key focus is on applications in every solution approach. In this context, uncompromising, superior quality is our hallmark. Every new solution found will invariably flow back into the **HARTING** technology pool, thereby enriching our resources. And every new solution we go on to create will draw on this wealth of resources in order to optimize each and every individual solution. In this way, **HARTING** is synergy in action.

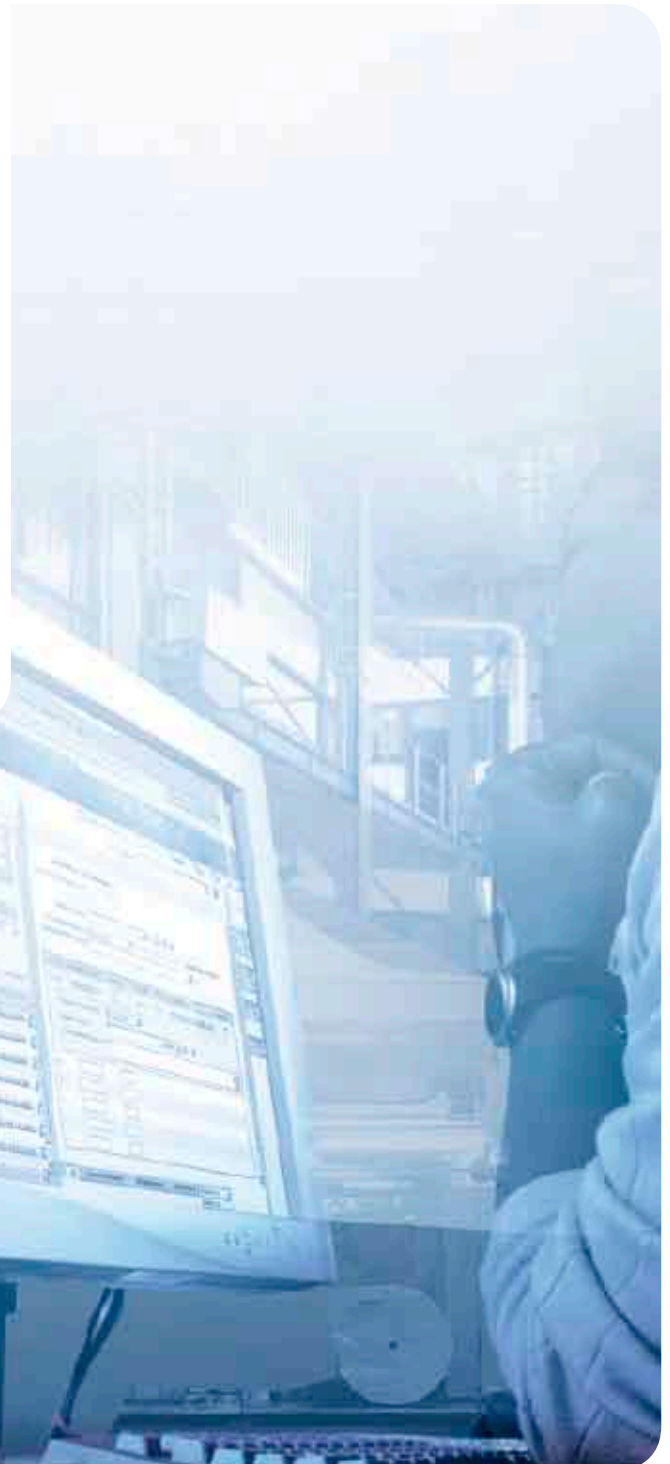



HARKIS® is the abbreviation for **HARTING-Katalog-Informationen-System** (HARTING catalogue information system).

HARKIS® is an electronic catalogue with part configuration and 3D components library. Here you can choose a connector according to your demands. Afterwards you are able to send your inquiry created with the listed parts. The drawings to every single part are available in PDF-format. The parts are downloadable in 2D-format (DXF) and 3D-format (IGES, STEP). The 3D-models can be viewed with a VRML-viewer.

You can find **HARKIS®** at www.HARKIS.HARTING.com. It is also available on CD-ROM and DVD.



Piece part consulting



CAD library



Product samples: Fast-track delivery to your desk, free of charge

With immediate effect, the new express sample dispatching service in the HARTING catalogue information system (**HARKIS®**) allows customers to order samples immediately, easily and free of charge on express delivery. A broad selection from the device connectivity product portfolio is now available. In the case of unavailable items the system offers alternative products with similar features that can be requested at a mouse click.

The samples are shipped within 48 hours after your order, free of charge. This service enables tremendous flexibility, especially in the design phase of projects.

Identification

Part number

HARKIS® CD-ROM
Basic product catalogue

98 40 000 0401

HARKIS® DVD
Basic product catalogue
2D and 3D CAD files inclusive

98 40 000 0405



General information









It is the customer's responsibility to check whether the components illustrated in this catalogue comply with different regulations from those stated in special fields of application which we are unable to foresee.

We reserve the right to modify designs in order to improve quality, keep pace with technological advancement or meet particular requirements in production.

No part of this catalogue may be reproduced in any form (print, photocopy, microfilm or any other process) or processed, duplicated or distributed by means of electronic systems without the written permission of HARTING Electronics GmbH & Co. KG, Espelkamp. We are bound by the English version only.

Outdoor Solutions

Page

Outdoor Solutions – general information		8
IP classes		10
Test schedule		11
Data connectors		
<i>Copper connectors RJ45</i>		
General information		12
Technical characteristics		13
HARTING PushPull RJ45, 4-pole and 8-pole		14
Han® 3 A RJ45, 4-pole		19
Han® 3 A RJ45, 8-pole		20
<i>Fibre optic connectors</i>		
General information		22
Technical characteristics		23
HARTING PushPull LC duplex /		
Han® 3 A 2 x LC duplex		24
LC duplex		26
Power connectors		
General information		27
Technical characteristics		29
HARTING PushPull Power		30
Han® PushPull Power		36
Hybrid connectors		
General information		38
Technical characteristics		39
Han® 3 A hybrid RJ45		40
Han® 3 A hybrid LC duplex		41
Tooling		43
Cable assemblies		
General information		46
Fibre optic and hybrid		47
RJ45 4-wire and 8-wire		50
List of part numbers		54
Company addresses		57

HARTING's new range of products for outdoor solutions combines the advantages of the reliable HARTING PushPull and Han® 3 A housings with innovative inserts for fibre optic and copper.

The integration of the standard LC fibre optic connectors, in singlemode and multimode, meets the demands set by harsh outdoor environments.

The hybrid variants combine data (LC fibre or RJ45) and power in one connector for EasyInstallation and maintenance.

These high-quality, robust HARTING interfaces offer vibration protection and IP 65 / IP 67 as standard. Power solutions and data connectors for the IP 20 environment complete the product range.

All these features make this HARTING connector range ideal for applications such as FTTA (Fibre To The Antenna), FTTH (Fibre To The Home) or LTE and WiMAX, where reliable outdoor connectivity is needed.

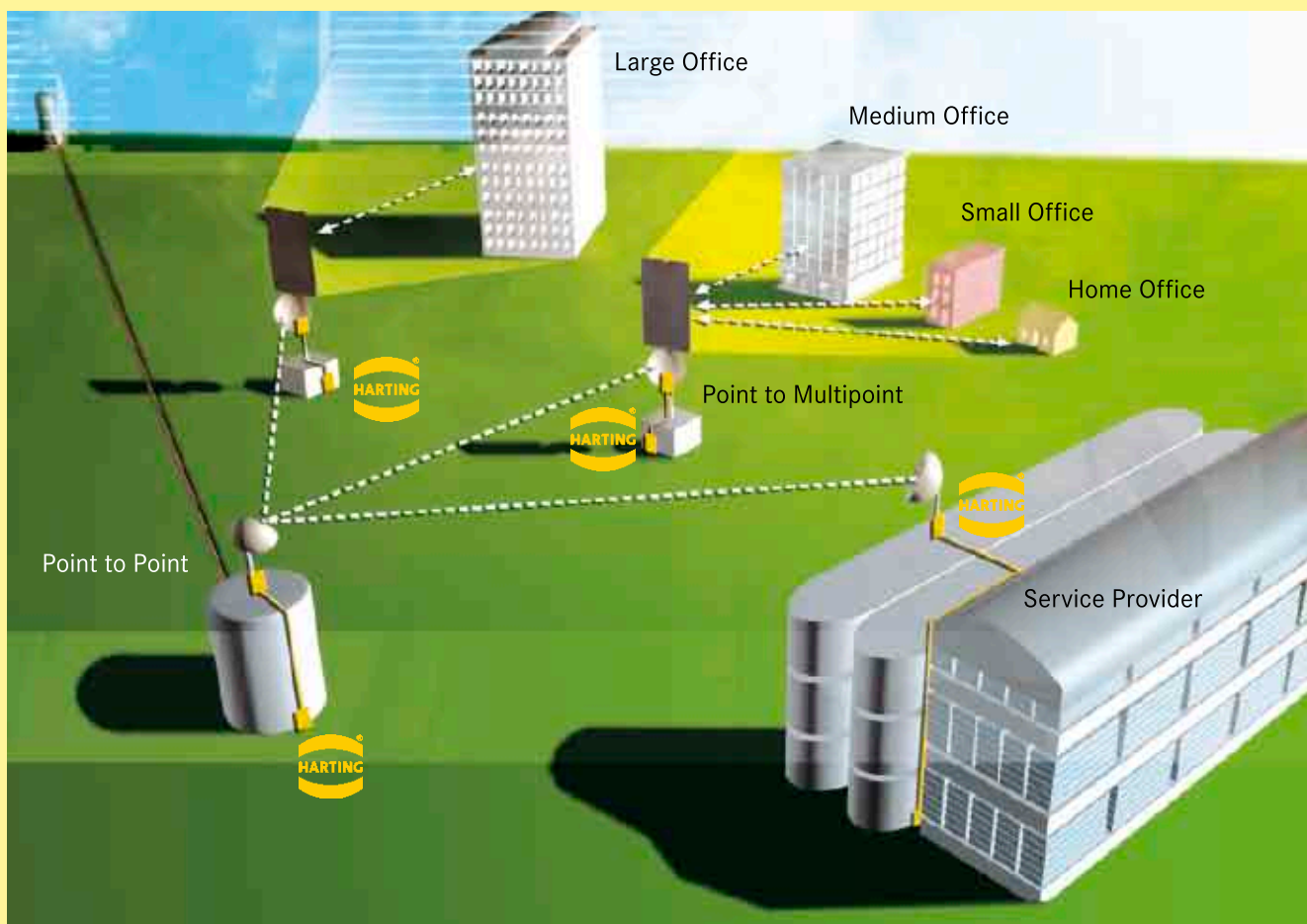

Configurations	
Housings	Inserts
HARTING PushPull	Power <ul style="list-style-type: none"> • DC 48 V / 300 V • AC 230 V / 300 V • 690 V / 16 A
Han® PushPull	Fibre <ul style="list-style-type: none"> • LC duplex • 2 x LC duplex
Han® 3 A M series Please contact us for other housings of Han® 3 A family e.g. plastic, angled, HPR (IP 68)	Hybrid <ul style="list-style-type: none"> • RJ45 & power • LC duplex & power

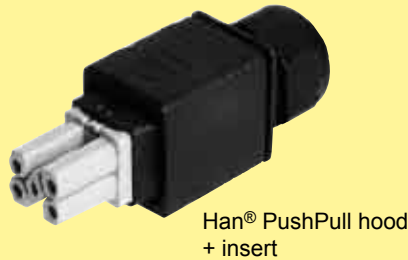
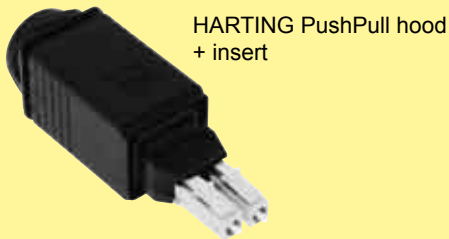

Features & benefits

- Standardized housings
- Smallest size in IP 65 / IP 67
- Up to four standardized LC fibre optic contacts
- Hybrid connectors for data & power
- EasyInstallation
- Advantages during maintenance
- Dedicated for singlemode or multimode fibres

The connector's housing, sealing and locking mechanism protect the connection from external influences such as mechanical shocks, foreign bodies, humidity, dust, water or other fluids such as cleansing and cooling agents, oils, etc. The degree of protection the housing offers is explained in the IEC 60 529, DIN EN 60 529, standards that categorize enclosures according to foreign body and water protection. The following table shows the different degrees of protection.

Code letters (International Protection)		First Index Figure (Foreign bodies protection)		Second Index Figure (Water protection)		
IP		6		5		
Index figure	Degree of protection		Index figure	Degree of protection		
0	No protection		No protection against accidental contact, no protection against solid foreign bodies	0	No protection against water	
1	Protection against large foreign bodies		Protection against contact with any large area by hand and against large solid foreign bodies with Ø > 50 mm	1	Drip-proof 	Protection against vertical water drips
2	Protection against medium sized foreign bodies		Protection against contact with the fingers, protection against solid foreign bodies with Ø > 12 mm	2	Drip-proof 	Protection against water drips (up to a 15° angle)
3	Protection against small solid foreign bodies		Protection against tools, wires or similar objects with Ø > 2.5 mm, protection against small foreign solid bodies with Ø > 2.5 mm	3	Spray-proof 	Protection against diagonal water drips (up to a 60° angle)
4	Protection against grain-shaped foreign bodies		As 3 however Ø > 1 mm	4	Splash-proof 	Protection against splashed water from all directions
5	Protection against injurious deposits of dust		Full protection against contact. Protection against interior injurious dust deposits	5	Hose-proof 	Protection against water (out of a nozzle) from all directions
6	Protection against ingress of dust		Total protection against contact. Protection against penetration of dust	6	Strong hose-proof 	Protection against strong water (out of a nozzle) from all directions
				7	Protected against immersion 	Protected against temporary immersion
				8	Water-tight 	Protected against water pressure

Connectors used outdoors have to meet the demands set by harsh environments and rapidly changing conditions.

This is the reason why special materials such as stainless steel, special coatings and seals are used for the HARTING PushPull and Han® 3 A M series. The chosen materials guarantee an optimal functionality of the connectors for up to 15 years of operation in outdoor applications.

The HARTING Outdoor Solutions connectors pass an extensive row of laboratory tests. The results show that both the plastic and the metal housings are ideally suited for the use in outdoor applications. The test schedule includes IP testing, exposure to ozone and UV light, mixed gas and salt spray tests.

The details of the tests are shown in the flow chart below:

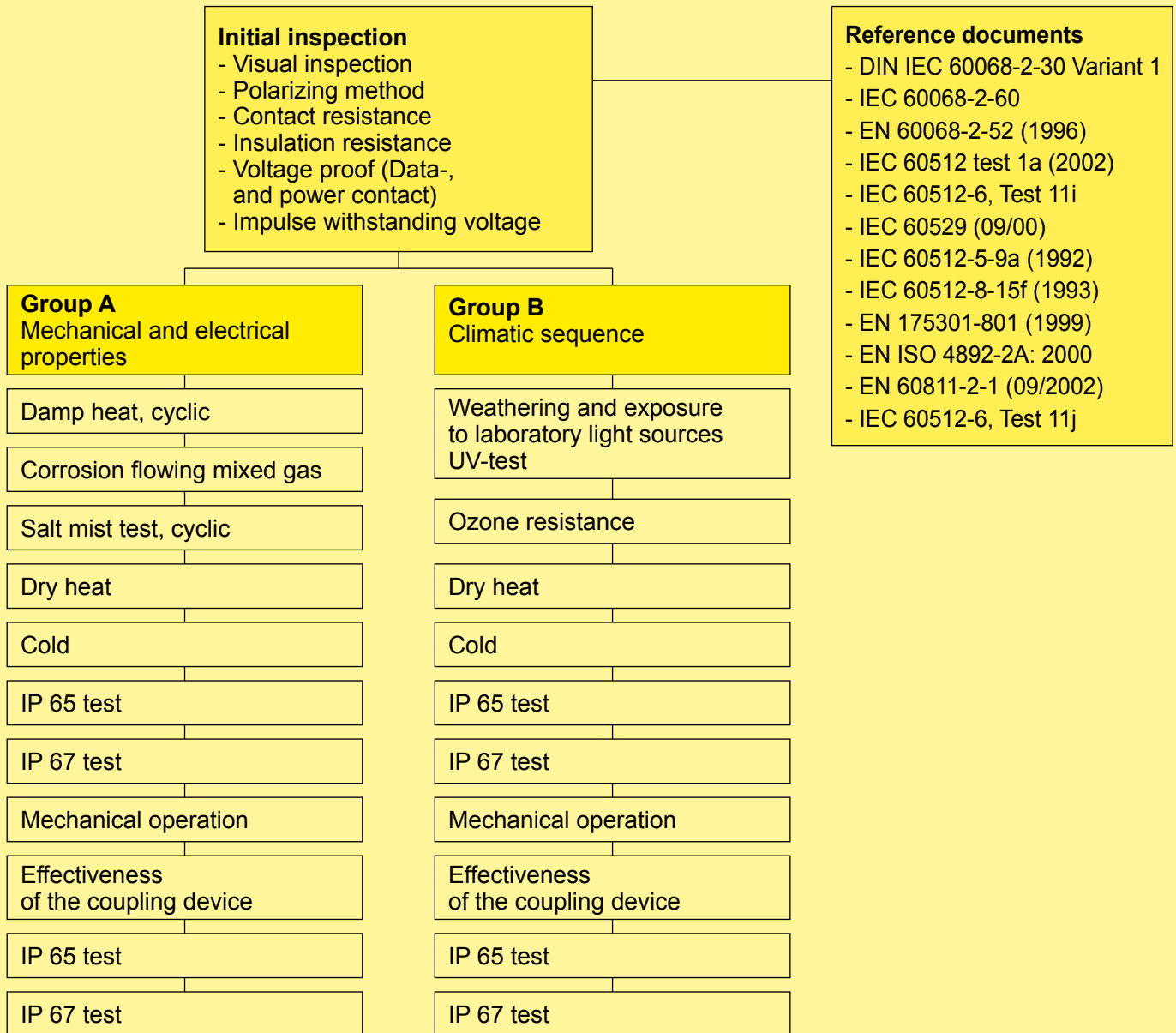

The modular HARTING RJ45 connector family is based on the standard RJ45 pin profile and was developed especially for use in rugged environments.

This technology charts a new course in the wiring of appliances with Ethernet interfaces, enabling the on-site configuration of connectors for many applications, no matter if the product is a power connector or a communications connector. In the context of the wiring of 4-pole Fast Ethernet networks, HARTING relies consistently on the HARAX® quick connection technology.

Solid or flexible conductors up to a cross-section of AWG 22 are terminated by IDC technology, without stripping or using any special tool.

HARTING offers the 8-pole data module with piercing connection technology, which meets the high requirements of category 6 for all Gigabit Ethernet networks. The 8-pole adapter of the category 6 data module also matches the screening plates of the 4-wire data module with quick connection technology. This functionality enables the conversion of any 100 MBit Fast Ethernet network into a Gigabit Ethernet network using HARTING RJ45 connectors. This innovative platform strategy also permits the use of the RJ45 data module in combination with the PushPull and Han® 3 A connector families.

Based on this innovative data module, HARTING has developed a comprehensive connector family which covers all applications for Fast Ethernet, Gigabit Ethernet, Ethernet/IP and other Ethernet profiles.

APPLIANCE INTEGRATION:

HARTING offers various RJ45 jacks for direct mounting on the PCBs of appliances.

Protection level	IP 65 / IP 67
Mating interface	RJ45 acc. to IEC 60 603-7
Termination cross section	
Cat. 5	AWG 24/7 ... AWG 22/7 (stranded) AWG 23/1 ... AWG 22/1 (solid)
Cat. 6	AWG 27/7 ... AWG 24/7 (stranded)
Temperature range	-40 °C ... +70 °C
Flammability acc. to UL 94	V-0
	UL approval (E102079)

HARTING PushPull connector RJ45

Locking mechanism	PushPull acc. to ISO/IEC 24 702 and IEC 61076-3-106, variant 4
Cable diameter	4.9 - 8.6 mm
Mating cycles	min. 750
Housing material	Plastic, black Coated zinc die cast

Han® 3 A connector RJ45

Cable diameter	6.0 - 9.0 mm
Mating cycles	min. 500
Housing material	Plastic, black Coated zinc die cast
Housing surface	Powder-coated RAL 7037 (grey)
Locking element	Steel, zinc plated
Hoods/ Housings seal	NBR

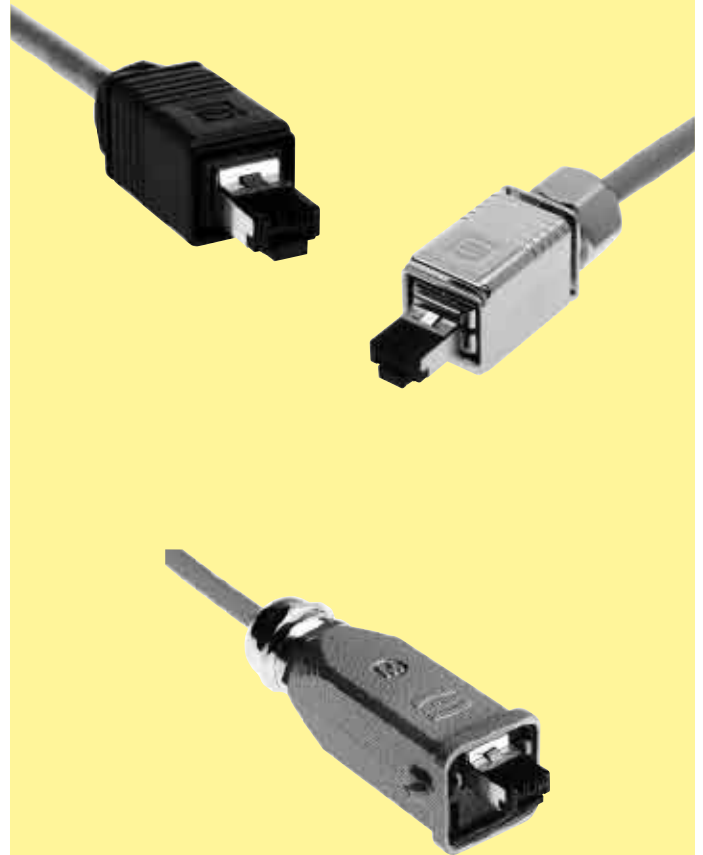

Copper connectors RJ45

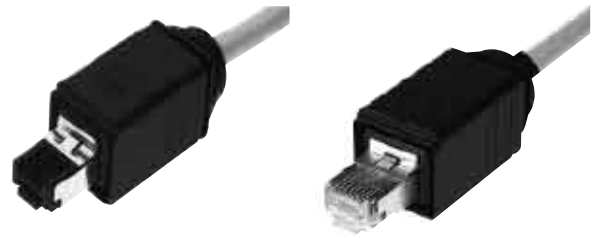

HARTING PushPull connector
RJ45, 4-pole and 8-pole, plastic

Identification	Part No.	Drawing	Dimensions in mm
<p>Connector set, Cat. 5, 4-pole incl. housing, cable gland and instruction manual</p>	<p>09 45 145 1100</p>		
<p>Connector set, Cat. 6, 8-pole incl. housing, cable gland and instruction manual</p> <p>Wire manager white</p> <p>Wire manager blue</p>	<p>09 45 145 1500</p> <p>09 45 145 1510</p>		
<p>Reference note: For Cat. 6 patch cords it is recommended to use 1 connector with a white wire manager and one with a blue cable manager, in order to optimise the crosstalk between different signal pairs.</p>			
<p>Protection cover for connectors with cord, IP 65 / IP 67</p>	<p>09 45 845 0010</p>		

Connector set, Cat. 5, 4-pole
incl. housing, cable gland
and instruction manual

09 45 145 1100

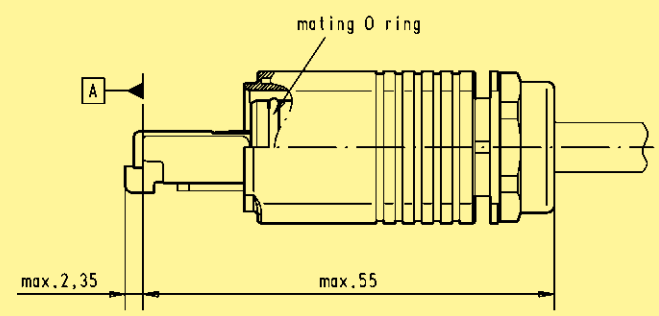

Connector set, Cat. 6, 8-pole
incl. housing, cable gland
and instruction manual

Wire manager white

Wire manager blue

09 45 145 1500

09 45 145 1510

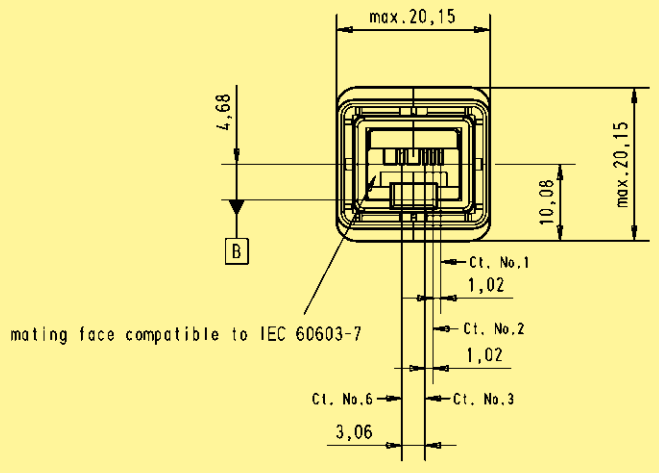

Reference note:
For Cat. 6 patch cords it is recommended to
use 1 connector with a white wire manager
and one with a blue cable manager, in order
to optimise the crosstalk between different
signal pairs.

Protection cover for connectors
with cord, IP 65 / IP 67

09 45 845 0010

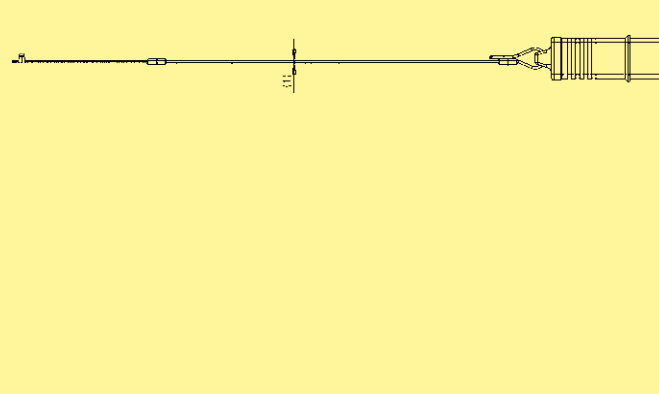

Copper connectors RJ45

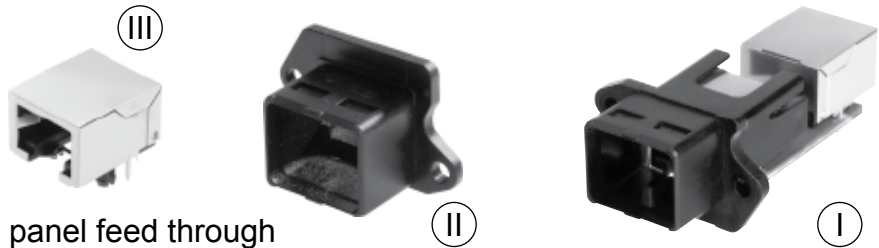

HARTING PushPull Compact panel feed through RJ45, plastic

Identification	Part No.	Drawing	Dimensions in mm
Panel feed through set incl. housing and instruction manual, fixing holes M2.5 (I)	09 45 245 1102		
Separate housing incl. flat sealing for direct device integration, fixing holes M2.5 (II)	with clip 09 45 545 0021 without clip 09 45 545 0023		
RJ45 jacks, Cat. 5 for direct device integration, Category 5, shielded (III)	SMD 09 45 551 1100 ¹⁾ SMD 09 45 551 1110 ²⁾ through hole 09 45 551 1102 ¹⁾		
Protection cover for housing bulkhead mounting with cord IP 65 / IP 67 fixing ring for M3 Version with active locking	09 45 845 0006		
Version with passive locking	09 45 845 0009		
IP 40 protection cover for housing bulkhead mounting, rubber	09 45 845 0003		

1) Packaging: Blister à 120 pieces

2) Packaging: Tape & Reel à 130 pieces

HARTING PushPull EasyInstall
panel feed through
RJ45, plastic

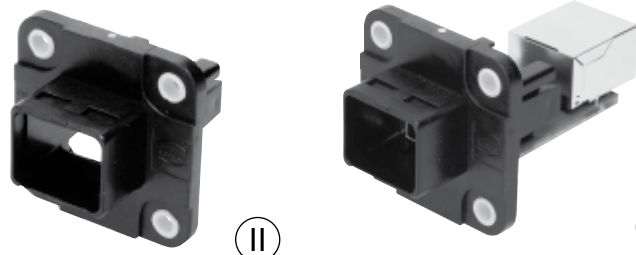

Identification Part No. Drawing Dimensions in mm

EasyInstall panel feed through set
incl. PCB and 2 RJ45 jacks

I

09 45 245 1130

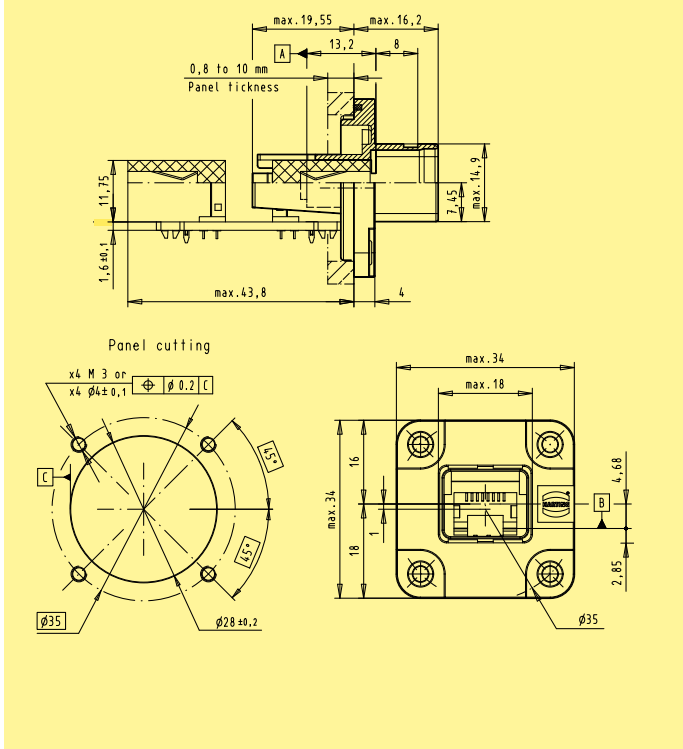

Separate housing EasyInstall

II without fixing clip

with fixing clip

09 45 545 0030

09 45 545 0031

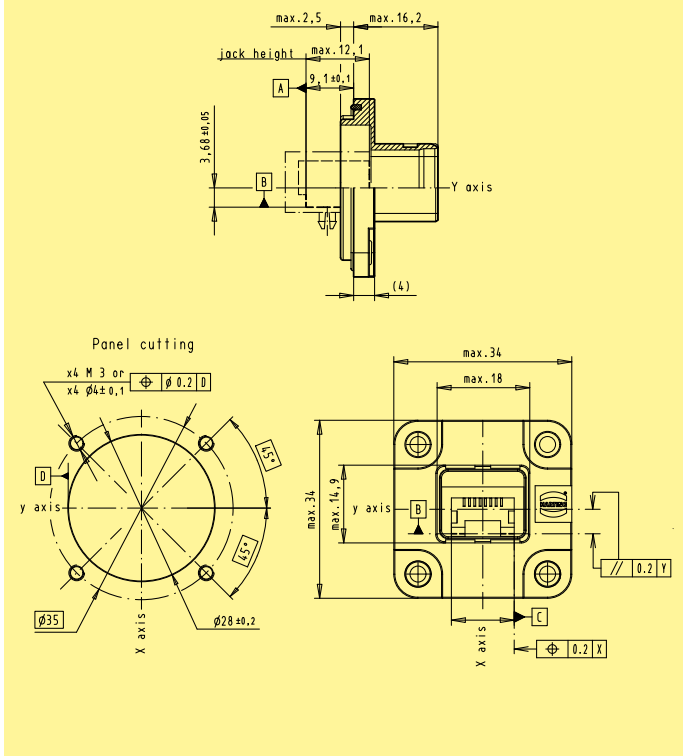



Han® 3 A connector
RJ45, 4-pole

Identification	Part No.	Drawing	Dimensions in mm
----------------	----------	---------	------------------

Connector set

incl. housing, cable gland and instruction manual

Plastic version	straight	09 45 125 1100
	angled	09 45 125 1104
Standard metal version	straight	09 45 115 1100
	angled	09 45 115 1104
Metal version M	straight	09 45 115 1102
	angled	09 45 115 1106
Coding pin set		09 45 820 0000

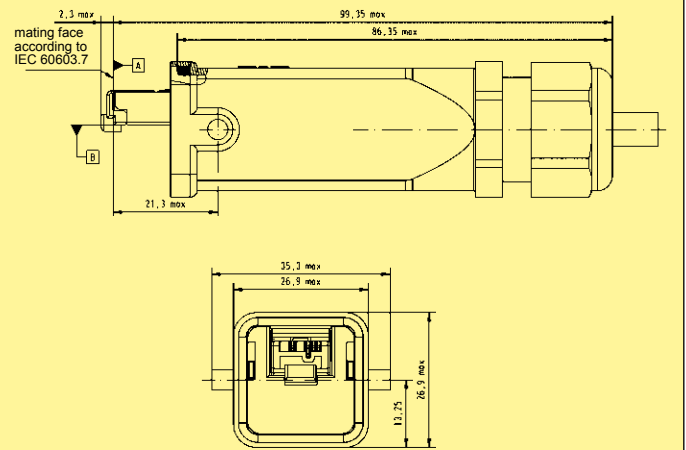

Dimensions valid for the straight plastic version

Protection cover for connectors with cord, IP 65 / IP 67

Plastic version, grey	09 20 003 5442
Standard metal version, grey	09 20 003 5422
Metal version M, black	09 37 003 5402

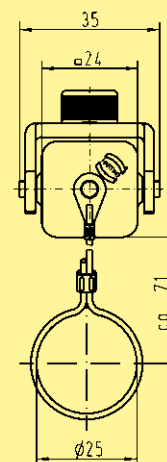

Dimensions valid for the plastic version

Copper connectors RJ45



Han® 3 A connector
RJ45, 8-pole

Identification	Part No.	Drawing	Dimensions in mm
----------------	----------	---------	------------------

Connector set incl. housing, cable gland and instruction manual			
Plastic version	Wire manager white	09 45 125 1500	
	Wire manager blue	09 45 125 1510	
Metal version Standard	Wire manager white	09 45 115 1500	
	Wire manager blue	09 45 115 1510	
Metal version M	Wire manager white	09 45 115 1502	
	Wire manager blue	09 45 115 1512	
Coding pin set		09 45 820 0000	

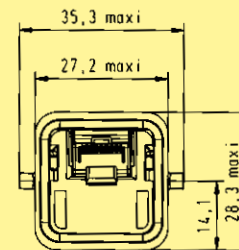
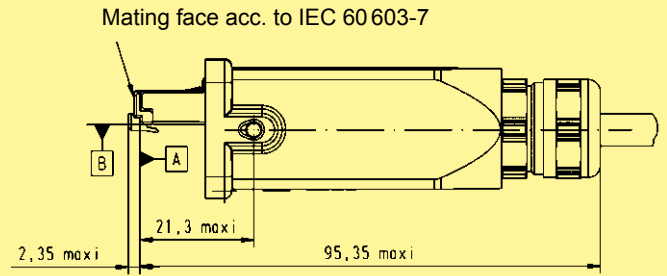

Dimensions valid for metal version Standard

Copper connectors RJ45



Han® 3 A panel feed through RJ45, 8-pole

Identification	Part No.	Drawing	Dimensions in mm	
Panel feed through set incl. housing and instruction manual				
Plastic version	straight	09 45 225 1100		
	angled	09 45 225 1108		
Standard metal version	straight	09 45 215 1100		
	angled	09 45 215 1108		
Standard metal version with self-closing protective cap	straight	09 45 215 1103		
Metal version M	straight	09 45 215 1102		
	angled	09 45 215 1109		
Coding pin set		09 45 820 0000		
Dimensions valid for the straight plastic version				
Gender changer incl. installation frame				
Plastic version		09 45 225 1107		
Standard metal version		09 45 215 1107		
Metal version M		09 45 215 1110		
Coding pin set		09 45 820 0000		
Dimensions valid for the plastic version				
Protection cover for panel feed through IP 65 / IP 67				
Plastic version, black		09 20 003 5449		
Standard metal version, grey		09 20 003 5425		
Metal version M, black		09 37 003 5406		
Dimensions valid for the plastic version				

Apart from applications in the field of telecommunications, fibre optic technology is of great importance in the industrial market sector.

In telecommunications there are requirements for:

- High transmission capacity
- Low cable attenuation
- No crosstalk

The features are also required in the industrial sector along with the following major considerations:

- Zero susceptibility to electromagnetic interference
- Electrical insulation between transmitter and receiver
- Small cable diameter

Fibre optic communication works by pulses of light. When feeding them in at one end of the fibre optic cable, the pulses are passed to the other end by total internal reflection.

Total internal reflection occurs at the boundary layer between core and cladding by virtue of the different values of optical refractive index (n) between the two materials (n cladding less than n core).

The singlemode fibre is mainly used in telecommunications because of its low attenuation and wide bandwidth.

The gradient index fibre and the step fibre with their large core diameters are chiefly used as communication cables in industrial applications due to their easy handling and relatively low costs. The link length ranges from several meters to several kilometers.

There are three different types of optical fibres:

		Typical Dimensions Core/Cladding \varnothing	Attenuation
Step index (SI) fibre HCS ²⁾ / POF ¹⁾		200 / 230 μm 980 / 1000 μm	5 ... 8 dB/km 0.2 dB/m
Gradient index (GI) fibre		50 / 125 μm 62.5 / 125 μm	2.6 dB/km 3.2 dB/km
Singlemode fibre		9 / 125 μm	< 0.3 dB/km

optical refractive index profile

¹⁾ POF = Polymer-Optical Fibre

²⁾ HCS[®] = Hard Clad Silica is registered trademark of SpecTran Corporation

Protection level

HARTING PushPull /	
Han® 3 A 2 x LC duplex	IP 65 / IP 67
Unibody / Adapter	IP 20

Cable diameter

HARTING PushPull	4.9 - 8.6 mm
Han® 3 A 2 x LC duplex*	5 - 14 mm

Mating cycles

min. 200

Temperature range

-40 °C ... +70 °C

Housing material

HARTING PushPull	Plastic, black Coated zinc die cast
Han® 3 A 2 x LC duplex	Coated zinc die cast

Flammability

acc. to UL 94

V-0

Han® 3 A 2 x LC duplex

Housing surface

- Priming	Chromated
- Top Coat	Epoxy powder paint (black)

Locking element

V2A Steel

Hoods/Housings seal

FPM

The optic module is based on standardized LC connector mating face in accordance with IEC 61754-20. The coupling sleeve is mateable to standard LC patch cables on rear side.

- Small form factor (50 % compared to SC and ST®)
- A one-piece moulded LC body form for enhanced mechanical reliability
- A & B part identification on duplex in accordance with TIA 568 standard

Extension cord adaptor

Adaptor for easy extension of optical lines (under preparation).

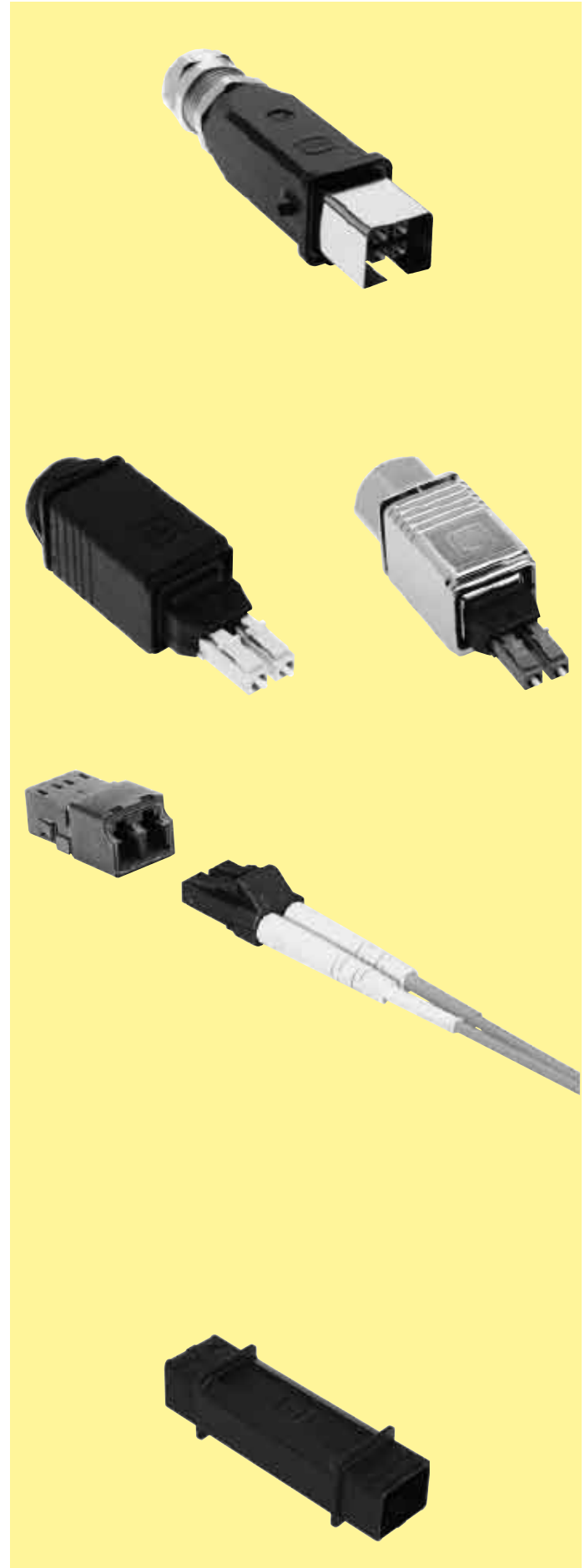

* cable side is delivered with sealing gland

Overvoltage category

The overvoltage category is dependent on the mains voltage and the location at which the equipment is installed. It describes the maximum overvoltage resistance of a device in the event of a power supply system fault, e. g. in the event of a lightning strike.

The overvoltage category affects the dimensioning of components in that it determines the clearance air gap. Pursuant to the relevant standards, there are 4 overvoltage categories.

Equipment for industrial use, all HARTING industrial connectors fall into Overvoltage Category III.

Extract from DIN VDE 0110-1 and IEC 60664-1, Para. 2.2.2.1.1

Equipment of overvoltage category III is equipment in fixed installations and for cases where the reliability and the availability of the equipment is subject to special requirements.

Note: Examples of such equipment are switches in the fixed installation and equipment for industrial use with permanent connection to the fixed installation.

Pollution degree

The dimensioning of operating equipment is dependent on environmental conditions. Any pollution or contamination may give rise to conductivity that, in combination with moisture, may affect the insulating properties of the surface on which it is deposited. The pollution degree influences the design of components in terms of the creepage distance.

The pollution degree is defined for exposed, unprotected insulation on the basis of environmental conditions.

HARTING industrial connectors are designed as standard for Pollution Degree 3.

Pollution degree 3 in industrial, commercial and agricultural premises, unheated storage premises, workshops or boiler rooms, also for the electrical components of assembly or mounting equipment and machine tools.

Extract from DIN VDE 0110-1 and IEC 60664-1, Para. 2.5.1

Pollution degree 3: Conductive pollution occurs or dry non-conductive pollution occurs which becomes conductive due to condensation which is to be expected.

Current carrying capacity

The current carrying capacity is determined in tests which are conducted on the basis of the DIN IEC 60512 part 3. The current carrying capacity is limited by the thermal properties of materials which are used for inserts as well as by the insulating materials. These components have a limiting temperature which should not be exceeded.

The relationship between the current, the temperature rise (loss at the contact resistance) and the ambient temperature of the connector is represented by a curve. On a linear co-ordinate system the current lies on the vertical line (ordinate) and the ambient temperature on the horizontal line (abscissa) which ends at the upper limiting temperature.

In another measurement the self-heating (Δt) at different currents is determined.

At least 3 points are determined which are connected to a parabolic curve, the basic curve.

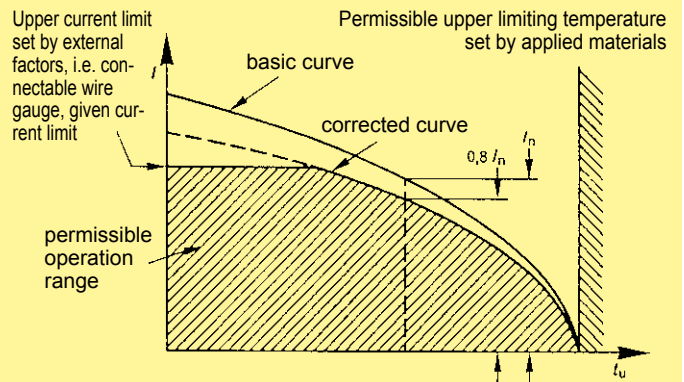

The corrected current carrying capacity curve is derived from this basic curve. The reasons for the correction are external factors that bring an additional limitation to the current carrying capacity, i.e. connectable wire gauge or an unequal dispersion of current.



Example of a current capacity curve

Definition: The rated current is the continuous, not interrupted current a connector can take when simultaneous power on all contacts is given, without exceeding the maximum temperature.

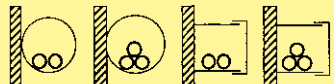
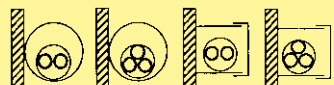
Current carrying capacity of copper wires

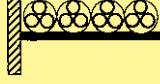
Diameter [mm ²] of single wires in a three-phase system	0.75	1	1.5	2.5
Type of installation				
 B1 Wires in protective tubes and installation conduits	7.6	10.4	13.5	18.3
 B2 Cables and wires in protective tubes and installation conduits	–	9.6	12	16.5
 C Cables and wires at walls	–	11.7	15.2	21
 D Cables and wires on a bed	–	11.5	16.1	22
Depiction in accordance with DIN EN 60204 for PVC-insulated copper wires in an ambient temperature of + 40 °C under permanent operating conditions.				
For different conditions and temperatures, installations, insulation materials or conductors the relevant corrections have to be carried out.				

HARTING offers with the HARTING PushPull Power connector an universal solution for the power supply in compact and robust applications. It is in its element wherever small dimensions are combined with a high protection class.

The connector is available in a 4 pole 48 V and a 2 pole 250 V version. The newly designed power contacts can carry up to 12 resp. 16 A each (see deratings). In spite of this high current carrying capacity the connector gets by with minimal dimensions and fulfils the industrial requirements for clearances and creepage distances at the same time.

Additionally the HARTING PushPull Power connector offers the protection class of IP 65 and IP 67. Beside numerous industrial use cases it is thereby suited for diverse applications in the fields of transportation and telecommunication.

The cable side of the HARTING PushPull Power is terminated with crimping technology. For the receptacle several solutions with different termination technologies are offered.

The innovative locking mechanism of the connector enables an easy plugging and pulling with just one hand. The mechanism is based on the same housing which is already established for the HARTING RJ45 product family.

Benefits

- Minimum space requirements in spite of high current carrying capacity
- Very compact housing in a high protection class
- Innovative PushPull locking mechanism
- Protection against contact on plug AND receptacle side enables an easy and safe installation
- For low voltage (48 V) and for power supply (250 V) available
- Codeable without losing contacts
- Different termination technologies for individual device integration

Typical application areas

- Factory and building automation
- Industrial electronics
- Telecommunication und wireless networks
- Transportation
- Industrial monitoring and camera systems
- Lighting and display technology
- Access control systems

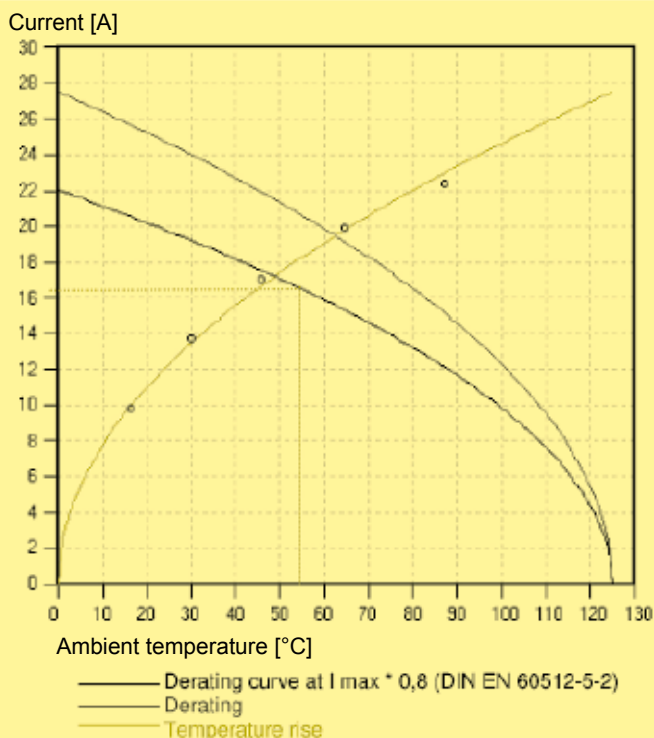
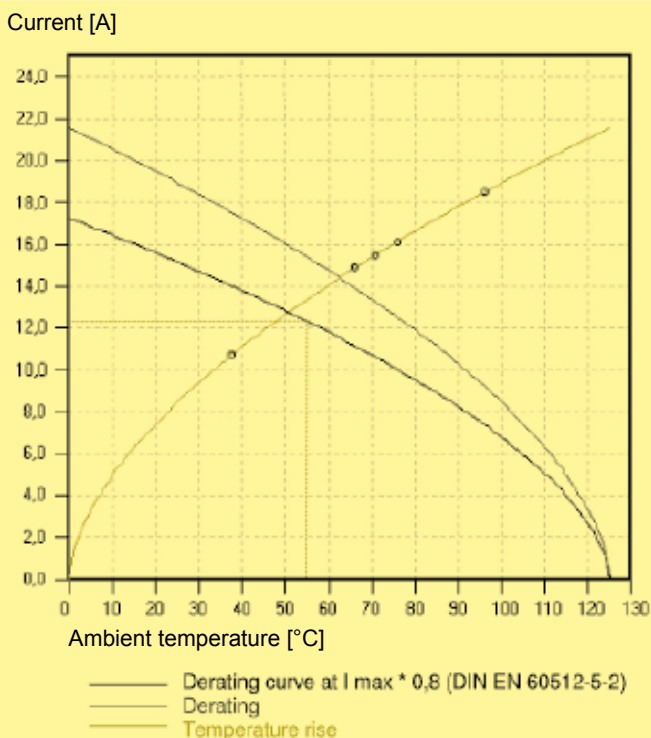

28 Derating diagram "low voltage, 48 V"; 4 contacts loaded

Derating diagram "power supply, 250 V"; 2 contacts loaded

Specification	DIN VDE 0110
Protection level	IP 65 / IP 67
Finger protection on cable and device side	
Mating cycles	min. 750
Temperature range	-40 °C ... +70 °C
Locking system	PushPull

Han® PushPull Power 4/0

Rated voltage	690 V
with solder termination	230 / 400 V
Rated current	16 A
No. of current carrying contacts	4
Pre-leading PE contact	1
Wire gauge	0.5 – 2.5 mm ²
Cable diameter	6.5 – 13 mm
Housing material	Plastic, black, UL 94 V-0

HARTING PushPull Power 4/0

Rated voltage	48 V
Rated current	12 A @ 55 °C
No. of current carrying contacts	4
Wire gauge	1.5 mm ² (AWG 16)
Cable diameter	4.9 – 8.6 mm
Housing material	Plastic, black, UL 94 V-0 Coated zinc die cast

HARTING PushPull Power 2/0

Rated voltage	250 V
Rated current	16 A @ 55 °C
No. of current carrying contacts	2
Pre-leading PE contact	1
Wire gauge	1.5 mm ² (AWG 16)
Cable diameter	4.9 – 8.6 mm
Housing material	Plastic, black, UL 94 V-0

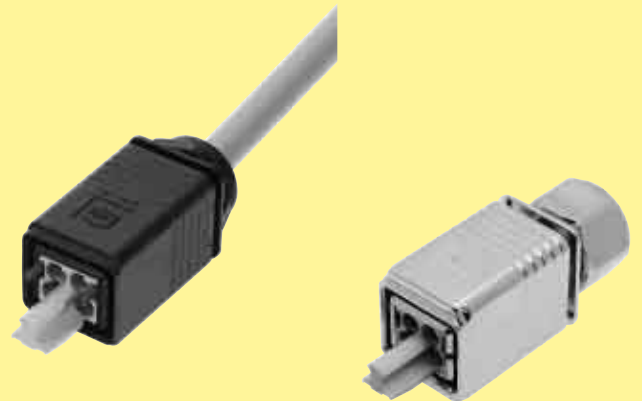



HARTING PushPull Power 4/0 connector for low voltage (48 V) applications, plastic

Identification	Part No.	Drawing	Dimensions in mm
----------------	----------	---------	------------------

Connector set
incl. 4 turned crimp contacts (male), insulator body (**grey**), housing, cable gland

Set of coding pins
To avoid accidental incorrect mating a coding system is required. The coding pins are inserted without loss of contacts.

09 46 145 4400

09 46 840 0000

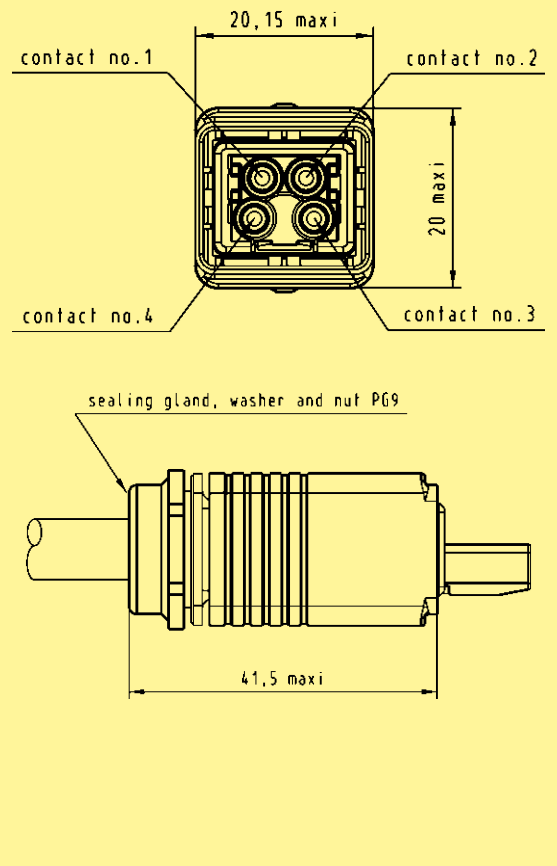

Protection cover for connectors
with cord, IP 65 / IP 67

09 45 845 0010

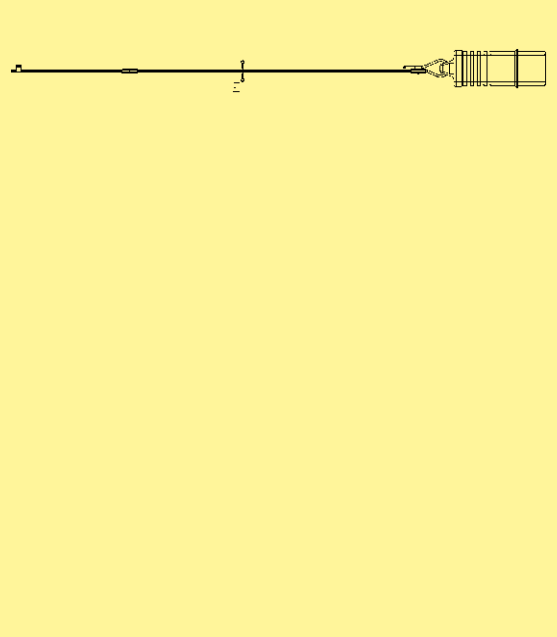



HARTING PushPull Power 4/0 panel feed through for low voltage (48 V) applications, plastic

Identification	Part No.	Drawing	Dimensions in mm
<p>Housing bulkhead mounting Compact</p> <p>with 4 turned female contacts and insulation</p> <p>with crimp termination for 1.5 mm²</p> <p>with solder termination, 90° angled</p> <p>with cable cage clamp</p>	<p>09 46 245 4400</p> <p>09 46 245 4000</p> <p>09 46 245 4001</p>		<p>25.2</p> <p>18 maxi</p> <p>19.2 maxi</p> <p>15.7 maxi</p> <p>15.8 maxi</p> <p>3.5</p> <p>7.45</p> <p>20.5 maxi</p> <p>1mm flat seal</p> <p>without x2 M2,5 screwing</p> <p>Panel front cutout</p> <p>0.3 mN recommended screwing torque</p> <p>M2,5 or Ø2,6</p> <p>Ø 0.1</p> <p>16.2 max.</p> <p>10.35 radius</p> <p>R1 maxi</p> <p>3.5</p> <p>18.4 ±0.1</p> <p>Axis X</p> <p>Axis Y</p>
<p>Housing bulkhead mounting EasyInstall</p> <p>with 4 turned female contacts and insulation</p> <p>with crimp termination for 1.5 mm²</p> <p>with solder termination, 90° angled</p> <p>with cable cage clamp</p>	<p>09 46 245 4430</p> <p>09 46 245 4030</p> <p>09 46 245 4031</p>		<p>max 34</p> <p>max 18</p> <p>max 16.9</p> <p>max 34</p> <p>max 19.55</p> <p>max 16.2</p> <p>15.8 maxi</p> <p>(6,5)</p> <p>max 4.05</p> <p>(6,42)</p> <p>Z axis</p> <p>Y Axis</p> <p>X Axis</p> <p>contact no. 1</p> <p>contact no. 2</p> <p>contact no. 3</p> <p>contact no. 4</p>
<p>Set of coding pins</p> <p>To avoid accidental incorrect mating a coding system is required. The coding pins are inserted without loss of contacts.</p>	<p>09 46 840 0000</p>		
<p>IP 65 / IP 67 protective cap</p> <p>with cord</p>	<p>09 45 845 0009</p>		



HARTING PushPull Power 4/0 connectors for low voltage (48 V) applications, metal

Identification	Part No.	Drawing	Dimensions in mm
Connector set incl. 4 turned crimp contacts (male), insulation, housing, cable gland	09 46 195 4400		
Crimp contacts male 0.75 mm ² (AWG 20 - 18) 1.5 mm ² (AWG 16 - 14) 2.5 mm ² (AWG 12)	09 46 500 0403 09 46 500 0401 09 46 500 0405		
Set of coding pins To avoid accidental incorrect mating a coding system is required. This coding pins are inserted without loss of contact.	09 46 840 0000		
IP 65 / IP 67 protective cap for connector with cord for device side with cord	09 45 845 0010 09 45 845 0009		
IP 40 protection cover for housing bulkhead mounting, rubber	09 45 845 0003		



HARTING PushPull Power 2/0 connector
for (250 V) power supply, plastic

Identification	Part No.	Drawing	Dimensions in mm
----------------	----------	---------	------------------

<p>Connector set incl. 3 turned crimp contacts (male) insulator body (black), housing, cable gland</p>	09 46 145 3410		<p>20,15 maxi</p> <p>contact no. 2</p> <p>contact no. 1</p> <p>20 maxi</p> <p>GND contact pre-mating pin</p> <p>sealing gland, washer and nut PG9</p> <p>41,5 maxi</p>
<p>Set of coding pins To avoid accidental incorrect mating a coding system is required. The coding pins are inserted without loss of contacts.</p>	09 46 840 0000		

<p>Protection cover for connectors with cord, IP 65 / IP 67</p>	09 45 845 0010		
--	----------------	--	--

Han® 3 A hybrid RJ45

- Field-assembly with mounting tool
- Compact design and very robust housing
- Suitable for termination with solid and stranded cables
- Protection against direct contact on cable and device side according to EN 60 529
- RJ45 Ethernet data connector with Power Pins for hybrid applications

Han® 3 A hybrid LC duplex

- Small form factor (compared to SC and ST®)
- Compact, space-saving design
- Combined to only one FO-module for high mechanical load
- High packing density
- A & B part identification according to TIA 568 standard

Protection level	IP 65 / IP 67
Cable diameter*	
Han® 3 A RJ45	9 - 13 mm
LC duplex	5 - 14 mm
Sealing gland	
RJ45	EMC
Fibre optic	standard
Mating cycles	
RJ45	100
Fibre optic	200
Temperature range	-40 °C ... +70 °C
Housing material	Coated zinc die cast
Housing surface	
- Priming	Chromated
- Top coat	Epoxy powder paint (black)
Locking element	V2A Steel
Hoods/Housings seal	FPM
Flammability acc. to UL 94	V-0

Data part LC duplex

The optic module is based on standardized LC connector mating face in accordance with IEC 61 754-20. The coupling sleeve is mateable to standard LC patch cables on rear side.

Data part RJ45

Transmission properties in accordance with Category 5 ISO/IEC 11 801:2002, corresponding to TIA/EIA 568:2002

Mating interface	RJ45 in accordance with IEC 60 603-7
------------------	--------------------------------------

Power part (available in two coded versions)

Rated voltage	300 V AC/DC
Rated current	12 A @ 70 °C
No. of current carrying contacts	3 (AC: L1, PE, N or DC: V+, GND, V-)
	Premating PE/GND
Finger protection	On cable and device side (acc. to EN 60 529)
Cable diameter	2.5 mm ²

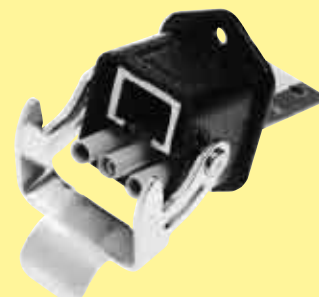

* please contact us for other cable diameter



Han® 3 A hybrid LC duplex

Identification	Part No.	Drawing	Dimensions in mm
----------------	----------	---------	------------------

Han® 3 A hybrid LC duplex

Cable side*

Power: 3 x Han D® male contacts

Data: Multimode GOF

AC version

09 57 508 0500 000

DC version

09 57 508 0510 000

Data: Singlemode GOF

AC version

09 57 508 0501 000

DC version

09 57 508 0511 000

Device side

Power: 3 x Han D® female contacts

Data: Multimode GOF

AC version

09 57 568 0500 000

DC version

09 57 568 0510 000

Data: Singlemode GOF

AC version

09 57 568 0501 000

DC version

09 57 568 0511 000

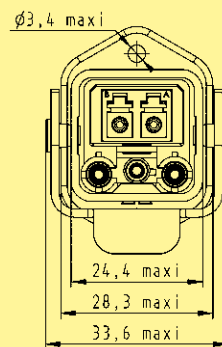
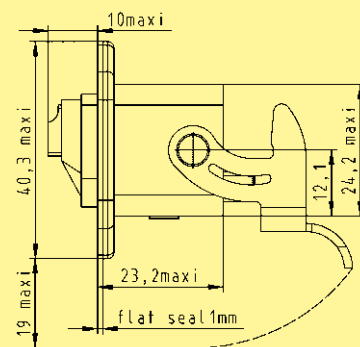
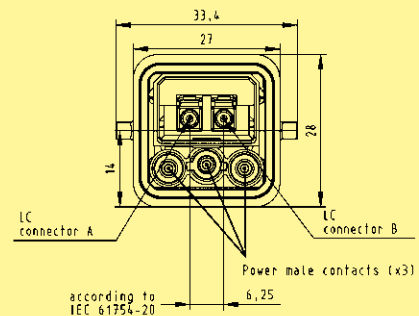
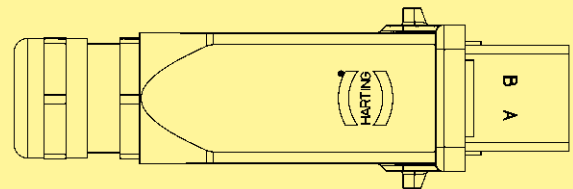
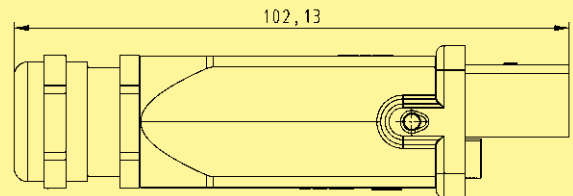

Recommended panel cutout dimension

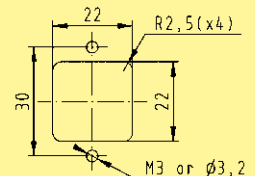

* cable side is delivered with sealing gland

Crimp connection

A perfect crimp connection is gastight, therefore corrosion free and amounts to a cold weld of the parts being connected. For this reason, major features in achieving high quality crimp connections are the design of the contact crimping parts and of course the crimping tool itself. Wires to be connected must be carefully matched with the correct size of crimp contacts. If these basic requirements are met, users will be assured of highly reliable connections with low contact resistance and high resistance to corrosive attack.

The economic and technical advantages are:

- Constant contact resistance as a result of precisely repeated crimp connection quality
- Corrosion free connections as a result of cold weld action
- Pre-preparation of cable forms with crimp contacts fitted
- Optimum cost cable connection

Requirements for crimp connectors are laid down in DIN IEC 60 352-2, Amend. 2, as illustrated in the table.

Pull out force of stranded wire

The main criterion by which to judge the quality of a crimp connection is the retention force achieved by the wire conductor in the terminal section of the contact. DIN IEC 60 352, part 2, defines the extraction force in relation to the cross-section of the conductor. When fitted using HARTING crimping tools and subject to their utilization in an approved manner, our crimp connectors comply with the required extraction forces.

Crimping tools

Crimping tools (hand operated or automatic) are carefully designed to produce with high pressure forming parts a symmetrical connection of the crimping part of the contact and the wire being connected with the minimum increase in size at the connection point. The positioner automatically locates the crimp and wire at the correct point in the tool.

A ratchet in the tool performs 2 functions:

- ① It prevents insertion of the crimp into the tool for crimping before the jaws are fully open
- ② It prevents the tool being opened before the crimping action is completed

Identical, perfectly formed, connections can be produced using this crimping system.





Tensile strength of crimped connections







Conductor cross-section		Tensile strength
mm ²	AWG	N
0.08	28	11
0.12	26	15
0.14		18
0.22	24	28
0.25		32
0.32	22	40
0.5	20	60
0.75		85
0.82	18	90
1.0		108
1.3	16	135
1.5		150
2.1	14	200
2.5		230
3.3	12	275
4.0		310

Extract from DIN IEC 60 352-2, Amend. 2, Table IV



Crimp-cross section
HARTING crimp profile

Identification	Wire gauge (mm ²)	Part No.								
Han® PushPull Power 8-indent crimping tool		09 46 800 0000		For wire gauges 0.08 ... 4.0 mm ² (AWG 28 ... 12).						
Locator HARTING PushPull Power contacts for crimping tool (09 99 000 0001)		09 46 800 0010								
Crimping tool depth adjustment gauge				For the fine adjustment of the crimping depth of the Han® PushPull Power 8-indent crimping tool.						
Ø 1.02 mm		09 46 800 0002								
Ø 1.15 mm		09 46 800 0003								
			<table border="1"> <thead> <tr> <th>Wire</th> <th>Gauge</th> </tr> </thead> <tbody> <tr> <td>0.25 mm² ... 1.50 mm²</td> <td>Ø 1.02 mm</td> </tr> <tr> <td>1.50 mm² ... 2.50 mm²</td> <td>Ø 1.15 mm</td> </tr> </tbody> </table>	Wire	Gauge	0.25 mm ² ... 1.50 mm ²	Ø 1.02 mm	1.50 mm ² ... 2.50 mm ²	Ø 1.15 mm	
Wire	Gauge									
0.25 mm ² ... 1.50 mm ²	Ø 1.02 mm									
1.50 mm ² ... 2.50 mm ²	Ø 1.15 mm									
Insertion tool		09 46 800 0099		For an easy insertion and extraction of the male and female crimp contacts into / out of the insulator body.						
Extraction tool		09 46 800 0098								
Han D® and Han® P contacts										
BUCHANAN crimping tool for all contacts		09 99 000 0001								
Locator for Han D® contacts		09 99 000 0311								
Locator for Han® P contacts		09 99 000 0329								
Crimping tool depth adjustment gauge for Han D® contacts	0.14-0.25	09 99 000 0203								
	0.37	09 99 000 0125								
	0.5-1.0	09 99 000 0007								
	1.5	09 99 000 0008								
	2.5	09 99 000 0007								
HARTING RJ45 Assembly Tool for 8-pole HARTING RJ45 connectors		09 45 800 0500		With the RJ45 Assembly Tool 8-pole connectors can be fast, easily and reliably connected to flexible cables.						
Stripping Tool Stripping Tool for 2 pairs PROFINET cables incl. blade cassette		09 45 800 0000								
Blade cassette		09 45 800 0001		The RJ45 Stripping Tool allows the insulation to be removed from suitable 2 pair and 4 pair cables for fast mounting with diameters between 2.5 - 8 mm quickly and easily. The tool is pre-set for a cable diameter of 6.5 mm. It allows the cable sheath and screening braid to be stripped consistently and simultaneously.						

Identification	Wire gauge (mm ²)	Part No.	
Tool kit GI-fibre		20 99 000 3015	 <p>Height : 170 mm Width : 470 mm Depth : 360 mm</p> <p>Tool kit for connector mounting of glass fibres, using adhesive e.g.: GI 50/125 µm.</p>
HARTING crimping tool for F.O. connector (glass fibre) SW 4.3 and 3.8 mm		20 99 000 1031	
HARTING crimping tool for F.O. connector (glass fibre) SW 6.5, 4.95 and 3.0 mm		20 99 000 1033	<p>For crimping the strain relief to the connector</p> <p>... 1031 F.O. cable for glass fibre</p> <p>... 1033 POF¹⁾ and SERCOS²⁾ cable ø 6.0; ø 3.6</p>
HARTING crimping tool with locator for Han D [®] , Han E [®] , Han C [®]	0.14-1.5	09 99 000 0110	
HARTING crimping tool with locator for Han D [®] , Han E [®]	0.14-1.5	09 99 000 0021	
HARTING crimping tool for LC contacts	4 - 6	09 99 000 0303	
Removal tool for crimp contacts Han D [®]			 <p> . . 0012 . . 0004 . . 0052 </p> <p>A removal tool is necessary if contacts are to be replaced in the insert. It is inserted from the mating face and pushed over the contact until a stop is noticeable. Additional pressure unlocks the contact and pushes it out of the wiring side. In case of the removal tool (. . 0052) the unlocking process is achieved by pressure on the central rod.</p>

HARTING offers a wide choice of cable assemblies in either copper, hybrid (power and data) or fibre optic based around its comprehensive range of I/O connectors.

These cable assemblies are manufactured using components selected from a wide range of inserts with housings available in either a metal or plastic construction. The significant range of connectors and housings available allow for customer specific applications to be fulfilled.

The HARTING product portfolio offers fully assembled 100% tested cable harnesses and removes the need for on-site assembly activity. Customer specific lengths are available on request.

The “new” fibre optic and hybrid interfaces used in HARTING customised cable assemblies are ideally suited for FTTA (Fibre To The Antenna) applications offering easier handling and transportation and reduced installation time.





Fibre optic cable assembly
HARTING PushPull LC duplex multimode

Identification	Part No.	Drawing	Dimensions in mm
<p>Fibre optic cable, double ended, multimode, 62.5 μm</p> <p>Length: a = 1 m a = 5 m a = 10 m a = 20 m a = 40 m a = 50 m a = 100 m</p>	<p>33 58 211 0010 001 33 58 211 0050 001 33 58 211 0100 001 33 58 211 0200 001 33 58 211 0400 001 33 58 211 0500 001 33 58 211 1000 001</p>	<p>double ended</p> <p>a = length</p>	
<p>Fibre optic cable, single ended, multimode, 62.5 μm</p> <p>Length: a = 1 m a = 5 m a = 10 m a = 20 m a = 40 m a = 50 m a = 100 m</p>	<p>33 58 111 0010 001 33 58 111 0050 001 33 58 111 0100 001 33 58 111 0200 001 33 58 111 0400 001 33 58 111 0500 001 33 58 111 1000 001</p>	<p>Protection level: IP 65 / IP 67</p> <p>single ended</p> <p>a = length</p>	
<p>Fibre optic breakout cable</p> <p>Length: 10 m Length: 20 m Length: 100 m</p>	<p>33 58 751 0100 001 33 58 751 0200 001 33 58 751 1000 001</p>	<p>PUR jacket 2-fibre multimode Outer diameter: Min. bending radius: Installation: Operating:</p>	<p>62.5 μm 7 mm 10.5 cm 7.0 cm</p>

Further cable lengths are available on request



Hybrid cable assembly Han® 3 A hybrid RJ45

Identification	Part No.	Drawing	Dimensions in mm
<p>Hybrid cable, double ended, 4 x 2 x AWG 26/7 + 3 x 2.5 mm²</p> <p>Length: a = 1 m AC version DC version</p> <p> a = 5 m AC version DC version</p> <p> a = 10 m AC version DC version</p> <p> a = 20 m AC version DC version</p>	<p>33 57 211 0010 001 33 57 211 0010 002</p> <p>33 57 211 0050 001 33 57 211 0050 002</p> <p>33 57 211 0100 001 33 57 211 0100 002</p> <p>33 57 211 0200 001 33 57 211 0200 002</p>	<p>double ended</p> <p>a = length</p>	
<p>Hybrid cable, single ended, 4 x 2 x AWG 26/7 + 3 x 2.5 mm²</p> <p>Length: a = 1 m AC version DC version</p> <p> a = 5 m AC version DC version</p> <p> a = 10 m AC version DC version</p> <p> a = 20 m AC version DC version</p>	<p>33 57 111 0010 002 33 57 111 0010 001</p> <p>33 57 111 0050 002 33 57 111 0050 001</p> <p>33 57 111 0100 002 33 57 111 0100 001</p> <p>33 57 111 0200 002 33 57 111 0200 001</p>	<p>Protection level: IP 65 / IP 67</p> <p>Data part: Transmission properties in accordance with ISO/IEC 11801:2002: Class D</p> <p>single ended</p> <p>a = length</p>	
<p>Hybrid outdoor cable</p> <p>Length: 10 m</p> <p>Length: 20 m</p> <p>Length: 500 m</p>	<p>33 57 851 0100 001</p> <p>33 57 851 0200 001</p> <p>33 57 851 5000 001</p>		<p>PVC jacket</p> <p>4 x 2 x AWG 26/7 + 3 x 2.5 mm²</p> <p>Outer diameter: 12 mm</p> <p>Min. bending radius: single: 5 x OD repeated: 10 x OD</p>

Further cable lengths are available on request



Outdoor cable assembly RJ 45, 4-wire

Identification	Part No.	Drawing	Dimensions in mm
HARTING PushPull Outdoor cable, RJ45, 4-wire Length: a = 1.5 m a = 3.0 m a = 5.0 m a = 10.0 m a = 20.0 m	09 47 363 6069 09 47 363 6071 09 47 363 6073 09 47 363 6078 09 47 363 6080	double ended a = length 	
Han® 3 A Outdoor cable, RJ45, 4-wire Length: a = 1.5 m a = 3.0 m a = 5.0 m a = 10.0 m a = 20.0 m	09 45 715 0064 09 45 715 0066 09 45 715 0068 09 45 715 0073 09 45 715 0075	double ended a = length 	
Outdoor cable 4-wire, RJ45, Cat. 5, PVC Length: 20 m ring Length: 50 m ring Length: 100 m ring Length: 500 m reel	09 45 600 0135 09 45 600 0145 09 45 600 0105 09 45 600 0115		Wire: stranded tinned copper, AWG 22/7 Overall screen: aluminate foil overlapped, tinned copper wire braid, braid coverage about 85 % Overall diameter: 6.3 – 6.7 mm

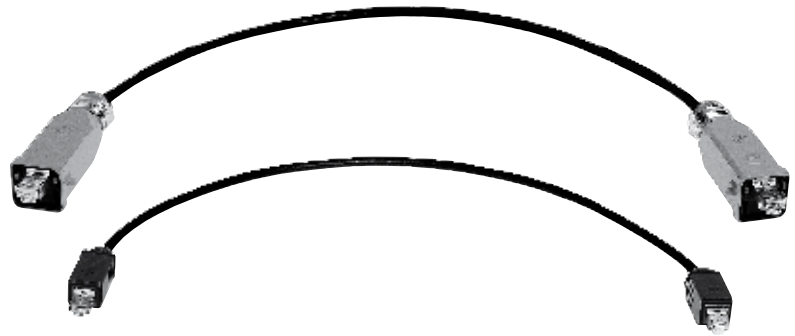

Outdoor cable assembly RJ 45,
8-wire Cat. 5 / Cat. 5e

Identification	Part No.	Drawing	Dimensions in mm
----------------	----------	---------	------------------

**HARTING PushPull
Outdoor cable, RJ45, 8-wire**

Length: a = 1.5 m
 a = 3.0 m
 a = 5.0 m
 a = 10.0 m
 a = 20.0 m

09 45 745 1105
 09 45 745 1107
 09 45 745 1109
 09 45 745 1114
 09 45 745 1116

double ended

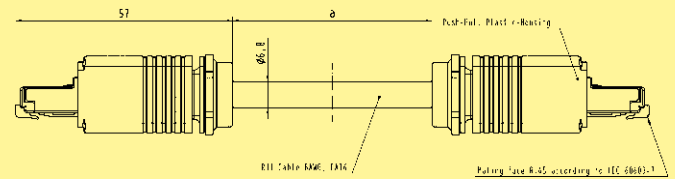

a = length

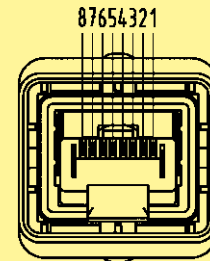

**Han® 3 A
Outdoor cable, RJ45, 8-wire**

Length: a = 1.5 m
 a = 3.0 m
 a = 5.0 m
 a = 10.0 m
 a = 20.0 m

09 45 715 1105
 09 45 715 1107
 09 45 715 1109
 09 45 715 1114
 09 45 715 1116

double ended

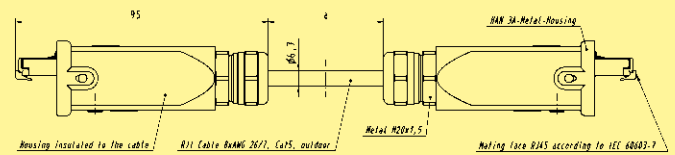

a = length

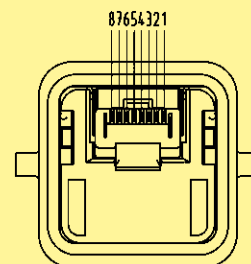

**Outdoor cable 8-wire, RJ45,
Cat. 5 / Cat. 5e, PVC**

Length: 20 m ring
 Length: 50 m ring
 Length: 100 m ring
 Length: 500 m reel

09 45 600 0230
 09 45 600 0240
 09 45 600 0200
 09 45 600 0220



Wire: bare stranded copper, AWG 26/7
 Overall screen: aluminium bonded polyester tape and tinned copper wire braid, braid coverage about 85 %
 Overall diameter: 6.5 – 6.9 mm

Further cable lengths are available on request



Outdoor cable assembly RJ 45,
8-wire Cat. 6

Identification	Part No.	Drawing	Dimensions in mm
<p>HARTING PushPull Outdoor cable, RJ45, 8-wire</p> <p>Length: a = 1.5 m a = 3.0 m a = 5.0 m a = 10.0 m a = 20.0 m</p>	<p>09 45 745 1578 09 45 745 1580 09 45 745 1582 09 45 745 1587 09 45 745 1589</p>	<p>double ended</p> <p>a = length</p>	
<p>Han® 3 A Outdoor cable, RJ45, 8-wire</p> <p>Length: a = 1.5 m a = 3.0 m a = 5.0 m a = 10.0 m a = 20.0 m</p>	<p>09 45 715 1583 09 45 715 1585 09 45 715 1587 09 45 715 1592 09 45 715 1594</p>	<p>double ended</p> <p>a = length</p>	
<p>Outdoor cable 8-wire, RJ45, Cat. 6, PVC</p> <p>Length: 20 m ring Length: 50 m ring Length: 100 m ring Length: 500 m reel</p>	<p>09 45 600 0531 09 45 600 0541 09 45 600 0501 09 45 600 0521</p>	<p>Wire: bare stranded copper, AWG 27/7 Pairs: aluminate foil overlapped PIMF Overall screen: tinned copper wire braid, braid coverage about 60 % Overall diameter: 6.3 – 6.9 mm</p>	

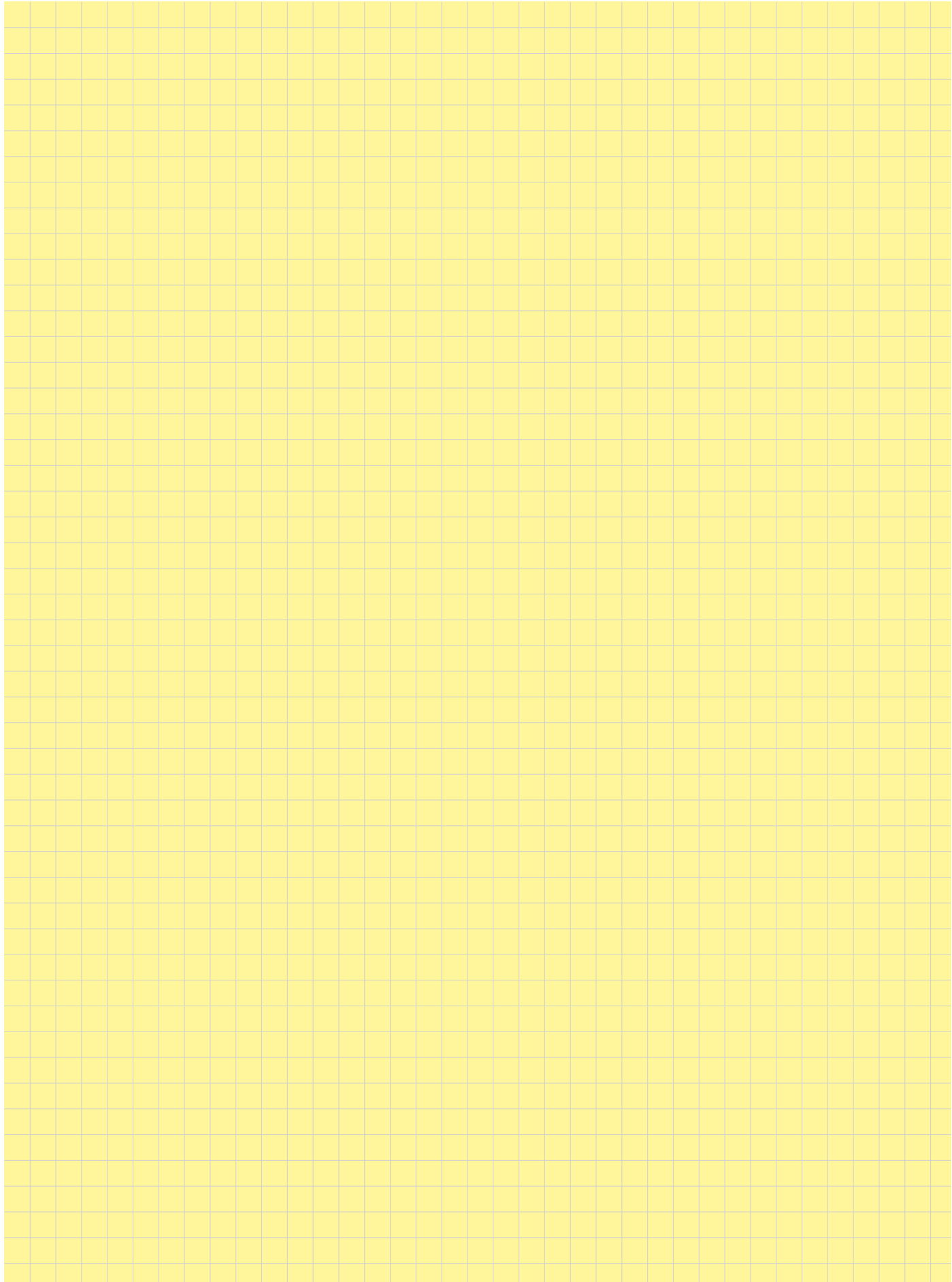

List of part numbers





Part No.	Page	Part No.	Page	Part No.	Page	Part No.	Page
09 20 003 5422	19	09 45 145 1100	14	09 45 715 0068	50	09 46 245 3410	35
09 20 003 5425	21	09 45 145 1500	14	09 45 715 0073	50	09 46 245 3430	35
09 20 003 5442	19	09 45 145 1510	14	09 45 715 0075	50	09 46 245 4000	31
09 20 003 5449	21			09 45 715 1105	51	09 46 245 4001	31
		09 45 195 1100	17	09 45 715 1107	51	09 46 245 4030	31
		09 45 195 1500	17	09 45 715 1109	51	09 46 245 4031	31
		09 45 195 1510	17	09 45 715 1114	51	09 46 245 4400	31
09 35 000 6103	37			09 45 715 1116	51	09 46 245 4430	31
09 35 000 6104	37			09 45 715 1583	52		
09 35 000 6105	37	09 45 215 1100	21	09 45 715 1585	52		
09 35 000 6106	37	09 45 215 1102	21	09 45 715 1587	52	09 46 295 4030	33
09 35 000 6107	37	09 45 215 1103	21	09 45 715 1592	52	09 46 295 4031	33
09 35 000 6190	37	09 45 215 1107	21	09 45 715 1594	52	09 46 295 4430	33
09 35 000 6203	37	09 45 215 1108	21				
09 35 000 6204	37	09 45 215 1109	21	09 45 745 1105	51		
09 35 000 6205	37	09 45 215 1109	21	09 45 745 1107	51	09 46 500 0401	32
09 35 000 6206	37	09 45 215 1110	21	09 45 745 1109	51	09 46 500 0402	33
09 35 000 6207	37			09 45 745 1114	51	09 46 500 0403	32
		09 45 225 1100	21	09 45 745 1116	51	09 46 500 0404	33
		09 45 225 1107	21	09 45 745 1578	52	09 46 500 0405	32
09 35 002 0323	37	09 45 225 1108	21	09 45 745 1580	52	09 46 500 0406	33
				09 45 745 1582	52		
09 35 002 3003	37			09 45 745 1587	52	09 46 500 4400	33
09 35 002 3004	37			09 45 745 1589	52		
09 35 002 5402	36	09 45 245 1102	15				
09 35 002 5411	36	09 45 245 1130	16			09 46 800 0000	44
				09 45 800 0000	44	09 46 800 0002	44
		09 45 295 1130	18	09 45 800 0001	44	09 46 800 0003	44
09 35 231 0333	36			09 45 800 0500	44	09 46 800 0010	44
09 35 231 0423	36					09 46 800 0098	44
		09 45 545 0021	15			09 46 800 0099	44
		09 45 545 0023	15	09 45 820 0000	19		
09 35 232 0333	36	09 45 545 0030	16	09 45 820 0000	20	09 46 840 0000	30
09 35 232 0421	36	09 45 545 0031	16	09 45 820 0000	21	09 46 840 0000	31
09 35 232 0423	36					09 46 840 0000	32
		09 45 551 1100	15	09 45 845 0003	15	09 46 840 0000	34
		09 45 551 1102	15	09 45 845 0003	18	09 46 840 0000	35
		09 45 551 1110	15	09 45 845 0003	32		
				09 45 845 0006	15		
09 37 003 5402	19			09 45 845 0006	18		
09 37 003 5406	21	09 45 595 0031	18	09 45 845 0009	15	09 47 363 6069	50
				09 45 845 0009	18	09 47 363 6071	50
		09 45 600 0105	50	09 45 845 0009	31	09 47 363 6073	50
		09 45 600 0115	50	09 45 845 0009	32	09 47 363 6078	50
09 45 115 1100	19	09 45 600 0135	50	09 45 845 0010	14	09 47 363 6080	50
09 45 115 1102	19	09 45 600 0145	50	09 45 845 0010	17		
09 45 115 1104	19	09 45 600 0200	51	09 45 845 0010	30		
09 45 115 1106	19	09 45 600 0220	51	09 45 845 0010	32		
09 45 115 1500	20	09 45 600 0230	51	09 45 845 0010	34		
09 45 115 1502	20	09 45 600 0240	51				
09 45 115 1510	20	09 45 600 0501	52			09 57 308 0500 000	40
09 45 115 1512	20	09 45 600 0521	52			09 57 308 0501 000	40
		09 45 600 0531	52	09 46 145 3410	34		
		09 45 600 0541	52				
09 45 125 1100	19			09 46 145 4400	30	09 57 368 0500 000	40
09 45 125 1104	19					09 57 368 0501 000	40
09 45 125 1500	20	09 45 715 0064	50			09 57 368 0510 000	40
09 45 125 1510	20	09 45 715 0066	50	09 46 195 4400	32	09 57 368 0511 000	40

List of part numbers



Part No.	Page	Part No.	Page	Part No.	Page	Part No.	Page
09 57 400 0001 000	26	09 99 000 0329	37	33 57 211 0100 001	49		
09 57 400 0002 000	26	09 99 000 0329	44	33 57 211 0100 002	49		
09 57 400 0003 000	26	09 99 000 0379	37	33 57 211 0105 001	48		
09 57 400 0004 000	26			33 57 211 0105 002	48		
				33 57 211 0200 001	49		
				33 57 211 0200 002	49		
09 57 402 0500 000	24			33 57 211 0205 001	48		
09 57 402 0501 000	24	19 00 000 5050	42	33 57 211 0205 002	48		
				33 57 211 0405 001	48		
09 57 407 0001 000	24			33 57 211 0405 002	48		
09 57 407 0002 000	24			33 57 211 0505 001	48		
				33 57 211 0505 002	48		
		19 62 000 5080	42	33 57 211 1005 001	48		
		19 62 000 5081	42	33 57 211 1005 002	48		
09 57 409 0500 000	25	19 62 000 5082	42				
09 57 409 0501 000	25	19 62 000 5084	42				
				33 57 851 0100 001	49		
				33 57 851 0100 002	48		
09 57 441 0500 000	24			33 57 851 0200 001	49		
09 57 441 0501 000	24			33 57 851 0200 002	48		
				33 57 851 5000 001	49		
09 57 467 0001 000	24	20 99 000 1031	45	33 57 851 5000 002	48		
09 57 467 0002 000	24	20 99 000 1033	45				
		20 99 000 3015	45				
				33 58 111 0010 001	47		
09 57 468 0500 000	25			33 58 111 0050 001	47		
09 57 468 0501 000	25			33 58 111 0100 001	47		
				33 58 111 0200 001	47		
09 57 469 1500 000	25	33 57 111 0010 001	49	33 58 111 0400 001	47		
09 57 469 1501 000	25	33 57 111 0010 002	49	33 58 111 0500 001	47		
		33 57 111 0015 001	48				
		33 57 111 0015 002	48	33 58 111 1000 001	47		
		33 57 111 0050 001	49				
09 57 508 0500 000	41	33 57 111 0050 002	49				
09 57 508 0501 000	41	33 57 111 0055 001	48	33 58 211 0010 001	47		
09 57 508 0510 000	41	33 57 111 0055 002	48	33 58 211 0050 001	47		
09 57 508 0511 000	41	33 57 111 0100 001	49	33 58 211 0100 001	47		
		33 57 111 0100 002	49	33 58 211 0200 001	47		
		33 57 111 0105 001	48	33 58 211 0400 001	47		
09 57 568 0500 000	41	33 57 111 0105 002	48	33 58 211 0500 001	47		
09 57 568 0501 000	41	33 57 111 0200 001	49				
09 57 568 0510 000	41	33 57 111 0200 002	49	33 58 211 1000 001	47		
09 57 568 0511 000	41	33 57 111 0205 001	48				
		33 57 111 0205 002	48				
		33 57 111 0405 001	48	33 58 751 0100 001	47		
		33 57 111 0405 002	48	33 58 751 0200 001	47		
		33 57 111 0505 001	48				
09 99 000 0001	37	33 57 111 0505 002	48	33 58 751 1000 001	47		
09 99 000 0001	44						
09 99 000 0004	45	33 57 111 1005 001	48				
09 99 000 0007	44	33 57 111 1005 002	48				
09 99 000 0008	44						
09 99 000 0012	45						
09 99 000 0021	45	33 57 211 0010 001	49				
09 99 000 0052	45	33 57 211 0010 002	49	98 40 000 0401	6		
09 99 000 0110	45	33 57 211 0015 001	48	98 40 000 0405	6		
09 99 000 0125	44	33 57 211 0015 002	48				
09 99 000 0203	44	33 57 211 0050 001	49				
09 99 000 0303	45	33 57 211 0050 002	49				
09 99 000 0311	44	33 57 211 0055 001	48				
09 99 000 0319	37	33 57 211 0055 002	48				

Please send me further information:

CD-ROM HARKIS® basic 
DVD HARKIS® basic 



Interface Connectors



Outdoor Solutions



Industrial Connectors Han®



Connectors
DIN 41612



Ethernet Network
Solutions Automation IT



Coaxial and Metric
Connectors



Application
brochure



TCA Connectors



Device Connectivity



Backplanes and
Integrated Systems

Sender:

Company: _____

Street: _____

Department: _____

Postcode/Town: _____

Name: _____

Country: _____

Prenome: _____

Phone: _____

Function: _____

Fax: _____

Please send it by post or fax to your local HARTING representatives (see page addresses) or visit us under www.HARTING.com.

E-Mail: _____

Production plants – worldwide



Espelkamp / Germany – Plant 1



Espelkamp / Germany – Plant 2



Espelkamp / Germany – Plant 3



Espelkamp / Germany – Plant 4



Espelkamp / Germany – Plant 5

Sales partner – worldwide



Argentina

Condelectric S.A.
Hipólito Yrigoyen 2591
(B1640HFY) Martínez, Buenos Aires
Phone + Fax +54 11 4836-1053
E-Mail: info@condelectric.com.ar

Denmark

Wexøe A/S
Lejrvej 31, DK-3500 Vaerloese
Phone +4545465800
Fax +4545465801
E-Mail: wexoe@wexoe.dk
Internet: www.wexoe.dk

Finland

INTOTEL OY
Kutojantie 4, 02630 Espoo, Finland
P.O. Box 125, 02631 Espoo, Finland
Phone +358-9-521 300
Fax +358-9-7553581
E-Mail: into@intotel.fi
Internet: www.intotel.fi

Israel

COMTEL
Israel Electronics Solutions Ltd.
Bet Hapamon, 20 Hataas st.
P.O.Box 66
Kefar-Saba 44425
Phone +972-9-7677240
Fax +972-9-7677243
E-Mail: sales@comtel.co.il
Internet: www.comtel.co.il

South Africa

Cabcon Technologies (PTY)Ltd
P.O. Box 13002, Northmead,
Benoni, 1511 Gauteng
Phone +27 1184533258
Fax +27 118454077
E-Mail: cabcon@mweb.co.za

Turkey

Gökhan Elektrik San. Tic. Ltd. Sti.
Perpa Elektrikçiler Is Merkezi A Blok
Kat:7-8-9 No.694
80270 Okmeydani/Istanbul
Phone +90(212) 2213236 (pbx)
Fax +90(212) 2213240
E-Mail: gokhan@gokhanelektrik.com.tr
Internet: www.gokhanelektrik.com



Zhuhai / China



Northampton / Great Britain



Biel / Switzerland



Sibiu / Romania



Elgin / USA

Australia

HARTING Pty Ltd
Suite 11 / 2 Enterprise Drive
Bundoora 3083, AUS-Victoria
Phone +61 9466 7088
Fax +61 9466 7099
E-Mail: au@HARTING.com
www.HARTING.com

Austria

HARTING Ges. m. b. H.
Deutschstraße 19, A-1230 Wien
Phone +431 6162121
Fax +431 6162121-21
E-Mail: at@HARTING.com
www.HARTING.at

Belgium

HARTING N.V./S.A.
Z.3 Doornveld 23, B-1731 Zellik
Phone +32 2 466 0190
Fax +32 2 466 7855
E-Mail: be@HARTING.com
www.HARTING.be

Brazil

HARTING Ltda.
Av. Dr. Lino de Moraes
Pq. Jabaquara, 255
CEP 04360-001 – São Paulo – SP – Brazil
Phone +55 11 5035 0073
Fax +55 11 5034 4743
E-Mail: br@HARTING.com
www.HARTING.com.br

China

Zhuhai HARTING Limited
Shanghai branch
Room 5403, HK New World Tower
300 Huai Hai Road (M.)
Shanghai 200021, China
Phone +86 21 6386 2200
Fax +86 21 6386 8636
E-Mail: cn@HARTING.com
www.HARTING.com.cn

Czech Republic

HARTING spol. s.r.o.
Mlýnská 2, CZ-160 00 Praha 6
Phone +420 220 380 460
Fax +420 220 380 461
E-Mail: cz@HARTING.com
www.HARTING.cz

Finland

HARTING Oy
Teknobulevardi 3-5, PL 35
FI-01530 Vantaa
Phone +358 9 350 87 300
Fax +358 9 350 87 320
E-Mail: fi@HARTING.com
www.HARTING.fi

France

HARTING France
181 avenue des Nations, Paris Nord 2
BP 66058 Tremblay en France
F-95972 Roissy Charles de Gaulle Cédex
Phone +33 1 4938 3400
Fax +33 1 4863 2306
E-Mail: fr@HARTING.com
www.HARTING.fr

Germany

HARTING Deutschland GmbH & Co. KG
Postfach 2451, D-32381 Minden
Simeons carré 1, D-32427 Minden
Phone +49 571 8896 0
Fax +49 571 8896 282
E-Mail: de@HARTING.com
www.HARTING.com

Office Germany

HARTING Deutschland GmbH & Co. KG
Blankenauer Straße 99
D-09113 Chemnitz
Phone +49 0371 429211
Fax +49 0371 429222
E-Mail: de.sales@HARTING.com
www.HARTING.com

Great Britain

HARTING Ltd., Caswell Road
Brackmills Industrial Estate
GB-Northampton, NN4 7PW
Phone +44 1604 827 500
Fax +44 1604 706 777
E-Mail: gb@HARTING.com
www.HARTING.co.uk

Hong Kong

HARTING (HK) Limited,
Regional Office Asia Pacific
3512 Metroplaza Tower 1
223 Hing Fong Road
Kwai Fong, N. T., Hong Kong
Phone +852 2423 7338
Fax +852 2480 4378
E-Mail: ap@HARTING.com
www.HARTING.com.hk

Hungary

HARTING Magyarország Kft.
Fehérvári út 89-95, H-1119 Budapest
Phone +36 1 205 34 64
Fax +36 1 205 34 65
E-Mail: hu@HARTING.com
www.HARTING.hu

India

HARTING India Private Limited
No. D, 4th Floor, ,Doshi Towers'
No. 156 Poonamallee High Road,
Kilpauk, Chennai 600 010
Tamil Nadu, Chennai
Phone +91 44 435604 15
Fax +91 44 435604 17
E-Mail: in@HARTING.com
www.HARTING.com

Italy

HARTING SpA
Via dell'Industria 7
I-20090 Vimodrone (Milano)
Phone +39 02 250801
Fax +39 02 2650 597
E-Mail: it@HARTING.com,
www.HARTING.it

Japan

HARTING K. K.
Yusen Shin-Yokohama 1
Chome Bldg., 2F
1-7-9, Shin-Yokohama, Kohoku-ku,
Yokohama 222-0033 Japan
Phone +81 45 476 3456
Fax +81 45 476 3466
E-Mail: jp@HARTING.com
www.HARTING.co.jp

Korea

HARTING Korea Limited
#308 Yatap Leaders Building, 342-1,
Yatap-dong, Bundang-gu,
Sungnam-City, Kyunggi-do
463-828, Republic of Korea
Phone +82 31 781 4615
Fax +82 31 781 4616
E-Mail: kr@HARTING.com
www.HARTING.com.cn/kr

Netherlands

HARTING B.V.
Larenweg 44
NL-5234 KA ,s-Hertogenbosch
Postbus 3526
NL-5203 DM ,s-Hertogenbosch
Phone +31 736 410 404
Fax +31 736 440 699
E-Mail: nl@HARTING.com
www.HARTINGbv.nl

Norway

HARTING A/S
Østensjøveien 36, N-0667 Oslo
Phone +47 22 700 555
Fax +47 22 700 570
E-Mail: no@HARTING.com
www.HARTING.no

Subsidiary companies – worldwide



Poland

HARTING Polska Sp. z o. o.
ul. Kamieńskiego 201-219
PL-51-126 Wrocław
Phone +48 71 352 81 71
Fax +48 71 320 74 44
E-Mail: pl@HARTING.com
www.HARTING.pl

Portugal

HARTING Iberia, S. A.
Avda. Josep Tarradellas,
20-30, 4º 6ª
E-08029 Barcelona
Phone +351 219 673 177
Fax +351 219 678 457
E-Mail: es@HARTING.com
www.HARTING.es/pt

Russia

HARTING ZAO
Maliy Sampsoniyevsky prospect 2A
194044 Saint Petersburg, Russia
Phone +7 812 327 6477
Fax +7 812 327 6478
E-Mail: ru@HARTING.com
www.HARTING.ru

Singapore

HARTING Singapore Pte Ltd.
25 International Business Park
#02-06 German Centre
Singapore 609916
Phone +65 6225 5285
Fax +65 6225 9947
E-Mail: sg@HARTING.com
www.HARTING.com

Spain

HARTING Iberia S.A.
Josep Tarradellas 20-30 4º 6ª
E-08029 Barcelona
Phone +34 93 363 84 75
Fax +34 93 419 95 85
E-Mail: es@HARTING.com
www.HARTING.es

Sweden

HARTING AB
Gustavslundsvägen 141 B 4tr
S-167 51 Bromma
Phone +46 8 445 7171
Fax +46 8 445 7170
E-Mail: se@HARTING.com
www.HARTING.se

Switzerland

HARTING AG
Industriestrasse 26
CH-8604 Volketswil
Phone +41 44 908 20 60
Fax +41 44 908 20 69
E-Mail: ch@HARTING.com
www.HARTING.ch

Taiwan

HARTING R.O.C. Limited
Room 1, 5th Floor
No. 495 GuangFu South Road
Taiwan – Taipei 110
Tel. +886 02-2 758-6177
Fax +886 02-2758-7177
E-Mail: tw@HARTING.com
www.HARTING.com.tw

USA

HARTING Inc. of North America
1370 Bowes Road, USA-Elgin,
Illinois 60123
Phone +1 877 741-1500 (toll free)
Fax +1 866 278-0307 (Inside Sales)
Fax +1 847 717-9430 (Sales and
Marketing)
E-Mail: us@HARTING.com
www.HARTING-USA.com

Eastern-Europe

HARTING Eastern Europe GmbH
Bamberger Straße 7
D-01187 Dresden
Phone +49 351 4361 760
Fax +49 351 4361 770
E-Mail:
Eastern.Europe@HARTING.com
www.HARTING.com

Distributor – Switzerland



Distrelec AG
Grabenstrasse 6
CH-8606 Nänikon
Phone +41 1 944 99 11
Fax +41 1 944 99 88
E-Mail: info@distrelec.com
Internet: www.distrelec.com

Distributors – worldwide



Farnell InOne:
www.farnellinone.com;
in US: Newark InOne:
www.newarkinone.com

RS Components:
www.rs-components.com;
in US: Allied Electronics:
www.alliedelec.com

FUTURE Electronics
www.futureelectronics.com

Other countries



HARTING
Electronics GmbH & Co. KG
P.O. Box 1433
D-32328 Espelkamp
Phone +495772/47-97200
Fax +495772/47-777
E-Mail:
electronics@HARTING.com

Global Business Unit Electronics



HARTING Electronics
GmbH & Co. KG
P.O.Box 1433
D-32328 Espelkamp
Phone +495772/47-97200
Fax +495772/47-777
E-Mail: electronics@HARTING.com
Internet: www.HARTING.com



Pushing Performance

www.HARTING.com