

# Harmony™ XB4/XB5/XB7 22 mm push buttons

Catalog  
2014



**Schneider**  
Electric™



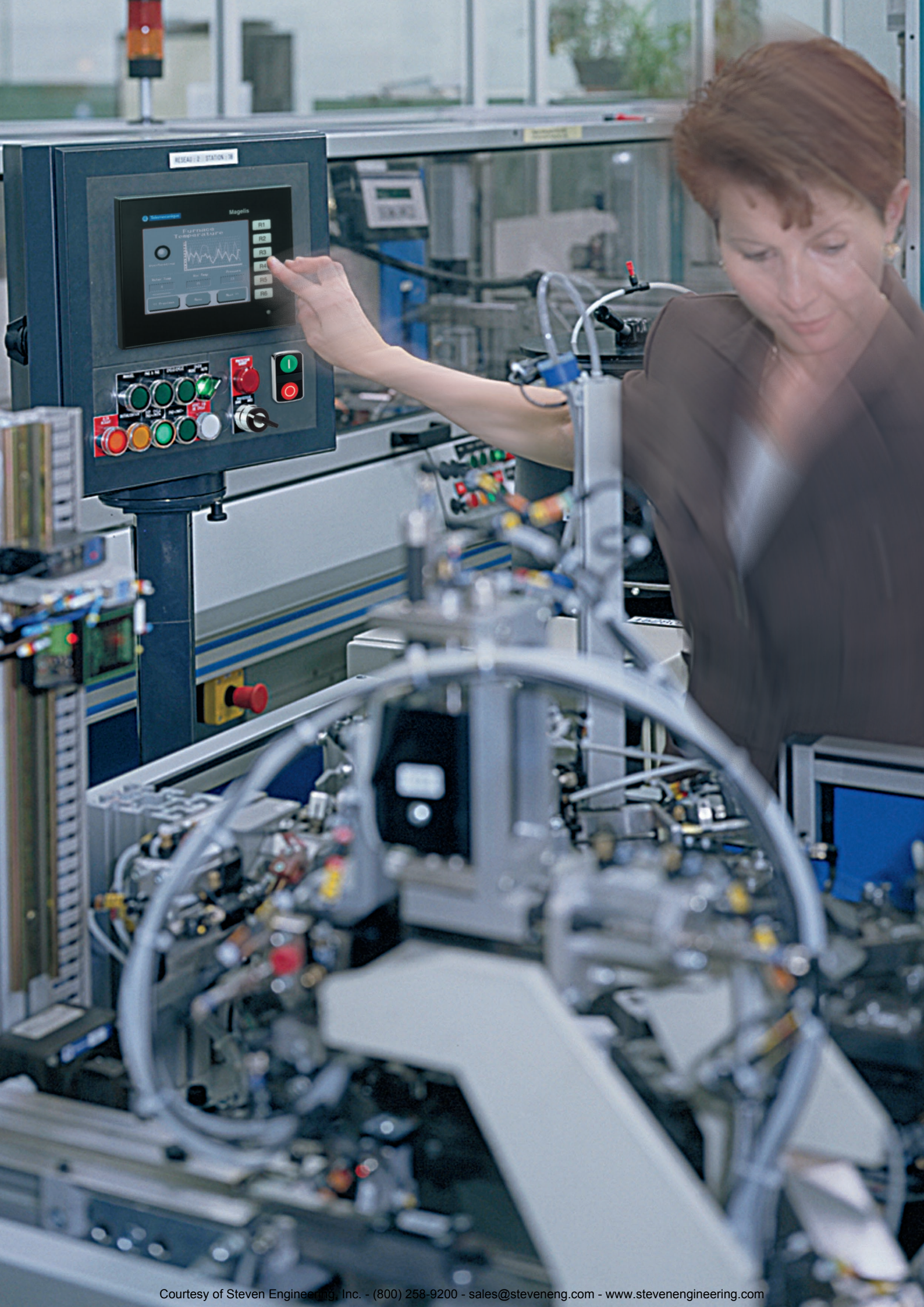



# Harmony™ 22 mm push buttons...

your all-around solution for all your 22 mm push button applications.

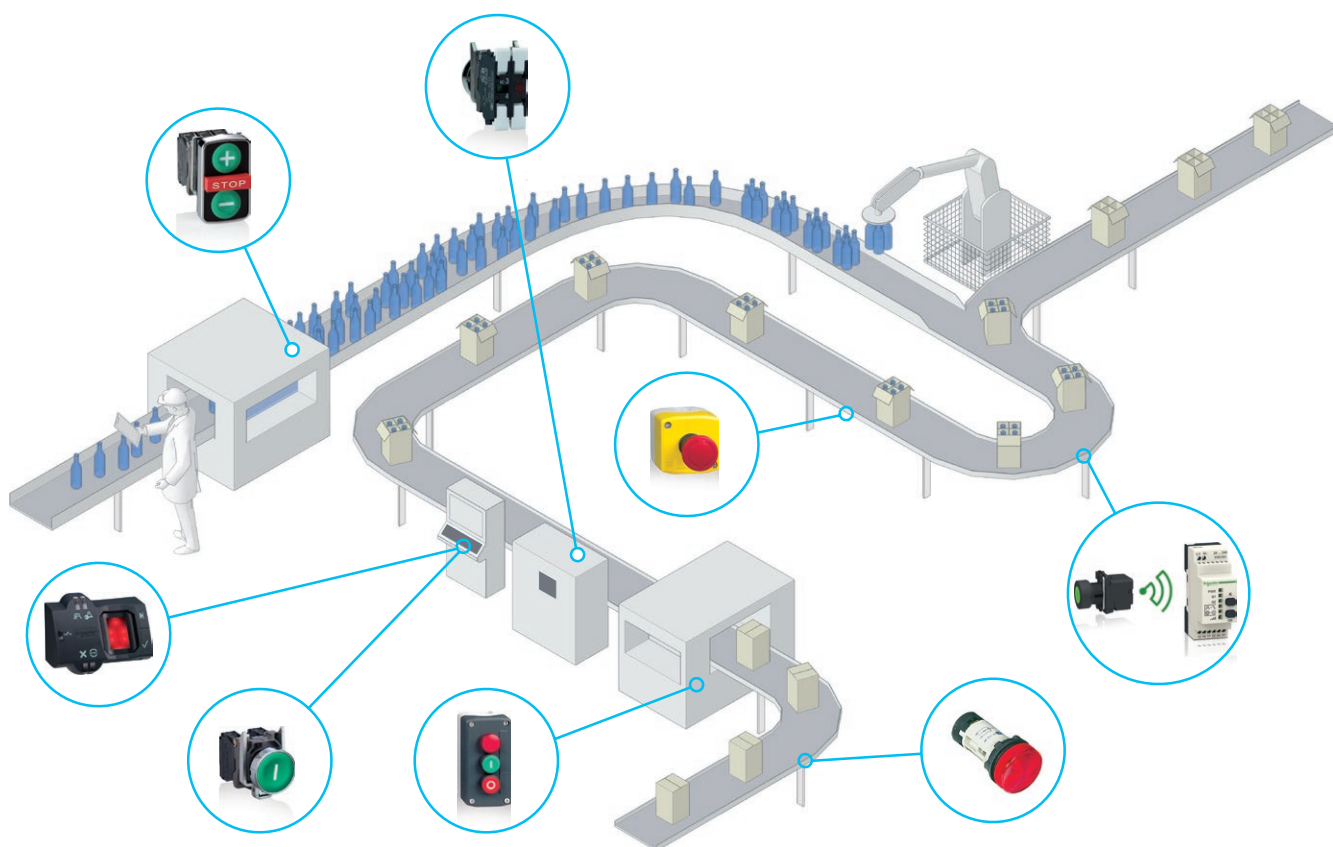

## > Reliable components for any situation...

- Robust
- Conforms to the highest quality and safety standards

## > Innovative solutions for any application...

- Comprehensive, complimentary product line

## > Time-savings for added value...

- Simplicity and speed of installation
- Worldwide availability

## Harmony also has a comprehensive line of:

- Beacons and indicator banks
- Control stations
- Cam switches
- Joystick controllers



## Control machine access... Biometric switch

Designed to restrict access to industrial machines or processes to authorized personnel only, for...

- starting, set-up, adjustment
- switching to maintenance mode
- re-setting following an emergency stop

### Robust and reliable

- Reduces problems inherent in existing systems: loss, theft or copying of keys, badges and passwords
- IP65, NEMA 12 degree of protection
- Protective cover (as accessory)
- Resistant to mechanical shock and vibration
- EMC protection

➔ For more information, see [page 160](#)



### Simple

- Mounted in the same way as a standard 22 mm switch
- Fully stand-alone product with direct parametering and registration/recording on front face

### 200

recordable fingerprints capacity

## Reduce installation time... Wireless, batteryless push buttons

By totally eliminating cabling and components between the push button and the electrical cabinet, you save installation time, and reduce your installation costs.

### Simplified machine cabling

- with completely wireless push buttons

### Easier integration through open protocols

- by serial link Modbus™ and Ethernet Modbus/TCP

### Architecture solutions

- for integration into industrial and building environments

➔ For more information, see [page 170](#)





## Choose high performance, compact, robust solutions...

### Monolithic push buttons

For your control systems that require high-performance, compact, and easy-to-install components...Harmony XB7 push buttons are your ideal solution. The new Emergency Stop push button design allows immediate identification of safety functions and status of contacts.

#### Simple installation, simple integration

- easy to install and to integrate into your Control Systems

#### Designed for quality and conformity

- conforms to industry standards and Machinery Directive

#### High performance for industrial applications

- robust, durable controls for industry and buildings



➔ For more information, see [page 190](#)

## Complete

product range

## Boost performance and speed...

### Contact blocks

#### Quick and secure connection

##### Spring terminal connection

- Intuitive cabling without using tool
- Excellent resistance to mechanical shock and vibration
- Trustworthy, safe and secure connections

➔ For more information, see [pages 50 & 124](#)



## 66% savings

in connection time vs. a  
screw clamp connector

# Contents



## Selection guide

Harmony™ XB4 metal and XB5/XB7 plastic 22 mm push buttons	8
Harmony™ control stations and enclosures	10



## Harmony™ XB4 metal products





<b>Product range</b>	12
<b>Schematic library</b>	13
<b>Introduction</b>	
Complete units	14
Sub-assemblies	16
<b>Specifications</b>	
Complete units and sub-assemblies	20
<b>Installation</b>	
Contact mounting	24
Contact sequence for selector switches	25
<b>References</b>	
Push buttons, spring return	
• Unmarked	26
• With marking	28
• Illuminated with integral LED	29
• Illuminated with BA 9s base fitting	31
Multiple head push buttons, spring return	
• Double-headed push buttons	32
• + 1 white central pilot light block	32
• Triple-headed push buttons	33
• Accessories	33
Mushroom head push buttons	
• Spring return	34
• Illuminated, spring return	34
• Latching	35
• Illuminated, latching	35
Emergency stop devices	
• Trigger action and mechanical latching	36
Emergency switching off devices	
• Mechanical latching	37
• Illuminated, mechanical latching	37
Selector switches	
• With standard handle	38
• With long handle	39
• With long handle, padlockable	39
• Key switches	40
• With knurled knob	41
• Illuminated, w/ standard handle and integral LED	42
Toggle switches	41
Pilot lights	
• With integral LED	44
• With BA 9s base fitting	45
Specific functions	
• Heads for manual overload reset push buttons	46
• Heads + mounting base for potentiometer	46
• Hour counters	46
• Annunciators	46
• Fuse carrier	46
• Joystick controllers	47
• Wobble stick heads	47
Contact and illuminated functions (blocks & bodies)	
• With screw clamp terminal connections	48
• With spring clamp terminal connections	50
• For printed circuit board	51
• With Faston® connectors	52
• For plug-in connector	53
Contact and illuminated functions (bodies)	
• With integral LED	54
• With BA 9s base fitting	58
Contact and light blocks for specific applications	
• Contact blocks	48
• Flashing light blocks	49
• Light blocks for "remote test" function	49
• LED suppressors	49
Accessories	
• For heads	60
• For push buttons	68
Legends, legend holders	62
<b>Dimensions and mounting</b>	72



## Harmony™ XB5 plastic products

<b>Product range</b>	84
<b>Schematic library</b>	85
<b>Introduction</b>	
Complete units	86
Sub-assemblies	88
<b>Specifications</b>	
Complete units and sub-assemblies	92
<b>Installation</b>	
Contact mounting	96
Contact sequence for selector switches	97
<b>References</b>	
Push buttons, spring return	
• Unmarked	98
• With marking	102
• Illuminated with integral LED	103
• Illuminated with BA 9s base fitting	105
Multiple head push buttons, spring return	
• Double-headed push buttons	106
• Triple-headed push buttons	107



• + 1 white central pilot light block . . . . .	106	• Accessories . . . . .	107
<b>Mushroom head push buttons</b>		• Illuminated, latching . . . . .	109
• Spring return . . . . .	108		
• Latching . . . . .	109		
<b>Emergency stop devices</b>		• Illuminated, trigger action and mechanical latching	110
• Trigger action and mechanical latching . . . . .	110		
<b>Emergency switching off devices</b>		• Illuminated, mechanical latching . . . . .	111
• Mechanical latching . . . . .	111		
<b>Push buttons</b>			
• Push-turn to release . . . . .	112		
<b>Selector switches</b>		• With knurled knob . . . . .	115
• With standard handle . . . . .	113	• Illuminated, w/ standard handle and integral LED	116
• With long handle . . . . .	113		
• Key switches . . . . .	114		
<b>Toggle switches</b> . . . . .	115		
<b>Pilot lights</b>		• With BA 9s base fitting . . . . .	119
• With integral LED . . . . .	118		
<b>Specific functions</b>		• Annunciators . . . . .	120
• Heads for manual overload reset push buttons	120	• Fuse carrier . . . . .	120
• Heads + mounting base for potentiometer . . . . .	120	• Joystick controllers . . . . .	121
• Hour counters . . . . .	120		
<b>Contact and illuminated functions (blocks &amp; bodies)</b>		• With Faston® connectors . . . . .	126
• With screw clamp terminal connections . . . . .	122	• For plug-in connector . . . . .	127
• With spring clamp terminal connections . . . . .	124		
• For printed circuit board . . . . .	125		
<b>Contact and illuminated functions (bodies)</b>		• With BA 9s base fitting . . . . .	132
• With integral LED . . . . .	128		
<b>Contact and light blocks for specific applications</b>		• Light blocks for “remote test” function . . . . .	123
• Contact blocks . . . . .	122	• LED suppressors . . . . .	123
• Flashing light blocks . . . . .	123		
<b>Accessories</b>		• For push buttons . . . . .	144
• For heads . . . . .	134		
<b>Legends, legend holders</b> . . . . .	138		
<b>Dimensions and mounting</b> . . . . .	148		
 <b>Harmony™ XB5S biometric switch</b> . . . . .	160		
<b>Selection guide</b> . . . . .	164		
<b>Introduction</b> . . . . .	166		
<b>Description and references</b> . . . . .	167		
<b>Specifications, connections and dimensions</b> . . . . .	168		
 <b>Harmony™ XB5R plastic and XB4R metal wireless, batteryless products</b> . . . . .	170		
<b>Introduction</b> . . . . .	176		
<b>Description</b> . . . . .	177		
<b>Specifications</b> . . . . .	179		
<b>References</b>			
Ready-to-use packs . . . . .	183		
Transmitter components . . . . .	184		
Programmable receivers . . . . .	185		
Accessories . . . . .	185		
<b>Dimensions and wiring diagrams</b> . . . . .	186		
<b>ZBRN1 and ZBRN2 Access points</b> . . . . .	188		
 <b>Harmony™ XB7 plastic products</b> . . . . .	190		
<b>Introduction</b> . . . . .	194		
<b>Specifications</b>			
Monolithic push buttons, switches and pilot lights . . . . .	195		
<b>References</b>			
Push buttons, spring return			
• Unmarked . . . . .	197	• With marking . . . . .	198
Pilot lights		Push buttons, illuminated	
• With integral LED . . . . .	199	• With integral LED . . . . .	199
Selector switches and key switches . . . . .	200		
Emergency stop trigger action and mechanically latching push buttons . . . . .	200		
Legends, legend holders . . . . .	201		
Accessories . . . . .	202		
<b>Dimensions and mounting</b> . . . . .	203		
 <b>Multiple head spring return push buttons substitution table</b> . . . . .	206		
 <b>Product reference index</b> . . . . .	208		

# Harmony™ XB4 metal and XB5/XB7 plastic 22 mm push buttons

Applications		Pilot lights		Push buttons, selector switches and pilot lights		
Description of the range		<ul style="list-style-type: none"> <li>■ LED pilot lights</li> <li>■ Push buttons</li> <li>■ Emergency Stop buttons</li> <li>■ Emergency switching off push buttons</li> <li>■ Selector switches and key switches</li> <li>■ Illuminated push buttons</li> <li>■ Pilot lights</li> </ul>				
Features	Products	Monolithic, compact, low consumption		Complete units or sub-assemblies (body + head)		Monolithic
	Bezel	Double insulated		Metal, chromium plated or black	Double insulated	
	Shape of head	Circular	Circular, square or rectangular	Circular	Circular or square	Circular
Drilling or cut-out for mounting		8 and 12 mm	16 mm	22 mm	22 and 25 mm	
Degree of protection		Conforming to IEC60529	IP 40 IP 65 with seal	IP 65	IP 66 IP 69K for selectors switches, multiple-headed push buttons, and booted push buttons	IP 54
Cabling		Tags for 2.8 x 0.5 mm connectors, or threaded connector	Faston® connectors Solder pins for printed circuit boards	Spring clamp terminal connections Screw clamp terminal connections Faston connectors Connector With adaptor for printed circuit board	Screw clamp terminal connections	
Mounting		Panel thickness	1 to 8 mm	1 to 6 mm		
Type references		<b>XVLA</b>	<b>XB6</b>	<b>XB4</b>	<b>XB5</b>	<b>XB7</b>
Pages		Please refer to the Digest		26 to 47	98 to 121	190 to 204



Joystick controllers	Push buttons, selector switches and pilot lights	Cam switches
----------------------	--	--------------

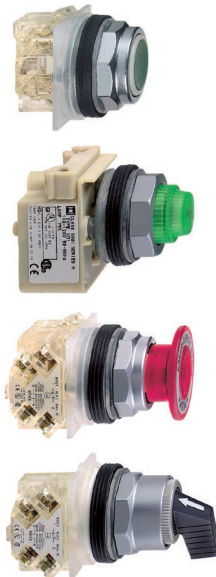

- 2 or 4 direction
- Stay put or spring return

- Push buttons
- Emergency Stop buttons
- Emergency switching off push buttons
- Selector switches and key switches
- Illuminated push buttons
- Pilot lights

- Switches
- Stepping switches
- Reversing and changeover switches
- Ammeter switches
- Voltmeter switches
- Reversing switches
- Star-delta and reversing star-delta switches
- Pole change switches

Complete units or sub-assemblies (body + head with lever)			Complete units or sub-assemblies (body + head)	Complete units or sub-assemblies (body + front panel + head)
Chromium plated metal	Double insulated, black		Chromium plated metal or double insulated	Metal, chromium plated or black Double insulated
Circular			Hexagonal	Square
22 mm			30 mm	16 or 22 mm: series K10 22 mm and multimounting: series K2 4 holes, 48 or 68 centers: series K30 to K150
IP 65	IP 66	IP 65	IP 65	IP65: series K10 IP 40, IP 65 with seal: series K2 IP 40: series K30 to K150
Screw and captive cable clamp connections			Screw and captive cable clamp connections	
1 to 6 mm			1 to 6 mm	0.5 to 6 mm (depending on model)
<b>XD4PA</b>	<b>XD2GA</b>	<b>XD5PA</b>	<b>9001K, 9001SK</b>	<b>K10, K2, K30, K50, K63, K115, K150</b>
47	Please refer to the Digest	121	Please refer to the Digest	Please refer to the Digest

# Harmony™ control stations and enclosures

<b>Ranges</b>	<b>Universal</b>		
	<b>Plastic</b>		<b>Metal</b>
	<b>Complete stations and separate components for customer assembly</b>	<b>Complete stations and separate components for customer assembly</b>	<b>Empty enclosures</b>



<b>Main feature</b>	Pre-drilled enclosures		Pre-drilled or undrilled enclosures
<b>Associated control and signaling units</b>	Harmony XB5 with plastic bezel		Harmony XB4 with metal bezel Harmony XB5 with plastic bezel
<b>Number of cut-outs for 22 mm control and signaling units</b>	1, 2, 3, 4 or 5	1, 2 or 3 (complete stations) 1, 2, 3, 4 or 5 (empty enclosures)	1, 2, 3, 4, 6, 8 or 12
<b>Material</b>	Polycarbonate		Zinc or aluminium alloy
<b>Color</b>	Yellow lid Light grey base	Dark grey lid Light grey base	<b>XAP M:</b> Blue lid Blue base <b>XAP J:</b> Yellow lid Blue base
<b>Degree of protection</b>	IP 66 IP 69K with boot		IP 65
<b>Function</b>	Emergency stop	Start or Stop Start-Stop with pilot light Movement control	According to equipment fitted: <input type="checkbox"/> Start or Stop <input type="checkbox"/> Start-Stop with pilot light <input type="checkbox"/> Movement control <input type="checkbox"/> Emergency stop
<b>Cable entries</b>	Knock-outs		Drilled
<b>Type references</b>	<b>XALK</b>	<b>XALD</b>	<b>XAPM, XAPJ</b>
<b>Page(s)</b>	Please refer to the Digest		



Universal		Optimum		Application specific	
Metal	Metal front plate, insulated protective rear cover	Plastic			Metal
Empty enclosures	Empty, flush mounting enclosures: front plate + rear cover	Empty insulated enclosures	Complete stations and separate components for customer assembly	Enclosures for severe environments	Key operated control stations



Pre-drilled enclosures	Pre-drilled front plates & rear covers	Pre-drilled or undrilled enclosures	Pre-drilled enclosures	Pre-drilled empty enclosures	Fitted stations
Harmony XB4 with metal bezel Harmony XB5 with plastic bezel			Harmony XB7, monolithic, plastic	Harmony XB5 with plastic bezel	With key lock bezel
8, 16, 24, 30 or 40	1, 2, 3, 4 or 5	1, 2, 4, 8 or 16	1, 2 or 3	1, 2, 3, 4 or 5	–
Aluminium alloy or sheet steel	Front plate: brushed aluminium Rear cover: polystyrene	Glass-reinforced polyester	ABS	Mineral reinforced polyamide	Zinc alloy
Blue lid and base	Unpainted aluminium	Colored grey throughout	Light grey or yellow lid Light grey base	Black lid Black base	Grey
IP 54	IP 65		IP 54	IP 66	IP 54
According to equipment fitted: <input type="checkbox"/> Start or Stop <input type="checkbox"/> Start-Stop with pilot light <input type="checkbox"/> Movement control <input type="checkbox"/> Emergency stop					Start-Stop
Drilled	Knock-outs	Tapped for cable gland	Knock-outs	ISO 20	Tapped for cable gland
<b>XB2SL</b>	<b>XAPE</b>	<b>XAPA</b>	<b>XAL E</b>	<b>XAL G</b>	<b>XAP S</b>

Please refer to the Digest

# Harmony™ XB4 metal 22 mm push buttons

Push buttons, switches and pilot lights

**Description**

The 22 mm product range of metal control and signaling units is comprised of:

Complete units with chromium plated metal bezel, XB4B

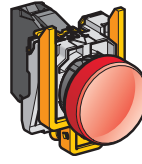
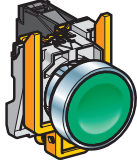

Push buttons and switches

Pilot lights

Sub-assemblies with chromium plated or black metal bezel, ZB4B

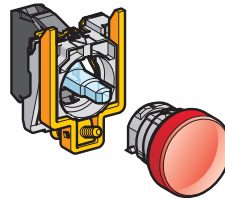
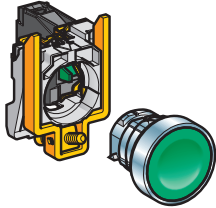

Push buttons and switches:  
body + head sub-assemblies

Pilot lights:  
body + head sub-assemblies

ZB component parts and accessories

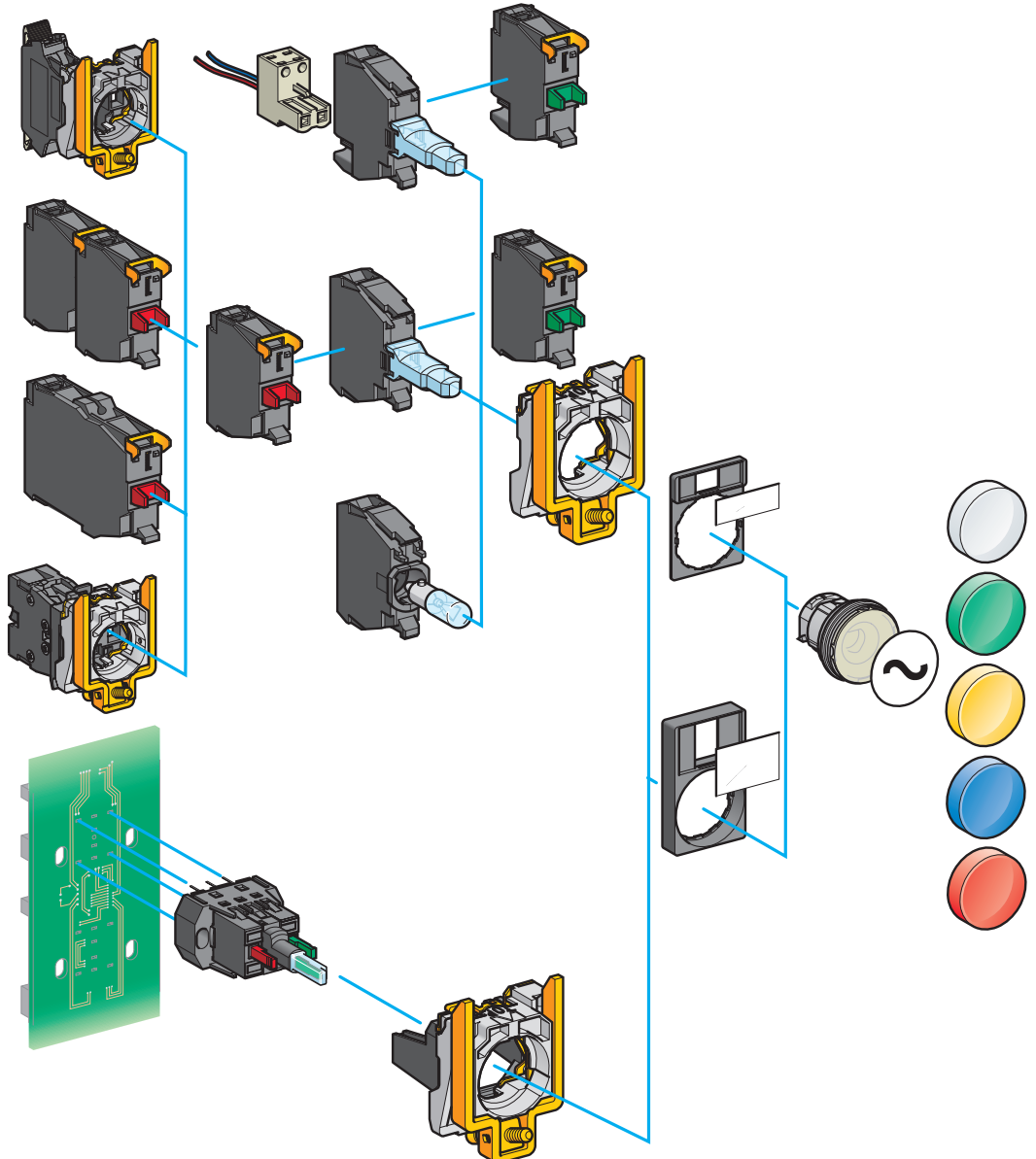

## Schematic library

### Typical wiring diagrams

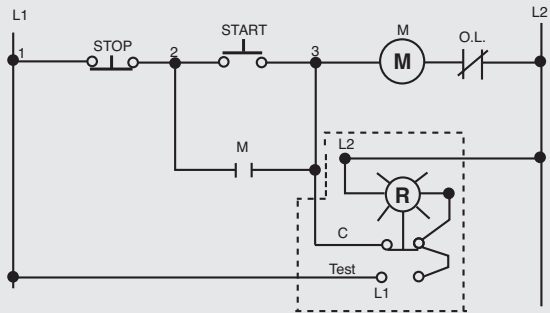

Push-To-Test Pilot Light

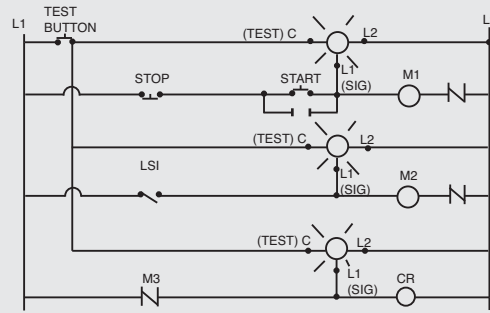

Remote Test Pilot Light

### Joystick controller functions

#### 2 direction

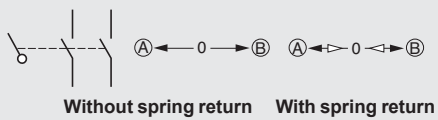

#### 4 direction

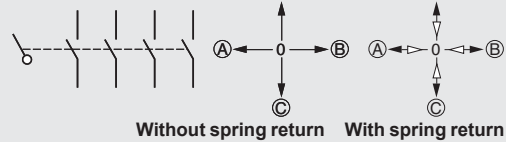

# Harmony™ XB4 metal 22 mm push buttons

Push buttons, switches and pilot lights:  
complete units, XB4B

## Complete units

## Contact functions

Push buttons, spring return,  
with chromium plated metal  
bezel

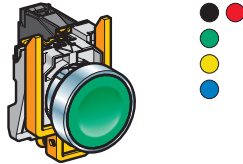

Flush push, unmarked  
XB4BA●1/BA42  
see page 26

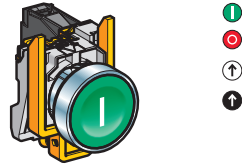

Flush push, with marking  
XB4BA3311  
see page 28

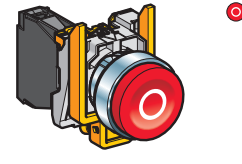

Projecting push, with marking  
XB4BL4322  
see page 28

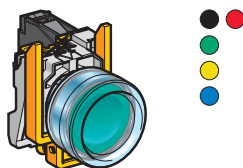

Booted flush push  
XB4BP●1/BP42  
see page 27

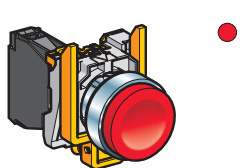

Projecting push, unmarked  
XB4BL42  
see page 27

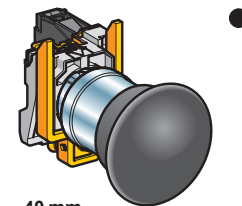

40 mm  
Mushroom head  
XB4BC21  
see page 34

Multiple-headed push  
buttons, spring return, with  
chromium plated metal bezel

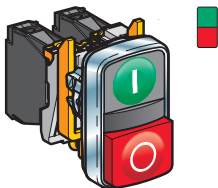

Double-headed  
XB4BL73415  
see page 33

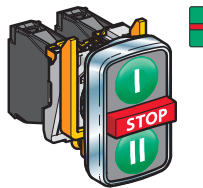

Triple-headed  
XB4BA731327/XB4BA711237  
see page 33

Emergency Stop or  
Emergency switching off  
mushroom head push  
buttons, 40 mm, with  
chromium plated metal bezel

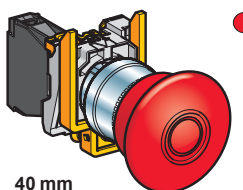

40 mm

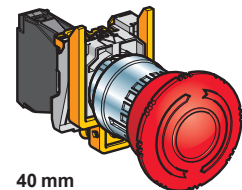

40 mm

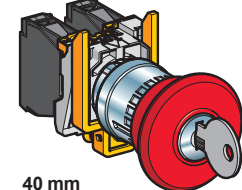

40 mm

Emergency stop trigger  
action and mechanical  
latching

Push-pull (EN/ISO 13850: 2006)  
XB4BT845  
see page 36

Turn to release (EN/ISO 13850: 2006)  
XB4BS844●  
see page 36

Key release (EN/ISO 13850: 2006)  
XB4BS9445  
see page 36

Emergency switching off  
mechanical latching

Push-pull (IEC 60364-5-53)  
XB4BT42  
see page 37

Turn to release (IEC 60364-5-53)  
XB4BS542  
see page 37

Key release (IEC 60364-5-53)  
XB4BS142  
see page 37

Selector switches and key  
switches, with chromium  
plated metal bezel

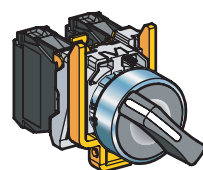

Standard handle, black  
XB4BD●●  
see page 38

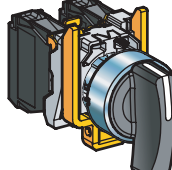

Long handle, black  
XB4BJ●●  
see page 39

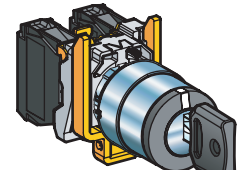

Key switch  
XB4BG●●  
see page 40



# Harmony™ XB4 metal 22 mm push buttons

Push buttons, switches and pilot lights:  
complete units, XB4B

## Complete units

## Signaling functions

### Pilot lights

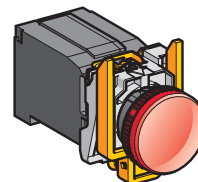
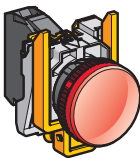
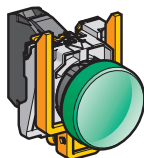

Integral LED

**XB4BVB●/BVG●/BVM●**  
see page 44

For bulb with BA 9s base fitting  
Direct supply

**XB4BV6●**  
see page 45

Via integral transformer with secondary

**XB4BV3●/BV4●**  
see page 45

## Combined functions (contact + signaling)

### Illuminated push buttons, spring return, flush push, chromium plated metal bezel

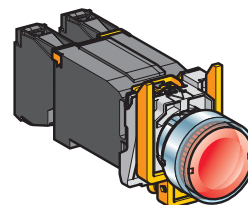
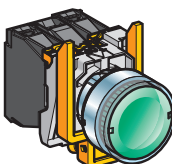
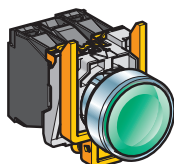

Integral LED

**XB4BW3●B5/BW3●G5/BW3●M5**  
see page 29

For bulb with BA 9s base fitting  
Direct supply

**XB4BW3●65**  
see page 31

Via integral transformer

**XB4BW3●35/BW3●45**  
see page 31

### Double-headed push buttons + pilot light block, spring return, chromium plated metal bezel

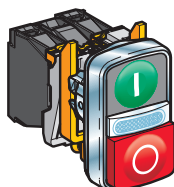

Integral LED

**XB4BW73731●5**  
see page 32

### Illuminated selector switches with standard handle, chromium plated metal bezel

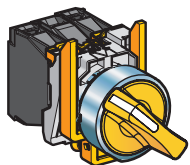

Integral LED

**XB4BK12●●5, XB4BK13●●5**  
see page 42

### Wireless, batteryless push button

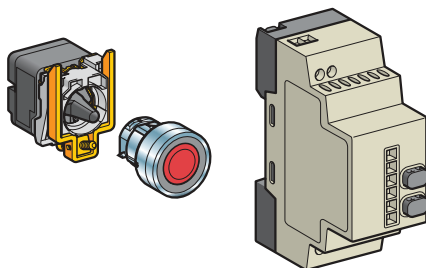

Ready-to-use packs

**XB4R●●●●**  
see page 188

# Harmony™ XB4 metal 22 mm push buttons

Push buttons, switches and pilot lights:  
sub-assemblies, ZB4B

**Non-illuminated units  
for user assembly**

**Contact functions**

For push buttons,  
spring return, unmarked

Body  
sub-assemblies

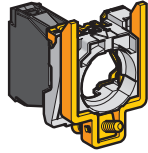

Screw clamp  
terminals  
ZB4BZ10/BZ141  
page 48

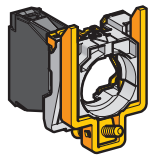

Faston®  
ZB4BZ10/3  
page 52

For push buttons,  
spring return, with marking

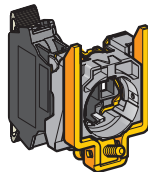

Spring clamp  
terminals  
ZBE 10/5  
ZB4BZ10/5  
page 50

For multiple-headed push  
buttons, spring return

Head sub-assemblies, chromium plated or black metal bezel

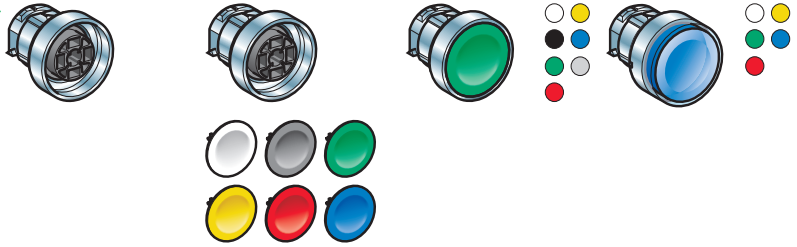

Flush push  
without cap  
ZB4BA0  
page 26

Flush push  
with set of 6 caps  
ZB4BA9  
page 26

Flush push  
ZB4BA●  
page 26

Flush push for  
insertion of legend  
ZB4BA●8  
page 26



Projecting push  
ZB4BL●  
page 26

Recessed push  
ZB4BA●6  
page 27

Booted flush/  
projecting push  
ZB4BP●/BP●S  
page 27

Booted flush push  
for insertion of legend  
ZB4BP●8  
page 27



Flush push  
ZB4BA●3●/BA●4●  
ZB4BA334/335  
page 28

Projecting push  
ZB4BL●3●  
page 28



Double-headed push  
buttons  
ZB4BA7●●●  
ZB4BA79  
ZB4BL734●  
page 32

Triple-headed push buttons  
ZB4BA7313●  
ZB4BA711●●  
ZB4BA72124  
ZB4BA791  
page 33

# Harmony™ XB4 metal 22 mm push buttons

Push buttons, switches and pilot lights:  
sub-assemblies, ZB4B

**Non-illuminated units  
for user assembly  
(continued)**

**Contact functions**

For mushroom head push buttons

Body sub-assemblies

Head sub-assemblies, chromium plated or black metal bezel

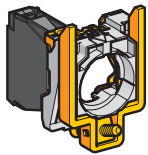

Screw clamp terminals  
ZB4BZ10●/BZ141  
page 48

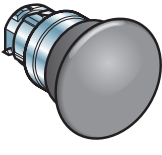

● ● ● ● ● ● ● ● ● ●  
Ø 30  
Ø 40  
Ø 60

Spring return  
ZB4BC●/BR●  
see page 34

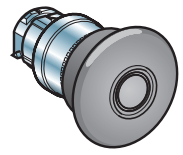

● ● ● ● ● ● ● ● ● ●  
Ø 30  
Ø 40  
Ø 60

Latching  
ZB4B●2/BS●2/BS55  
see page 35

For Emergency Stop or  
Emergency switching off  
mushroom head push buttons

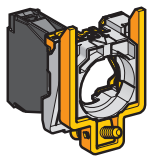

Faston®  
ZB4BZ10●3  
page 52

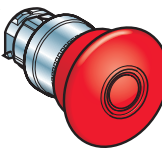

● ● ● ● ● ● ● ● ● ●  
Ø 30  
Ø 40  
Ø 60

Push-pull (EN/ISO 13850: 2006)  
ZB4BT84  
see page 36

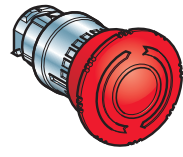

● ● ● ● ● ● ● ● ● ●  
Ø 30  
Ø 40  
Ø 60

Turn to release (EN/ISO 13850: 2006)  
ZB4BS8●4  
see page 36

Emergency stop trigger  
action and mechanical  
latching

Emergency switching off  
mechanical latching

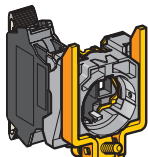

Spring clamp terminals  
ZBE 10●5  
ZB4BZ10●5  
page 50

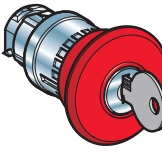

● ● ● ● ● ● ● ● ● ●  
Ø 30  
Ø 40  
Ø 60

Key release (EN/ISO 13850: 2006)  
ZB4BS9●4  
see page 36

Key release (IEC 60364-5-3)  
ZB4BS74/BS14/BS24  
see page 37

Emergency stop trigger  
action and mechanical  
latching

Emergency switching off  
mechanical latching

For selector switches  
and key switches

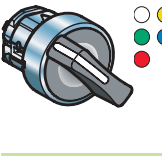

Standard black handle (1)  
ZB4BD●  
page 38

Long black handle (1)  
ZB4BJ●  
page 39

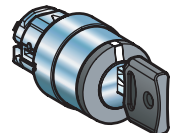
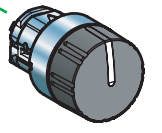
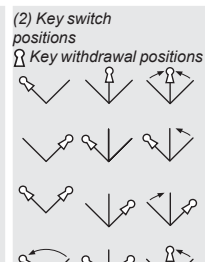
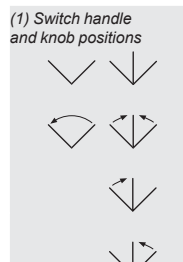

Knurled black knob (1)  
ZB4BD●9  
page 41

Key switch (2)  
ZB4BG●●/  
BG●TEC10  
page 40

For toggle switches

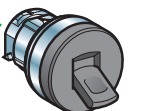

2-position lever (3)  
ZB4BD●8, see page 41

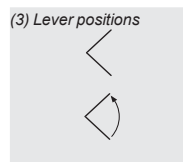

# Harmony™ XB4 metal 22 mm push buttons

Push buttons, switches and pilot lights:  
sub-assemblies, ZB4B

**Pilot lights  
for user assembly**

**Signaling functions**

**Body sub-assemblies  
with integral LED**

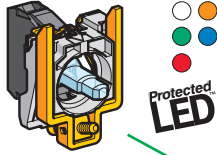

Connection: screw  
clamp terminals  
**ZB4BVJ/BVB/BVG/  
BVM**  
see page 56

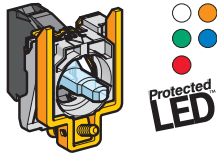

Connection: plug-in  
connector  
**ZB4VB●4/BVG●4/  
BVM●4**  
please consult your  
Regional Sales Office

**Head sub-assemblies**



With lens fitted  
**ZB4BV0●3**  
see page 44

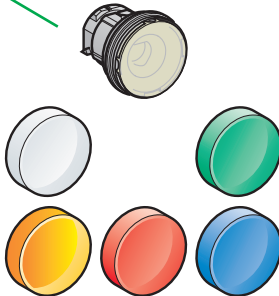

With 5 separate lenses, not fitted  
**ZB4BV003**  
see page 44

**Body sub-assemblies  
for BA 9s bulb**



Direct supply  
Connection: screw  
clamp terminals  
**ZB4BV6**  
see page 59

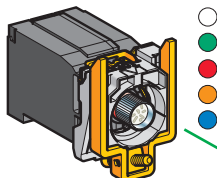

Via integral transformer  
Connection: screw clamp  
terminals  
**ZB4BV●D●**  
see page 59

**Head sub-assemblies**



With lens fitted  
**ZB4BV0●, ZB4BV0●S**  
see page 45



# Harmony™ XB4 metal 22 mm push buttons

Push buttons, switches and pilot lights:  
sub-assemblies, ZB4B

## Illuminated push buttons for user assembly

For illuminated push buttons, spring return

### Body sub-assemblies with integral LED

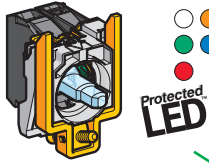

Screw clamp terminals  
ZB4BW0B/BW0G/  
BW0M  
page 54

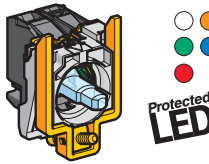

Plug-in connector  
ZB4BW0B●●4  
please consult your  
Regional Sales Office

For illuminated double-headed push buttons, spring return

For illuminated "push-push to release" push buttons and illuminated selector switches with standard handle

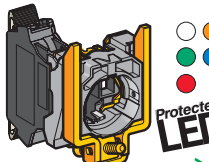

Spring clamp terminals  
ZBV●●●  
page 50

For illuminated mushroom head push buttons

For illuminated push buttons, spring return

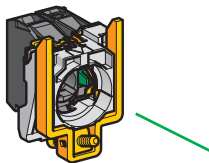

Direct supply or via  
integral transformer  
Screw clamp terminals  
ZB4BW0●●●  
page 58

## Combined functions (contact + signaling)

### Head sub-assemblies, chromium plated or black metal bezel

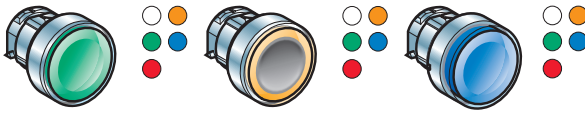

Flush push ZB4BW3●3 page 30	Flush push with illuminated ring ZB4BW9●3 page 30	Flush push for insertion of legend ZB4BA●8 page 30
-----------------------------------	---	--

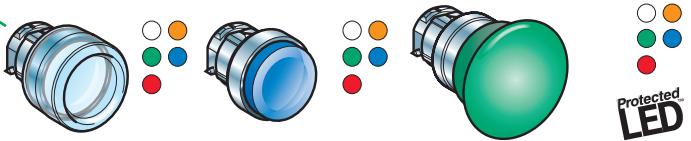

Booted flush push ZB4BW5●3 page 30	Projecting push ZB4BW1●3, ZB4BW1●3S page 30	Mushroom head, spring return ZB4BW4●3 page 34
--	--	---



Double-headed (flush/flush push) + central pilot light  
Double-headed (flush/projecting push) + central pilot light  
ZB4BW7A17●● / ZB4BW7A374● / ZB4BW7A9, see page 32  
ZB4BW7L374●, see page 32

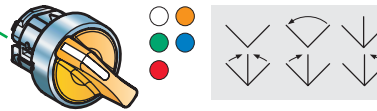

Selector switches with standard handle  
ZB4BK1●●3  
see page 42



Mushroom head, latching ZB4BW6●3 see page 35	Emergency switching off, mechanical latching, push-pull ZB4BW643 see page 37
--	--

### Body sub-assemblies for BA 9s bulb

### Head sub-assemblies, chromium plated or black metal bezel



Flush push ZB4BW3●, ZB4BW3●S page 31	Projecting push ZB4BW1●, ZB4BW1●S page 31
---	--

# Harmony™ XB4 metal 22 mm push buttons

Push buttons, switches and pilot lights

Environment			
Protective treatment standard version			"TH" treatment
Ambient air temperature around the device	Storage	°C	- 40 to + 70
	Operation	°C	- 25 to + 70: LED and neon bulb versions - 25 to + 55: incandescent bulb version
Electric shock protection	Conforming to IEC 61140		Class I
Degree of protection	Conforming to IEC 60529		IP 66 IP 69 K (Selector switches and multiple-headed push buttons)
	Conforming to NEMA		NEMA type 4X and 13, unless otherwise stated
Resistance to high pressure washer		Pa	70 x 10 <sup>5</sup> (70 bar); distance: 0.1 m Temperature: 55°C
Mechanical shock protection	Conforming to IEC 50102		Non-illuminated heads: IK 03 Illuminated heads: IK 05 Selector switch heads: IK 06
Conforming to standards			EN/IEC 60947-1, EN/IEC 60947-5-1, EN/IEC 60947-5-4, EN/IEC 60947-5-5, EN/IEC60204-1 and EN/ISO 13850:2006 (Emergency stop trigger action and mechanical latching push buttons, see page 36063/2), IEC60364-5-53 (Emergency switching off mechanical latching push buttons, see page 36063/3) JIS C4520, UL 508, CSA C22-2 no. 14
Product certifications	UL Listed, CSA		Standard single contacts with screw clamp and spring terminals: A600; Q600 Double contacts with screw clamp terminals: A600; Q600 Light blocks with screw clamp terminals Joystick controllers XD4PA/ZD4PA: A600; R300 Special contact blocks: □ ZBE201: A300; Q300 □ ZBE202: A600; Q600 Single contacts for high power switching: □ ZBE501 and ZBE 502: A300; P300
	UL Recognized, CSA		Standard single contacts for plug-in connector: A300; R300 Standard contacts for printed circuit board: B300; R300
	BV, RINA, LROS, DNV, GL		Standard single contacts and double contacts with screw clamp or spring terminals:
Terminal referencing	Conforming to EN 50005 and EN 50013		

## Specifications of contact or combined contact and signaling functions (see page 24)

Mechanical specifications			
Contact operation	N/C or N/O		Slow break
Positive operation	Conforming to EN/IEC 60947-5-1 appendix K		All functions incorporating a N/C contact have positive opening operation
Operating travel (to change the electrical state)	Push button	mm	Changing N/C state: 1.5 Changing N/O state: 2.6 Total travel: 4.3
Operating force	Push button	N	Changing N/C state: 3.5 Changing N/O state: 3.8
	Additional contact only (extra to change state)	N	Single N/C contact: 2 Single N/O contact: 2.3
		N	Double N/C contact: 3.4 Double N/O contact: 5 Double contact N/C + N/O: 4.6
Emergency stop or Emergency switching off with N/C + N/O		N	Standard push-pull: 45 Trigger action push-pull: 50
		N	Standard turn to release and key release: 40 Trigger action turn to release and key release, "trigger action": 44

# Harmony™ XB4 metal 22 mm push buttons

Push buttons, switches and pilot lights

Specifications of contact or combined contact and signaling functions (continued) (see page 24)			
<b>Operating torque</b> (to change the electrical state)	Selector switches	<b>N.m</b>	N/O contact: 0.14
	Additional contact only	<b>N.m</b>	N/O contact: 0.05
<b>Mechanical durability</b> (in millions of operating cycles)	Push button	Spring return	5
		Multiple-headed	1
		Push-push to release	0.5
	Selector switch	Non-illuminated	1
		Illuminated	0.5
	Toggle switch		0.5
	Emergency Stop or Emergency switching off push button		0.3 with 3 contacts
	Joystick controller		1
	Standard contact block only		5
	Low power switching contact block only (dust protected)		0.5
<b>Vibration resistance</b>	Conforming to IEC 60068-2-6		Frequency: 2 to 500 Hz: 5 gn
<b>Mechanical shock resistance</b>	Conforming to IEC 60068-2-27		All functions except mushroom head push buttons, spring return: <input type="checkbox"/> half sine wave acceleration 11 ms: 50 gn <input type="checkbox"/> half sine wave acceleration 18 ms: 30 gn Mushroom head push button, spring return: <input type="checkbox"/> half sine wave acceleration 11 ms: 10 gn
<b>Electrical specifications</b>			
<b>Cabling capacity</b>	Conforming to EN/IEC 60947-1	<b>mm<sup>2</sup></b>	Standard block with screw clamp or spring terminals: Min: 1 x 0.22 without cable end Max: 2 x 1.5 with cable end Cross headed screws (Pozidriv or Philips type 1), slotted for flat 4 and 5.5 mm screwdriver Tightening torque: 0.8 N.m (maxi 1.2 N.m)  Contact blocks for high power switching: Min: 1 x 0.5 without cable end Max: 2 x 2.5 with or without cable end
<b>Contact material</b>	Silver alloy (Ag / Ni)		Standard single and double blocks with screw clamp or spring terminals Blocks for plug-in connector Standard blocks for printed circuit board connection
	Gold flashed (Ag / Ni / Au)		Low power switching contact blocks with screw clamp terminals Low power switching contact blocks for printed circuit board connection
<b>Short-circuit protection</b>	Conforming to EN/IEC 60947-5-1d	<b>A</b>	Standard single and double blocks with screw clamp or spring terminals: 10 (gG cartridge fuse conforming to IEC 60269-1) Blocks for plug-in connector: 4 (gG cartridge fuse conforming to IEC 60269-1) Standard blocks for printed circuit board connection: 4 (gG cartridge fuse conforming to IEC 60269-1)
<b>Rated thermal current</b>	Conforming to EN/IEC 60947-5-1	<b>A</b>	Standard single and double blocks with screw clamp or spring terminals: 10 Blocks for plug-in connector: 10 Standard blocks for printed circuit board connection: 6
<b>Rated insulation voltage</b>	Conforming to EN/IEC 60947-1	<b>V</b>	Standard single and double blocks with screw clamp or spring terminals: Ui = 600, degree of pollution 3 Blocks for plug-in connector or Faston® connectors: Standard blocks for printed circuit board connection Contact blocks for high-power switching: Ui = 250, degree of pollution 3
<b>Rated impulse withstand voltage</b>	Conforming to IEC 60947-1	<b>kV</b>	Standard single and double blocks with screw clamp or spring terminals: Uimp = 6 Blocks for plug-in connector Standard blocks for printed circuit board connection Contact blocks for high-power switching applications: Uimp = 4

# Harmony™ XB4 metal 22 mm push buttons

Push buttons, switches and pilot lights

**Specifications of contact or combined contact and signaling functions (continued) (see page 24)**

**Electrical specifications (continued)**

<b>Rated operational specifications</b> Conforming to EN/IEC 60947-5-1		a.c. supply: utilization category AC-15		<p><b>Standard single and double blocks with screw clamp or spring terminals:</b> A600: Ue = 600 V and Ie = 1.2 A or Ue = 240 V and Ie = 3 A or Ue = 120 V and Ie = 6 A</p> <p><b>Blocks for plug-in connector:</b> A300: Ue = 120 V and Ie = 6 A or Ue = 240 V and Ie = 3 A</p> <p><b>Standard blocks for printed circuit board connection:</b> B300: Ue = 120 V and Ie = 3 A or Ue = 240 V and Ie = 1.5 A</p> <p><b>Special contact blocks:</b></p> <ul style="list-style-type: none"> <li>□ ZBE201: A300: Ue = 240 V and Ie = 3 A or Ue = 120 V and Ie = 6 A (with insulation voltage Ui = 500 V)</li> <li>□ ZBE202: A600: Ue = 600 V and Ie = 1.2 A or Ue = 240 V and Ie = 3 A or Ue = 120 V and Ie = 6 A</li> </ul> <p><b>Contact blocks for high power switching:</b></p> <ul style="list-style-type: none"> <li>□ ZBE50●: A300: Ue = 240 V and Ie = 3 A or Ue = 120 V and Ie = 6 A</li> </ul>
		d.c. supply: utilization category DC-13		<p><b>Standard single and double blocks with screw clamp or spring terminals</b> Q600: Ue = 600 V and Ie = 0.1 A or Ue = 250 V and Ie = 0.27 A or Ue = 125 V and Ie = 0.55 A</p> <p><b>Joystick controllers XD4PA/ZD4PA:</b> R300: Ue = 125 V and Ie = 0.22 A or Ue = 250 V and Ie = 0.1 A</p> <p><b>Blocks for plug-in connector:</b> R300: Ue = 125 V and Ie = 0.22 A or Ue = 250 V and Ie = 0.1 A</p> <p><b>Standard blocks for printed circuit board connection:</b> R300: Ue = 125 V and Ie = 0.22 A or Ue = 250 V and Ie = 0.1 A</p> <p><b>Special contact blocks:</b></p> <ul style="list-style-type: none"> <li>□ ZBE201: Q300; Ue = 125 V and Ie = 0.55 A or Ue = 250 V and Ie = 0.27 A</li> <li>□ ZBE202: Q600; Ue = 600 V and Ie = 0.1 A or Ue = 250 V and Ie = 0.27 A or Ue = 125 V and Ie = 0.55 A</li> </ul> <p><b>Contact block for high power switching:</b></p> <ul style="list-style-type: none"> <li>□ ZBE50●: P300: Ue = 125 V and Ie = 1.1 A or Ue = 250 V and Ie = 0.55 A</li> </ul>
<b>Specifications of special contact blocks</b>	Low power switching		<b>VA</b>	P max: 12
			<b>A</b>	I max: 0.1
			<b>V</b>	U max: 24
	High power switching Conforming to IEC/EN 60947-5-1	100 000 operating cycles Load factor: 0.5 Operating rate: 900 cycles/hour	<b>VA</b>	P max: 240
			<b>A</b>	I max: 10
			<b>V</b>	U: 24 ---
<b>Electrical durability</b> Conforming to EN/IEC 60947-5-1 appendix C Operating rate 3600 operating cycles/hour Load factor: 0.5	a.c. supply for 1 million operating cycles utilization category AC-15		<b>V</b>	Standard single blocks with screw clamp or spring terminals:
				24
	<b>A</b>	4	3	2
		Standard double blocks with screw clamp terminals and blocks for plug-in connector:	<b>V</b>	24
<b>A</b>	3			1.5
d.c. supply for 1 million operating cycles utilization category DC-13	Standard single blocks with screw clamp or spring terminals:	<b>V</b>	24	110
			<b>A</b>	0.5
	Standard double blocks with screw clamp terminals and blocks four plug-in connector:	<b>V</b>	24	110
			<b>A</b>	0.4
<b>Electrical reliability</b> Failure rate Conforming to EN/IEC 60947-5-4	In clean environment			<p>Standard blocks:</p> <ul style="list-style-type: none"> <li>- at 17 V and 5 mA, <math>\lambda &lt; 10^{-8}</math></li> <li>- at 5 V and 1 mA, <math>\lambda &lt; 10^{-6}</math></li> </ul> <p>Special blocks with gold flashed contacts for low power switching:</p> <ul style="list-style-type: none"> <li>- at 5 V and 1 mA, <math>\lambda &lt; 10^{-7}</math></li> </ul>
	In dusty environment			<p>Special blocks with gold flashed contacts and dust protection for low power switching only:</p> <ul style="list-style-type: none"> <li>- at 5 V and 1 mA, <math>\lambda &lt; 10^{-7}</math></li> </ul>



# Harmony™ XB4 metal 22 mm push buttons

Push buttons, switches and pilot lights

## Specifications of illuminated units (pilot lights)

Mechanical specifications			
Vibration resistance	Conforming to IEC 60068-2-6		Frequency: 12 to 500 Hz: 5 gn
Electric shock resistance	Conforming to IEC 60068-2-27		Half sine wave acceleration 11 ms: 50 gn Half sine wave acceleration 18 ms: 30 gn
Electrical specifications			
Cabling capacity	Conforming to EN/IEC 60947-1	mm <sup>2</sup>	Screw clamp and spring terminals Min: 1 x 0.22 without cable end (1 x 0.34 for linking) Max: 2 x 1.5 with cable end
Rated insulation voltage	Conforming to EN/IEC 60947-1	V	Direct supply pilot light blocks (BA 9s bulb): U <sub>i</sub> = 250, degree of pollution 3 Pilot light blocks with integral LED: U <sub>i</sub> = 250, degree of pollution 3 Pilot light blocks with transformer: U <sub>i</sub> = 600, degree of pollution 3
Rated impulse withstand voltage	Conforming to EN/IEC 60947-1	kV	Direct supply pilot light blocks (BA 9s bulb): U <sub>imp</sub> = 4 Pilot light blocks with integral LED: U <sub>imp</sub> = 4 Pilot light blocks with transformer: U <sub>imp</sub> = 6

## Specific specifications of single light blocks with integral LED

Voltage limits	For rated voltage	V	12 V: 10 to 15 ~; 10.2 to 13.8 ~ 24 V: 19.2 to 30 ~; 21.6 to 26.4 ~ 24 to 120 V: 19.2 to 132 ~; 21.6 to 132 ~ 48 to 120 V: 40 to 132 ~ 230/240 V: 195 to 264 ~
Current consumption	Applicable to all colors	mA	Blocks with ~ 12 V supply: 18 Blocks with ~ 24 V supply: 18 Blocks with ~ 120 V supply: 14 Blocks with ~ 240 V supply: 14
Service life	At rated voltage and at an ambient temperature of 25 °C	H	100 000
Surge withstand	Conforming to IEC 61000-4-5	kV	1
Resistance to fast transients	Conforming to IEC 61000-4-4	kV	2
Resistance to electromagnetic fields	Conforming to IEC 61000-4-3	V/m	10
Resistance to electrostatic discharges	Conforming to IEC 61000-2-6	kV	8: in free air, in insulating parts 6: on contact, on metal parts
Direct parallel connection across inductive load e.g.: contactor coil or solenoid	Maximum power of load	VA	For high power applications (≥ 30 VA), a ZBV● LED suppressor must be connected across the light block terminals (see page 49)
Electromagnetic emission	Conforming to IEC 55011		Class B

## Specific specifications

Body/mounting collar			
Tightening torque of mounting screw		N.m	0.8 (max 1.2)
Hour counters and annunciators			
Voltage limits	Hour counter and annunciator		± 10% of the nominal voltage
Current consumption	Hour counter	mA	XB5DSB: 7 to 15 XB5DSG: 8 XB5DSM: 8
	Annunciator	mA	5

# Harmony™ XB4 metal 22 mm push buttons

Contact mounting - Contact sequence

## Maximum recommended configurations for achieving catalog specifications

Unit type (complete units XB4B, heads ZB4B)	Push buttons, spring return XB4BA●, ZB4BA●, (except ZB4BA●8) XB4BC●, ZB4BC●, XB4BL●, ZB4BL●, XB4BP●, ZB4BP●, ZB4BR● Triple-headed push buttons XB4BA731327, XB4BA711137, ZB4BA7313●, ZB4BA7111●, ZB4BA72124, ZB4BA791	Double-headed push buttons XB4BL73415, ZB4BA712●, ZB4B●734●, ZB4BA79	Illuminated push buttons, spring return XB4BW●, ZB4BW●, ZB4BA●8 Double-headed push buttons + pilot light block XB4BW73731●5, ZB4BW7A17●●, ZB4BW7●374●, ZB4BW7A9	
Solution using single contacts				
Solution using single and double contacts				
Maximum recommended configurations	Single contacts Double contacts + single contacts Light block	9 3 + 3 -	6 2 + 2 -	6 2 + 2 1

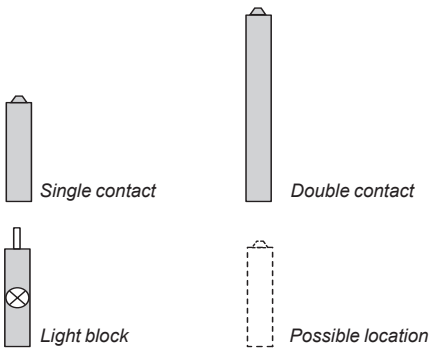

## Possible configurations for high power switching contacts (1) (2)

High power switching contact blocks with screw clamp terminal connections:  
ZBE 501, ZBE 502, ZBE 503, ZBE 504 and ZBE 505  
High power switching contact blocks with connection by Faston® connectors  
ZBE 5013, ZBE 5023, ZBE 5033, ZBE 5043 and ZBE 5053

1 N/O	1 N/C	1 N/O + N/C 1 N/O + N/O 1 N/C + N/C

(1) The configurations are not upgradable and cannot be combined with other types of contact and signaling functions.  
(2) High power switching contacts are not compatible with Harmony triple-headed push buttons.

Emergency stop or Emergency switching off XB4BT●, ZB4BT●, XB4BS●, ZB4BS●		Selector switches ■ Standard handle XB4BD●, ZB4BD●, ■ Long handle XB4BJ●, ZB4BJ●, ■ Knurled knob ZB4BD●9, ■ Key switch XB4BG●, ZB4BG●			Illuminated selector switches, standard handle XB4BK●, ZB4BK●		Toggle switches ZB4BD●8	
4	4	5	4	6	4	6		
2	1	2	1	2	2	3		
+	+	+	+	+	+	+		
0	2	1	2	2	0	0		
-	-	-	-	-	1	-		



### Sequence of contacts fitted to selector switch bodies

Unit type		Selector switches					
		2-position	3-position				
		315°	45°	315°	0°	45°	
Push	Position	Top					
		Bottom					
		Location	L C R	L C R	L C R	L C R	
		State	0 0 0	1 1 1	1 1 0	0 0 0	0 1 1
Contacts		N/O	□ □ □	■ ■ ■	■ ■ □	□ □ □	□ ■ ■
		N/C	■ ■ ■	□ □ □	□ □ ■	■ ■ ■	■ □ □
L left, C center, R right							
□ open, ■ closed							





# Harmony™ XB4 metal 22 mm push buttons



Spring return push buttons, unmarked

Assembly of other products using body/contact assemblies, see page 48; accessories, see pages 60 and 62

Push buttons with flush push <sup>(1)</sup>						
Screw clamp terminal connections (Schneider Electric anti-retightening system)						
Shape of head	Type of push	Type of contact		Color of push	Reference	Weight
						
		N/O	N/C			kg

Complete units						
	Flush	1	-	White	<b>XB4BA11</b> (ZB4BZ101 + ZB4BA1)	0.080
				Black	<b>XB4BA21</b> (ZB4BZ101 + ZB4BA2)	0.080
				Green	<b>XB4BA31</b> (ZB4BZ101 + ZB4BA3)	0.080
				Yellow	<b>XB4BA51</b> (ZB4BZ101 + ZB4BA5)	0.080
				Blue	<b>XB4BA61</b> (ZB4BZ101 + ZB4BA6)	0.080
				Red	<b>XB4BA42</b> (ZB4BZ102 + ZB4BA4)	0.080
-	-	1				

Heads only						
	Without cap <sup>(2)</sup>			-	<b>ZB4BA0</b>	0.028
	Flush, with set of 6 colored caps			6 colors <sup>(3)</sup>	<b>ZB4BA9</b>	0.038
	Flush			White	<b>ZB4BA1</b>	0.029
				Black	<b>ZB4BA2</b>	0.029
				Green	<b>ZB4BA3</b>	0.029
				Red	<b>ZB4BA4</b>	0.029
				Yellow	<b>ZB4BA5</b>	0.029
				Blue	<b>ZB4BA6</b>	0.029
				Grey	<b>ZB4BA8</b>	0.029
	Flush with transparent cap for insertion of legend <sup>(4)</sup>			White	<b>ZB4BA18</b>	0.028
				Green	<b>ZB4BA38</b>	0.028
				Red	<b>ZB4BA48</b>	0.028
				Yellow	<b>ZB4BA58</b>	0.028
				Blue	<b>ZB4BA68</b>	0.028
	Flush (high bezel)			White	<b>ZB4BA14</b>	0.034
				Black	<b>ZB4BA24</b>	0.034
				Green	<b>ZB4BA34</b>	0.034
				Red	<b>ZB4BA44</b>	0.034
				Yellow	<b>ZB4BA54</b>	0.034
				Blue	<b>ZB4BA64</b>	0.034

Push buttons with projecting push <sup>(1)</sup>						
Screw clamp terminal connections (Schneider Electric anti-retightening system)						
Shape of head	Type of push	Type of contact		Color of push	Reference	Weight
						
		N/O	N/C			kg

Complete units						
	Projecting	-	1	Red	<b>XB4BL42</b> (ZB4BZ102 + ZB4BL4)	0.081

Heads only						
	Projecting			White	<b>ZB4BL1</b>	0.030
				Black	<b>ZB4BL2</b>	0.030
				Green	<b>ZB4BL3</b>	0.030
				Red	<b>ZB4BL4</b>	0.030
				Yellow	<b>ZB4BL5</b>	0.030
				Blue	<b>ZB4BL6</b>	0.030

### Heads with black metal bezel

To order, add a figure 7 to the references listed from above.  
 Example: **ZB4BA0** becomes **ZB4BA07**.

(1) Recommended maximum number of contacts constituting the body (mounting collar + contact) associated with the head, see page 24.  
 (2) Colored cap to be ordered separately: see page 60.  
 (3) Head supplied with 6 different colored caps (white, black, green, red, yellow, blue) not fitted.  
 (4) For legend ordering information, see page 64.  
 Note: For contact block and mounting collar ordering information, see pages 48, 50, 51 and 52.



XB4BA31



ZB4BA0



ZB4BA4



ZB4BA38



ZB4BA34

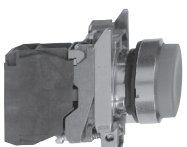

XB4BL42



ZB4BL1



# Harmony™ XB4 metal 22 mm push buttons

Spring return push buttons, unmarked

Assembly of other products using body/contact assemblies, see page 48; accessories, see pages 60 and 62

## Push buttons with recessed push (1)

### High guard



ZB4BA36

Shape of head	Type of push	Color	Reference	Weight kg
	Recessed (high guard)	White	ZB4BA16	0.034
		Black	ZB4BA26	0.034
		Green	ZB4BA36	0.034
		Red	ZB4BA46	0.034
		Yellow	ZB4BA56	0.034
		Blue	ZB4BA66	0.034

## Push buttons with silicone booted head for severe environments (1)

### Screw clamp terminal connections (Schneider Electric anti-retightening system)

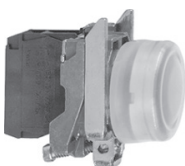

XB4BP21

Shape of head	Type of push	Type of contact	Color of push	Reference	Weight kg	
		N/O				
		N/C				
<b>Complete units</b>						
	Booted, clear silicone (color of push unobscured)	1	–	Black	XB4BP21 (ZB4BZ101 + ZB4BP2)	0.082
		–	–	Green	XB4BP31 (ZB4BZ101 + ZB4BP3)	0.082
		–	–	Yellow	XB4BP51 (ZB4BZ101 + ZB4BP5)	0.082
		–	–	Blue	XB4BP61 (ZB4BZ101 + ZB4BP6)	0.082
		–	1	Red	XB4BP42 (ZB4BZ102 + ZB4BP4)	0.082

## Silicone booted heads only, with increased protection (IP 69K)



ZB4BP18



ZB4BPA4

	Flush	Clear boot (2) For insertion of protected legend within head (3)	White	ZB4BP18	0.034
			Green	ZB4BP38	0.034
			Red	ZB4BP48	0.034
			Yellow	ZB4BP58	0.034
			Blue	ZB4BP68	0.034
	Flush	Clear boot (2)	White	ZB4BPA1	0.034
			Black	ZB4BPA2	0.034
			Green	ZB4BPA3	0.034
			Red	ZB4BPA4	0.034
			Yellow	ZB4BPA5	0.034
			Blue	ZB4BPA6	0.034
	Projecting	Clear boot (2)	White	ZB4BP1	0.031
			Black	ZB4BP2	0.031
			Green	ZB4BP3	0.031
			Red	ZB4BP4	0.031
			Yellow	ZB4BP5	0.031
			Blue	ZB4BP6	0.031

## Silicone booted heads only, standard for mounting with legend holder (IP 66)



ZB4BP2S



ZB4BP183

	Flush	Colored boot (4)	White	ZB4BP1S	0.034
			Black	ZB4BP2S	0.034
			Green	ZB4BP3S	0.034
			Red	ZB4BP4S	0.034
			Yellow	ZB4BP5S	0.034
			Blue	ZB4BP6S	0.034
	Flush	Clear membrane (4) For insertion of protected legend within head (3)	White	ZB4BP183	0.026
			Green	ZB4BP383	0.026
			Red	ZB4BP483	0.026
			Yellow	ZB4BP583	0.026
			Blue	ZB4BP683	0.026

## Heads with black metal bezel

To order, add a figure 7 to the references selected from above.

Example: ZB4BP18 becomes ZB4BP187.

(1) Recommended maximum number of contacts constituting the body (mounting collar + contact) associated with the head, see page 24.

(2) Permissible panel thickness 1 to 5 mm, cannot be used with legend holders.

(3) To order a legend for insertion within the head, see page 62.

(4) Replacement of silicone protection element without dismantling head, see page 61.

Note: For contact block and mounting collar ordering information, see pages 48, 50, 51 and 52.

# Harmony™ XB4 metal 22 mm push buttons Spring return push buttons, with marking

Assembly of other products using body/contact assemblies, see page 48; accessories, see pages 60 and 62

Push buttons with flush or projecting push (1)								
Screw clamp terminal connections (Schneider Electric anti-retightening system)								
Shape of head	Type of push	Type of contact		Marking Text (color)	Color of push	Reference	Weight	
		N/O	N/C					
<b>Complete units</b>								
	Flush	1	–	"I" (white)	Green	<b>XB4BA3311</b> (ZB4BZ101 + ZB4BA331)	0.080	
	Flush	–	1	"O" (white)	Red	<b>XB4BA4322</b> (ZB4BZ102 + ZB4BA432)	0.080	
	Projecting	–	1	"O" (white)	Red	<b>XB4BL4322</b> (ZB4BZ102 + ZB4BL432)	0.080	
	Flush (2)	1	–	↑ (black)	White	<b>XB4BA3341</b> (ZB4BZ101 + ZB4BA334)	0.080	
	Flush (2)	1	–	↓ (white)	Black	<b>XB4BA3351</b> (ZB4BZ101 + ZB4BA335)	0.080	
<b>Heads only</b>								
	Flush			"I" (white)	Green	<b>ZB4BA331</b>	0.029	
				"I" (black)	White	<b>ZB4BA131</b>	0.029	
				"II" (white)	Green	<b>ZB4BA336</b>	0.029	
				"II" (black)	White	<b>ZB4BA136</b>	0.029	
				"START" (white)	Green	<b>ZB4BA333</b>	0.029	
				"START" (black)	White	<b>ZB4BA133</b>	0.029	
				"ON" (white)	Green	<b>ZB4BA341</b>	0.029	
				"ON" (black)	White	<b>ZB4BA141</b>	0.029	
				"MARCHE" (black)	White	<b>ZB4BA142</b>	0.029	
					(white)	Black	<b>ZB4BA245</b>	0.029
					(black)	White	<b>ZB4BA145</b>	0.029
				"O" (white)	Red	<b>ZB4BA432</b>	0.029	
						Black	<b>ZB4BA232</b>	0.029
				"STOP" (white)	Red	<b>ZB4BA434</b>	0.029	
						Black	<b>ZB4BA234</b>	0.029
				"OFF" (white)	Red	<b>ZB4BA435</b>	0.029	
						Black	<b>ZB4BA235</b>	0.029
				↑ (black) (2)	White	<b>ZB4BA334</b>	0.029	
				↓ (white) (2)	Black	<b>ZB4BA335</b>	0.029	
			Projecting			"O" (white)	Red	<b>ZB4BL432</b>
					Black	<b>ZB4BL232</b>	0.030	
				"STOP" (white)	Red	<b>ZB4BL434</b>	0.030	
					Black	<b>ZB4BL234</b>	0.030	
				"OFF" (white)	Red	<b>ZB4BL435</b>	0.030	
					Black	<b>ZB4BL235</b>	0.030	



XB4BA4322



ZB4BA331



ZB4BA334



ZB4BL432

### Heads with black metal bezel



To order, add a figure 7 to the references selected from above.  
Example: **ZB4BA331** becomes **ZB4BA3317**.

(1) Recommended maximum number of contacts constituting the body (mounting collar + contact) associated with the head, see page 24.  
(2) Product supplied with cap not clipped-in, allowing orientation through 360° in 90° steps.  
Note: For contact block and mounting collar ordering information, see pages 48, 50, 51 and 52.

# Harmony™ XB4 metal 22 mm push buttons

Illuminated push buttons, spring return,  
with integral LED

Assembly of other products using body/contact assemblies: see page 48; combined sub-assemblies, see page 52; accessories, see page 62

Illuminated push buttons with flush push <sup>(1)</sup>							
Screw clamp terminal connections (Schneider Electric anti-retightening system)							
Shape of head	Description	Type of contact		Supply voltage	Color of push	Reference	Weight
				V			kg
		N/O	N/C				

**Complete units - With plain lens**

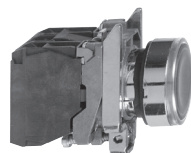

XB4BW33B5

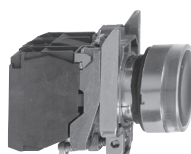

XB4BW34G5

Shape of head	Description	Type of contact	Type of contact	Supply voltage	Color of push	Reference	Weight
	Integral LED	1	1	~ 24 50/60 Hz	White	<b>XB4BW31B5</b> (ZB4BW0B15 + ZB4BW313)	0.097
					Green	<b>XB4BW31B5</b> (ZB4BW0B35 + ZB4BW333)	0.097
					Red	<b>XB4BW31B5</b> (ZB4BW0B45 + ZB4BW343)	0.097
					Orange	<b>XB4BW35B5</b> (ZB4BW0B55 + ZB4BW353)	0.097
					Blue	<b>XB4BW36B5</b> (ZB4BW0B65 + ZB4BW363)	0.097
					~ 110 to 120 50/60 Hz	White	<b>XB4BW31G5</b> (ZB4BW0G15 + ZB4BW313)
				Green	<b>XB4BW33G5</b> (ZB4BW0G35 + ZB4BW333)	0.097	
				Red	<b>XB4BW34G5</b> (ZB4BW0G45 + ZB4BW343)	0.097	
				Orange	<b>XB4BW35G5</b> (ZB4BW0G55 + ZB4BW353)	0.097	
				Blue	<b>XB4BW36G5</b> (ZB4BW0G65 + ZB4BW363)	0.097	
				~ 230 to 240 50/60 Hz	White	<b>XB4BW31M5</b> (ZB4BW0M15 + ZB4BW313)	0.097
				Green	<b>XB4BW33M5</b> (ZB4BW0M35 + ZB4BW333)	0.097	
				Red	<b>XB4BW34M5</b> (ZB4BW0M45 + ZB4BW343)	0.097	
				Orange	<b>XB4BW35M5</b> (ZB4BW0M55 + ZB4BW353)	0.097	
				Blue	<b>XB4BW36M5</b> (ZB4BW0M65 + ZB4BW363)	0.097	

(1) Recommended maximum number of contacts constituting the body (mounting collar + contact) associated with the head, see page 24.  
Note: Refer to page 13 for Push-To-Test Pilot Light and Remote Test Pilot Light wiring diagrams.

# Harmony™ XB4 metal 22 mm push buttons

Illuminated push buttons, spring return,  
with integral LED

Assembly of other products using combined sub-assemblies, see page 52; accessories, see page 24



## Illuminated push buttons with flush push (1)

Shape of head	Type of push	Color	Reference	Weight kg
<b>Heads only (2) - With plain lens</b>				
 Protected LED	Flush	White	ZB4BW313	0.026
		Green	ZB4BW333	0.026
		Red	ZB4BW343	0.026
		Orange	ZB4BW353	0.026
		Blue	ZB4BW363	0.026
 Protected LED	Flush with illuminated ring	White	ZB4BW913	0.026
		Green	ZB4BW933	0.026
		Red	ZB4BW943	0.026
		Orange	ZB4BW953	0.026
		Blue	ZB4BW963	0.026
 Protected LED	Flush with clear boot	White	ZB4BW513	0.031
		Green	ZB4BW533	0.031
		Red	ZB4BW543	0.031
		Orange	ZB4BW553	0.031
		Blue	ZB4BW563	0.031
 Protected LED	Flush for insertion of legend (3)	White	ZB4BA18	0.028
		Green	ZB4BA38	0.028
		Red	ZB4BA48	0.028
		Orange	ZB4BA58	0.028
		Blue	ZB4BA68	0.028

## Heads only (2) - With grooved lens (4)

 Protected LED	Flush	White	ZB4BW313S	0.026
		Green	ZB4BW333S	0.026
		Red	ZB4BW343S	0.026
		Orange	ZB4BW353S	0.026
		Blue	ZB4BW363S	0.026

## Illuminated push buttons with projecting push (1)

Shape of head	Type of push	Color	Reference	Weight kg
<b>Heads only (2) - With plain lens</b>				
 Protected LED	Projecting	White	ZB4BW113	0.029
		Green	ZB4BW133	0.029
		Red	ZB4BW143	0.029
		Orange	ZB4BW153	0.029
		Blue	ZB4BW163	0.029
 Protected LED	Projecting	White	ZB4BW113S	0.026
		Green	ZB4BW133S	0.026
		Red	ZB4BW143S	0.026
		Orange	ZB4BW153S	0.026
		Blue	ZB4BW163S	0.026

## Heads with black metal bezel

To order, add a figure 7 to the references selected from above.

Example: ZB4BW313 becomes ZB4BW3137.

Example 2: ZB4BW313S becomes ZB4BW313S7.

(1) Recommended maximum number of contacts constituting the body (mounting collar + contact) associated with the head, see page 24.

(2) Only for use with bodies comprised of a light source with integral LED.

(3) For legend ordering information, see page 62.

(4) For use in bright ambient light conditions (outdoors in sunlight, for example).

Note: For contact block and mounting collar ordering information, see pages 48, 50, 51 and 52.

For light module ordering information, see pages 49, 50 and 51.

# Harmony™ XB4 metal 22 mm push buttons

Illuminated push buttons, spring return,  
with BA 9s base fitting

Assembly of other products using combined sub-assemblies, see page 54; accessories, see page 24

Illuminated push buttons with flush push <sup>(1)</sup>							
Screw clamp terminal connections (Schneider Electric anti-retightening system)							
Shape of head	Description	Type of contact		Supply voltage	Color of push	Reference	Weight
		N/O	N/C				
							kg

### Complete units - With plain lens

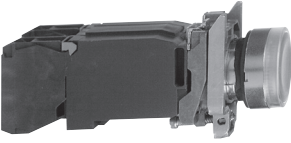
	Direct supply for bulb with BA 9s base fitting, 2.4 W max (bulb not included)	1	1	≤ 250	White	<b>XB4BW3165</b> (ZB4BW065 + ZB4BW31)	0.097	
					Green	<b>XB4BW3365</b> (ZB4BW065 + ZB4BW33)	0.097	
					Red	<b>XB4BW3465</b> (ZB4BW065 + ZB4BW34)	0.097	
					Orange	<b>XB4BW3565</b> (ZB4BW065 + ZB4BW35)	0.097	
	Via integral transformer 1.2 VA, 6 V secondary, incandescent bulb with BA 9s base fitting (bulb included)	1	1	~110 to 120 50/60 Hz	White	<b>XB4BW3135</b> (ZB4BW035 + ZB4BW31)	0.169	
					Green	<b>XB4BW3335</b> (ZB4BW035 + ZB4BW33)	0.169	
					Red	<b>XB4BW3435</b> (ZB4BW035 + ZB4BW34)	0.169	
					Orange	<b>XB4BW3535</b> (ZB4BW035 + ZB4BW35)	0.169	
					~ 230 50 Hz ~220 to 240 60 Hz	White	<b>XB4BW3145</b> (ZB4BW045 + ZB4BW31)	0.170
						Green	<b>XB4BW3345</b> (ZB4BW045 + ZB4BW33)	0.170
						Red	<b>XB4BW3445</b> (ZB4BW045 + ZB4BW34)	0.170
						Orange	<b>XB4BW3545</b> (ZB4BW045 + ZB4BW35)	0.170

XB4BW3545

### Heads only <sup>(2)</sup> - With plain lens

	Flush	White	<b>ZB4BW31</b>	0.027
		Green	<b>ZB4BW33</b>	0.027
		Red	<b>ZB4BW34</b>	0.027
		Orange	<b>ZB4BW35</b>	0.027
		Blue	<b>ZB4BW36</b>	0.027
		Clear	<b>ZB4BW37</b>	0.027

ZB4BW33

### Heads only <sup>(2)</sup> - With grooved lens <sup>(3)</sup>

	Flush	White	<b>ZB4BW31S</b>	0.027
		Green	<b>ZB4BW33S</b>	0.027
		Red	<b>ZB4BW34S</b>	0.027
		Orange	<b>ZB4BW35S</b>	0.027
		Blue	<b>ZB4BW36S</b>	0.027
		Clear	<b>ZB4BW37S</b>	0.027

### Illuminated push buttons with projecting push <sup>(1)</sup>

#### Heads only <sup>(2)</sup> - With plain lens

	Projecting	White	<b>ZB4BW11</b>	0.028
		Green	<b>ZB4BW13</b>	0.028
		Red	<b>ZB4BW14</b>	0.028
		Orange	<b>ZB4BW15</b>	0.028
		Blue	<b>ZB4BW16</b>	0.028
		Clear	<b>ZB4BW17</b>	0.028

ZB4BW14

#### Heads only <sup>(2)</sup> - With grooved lens <sup>(3)</sup>

	Projecting	White	<b>ZB4BW11S</b>	0.027
		Green	<b>ZB4BW13S</b>	0.027
		Red	<b>ZB4BW14S</b>	0.027
		Orange	<b>ZB4BW15S</b>	0.027
		Blue	<b>ZB4BW16S</b>	0.027
		Clear	<b>ZB4BW17S</b>	0.027

### Heads with black metal bezel

To order, add a figure 7 to the references selected from above.

Example: **ZB4BW31** becomes **ZB4BW317**. Example 2: **ZB4BW31S** becomes **ZB4BW31S7**.

<sup>(1)</sup> Recommended maximum number of contacts constituting the body (mounting collar + contact) associated with the head, see page 24

<sup>(2)</sup> Only for use with bodies comprised of a light source with BA9s base fitting bulb (incandescent, neon or LED).

<sup>(3)</sup> For use in bright ambient light conditions (outdoors in sunlight, for example).

Note: For contact block and mounting collar ordering information, see pages 48, 50, 51 and 52.

For light module ordering information, see pages 49, 50 and 51.



# Harmony™ XB4 metal 22 mm push buttons Multiple head push buttons, spring return

User assembly of other units, using body-contact assemblies, see page 48; combined sub-assemblies, see page 54



ZB4BL73415



ZB4BA7121



ZB4BL7341



ZB4BW73731•5



ZB4BW7A1721



ZB4BW7A3741

Double-headed push buttons (1)						
Screw clamp terminal connections (Schneider Electric anti-retightening system)						
Shape of head	Description	Type of contact		Color and marking of caps (2)	Reference	Weight
						kg
		N/O	N/C			
<b>Complete units</b>						
	2 pushes (1 flush black + 1 projecting red)	1	1	White "1" on green background White "0" on red background	<b>ZB4BL73415</b>	0.116
<b>Heads only</b>						
	2 flush black pushes			White background + black background, unmarked	<b>ZB4BA7120</b>	0.056
				Black "1" on white background White "0" on black background	<b>ZB4BA7121</b>	0.056
				Green background + red background, unmarked	<b>ZB4BA7340</b>	0.056
				White "1" on green background White "0" on red background	<b>ZB4BA7341</b>	0.056
				Without cap (3)	<b>ZB4BA79</b>	0.056
	1 flush black push 1 projecting red push			Green background + red background, unmarked	<b>ZB4BL7340</b>	0.056
				White "1" on green background White "0" on red background	<b>ZB4BL7341</b>	0.056

Double-headed push buttons + 1 white central pilot light block (1)						
Screw clamp terminal connections (Schneider Electric anti-retightening system)						
Shape of head	Description	Type of contact		Color and marking of caps (2)	Pilot light voltage	Weight
					V	kg
		N/O	N/C			
<b>Complete units</b>						
	1 flush black push 1 projecting red push 1 white central pilot light block	1	1	White "1" on green background White "0" on red background	24	<b>ZB4BW73731B5</b> 0.130
					120	<b>ZB4BW73731G5</b> 0.130
					240	<b>ZB4BW73731M5</b> 0.130
<b>Heads only (5)</b>						
	2 flush black pushes 1 clear central pilot light (4)			White background + black background, unmarked		<b>ZB4BW7A1720</b> 0.056
				Black "1" on white background White "0" on black background		<b>ZB4BW7A1721</b> 0.056
				Green background + red background, unmarked		<b>ZB4BW7A3740</b> 0.056
				White "1" on green background White "0" on red background		<b>ZB4BW7A3741</b> 0.056
				Black "↑" on white background White "↓" on black background		<b>ZB4BW7A1724</b> 0.056
				Black "+" on white background Black "-" on white background		<b>ZB4BW7A1715</b> 0.056
				Without cap (3)		<b>ZB4BW7A9</b> 0.056
	1 flush black push 1 projecting red push 1 clear central pilot light (4)			Green background + red background, unmarked		<b>ZB4BW7L3740</b> 0.056
				White "1" on green background White "0" on red background		<b>ZB4BW7L3741</b> 0.056

### Heads with black metal bezel

To order, add the suffix 7 to the references selected above. Example: **ZB4BA7120** becomes **ZB4BA71207**.

(1) Recommended maximum number of contacts constituting the body (mounting collar + contact) associated with the head, see page 24.  
 (2) These caps are fitted by Schneider Electric and cannot be removed (risk of damage).  
 (3) Caps to be ordered separately: see page 33.  
 (4) Color of centrally positioned pilot light determined by the color of the LED incorporated in the body sub-assembly.  
 (5) Only for use with bodies comprised of a light source with integral LED.  
 Note: For contact block and mounting collar ordering information, see pages 48, 50, 51 and 52.  
 For light module ordering information, see pages 49, 50 and 51.

# Harmony™ XB4 metal 22 mm push buttons Multiple head push buttons, spring return

User assembly of other units, using body-contact assemblies, see page 48; combined sub-assemblies, see page 54

Triple-headed push buttons (1) (2)							
Screw clamp terminal connections (Schneider Electric anti-retightening system)							
Shape of head	Description	Type of contact			Color and marking of caps (3)	Reference	Weight
							kg
		N/O	N/C	N/O			

Complete units							
	2 flush black pushes + 1 central projecting red push marked "Stop" in white	1	1	1	White "I" on green background White "II" on green background	<b>XB4BA731327</b>	0.128
					Black "→" on white background White "←" on black background	<b>XB4BA711237</b>	0.128

Heads only							
	2 flush black pushes + 1 central projecting red push marked "Stop" in white				White "I" on green background White "II" on green background	<b>ZB4BA73132</b>	0.056
					White "←" on green background White "→" on green background	<b>ZB4BA73133</b>	0.056
					White "↑" on green background White "↓" on green background	<b>ZB4BA73134</b>	0.056
					White "+" on green background White "-" on green background	<b>ZB4BA73135</b>	0.056
					Black "+" on white background Black "-" on white background	<b>ZB4BA71115</b>	0.056
					Black "→" on white background White "←" on black background	<b>ZB4BA71123</b>	0.056
					Black "↑" on white background White "↓" on black background	<b>ZB4BA71124</b>	0.056
					White "↑" on black background White "↓" on black background	<b>ZB4BA72124</b>	0.056
					Without cap (4)	<b>ZB4BA791</b>	0.056

Specific accessories for multiple-headed push buttons						
Description	Background color	Marking	Sold in lots of	Reference	Weight	kg
Caps only for clip-on mounting on double or triple-headed push buttons (5)	White	Unmarked	10	<b>ZBA71</b>	0.010	
		"I" black	10	<b>ZBA7131</b>	0.010	
		"→" black	10	<b>ZBA7134</b>	0.010	
		"+" black	10	<b>ZBA7138</b>	0.010	
	Black	Unmarked	10	<b>ZBA72</b>	0.010	
		"O" white	10	<b>ZBA7232</b>	0.010	
		"+" white	10	<b>ZBA7233</b>	0.010	
		"→" white	10	<b>ZBA7235</b>	0.010	
	Green	Unmarked	10	<b>ZBA73</b>	0.010	
		"I" white	10	<b>ZBA7331</b>	0.010	
		"+" white	10	<b>ZBA7333</b>	0.010	
		"↑" white	10	<b>ZBA7335</b>	0.010	
Red	Unmarked	10	<b>ZBA74</b>	0.010		
	"O" white	10	<b>ZBA7432</b>	0.010		
Yellow	Unmarked	10	<b>ZBA75</b>	0.010		
Blue	Unmarked	10	<b>ZBA76</b>	0.010		

Clear silicone boots (6)	For 2 flush pushes	–	10	<b>ZBA708</b>	0.055
	For 3 pushes	–	10	<b>ZBA709</b>	0.055
	For 1 flush push + 1 projecting push	–	10	<b>ZBA710</b>	0.055

### Heads with black metal bezel

To order, add the suffix **7** to the references selected above.  
Example: **ZB4BA73132** becomes **ZB4BA731327**.

- (1) Recommended maximum number of contacts constituting the body (mounting collar + contact) associated with the head, see page 24.
  - (2) Not compatible with high power switching contacts and contacts for printed circuit board.
  - (3) These caps are fitted by Schneider Electric and cannot be removed (risk of damage).
  - (4) Caps to be ordered separately: see accessories on this page.
  - (5) Can be clipped-in at 90° steps, through 360°.
  - (6) Can be replaced without dismantling the head.
- Note: For contact block and mounting collar ordering information, see pages 48, 50, 51 and 52.



XB4BA731327



ZB4BA73133



ZB4BA71124



ZBA7235



ZBA7331



ZBA7432





ZBA 709

# Harmony™ XB4 metal 22 mm push buttons

Mushroom head push buttons, spring return

Assembly of other products using body/contact assemblies, see page 48; accessories, see page 62

Mushroom head push buttons (1) (2)						
Screw clamp terminal connections (Schneider Electric anti-retightening system)						
Shape of head	Type of push	Type of contact		Push Dia. (mm)	Color	Reference
						
		N/O	N/C			
						Weight
						kg

Complete units							
	Mushroom head	1	–	40	Black	<b>XB4BC21</b> (ZB4BZ101 + ZB4BC2)	0.122

Heads only							
	Mushroom head			30	Black	<b>ZB4BC24</b>	0.075
					Green	<b>ZB4BC34</b>	0.075
					Red	<b>ZB4BC44</b>	0.075
					Yellow	<b>ZB4BC54</b>	0.075
					Blue	<b>ZB4BC64</b>	0.075
				40	Black	<b>ZB4BC2</b>	0.074
					Green	<b>ZB4BC3</b>	0.074
					Red	<b>ZB4BC4</b>	0.074
					Yellow	<b>ZB4BC5</b>	0.074
					Blue	<b>ZB4BC6</b>	0.074
				60	Black	<b>ZB4BR2</b>	0.093
					Green	<b>ZB4BR3</b>	0.093
					Red	<b>ZB4BR4</b>	0.093
					Yellow	<b>ZB4BR5</b>	0.093
					Blue	<b>ZB4BR6</b>	0.093
				60 (3)	Black	<b>ZB4BR216</b>	0.054
				Hemispherical	Green	<b>ZB4BR316</b>	0.054
					Red	<b>ZB4BR416</b>	0.054
					Yellow	<b>ZB4BR516</b>	0.054
					Blue	<b>ZB4BR616</b>	0.054

### Illuminated mushroom head push buttons (1) (2)

#### Integral LED

Shape of head	Type of push	Push Dia. (mm)	Color	Reference	Weight kg
	Mushroom head	40	White	<b>ZB4BW413</b>	0.051
			Green	<b>ZB4BW433</b>	0.051
			Red	<b>ZB4BW443</b>	0.051
			Orange	<b>ZB4BW453</b>	0.051
			Blue	<b>ZB4BW463</b>	0.051



### Heads with black metal bezel

To order, add a figure 7 to the references selected above.  
Example: **ZB4BC24** becomes **ZB4BC247**.

(1) These push buttons and heads cannot be used for an Emergency Stop function. Therefore, it is recommended that a legend with a black or white background is used.  
 (2) Recommended maximum number of contacts constituting the body (mounting collar + contact) associated with the head, see page 24.  
 (3) Ergonomic product used in two-handed control applications. Recommended maximum number of contacts constituting the body (mounting collar + contact) associated with the head: 6.  
 (4) Only for use with bodies comprised of a light block with integral LED.  
 Note: For contact block and mounting collar ordering information, see pages 48, 50, 51 and 52.  
 For light module ordering information, see pages 49, 50 and 51.



XB4BC21



ZB4BC24



ZB4BC2



ZB4BR2







ZB4BR216



ZB4BW443

# Harmony™ XB4 metal 22 mm push buttons Mushroom head push buttons, latching

Assembly of other products using body/contact assemblies, see page 48; accessories, see page 62

Mushroom head push buttons (1) (2)					
Shape of head	Type of reset	Push Dia. (mm)	Color	Reference	Weight kg
<b>Heads only</b>					
	Push-pull	40	Black	ZB4BT2	0.077
		60	Black	ZB4BX2	0.095
	Turn to release	30	Black	ZB4BS42	0.066
		40	Black	ZB4BS52	0.070
		40	Yellow	ZB4BS55	0.070
		60	Black	ZB4BS62	0.090
	Key release (key no. 455) (2 keys included with head) (3)  (5)	30	Black	ZB4BS72	0.066
		40	Black	ZB4BS12 (4)	0.070
		60	Black	ZB4BS22	0.090

ZB4BT2

ZB4BS62

ZB4BS72

Illuminated mushroom head push buttons (1) (2)					
Integral LED					
Shape of head	Type of reset	Push Dia. (mm)	Color	Reference	Weight kg
<b>Heads only</b>					
	Mushroom head	40	White	ZB4BW613	0.051
			Green	ZB4BW633	0.051
			Orange	ZB4BW653	0.051
			Blue	ZB4BW663	0.051

### Heads with black metal bezel

To order, add a figure 7 to the references selected above.  
Example: ZB4BT2 becomes ZB4BT27.





(1) These push buttons and heads cannot be used for an Emergency Stop function. Therefore, it is recommended that a legend with a black or white background is used.  
 (2) Recommended maximum number of contacts constituting the body (mounting collar + contact) associated with the head, see page 24.  
 (3) For specific keys with other numbers, please consult your Regional Sales Office.  
 (4) Other key numbers:  
 - key no. 421E: add suffix 12 to the reference.  
 - key no. 458A: add suffix 10 to the reference.  
 - key no. 520E: add suffix 14 to the reference.  
 - key no. 3131A: add suffix 20 to the reference.  
 Example: To order a 40 mm black mushroom head for a latching push button, with release by key no. 421E, the reference becomes: ZB4BS1212.  
 (5) The symbol  indicates key withdrawal position(s).  
 Note: For contact block and mounting collar ordering information, see pages 48, 50, 51 and 52.  
 For light module ordering information, see pages 49, 50 and 51.

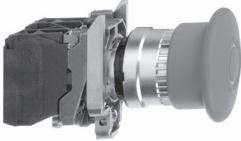

# Harmony™ XB4 metal 22 mm push buttons Emergency stop devices

Assembly of other products using body/contact assemblies, see page 48; accessories, see pages 67 and 68

Mushroom head emergency stop trigger action and mechanical latching push buttons conform to standards EN/IEC 60204-1 and EN/ISO 13850:2006, to Machinery Directive 98/37/EC and to standard EN/IEC60947-5-5. Please consult your Regional Sales Office for a full explanation of these standards and directives.

Emergency stop trigger action and mechanical latching push buttons (1) (2)						
Screw clamp terminal connections (Schneider Electric anti-retightening system)						
Shape of head	Type of reset	Type of contact		Push		Reference
		N/O	N/C	Dia. (mm)	Color	
Weight						
kg						

Complete units								
		Push-pull	1	1	40	Red	<b>XB4BT845</b> (ZB4BZ105 + ZB4BT84)	0.136
		Turn to release	1	1	40	Red	<b>XB4BS8445</b> (ZB4BZ105 + ZB4BS844)	0.130
			–	2	40	Red	<b>XB4BS8444</b> (ZB4BZ104 + ZB4BS844)	0.130
			1	2	40	Red	<b>XB4BS84441</b> (ZB4BZ141 + ZB4BS844)	0.140
		Key release (key no. 455)	1	1	40	Red	<b>XB4BS9445</b> (ZB4BZ105 + ZB4BS944)	0.170

Heads only						
Shape of head	Type of reset	Push		Reference	Weight	
		Dia. mm	Color			
kg						
	Push-pull	30	Red	<b>ZB4BT844</b>	0.078	
		40	Red	<b>ZB4BT84</b>	0.078	
		60	Red	<b>ZB4BX84</b>	0.098	
	Turn to release	30	Red	<b>ZB4BS834</b>	0.068	
		40	Red	<b>ZB4BS844</b>	0.073	
		60	Red	<b>ZB4BS864</b>	0.093	
	Key release (key no. 455) 2 keys included with head (5)	30	Red	<b>ZB4BS934</b>	0.094	
		40	Red	<b>ZB4BS944 (4)</b>	0.098	
		60	Red	<b>ZB4BS964</b>	0.118	

Bellows for harsh environments (IP 69K)					
For use in	Material	Color	Sold in lots of	Unit reference	Weight
kg					
Environments subject to humidity, dust, high pressure cleaning, etc.	Silicone	Red	2	<b>ZBZ48</b>	0.009
	EPDM	Black	2	<b>ZBZ28</b>	0.009
		Yellow	2	<b>ZBZ58</b>	0.009

### Heads with black metal bezel

To order, add a figure 7 to the references selected above.  
Example: **ZB4BT844** becomes **ZB4BT8447**.

(1) Recommended maximum number of contacts constituting the body (mounting collar + contact) associated with the head, see page 24  
 (2) It is recommended that a legend or yellow background is used.  
 (3) The symbol  indicates key withdrawal position(s).  
 (4) Other key numbers:  
 - key no. 421E: add suffix 12 to the reference.  
 - key no. 458A: add suffix 10 to the reference.  
 - key no. 520E: add suffix 14 to the reference.  
 - key no. 3131A: add suffix 20 to the reference.  
 - key no. 4A185: add suffix D to the reference.  
 Example: To order a 40 mm red mushroom head for a trigger action and mechanical latching Emergency stop push button, with release by key no. 421E, the reference becomes: **ZB4BS94412**.  
 (5) For specific keys with other numbers, please consult your Regional Sales Office.  
 Note: For contact block and mounting collar ordering information, see pages 48, 50, 51 and 52.

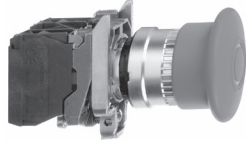

XB4BT845



XB4BS9445



XB4BS834

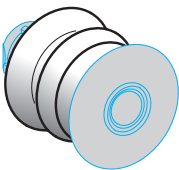



ZBZ●8



# Harmony™ XB4 metal 22 mm push buttons Emergency switching off devices

Assembly of other products using body/contact assemblies, see page 48; combined sub-assemblies, see page 52; accessories, see pages 62 and 68



Mushroom head emergency switching off mechanical latching push buttons conform to standards IEC60364-5-53 and EN/IEC60947-5-5. Please consult your Regional Sales Office for a full explanation of these standards and directives.

Emergency switching off, mechanical latching push buttons <sup>(1) (2)</sup>						
Screw clamp terminal connections (Schneider Electric anti-retightening system)						
Shape of head	Type of reset	Type of contact		Push		Reference
		 N/O	 N/C	Dia. mm	Color	
						Weight kg

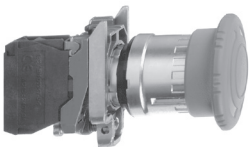
**Complete units**





XB4BS542

	Push-pull	–	1	40	Red	<b>XB4BT42</b> (ZB4BZ102 + ZB4BT4)	0.125
	Turn to release	–	1	40	Red	<b>XB4BS542</b> (ZB4BZ102 + ZB4BS54)	0.118
	Key release (key no. 455)	–	1	40	Red	<b>XB4BS142</b> (ZB4BZ102 + ZB4BS14)	0.133

**Heads only**



ZB4BT4

	Push-pull			30	Red	<b>ZB4BT44</b>	0.077
				40	Red	<b>ZB4BT4</b>	0.077
				60	Red	<b>ZB4BX4</b>	0.095
	Turn to release			30	Red	<b>ZB4BS44</b>	0.066
				40	Red	<b>ZB4BS54</b>	0.070
				60	Red	<b>ZB4BS64</b>	0.090
	Key release (key no. 455) 2 keys included with head (5)			30	Red	<b>ZB4BS74</b>	0.066
				40	Red	<b>ZB4BS14 (4)</b>	0.070
				60	Red	<b>ZB4BS24</b>	0.090



ZB4BS64



ZB4BS74

Illuminated Emergency switching off, mechanical latching push buttons <sup>(1)</sup>						
Screw clamp terminal connections (Schneider Electric anti-retightening system)						
Shape of head	Type of reset	Push		Reference	Weight kg	
		Dia. mm	Color			

<b>Heads only (6)</b>							
	Push-pull			40	Red	<b>ZB4BW643</b>	0.051

**Heads with black metal bezel**

To order, add a figure 7 to the references selected above.  
Example: **ZB4BT4** becomes **ZB4BT47**.

(1) Recommended maximum number of contacts constituting the body (mounting collar + contact) associated with the head, see page 24.

(2) It is recommended that a legend or yellow background is used.

(3) The symbol  indicates key withdrawal position(s).

(4) Other key numbers:

- key no. 421E: add suffix 12 to the reference.

- key no. 458A: add suffix 10 to the reference.

- key no. 520E: add suffix 14 to the reference.

- key no. 3131A: add suffix 20 to the reference.

Example: To order a 40 mm red mushroom head for a mechanical latching Emergency switching off push button, with release by key no. 421E, the reference becomes: **ZB4BS1412**.

(5) For specific keys with other numbers, please consult your Regional Sales Office.

(6) Only for use with bodies comprised of a light source with integral LED.

Note: For contact block and mounting collar ordering information, see pages 48, 50, 51 and 52.







For light module ordering information, see pages 49, 50 and 51.

# Harmony™ XB4 metal 22 mm push buttons

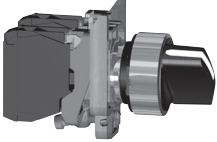





## Selector switches with standard handle

Assembly of other products using body/contact assemblies, see page 48; accessories, see page 62

Selector switches with standard handle <sup>(1)</sup>						
Screw clamp terminal connections (Schneider Electric anti-retightening system)						
Shape of head	Type of operator	Type of contact		Positions		Reference
		N/O	N/C	Number	Type	
						Weight
						kg

Complete units								
	Standard handle, black	1	–	2-position 90°	Stay put		<b>XB4BD21</b> (ZB4BZ101 + ZB4BD2)	0.095
		1	–		Spring return from right to left		<b>XB4BD41</b> (ZB4BZ101 + ZB4BD4)	0.100
		1	1		Stay put		<b>XB4BD25</b> (ZB4BZ105 + ZB4BD2)	0.095
		2	–	3-position ± 45°	Stay put		<b>XB4BD33</b> (ZB4BZ103 + ZB4BD3)	0.095
					Spring return to center		<b>XB4BD53</b> (ZB4BZ103 + ZB4BD5)	0.095

XB4BD33

Heads only								
	Standard handle, black			2-position 90°	Stay put		<b>ZB4BD2</b>	0.040
					Spring return from right to left		<b>ZB4BD4</b>	0.045
				3-position ± 45°	Stay put		<b>ZB4BD3</b>	0.040
					Spring return to center		<b>ZB4BD5</b>	0.040
					Spring return from left to center		<b>ZB4BD7</b>	0.040
					Spring return from right to center		<b>ZB4BD8</b>	0.040

ZB4BD4

Heads only with other colored handles	
	Standard handle, white
	add suffix <b>01</b> to the reference, example: <b>ZB4BD201</b>
	Standard handle, green
	add suffix <b>03</b> to the reference, example: <b>ZB4BD203</b>
	Standard handle, red
	add suffix <b>04</b> to the reference, example: <b>ZB4BD204</b>
	Standard handle, yellow
	add suffix <b>05</b> to the reference, example: <b>ZB4BD205</b>
	Standard handle, blue
	add suffix <b>06</b> to the reference, example: <b>ZB4BD206</b>

**Heads with black metal bezel**











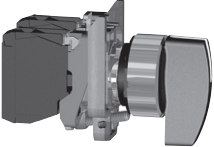



















For heads with standard black handle only. To order, add the suffix **7** to the references selected from above.  
Example: **ZB4BD2** becomes **ZB4BD27**.

<sup>(1)</sup> Recommended maximum number of contacts and sequence of contacts constituting the body (mounting collar + contact) associated with the head, see page 24.  
Note: For contact block and mounting collar ordering information, see pages 48, 50, 51 and 52.

# Harmony™ XB4 metal 22 mm push buttons

Selector switches with long handle:  
normal and padlockable

Assembly of other products using body/contact assemblies, see page 48; accessories, see page 62

Selector switches with long handle (1)												
Screw clamp terminal connections (Schneider Electric anti-retightening system)												
Shape of head	Type of operator	Type of contact		Positions		Reference	Weight					
		N/O	N/C	Number	Type							
<b>Complete units</b>												
	Long handle, black	1	-	2-position 90°	Stay put		<b>ZB4BJ21</b> (ZB4BZ101 + ZB4BJ2)	0.096				
				3-position ±45°	Stay put		<b>ZB4BJ33</b> (ZB4BZ103 + ZB4BJ3)	0.096				
					Spring return to center		<b>ZB4BJ53</b> (ZB4BZ103 + ZB4BJ5)	0.096				
<b>Heads only</b>												
	Long handle, black	1	-	2-position 90°	Stay put		<b>ZB4BJ2</b>	0.040				
					Spring return from right to left		<b>ZB4BJ4</b>	0.045				
				3-position ±45°	Stay put		<b>ZB4BJ3</b>	0.040				
					Spring return to center		<b>ZB4BJ5</b>	0.040				
					Spring return from left to center		<b>ZB4BJ7</b>	0.040				
					Spring return from right to center		<b>ZB4BJ8</b>	0.040				
					Long handle, padlockable (2)	1	-	2-position 90°	Stay put		<b>ZB4BJ291</b>	0.048
										<b>ZB4BJ292</b>	0.048	
	<b>ZB4BJ294</b>	0.048										
Spring return from right to left		<b>ZB4BJ491</b>	0.054									
3-position ±45°	Stay put		<b>ZB4BJ391</b>					0.048				
		<b>ZB4BJ392</b>	0.048									
		<b>ZB4BJ393</b>	0.048									
		<b>ZB4BJ394</b>	0.048									
		<b>ZB4BJ395</b>	0.048									
		<b>ZB4BJ396</b>	0.048									
		<b>ZB4BJ397</b>	0.048									
	Spring return to center		<b>ZB4BJ593</b>					0.048				
Spring return from right to center		<b>ZB4BJ891</b>	0.048									
		<b>ZB4BJ893</b>	0.048									
	<b>ZB4BJ895</b>	0.048										
Spring return from left to center		<b>ZB4BJ792</b>	0.048									
		<b>ZB4BJ793</b>	0.048									
		<b>ZB4BJ796</b>	0.048									

### Heads with black metal bezel

To order, add a figure 7 to the references selected from above.

Example: **ZB4BJ2** becomes **ZB4BJ27**.

(1) Recommended maximum number of contacts and sequence of contacts constituting the body (mounting collar + contact) associated with the head, see page 24.

(2) The symbol  indicates the padlocking positions.

Note: For contact block and mounting collar ordering information, see pages 48, 50, 51 and 52.

# Harmony™ XB4 metal 22 mm push buttons

Key switches with key no. 455, 421E, 458A, 520E, 3131A

Assembly of other products using body/contact assemblies, see page 48; accessories, see page 62

Key switches <sup>(1) (2)</sup>						
Screw clamp terminal connections (Schneider Electric anti-retightening system)						
Shape of head	Type of operator	Type of contact		Positions		Reference
		N/O	N/C	Number	Type	

**Complete units**

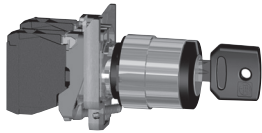

XB4BG33

Key switch with key no. 455	Type of contact	Positions	Type	Reference	Weight
1	-	2-position 90°	Stay put	<b>XB4BG21</b> (ZB4BZ101 + ZB4BG2)	0.153
				<b>XB4BG41</b> (ZB4BZ101 + ZB4BG4)	0.153
		Spring return to left	<b>XB4BG61</b> (ZB4BZ101 + ZB4BG6)	0.153	
		3-position ± 45°	Stay put	<b>XB4BG03</b> (ZB4BZ103 + ZB4BG0)	0.153
	<b>XB4BG33</b> (ZB4BZ103 + ZB4BG3)		0.153		

**Heads only**



ZB4BG0

Key switch with key no. 455 <sup>(3) (4)</sup>	Type of contact	Positions	Type	Reference	Weight		
						Number	Type
1	-	2-position 90°	Stay put	<b>ZB4BG2</b>	0.098		
				<b>ZB4BG02</b>	0.098		
				<b>ZB4BG4</b>	0.098		
			Spring return from right to left	<b>ZB4BG6</b>	0.098		
			3-position ± 45°	Stay put	<b>ZB4BG0</b>	0.098	
					<b>ZB4BG03</b>	0.098	
				<b>ZB4BG04</b>	0.098		
				<b>ZB4BG3</b>	0.098		
				<b>ZB4BG5</b>	0.098		
				<b>ZB4BG9</b>	0.098		
					Spring return from left to center	<b>ZB4BG1</b>	0.098
						<b>ZB4BG01</b>	0.098
Spring return to center	<b>ZB4BG7</b>				0.098		
Spring return from right to center	<b>ZB4BG8</b>				0.098		
	<b>ZB4BG05</b>				0.098		
	<b>ZB4BG08</b>				0.098		

**Heads with black metal bezel**

To order, add a figure 7 to the references selected from above. Example: **ZB4BG2** becomes **ZB4BG27**.











(1) Recommended maximum number of contacts and sequence of contacts constituting the body (mounting collar + contact) associated with the head, see page 24.  
 (2) The symbol indicates key withdrawal position(s).  
 (3) Other key numbers:  
 - key no. 421E: add suffix 12 to the reference.  
 - key no. 458A: add suffix 10 to the reference.  
 - key no. 520E: add suffix 14 to the reference.  
 - key no. 3131A: add suffix 20 to the reference.  
 Example: For a switch head with key no. 421E, 2-position stay put, with key withdrawal from the left-hand position, the reference becomes: **ZB4BG212**.  
 (4) For specific keys with other numbers, please consult your Regional Sales Office.  
 Note: For contact block and mounting collar ordering information, see pages 48, 50, 51 and 52.









# Harmony™ XB4 metal 22 mm push buttons



Key switches with key no. TEC10

Selector switches with knurled knob - Toggle switches

Assembly of other products using body/contact assemblies, see page 48; accessories, see page 62

Key switches with key TEC10						
Shape of head	Type of operator	Positions		Reference	Weight kg	
		Number	Type			
<b>Heads only</b>						
	Key switch with key no. TEC10	2-position 90°	Stay put		<b>ZB4BG2TEC10</b>	0.160
					<b>ZB4BG4TEC10</b>	0.160
			Spring return from right to left		<b>ZB4BG6TEC10</b>	0.170
				3-position ± 45°	Stay put	
			<b>ZB4BG3TEC10</b>			0.160
			<b>ZB4BG5TEC10</b>			0.160
		Spring return to center			<b>ZB4BG9TEC10</b>	0.160
					<b>ZB4BG7TEC10</b>	0.170
					<b>ZB4BG05TEC10</b>	0.170

Selector switches with knurled knob (1)						
Shape of head	Type of operator	Positions		Reference	Weight kg	
		Number	Type			
<b>Heads only</b>						
	Black knurled knob	2-position 90°	Stay put		<b>ZB4BD29</b>	0.043
					<b>ZB4BD49</b>	0.050
		3-position ± 45°	Stay put		<b>ZB4BD39</b>	0.040
					<b>ZB4BD59</b>	0.040
					<b>ZB4BD79</b>	0.040
					<b>ZB4BD89</b>	0.040
						

Toggle switches (1)						
Shape of head	Type of operator	Positions		Reference	Weight kg	
		Number	Type			
<b>Heads only</b>						
	Black lever	2-position 90°	Stay put		<b>ZB4BD28</b>	0.026
					<b>ZB4BD48</b>	0.026

### Heads with black metal bezel

To order, add a figure 7 to the references selected from above.  
Example: **ZB4BD29** becomes **ZB4BD297**.

For the references with key TEC10, add the 7 before TEC10.  
Example: **ZB4BG2TEC10** becomes **ZB4BG27TEC10**.

(1) Recommended maximum number of contacts and sequence of contacts constituting the body (mounting collar + contact) associated with the head, see page 24.  
Note: For contact block and mounting collar ordering information, see pages 48, 50, 51 and 52.



ZB4BD29







ZB4BD28



# Harmony™ XB4 metal 22 mm push buttons

Illuminated selector switches with standard handle and integral LED

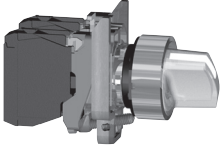
Assembly of other products using combined sub-assemblies, see page 52; accessories, see page 62

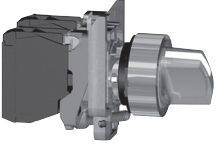
Illuminated selector switches with standard handle, with integral LED <sup>(1)</sup>														
Screw clamp terminal connections (Schneider Electric anti-retightening system)														
Shape of head	Type of operator	Type of contact	Positions Number Type	Supply voltage	Color of handle	Reference	Weight							
				V			kg							
		N/O	N/C											
<b>Complete units</b>														
 XB4BK123B5		Standard handle	1	1	2-position Stay put  90°	~ 24 (50/60 Hz)	Green <b>XB4BK123B5</b> (ZB4BW0B35 + ZB4BK1233)	0.101						
							Red <b>XB4BK124B5</b> (ZB4BW0B45 + ZB4BK1243)	0.101						
							Orange <b>XB4BK125B5</b> (ZB4BW0B55 + ZB4BK1253)	0.101						
						~ 110 to 120 (50/60 Hz)	Green <b>XB4BK123G5</b> (ZB4BW0G35 + ZB4BK1233)	0.101						
							Red <b>XB4BK124G5</b> (ZB4BW0G45 + ZB4BK1243)	0.101						
							Orange <b>XB4BK125G5</b> (ZB4BW0G55 + ZB4BK1253)	0.101						
						~ 230 to 240 (50/60 Hz)	Green <b>XB4BK123M5</b> (ZB4BW0M35 + ZB4BK1233)	0.101						
							Red <b>XB4BK124M5</b> (ZB4BW0M45 + ZB4BK1243)	0.101						
							Orange <b>XB4BK125M5</b> (ZB4BW0M55 + ZB4BK1253)	0.101						
						 XB4BK134B5			1	1	3-position Stay put  ± 45°	~ 24 (50/60 Hz)	Green <b>XB4BK133B5</b> (ZB4BW0B35 + ZB4BK1333)	0.101
													Red <b>XB4BK134B5</b> (ZB4BW0B45 + ZB4BK1343)	0.101
													Orange <b>XB4BK135B5</b> (ZB4BW0B55 + ZB4BK1353)	0.101
												~ 110 to 120 (50/60 Hz)	Green <b>XB4BK133G5</b> (ZB4BW0G35 + ZB4BK1333)	0.101
													Red <b>XB4BK134G5</b> (ZB4BW0G45 + ZB4BK1343)	0.101
													Orange <b>XB4BK135G5</b> (ZB4BW0G55 + ZB4BK1353)	0.101
												~ 230 to 240 (50/60 Hz)	Green <b>XB4BK133M5</b> (ZB4BW0M35 + ZB4BK1333)	0.101
													Red <b>XB4BK134M5</b> (ZB4BW0M45 + ZB4BK1343)	0.101
													Orange <b>XB4BK135M5</b> (ZB4BW0M55 + ZB4BK1353)	0.101







(1) Recommended maximum number of contacts constituting the body (mounting collar + contact) associated with the head, see page 24.

# Harmony™ XB4 metal 22 mm push buttons

## Illuminated selector switches with standard handle and integral LED

Assembly of other products using combined sub-assemblies, see page 48; accessories, see page 62

### Illuminated selector switches with standard handle, with integral LED (continued) (1)

Shape of head	Type of operator	Positions		Color of handle	Reference	Weight kg	
		Number	Type				
<b>Heads only (2)</b>							
	Standard handle	2-position 90°	Stay put		White	<b>ZB4BK1213</b>	0.036
				Green	<b>ZB4BK1233</b>	0.036	
				Red	<b>ZB4BK1243</b>	0.036	
				Orange	<b>ZB4BK1253</b>	0.036	
				Blue	<b>ZB4BK1263</b>	0.036	
			Spring return from right to left		White	<b>ZB4BK1413</b>	0.037
				Green	<b>ZB4BK1433</b>	0.037	
				Red	<b>ZB4BK1443</b>	0.037	
				Orange	<b>ZB4BK1453</b>	0.037	
				Blue	<b>ZB4BK1463</b>	0.037	
	3-position ± 45°	Stay put		White	<b>ZB4BK1313</b>	0.036	
				Green	<b>ZB4BK1333</b>	0.036	
				Red	<b>ZB4BK1343</b>	0.036	
				Orange	<b>ZB4BK1353</b>	0.036	
				Blue	<b>ZB4BK1363</b>	0.036	
			Spring return to center		White	<b>ZB4BK1513</b>	0.036
				Green	<b>ZB4BK1533</b>	0.036	
				Red	<b>ZB4BK1543</b>	0.036	
				Orange	<b>ZB4BK1553</b>	0.036	
				Blue	<b>ZB4BK1563</b>	0.036	
Spring return from right to center		White	<b>ZB4BK1813</b>	0.036			
		Green	<b>ZB4BK1833</b>	0.036			
		Red	<b>ZB4BK1843</b>	0.036			
		Orange	<b>ZB4BK1853</b>	0.036			
		Blue	<b>ZB4BK1863</b>	0.036			
Spring return from left to center		White	<b>ZB4BK1713</b>	0.036			
		Green	<b>ZB4BK1733</b>	0.036			
		Red	<b>ZB4BK1743</b>	0.036			
		Orange	<b>ZB4BK1753</b>	0.036			
		Blue	<b>ZB4BK1763</b>	0.036			



ZB4BK1343



### Heads with black metal bezel

To order, add a figure 7 to the references selected from above.  
Example: **ZB4BK1213** becomes **ZB4BK12137**.



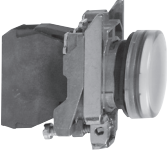

(1) Recommended maximum number of contacts constituting the body (mounting collar + contact) associated with the head, see page 24.  
(2) Only for use with bodies comprised of a light source with integral LED.  
Note: For contact block and mounting collar ordering information, see pages 48, 50, 51 and 52.  
For light module ordering information, see pages 49, 50 and 51.

# Harmony™ XB4 metal 22 mm push buttons Pilot lights with integral LED

Assembly of other products using body/light assemblies, see page 56; accessories, see pages 60 and 62

Pilot lights with integral LED					
Screw clamp terminal connections (Schneider Electric anti-retightening system)					
Shape of head	Supply voltage V	Color	Reference	Weight kg	
<b>Complete units</b>					
■ With plain lens					
	 <b>Protected LED</b>	~ 24 (50/60 Hz)	White	<b>XB4BVB1</b> (ZB4BVB1 + ZB4BV013)	0.080
			Green	<b>XB4BVB3</b> (ZB4BVB3 + ZB4BV033)	0.080
			Red	<b>XB4BVB4</b> (ZB4BVB4 + ZB4BV043)	0.080
			Orange	<b>XB4BVB5</b> (ZB4BVB5 + ZB4BV053)	0.080
			Blue	<b>XB4BVB6</b> (ZB4BVB6 + ZB4BV063)	0.080
			White	<b>XB4BVG1</b> (ZB4BVG1 + ZB4BV013)	0.080
	Green	<b>XB4BVG3</b> (ZB4BVG3 + ZB4BV033)	0.080		
	Red	<b>XB4BVG4</b> (ZB4BVG4 + ZB4BV043)	0.080		
	Orange	<b>XB4BVG5</b> (ZB4BVG5 + ZB4BV053)	0.080		
	Blue	<b>XB4BVG6</b> (ZB4BVG6 + ZB4BV063)	0.080		
	~ 110 to 120 (50/60 Hz)	White	<b>XB4BVM1</b> (ZB4BVM1 + ZB4BV013)	0.080	
		Green	<b>XB4BVM3</b> (ZB4BVM3 + ZB4BV033)	0.080	
		Red	<b>XB4BVM4</b> (ZB4BVM4 + ZB4BV043)	0.080	
		Orange	<b>XB4BVM5</b> (ZB4BVM5 + ZB4BV053)	0.080	
		Blue	<b>XB4BVM6</b> (ZB4BVM6 + ZB4BV063)	0.080	
		White	<b>XB4BVM1</b> (ZB4BVM1 + ZB4BV013)	0.080	
	Green	<b>XB4BVM3</b> (ZB4BVM3 + ZB4BV033)	0.080		
	Red	<b>XB4BVM4</b> (ZB4BVM4 + ZB4BV043)	0.080		
Orange	<b>XB4BVM5</b> (ZB4BVM5 + ZB4BV053)	0.080			
Blue	<b>XB4BVM6</b> (ZB4BVM6 + ZB4BV063)	0.080			

XB4BVB5

Heads only (1)					
Shape of head	For use with body comprised of light source type	Color of lens	Reference	Weight kg	
■ With plain lens					
	 <b>Protected LED</b>	Integral LED only	White	<b>ZB4BV013</b>	0.026
		Green	<b>ZB4BV033</b>	0.026	
		Red	<b>ZB4BV043</b>	0.026	
		Orange	<b>ZB4BV053</b>	0.026	
		Blue	<b>ZB4BV063</b>	0.026	
		5 colors (2) (3)	<b>ZB4BV003</b>	0.026	
■ With plain lens, for insertion of legend (3)					
 <b>Protected LED</b>	Integral LED only	White	<b>ZB4BV013E</b>	0.026	
		Green	<b>ZB4BV033E</b>	0.026	
		Red	<b>ZB4BV043E</b>	0.026	
		Orange	<b>ZB4BV053E</b>	0.026	
		Blue	<b>ZB4BV063E</b>	0.026	
■ With grooved lens (4)					
 <b>Protected LED</b>	Integral LED only	White	<b>ZB4BV013S</b>	0.026	
		Green	<b>ZB4BV033S</b>	0.026	
		Red	<b>ZB4BV043S</b>	0.026	
		Orange	<b>ZB4BV053S</b>	0.026	
		Blue	<b>ZB4BV063S</b>	0.026	

ZB4BV063

ZB4BV043S

(1) Only for use with bodies comprised of a light source with integral LED.  
 (2) Head supplied with 5 different colored lenses (white, green, red, orange, blue) not fitted, for insertion of legend.  
 (3) For legend ordering information: see page 62.  
 (4) For use in bright ambient light conditions (outdoors in sunlight, for example).  
 Note: For light module and mounting collar ordering information, see pages 49, 50 and 51.

# Harmony™ XB4 metal 22 mm push buttons

Pilot lights with integral LED and  
with BA 9s base fitting

Assembly of other products using body/light assemblies, see page 57; accessories, see pages 60 and 62

## Pilot lights with integral LED and transformer (1.2 VA, 24 V secondary)

Screw clamp terminal connections (Schneider Electric anti-retightening system)



Shape of head	Supply voltage V	Color	Reference (1)	Weight kg
<b>Complete units - With plain lens</b>				
	~ 400 - 50 Hz (1)	White	<b>XB4BV5B1</b>	0.172
		Green	<b>XB4BV5B3</b>	0.172
		Red	<b>XB4BV5B4</b>	0.172
		Orange	<b>XB4BV5B5</b>	0.172
		Blue	<b>XB4BV5B6</b>	0.172



XB4BV5B●

## Pilot lights with BA 9s base fitting, with plain or grooved lens

Screw clamp terminal connections (Schneider Electric anti-retightening system)

Shape of head	Supply voltage V	Color	Reference	Weight kg
<b>Complete units - With plain lens</b>				
■ Direct supply, for BA 9s bulb, U ≤ 250 V, 2.4 W max (bulb not included)				
	≤ 250	White	<b>XB4BV61</b> (ZB4BV6 + ZB4BV01)	0.075
		Green	<b>XB4BV63</b> (ZB4BV6 + ZB4BV03)	0.075
		Red	<b>XB4BV64</b> (ZB4BV6 + ZB4BV04)	0.075
		Orange	<b>XB4BV65</b> (ZB4BV6 + ZB4BV05)	0.075
■ Via integral transformer, 1.2 VA, 6 V secondary, with BA 9s incandescent bulb (included)				
	~ 110 to 120 - 50/60 Hz	White	<b>XB4BV31</b> (ZB4BV3 + ZB4BV01)	0.152
		Green	<b>XB4BV33</b> (ZB4BV3 + ZB4BV03)	0.152
		Red	<b>XB4BV34</b> (ZB4BV3 + ZB4BV04)	0.152
		Orange	<b>XB4BV35</b> (ZB4BV3 + ZB4BV05)	0.152
	~ 230 - 50 Hz ~ 220 to 240 - 60 Hz	White	<b>XB4BV41</b> (ZB4BV4 + ZB4BV01)	0.152
		Green	<b>XB4BV43</b> (ZB4BV4 + ZB4BV03)	0.152
		Red	<b>XB4BV44</b> (ZB4BV4 + ZB4BV04)	0.152
		Orange	<b>XB4BV45</b> (ZB4BV4 + ZB4BV05)	0.152

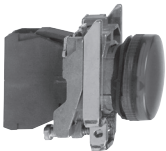

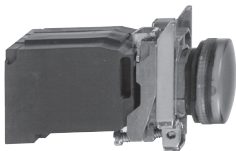

XB4BV64



XB4BV33

## Heads only (2)

Shape of head	For use with body comprised of light source type	Color of lens	Reference	Weight kg
■ With plain lens				
	<b>With BA 9s base fitting</b>	White	<b>ZB4BV01</b>	0.027
		Green	<b>ZB4BV03</b>	0.027
		Red	<b>ZB4BV04</b>	0.027
		Orange	<b>ZB4BV05</b>	0.027
		Blue	<b>ZB4BV06</b>	0.027
		Clear	<b>ZB4BV07</b>	0.027
■ With grooved lens (3)				
	<b>With BA 9s base fitting</b>	White	<b>ZB4BV01S</b>	0.027
		Green	<b>ZB4BV03S</b>	0.027
		Red	<b>ZB4BV04S</b>	0.027
		Orange	<b>ZB4BV05S</b>	0.027
		Blue	<b>ZB4BV06S</b>	0.027
		Clear	<b>ZB4BV07S</b>	0.027



ZB4BV04



ZB4BV06S

(1) To order ~ 440 to 460 V - 60 Hz transformer blocks, please replace "5" in the reference by "8". Example: XB4BV5B1 becomes XB4BV8B1. To order ~ 550 to 600 V - 60 Hz blocks, please replace "5" by "9". Example: XB4BV5B1 becomes XB4BV9B1.

(2) Only for use with bodies comprised of a light source with BA 9s base fitting (incandescent, neon or LED).

(3) For use in bright ambient light conditions (outdoors in sunlight, for example).

Note: For light module and mounting collar ordering information, see pages 49, 50 and 51.

# Harmony™ XB4 metal 22 mm push buttons

Push buttons for manual overload reset, hour counters, buzzers, fuse carrier

Assembly of other products using body/contact assemblies, see page 48; accessories, see page 62



XB4BA8•1

Manual overload reset push buttons					
Shape of head	Travel mm	Actuation distance mm	Color	Reference	Weight kg
	10	6 to 16	Black	<b>XB4BA821</b>	0.037
			Red	<b>XB4BA841</b>	0.037
			Blue	<b>XB4BA861</b>	0.037
		16 to 26	Black	<b>XB4BA822</b>	0.038
			Red	<b>XB4BA842</b>	0.038
			Blue	<b>XB4BA862</b>	0.038
	14	30 to 130	Black	<b>XB4BA921</b>	0.058
			Red	<b>XB4BA941</b>	0.058
			Blue	<b>XB4BA961</b>	0.058
		130 to 257	Black	<b>XB4BA922</b>	0.071
			Red	<b>XB4BA942</b>	0.071
			Blue	<b>XB4BA962</b>	0.071

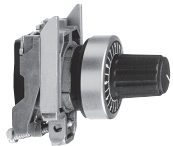

ZB4BD912

Heads + mounting base for potentiometer (1)				
Shape of head	Description	For use with	Reference	Weight kg
	For potentiometer with shaft length 45 to 50 mm	6 mm shaft	<b>ZB4BD912</b>	0.080
		6.35 mm shaft	<b>ZB4BD922</b>	0.080



XB5DS•

Hour counters			
Specifications	Supply voltage V	Reference	Weight kg
Indication 0 to 9999.9	~ 12 to 24 - 50/60 Hz	<b>XB5DSB</b>	0.045
	~ 120 - 60 Hz	<b>XB5DSG</b>	0.045
	~ 230 to 240 - 50 Hz	<b>XB5DSM</b>	0.045



XB5KS•

Annunciators (IP 40 NEMA 1)			
85 db buzzer: 4 kHz, with continuous or intermittent operation (connection diagram: see page 77)	~ 24 - 50/60 Hz	<b>XB5KSB</b>	0.035
	~ 120 - 50/60 Hz	<b>XB5KSG</b>	0.035
	~ 230 to 240 - 50 Hz	<b>XB5KSM</b>	0.035



XB5DT1S

Fuse carrier			
Description	For use with	Reference	Weight kg
Fuse carrier	5 x 20 mm fuse 6.3 A - 250 V	<b>t</b>	0.022

(1) Potentiometer not included.  
Note: For contact block and mounting collar ordering information, see pages 48, 50, 51 and 52.



# Harmony™ XB4 metal 22 mm push buttons

Joystick controllers, wobble sticks

Assembly of other products using accessories, see page 62

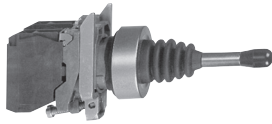

XD4PA12

Joystick controllers (with 54 mm long operating shaft) (1)				
Screw clamp terminal connections (Schneider Electric anti-retightening system)				
Description	Operation	Spring return to zero position	Reference	Weight kg
<b>Complete products</b>				
2-direction	1 notch 1 N/O contact per direction	Without	<b>XD4PA12</b>	0.116
		With	<b>XD4PA22</b>	0.116
4-direction	1 notch 1 N/O contact per direction	Without	<b>XD4PA14</b>	0.133
		With	<b>XD4PA24</b>	0.133

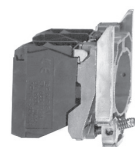

ZD4PA103

Sub-assemblies for joystick controllers			
Description	Functions	Reference	Weight kg
Complete body/contact assemblies	2-direction	<b>ZD4PA103</b>	0.049
	4-direction	<b>ZD4PA203</b>	0.058
Complete head assemblies with operating shaft	2-direction, stay put	<b>ZD4PA12</b>	0.022
	2-direction, spring return to zero position	<b>ZD4PA22</b>	0.022
	4-direction, stay put	<b>ZD4PA14</b>	0.022
	4-direction, spring return to zero position	<b>ZD4PA24</b>	0.022

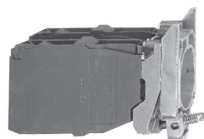

ZD4PA203



ZD4PA12

Legends 30 x 48 mm for engraving	2-direction	Black one side Red reverse	<b>ZBG2201</b>	0.001
		White one side Yellow reverse	<b>ZBG2401</b>	0.001
Legends 48 x 48 mm for engraving	4-direction	Black one side Red reverse	<b>ZBG4201</b>	0.002
		White one side Yellow reverse	<b>ZBG4401</b>	0.002



ZB4BB2

Wobble stick heads				
Shape of head	For use with	Color	Reference	Weight kg
	Omnidirectional, spring return	Black	<b>ZB4BB2</b>	0.058
		Red	<b>ZB4BB4</b>	0.058

(1) Must not be used with standard contact blocks ZBE10● (single) or ZBE20● (double).  
Note: For contact block and mounting collar ordering information, see pages 48, 50, 51 and 52.

**Other versions** Joystick controllers and complete body/contact assemblies for joystick controllers with Faston® connector terminals (6.35 or 2 x 2.8). Please consult your Regional Sales Office.

# Harmony™ XB4 metal 22 mm push buttons

Body/contact assemblies  
Screw clamp terminal connections

To combine with heads, see pages 26 to 47



ZB4BZ009



ZBE101



ZBE203

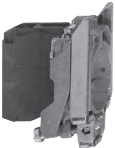

ZB4BZ101



ZBE201

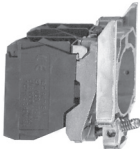

ZB4BZ106

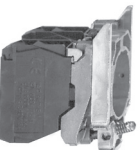

ZB4BZ107

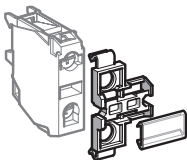

ZBZ001

Body/mounting collar			
For use with	Sold in lots of	Unit reference	Weight kg
Electrical block (contact or light)	10	ZB4BZ009	0.038

### Contact functions (1) Screw clamp terminal connections (Schneider Electric anti-retightening system)

Contacts for standard applications						
Description	Type of contact			Sold in lots of	Unit reference	Weight kg
		N/O	N/C			
Contact blocks	Single	1	–	5	ZBE101	0.011
		–	1	5	ZBE102	0.011
	Double	2	–	5	ZBE203	0.020
		–	2	5	ZBE204	0.020
	Single with body/mounting collar	1	1	5	ZBE205	0.020
		1	–	1	ZB4BZ101	0.053
		–	1	1	ZB4BZ102	0.053
		2	–	1	ZB4BZ103	0.062
		–	2	1	ZB4BZ104	0.062
		1	1	1	ZB4BZ105	0.062
		1	2	1	ZB4BZ141	0.072

Contacts for specific applications								
Application	Type of contact	Description			Sold in lots of	Unit reference	Weight kg	
			N/O	N/C				
Low power switching	Single	Standard	1	–	5	ZBE1016	0.012	
			–	1	5	ZBE1026	0.012	
		Dusty environment (2) (IP5X, 50 µm dust)	1	–	5	ZBE1016P	0.012	
			–	1	5	ZBE1026P	0.012	
Staggered contacts	Single	Early make N/O	1	–	5	ZBE201	0.011	
		Late break N/C	–	1	5	ZBE202	0.011	
		Single with body/ mounting collar	Overlapping N/O+N/C	1	1	5	ZB4BZ106	0.062
			Staggered N/O+N/O	2	–	5	ZB4BZ107	0.062

### Clip-on legend holder, sheet of blank legends and labelling software

Description	Sold in lots of	Unit reference	Weight kg
Clip-on legend-holder for electrical blocks with screw clamp terminal connections (4). For identification of an XB4B control or signaling unit	10	ZBZ001	0.001
Sheet of 50 blank legends for legend holder ZBZ001	10	ZBY001	0.023

(1) The contact blocks enable variable composition of body/contact assemblies. Maximum number of rows possible: 3. Either 3 rows of 3 single contacts or 1 row of 3 double contacts + 1 row of 3 single contacts (double contacts occupy the first 2 rows). Maximum number of contacts is specified on page 24.

(2) It is not possible to fit an additional contact block on the back of these contact blocks.

(3) It is not possible to fit an additional contact block on the back of these contact blocks or to use these contacts with light blocks.

(4) This legend holder is not compatible with high power switching contacts.

# Harmony™ XB4 metal 22 mm push buttons

Light blocks  
“Test light” - Protection

To combine with heads, see page 30

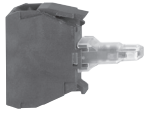

ZBVB●

Light blocks with screw clamp terminal connections (Schneider Electric anti-retightening system)					
Description	Supply voltage V	Color of light source	Sold in lots of	Unit reference	Weight kg
<b>Integral LED</b> (to combine with heads for integral LED)	~ 12 (50/60 Hz)	White	5	ZBVJ1	0.017
		Green	5	ZBVJ3	0.017
		Red	5	ZBVJ4	0.017
		Orange	5	ZBVJ5	0.017
		Blue	5	ZBVJ6	0.017
		~ 24 (50/60 Hz)	White	5	ZBVB1
Green	5		ZBVB3	0.017	
Red	5		ZBVB4	0.017	
Orange	5		ZBVB5	0.017	
Blue	5		ZBVB6	0.017	
~ 24 to 120 (50/60 Hz)	White		5	ZBVBG1	0.017
	Green	5	ZBVBG3	0.017	
	Red	5	ZBVBG4	0.017	
	Orange	5	ZBVBG5	0.017	
	Blue	5	ZBVBG6	0.017	
	~ 110 to 120 (50/60 Hz)	White	5	ZBVG1	0.017
Green		5	ZBVG3	0.017	
Red		5	ZBVG4	0.017	
Orange		5	ZBVG5	0.017	
Blue		5	ZBVG6	0.017	
~ 230 to 240 (50/60 Hz)		White	5	ZBVM1	0.017
	Green	5	ZBVM3	0.017	
	Red	5	ZBVM4	0.017	
	Orange	5	ZBVM5	0.017	
	Blue	5	ZBVM6	0.017	

Flashing light blocks with screw clamp terminal connections (Schneider Electric anti-retightening system)					
Description	Supply voltage V	Color of light source	Sold in lots of	Unit reference	Weight kg
<b>Integral LED</b> (to combine with heads for integral LED)	~ 24 (50/60 Hz)	White	5	ZBV18B1	0.017
		Green	5	ZBV18B3	0.017
		Red	5	ZBV18B4	0.017
		Orange	5	ZBV18B5	0.017
		Blue	5	ZBV18B6	0.017
		~ 110 to 120 (50/60 Hz)	White	5	ZBV18G1
Green	5		ZBV18G3	0.017	
Red	5		ZBV18G4	0.017	
Orange	5		ZBV18G5	0.017	
Blue	5		ZBV18G6	0.017	
~ 230 to 240 (50/60 Hz)	White		5	ZBV18M1	0.017
	Green	5	ZBV18M3	0.017	
	Red	5	ZBV18M4	0.017	
	Orange	5	ZBV18M5	0.017	
	Blue	5	ZBV18M6	0.017	

Transformer blocks for 24 V light blocks				
For use with	Supply voltage V	Description	Reference	Weight kg
Light blocks with integral LED	~ 400 V - 50 Hz	Transformer 400 V - 24 V ~	ZBV5B (1)	0.090

Light blocks for “remote test” function				
Light blocks	Supply voltage V	Description	Reference	Weight kg
Light blocks with integral LED	~ 12 and 24 ~ 24 to 120	Single module, 1 connecting wire	ZBZG156 (2)	0.010
Light blocks with integral LED	~ 48 to 230	Double module, with connecting wires	ZBZM156 (3)	0.010

LED suppressors				
For use with	Supply voltage V	Level of protection	Reference	Weight kg
Light blocks with integral LED fitted with screw clamp terminal connections	~ 120	25 to 120 VA	ZBZVG	0.010
	~ 230	30 to 230 VA	ZBZVM	0.010

(1) To order ~ 440 to 460 V - 60 Hz transformer blocks, please replace "5" in the reference by "8": ZBV 5B becomes ZBV 8B. To order ~ 550 to 600 V - 60 Hz transformer blocks, please replace "5" by "9": ZBV 5B becomes ZBV 9B.  
 (2) Block for use with ~ light blocks with integral LED types ZBVJ●, ZBVB●, ZBVBG● or with direct supply light block for BA 9s bulb, ZBV6.  
 (3) Block for use ~ light blocks integral LED types ZBVG●, ZBVM●, see connection on page 72.



ZBV 5B



ZBZG156



ZBZM156



ZBZV●

# Harmony™ XB4 metal 22 mm push buttons

Body/contact assemblies  
Spring clamp terminal connections

To combine with heads, see pages 26 to 47



ZB4BZ009

Body/mounting collar				
For use with	Sold in lots of	Unit reference	Weight kg	
Electrical block (contact or light)	10	ZB4BZ009	0.038	



ZBE 1015

Contact functions						
Spring clamp terminal connections (1)						
Contacts for standard applications						
Description	Type of contact	Terminal connection		Sold in lots of	Unit reference	Weight kg
		N/O	N/C			
Contact blocks	Single	1	–	4	ZBE1015	0.011
		–	1	4	ZBE1025	0.011
Contact blocks	Single with body/mounting collar	1	–	1	ZB4BZ1015	0.053
		–	1	1	ZB4BZ1025	0.053
		2	–	1	ZB4BZ1035	0.062
		–	2	1	ZB4BZ1045	0.062
		1	1	1	ZB4BZ1055	0.062

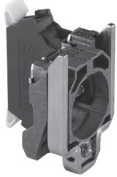

ZB4BZ1015

Light blocks					
Spring clamp terminal connections (1)					
Description	Supply voltage V	Color of light source	Sold in lots of	Unit reference	Weight kg
Integral LED (to combine with heads for integral LED)	~ 12 (50/60 Hz)	White	4	ZBVJ15	0.016
		Green	4	ZBVJ35	0.016
		Red	4	ZBVJ45	0.016
		Orange	4	ZBVJ55	0.016
		Blue	4	ZBVJ65	0.016
		Integral LED <b>protected LED</b>	~ 24 (50/60 Hz)	White	4
Green	4			ZBVB35	0.016
Red	4			ZBVB45	0.016
Orange	4			ZBVB55	0.016
Blue	4			ZBVB65	0.016
Integral LED	~ 110 to 120 (50/60 Hz)			White	4
		Green	4	ZBVG35	0.016
		Red	4	ZBVG45	0.016
		Orange	4	ZBVG55	0.016
		Blue	4	ZBVG65	0.016
		Integral LED	~ 230 to 240 (50/60 Hz)	White	4
Green	4			ZBVM35	0.016
Red	4			ZBVM45	0.016
Orange	4			ZBVM55	0.016
Blue	4			ZBVM65	0.016



ZBV B35

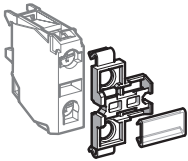

ZBZ001

Sheet of 50 blank legends				
For use with	Sold in lots of	Unit reference	Weight kg	
Legend holder ZBZ001	10	ZBY001	0.023	

(1) It is not possible to fit an additional block on the back of these contact or light blocks.

# Harmony™ XB4 metal 22 mm push buttons

## Body/contact assemblies

For printed circuit board

To combine with heads, see pages 26 to 47



ZB4BZ009

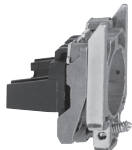

ZB4BZ079 + ZB4BZ009



ZBZ010



ZBE701



ZBE702



ZBVB7

### Body/mounting collar and accessories specifically for printed circuit board mounting (1)

#### Accessories required when using adaptor (socket) ZBZ010

Description	For use with	Sold in lots of	Unit reference	Weight kg
Body/mounting collar	Electrical block (contact or light)	10	ZB4BZ009	0.006
Mounting collar/pillar	Printed circuit board support (mounting screw ZBZ006 to be ordered separately)	10	ZB4BZ079	0.003
Mounting screw for printed circuit board	Mounting collar/pillar ZB4BZ079	10	ZBZ006	0.011

#### Adapter (socket) (1)

For use with	Thickness of printed circuit board (mm)	Sold in lots of	Unit reference	Weight kg
Electrical block (contact or light)	1.6 ± 0.2	10	ZBZ010	0.008
	2.2 ± 0.2	10	ZBZ011	0.008
	3.2 ± 0.2	10	ZBZ012	0.008

### Contact functions (1)

#### Contacts for standard applications

Description	Type of contact	Symbol		Sold in lots of	Unit reference	Weight kg
		N/O	N/C			
Contact blocks	Single	1	–	5	ZBE701	0.011
		–	1	5	ZBE702	0.011

#### Contacts for specific applications

Application	Type of contact	Symbol		Sold in lots of	Unit reference	Weight kg
		N/O	N/C			
Low power switching	Single	1	–	5	ZBE7016	0.012
		–	1	5	ZBE7026	0.012

### Light blocks (1)

Description	Supply voltage V	Color of LED	Sold in lots of	Unit reference	Weight kg
Integral LED (to combine with heads for integral LED)	≈ 24 (50/60 Hz)	White	5	ZBVB17	0.004
		Green	5	ZBVB37	0.004
		Red	5	ZBVB47	0.004
		Orange	5	ZBVB57	0.004
		Blue	5	ZBVB67	0.004





(1) For details of support drilling and of printed circuit board: see page 72

# Harmony™ XB4 metal 22 mm push buttons





Body/contact assemblies  
Faston® connectors

To combine with heads, see pages 26 to 47

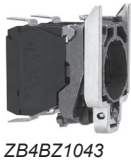
**Contact functions (1)**  
Faston connectors (6.35 or 2 x 2.8 mm) (Schneider Electric anti-retightening system)

Contacts for standard applications						
Description	Type of contact			Sold in lots of	Unit reference	Weight kg
Contact blocks	Single	1	–	5	ZBE1013	0.011
		–	1	5	ZBE1023	0.011
	Double	2	–	5	ZBE2033	0.020
		–	2	5	ZBE2043	0.020
		1	1	5	ZBE2053	0.020
	Single with body/mounting collar	1	–	1	ZB4BZ1013 (2)	0.053
		–	1	1	ZB4BZ1023 (2)	0.053
		2	–	1	ZB4BZ1033	0.062
		–	2	1	ZB4BZ1043	0.062
		1	1	1	ZB4BZ1053	0.062



Contacts for specific applications							
Application	Type of contact	Description			Sold in lots of	Unit reference	Weight kg
Low power switching	Single	Standard	1	–	5	ZBE10163 (2)	0.012
			–	1	5	ZBE10263 (2)	0.012
	Dusty environments (3) (IP5X, 50 µm dust)	1	–	5	ZBE1016P3 (2)	0.012	
		–	1	5	ZBE1026P3 (2)	0.012	
Staggered contacts	Single	Early make 	1	–	5	ZBE2013 (2)	0.011
		Late break 	–	1	5	ZBE2023 (2)	0.011
		N/C 					
High power switching	Single	Standard (4)	1	–	1	ZBE5013	0.021
			–	1	1	ZBE5023	0.021
			2	–	1	ZBE5033	0.033
			–	2	1	ZBE5043	0.033
			1	1	1	ZBE5053	0.033

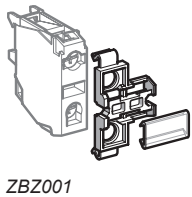

Clip-on legend holder for electrical blocks with screw clamp terminal connections (5)			
For use with	Sold in lots of	Unit reference	Weight kg
Identification of an XB4B control or signaling unit	10	ZBZ001	0.001
Sheet of 50 blank legends	10	ZBY001	0.023

(1) The contact blocks enable variable composition of body/contact assemblies. Maximum number of rows possible: 3. Either 3 rows of 3 single contacts or 1 row of 3 double contacts + 1 row of 3 single contacts (double contacts occupy the first 2 rows).  
 (2) To order products with screw clamp terminal connections for lugs, replace the 3 at the end of the reference with a 9. Example: ZBE1013 becomes ZBE1019.  
 (3) It is not possible to fit an additional contact block on the back of these contact blocks.  
 (4) It is not possible to fit an additional contact block on the back of these contact blocks or to use these contacts with light blocks.  
 (5) This legend holder is not compatible with high power switching contact blocks.



# Harmony™ XB4 metal 22 mm push buttons

Body/contact assemblies  
Plug-in connector

To combine with heads, see pages 26 to 47



ZB4BZ009



ZBE1014



ZBE1024

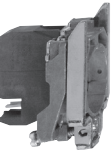

ZB4BZ1014

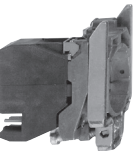

ZB4BZ1024

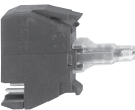

ZBVB4

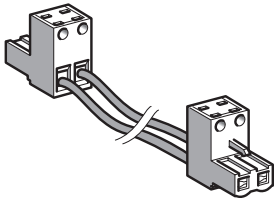

APE1C2250

### Body/mounting collar

For use with	Sold in lots of	Unit reference	Weight kg
Electrical block (contact or light)	10	ZB4BZ009	0.038

### Contact functions Plug-in connector (1)

#### Contacts for standard applications

Description	Type of contact	Symbol		Sold in lots of	Unit reference	Weight kg
		N/O	N/C			
Contact blocks	Single	1	–	5	ZBE1014	0.011
		–	1	5	ZBE1024	0.011
Contact blocks	Single with body/mounting collar	1	–	1	ZB4BZ1014	0.050
		–	1	1	ZB4BZ1024	0.050
		2	–	1	ZB4BZ1034	0.058
		–	2	1	ZB4BZ1044	0.058
		1	1	1	ZB4BZ1054	0.058
		1	2	1	ZB4BZ1414	0.064

### Light blocks Plug-in connector

Description	Supply voltage (V)	Color of light source	Sold in lots of	Unit reference	Weight kg
Integral LED (to combine with heads for integral LED)	≈ 24 (50/60 Hz)	White	5	ZBVB14	0.016
		Green	5	ZBVB34	0.016
		Red	5	ZBVB44	0.016
		Orange	5	ZBVB54	0.016
		Blue	5	ZBVB64	0.016
		Protected LED	~ 110 to 120 (50/60 Hz)	White	5
Green	5			ZBVG34	0.016
Red	5			ZBVG44	0.016
Orange	5			ZBVG54	0.016
Blue	5			ZBVG64	0.016
Protected LED	~ 230 to 240 (50/60 Hz)			White	5
		Green	5	ZBVM34	0.016
		Red	5	ZBVM44	0.016
		Orange	5	ZBVM54	0.016
		Blue	5	ZBVM64	0.016

### Connecting cables and connector

Description	Number of connectors	Wire c.s.a. mm <sup>2</sup>	Length mm	Sold in lots of	Unit reference	Weight kg
Cables with connectors 2-pin, 5.08 mm pitch	1	0.75	500	8	APE1C2150	0.120
	2	0.75	500	8	APE1C2250	0.180
Spring terminal connector 2-pin, 5.08 mm pitch	–	0.2 to 2.5	–	10	APE1PRE21	0.003

(1) It is not possible to fit an additional contact block on the back of these contact blocks.

# Harmony™ XB4 metal 22 mm push buttons

Body/contact assemblies + light blocks  
with integral LED

To combine with heads, see pages 29 to 43; contacts, see page 48

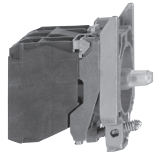

ZB4BW0...3

**Complete body/contact assemblies and light blocks (1)**  
Screw clamp terminal connections (Schneider Electric anti-retightening system)

Light source	Supply voltage	Type of contact		Color of light source	Reference	Weight
		N/O	N/C			
V						
kg						
<b>Direct supply</b>						
Integral LED <b>Protected LED</b>	~ 24 (50/60 Hz)	1	-	White	ZB4BW0B11	0.064
				Green	ZB4BW0B31	0.064
				Red	ZB4BW0B41	0.064
				Orange	ZB4BW0B51	0.064
				Blue	ZB4BW0B61	0.064
		-	1	White	ZB4BW0B12	0.064
				Green	ZB4BW0B32	0.064
				Red	ZB4BW0B42	0.064
				Orange	ZB4BW0B52	0.064
				Blue	ZB4BW0B62	0.064
	2	-	White	ZB4BW0B13	0.074	
			Green	ZB4BW0B33	0.074	
			Red	ZB4BW0B43	0.074	
			Orange	ZB4BW0B53	0.074	
			Blue	ZB4BW0B63	0.074	
	1	1	White	ZB4BW0B15	0.074	
			Green	ZB4BW0B35	0.074	
			Red	ZB4BW0B45	0.074	
			Orange	ZB4BW0B55	0.074	
			Blue	ZB4BW0B65	0.074	
~ 110 to 120 (50/60 Hz)	1	-	White	ZB4BW0G11	0.064	
			Green	ZB4BW0G31	0.064	
			Red	ZB4BW0G41	0.064	
			Orange	ZB4BW0G51	0.064	
			Blue	ZB4BW0G61	0.064	
	-	1	White	ZB4BW0G12	0.064	
			Green	ZB4BW0G32	0.064	
			Red	ZB4BW0G42	0.064	
			Orange	ZB4BW0G52	0.064	
			Blue	ZB4BW0G62	0.064	
2	-	White	ZB4BW0G13	0.074		
		Green	ZB4BW0G33	0.074		
		Red	ZB4BW0G43	0.074		
		Orange	ZB4BW0G53	0.074		
		Blue	ZB4BW0G63	0.074		
1	1	White	ZB4BW0G15	0.074		
		Green	ZB4BW0G35	0.074		
		Red	ZB4BW0G45	0.074		
		Orange	ZB4BW0G55	0.074		
		Blue	ZB4BW0G65	0.074		



**Other versions** Complete bodies with Faston® connector terminals (6.35 or 2 x 2.8).  
Please consult your Regional Sales Office.

(1) Can be fitted with additional contact blocks: see page 48.

# Harmony™ XB4 metal 22 mm push buttons

Body/contact assemblies + light blocks  
with integral LED

To combine with heads, see pages 29 to 43; contacts, see page 48

Complete body/contact assemblies and light blocks (1) (continued)						
Screw clamp terminal connections (Schneider Electric anti-retightening system)						
Light source	Supply voltage	Type of contact		Color of light source	Reference	Weight
	V					kg
		N/O	N/C			
<b>Direct supply (continued)</b>						
Integral LED <b>Protected LED</b>	~ 230 to 240 (50/60 Hz)	1	–	White	ZB4BW0M11	0.064
				Green	ZB4BW0M31	0.064
				Red	ZB4BW0M41	0.064
				Orange	ZB4BW0M51	0.064
				Blue	ZB4BW0M61	0.064
	–	1	–	White	ZB4BW0M12	0.064
				Green	ZB4BW0M32	0.064
				Red	ZB4BW0M42	0.064
				Orange	ZB4BW0M52	0.064
				Blue	ZB4BW0M62	0.064
	2	–	–	White	ZB4BW0M13	0.074
				Green	ZB4BW0M33	0.074
				Red	ZB4BW0M43	0.074
				Orange	ZB4BW0M53	0.074
				Blue	ZB4BW0M63	0.074
	1	1	1	White	ZB4BW0M15	0.074
				Green	ZB4BW0M35	0.074
				Red	ZB4BW0M45	0.074
				Orange	ZB4BW0M55	0.074
				Blue	ZB4BW0M65	0.074

**Other versions** Complete bodies with Faston® connector terminals (6.35 or 2 x 2.8).  
Please consult your Regional Sales Office.

(1) Can be fitted with additional contact blocks: see page 48.

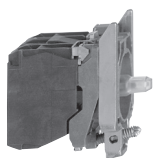

ZB4BW0M11

# Harmony™ XB4 metal 22 mm push buttons

Body/light assemblies for pilot lights  
with integral LED

To combine with heads, see page 44; contacts, see page 48

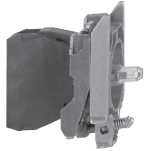

ZB4BV●●

Protected  
LED

Complete light bodies (mounting collar + light block with integral LED)				
Screw clamp terminal connections (Schneider Electric anti-retightening system)				
Light source	Supply voltage V	Color of light source	Reference	Weight kg
Integral LED	≈ 12 (50/60 Hz)	White	ZB4BVJ1	0.054
		Green	ZB4BVJ3	0.054
		Red	ZB4BVJ4	0.054
		Orange	ZB4BVJ5	0.054
		Blue	ZB4BVJ6	0.054
		White	ZB4BVB1	0.054
	≈ 24 (1) (50/60 Hz)	Green	ZB4BVB3	0.054
		Red	ZB4BVB4	0.054
		Orange	ZB4BVB5	0.054
		Blue	ZB4BVB6	0.054
		≈ 24 to 120 (50/60 Hz)	White	ZB4BVBG1
	Green		ZB4BVBG3	0.054
	Red		ZB4BVBG4	0.054
	Orange		ZB4BVBG5	0.054
	Blue		ZB4BVBG6	0.054
	≈ 110 to 120 (1) (50/60 Hz)	White	ZB4BVG1	0.054
		Green	ZB4BVG3	0.054
		Red	ZB4BVG4	0.054
Orange		ZB4BVG5	0.054	
Blue		ZB4BVG6	0.054	
≈ 230 to 240 (1) (50/60 Hz)	White	ZB4BVM1	0.054	
	Green	ZB4BVM3	0.054	
	Red	ZB4BVM4	0.054	
	Orange	ZB4BVM5	0.054	
	Blue	ZB4BVM6	0.054	

(1) Complete bodies with Faston® connector terminals (6.35 or 2 x 2.8), see page 52.

# Harmony™ XB4 metal 22 mm push buttons

Body/light assemblies for pilot lights  
with integral LED

To combine with heads, see page 44; contacts, see page 48

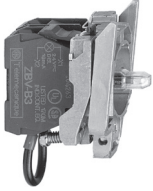

ZB4BVB●156

**Complete light bodies with 3-terminal “remote test” function**  
(mounting collar + light block with integral LED + pre-wired block for “remote test light” function)  
**Screw clamp terminal connections** (Schneider Electric anti-retightening system)

Light source	Supply voltage V	Color of light source	Reference	Weight kg
Integral LED <b>Protected LED</b>	≈ 24 (1) (50/60 Hz)	White	ZB4BVB1156	0.054
		Green	ZB4BVB3156	0.054
		Red	ZB4BVB4156	0.054
		Orange	ZB4BVB5156	0.054
		Blue	ZB4BVB6156	0.054

**Complete bodies with flashing pilot light** (mounting collar + light block with integral LED)  
**Screw clamp terminal connections** (Schneider Electric anti-retightening system)



Light source	Supply voltage V	Color of light source	Reference	Weight kg
Integral LED <b>Protected LED</b>	≈ 24 (50/60 Hz)	White	ZB4BV18B1	0.054
		Green	ZB4BV18B3	0.054
		Red	ZB4BV18B4	0.054
		Orange	ZB4BV18B5	0.054
		Blue	ZB4BV18B6	0.054
		Blue	ZB4BV18B6	0.054
	≈ 110 to 120 (50/60 Hz)	White	ZB4BV18G1	0.054
		Green	ZB4BV18G3	0.054
		Red	ZB4BV18G4	0.054
		Orange	ZB4BV18G5	0.054
		Blue	ZB4BV18G6	0.054
		Blue	ZB4BV18G6	0.054
	≈ 230 to 240 (50/60 Hz)	White	ZB4BV18M1	0.054
		Green	ZB4BV18M3	0.054
		Red	ZB4BV18M4	0.054
Orange		ZB4BV18M5	0.054	
Blue		ZB4BV18M6	0.054	
Blue		ZB4BV18M6	0.054	

(1) For a ~ 120 or 230 V supply, use complete body ZB4BVG● or ZB4BVM● with block for “remote test light” function type ZBZM156, see pages 44 and 49.

# Harmony™ XB4 metal 22 mm push buttons

Body/contact assemblies + light blocks  
with BA 9s base fitting

To combine with heads, see page 31; contacts, see page 48

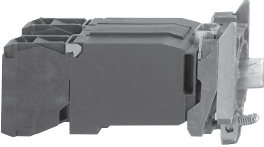
Complete body/contact assemblies and light blocks <sup>(1)</sup>								
For bulb with BA 9s base fitting (incandescent, neon or LED)								
Screw clamp terminal connections (Schneider Electric anti-retightening system)								
Light source	Supply voltage	Type of contact		Color of light source	Reference	Weight		
								
	V	N/O	N/C			kg		
<b>Direct supply</b>								
 ZB4BW06●	BA9s base fitting bulb, 2.4 W max, not included <sup>(2)</sup>	≤ 250	1	–	–	ZB4BW061	0.063	
			–	1	–	–	ZB4BW062	0.063
			2	–	–	–	ZB4BW063	0.073
			1	1	–	–	ZB4BW065	0.073
<b>Supply via integral transformer (1.2 VA, 6 V secondary)</b>								
 ZB4BW05●	BA9s base fitting incandescent bulb, included	~ 110 to 120 50/60 Hz	1	–	–	ZB4BW031	0.141	
			1	1	–	ZB4BW035	0.151	
		~ 230 50 Hz	1	–	–	ZB4BW041	0.141	
		~ 220 to 240 60 Hz	1	1	–	ZB4BW045	0.151	
		~ 400 50 Hz	1	–	–	ZB4BW051	0.141	
			1	1	–	ZB4BW055	0.151	
	BA9s base fitting LED, included	~ 110 to 120 50/60 Hz	1	1	White	ZB4BW03D15	0.151	
					Green	ZB4BW03D35	0.151	
					Red	ZB4BW03D45	0.151	
					Orange	ZB4BW03D55	0.151	
Blue					ZB4BW03D65	0.151		
~ 230 50 Hz ~ 220 to 240 60 Hz		1	1	White	ZB4BW04D15	0.151		
				Green	ZB4BW04D35	0.151		
				Red	ZB4BW04D45	0.151		
				Orange	ZB4BW04D55	0.151		
				Blue	ZB4BW04D65	0.151		
~ 400 50/60 Hz		1	1	White	ZB4BW05D15	0.152		
				Green	ZB4BW05D35	0.152		
	Red			ZB4BW05D45	0.152			
	Orange			ZB4BW05D55	0.152			
			Blue	ZB4BW05D65	0.152			

**Other versions** Complete bodies with integral transformer incorporating Faston® connector terminals (6.35 or 2 x 2.8). Please consult your Regional Sales Office.

<sup>(1)</sup> Can be fitted with additional contact blocks: see page 48.  
<sup>(2)</sup> Bulb to be ordered separately: see page 68.



# Harmony™ XB4 metal 22 mm push buttons

Light bodies for pilot lights  
with BA 9s base fitting

To combine with heads, see page 45; contacts, see page 48

**Light blocks**  
**Screw clamp terminal connections (Schneider Electric anti-retightening system)**

Description	Supply voltage V	Sold in lots of	Unit reference	Weight kg
Direct supply for BA 9s base fitting bulb, 2.4 W max., not included (1)	≤ 250	5	ZBV6	0.016

**Complete light bodies (mounting collar + light block )**  
**For bulb with BA 9s base fitting (incandescent, neon or LED)**  
**Screw clamp terminal connections (Schneider Electric anti-retightening system)**

Light source	Supply voltage V	Color of light source	Reference	Weight kg
--------------	---------------------	--------------------------	-----------	--------------

**Direct supply**

BA 9s base fitting bulb, 2.4 W max, not included (1)	≤ 250	–	ZB4BV6	0.052
--	-------	---	--------	-------

**Supply via integral transformer (1.2 VA, 6 V secondary)**

BA 9s base fitting incandescent bulb, included	~ 110 to 120 -50/60 Hz	–	ZB4BV3	0.130
	~ 230 - 50 Hz	–	ZB4BV4	0.130
	~ 220 to 240 - 60 Hz	–	ZB4BV5	0.131
	~ 400 - 50 Hz	–	ZB4BV5	0.131
	~ 440 to 480 - 60 Hz	–	ZB4BV8	0.128
	~ 550 to 600 - 60 Hz	–	ZB4BV9	0.131

BA 9s base fitting LED, included	~ 110 to 120 - 50/60 Hz	White	ZB4BV3D1	0.134
		Green	ZB4BV3D3	0.134
		Red	ZB4BV3D4	0.134
		Orange	ZB4BV3D5	0.134
		Blue	ZB4BV3D6	0.134

	~ 230 - 50 Hz ~ 220 to 240 - 60 Hz	White	ZB4BV4D1	0.134
		Green	ZB4BV4D3	0.134
		Red	ZB4BV4D4	0.134
		Orange	ZB4BV4D5	0.134
		Blue	ZB4BV4D6	0.134

	~ 400 - 50/60 Hz	White	ZB4BV5D1	0.134
		Green	ZB4BV5D3	0.134
		Red	ZB4BV5D4	0.134
		Orange	ZB4BV5D5	0.134
		Blue	ZB4BV5D6	0.134

**Complete light bodies with 3-terminal “remote test” function (mounting collar + light block)**  
**For bulb with BA 9s base fitting (incandescent, neon or LED)**  
**Screw clamp terminal connections (Schneider Electric anti-retightening system)**

**Direct supply**

BA 9s base fitting bulb, 2.4 W max, not included (1)	≤ 250	–	ZB4BV156	0.062
--	-------	---	----------	-------

(1) Bulb to be ordered separately, see page 70.

**Other versions** Complete bodies with Faston® connector terminals (6.35 or 2 x 2.8), see page 49.

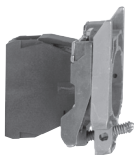

ZB4BV6

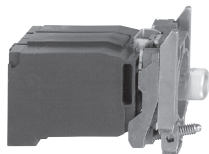

ZB4BV●

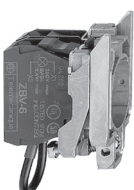

ZB4BV156

# Harmony™ XB4 metal 22 mm push buttons

## Accessories for heads

### Caps



ZBA●



ZBL●



ZBA●33

#### Push button caps - unmarked

For use with	Type of push	Color	Sold in lots of	Unit reference	Weight kg
ZB4BA0 push button heads supplied without cap	Flush	White	10	ZBA1	0.001
		Black	10	ZBA2	0.001
		Green	10	ZBA3	0.001
		Red	10	ZBA4	0.001
		Yellow	10	ZBA5	0.001
		Blue	10	ZBA6	0.001
		6 colors (1)	1	ZBA9	0.006
	Projecting	White	10	ZBL1	0.001
		Black	10	ZBL2	0.001
		Green	10	ZBL3	0.001
		Red	10	ZBL4	0.001
		Yellow	10	ZBL5	0.001
		Blue	10	ZBL6	0.001
	6 colors (1)	1	ZBL9	0.006	

#### Push button caps - marked

For use with	Type of push	Marking		Color of cap	Unit reference	Weight kg
		Text	Color			
ZB4BA0 push button heads supplied without cap (sold in lots of 10)	Flush	I (2)	White	Green	ZBA331	0.001
			Black	White	ZBA131	0.001
		II	White	Green	ZBA336	0.001
			Black	White	ZBA136	0.001
		III	White	Green	ZBA337	0.001
			Black	White	ZBA137	0.001
		IV	White	Green	ZBA338	0.001
			Black	White	ZBA138	0.001
		START (2)	White	Green	ZBA333	0.001
			Black	White	ZBA133	0.001
		ON	White	Green	ZBA341	0.001
			Black	White	ZBA141	0.001
		UP (2)	Black	White	ZBA343	0.001
		DOWN (2)	White	Black	ZBA344	0.001
		⊕ (2)	White	Black	ZBA245	0.001
			Black	White	ZBA145	0.001
		↑ (3)	White	Black	ZBA335	0.001
			Black	White	ZBA334	0.001
		O (2)	White	Red	ZBA432	0.001
				Black	ZBA232	0.001
		STOP (2)	White	Red	ZBA434	0.001
				Black	ZBA234	0.001
		OFF	White	Red	ZBA435	0.001
				Black	ZBA235	0.001
		◇	White	Green	ZBA346	0.001
		R (2)	White	Blue	ZBA639	0.001
		+	White	Black	ZBA2934	0.001
		-	White	Black	ZBA2935	0.001

(1) Set of 6 different colored caps: white, black, green, red, yellow, blue.

(2) Double injection molded marking.

(3) Can be clipped-in at 90° steps, through 360°

# Harmony™ XB4 metal 22 mm push buttons

Accessories for heads  
Boots, lens caps



ZBP0

## Transparent boots for push buttons (1)

Description	For use with push button types	Sold in lots of	Unit reference	Weight kg
Single boots	Flush with circular head	10	ZBPA	0.002
	Projecting with circular head	10	ZBP0	0.002
	Flush or projecting with circular head for food industry applications	10	ZBP0A	0.002

## Colored boots

Description	Color	Sold in lots of	Unit reference	Weight kg
Colored boots (can be replaced without dismantling the head)	Black	10	ZB2BP012	0.003
	Green	10	ZB2BP013	0.003
	Red	10	ZB2BP014	0.003
	Yellow	10	ZB2BP015	0.003
	Blue	10	ZB2BP016	0.003

## Lens caps

For use with	Color	Sold in lots of	Unit reference	Weight kg
<b>Lens caps for light sources with integral LED</b>				
Pilot lights	White	10	ZBV0113	0.002
	Green	10	ZBV0133	0.002
	Red	10	ZBV0143	0.002
	Orange	10	ZBV0153	0.002
	Blue	10	ZBV0163	0.002
	5 different colored grooved lenses (2)	5	ZBV0103S	0.010
Illuminated push buttons, with flush push	White	10	ZBW9113	0.002
	Green	10	ZBW9133	0.002
	Red	10	ZBW9143	0.002
	Orange	10	ZBW9153	0.002
	Blue	10	ZBW9163	0.002
Illuminated push buttons, with projecting push	White	10	ZBW9313	0.002
	Green	10	ZBW9333	0.002
	Red	10	ZBW9343	0.002
	Orange	10	ZBW9353	0.002
	Blue	10	ZBW9363	0.002
<b>Lens caps for light sources with BA 9s base fitting</b>				
Pilot lights	White	10	ZBV011	0.002
	Green	10	ZBV013	0.002
	Red	10	ZBV014	0.002
	Orange	10	ZBV015	0.002
	Blue	10	ZBV016	0.002
	Clear	10	ZBV017	0.002
	Push buttons, illuminated, with flush push	White	10	ZBW911
Green		10	ZBW913	0.002
Red		10	ZBW914	0.002
Orange		10	ZBW915	0.002
Blue		10	ZBW916	0.002
Clear		10	ZBW917	0.002
Push buttons, illuminated, with projecting push	White	10	ZBW931	0.002
	Green	10	ZBW933	0.002
	Red	10	ZBW934	0.002
	Orange	10	ZBW935	0.002
	Blue	10	ZBW936	0.002
	Clear	10	ZBW937	0.002



ZBV01●3



ZBV01●

(1) Boots for multiple-headed push buttons: see page 33

(2) Clear, green, red, orange, blue.

# Harmony™ XB4 metal 22 mm push buttons

8 x 27 mm legends with  
30 x 40 mm legend holders



ZBZ34



ZBY•H101

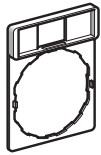

ZBZ32

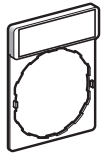

ZBY•101

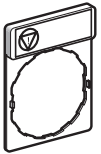

ZBY4140

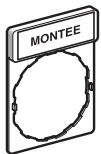

ZBY2107

### 30 x 40 mm legend holders (flush mounting with bezel) for 8 x 27 mm legends <sup>(1)</sup>

Description	Legend Color	Marking	Sold in lots of	Unit reference	Weight kg
Without legend	–	–	10	ZBZ34	0.003
With blank legend	Black or red background	–	10	ZBY2H101	0.004
	White or yellow background	–	10	ZBY4H101	0.004

### Standard (30 x 40 mm) legend holders for 8 x 27 mm legends <sup>(1)</sup>

Description	Legend Color	Marking	Sold in lots of	Unit reference	Weight kg		
Without legend	–	–	10	ZBZ32	0.001		
With blank legend (for engraving)	Black or red background	–	10	ZBY2101	0.002		
	White or yellow background	–	10	ZBY4101	0.002		
With 8 x 27 mm legend (with International marking)	Black or red background (2)	O (black background)	1	ZBY2146	0.002		
		O (red background)	1	ZBY2931	0.002		
		I	1	ZBY2147	0.002		
		II	1	ZBY2148	0.002		
		O-I	1	ZBY2178	0.002		
		I-II	1	ZBY2179	0.002		
		I-O-II	1	ZBY2186	0.002		
		AUTO	1	ZBY2115	0.002		
		STOP	1	ZBY2304	0.002		
		Yellow background	1	ZBY4140 (3)	0.002		
		With 8 x 27 mm legend (with French language marking)	Black or red background (2)	ARRET (red backgr.)	1	ZBY2104	0.002
				ARRET (black backgr.)	1	ZBY0104	0.002
				ARRET GENERAL	1	ZBY2129	0.002
ARRET REARMEMENT	1			ZBY2133	0.002		
ARRET-MARCHE	1			ZBY2166	0.002		
ARRIERE	1			ZBY2106	0.002		
AUTO CYCLE-CYCLE	1			ZBY2198	0.002		
AUTO CYCLE-MAIN	1			ZBY2199	0.002		
AUTO-MAIN	1			ZBY2164	0.002		
AUTO-O-MAIN	1			ZBY2185	0.002		
AVANT	1			ZBY2105	0.002		
AVANT-O-ARRIERE	1			ZBY2184	0.002		
C-P-C-NORMAL	1			ZBY2165	0.002		
CYCLE-MAIN	1			ZBY2197	0.002		
DECLENCHEMENT	1			ZBY2132	0.002		
DEFAUT (black backgr.)	1			ZBY2134	0.002		
DEFAUT (red backgr.)	1			ZBY2135	0.002		
DEPART CYCLE	1			ZBY2195	0.002		
DESCENTE	1			ZBY2108	0.002		
DROITE	1			ZBY2109	0.002		
ENCLENCHEMENT	1			ZBY2131	0.002		
EN SERVICE	1			ZBY2111	0.002		
FERMETURE	1			ZBY2114	0.002		
GAUCHE	1			ZBY2110	0.002		
HORS SERVICE	1			ZBY2112	0.002		
HORS-EN	1			ZBY2167	0.002		
LENT	1			ZBY2127	0.002		
MAIN	1	ZBY2116	0.002				
MARCHE	1	ZBY2103	0.002				
MONTEE	1	ZBY2107	0.002				
OUVERTURE	1	ZBY2113	0.002				
PHASE / PHASE	1	ZBY2196	0.002				
REARMEMENT (red background)	1	ZBY2123	0.002				
REARMEMENT (black background)	1	ZBY0123	0.002				
SOUS TENSION	1	ZBY2126	0.002				
VITE	1	ZBY2128	0.002				
Red background	ARRET D'URGENCE	1	ZBY2130 (3)	0.002			

(1) For legends, see pages 64 to 66.

(2) "Start" functions: white letters on black background. "Stop" functions: white letters on red background (unless otherwise specified above).

(3) For complying with ISO 13850:2006 standard, paragraph 4.4.6., Emergency Stop function logo  has been added.

# Harmony™ XB4 metal 22 mm push buttons

8 x 27 mm legends with  
30 x 40 mm legend holders

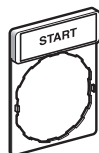

ZBY2303

## Standard (30 x 40 mm) legend holders with 8 x 27 mm legends (continued)

Description	Legend Color	Marking	Reference	Weight kg		
<b>With legend</b> (with English language marking)	Black or red background (1)	AUTO-HAND	ZBY2364	0.002		
		AUTO-O-HAND	ZBY2385	0.002		
		CLOSE	ZBY2314	0.002		
		DOWN	ZBY2308	0.002		
		FAST	ZBY2328	0.002		
		FORWARD	ZBY2305	0.002		
		HAND	ZBY2316	0.002		
		HAND-OFF-AUTO	ZBY2387	0.002		
		INCH	ZBY2321	0.002		
		LEFT	ZBY2310	0.002		
		OFF	ZBY2312	0.002		
		OFF-ON	ZBY2367	0.002		
		ON	ZBY2311	0.002		
		OPEN	ZBY2313	0.002		
		POWER ON	ZBY2326	0.002		
		RESET (red background)	ZBY2323	0.002		
		RESET (black background)	ZBY2322	0.002		
		REVERSE	ZBY2306	0.002		
		RIGHT	ZBY2309	0.002		
		RUN	ZBY2334	0.002		
		SLOW	ZBY2327	0.002		
		START	ZBY2303	0.002		
		STOP-START	ZBY2366	0.002		
		UP	ZBY2307	0.002		
			Red background	EMERGENCY STOP	ZBY2330 (2)	0.002
		<b>With legend</b> (with German language marking)	Black or red background (1)	AB	ZBY2208	0.002
				AUF	ZBY2207	0.002
AUS	ZBY2204			0.002		
AUS-EIN	ZBY2266			0.002		
AUS-IN BETRIEB	ZBY2267			0.002		
AUS-RÜCKSTELLUNG	ZBY2233			0.002		
AUSSCHALTEN	ZBY2232			0.002		
AUTO-HAND	ZBY2364			0.002		
AUTO-O-HAND	ZBY2385			0.002		
AUTOZYKL-HAND	ZBY2299			0.002		
AUTOZYKL- 1 ZYKL	ZBY2298			0.002		
C-P-C-NORMAL	ZBY2265			0.002		
EIN	ZBY2203			0.002		
EINSCHALTEN	ZBY2231			0.002		
HAND	ZBY2316			0.002		
LANGSAM	ZBY2227			0.002		
LINKS	ZBY2210			0.002		
NOT-AUS (red background)	ZBY2230			0.002		
ÖFFNEN	ZBY2213			0.002		
RECHTS	ZBY2209			0.002		
RÜCKSTELLUNG	ZBY2223			0.002		
SCHLIESSEN	ZBY2214			0.002		
SCHNELL	ZBY2228			0.002		
SPANNUNG EIN	ZBY2226			0.002		
STEUERUNG AUS	ZBY2212			0.002		
STEUERUNG EIN	ZBY2211			0.002		
STÖRUNG (black background)	ZBY2234			0.002		
STÖRUNG (red background)	ZBY2235			0.002		
VOR	ZBY2205			0.002		
VOR-O-ZURÜCK	ZBY2284			0.002		
ZURÜCK	ZBY2206			0.002		
ZYKLUS-HAND	ZBY2297			0.002		
ZYKLUSSTART	ZBY2295			0.002		
	Red background	NOT-HALT	ZBY2229 (2)	0.002		
	Yellow background	NOT-HALT	ZBY22420001 (2)	0.002		

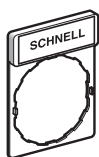

ZBY2228

(1) "Start" functions: white letters on black background. "Stop" functions: white letters on red background (unless otherwise specified above).  
(2) For complying with ISO 13850:2006 standard, paragraph 4.4.6., Emergency Stop function logo (E) has been added.

# Harmony™ XB4 metal 22 mm push buttons 8 x 27 mm legends

8 x 27 mm marked legends (for 30 x 40 mm legend holders ZBZ32 and ZBZ34)						
Language	Color of background	Marking	Reference	Weight kg		
Without	White or yellow	–	ZBY0102	0.001		
International	Black or red (1)	O (black background)	ZBY02146	0.001		
		O (red background)	ZBY02931	0.001		
		I	ZBY02147	0.001		
		II	ZBY02148	0.001		
		O-I	ZBY02178	0.001		
		I-II	ZBY02179	0.001		
		I-O-II	ZBY02186	0.001		
		AUTO	ZBY02115	0.001		
		STOP	ZBY02304	0.001		
		Red		ZBY0140 (2)	0.001	
		French	Black or red (1)	ARRET (red background)	ZBY02104	0.001
				ARRET (black background)	ZBY00104	0.001
				ARRET GENERAL	ZBY02129	0.001
ARRET REARMEMENT	ZBY02133			0.001		
ARRET-MARCHE	ZBY02166			0.001		
ARRIERE	ZBY02106			0.001		
AUTO CYCLE-CYCLE	ZBY02198			0.001		
AUTO CYCLE-MAIN	ZBY02199			0.001		
AUTO-MAIN	ZBY02164			0.001		
AUTO-O-MAIN	ZBY02185			0.001		
AVANT	ZBY02105			0.001		
AVANT-O-ARRIERE	ZBY02184			0.001		
C-P-C-NORMAL	ZBY02165			0.001		
CYCLE-MAIN	ZBY02197			0.001		
DECLENCHEMENT	ZBY02132			0.001		
DEFAUT (black background)	ZBY02134			0.001		
DEFAUT (red background)	ZBY02135			0.001		
DEPART CYCLE	ZBY02195			0.001		
DESCENTE	ZBY02108			0.001		
DROITE	ZBY02109			0.001		
ENCLANCHEMENT	ZBY02131			0.001		
EN SERVICE	ZBY02111			0.001		
FERMETURE	ZBY02114			0.001		
GAUCHE	ZBY02110			0.001		
HORS SERVICE	ZBY02112			0.001		
HORS-EN	ZBY02167			0.001		
LENT	ZBY02127			0.001		
MAIN	ZBY02116			0.001		
MARCHE	ZBY02103			0.001		
MONTEE	ZBY02107			0.001		
OUVERTURE	ZBY02113			0.001		
PHASE / PHASE	ZBY02196			0.001		
REARMEMENT (red background)	ZBY02123			0.001		
REARMEMENT (black background)	ZBY00123	0.001				
SOUS TENSION	ZBY02126	0.001				
VITE	ZBY02128	0.001				
Red	ARRET D'URGENCE	ZBY02130	0.001			

(1) "Start" functions: white letters on black background. "Stop" functions: white letters on red background (unless otherwise specified above).  
 (2) For complying with ISO 13850:2006 standard, paragraph 4.4.6., Emergency Stop function logo  has been added.



ZBY02178



ZBY0140



ZBY0104



# Harmony™ XB4 metal 22 mm push buttons 8 x 27 mm legends

## 8 x 27 mm marked legends (for 30 x 40 mm legend holders ZBZ32 and ZBZ34) (continued)

Language	Color of background	Marking	Reference	Weight kg
English	Black or red (1)	AUTO-HAND	ZBY02364	0.001
		AUTO-O-HAND	ZBY02385	0.001
		CLOSE	ZBY02314	0.001
		DOWN	ZBY02308	0.001
		EMERGENCY STOP	ZBY02330	0.001
		FAST	ZBY02328	0.001
		FORWARD	ZBY02305	0.001
		HAND	ZBY02316	0.001
		HAND-OFF-AUTO	ZBY02387	0.001
		INCH	ZBY02321	0.001
		LEFT	ZBY02310	0.001
		OFF	ZBY02312	0.001
		OFF-ON	ZBY02367	0.001
		ON	ZBY02311	0.001
		OPEN	ZBY02313	0.001
		POWER ON	ZBY02326	0.001
		RESET (red background)	ZBY02323	0.001
		RESET (black background)	ZBY02322	0.001
		REVERSE	ZBY02306	0.001
		RIGHT	ZBY02309	0.001
		RUN	ZBY02334	0.001
		SLOW	ZBY02327	0.001
		START	ZBY02303	0.001
		STOP-START	ZBY02366	0.001
UP	ZBY02307	0.001		
	Red	EMERGENCY STOP	ZBY02330 (2)	0.001
German	Black or red (1)	AB	ZBY02208	0.001
		AUF	ZBY02207	0.001
		AUS	ZBY02204	0.001
		AUS-EIN	ZBY02266	0.001
		AUS-IN BETRIEB	ZBY02267	0.001
		AUS-RÜCKSTELLUNG	ZBY02233	0.001
		AUSSCHALTEN	ZBY02232	0.001
		AUTO-HAND	ZBY02364	0.001
		AUTO-O-HAND	ZBY02385	0.001
		AUTOZYKL-HAND	ZBY02299	0.001
		AUTOZYKL- 1 ZYKL	ZBY02298	0.001
		C-P-C-NORMAL	ZBY02265	0.001
		EIN	ZBY02203	0.001
		EINSCHALTEN	ZBY02231	0.001
		HAND	ZBY02316	0.001
		LANGSAM	ZBY02227	0.001
		LINKS	ZBY02210	0.001
		NOT-AUS (red background)	ZBY02230	0.001
		ÖFFNEN	ZBY02213	0.001
		RECHTS	ZBY02209	0.001
		RÜCKSTELLUNG	ZBY02223	0.001
		SCHLIESSEN	ZBY02214	0.001
		SCHNELL	ZBY02228	0.001
		SPANNUNG EIN	ZBY02226	0.001
		STEUERUNG AUS	ZBY02212	0.001
		STEUERUNG EIN	ZBY02211	0.001
		STÖRUNG (black background)	ZBY02234	0.001
		STÖRUNG (red background)	ZBY02235	0.001
		VOR	ZBY02205	0.001
		VOR-O-ZURÜCK	ZBY02284	0.001
		ZURÜCK	ZBY02206	0.001
		ZYKLUS-HAND	ZBY02297	0.001
		ZYKLUSSTART	ZBY02295	0.001
			Red	NOT-HALT
	Yellow	NOT-HALT	ZBY022420001 (2)	0.001

## Sheets of peel-off legends (with backing board and protective transparent cover)

Description	For use with	Sold in lots of	Unit reference	Weight kg
Sheet of 76 legends 8 x 27 mm	30 x 40 mm legend holder ZBZ32 and ZBZ34	10	ZBY4100	0.043

(1) "Start" functions: white letters on black background. "Stop" functions: white letters on red background (unless otherwise specified above).

(2) For complying with ISO 13850:2006 standard, paragraph 4.4.6., Emergency Stop function logo  has been added.

START

ZBY02303

SCHNELL

ZBY02228

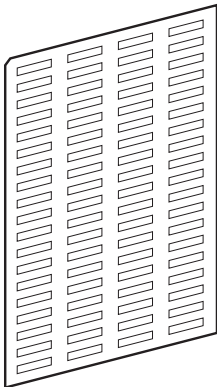

ZBY4100

# Harmony™ XB4 metal 22 mm push buttons

Legend holders for 18 x 27 mm legends  
18 x 27 mm legends for engraving or printing



ZBZ33

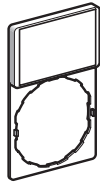

ZBY610●

### Standard (30 x 50 mm) legend holders for 18 x 27 mm legends

Description	Color of background	Sold in lots of	Unit reference	Weight kg
Without legend	–	10	ZBZ33	0.001
With blank legend	Black or red	10	ZBY6101	0.002
	White or yellow	10	ZBY6102	0.002
	Yellow	10	ZBY6140 (1)	0.002

### 30 x 50 mm legend holder (flush mounting with bezel) for 18 x 27 mm legends



ZBZ35

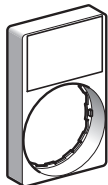

ZBY6H10●

Description	Color of background	Sold in lots of	Unit reference	Weight kg
Without legend	–	10	ZBZ35	0.003
With blank legend	Black or red	10	ZBY6H101	0.004
	White or yellow	10	ZBY6H102	0.004

### 18 x 27 mm legends for engraving (for 30 x 50 mm legend-holders)

Color	Language	Marking	Sold in lots of	Unit reference	Weight kg
Black or red background	–	Without	10	ZBY0501	0.001
White or yellow background	–	Without	10	ZBY0502	0.001
Red background	International		10	ZBY5140 (1)	0.001
	French	ARRET D'URGENCE	10	ZBY55130 (1)	0.001
	English	EMERGENCY STOP	10	ZBY55330 (1)	0.001

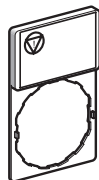

ZBY5140

### Sheets of peel-off legends 18 x 27 mm (with backing board and protective transparent cover)

Description	For use with	Sold in lots of	Unit reference	Weight kg
Sheet of 40 legends 18 x 27 mm	30 x 50 mm legend holder ZBZ33 and ZBZ35	10	ZBY5100	0.044



ZBY42101



ZBY62101

### Nameplates, 30 x 40 mm, blank

Text color	Background color	Unit reference
White	Black	ZBY42101
White	Red	ZBY44101
Black	Yellow	ZBY41101
Black	White	ZBY45101

### Nameplates, 30 x 50 mm, blank

Text color	Background color	Unit reference
White	Black	ZBY62101
White	Red	ZBY64101
Black	Yellow	ZBY61101
Black	White	ZBY65101

(1) For complying with ISO 13850:2006 standard, paragraph 4.4.6., Emergency Stop function logo has been added.

# Harmony™ XB4 metal 22 mm push buttons

Legends, for insertion, for printing, pre-printed, labelling software, circular legends

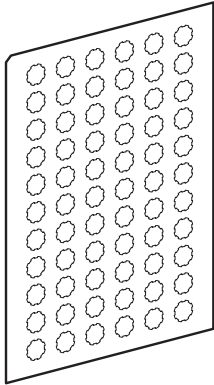

ZBY1101

Legends for XB4B push buttons, illuminated push buttons and pilot lights					
Description	Language	Marking	Sold in lots of	Unit reference	Weight kg
Sheets of 66 circular peel-off, transparent, self-adhesive legends	–	Without	10	ZBY1101	0.017
Strips of 66 circular peel-off, transparent, self-adhesive legends	International	O	10	ZBY1146	0.017
		I	10	ZBY1147	0.017
		II	10	ZBY1148	0.017
		III	10	ZBY1149	0.017
		STOP	10	ZBY1304	0.017
		†	10	ZBY1912	0.017
	French	ARRET	10	ZBY1104	0.017
		ARRIERE	10	ZBY1106	0.017
		AUTO	10	ZBY1115	0.017
		AVANT	10	ZBY1105	0.017
		DESCENTE	10	ZBY1108	0.017
		MAIN	10	ZBY1116	0.017
		MARCHE	10	ZBY1103	0.017
		MONTEE	10	ZBY1107	0.017
	English	HAND	10	ZBY1316	0.017
		OFF	10	ZBY1312	0.017
		ON	10	ZBY1311	0.017
		START	10	ZBY1303	0.017
	German	AB	10	ZBY1208	0.017
AUF		10	ZBY1207	0.017	
AUS		10	ZBY1204	0.017	
EIN		10	ZBY1203	0.017	
ZU		10	ZBY1214	0.017	

## Circular, yellow legends for mushroom head push buttons

Used for “Emergency stop” function				
Diameter mm	Conforming to standards	Marking on yellow background	Reference	Weight kg
60	EN/IEC 60204-1 and EN/ISO 13850:2006	–	ZBY9140 (1)	0.004
		ARRET D'URGENCE	ZBY9130	0.004
		EMERGENCY STOP	ZBY9330	0.004
		NOT-HALT	ZBY9230	0.004
		PARADA DE EMERGENCIA	ZBY9430	0.004
		ARRESTO DE EMERGENZA	ZBY9630	0.004
		–	ZBY8140	0.008
90	EN/IEC 60204-1 and EN/ISO 13850:2006	ARRET D'URGENCE	ZBY8130	0.008
		EMERGENCY STOP	ZBY8330	0.008
		NOT-HALT	ZBY8230	0.008
		PARADA DE EMERGENCIA	ZBY8430	0.008
		ARRESTO DE EMERGENZA	ZBY8630	0.008



ZBY9330

Used for “Emergency switching off” function				
Diameter mm	Conforming to standards	Marking on yellow background	Reference	Weight kg
60	EN/IEC 60204-1	–	ZBY9101	0.004
		COUPURE D'URGENCE	ZBY9160	0.004
		EMERGENCY SWITCHING OFF	ZBY9360	0.004
		NOT-AUS	ZBY9260	0.004
		DESCONEXION DE EMERGENCIA	ZBY9460	0.004
		INTERRUZIONE DI EMERGENZA	ZBY9660	0.004
90	EN/IEC 60204-1	–	ZBY8101	0.008
		COUPURE D'URGENCE	ZBY8160	0.008
		EMERGENCY SWITCHING OFF	ZBY8360	0.008
		NOT-AUS	ZBY8260	0.008
		DESCONEXION DE EMERGENCIA	ZBY8460	0.008
		INTERRUZIONE DI EMERGENZA	ZBY8660	0.008



ZBY9360

(1) For complying with ISO 13850:2006 standard, paragraph 4.4.6., Emergency Stop function logo  has been added.

# Harmony™ XB4 metal 22 mm push buttons

## Accessories for push buttons

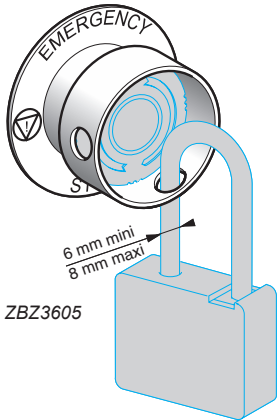

ZBZ3605



ZBY9330T



ZBY9360T

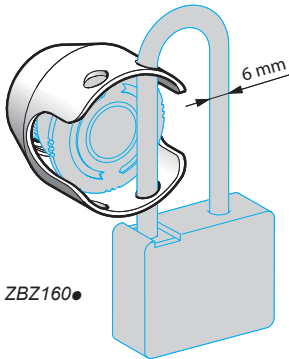

ZBZ160●

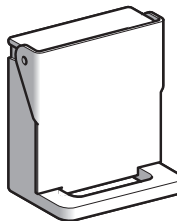

ZB4BZ64

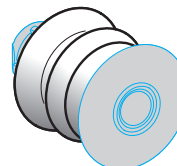

ZBZ●8

### Accessories for mushroom head push buttons

Used for "Emergency stop" (1) or "Emergency switching off" function (2)

Description	For use with	Color	Reference	Weight kg
<b>Padlocking kit (3) (4)</b> (padlockable)	Emergency stop (1) and Emergency switching off function (2), only with the following Ø 40 trigger action push buttons: XB4BS844●, XB4BS9445, ZB4BS844, ZB4BS944.	Yellow	<b>ZBZ3605</b>	0.045

Description	Marking	Color	Reference	Weight kg
Ø 60 mm legend for padlocking device <b>ZBZ3605</b> For Emergency stop function (1)	–	Yellow	<b>ZBY9140T</b>	0.004
	ARRET D'URGENCE	Yellow	<b>ZBY9130T</b>	0.004
	EMERGENCY STOP	Yellow	<b>ZBY9330T</b>	0.004
Ø 60 mm legend for padlocking device <b>ZBZ3605</b> For Emergency switching off function (2)	–	Yellow	<b>ZBY9101T</b>	0.004
	COUPURE D'URGENCE	Yellow	<b>ZBY9160T</b>	0.004
	EMERGENCY SWITCHING OFF	Yellow	<b>ZBY9360T</b>	0.004
<b>Metal guards</b> Padlockable (4)	Emergency stop function (1), only with the following Ø 40 trigger action push buttons; XB4BT845, XB4BS844●, XB4BS9445, ZB4BT84, ZB4BS844, ZB4BS944.	Chromium plated	<b>ZBZ1600</b>	0.046
		Black	<b>ZBZ1602</b>	0.046
		Red	<b>ZBZ1604</b>	0.046
		Blue	<b>ZBZ1606</b>	0.046

### Other accessories

Description	For use with	Color	Reference	Weight kg
<b>Plastic guard</b>	Selector switches and key switches	Black	<b>ZBZ2102</b>	0.005
<b>Padlockable flaps</b>	Push buttons	Black	<b>ZB4BZ62</b>	0.076
		Red	<b>ZB4BZ64</b>	0.076
		Yellow	<b>ZB4BZ65</b>	0.076
		Blue	<b>ZB4BZ66</b>	0.076

Description	Application	Material	Color	Sold in lots of	Unit reference	Weight kg
<b>Bellows seals for harsh environments (IP 69K)</b> (5)	Environments subject to humidity, dust, high-pressure cleaning etc...	Silicone	Red	2	<b>ZBZ48</b>	0.009
			Black	2	<b>ZBZ28</b>	0.009
		EPDM	2	<b>ZBZ58</b>	0.009	

(1) Ensures conformity with standards EN/IEC 60204-1 and EN/ISO 13850:2006.

(2) Ensures conformity with standard EN/IEC 60204-1.

(3) Standard circular legends are not compatible with this product. Use special legends ZBY9●●●T.

(4) No isolation function is possible when this guard is fitted.

(5) Only when mounted on control stations. Use special legends ZBY9●●●T.

# Harmony™ XB4 metal 22 mm push buttons

Accessories for push buttons



ZB5SZ3

### Other accessories (continued)

Description	For use with	Color	Sold in lots of	Unit reference	Weight kg
Metal circular blanking plug (1)	Ø 22 control and signaling units	Chromium plated	10	ZB4SZ3	0.023
		Black	10	ZB4SZ37	0.023
Black plastic circular blanking plug (with mounting nut)	Ø 22 control and signaling units	Black	10	ZB5SZ3	0.009
Liquid spray protective washer to be fitted under the head	Ø 22 control and signaling units	Chromium plated	50	ZB4BZ007	0.010
		Black	50	ZB4BZ0077	0.010
Flush mounting kit	Push button ZB4B● with head mounted flush with bezel	Chromium plated		ZB4BZ011	0.007
		Black		ZB4BZ0117	0.007

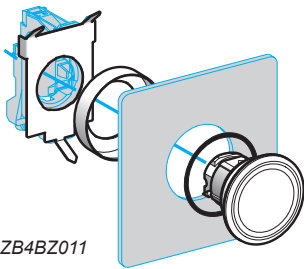

ZB4BZ011

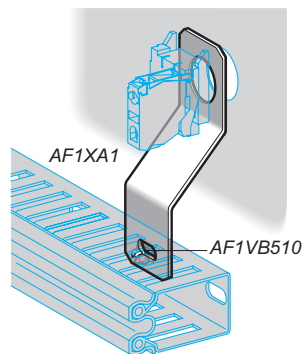

Description	Application	Sold in lots of	Unit reference	Weight kg
Cable ducting support	Mounting beneath head	10	AF1XA1	0.030
M5 x 10 screw, with hexagonal slotted head	For mounting cable ducting	100	AF1VB510	0.003
Support	For XB4B push buttons, switches and pilot lights	1	DX1AP52	0.160

(1) Body/mounting collar ZB4BZ009 required for mounting must be ordered separately, see page 51.

# Harmony™ XB4 metal 22 mm push buttons

Accessories for illuminated push buttons  
Bulbs



DL1CJ0●●●



DL1CE●●●



DL1CF●●●



XBFX13



ZBZ8

**Bulbs with BA 9s base fitting and associated accessories**

Description	Specifications	Color	Sold in lots of	Reference unit	Weight kg
LEDs	≈ 24 V	White	1	DL1CJ0241	0.002
		Green	1	DL1CJ0243	0.002
		Red	1	DL1CJ0244	0.002
		Orange	1	DL1CJ0245	0.002
		Blue	1	DL1CJ0246	0.002
	≈ 48 V	Green	1	DL1CJ0483	0.002
		Red	1	DL1CJ0484	0.002
		Orange	1	DL1CJ0485	0.002
	6 V - 1.2 W	White	1	DL1CD0061	0.002
		Green	1	DL1CD0063	0.002
Red		1	DL1CD0064	0.002	
Orange		1	DL1CD0065	0.002	
Blue		1	DL1CD0066	0.002	
Incandescent bulbs	6 V - 1.2 W	–	10	DL1CB006	0.002
	24 V - 2 W	–	10	DL1CE024	0.002
	120 to 130 V 2.4 W	–	10	DL1CE130	0.002
Neon bulbs	120 to 130 V	–	10	DL1CF110	0.002
	230 to 240 V	–	10	DL1CF220	0.002
Bulb extractor	–	–	1	XBFX13	0.005
Lens cap tightening tool	Illuminated push buttons, with flush push	–	1	ZBZ8	0.009



# Harmony™ XB4 metal 22 mm push buttons

Accessories for push buttons  
Keys

## Replacement keys

Description	Key number	Reference	Weight kg
<b>For latching mushroom head push buttons and selector switches</b>			
Sets of 2 keys	455	ZBG455	0.013
	421E	ZBG421E	0.014
	458A	ZBG458A	0.014
	520E	ZBG520E	0.014
	3131A	ZBG3131A	0.014
	4A185	ZBDA185	0.014
	LU1	ZBDLU1	0.014
	LU2	ZBDLU2	0.014
	LU3	ZBDLU3	0.014
	LU4	ZBDLU4	0.014
	LU5	ZBDLU5	0.014
	LU6	ZBDLU6	0.014
	LU7	ZBDLU7	0.014
	LU8	ZBDLU8	0.014
	LU9	ZBDLU9	0.014
	LU10	ZBDLU10	0.014
	LU11	ZBDLU11	0.014
	LU12	ZBDLU12	0.014
	LU13	ZBDLU13	0.014
	LU14	ZBDLU14	0.014
	8D1	ZBD8D1	0.014

## For booted selector switches

Sets of 2 keys, one of which supplied booted (rubber boot)	455	ZBG455P	–
	421E	ZBG421EP	–
	458A	ZBG458AP	–
	520E	ZBG520EP	–
	3131A	ZBG3131AP	–

## Accessory for key switches (1)

Description	Function	Reference	Weight kg
Keyhole cover (rubber cover)	Protection of lock barrel when no key inserted in lock	ZBGP	0.005

## Boot for standard handle

Description	For use with	Sold in lots of	Unit reference	Weight kg
Boot for standard handle	ZB4BD●●	5	ZBDD2	0.005

(1) Not compatible with products with key TEC10.



ZBG455P

# Harmony™ XB4 metal 22 mm push buttons

Push buttons, switches and pilot lights:  
complete units, XB4B

**Push buttons, spring return**

**XB4BA●●**

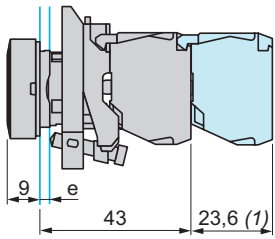

**XB4BL●●**

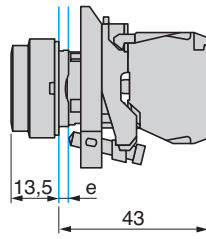

Common face view

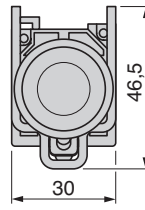

**XB4BP●●**

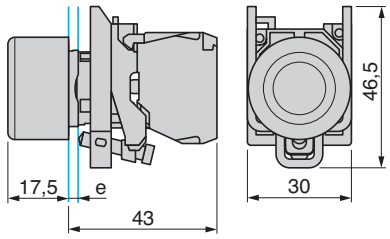

e: clamping thickness: 1 to 6 mm  
(1) Additional row of contacts or double contact.

e: clamping thickness: 1 to 6 mm

**Mushroom head push buttons, spring return**

**XB4BC21**

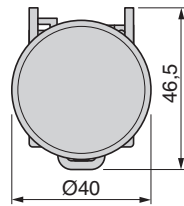
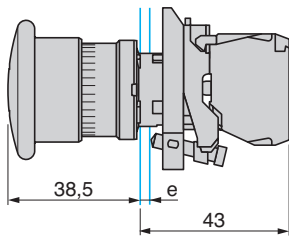

e: clamping thickness: 1 to 6 mm

**Multiple-headed push buttons (double or triple), spring return**

**XB4BL73415, XB4BW73731●5**

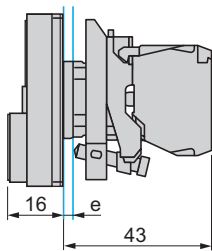

**XB4BA731327, XB4BA711237**

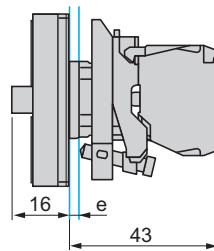

Common face view

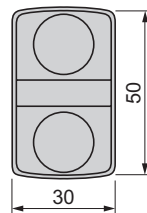

e: clamping thickness: 1 to 6 mm

**Emergency stop mushroom head push buttons, trigger action and mechanical latching**

**Push-pull**

**XB4BT845**

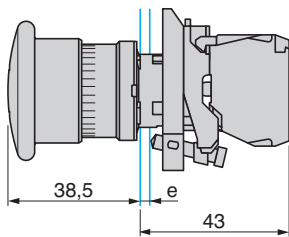

**Turn to release**

**XB4BS84441, BS8444, BS8445**

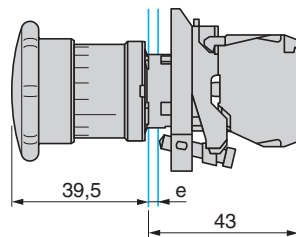

**Key release**

**XB4BS9445**

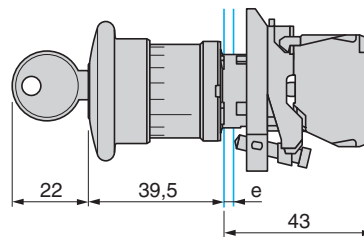

Common face view

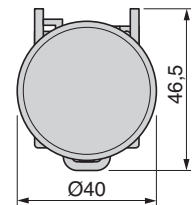

e: clamping thickness: 1 to 6 mm

e: clamping thickness: 1 to 6 mm

**Emergency switching off mushroom head push buttons, mechanical latching**

**Push-pull**

**XB4BT42**

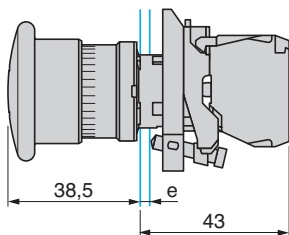

**Turn to release**

**XB4BS542**

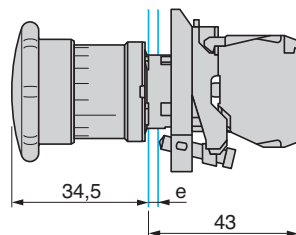

**Key release**

**XB4BS142**

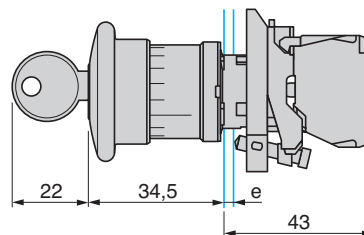

Common face view

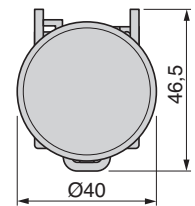

e: clamping thickness: 1 to 6 mm

e: clamping thickness: 1 to 6 mm

# Harmony™ XB4 metal 22 mm push buttons

Push buttons, switches and pilot lights:  
complete units, XB4B

## Selector switches

### Standard handle operator

XB4BD●●

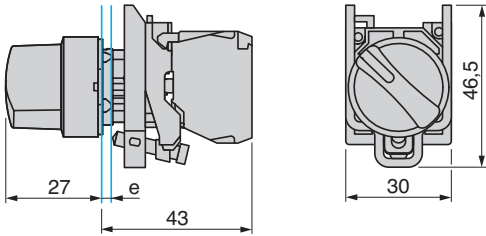

e: clamping thickness: 1 to 6 mm

### Long handle operator

XB4BJ●●

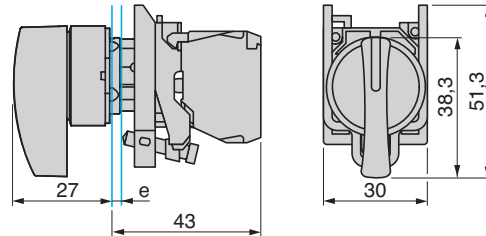

e: clamping thickness: 1 to 6 mm

## Key switches

XB4BG●●

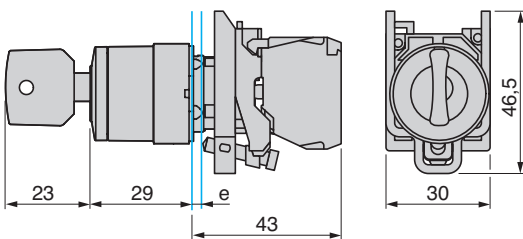

e: clamping thickness: 1 to 6 mm

# Harmony™ XB4 metal 22 mm push buttons

Push buttons, switches and pilot lights:  
complete units, XB4B

**Pilot lights**

**Integral LED**  
XB4BVB●, BVG●, BVM●

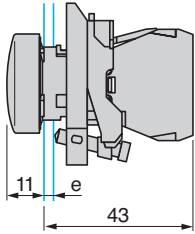

**Direct supply**  
XB4BV6●

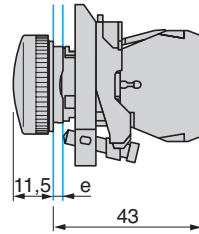

**Via integral transformer**  
XB4BV3●, BV4●

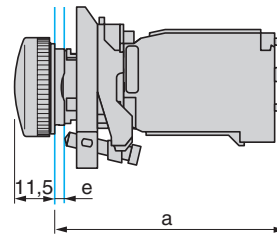

Common face view

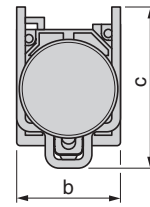

	a	b	c
XB4BV●●	66	30	46.5
XB4BV5B●	89.6	40	46.5

e: clamping thickness: 1 to 6 mm

e: clamping thickness: 1 to 6 mm

**Illuminated push buttons, spring return**

**Integral LED**  
XB4BWB3●●5

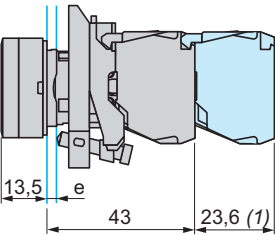

**Direct supply**  
XB4BW3●65

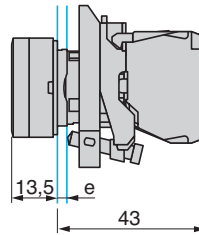

**Via integral transformer**  
XB4BW3●●5

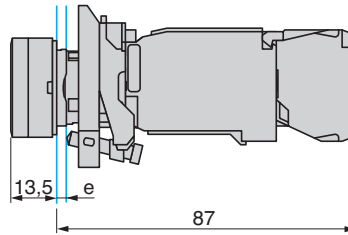

Common face view

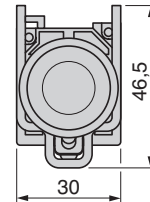

e: clamping thickness: 1 to 6 mm  
(1) Additional row of contacts or double contact

e: clamping thickness: 1 to 6 mm

**Illuminated selector switches**

**Integral LED**  
XB4BK12●●5

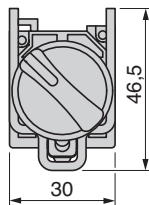
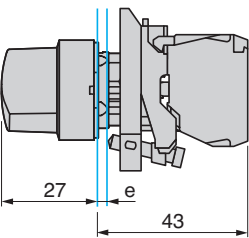

e: clamping thickness: 1 to 6 mm

e: clamping thickness: 1 to 6 mm

**Panel cut-out for push buttons, switches and pilot lights (finished holes, ready for installation)**

Connection by screw clamp terminals or plug-in connectors  
or on printed circuit board

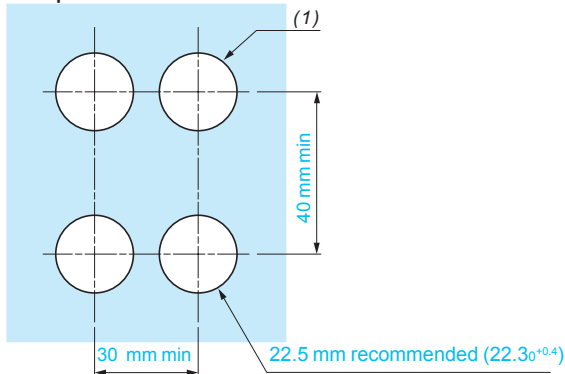

Connection by Faston® connectors

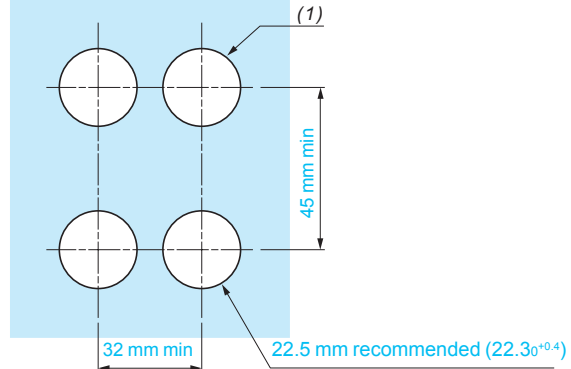

(1) Diameter on finished panel or support.

# Harmony™ XB4 metal 22 mm push buttons

Push buttons, switches and pilot lights:  
sub-assemblies, ZB4B

### Heads for spring return push buttons

ZB4BA●,  
ZB4BA●●●ZB4BA●8

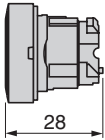

ZB4BL●, ZB4BL●●●

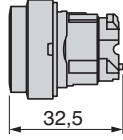

ZB4BA●4, ZB4BA●6

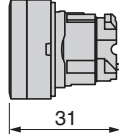

Common face view

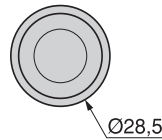

ZB4BP●●, ZB4BP●S, ZB4BP●83, ZB4BP●

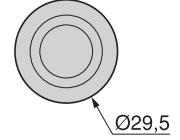
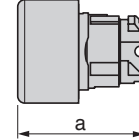

ZB4	a
BP●●	36.5
BP●S	33
BP●83	32
BP●	35

### Mushroom heads for spring return push buttons

ZB4BC●4

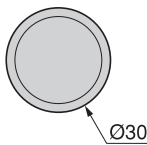
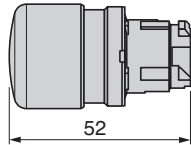

ZB4BC●, ZB4BR●

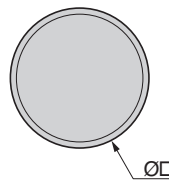
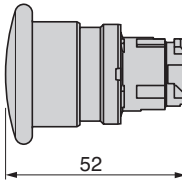

ZB4BR●16

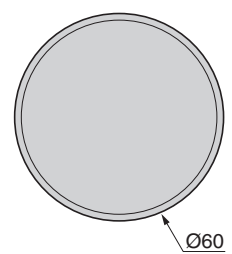
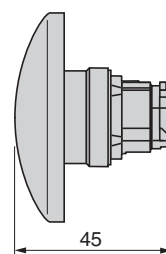

ZB4	Dia. (mm)
BC●	40
BR●	60

### Heads for double-headed, spring return push buttons

ZB4BA712●,  
ZB4BA734●,  
ZB4BA79

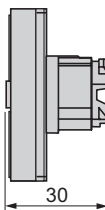

ZB4BL734●

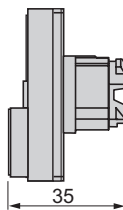

Common face view

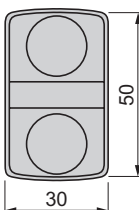

ZB4BA712●,  
ZB4BA734●,  
ZB4BA79  
+ boot ZBA708

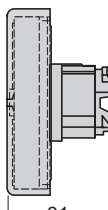

ZB4BL734●  
+ boot ZBA710

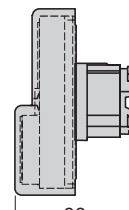

Common face view

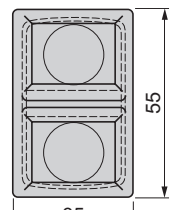

### Heads for triple-headed, spring return push buttons

ZB4BA7313●, ZB4BA711●●,  
ZB4BA72124, ZB4BA791

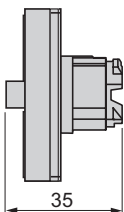

ZB4BA7313●,  
ZB4BA711●●,  
ZB4BA72124,  
ZB4BA791  
+ boot ZBA709

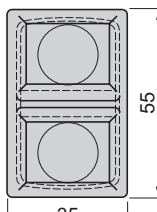
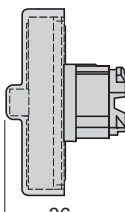
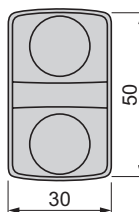

# Harmony™ XB4 metal 22 mm push buttons

Push buttons, switches and pilot lights:  
sub-assemblies, ZB4B

Mushroom heads for Emergency stop, trigger action and mechanical latching push buttons  
Mushroom heads for Emergency switching off, mechanical latching push buttons

**Push-pull**

ZB4BT84, ZB4BT4

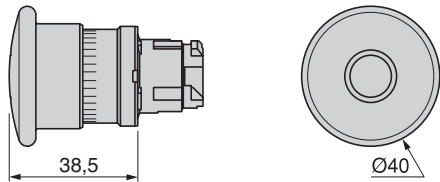

**Turn to release**

ZB4BS834, ZB4BS44

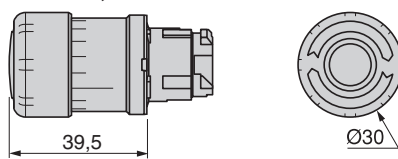

ZB4BS844, ZB4BS54

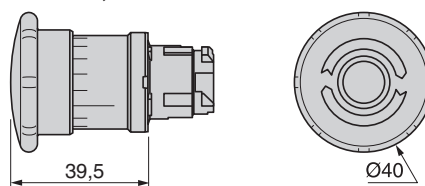

ZB4BS864, ZB4BS64

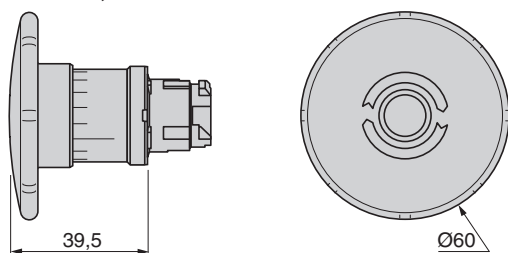

**Key release**

ZB4BS934, ZB4BS74

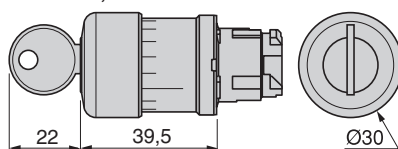

ZB4BS944, ZB4BS14

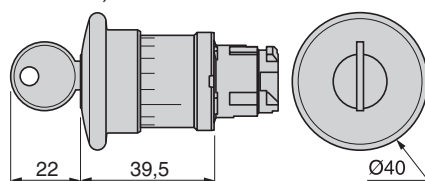

ZB4BS964, ZB4BS24

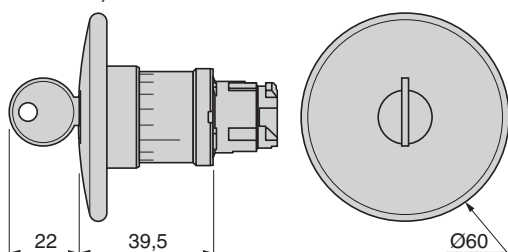



# Harmony™ XB4 metal 22 mm push buttons

Push buttons, switches and pilot lights:  
sub-assemblies, ZB4B

## Mushroom heads for latching push buttons (1)

### Push-pull

ZB4BT2

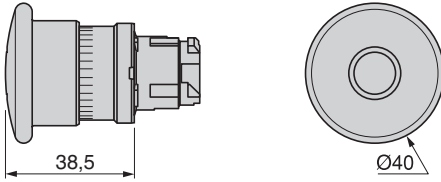

ZB4BX2

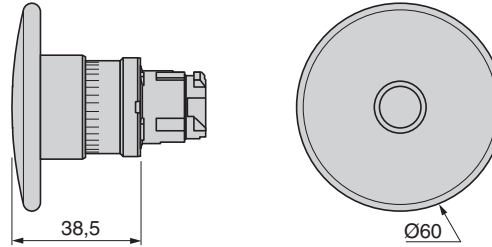

### Turn to release

ZB4BS42

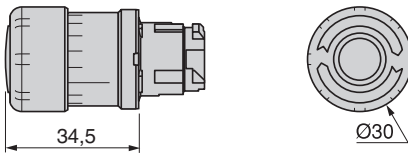

ZB4BS52, ZB4BS55

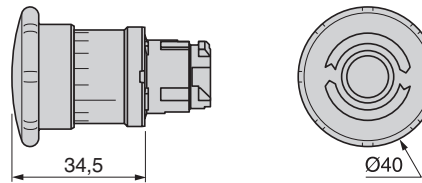

ZB4BS62

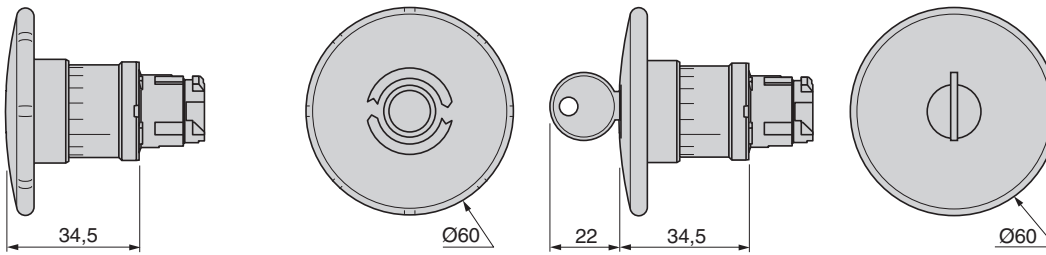

### Key release

ZB4BS72

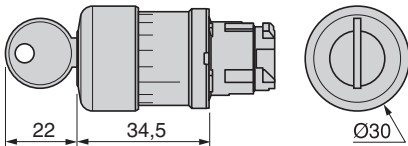

ZB4BS12

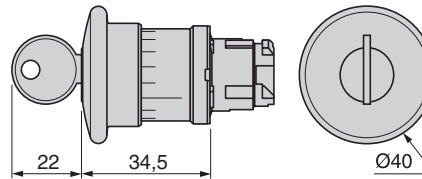

ZB4BS22

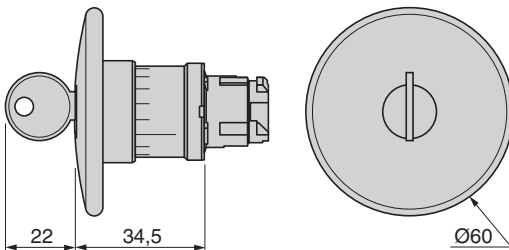

(1) Red mushroom heads for Emergency stop and Emergency switching off, latching push buttons: see page 76.

# Harmony™ XB4 metal 22 mm push buttons

Push buttons, switches and pilot lights:  
sub-assemblies, ZB4B

## Heads for selector switches

### Standard handle operator

ZB4BD●, ZB4BD0●M

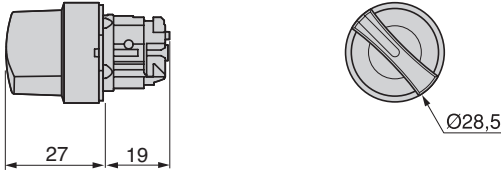

### Long handle operator

ZB4BJ●, ZB4BD0●M

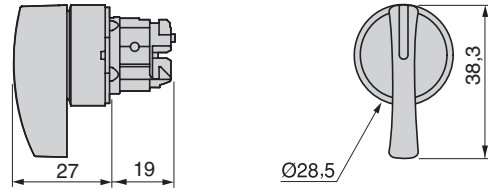

### Padlockable long handle operator (6.35 mm shank max.)

ZB4BJ●9●

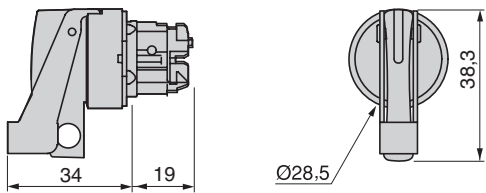

### Black knurled knob

ZB4BD●9

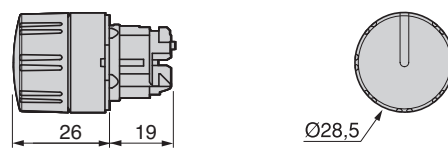

## Key switches

ZB4BG●, ZB4BG0●, ZB4BG0●M

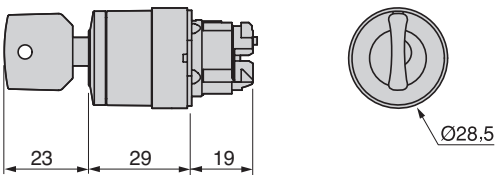

## Heads for toggle switches

ZB4BD●8



## Bodies for push buttons and switches

### Screw clamp terminal connections

ZB4BZ10●, ZB4BZ141

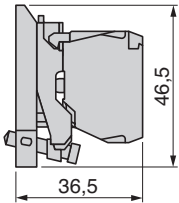

### Spring terminal connections

ZB4BZ10●5

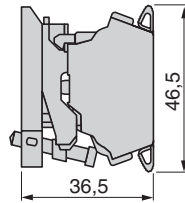

### Plug-in connector

ZB4BZ10●4, ZB4BZ1414

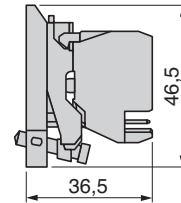

## High power switching with screw clamp terminal connections

ZBE50● block + ZB4BZ009 body

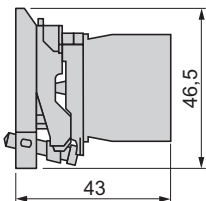

# Harmony™ XB4 metal 22 mm push buttons

Push buttons, switches and pilot lights:  
sub-assemblies, ZB4B and ZBV

## Heads for pilot lights, with light source

### Integral LED

ZB4BV0●3, ZB4BV0●3S

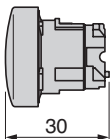

### Incandescent, neon or LED

ZB4BV0●, ZB4BV0●S

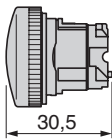

Common face view

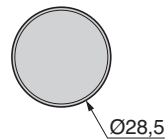

## Bodies for pilot lights, screw clamp terminal connections

### Integral LED

ZB4BV●●

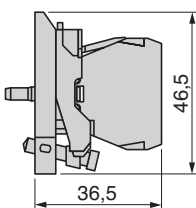

### Direct supply, for BA 9s bulb

ZB4BV6

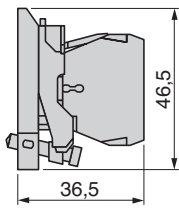

### Via integral transformer, for BA 9s bulb

ZB4BV●, ZB4BV●D●

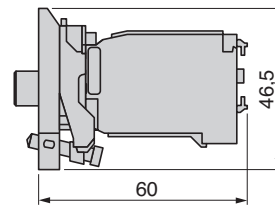

## Light block + body/mounting collar for pilot lights, plug-in connector

### Integral LED

ZBV●●4 light block + ZB4BZ009 body/mounting collar

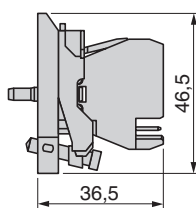

## Transformer blocks

### For 24 V light blocks with integral LED

ZBV 5B, ZBV 8B, ZBV 9B

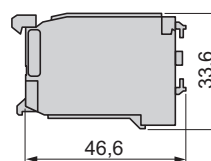

## Light block + body/mounting collar for pilot lights, spring terminal connections

### Integral LED

ZBV●●5 light block + ZB4BZ009 body/mounting collar

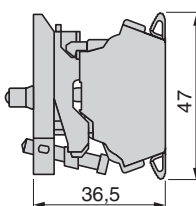

## Connections

### Blocks for "remote test light" function

ZBZG156

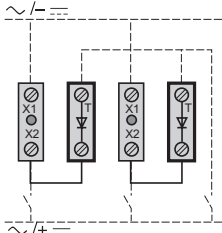

ZBZM156

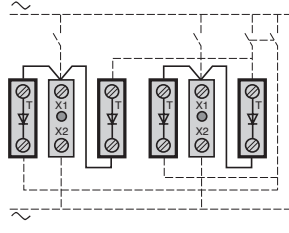

# Harmony™ XB4 metal 22 mm push buttons

Push buttons, switches and pilot lights:  
sub-assemblies, ZB4B

## Heads for spring return illuminated push buttons, for light source types

### LED

ZB4BW3●3, ZB4BW3●3S  
ZB4BW5●3, ZB4BA●8

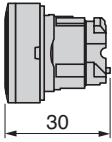

ZB4BW1●3, ZB4BL●8

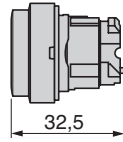

Common face view

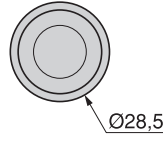

ZB4BW9●3

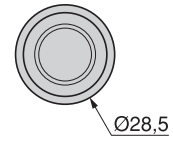
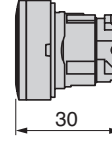

### Incandescent or neon

ZB4BW3●3, ZB4BW3●S

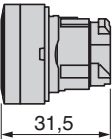

ZB4BW1●

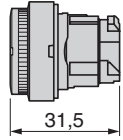

Common face view

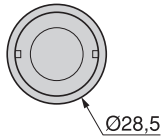

## Heads for 40 mm mushroom head illuminated push buttons with LED

ZB4BW4●3, ZB4BW6●3

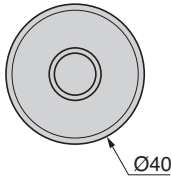
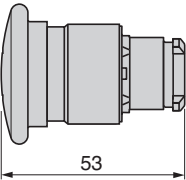

## Heads for double-headed push buttons + pilot light

ZB4BW7A374●,  
ZB4BW7A17●●,  
ZB4BW7A9

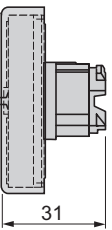

ZB4BW7L374●

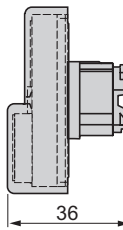

Common face view

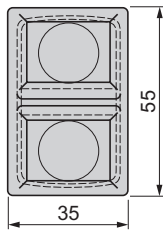

ZB4BW7A374●,  
ZB4BW7A17●●,  
ZB4BW7A9  
+ boot ZBA 708

ZB4BW7L374●  
+ boot ZBA 710

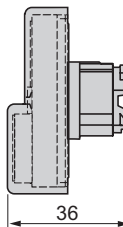
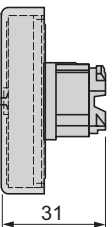

Common face view

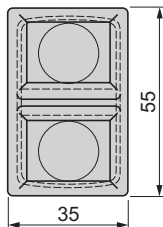

## Heads for illuminated selector switches with standard handle

ZB4BK1●●●3

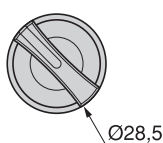
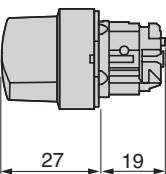

# Harmony™ XB4 metal 22 mm push buttons

Push buttons, switches and pilot lights:  
complete units, XB4B

## Bodies for illuminated push buttons and switches

### Screw clamp terminal connections

Integral LED	Direct supply, BA 9s bulb	Via integral transformer, BA 9s bulb	Plug-in connector Integral LED
ZB4BW0●●●	ZB4BW06●	ZB4BW0●●, BW0●D●●	ZB4BW0●●●4

## Manual overload reset buttons

### XB4BA8●●

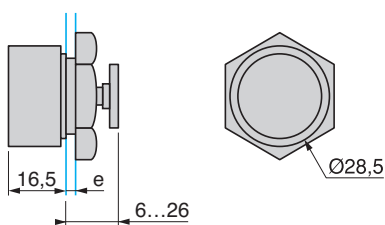

### XB4BA9●●

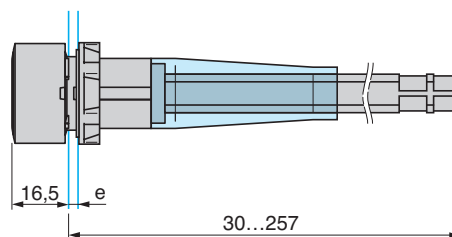

e: panel thickness 1 to 6 mm

## Heads + mounting base for potentiometer

### ZB4BD9●2

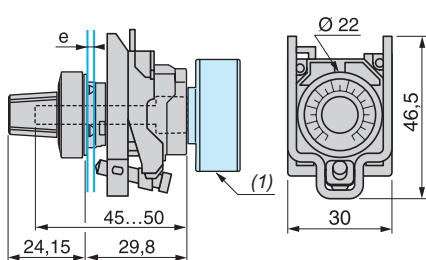

(1) Potentiometer not included.

## Wobble stick head

### ZB4BB●

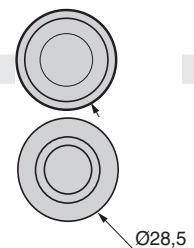
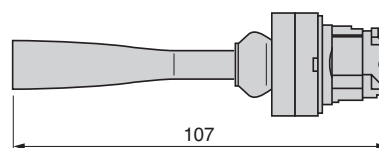

# Harmony™ XB4 metal 22 mm push buttons

Push buttons, switches and pilot lights:  
complete units, XB4B

## Joystick controllers

**XD4 PA●2**

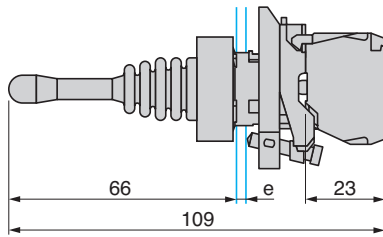

**XD4 PA●4**

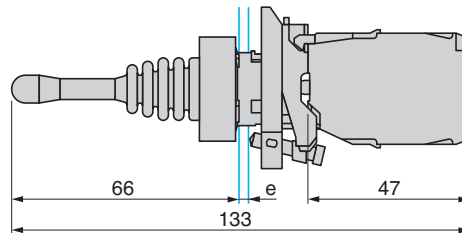

Common face view

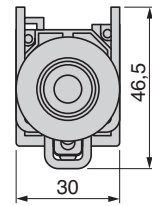

e: panel thickness 1 to 6 mm

## Hour counters

**XB5 DS●**

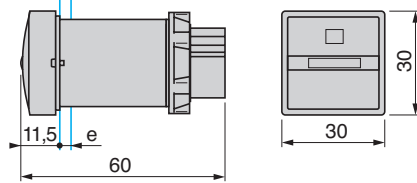

## Annunciators

**XB5 KS●**

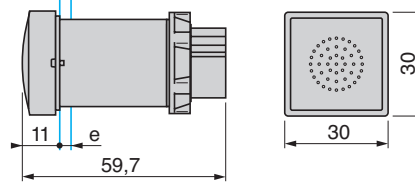

## Cabling

**XB5 KS●**

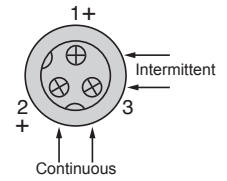

e: panel thickness 1 to 6 mm



# Harmony™ XB4 metal 22 mm push buttons

Push buttons, switches and pilot lights:  
for printed circuit board connection

## Push buttons, switches and pilot lights for printed circuit board connection

### Panel cut-outs (viewed from installer's side)

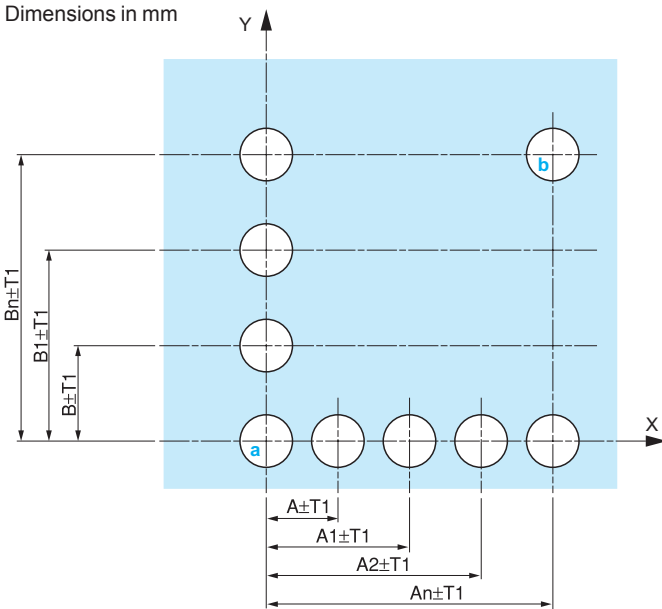

### Printed circuit board cut-outs (viewed from electrical block side)

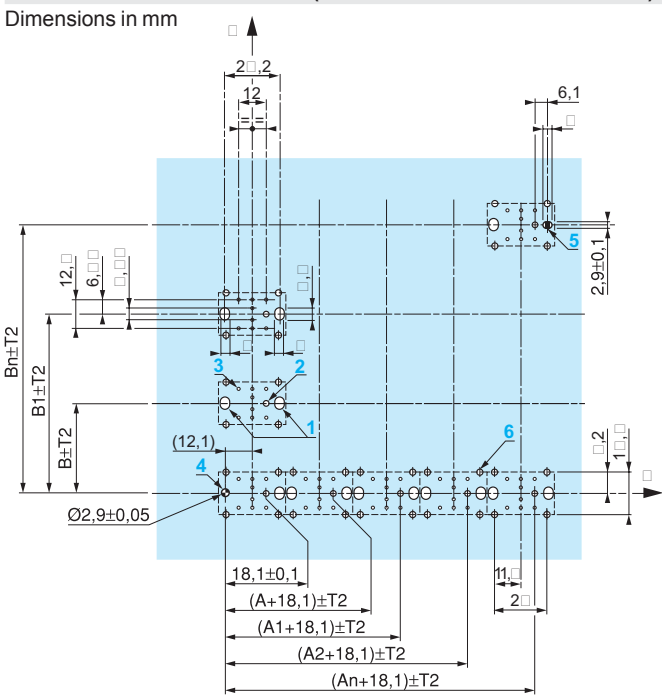

### General tolerances of the panel and printed circuit board

The cumulative tolerance must not exceed 0.3 mm:  $T1 + T2 = 0.3$  mm max.

### Installation information:

- Minimum thickness of circuit board: 1.6 mm.
- Cut-out diameter:  $22.4 \text{ mm} \pm 0.1 \text{ mm}$ .
- Orientation of body/mounting collar ZB4BZ009:  $\pm 2^\circ 30'$  (excluding cut-outs marked **a** and **b**).
- Tightening torque of screws ZBZ006: 0.6 N.m. max.
- Allow for one ZB4BZ079 mounting collar/pillar and its mounting screws:
  - every 90 mm horizontally (X), and 120 mm vertically (Y).
  - with each selector switch head (ZB4BD●, ZB4BJ●, ZB4BG●).

The mounting centers marked **a** and **b** are diagonally opposed and must align with those marked **4** and **5**.

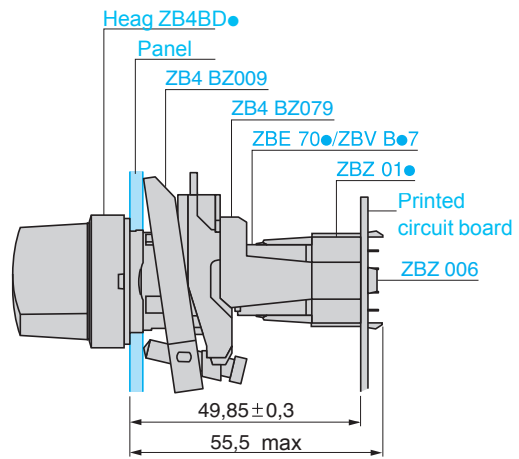

### Mounting of adapter (socket) ZBZ01●:

- 1** 2 elongated holes for ZBZ006 screw access.
- 2** 1 hole  $2.4 \text{ mm} \pm 0.05$  for centering adapter ZBZ01●
- 3** 8 x 1.2 mm holes.
- 4** 1 hole  $2.9 \text{ mm} \pm 0.05$ , for aligning the printed circuit board (with cut-out marked **a**).
- 5** 1 elongated hole for aligning the printed circuit board (with cut-out marked **b**).
- 6** 4 holes 2.4 mm for clipping in adapter ZBZ01●.

Dimensions  $An + 18.1$  relate to the  $2.4 \text{ mm} \pm 0.05$  holes for centering adapter ZBZ01●.

# Harmony™ XB5 plastic 22 mm push buttons

Push buttons, switches and pilot lights

**Description**

The 22 mm product range of plastic (double insulated) control and signaling units is comprised of:

**Complete units, XB5A**



Push buttons and switches



Pilot lights

**Sub-assemblies, ZB5A**

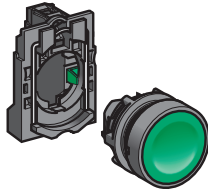

Push buttons and switches:  
body + head sub-assemblies

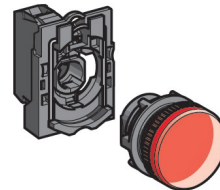

Pilot lights:  
body + head sub-assemblies

**ZB component parts and accessories**

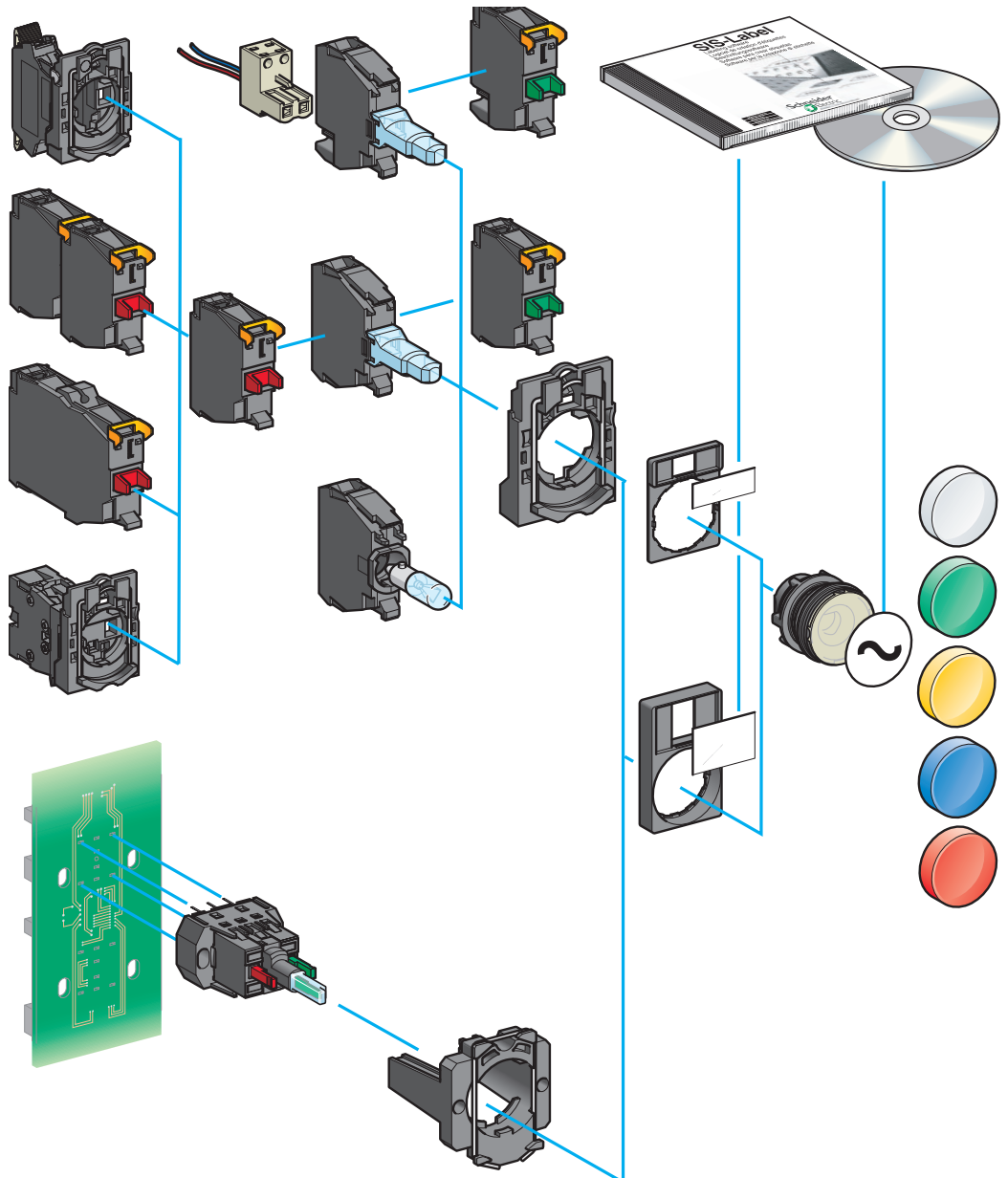

**Schematic library**

**Typical wiring diagrams**

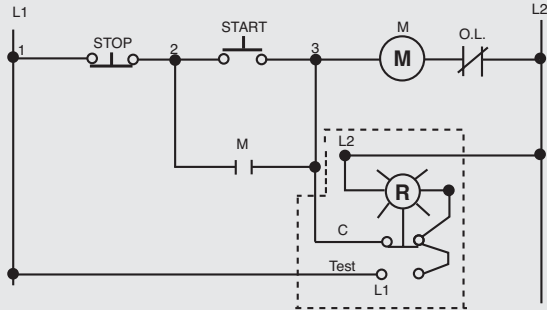

**Push-To-Test Pilot Light**

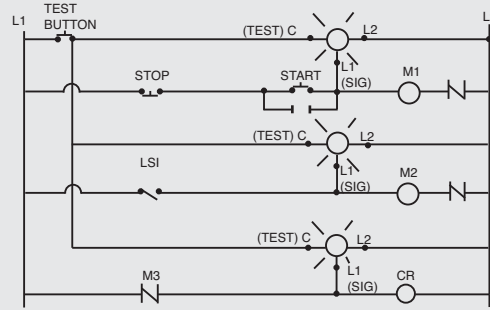

**Remote Test Pilot Light**

**Joystick controller functions**

**2 direction**

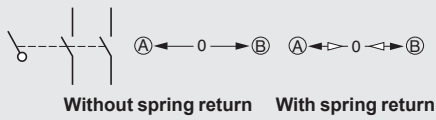

**4 direction**

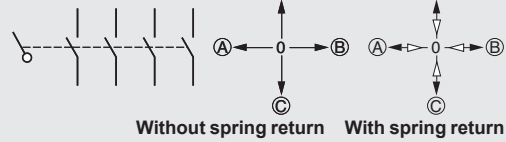

# Harmony™ XB5 plastic 22 mm push buttons

Push buttons, switches and pilot lights:  
complete units, XB5A

**Complete units**

**Contact functions**

**Push buttons, spring return**



Flush push, unmarked  
XB5AA●1/AA42  
see page 98



Flush push, with marking  
XB5AA3311/AA33●1  
see page 102



Projecting push, with marking  
XB5AL4322  
see page 102



Booted flush push  
XB5AP●1/AP42  
see page 101



Projecting push, unmarked  
XB5AL42  
see page 100

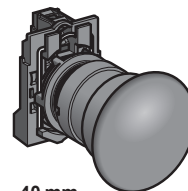

40 mm  
Mushroom head  
XB5AC21  
see page 108

**Multiple-headed push buttons, spring return**

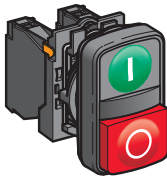

Double-headed  
XB5AL73415  
see page 106



Triple-headed  
XB5AA731327/XB5AA711237  
see page 107

**Emergency Stop or  
Emergency switching off  
mushroom head push  
buttons, 40 mm**

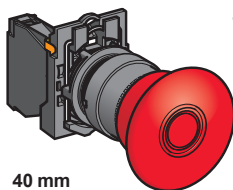

40 mm

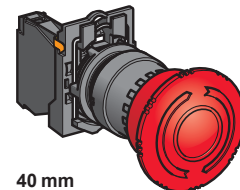

40 mm

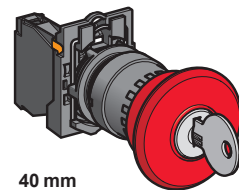

40 mm

**Emergency stop trigger  
action and mechanical  
latching**

Push-pull (EN/ISO 13850: 2006)  
XB5AT845  
see page 110

Turn to release (EN/ISO 13850: 2006)  
XB5AS8●4  
see page 110

Key release (EN/ISO 13850: 2006)  
XB5AS9445  
see page 110

**Emergency switching off  
mechanical latching**

Push-pull (IEC 60364-5-53)  
XB5AT42  
see page 111

Turn to release (IEC 60364-5-53)  
XB5AS542  
see page 111

Key release (IEC 60364-5-53)  
XB5AS142  
see page 111

**Selector switches  
and key switches**

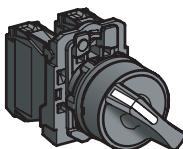

Standard handle, black  
XB5AD●●  
see page 113



Long handle, black  
XB5AJ●●  
see page 113

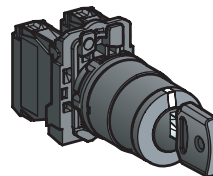

Key switch  
XB5AG●●  
see page 114

# Harmony™ XB5 plastic 22 mm push buttons

Push buttons, switches and pilot lights:  
complete units, XB5A

## Complete units (continued)

### Pilot lights

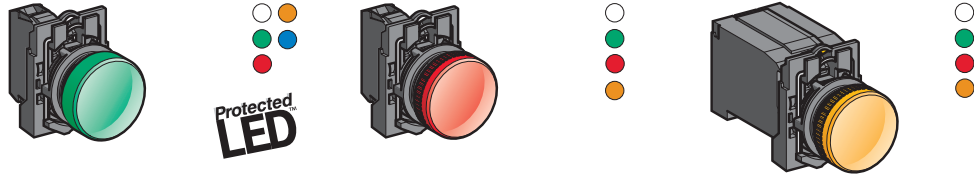

Integral LED  
XB5AVB●/AVG●/AVM●  
see page 118

For bulb with BA 9s base fitting  
Direct supply  
XB5AV6●  
see page 119

Via integral transformer  
XB5AV3●/AV4●  
see page 119

## Combined functions (contact + signaling)

### Illuminated push buttons, spring return, flush push

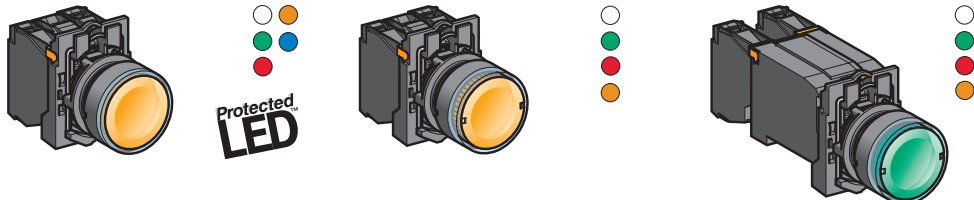

Integral LED  
XB5AW3●B5/AW3●G5/AW3●M5  
see page 103

For bulb with BA 9s base fitting  
Direct supply  
XB5AW3●65  
see page 99

Via integral transformer  
XB5AW3●35/AW3●45  
see page 105

### Double-headed push buttons, spring return, + pilot light block

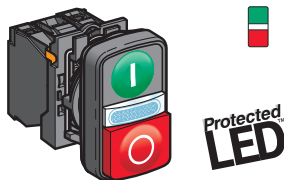

Integral LED  
XB5AW73731●5  
see page 106

### Illuminated selector switches, standard handle

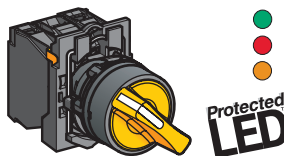

Integral LED  
XB5AK12●●5, XB5AK13●●5  
see page 116

### Fingerprint reader biometric switches

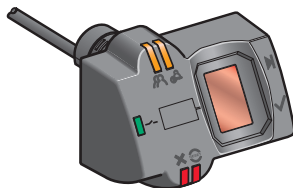

Bistable or monostable type, 24 Vdc  
XB5S●B●●●●  
see page 167

### Wireless, batteryless push buttons

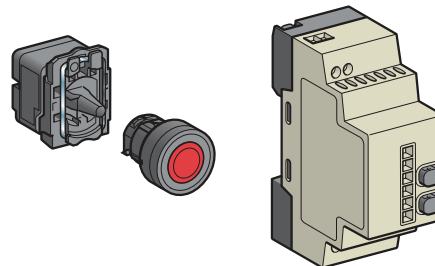

Wireless, batteryless push buttons  
24 Vdc or 24 to 240 Vac/Vdc  
XB5R●●●●  
see page 183

# Harmony™ XB5 plastic 22 mm push buttons

Push buttons, switches and pilot lights:  
sub-assemblies, ZB5A

## Non-illuminated units for user assembly

## Contact functions

### Body sub-assemblies

### Head sub-assemblies

For push buttons,  
spring return, unmarked

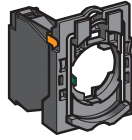

Screw clamp terminals  
ZB5AZ10●/AZ141  
page 122

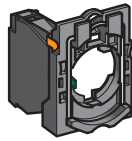

Faston®  
ZB5AZ10●3  
page 126

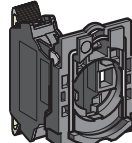

Spring clamp terminals  
ZBE 10●5  
ZB5AZ10●5  
page 124

For push buttons,  
spring return, with marking

For multiple-headed push  
buttons, spring return

For "push-turn to release"  
push buttons



Flush push without cap/with set of 6 caps  
ZB5AA0/AA9  
page 98

Flush push  
ZB5AA●  
page 98

Flush push for insertion of legend  
ZB5AA●8  
page 98

Flush push, cap mounted/not mounted  
ZB5CA0/CA●  
page 98



Projecting  
ZB5AL●  
page 100



Recessed push  
ZB5AA●  
page 99



Booted flush push, for insertion of legend  
ZB5AP●●/AP●S  
page 100



Projecting or recessed push  
ZB5CA●/CL●  
page 99



Flush push  
ZB5AA●3●/AA●4●  
page 102



Projecting push  
ZB5AL●  
page 102



Flush push  
ZB5CA●3●/ CA●9●  
page 102

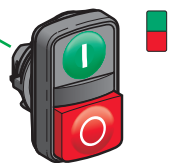

Double-headed  
ZB5AA7●●●/AA79  
ZB5AL734●  
page 106

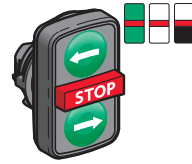

Triple-headed  
ZB5AA7313●, ZB5AA711●●  
ZB5AA72124, ZB5AA791  
page 107

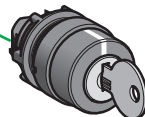

Key switches  
ZB5AFD●  
page 112



Knurled knob (1)  
ZB5AF  
page 112

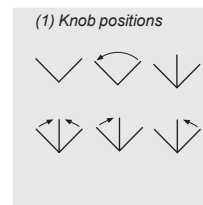



# Harmony™ XB5 plastic 22 mm push buttons

Push buttons, switches and pilot lights:  
sub-assemblies, ZB5A

**Non-illuminated units  
for user assembly**  
*(continued)*

For mushroom head push buttons

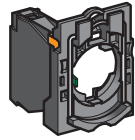

Screw clamp terminals  
ZB5AZ10/AZ141  
page 122

For Emergency Stop or  
Emergency switching off  
mushroom head push buttons

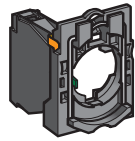

Faston®  
ZB5AZ10/3  
page 126

Emergency stop trigger  
action and mechanical  
latching

Emergency switching off  
mechanical latching

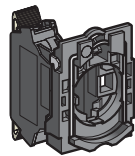

Spring clamp terminals  
ZBE 10/5  
ZB5AZ10/5  
page 124

Emergency stop trigger  
action and mechanical  
latching

Emergency switching off  
mechanical latching

For selector switches  
and key switches

For toggle switches

**Contact functions (continued)**

**Body sub-assemblies**

**Head sub-assemblies**

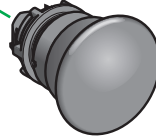

Ø 30  
Ø 40  
Ø 60

Spring  
ZB5AC/AR  
see page 108



Ø 30  
Ø 40  
Ø 60

Latching  
ZB5A/2/AS/2/AS55  
see page 109

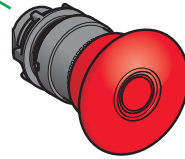

Ø 30  
Ø 40  
Ø 60

Push-pull (EN/ISO 13850: 2006)  
ZB5AT84  
see page 110



Ø 30  
Ø 40  
Ø 60

Turn to release (EN/ISO 13850: 2006)  
ZB5AS8/4  
see page 110

Push-pull (IEC 60364-5-53)  
ZB5AT/AX  
see page 111

Turn to release (IEC 60364-5-53)  
ZB5AS44/AS54/AS64  
see page 111

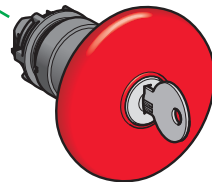

Ø 30  
Ø 40  
Ø 60

Key release (EN/ISO 13850: 2006)  
ZB5AS9/4/AS944D, see page 110

Key release (IEC 60364-5-53)  
ZB5AS/4/AS14D, see page 111



Standard handle (1)  
ZB5AD  
page 113



Long black handle (1)  
ZB5AJ  
page 113

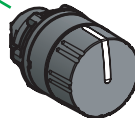

Knurled black knob (1)  
ZB5AD/9  
page 115

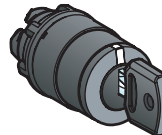

Key switch (2)  
ZB5AG  
page 115

(1) Switch handle  
and knob  
positions

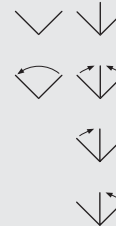

(2) Key switch positions  
Key withdrawal  
positions

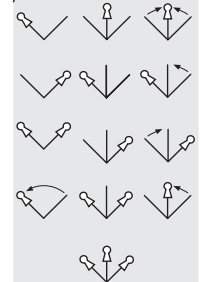

(3) Lever positions

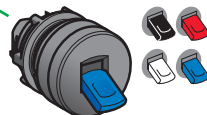

2-position lever (3)  
ZB5AD/8  
see page 115

# Harmony™ XB5 plastic 22 mm push buttons

Push buttons, switches and pilot lights:  
sub-assemblies, ZB5A

## Pilot lights for user assembly

### Signaling functions

#### Body sub-assemblies with integral LED

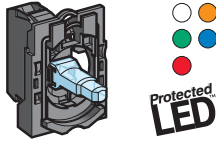

Connection: screw clamp terminals  
ZB5AVB/AVG/AVM  
see page 130

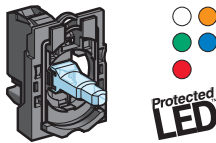

Connection: plug-in connector  
Please consult your Regional  
Sales Office

#### Body sub-assemblies for BA 9s bulb

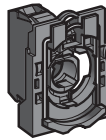

Direct supply  
Connection: screw clamp terminals  
ZB5AV6, page 133

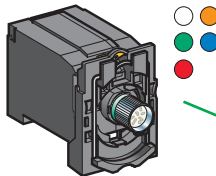

Via integral transformer  
Connection: screw clamp terminals  
ZB5AV●/AV3D●/AV5D●  
page 133

#### Head sub-assemblies



With lens fitted (insertion of legend)  
ZB5AV0●3/AV0●3E, see page 118



With lens fitted  
ZB5CV0●3, see page 118



With 5 lens caps (not fitted) for insertion of legend  
ZB5AV003/AV0●3●, see page 118



With 5 separate lens caps, not fitted  
ZB5CV003, see page 118

#### Head sub-assemblies

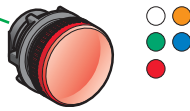

With lens fitted  
ZB5AV0●, see page 119

## Illuminated push buttons for user assembly

### Combined functions (contact + signaling)

#### Body sub-assemblies for BA 9s bulb

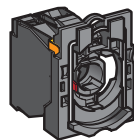

Direct supply  
Connection: screw clamp terminals  
ZB5AW06●, page 132

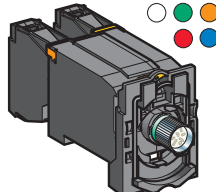

Via integral transformer  
Connection: screw clamp terminals  
ZB5AW03/4/5/3D/4D/5D  
see page 122

#### Head sub-assemblies

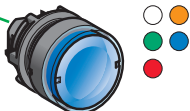

Flush  
ZB5AW3●/AW3●S, see page 104

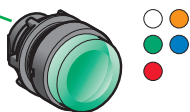

Projecting  
ZB5AW1●/AW1●S, see page 104

For illuminated push buttons,  
spring return

# Harmony™ XB5 plastic 22 mm push buttons

Push buttons, switches and pilot lights:  
sub-assemblies, ZB5A

## Illuminated push buttons for user assembly

For illuminated push buttons, spring return

### Body sub-assemblies with integral LED

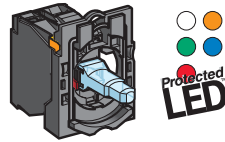

Connection: screw clamp terminals  
**ZB5AW0B/AW0G/AW0M**  
see page 104

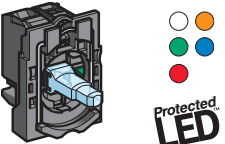

Connection: plug-in connector

Please consult your Regional Sales Office

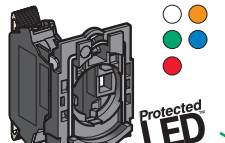

For double-headed push buttons, spring return, with pilot light

For illuminated, mushroom head push buttons, latching

Connection: spring clamp terminals  
**ZBV ●●5**  
see page 124

For illuminated mushroom head push buttons

- Emergency Stop with trigger action and mechanical latching
- or
- Emergency switching off with mechanical latching only

## Combined functions (contact + signaling) (continued)

### Head sub-assemblies



Flush push  
Flush push with illuminated ring  
**ZB5AW3●3/AW3●3S/AW9●3**  
see page 104



Flush push  
for insertion of legend  
**ZB5AA●8**  
see page 104

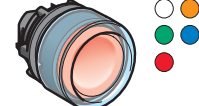

Booted flush push  
**ZB5AW5●3**  
see page 104

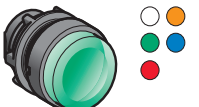

Projecting push  
**ZB5AW1●3/AW1●3S**  
see page 104



Flush or projecting push  
Flush or projecting push for insertion of legend  
**ZB5CW3●3/CW1●3**  
see page 104

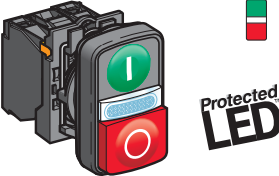

Double-headed (flush/flush push) + central pilot light  
Double-headed (flush/projecting push) + central pilot light  
**ZB5AW7A17●●, ZB5AW7A374●, ZB5AW7A9**, see page 106  
**ZB5AW7L374●**, see page 106

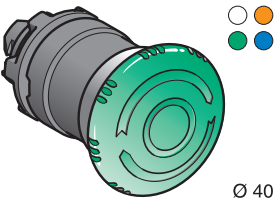

Turn to release  
**ZB5AW7●3**, see page 109

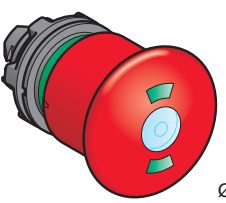

Push-pull with mechanical state indicator (EN/ISO 13850:2006)  
**ZB5AT8643M**  
see page 110

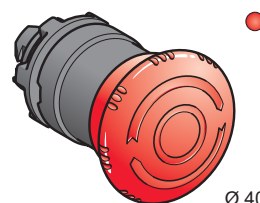

Turn to release (IEC 60364-5-53)  
**ZB5AW743**  
see page 111

(1) Handle positions



# Harmony™ XB5 plastic 22 mm push buttons

Push buttons, switches and pilot lights

Environment			
Protective treatment	Standard version		"TH" treatment
Ambient air temperature around the device	Storage	°C	- 40 to + 70
	Operation	°C	- 25 to + 70: LED and neon bulb versions - 25 to + 55: incandescent bulb version
Electric shock protection	Conforming to IEC 61140		Class II
Degree of protection	Conforming to IEC 60529		IP 66 IP 69 K (Selector switches and multiple-headed push buttons) IP 54 (Emergency stop illuminated, trigger action and mechanical latching push buttons with mechanical state indicator)
	Conforming to NEMA		NEMA type 4X and 13, unless otherwise stated
Resistance to high pressure washer		Pa	70 x 10 <sup>5</sup> (70 bar); distance: 0.1 m Temperature: 55 °C
Mechanical shock protection	Conforming to IEC 50102		Non-illuminated heads: IK 03 Illuminated heads: IK 05 Selector switch heads: IK 06
Conforming to standards			EN/IEC 60947-1, EN/IEC 60947-5-1, EN/IEC 60947-5-4, EN/IEC 60947-5-5, EN/IEC60204-1 and EN/ISO 13850: 2006 (Emergency stop trigger action and mechanical latching push buttons, see page 110) IEC60364-5-53 (Emergency switching off mechanical latching push buttons, see page 110) EN 81-1 (Emergency stop illuminated, trigger action and mechanical latching push buttons with mechanical state indicator, see page 110) JIS C4520, UL 508, CSA C22-2 no. 14
Product certifications	UL Listed, CSA		Standard single contacts with screw clamp and spring terminals: A600; Q600 Double contacts with screw clamp terminals: A600; Q600 Light blocks with screw clamp terminals Joystick controllers XD5PA/ZD5PA: A600; R300 Special contact blocks: □ ZBE201: A300; Q300 □ ZBE202: A600; Q600 Single contacts for high power switching: □ ZBE501 and ZBE 502: A300; P300
	UL Recognized, CSA		Standard single contacts for plug-in connector: A300; R300 Standard contacts for printed circuit board: B300; R300
	BV, RINA, LROS, DNV, GL		Standard single contacts and double contacts with screw clamp or spring terminals:
Terminal referencing	Conforming to EN 50005 and EN 50013		

### Specifications of contact or combined contact and signaling functions (see page 96)

Mechanical specifications			
Contact operation	N/C or N/O		Slow break
Positive operation	Conforming to EN/IEC 60947-5-1 appendix K		All functions incorporating a N/C contact have positive opening operation
Operating travel (to change the electrical state)	Push button	mm	Changing N/C state: 1.5 Changing N/O state: 2.6 Total travel: 4.3
Operating force	Push button	N	Changing N/C state: 3.5 Changing N/O state: 3.8
	Additional contact only (extra to change state)	N	Single N/C contact: 2 Single N/O contact: 2.3
		N	Double N/C contact: 3.4 Double N/O contact: 5 Double contact N/C + N/O: 4.6
Emergency stop or Emergency switching off with N/C + N/O		N	Standard push-pull: 45 Trigger action push-pull: 50
		N	Standard turn to release and key release: 40 Trigger action turn to release and key release: 44

# Harmony™ XB5 plastic 22 mm push buttons

Push buttons, switches and pilot lights

**Specifications of contact or combined contact and signaling functions (continued) (see page 96)**

**Mechanical specifications (continued)**

<b>Operating torque</b> (to change the electrical state)	Selector switches	<b>N.m</b>	N/O contact: 0.14
	Additional contact only	<b>N.m</b>	N/O contact: 0.05
<b>Mechanical durability</b> (in millions of operating cycles)	Push button	Spring return	5
		Multiple-headed	1
		Push-push to release	0.5
	Selector switch	Non-illuminated	1
		Illuminated	0.5
	Toggle switch		0.5
	Emergency stop or Emergency switching off push button		0.3 with 4 contacts 0.3 with 2 contacts (Emergency stop with mechanical state indicator)
	Joystick controller		1
	Standard contact block only		5
	Low power switching contact block only (dust protected)		0.5
<b>Vibration resistance</b>	Conforming to IEC 60068-2-6		Frequency: 2 to 500 Hz: 5 gn
<b>Mechanical shock resistance</b>	Conforming to IEC 60068-2-27		All functions except mushroom head push buttons, spring return: <input type="checkbox"/> half sine wave acceleration 11 ms: 50 gn <input type="checkbox"/> half sine wave acceleration 18 ms: 30 gn Spring return mushroom head push button: <input type="checkbox"/> half sine wave acceleration 11 ms: 15 gn

**Electrical specifications**

<b>Cabling capacity</b>	Conforming to IEC 60947-1	<b>mm<sup>2</sup></b>	Standard block with screw clamp or spring terminals: Min: 1 x 0.22 without cable end Max: 2 x 1.5 with cable end Cross headed screws (Pozidriv or Phillips type 1), slotted for flat 4 and 5.5 mm screwdriver Tightening torque: 0.8 N.m (maxi 1.2 N.m)  Contact blocks for high power switching: Min: 1 x 0.5 without cable end Max: 2 x 2.5 with or without cable end
<b>Contact material</b>	Silver alloy (Ag / Ni)		Standard single and double blocks with screw clamp or spring terminals Blocks for plug-in connector Standard blocks for printed circuit board connection
	Gold flashed (Ag / Ni / Au)		Low power switching contact blocks with screw clamp terminals Low power switching contact blocks for printed circuit board connection
<b>Short-circuit protection</b>	Conforming to EN/IEC 60947-5-1	<b>A</b>	Standard single and double blocks with screw clamp or spring terminals: 10 (gG cartridge fuse conforming to IEC 60269-1) Blocks for plug-in connector Standard blocks for printed circuit board connection: 4 (gG cartridge fuse conforming to IEC 60269-1)
<b>Rated thermal current</b>	Conforming to EN/IEC 60947-5-1	<b>A</b>	Standard single and double blocks with screw clamp or spring terminals: 10 Blocks for plug-in connector: 10 Standard blocks for printed circuit board connection: 6
<b>Rated insulation voltage</b>	Conforming to EN/IEC 60947-1	<b>V</b>	Standard single and double blocks with screw clamp or spring terminals: Ui = 600, degree of pollution 3 Blocks for plug-in connector or Faston® connectors Standard blocks for printed circuit board connection Contact blocks for high-power switching: Ui = 250, degree of pollution 3
<b>Rated impulse withstand voltage</b>	Conforming to IEC 60947-1	<b>kV</b>	Standard single and double blocks with screw clamp or spring terminals: Uimp = 6 Blocks for plug-in connector Standard blocks for printed circuit board connection Contact blocks for high-power switching: Uimp = 4

# Harmony™ XB5 plastic 22 mm push buttons

Push buttons, switches and pilot lights

**Specifications of contact or combined contact and signaling functions (continued) (see page 96)**

**Electrical specifications (continued)**

<b>Rated operational specifications</b> Conforming to EN/IEC 60947-5-1	a.c. supply: utilization category AC-15		<b>Standard single and double blocks with screw clamp or spring terminals</b> A600: Ue = 600 V and Ie = 1.2 A or Ue = 240 V and Ie = 3 A or Ue = 120 V and Ie = 6 A <b>Blocks for plug-in connector:</b> A300: Ue = 120 V and Ie = 6 A or Ue = 240 V and Ie = 3 A <b>Standard blocks for printed circuit board connection:</b> B300: Ue = 120 V and Ie = 3 A or Ue = 240 V and Ie = 1.5 A <b>Special contact blocks:</b> □ ZBE201: A300: Ue = 240 V and Ie = 3 A or Ue = 120 V and Ie = 6 A (with insulation voltage Ui = 500 V) □ ZBE202: A600: Ue = 600 V and Ie = 1.2 A or Ue = 240 V and Ie = 3 A or Ue = 120 V and Ie = 6 A <b>Contact blocks for high power switching:</b> □ ZBE50●: A300: Ue = 240 V and Ie = 3 A or Ue = 120 V and Ie = 6 A								
	d.c. supply: utilization category DC-13		<b>Standard single and double blocks with screw clamp or spring terminals</b> Q600: Ue = 600 V and Ie = 0.1 A or Ue = 250 V and Ie = 0.27 A or Ue = 125 V and Ie = 0.55 A <b>Joystick controllers XD5PA/ZD5PA:</b> R300: Ue = 125 V and Ie = 0.22 A or Ue = 250 V and Ie = 0.1 A <b>Blocks for plug-in connector:</b> R300: Ue = 125 V and Ie = 0.22 A or Ue = 250 V and Ie = 0.1 A <b>Standard blocks for printed circuit board connection:</b> R300: Ue = 125 V and Ie = 0.22 A or Ue = 250 V and Ie = 0.1 A <b>Special contact blocks:</b> □ ZBE201: Q300; Ue = 125 V and Ie = 0.55 A or Ue = 250 V and Ie = 0.27 A □ ZBE202: Q600; Ue = 600 V and Ie = 0.1 A or Ue = 250 V and Ie = 0.27 A or Ue = 125 V and Ie = 0.55 A <b>Contact blocks for high power switching:</b> □ ZBE50●: P300: Ue = 125 V and Ie = 1.1 A or Ue = 250 V and Ie = 0.55 A								
<b>Specifications of special contact blocks</b>	<b>Low power switching</b>		<b>VA</b> P max: 12 <b>A</b> I max: 0.1 <b>V</b> U max: 24								
	<b>High power switching</b> conforming to EN/IEC 60947-5-1	100 000 operating cycles Load factor: 0.5 Operating rate: 900 cycles/hour	<b>VA</b> P max: 240 <b>A</b> I max: 10 <b>V</b> U: 24 ~								
<b>Electrical durability</b> Conforming to EN/IEC 60947-5-1 appendix C Operating rate 3600 operating cycles/hour Load factor: 0.5	a.c. supply for 1 million operating cycles utilization category AC-15		Standard single blocks with screw clamp terminals or spring terminals: <table border="1"> <tr> <td><b>V</b></td> <td>24</td> <td>120</td> <td>230</td> </tr> <tr> <td><b>A</b></td> <td>4</td> <td>3</td> <td>2</td> </tr> </table>	<b>V</b>	24	120	230	<b>A</b>	4	3	2
		<b>V</b>	24	120	230						
	<b>A</b>	4	3	2							
		Standard double blocks with screw clamp terminals and blocks for plug-in connector: <table border="1"> <tr> <td><b>V</b></td> <td>24</td> <td>120</td> <td>230</td> </tr> <tr> <td><b>A</b></td> <td>3</td> <td>1.5</td> <td>1</td> </tr> </table>	<b>V</b>	24	120	230	<b>A</b>	3	1.5	1	
<b>V</b>	24	120	230								
<b>A</b>	3	1.5	1								
d.c. supply for 1 million operating cycles utilization category DC-13		Standard single blocks with screw clamp terminals or spring terminals: <table border="1"> <tr> <td><b>V</b></td> <td>24</td> <td>110</td> </tr> <tr> <td><b>A</b></td> <td>0.5</td> <td>0.2</td> </tr> </table>	<b>V</b>	24	110	<b>A</b>	0.5	0.2			
	<b>V</b>	24	110								
<b>A</b>	0.5	0.2									
	Standard double blocks with screw clamp terminals and blocks for plug-in connector: <table border="1"> <tr> <td><b>V</b></td> <td>24</td> <td>110</td> </tr> <tr> <td><b>A</b></td> <td>0.4</td> <td>0.15</td> </tr> </table>	<b>V</b>	24	110	<b>A</b>	0.4	0.15				
<b>V</b>	24	110									
<b>A</b>	0.4	0.15									
<b>Electrical reliability</b> <b>Failure rate</b> Conforming to EN/IEC 60947-5-4	In clean environment		Standard blocks: - at 17 V and 5 mA, $\lambda < 10^{-6}$ - at 5 V and 1 mA, $\lambda < 10^{-6}$ Special blocks with gold flashed contacts, for low power switching: - at 5 V and 1 mA, $\lambda < 10^{-7}$								
	In dusty environment		Special blocks with gold flashed contacts and dust protection for low power switching only: - at 5 V and 1 mA, $\lambda < 10^{-7}$								



# Harmony™ XB5 plastic 22 mm push buttons

Push buttons, switches and pilot lights

## Specifications of illuminated units (pilot lights)

### Mechanical specifications

Vibration resistance	Conforming to IEC 60068-2-6		Frequency: 12 to 500 Hz: 5 gn
Electric shock resistance	Conforming to IEC 60068-2-27		Half sine wave acceleration 11 ms: 50 gn Half sine wave acceleration 18 ms: 30 gn

### Electrical specifications

Cabling capacity	Conforming to EN/IEC 60947-1	mm <sup>2</sup>	Screw clamp and spring terminals Min: 1 x 0.2 without cable end (1 x 0.34 for linking) Max: 2 x 1.5 with cable end
Rated insulation voltage	Conforming to EN/IEC 60947-1	V	Direct supply pilot light blocks (BA 9s bulb): U <sub>i</sub> = 250 degree of pollution 3 Pilot light blocks with integral LED: U <sub>i</sub> = 250 degree of pollution 3 Pilot light blocks with transformer: U <sub>i</sub> = 600 degree of pollution 3
Rated impulse withstand voltage	Conforming to EN/IEC 60947-1	kV	Direct supply pilot light blocks (BA 9s bulb): U <sub>imp</sub> = 4 Pilot light blocks with integral LED: U <sub>imp</sub> = 4 Pilot light blocks with transformer: U <sub>imp</sub> = 6

## Specific specifications of single light blocks with integral LED

Voltage limits	For rated voltage	V	12 V: 10 to 15 ~; 10.2 to 13.8 ~ 24 V: 19.2 to 15 ~; 21.6 to 13.8 ~ 24 to 120 V: 19.2 to 132 ~; 21.6 to 132 ~ 48 to 120 V: 40 to 132 ~ 230/240 V: 195 to 264 ~
Current consumption	Applicable to all colors	mA	Blocks with ~ 12 V supply: 18 Blocks with ~ 24 V supply: 18 Blocks with ~ 120 V supply: 14 Blocks with ~ 240 V supply: 14
Service life	At rated voltage and at an ambient temperature of 25 °C	H	100 000
Surge withstand	Conforming to IEC 61000-4-5	kV	1
Resistance to fast transients	Conforming to IEC 61000-4-4	kV	2
Resistance to electromagnetic fields	Conforming to IEC 61000-4-3	V/m	10
Resistance to electrostatic discharges	Conforming to IEC 61000-4-2	kV	8: in free air, in insulating parts 6: on contact, on metal parts
Direct parallel connection across inductive load e.g.: contactor coil or solenoid	Maximum power of load	VA	For high power applications (≥ 30 VA), a <b>ZBZV●</b> LED suppressor must be connected across the light block terminals (see page 123)
Electromagnetic emission	Conforming to IEC 55011		Class B

## Specific specifications

### Mounting nut

Head tightening torque		N.m	2.2 (± 0.2)
------------------------	--	-----	-------------

### Hour counters and annunciators

Voltage limits	Hour counter and annunciator	V	± 10% of the nominal voltage
Current consumption	Hour counter	mA	XB5DSB: 7 to 15 XB5DSG: 8 XB5DSM: 8
	Annunciator	mA	5

# Harmony™ XB5 plastic 22 mm push buttons

Contact mounting - Contact sequence

## Maximum recommended configurations guaranteeing achievement of catalog specifications

Unit type (complete units XB5B, heads ZB5 B)	Push buttons, spring return XB5AA●, ZB5AA●8, (except ZB5AA●8) XB5AC●, ZB5AC●, XB5AL●, ZB5AL●, XB5AP●, ZB5AP●, ZB5AR● Triple-headed push buttons XB5AA731327, XB5AA711137, ZB5AA7313●, ZB5AA7111●, ZB5AA72124, ZB5AA791	Double-headed push buttons XB5AL73415, ZB5AA712●, ZB5A●734●, ZB5AA79	Illuminated push buttons, spring return XB5AW●, ZB5AW●, ZB5AA●8 Double-headed push buttons + pilot light block XB5AW73731●5, ZB5AW7A17●●, ZB5AW7●374●, ZB5AW7A9	
Solution using single contacts				
Solution using single and double contacts				
Maximum recommended configurations	Single contacts Double contacts + Single contacts Light block	9 3 + 3 -	6 2 + 2 -	6 2 + 2 1

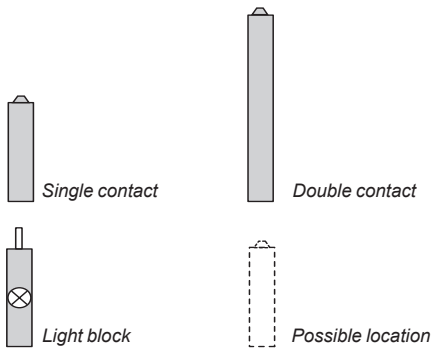

## Possible configurations for high power switching contacts (1) (2)

High power switching contact blocks with screw clamp terminal connections :  
 ZBE 501, ZBE 502, ZBE 503, ZBE 504 and ZBE 505  
 High power switching contact blocks with connection by Faston® connectors  
 ZBE 5013, ZBE 5023, ZBE 5033, ZBE 5043 and ZBE 5053

1 N/O	1 N/C	1 N/O + N/C 1 N/O + N/O 1 N/C + N/C

(1) The configurations are not upgradable and cannot be combined with other types of contact and signaling functions.  
 (2) High power switching contacts are not compatible with Harmony triple-headed push buttons.



Emergency stop or Emergency switching off XB5AT●, ZB5AT●, XB5AS●, ZB5AS●		Selector switches XB5AD●, ZB5AD●, ■ Standard handle XB5AJ●, ZB5AJ●, ■ Long handle ZB5AD●9, ■ Key switch XB5AG●, ZB5AG●			Illuminated selector switches with standard handle XB5AK●, ZB5AK● Illuminated Emergency Stop ZB5AT8643M, ZB5AW743		Toggle switches ZB5AD●8 Push buttons, push-turn to release, knurled operator ZB5AF●, or lockable ZB5FAD●	
4	4	5	4	6	4	6		
2	1	2	1	2	2	3		
+	+	+	+	+	+	+		
0	2	1	2	2	0	0		
-	-	-	-	-	1	-		

### Sequence of contacts fitted to selector switch bodies

Unit type			Selector switches														
			2-position			3-position											
			315°		45°		315°		0°		45°						
Push	Position	Top															
		Bottom															
	Location		L	C	R	L	C	R	L	C	R	L	C	R	L	C	R
	State		0	0	0	1	1	1	1	1	0	0	0	0	0	1	1
Contacts	N/O		□	□	□	■	■	■	■	■	□	□	□	□	□	■	■
	N/C		■	■	■	□	□	□	□	□	■	■	■	■	■	□	□
L left, C center, R right																	
□ open, ■ closed																	





# Harmony™ XB5 plastic 22 mm push buttons Spring return push buttons, unmarked

Assembly of other products using body/contact assemblies, see page 122; accessories, see pages 134 and 138



Push buttons with flush push <sup>(1)</sup>						
Screw clamp terminal connections (Schneider Electric anti-retightening system)						
Shape of head	Type of push	Type of contact		Color of push	Reference	Weight
		 N/O	 N/C			

Complete units						
	Flush	1	-	White	<b>XB5AA11</b> (ZB5AZ101 + ZB5AA1)	0.037
				Black	<b>XB5AA21</b> (ZB5AZ101 + ZB5AA2)	0.037
				Green	<b>XB5AA31</b> (ZB5AZ101 + ZB5AA3)	0.037
				Yellow	<b>XB5AA51</b> (ZB5AZ101 + ZB5AA5)	0.037
				Blue	<b>XB5AA61</b> (ZB5AZ101 + ZB5AA6)	0.037
				Red	<b>XB5AA42</b> (ZB5AZ102 + ZB5AA4)	0.037
		-	1			



Heads only, circular						
	Without cap <sup>(2)</sup>			-	<b>ZB5AA0</b>	0.022
	Flush, with set of 6 colored caps			6 colors <sup>(3)</sup>	<b>ZB5AA9</b>	0.027
	Flush	White	<b>ZB5AA1</b>	0.018		
		Black	<b>ZB5AA2</b>	0.018		
		Green	<b>ZB5AA3</b>	0.018		
		Red	<b>ZB5AA4</b>	0.018		
		Yellow	<b>ZB5AA5</b>	0.018		
		Blue	<b>ZB5AA6</b>	0.018		
	Flush with transparent cap for insertion of legend <sup>(4)</sup>	Grey	<b>ZB5AA8</b>	0.018		
		White	<b>ZB5AA18</b>	0.018		
		Green	<b>ZB5AA38</b>	0.018		
		Red	<b>ZB5AA48</b>	0.018		
		Yellow	<b>ZB5AA58</b>	0.018		
	Flush (high bezel)	Blue	<b>ZB5AA68</b>	0.018		
		White	<b>ZB5AA14</b>	0.020		
		Black	<b>ZB5AA24</b>	0.020		
		Green	<b>ZB5AA34</b>	0.020		
		Red	<b>ZB5AA44</b>	0.020		
		Yellow	<b>ZB5AA54</b>	0.020		
		Blue	<b>ZB5AA64</b>	0.020		



Heads only, square						
	Without cap <sup>(2)</sup>			-	<b>ZB5CA0</b>	0.022
	Flush	White	<b>ZB5CA1</b>	0.019		
		Black	<b>ZB5CA2</b>	0.019		
		Green	<b>ZB5CA3</b>	0.019		
		Red	<b>ZB5CA4</b>	0.019		
		Yellow	<b>ZB5CA5</b>	0.019		
		Blue	<b>ZB5CA6</b>	0.019		





(1) Recommended maximum number of contacts constituting the body (mounting collar + contact) associated with the head, see page 96.  
 (2) Colored cap to be ordered separately: see page 134.  
 (3) Head supplied with 6 different colored caps (white, black, green, red, yellow, blue) not fitted.  
 (4) For legend ordering information, see page 138.  
 Note: For contact block and mounting collar ordering information, see pages 122, 124, 125 and 126.

# Harmony™ XB5 plastic 22 mm push buttons Spring return push buttons, unmarked

Assembly of other products using body/contact assemblies, see page 122; accessories, see pages 134 and 138



ZB5AA16

Push buttons with recessed push <sup>(1)</sup>				
High guard				
Shape of head	Type of push	Color	Reference	Weight kg
<b>Heads only, circular</b>				
	Recessed (high guard)	White	<b>ZB5AA16</b>	0.020
		Black	<b>ZB5AA26</b>	0.020
		Green	<b>ZB5AA36</b>	0.020
		Red	<b>ZB5AA46</b>	0.020
		Yellow	<b>ZB5AA56</b>	0.020
		Blue	<b>ZB5AA66</b>	0.020
<b>Heads only, square</b>				
	Recessed (high guard)	White	<b>ZB5CA16</b>	0.012
		Black	<b>ZB5CA26</b>	0.012
		Green	<b>ZB5CA36</b>	0.012
		Red	<b>ZB5CA46</b>	0.012
		Yellow	<b>ZB5CA56</b>	0.012
		Blue	<b>ZB5CA66</b>	0.012







ZB5CA16

<sup>(1)</sup> Recommended maximum number of contacts constituting the body (mounting collar + contact) associated with the head, see page 96.  
Note: For contact block and mounting collar ordering information, see pages 122, 124, 125 and 126.

# Harmony™ XB5 plastic 22 mm push buttons

Spring return push buttons, unmarked

Assembly of other products using body/contact assemblies, see page 122; accessories, see pages 134 and 138

Push buttons with projecting push <sup>(1)</sup>						
Screw clamp terminal connections (Schneider Electric anti-retightening system)						
Shape of head	Type of push	Type of contact		Color of push	Reference	Weight
						
		N/O	N/C			kg
<b>Complete units</b>						
	Projecting	-	1	Red	<b>XB5AL42</b> (ZB5AZ102 + ZB5AL4)	0.038
<b>Heads only, circular</b>						
	Projecting			White	<b>ZB5AL1</b>	0.019
				Black	<b>ZB5AL2</b>	0.019
				Green	<b>ZB5AL3</b>	0.019
				Red	<b>ZB5AL4</b>	0.019
				Yellow	<b>ZB5AL5</b>	0.019
				Blue	<b>ZB5AL6</b>	0.019
<b>Heads only, square</b>						
	Projecting			White	<b>ZB5CL1</b>	0.021
				Black	<b>ZB5CL2</b>	0.021
				Green	<b>ZB5CL3</b>	0.021
				Red	<b>ZB5CL4</b>	0.021
				Yellow	<b>ZB5CL5</b>	0.021
				Blue	<b>ZB5CL6</b>	0.021



XB5AL42



ZB5AL3



ZB5CL1

(1) Recommended maximum number of contacts constituting the body (mounting collar + contact) associated with the head, see page 96.  
Note: For contact block and mounting collar ordering information, see pages 122, 124, 125 and 126.

# Harmony™ XB5 plastic

## 22 mm push buttons

Spring return push buttons, unmarked

Assembly of other products using body/contact assemblies, see page 122; combined sub-assemblies, see page 126; accessories, see page 138



XB5AP51

Push buttons with booted head (1)						
Screw clamp terminal connections (Schneider Electric anti-retightening system)						
Shape of head	Type of push	Type of contact		Color of push	Reference	Weight
		N/O	N/C			
						kg

Complete units						
	Booted, clear silicone (color of push unobscured)	1	-	Black	<b>XB5AP21</b> (ZB5AZ101 + ZB5AP2)	0.039
				Green	<b>XB5AP31</b> (ZB5AZ101 + ZB5AP3)	0.039
				Yellow	<b>XB5AP51</b> (ZB5AZ101 + ZB5AP5)	0.039
				Blue	<b>XB5AP61</b> (ZB5AZ101 + ZB5AP6)	0.039
				Red	<b>XB5AP42</b> (ZB5AZ102 + ZB5AP4)	0.039
		-	1			

Silicone booted heads only, with increased protection (IP 69K)						
	Flush	Clear boot (2) For insertion of protected legend within head (3)	White	<b>ZB5AP18</b>	0.023	
			Green	<b>ZB5AP38</b>	0.023	
			Red	<b>ZB5AP48</b>	0.023	
			Yellow	<b>ZB5AP58</b>	0.023	
			Blue	<b>ZB5AP68</b>	0.023	

ZB5AP48

	Flush	Clear boot (2)	White	<b>ZB5APA1</b>	0.023
			Black	<b>ZB5APA2</b>	0.023
			Green	<b>ZB5APA3</b>	0.023
			Red	<b>ZB5APA4</b>	0.023
			Yellow	<b>ZB5APA5</b>	0.023
			Blue	<b>ZB5APA6</b>	0.023

ZB5APA3

	Projecting	Clear boot (2)	White	<b>ZB5AP1</b>	0.014
			Black	<b>ZB5AP2</b>	0.014
			Green	<b>ZB5AP3</b>	0.014
			Red	<b>ZB5AP4</b>	0.014
			Yellow	<b>ZB5AP5</b>	0.014
			Blue	<b>ZB5AP6</b>	0.014

ZB5AP4

Silicone booted heads only, standard for with legend holder (IP 66)						
	Flush	Colored boot (4)	White	<b>ZB5AP1S</b>	0.021	
			Black	<b>ZB5AP2S</b>	0.021	
			Green	<b>ZB5AP3S</b>	0.021	
			Red	<b>ZB5AP4S</b>	0.021	
			Yellow	<b>ZB5AP5S</b>	0.021	
			Blue	<b>ZB5AP6S</b>	0.021	
		Clear membrane (4) For insertion of protected legend within head (3)	White	<b>ZB5AP183</b>	0.010	
			Green	<b>ZB5AP383</b>	0.010	
			Red	<b>ZB5AP483</b>	0.010	
			Yellow	<b>ZB5AP583</b>	0.010	
			Blue	<b>ZB5AP683</b>	0.010	

ZB5AP2S

ZB5AP183

(1) Recommended maximum number of contacts constituting the body (mounting collar + contact) associated with the head, see page 96.

(2) Permissible panel thickness 1 to 5 mm, cannot be used with legend holders.

(3) To order a legend for insertion within the head, see page 143.

(4) Replacement of silicone protection element without dismantling head, see page 136.

Note: For contact block and mounting collar ordering information, see pages 122, 124, 125 and 126.



# Harmony™ XB5 plastic 22 mm push buttons Spring return push buttons, with marking

Assembly of other products using body/contact assemblies, see page 122; accessories, see pages 134 and 138



XB5AA432



ZB5AA331















ZB5AA432



ZB5CA432



ZB5AL232

Push buttons with flush or projecting push (1)							
Screw clamp terminal connections (Schneider Electric anti-retightening system)							
Shape of head	Type of push	Type of contact		Marking Text (color)	Color of push	Reference	Weight  kg
		 N/O	 N/C				
<b>Complete units</b>							
	Flush	1	–	"I" (white)	Green	<b>XB5AA3311</b> (ZB5AZ101 + ZB5AA331)	0.037
	Flush	–	1	"O" (white)	Red	<b>XB5AA4322</b> (ZB5AZ102 + ZB5AA432)	0.037
	Projecting	–	1	"O" (white)	Red	<b>XB5AL4322</b> (ZB5AZ102 + ZB5AL432)	0.037
	Flush (2)	1	–	↑ (black)	White	<b>XB5AA3341</b> (ZB5AZ101 + ZB5AA334)	0.037
	Flush (2)	1	–	↓ (white)	Black	<b>XB5AA3351</b> (ZB5AZ101 + ZB5AA335)	0.037
<b>Heads only, circular</b>							
	Flush			"I" (white)	Green	<b>ZB5AA331</b>	0.018
				"I" (black)	White	<b>ZB5AA131</b>	0.018
				"II" (white)	Green	<b>ZB5AA336</b>	0.018
				"II" (black)	White	<b>ZB5AA136</b>	0.018
				"START" (white)	Green	<b>ZB5AA333</b>	0.018
				"START" (black)	White	<b>ZB5AA133</b>	0.018
				"ON" (white)	Green	<b>ZB5AA341</b>	0.018
				"ON" (black)	White	<b>ZB5AA141</b>	0.018
				 (white)	Black	<b>ZB5AA245</b>	0.018
				 (black)	White	<b>ZB5AA145</b>	0.018
				"O" (white)	Red	<b>ZB5AA432</b>	0.018
					Black	<b>ZB5AA232</b>	0.018
				"STOP" (white)	Red	<b>ZB5AA434</b>	0.018
					Black	<b>ZB5AA234</b>	0.018
				"OFF" (white)	Red	<b>ZB5AA435</b>	0.018
					Black	<b>ZB5AA235</b>	0.018
				UP (black)	White	<b>ZB5AA343</b>	0.018
				Down (white)	Black	<b>ZB5AA344</b>	0.018
				↑ (black) (2)	White	<b>ZB5AA334</b>	0.018
				↓ (white) (2)	Black	<b>ZB5AA335</b>	0.018
<b>Heads only, square</b>							
	Flush (2)			"I" (white)	Green	<b>ZB5CA331</b>	0.019
				"O" (white)	Red	<b>ZB5CA432</b>	0.019
				"+" (white)	Black	<b>ZB5CA2934</b>	0.019
				↑ (white)	Black	<b>ZB5CA2912</b>	0.019
				"R" (white)	Blue	<b>ZB5CA6939</b>	0.019
<b>Heads only, circular</b>							
	Projecting (2)			"O" (white)	Red	<b>ZB5AL432</b>	0.019
					Black	<b>ZB5AL232</b>	0.019
				"STOP" (white)	Red	<b>ZB5AL434</b>	0.019
					Black	<b>ZB5AL234</b>	0.019
				"OFF" (white)	Red	<b>ZB5AL435</b>	0.019
					Black	<b>ZB5AL235</b>	0.019

(1) Recommended maximum number of contacts constituting the body (mounting collar + contact) associated with the head, see page 96.  
 (2) Product supplied with cap not clipped-in, allowing orientation through 360° in 90° steps.  
 Note: For contact block and mounting collar ordering information, see pages 122, 124, 125 and 126.

# Harmony™ XB5 plastic 22 mm push buttons

Illuminated push buttons, spring return,  
with integral LED

Assembly of other products using body/contact assemblies, see page 122; accessories, see pages 134 and 138

Illuminated push buttons with flush push <sup>(1)</sup>								
Screw clamp terminal connections (Schneider Electric anti-retightening system)								
Shape of head	Description	Type of contact		Supply voltage	Color of push	Reference	Weight	
				V			kg	
		N/O	N/C					
<b>Complete units - With plain lens</b>								
	 <b>Protected LED</b>	Integral LED	1	1	~ 24 50/60 Hz	White	<b>XB5AW31B5</b> (ZB5AW0B15 + ZB5AW313)	0.056
						Green	<b>XB5AW33B5</b> (ZB5AW0B35 + ZB5AW333)	0.056
						Red	<b>XB5AW34B5</b> (ZB5AW0B45 + ZB5AW343)	0.056
						Orange	<b>XB5AW35B5</b> (ZB5AW0B55 + ZB5AW353)	0.056
						Blue	<b>XB5AW36B5</b> (ZB5AW0B65 + ZB5AW363)	0.056
					~ 110 to 120 50/60 Hz	White	<b>XB5AW31G5</b> (ZB5AW0G15 + ZB5AW313)	0.056
						Green	<b>XB5AW33G5</b> (ZB5AW0G35 + ZB5AW333)	0.056
						Red	<b>XB5AW34G5</b> (ZB5AW0G45 + ZB5AW343)	0.056
						Orange	<b>XB5AW35G5</b> (ZB5AW0G55 + ZB5AW353)	0.056
						Blue	<b>XB5AW36G5</b> (ZB5AW0G65 + ZB5AW363)	0.056
~ 230 to 240 50/60 Hz	White	<b>XB5AW31M5</b> (ZB5AW0M15 + ZB5AW313)	0.056					
	Green	<b>XB5AW33M5</b> (ZB5AW0M35 + ZB5AW333)	0.056					
	Red	<b>XB5AW34M5</b> (ZB5AW0M45 + ZB5AW343)	0.056					
	Orange	<b>XB5AW35M5</b> (ZB5AW0M55 + ZB5AW353)	0.056					
	Blue	<b>XB5AW36M5</b> (ZB5AW0M65 + ZB5AW363)	0.056					

(1) Recommended maximum number of contacts constituting the body (mounting collar + contact) associated with the head, see page 96.

# Harmony™ XB5 plastic 22 mm push buttons

Illuminated push buttons, spring return,  
with integral LED

Assembly of other products using combined sub-assemblies, see page 128; accessories, see page 138

Illuminated push buttons with flush push (1)				
Shape of head	Type of push	Color	Reference	Weight (kg)
<b>Heads only, circular (2) - With plain lens</b>				
 <b>Protected LED</b>	Flush	White	ZB5AW313	0.017
		Green	ZB5AW333	0.017
		Red	ZB5AW343	0.017
		Orange	ZB5AW353	0.017
		Blue	ZB5AW363	0.017
 <b>Protected LED</b>	Flush with illuminated ring	White	ZB5AW913	0.016
		Green	ZB5AW933	0.016
		Red	ZB5AW943	0.016
		Orange	ZB5AW953	0.016
		Blue	ZB5AW963	0.016
 <b>Protected LED</b>	Flush with clear boot	White	ZB5AW513	0.019
		Green	ZB5AW533	0.019
		Red	ZB5AW543	0.019
		Orange	ZB5AW553	0.019
		Blue	ZB5AW563	0.019
 <b>Protected LED</b>	Flush for insertion of legend (3)	White	ZB5AA18	0.018
		Green	ZB5AA38	0.018
		Red	ZB5AA48	0.018
		Orange	ZB5AA58	0.018
		Blue	ZB5AA68	0.018
<b>Heads only, circular (2) - With grooved lens (4)</b>				
 <b>Protected LED</b>	Flush	White	ZB5AW313S	0.017
		Green	ZB5AW333S	0.017
		Red	ZB5AW343S	0.017
		Orange	ZB5AW353S	0.017
		Blue	ZB5AW363S	0.017
<b>Heads only, square (2)</b>				
 <b>Protected LED</b>	Flush (legend can be inserted)	White	ZB5CW313	0.023
		Green	ZB5CW333	0.023
		Red	ZB5CW343	0.023
		Orange	ZB5CW353	0.023
		Blue	ZB5CW363	0.023
 <b>Protected LED</b>	Flush (high guard)	White	ZB5CW3136	0.014
		Green	ZB5CW3336	0.014
		Red	ZB5CW3436	0.014
		Orange	ZB5CW3536	0.014
		Blue	ZB5CW3636	0.014
<b>Illuminated push buttons with projecting push (1)</b>				
Shape of head	Type of push	Color	Reference	Weight (kg)
<b>Heads only, circular (2) - With plain lens</b>				
 <b>Protected LED</b>	Projecting	White	ZB5AW113	0.018
		Green	ZB5AW133	0.018
		Red	ZB5AW143	0.018
		Orange	ZB5AW153	0.018
		Blue	ZB5AW163	0.018
 <b>Protected LED</b>	Projecting	White	ZB5AW113S	0.017
		Green	ZB5AW133S	0.017
		Red	ZB5AW143S	0.017
		Orange	ZB5AW153S	0.017
		Blue	ZB5AW163S	0.017
<b>Heads only, square (2)</b>				
 <b>Protected LED</b>	Projecting (legend can be inserted)	White	ZB5CW113	0.024
		Green	ZB5CW133	0.024
		Red	ZB5CW143	0.024
		Orange	ZB5CW153	0.024
		Blue	ZB5CW163	0.024

(1) Recommended maximum number of contacts constituting the body (mounting collar + contact) associated with the head, see page 96.

(2) Only for use with bodies comprised of a light source with integral LED.

(3) For legend ordering information, see page 138.

(4) For use in bright ambient light conditions (outdoors in sunlight, for example).

Note: For contact block and mounting collar ordering information, see pages 122, 124, 125 and 126.

For light module ordering information, see pages 123, 124 and 125.



ZB5AW313



ZB5AW363



ZB5CW313



ZB5CW3136



ZB5AW143









ZB5CW143

# Harmony™ XB5 plastic 22 mm push buttons

Illuminated push buttons, spring return,  
with BA 9s base fitting

Assembly of other products using combined sub-assemblies, see page 128; accessories, see page 138

Illuminated push buttons with flush push <sup>(1)</sup>							
Screw clamp terminal connections (Schneider Electric anti-retightening system)							
Shape of head	Description	Type of contact		Supply voltage	Color of push	Reference	Weight
		 N/O	 N/C				
<b>Complete units - With plain lens</b>							
 XB5AW3465	Direct supply for bulb with BA 9s base fitting, 2.4 W max, (bulb not included)	1	1	≤ 250	White	<b>XB5AW3165</b> (ZB5AW065 + ZB5AW31)	0.057
					Green	<b>XB5AW3365</b> (ZB5AW065 + ZB5AW33)	0.057
					Red	<b>XB5AW3465</b> (ZB5AW065 + ZB5AW34)	0.057
					Orange	<b>XB5AW3565</b> (ZB5AW065 + ZB5AW35)	0.057
	Via integral transformer 1.2 VA, 6 V secondary, incandescent bulb with BA 9s base fitting, (bulb included)	1	1	~ 110 to 120 50/60 Hz	White	<b>XB5AW3135</b> (ZB5AW035 + ZB5AW31)	0.128
					Green	<b>XB5AW3335</b> (ZB5AW035 + ZB5AW33)	0.128
					Red	<b>XB5AW3435</b> (ZB5AW035 + ZB5AW34)	0.128
					Orange	<b>XB5AW3535</b> (ZB5AW035 + ZB5AW35)	0.128
				~ 230 50 Hz ~ 220 to 240 60 Hz	White	<b>XB5AW3145</b> (ZB5AW045 + ZB5AW31)	0.129
					Green	<b>XB5AW3345</b> (ZB5AW045 + ZB5AW33)	0.129
					Red	<b>XB5AW3445</b> (ZB5AW045 + ZB5AW34)	0.129
					Orange	<b>XB5AW3545</b> (ZB5AW045 + ZB5AW35)	0.129
<b>Heads only <sup>(2)</sup> - With plain lens</b>							
 ZB5AW33	Flush				White	<b>ZB5AW31</b>	0.018
					Green	<b>ZB5AW33</b>	0.018
					Red	<b>ZB5AW34</b>	0.018
					Orange	<b>ZB5AW35</b>	0.018
					Blue	<b>ZB5AW36</b>	0.018
					Clear	<b>ZB5AW37</b>	0.018
<b>Heads only <sup>(2)</sup> - With grooved lens <sup>(3)</sup></b>							
 ZB5AW33S	Flush				White	<b>ZB5AW31S</b>	0.018
					Green	<b>ZB5AW33S</b>	0.018
					Red	<b>ZB5AW34S</b>	0.018
					Orange	<b>ZB5AW35S</b>	0.018
					Blue	<b>ZB5AW36S</b>	0.018
					Clear	<b>ZB5AW37S</b>	0.018
<b>Illuminated push buttons with projecting push <sup>(1)</sup></b>							
<b>Heads only <sup>(2)</sup> - With plain lens</b>							
 ZB5AW11	Projecting				White	<b>ZB5AW11</b>	0.017
					Green	<b>ZB5AW13</b>	0.017
					Red	<b>ZB5AW14</b>	0.017
					Orange	<b>ZB5AW15</b>	0.017
					Blue	<b>ZB5AW16</b>	0.017
					Clear	<b>ZB5AW17</b>	0.017
<b>Heads only <sup>(2)</sup> - With grooved lens <sup>(3)</sup></b>							
 ZB5AW11S	Projecting				White	<b>ZB5AW11S</b>	0.018
					Green	<b>ZB5AW13S</b>	0.018
					Red	<b>ZB5AW14S</b>	0.018
					Orange	<b>ZB5AW15S</b>	0.018
					Blue	<b>ZB5AW16S</b>	0.018
					Clear	<b>ZB5AW17S</b>	0.018

(1) Recommended maximum number of contacts constituting the body (mounting collar + contact) associated with the head, see page 96.

(2) Only for use with bodies comprised of a light source with BA9s base fitting bulb (incandescent, neon or LED).

(3) For use in bright ambient light conditions (outdoors in sunlight, for example).

Note: For contact block and mounting collar ordering information, see pages 122, 124, 125 and 126.

For light module ordering information, see pages 123, 124 and 125.

# Harmony™ XB5 plastic 22 mm push buttons Multiple head push buttons, spring return

User assembly of other units, using body-contacts assemblies, see page 122; combined sub-assemblies, see page 128



Double-headed push buttons <sup>(1)</sup>						
Screw clamp terminal connections (Schneider Electric anti-retightening system)						
Shape of head	Description	Type of contact		Color and marking of caps <sup>(2)</sup>	Reference	Weight
						kg
		N/O	N/C			
<b>Complete units</b>						
	2 pushes (1 flush black + 1 projecting red)	1	1	White "I" on green background White "0" on red background	<b>XB5AL73415</b>	0.053
<b>Heads only</b>						
	2 flush black pushes			White background + black background, unmarked	<b>ZB5AA7120</b>	0.023
				Black "I" on white background White "0" on black background	<b>ZB5AA7121</b>	0.023
				Green background + red background, unmarked	<b>ZB5AA7340</b>	0.023
				White "I" on green background White "0" on red background	<b>ZB5AA7341</b>	0.023
				Without cap <sup>(3)</sup>	<b>ZB5AA79</b>	0.023
	1 flush black push 1 projecting red push			Green background + red background, unmarked	<b>ZB5AL7340</b>	0.023
				White "I" on green background White "0" on red background	<b>ZB5AL7341</b>	0.023

Double-headed push buttons + 1 white central pilot light block <sup>(1)</sup>						
Screw clamp terminal connections (Schneider Electric anti-retightening system)						
Shape of head	Description	Type of contact		Color and marking of caps <sup>(2)</sup>	Pilot light voltage	Weight
					V	kg
		N/O	N/C			
<b>Complete units</b>						
	1 flush black push 1 projecting red push 1 white central pilot light block	1	1	White "I" on green background White "0" on red background	24	<b>XB5AW73731B5</b> 0.066
					120	<b>XB5AW73731G5</b> 0.066
					240	<b>XB5AW73731M5</b> 0.066
<b>Heads only <sup>(5)</sup></b>						
	2 flush black pushes 1 clear central pilot light <sup>(4)</sup>			White background + black background, unmarked		<b>ZB5AW7A1720</b> 0.023
				Black "I" on white background White "0" on black background		<b>ZB5AW7A1721</b> 0.023
				Green background + red background, unmarked		<b>ZB5AW7A3740</b> 0.023
				White "I" on green background White "0" on red background		<b>ZB5AW7A3741</b> 0.023
				Black "+" on white background White "0" on black background		<b>ZB5AW7A1724</b> 0.023
				Black "+" on white background Black "-" on white background		<b>ZB5AW7A1715</b> 0.023
				Without cap <sup>(3)</sup>		<b>ZB5AW7A9</b> 0.023
	1 flush black push 1 projecting red push 1 clear central pilot light <sup>(4)</sup>			Green background + red background, unmarked		<b>ZB5AW7L3740</b> 0.023
				White "I" on green background White "0" on red background		<b>ZB5AW7L3741</b> 0.023

(1) Recommended maximum number of contacts constituting the body (mounting collar + contact) associated with the head, see page 96.  
 (2) These caps are fitted by Schneider Electric and cannot be removed (risk of damage).  
 (3) Caps to be ordered separately: see page 107.  
 (4) Color of centrally positioned pilot light determined by the color of the LED incorporated in the body sub-assembly.  
 (5) Only for use with bodies comprised of a light source with integral LED.  
 Note: For contact block and mounting collar ordering information, see pages 122, 124, 125 and 126.  
 For light module ordering information, see pages 123, 124 and 125.



# Harmony™ XB5 plastic 22 mm push buttons Multiple head push buttons, spring return

User assembly of other units, using body-contacts assemblies, see page 122; combined sub-assemblies, see page 128

Triple-headed push buttons (1) (2)							
Screw clamp terminal connections (Schneider Electric anti-retightening system)							
Shape of head	Description	Type of contact			Color and marking of caps (3)	Reference	Weight
							kg
		N/O	N/C	N/O			

Complete units							
	2 flush black pushes + 1 central projecting red push marked "Stop" in white	1	1	1	White "I" on green background White "II" on green background	<b>XB5AA731327</b>	0.063
					Black "→" on white background White "←" on black background	<b>XB5AA711237</b>	0.063

Heads only							
	2 flush black pushes + 1 central projecting red push marked "Stop" in white				White "I" on green background White "II" on green background	<b>ZB5AA73132</b>	0.023
					White "←" on green background White "→" on green background	<b>ZB5AA73133</b>	0.023
					White "↑" on green background White "↓" on green background	<b>ZB5AA73134</b>	0.023
					White "+" on green background White "-" on green background	<b>ZB5AA73135</b>	0.023
					Black "+" on white background Black "-" on white background	<b>ZB5AA71115</b>	0.023
					Black "→" on white background White "←" on black background	<b>ZB5AA71123</b>	0.023
					Black "↑" on white background White "↓" on black background	<b>ZB5AA71124</b>	0.023
					White "↑" on black background White "↓" on black background	<b>ZB5AA72124</b>	0.023
					Without cap (4)	<b>ZB5AA791</b>	0.023

Specific accessories for multiple-headed push buttons							
Description	Background color	Marking	Sold in lots of	Reference	Weight	kg	
Caps only for clip-on mounting on double or triple-headed push buttons (5)	White	Unmarked	10	<b>ZBA71</b>	0.010		
		"I" black	10	<b>ZBA7131</b>	0.010		
		"+" black	10	<b>ZBA7134</b>	0.010		
		"+" black	10	<b>ZBA7138</b>	0.010		
		Black	Unmarked	10	<b>ZBA72</b>	0.010	
		"O" white	10	<b>ZBA7232</b>	0.010		
	Green	"+" white	10	<b>ZBA7233</b>	0.010		
		"↓" white	10	<b>ZBA7235</b>	0.010		
		"I" white	10	<b>ZBA7237</b>	0.010		
		Unmarked	10	<b>ZBA73</b>	0.010		
		"I" white	10	<b>ZBA7331</b>	0.010		
		"+" white	10	<b>ZBA7333</b>	0.010		
Red	"↑" white	10	<b>ZBA7335</b>	0.010			
	"II" white	10	<b>ZBA7336</b>	0.010			
Yellow	Unmarked	10	<b>ZBA74</b>	0.010			
	"O" white	10	<b>ZBA7432</b>	0.010			
Blue	Unmarked	10	<b>ZBA75</b>	0.010			
	Unmarked	10	<b>ZBA76</b>	0.010			
Clear silicone boots (6)	For 2 flush pushes	–	10	<b>ZBA708</b>	0.055		
	For 3 pushes	–	10	<b>ZBA709</b>	0.055		
	For 1 flush push + 1 projecting push	–	10	<b>ZBA710</b>	0.055		

(1) Recommended maximum number of contacts constituting the body (mounting collar + contact) associated with the head, see page 96.  
 (2) Not compatible with high power switching contacts and contacts for printed circuit board.  
 (3) These caps are fitted by Schneider Electric and cannot be removed (risk of damage).  
 (4) Caps to be ordered separately: see accessories on this page.  
 (5) Can be clipped-in at 90° steps, through 360°.  
 (6) Can be replaced without dismantling the head.  
 Note: For contact block and mounting collar ordering information, see pages 122, 124, 125 and 126.



XB5AA731327



ZB5AA73133



ZB5AA71124



ZBA7235



ZBA7331



ZBA7432









ZBA 709

# Harmony™ XB5 plastic 22 mm push buttons

## Mushroom head push buttons, spring return

User assembly of other units, using body/contacts assemblies, see page 122; accessories, see page 138

Mushroom head push buttons <sup>(1)</sup> <sup>(2)</sup>							
Screw clamp terminal connections (Schneider Electric anti-retightening system)							
Shape of head	Type of push	Type of contact		Push Dia. (mm)	Color	Reference	Weight
							
		N/O	N/C				kg
<b>Complete units</b>							
	Mushroom head	1	-	40	Black	<b>XB5AC21</b> (ZB5AZ101 + ZB5AC2)	0.062
<b>Heads only</b>							
	Mushroom head			30	Black	<b>ZB5AC24</b>	0.027
					Green	<b>ZB5AC34</b>	0.027
					Red	<b>ZB5AC44</b>	0.027
					Yellow	<b>ZB5AC54</b>	0.027
					Blue	<b>ZB5AC64</b>	0.027
				40	Black	<b>ZB5AC2</b>	0.046
					Green	<b>ZB5AC3</b>	0.046
					Red	<b>ZB5AC4</b>	0.046
					Yellow	<b>ZB5AC5</b>	0.046
					Blue	<b>ZB5AC6</b>	0.046
				60	Black	<b>ZB5AR2</b>	0.065
					Green	<b>ZB5AR3</b>	0.065
					Red	<b>ZB5AR4</b>	0.065
					Yellow	<b>ZB5AR5</b>	0.065
					Blue	<b>ZB5AR6</b>	0.065
				60 (3) Hemispherical	Black	<b>ZB5AR216</b>	0.048
					Green	<b>ZB5AR316</b>	0.048
					Red	<b>ZB5AR416</b>	0.048
					Yellow	<b>ZB5AR516</b>	0.048
					Blue	<b>ZB5AR616</b>	0.048

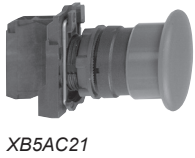

XB5AC21



ZB5AC24



ZB5AC2



ZB5AR4







ZB5AR216



(1) These push buttons and heads cannot be used for an Emergency Stop function. Therefore, it is recommended that a legend with a black or white background is used.  
 (2) Recommended maximum number of contacts constituting the body (mounting collar + contact) associated with the head, see page 96.  
 (3) Ergonomic product used in two-handed control applications. Recommended maximum number of contacts constituting the body (mounting collar + contact) associated with the head: 6.  
 Note: For contact block and mounting collar ordering information, see pages 122, 124, 125 and 126.



# Harmony™ XB5 plastic 22 mm push buttons Mushroom head push buttons, latching

User assembly of other units, using body/contacts assemblies, see page 122; accessories, see page 138

Mushroom head push buttons (1) (2)						
Shape of head	Type of reset	Push Dia. (mm)	Color	Reference	Weight kg	
 ZB5AT2		Push-pull	30	Black	ZB5AT24	0.044
			40	Black	ZB5AT2	0.049
			60	Black	ZB5AX2	0.067
 ZB5AS62		Turn to release	30	Black	ZB5AS42	0.040
			40	Black	ZB5AS52	0.044
			40	Yellow	ZB5AS55	0.044
			60	Black	ZB5AS62	0.064
 ZB5AS72		Key release (key no. 455) (2 keys included with head) (3)  (5)	30	Black	ZB5AS72	0.040
			40	Black	ZB5AS12 (4)	0.044
			60	Black	ZB5AS22	0.064

Illuminated mushroom head push buttons (2)						
Shape of head	Type of reset	Push Dia. (mm)	Color	Reference	Weight kg	
 ZB5AW733	 	Turn to release	40	White	ZB5AW713	0.022
				Green	ZB5AW733	0.022
				Orange	ZB5AW753	0.022
				Blue	ZB5AW763	0.022

(1) These push buttons and heads cannot be used for an Emergency Stop function. Therefore, it is recommended that a legend with a black or white background is used.

(2) Recommended maximum number of contacts constituting the body (mounting collar + contact) associated with the head, see page 96.

(3) For specific keys with other numbers, please consult your Regional Sales Office.

(4) Other key numbers:

- key no. 421E: add suffix 12 to the reference.

- key no. 458A: add suffix 10 to the reference.

- key no. 520E: add suffix 14 to the reference.

- key no. 3131A: add suffix 20 to the reference.

Example: To order a 40 mm black mushroom head for a latching push button, with release by key no. 421E, the reference becomes: ZB5AS1212.

(5) The symbol  indicates key withdrawal position(s).

(6) Only for use with bodies comprised of a light source with integral LED.

Note: For contact block and mounting collar ordering information, see pages 122, 124, 125 and 126.

For light module ordering information, see pages 123, 124 and 125.

# Harmony™ XB5 plastic 22 mm push buttons Emergency stop devices

Assembly of other products using body/contact assemblies, see page 122; combined sub-assemblies, see page 126; accessories, see pages 143 and 144

Mushroom head Emergency stop trigger action and mechanical latching push buttons conform to standards EN/IEC 60204-1 and EN/ISO 13850:2006, to Machinery Directive 98/37/EC and to standard EN/IEC60947-5-5. Please consult your Regional Sales Office for a full explanation of these standards and directives.

Emergency stop trigger action and mechanical latching push buttons <sup>(1) (2)</sup>						
Screw clamp terminal connections (Schneider Electric anti-retightening system)						
Shape of head	Type of reset	Type of contact		Push		Reference
		N/O	N/C	Dia. (mm)	Color	
						Weight
						kg

Complete units							
	Push-pull	1	1	40	Red	<b>XB5AT845</b> (ZB5AZ105 + ZB5AT84)	0.076
	Turn to release	1	1	40	Red	<b>XB5AS8445</b> (ZB5AZ105 + ZB5AS844)	0.072
		–	2	40	Red	<b>XB5AS8444</b> (ZB5AZ104 + ZB5AS844)	0.072
	Key release (key no. 455) 	1	1	40	Red	<b>XB5AS9445</b> (ZB5AZ105 + ZB5AS944)	0.112

Heads only						
Shape of head	Type of reset	Push		Reference	Weight	
		Dia. (mm)	Color			
	Push-pull	30	Red	<b>ZB5AT844</b>	0.050	
		40	Red	<b>ZB5AT84</b>	0.050	
		60	Red	<b>ZB5AX84</b>	0.050	
	Turn to release	30	Red	<b>ZB5AS834</b>	0.042	
		40	Red	<b>ZB5AS844</b>	0.046	
	Key release (key no. 455) 2 keys included with head (5) 	30	Red	<b>ZB5AS934</b>	0.068	
		40	Red	<b>ZB5AS944 (4)</b>	0.071	
		60	Red	<b>ZB5AS964</b>	0.092	
		40	Red	<b>ZB5AS944D</b>	0.071	

Bellows for harsh environments (IP 69K)					
For use in	Material	Color	Sold in lots of	Unit reference	Weight
Environments subject to humidity, dust, high pressure cleaning, etc.	Silicone	Red	2	<b>ZBZ48</b>	0.009
	EPDM	Black	2	<b>ZBZ28</b>	0.009
		Yellow	2	<b>ZBZ58</b>	0.009

Illuminated Emergency stop trigger action and mechanical latching push buttons with mechanical state indicator <sup>(1)</sup>					
For elevator inspection box applications					
Heads only <sup>(7)</sup>					
Shape of head	Type of reset	Push		Reference	Weight
		Dia. (mm)	Color		kg
	Push-pull (6)	40	Red	<b>ZB5AT8643M</b>	0.034

(1) Recommended maximum number of contacts constituting the body (mounting collar + contact) associated with the head, see page 96.  
 (2) It is recommended that a legend or yellow background is used.  
 (3) The symbol indicates key withdrawal position(s).  
 (4) Other key numbers:  
 - key no. 421E: add suffix **12** to the reference.  
 - key no. 458A: add suffix **10** to the reference.  
 - key no. 520E: add suffix **14** to the reference.  
 - key no. 3131A: add suffix **20** to the reference.  
 - key no. 4A185: add suffix **D** to the reference.  
 Example: To order a 40 mm red mushroom head for a trigger action and mechanical latching Emergency stop push button, with release by key no. 421E, the reference becomes: **ZB5AS94412**.  
 (5) For specific keys with other numbers, please consult your Regional Sales Office.  
 (6) Cannot be used with metal guards ZBZ160.  
 (7) Only for use with bodies comprised of a light source with integral LED.  
 Note: For contact block and mounting collar ordering information, see pages 122, 124, 125 and 126.  
 For light module ordering information, see pages 123, 124 and 125.



XB5AT845



XB5AS8445



XB5AS9445



ZB5AS844

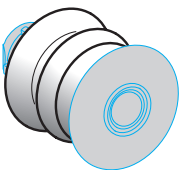

ZBZ•8

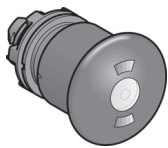

ZB5AT8643M

# Harmony™ XB5 plastic 22 mm push buttons Emergency switching off devices

Assembly of other products using body/contact assemblies, see page 122; combined sub-assemblies, see page 126; accessories, see pages 143 and 144

Mushroom head switching off mechanical latching push buttons conform to standards IEC60364-5-53 and EN/IEC60947-5-5. Please consult your Regional Sales Office for a full explanation of these standards and directives.

Emergency switching off, mechanical latching push buttons <sup>(1) (2)</sup>						
Screw clamp terminal connections (Schneider Electric anti-retightening system)						
Shape of head	Type of reset	Type of contact		Push		Reference
		N/O	N/C	Dia. (mm)	Color	
Weight						
kg						

**Complete units**



XB5AS542

	Push-pull	–	1	40	Red	<b>XB5AT42</b> (ZB5AZ102 + ZB5AT4)	0.065
	Turn to release	–	1	40	Red	<b>XB5AS542</b> (ZB5AZ102 + ZB5AS54)	0.060
	Key release (key no. 455)	–	1	40	Red	<b>XB5AS142</b> (ZB5AZ102 + ZB5AS14)	0.075

**Heads only**



ZB5AT4

	Push-pull			30	Red	<b>ZB5AT44</b>	0.049
				40	Red	<b>ZB5AT4</b>	0.049
				60	Red	<b>ZB5AX4</b>	0.067
	Turn to release			30	Red	<b>ZB5AS44</b>	0.040
				40	Red	<b>ZB5AS54</b>	0.044
				60	Red	<b>ZB5AS64</b>	0.064
	Key release (key no. 455) 2 keys included with head <sup>(5)</sup>			30	Red	<b>ZB5AS74</b>	0.040
				40	Red	<b>ZB5AS14</b> <sup>(4)</sup>	0.044
				60	Red	<b>ZB5AS24</b>	0.060
		Key release (key no. 4A185)		40	Red	<b>ZB5AS14D</b>	0.044



ZB5AS64



ZB5AS24

**Illuminated Emergency switching off, mechanical latching push buttons <sup>(1)</sup>**

Screw clamp terminal connections (Schneider Electric anti-retightening system)						
Shape of head	Type of reset	Push		Color	Reference	Weight
kg						

**Heads only <sup>(6)</sup>**

	Turn to release			40	Red	<b>ZB5AW743</b>	0.022
--	-----------------	--	--	----	-----	-----------------	-------



(1) Recommended maximum number of contacts constituting the body (mounting collar + contact) associated with the head, see page 96.

(2) It is recommended that a legend or yellow background is used.

(3) The symbol indicates key withdrawal position(s).

(4) Other key numbers:

- key no. 421E: add suffix **12** to the reference.

- key no. 458A: add suffix **10** to the reference.

- key no. 520E: add suffix **14** to the reference.

- key no. 3131A: add suffix **20** to the reference.

Example: To order a 40 mm red mushroom head for a mechanical latching Emergency switching off push button, with release by key no. 421E, the reference becomes: **ZB5AS1412**.

(5) For specific keys with other numbers, please consult your Regional Sales Office.

(6) Only for use with bodies comprised of a light source with integral LED.

Note: For contact block and mounting collar ordering information, see pages 122, 124, 125 and 126.

For light module ordering information, see pages 123, 124 and 125.

# Harmony™ XB5 plastic 22 mm push buttons Push buttons, push-turn to release

Assembly of other products using body/contact assemblies, see page 122; accessories, see page 138

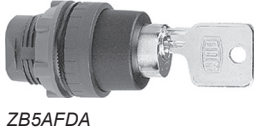

Push buttons with key-operated push (1)					
Shape of head	Type of push	Locking	Key withdrawal	Reference	Weight kg
<b>Heads only</b>					
	<b>Key no. 4A185</b>	Both positions	Both positions	<b>ZB5AFDA</b>	0.050
		Actuated position	Actuated position	<b>ZB5AFDB</b>	0.050
		Rest position	Rest position	<b>ZB5AFDC</b>	0.050
		Actuated position	Both positions	<b>ZB5AFDD</b>	0.050
	<b>Key LU1</b>	Both positions	Both positions	<b>ZB5AFDE01</b>	0.050
	<b>Key LU2</b>	Both positions	Both positions	<b>ZB5AFDE02</b>	0.050
	<b>Key LU3</b>	Both positions	Both positions	<b>ZB5AFDE03</b>	0.050
	<b>Key LU4</b>	Both positions	Both positions	<b>ZB5AFDE04</b>	0.050
	<b>Key LU5</b>	Both positions	Both positions	<b>ZB5AFDE05</b>	0.050
	<b>Key LU6</b>	Both positions	Both positions	<b>ZB5AFDE06</b>	0.050
	<b>Key LU7</b>	Both positions	Both positions	<b>ZB5AFDE07</b>	0.050
	<b>Key LU8</b>	Both positions	Both positions	<b>ZB5AFDE08</b>	0.050
	<b>Key LU9</b>	Both positions	Both positions	<b>ZB5AFDE09</b>	0.050
	<b>Key LU10</b>	Both positions	Both positions	<b>ZB5AFDE10</b>	0.050
	<b>Key LU11</b>	Both positions	Both positions	<b>ZB5AFDE11</b>	0.050
	<b>Key LU12</b>	Both positions	Both positions	<b>ZB5AFDE12</b>	0.050
	<b>Key LU13</b>	Both positions	Both positions	<b>ZB5AFDE13</b>	0.050
	<b>Key LU14</b>	Both positions	Both positions	<b>ZB5AFDE14</b>	0.050
	<b>Key LU15</b>	Both positions	Both positions	<b>ZB5AFDE15</b>	0.050



Push buttons with knurled push (1)					
Shape of head	Type of push	Marking	Reference	Weight kg	
<b>Heads only</b>					
	<b>Knurled without cap (2)</b>	–	<b>ZB5AF</b>	0.027	
	<b>Knurled with marked cap</b>	† (white on black background)	<b>ZB5AF351</b>	0.030	







(1) Recommended maximum number of contacts constituting the body (mounting collar + contact) associated with the head, see page 96.  
 (2) Colored caps to be ordered separately: see page 134.  
 Note: For contact block and mounting collar ordering information, see pages 122, 124, 125 and 126.

# Harmony™ XB5 plastic 22 mm push buttons

Selector switches with standard handle,  
Selector switches with long handle





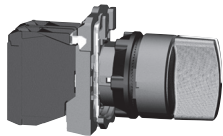

Assembly of other products using body/contact assemblies, see page 122; accessories, see page 138

Selector switches with standard handle (1)							Screw clamp terminal connections (Schneider Electric anti-retightening system)	
Shape of head	Type of operator	Type of contact		Positions		Reference	Weight	
		N/O	N/C	Number	Type			

Complete units								
	Standard handle, black	1	-	2-position 90°	Stay put		<b>XB5AD21</b> (ZB5AZ101 + ZB5AD2)	0.043
					Spring return from right to left		<b>XB5AD41</b> (ZB5AZ101 + ZB5AD4)	0.046
		1	1	3-position ± 45°	Stay put		<b>XB5AD25</b> (ZB5AZ105 + ZB5AD2)	0.043
		2	-		Stay put		<b>XB5AD33</b> (ZB5AZ103 + ZB5AD3)	0.043
				Spring return to center		<b>XB5AD53</b> (ZB5AZ103 + ZB5AD5)	0.043	



XB5AD33



Heads only									
	Standard handle, black	2-position 90°			Stay put		<b>ZB5AD2</b>	0.017	
					Spring return from right to left		<b>ZB5AD4</b>	0.020	
		3-position ± 45°				Stay put		<b>ZB5AD3</b>	0.017
						Spring return to center		<b>ZB5AD5</b>	0.017
						Spring return from left to center		<b>ZB5AD7</b>	0.017
						Spring return from right to center		<b>ZB5AD8</b>	0.017



ZB5AD2





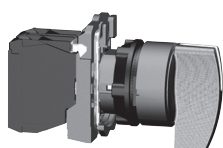

Heads only with other colored handles	
	Standard handle, white add suffix <b>01</b> to the reference, example: <b>ZB5AD201</b>
	Standard handle, green add suffix <b>03</b> to the reference, example: <b>ZB5AD203</b>
	Standard handle, red add suffix <b>04</b> to the reference, example: <b>ZB5AD204</b>
	Standard handle, yellow add suffix <b>05</b> to the reference, example: <b>ZB5AD205</b>
	Standard handle, blue add suffix <b>06</b> to the reference, example: <b>ZB5AD206</b>

Selector switches with long handle (1)							Screw clamp terminal connections (Schneider Electric anti-retightening system)	
Shape of head	Type of operator	Type of contact		Positions		Reference	Weight	
		N/O	N/C	Number	Type			

Complete units								
	Long handle, black	1	-	2-position 90°	Stay put		<b>XB5AJ21</b> (ZB5AZ101 + ZB5AJ2)	0.043
					2	-	3-position ± 45°	Stay put
						Spring return to center		<b>XB5AJ53</b> (ZB5AZ103 + ZB5AJ5)



ZB5AJ3

Heads only									
	Long handle, black	2-position 90°			Stay put		<b>ZB5AJ2</b>	0.017	
					Spring return from right to left		<b>ZB5AJ4</b>	0.020	
		3-position ± 45°				Stay put		<b>ZB5AJ3</b>	0.017
						Spring return to center		<b>ZB5AJ5</b>	0.017
						Spring return from left to center		<b>ZB5AJ7</b>	0.017
						Spring return from right to center		<b>ZB5AJ8</b>	0.017



















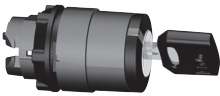





ZB5AJ

(1) Recommended maximum number of contacts and sequence of contacts constituting the body (mounting collar + contact) associated with the head, see page 96.  
Note: For contact block and mounting collar ordering information, see pages 122, 124, 125 and 126.

# Harmony™ XB5 plastic 22 mm push buttons

Key switches with key no. 455, 8D1, 421E, 458A, 520E or 3131A

Assembly of other products using body/contact assemblies, see page 122; accessories, see page 138

Key switches (1)								
Screw clamp terminal connections (Schneider Electric anti-retightening system)								
Shape of head	Type of operator	Type of contact		Positions		Reference	Weight	
		N/O	N/C	Number	Type (2)			
<b>Complete units</b>								
	Key switch with key no. 455	1	-	2-position 90°	Stay put		<b>XB5AG21</b> (ZB5AZ101 + ZB5AG2)	0.831
							<b>XB5AG41</b> (ZB5AZ101 + ZB5AG4)	0.831
		2	-	3-position ± 45°	Stay put		<b>XB5AG61</b> (ZB5AZ101 + ZB5AG6)	0.870
							<b>XB5AG03</b> (ZB5AZ103 + ZB5AG0)	0.831
						<b>XB5AG33</b> (ZB5AZ103 + ZB5AG3)	0.831	
<b>Heads only</b>								
	Key switch with key no. 455 (3) (4)			2-position 90°	Stay put		<b>ZB5AG2</b>	0.057
							<b>ZB5AG02</b>	0.057
				3-position ± 45°	Stay put		<b>ZB5AG4</b>	0.057
							<b>ZB5AG6</b>	0.061
							<b>ZB5AG0</b>	0.057
							<b>ZB5AG3</b>	0.057
							<b>ZB5AG5</b>	0.057
							<b>ZB5AG9</b>	0.057
							<b>ZB5AG09</b>	0.057
							<b>ZB5AG1</b>	0.057
							<b>ZB5AG7</b>	0.057
							<b>ZB5AG8</b>	0.057
		<b>ZB5AG05</b>	0.057					
		<b>ZB5AG08</b>	0.057					

(1) Recommended maximum number of contacts and sequence of contacts constituting the body (mounting collar + contact) associated with the head, see page 96.

(2) The symbol  indicates key withdrawal position(s).

(3) Other key numbers:

- key no. 421E: add suffix 12 to the reference.

- key no. 458A: add suffix 10 to the reference.

- key no. 520E: add suffix 14 to the reference.

- key no. 3131A: add suffix 20 to the reference.

Example: For a switch head with key no. 421E, 2-position stay put with key withdrawal from the left-hand position, the reference becomes: **ZB5AG212**.

(4) For specific keys with other numbers, please consult your Regional Sales Office.

Note: For contact block and mounting collar ordering information, see pages 122, 124, 125 and 126.































# Harmony™ XB5 plastic 22 mm push buttons

Key switches with key no. 8D1

Selector switches with knurled knob - Toggle switches





Assembly of other products using body/contact assemblies, see page 122; accessories, see page 138

Key switches (continued) (1)								
Screw clamp terminal connections (Schneider Electric anti-retightening system)								
Shape of head	Type of operator	Positions (2)		Reference	Weight kg			
		Number	Type					
	Key switch with key no. 8D1	2-position 90°	Stay put		ZB5AG2D	0.057		
					ZB5AG02D	0.057		
					ZB5AG4D	0.057		
			Spring return from right to left		ZB5AG6D	0.061		
				3-position ± 45°	Stay put		ZB5AG0D	0.057
							ZB5AG3D	0.057
			ZB5AG5D			0.057		
		Spring return from left to center	Stay put		ZB5AG9D	0.057		
					ZB5AG09D	0.057		
					ZB5AG03D	0.057		
			Spring return from right to center		ZB5AG04D	0.057		
					ZB5AG06D	0.057		
					ZB5AG1D	0.057		
		Spring return to center	Stay put		ZB5AG07D	0.057		
					ZB5AG8D	0.057		
					ZB5AG08D	0.057		
			Spring return from right to center		ZB5AG05D	0.057		
					ZB5AG05D	0.057		
	ZB5AG7D			0.057				

Selector switches with knurled knob (1)							
Shape of head	Type of operator	Positions		Reference	Weight kg		
		Number	Type				
	Black knurled knob	2-position 90°	Stay put		ZB5AD29	0.020	
				Spring return from right to left		ZB5AD49	0.024
						ZB5AD39	0.020
		3-position ± 45°	Stay put	Spring return to center		ZB5AD59	0.020
						ZB5AD79	0.020
						ZB5AD89	0.020
						ZB5AD89	0.020



ZB5AD39

Toggle switches (1)							
Shape of head	Type of operator	Positions		Reference	Weight kg		
		Number	Type				
	Black lever	2-position 90°	Stay put		ZB5AD28	0.023	
				Spring return		ZB5AD48	0.023
		White lever	2-position 90°		Stay put		ZB5AD2801
				Red lever		2-position 90°	Stay put
		Blue lever	2-position 90°		Stay put		



ZB5AD28

(1) Recommended maximum number of contacts and sequence of contacts constituting the body (mounting collar + contact) associated with the head, see page 96.

(2) The symbol  $\Omega$  indicates key withdrawal position(s).

Note: For contact block and mounting collar ordering information, see pages 122, 124, 125 and 126.





For light module ordering information, see pages 123, 124 and 125.



# Harmony™ XB5 plastic 22 mm push buttons

Illuminated selector switches with standard handle and integral LED

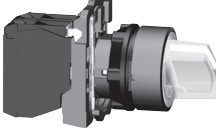
Assembly of other products using combined sub-assemblies, see page 126; accessories, see page 138

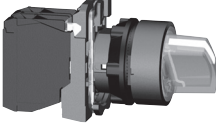
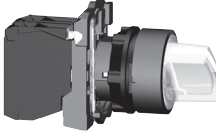
Illuminated selector switches with standard handle, with integral LED <sup>(1)</sup>														
Screw clamp terminal connections (Schneider Electric anti-retightening system)														
Shape of head	Type of operator	Type of contact	Positions Number Type	Supply voltage	Color of handle	Reference	Weight							
														
		N/O	N/C	V			kg							
<b>Complete units</b>														
 XB5AK123●5		Standard handle	1	1	2-position Stay put  90°	~ 24 (50/60 Hz)	Green <b>XB5AK123B5</b> (ZB5AW0B35 + ZB5AK1233)	0.516						
							Red <b>XB5AK124B5</b> (ZB5AW0B45 + ZB5AK1243)	0.516						
							Orange <b>XB5AK125B5</b> (ZB5AW0B55 + ZB5AK1253)	0.516						
						~ 110 to 120 (50/60 Hz)	Green <b>XB5AK123G5</b> (ZB5AW0G35 + ZB5AK1233)	0.516						
							Red <b>XB5AK124G5</b> (ZB5AW0G45 + ZB5AK1243)	0.516						
							Orange <b>XB5AK125G5</b> (ZB5AW0G55 + ZB5AK1253)	0.516						
						~ 230 to 240 (50/60 Hz)	Green <b>XB5AK123M5</b> (ZB5AW0M35 + ZB5AK1233)	0.516						
							Red <b>XB5AK124M5</b> (ZB5AW0M45 + ZB5AK1243)	0.516						
							Orange <b>XB5AK125M5</b> (ZB5AW0M55 + ZB5AK1253)	0.516						
						 XB5AK124●5						~ 24 (50/60 Hz)	Green <b>XB5AK133B5</b> (ZB5AW0B35 + ZB5AK1333)	0.516
													Red <b>XB5AK134B5</b> (ZB5AW0B45 + ZB5AK1343)	0.516
													Orange <b>XB5AK135B5</b> (ZB5AW0B55 + ZB5AK1353)	0.516
~ 110 to 120 (50/60 Hz)	Green <b>XB5AK133G5</b> (ZB5AW0G35 + ZB5AK1333)	0.516												
	Red <b>XB5AK134G5</b> (ZB5AW0G45 + ZB5AK1343)	0.516												
	Orange <b>XB5AK135G5</b> (ZB5AW0G55 + ZB5AK1353)	0.516												
~ 230 to 240 (50/60 Hz)	Green <b>XB5AK133M5</b> (ZB5AW0M35 + ZB5AK1333)	0.516												
	Red <b>XB5AK134M5</b> (ZB5AW0M45 + ZB5AK1343)	0.516												
	Orange <b>XB5AK135M5</b> (ZB5AW0M55 + ZB5AK1353)	0.516												
 XB5AK125●5												~ 24 (50/60 Hz)	Green <b>XB5AK133B5</b> (ZB5AW0B35 + ZB5AK1333)	0.516
													Red <b>XB5AK134B5</b> (ZB5AW0B45 + ZB5AK1343)	0.516
													Orange <b>XB5AK135B5</b> (ZB5AW0B55 + ZB5AK1353)	0.516
						~ 110 to 120 (50/60 Hz)	Green <b>XB5AK133G5</b> (ZB5AW0G35 + ZB5AK1333)	0.516						
							Red <b>XB5AK134G5</b> (ZB5AW0G45 + ZB5AK1343)	0.516						
							Orange <b>XB5AK135G5</b> (ZB5AW0G55 + ZB5AK1353)	0.516						
						~ 230 to 240 (50/60 Hz)	Green <b>XB5AK133M5</b> (ZB5AW0M35 + ZB5AK1333)	0.516						
							Red <b>XB5AK134M5</b> (ZB5AW0M45 + ZB5AK1343)	0.516						
							Orange <b>XB5AK135M5</b> (ZB5AW0M55 + ZB5AK1353)	0.516						









(1) Recommended maximum number of contacts constituting the body (mounting collar + contact) associated with the head, see page 96.

# Harmony™ XB5 plastic 22 mm push buttons

## Illuminated selector switches with standard handle and integral LED

Assembly of other products using combined sub-assemblies, see page 126; accessories, see page 138

### Illuminated selector switches with standard handle, with integral LED (continued) (1)

Shape of head	Type of operator	Positions		Color of handle	Reference	Weight kg	
		Number	Type				
<b>Heads only (2)</b>							
 ZB5AK1263	Standard handle	2-position 90°	Stay put		White	ZB5AK1213	0.016
				Green	ZB5AK1233	0.016	
				Red	ZB5AK1243	0.016	
				Orange	ZB5AK1253	0.016	
				Blue	ZB5AK1263	0.016	
			Spring return from right to left		White	ZB5AK1413	0.017
				Green	ZB5AK1433	0.017	
				Red	ZB5AK1443	0.017	
				Orange	ZB5AK1453	0.017	
				Blue	ZB5AK1463	0.017	
 ZB5AK1463	Standard handle	3-position ± 45°	Stay put		White	ZB5AK1313	0.016
				Green	ZB5AK1333	0.016	
				Red	ZB5AK1343	0.016	
				Orange	ZB5AK1353	0.016	
				Blue	ZB5AK1363	0.016	
			Spring return to center		White	ZB5AK1513	0.016
				Green	ZB5AK1533	0.016	
				Red	ZB5AK1543	0.016	
				Orange	ZB5AK1553	0.016	
				Blue	ZB5AK1563	0.016	
Spring return from right to center		White	ZB5AK1813	0.016			
	Green	ZB5AK1833	0.016				
	Red	ZB5AK1843	0.016				
	Orange	ZB5AK1853	0.016				
	Blue	ZB5AK1863	0.016				
Spring return from left to center		White	ZB5AK1713	0.016			
	Green	ZB5AK1733	0.016				
	Red	ZB5AK1743	0.016				
	Orange	ZB5AK1753	0.016				
	Blue	ZB5AK1763	0.016				

(1) Recommended maximum number of contacts constituting the body (mounting collar + contact) associated with the head, see page 96.

(2) Only for use with bodies comprised of a light source with integral LED.

Note: For contact block and mounting collar ordering information, see pages 122, 124, 125 and 126.  
For light module ordering information, see pages 123, 124 and 125.

# Harmony™ XB5 plastic 22 mm push buttons Pilot lights with integral LED

Assembly of other products using light block sub-assemblies, see page 130; accessories, see pages 134 and 138

## Pilot lights with integral LED Screw clamp terminal connections (Schneider Electric anti-retightening system)





XB5AVB1

Shape of head	Supply voltage V	Color	Reference	Weight kg
<b>Complete units</b>				
■ With plain lens				
 <b>Protected LED</b>	~ 24 (50/60 Hz)	White	<b>XB5AVB1</b> (ZB5AVB1 + ZB5AV013)	0.038
		Green	<b>XB5AVB3</b> (ZB5AVB3 + ZB5AV033)	0.038
		Red	<b>XB5AVB4</b> (ZB5AVB4 + ZB5AV043)	0.038
		Orange	<b>XB5AVB5</b> (ZB5AVB5 + ZB5AV053)	0.038
		Blue	<b>XB5AVB6</b> (ZB5AVB6 + ZB5AV063)	0.038
		White	<b>XB5AVG1</b> (ZB5AVG1 + ZB5AV013)	0.038
	~ 110 to 120 (50/60 Hz)	Green	<b>XB5AVG3</b> (ZB5AVG3 + ZB5AV033)	0.038
		Red	<b>XB5AVG4</b> (ZB5AVG4 + ZB5AV043)	0.038
		Orange	<b>XB5AVG5</b> (ZB5AVG5 + ZB5AV053)	0.038
		Blue	<b>XB5AVG6</b> (ZB5AVG6 + ZB5AV063)	0.038
		White	<b>XB5AVM1</b> (ZB5AVM1 + ZB5AV013)	0.038
		Green	<b>XB5AVM3</b> (ZB5AVM3 + ZB5AV033)	0.038
	~ 230 to 240 (50/60 Hz)	Red	<b>XB5AVM4</b> (ZB5AVM4 + ZB5AV043)	0.038
		Orange	<b>XB5AVM5</b> (ZB5AVM5 + ZB5AV053)	0.038
		Blue	<b>XB5AVM6</b> (ZB5AVM6 + ZB5AV063)	0.038

### Heads only, circular (1)



ZB5AV053

Shape of head	For use with body comprised of light source type	Color of lens	Reference	Weight kg
■ With plain lens				
 <b>Protected LED</b>	Integral LED only	White	<b>ZB5AV013</b>	0.017
		Green	<b>ZB5AV033</b>	0.017
		Red	<b>ZB5AV043</b>	0.017
		Orange	<b>ZB5AV053</b>	0.017
		Blue	<b>ZB5AV063</b>	0.017
		5 colors (2) (3)	<b>ZB5AV003</b>	0.017
■ With plain lens, for insertion of legend (3)				
 <b>Protected LED</b>	Integral LED only	White	<b>ZB5AV013E</b>	0.017
		Green	<b>ZB5AV033E</b>	0.017
		Red	<b>ZB5AV043E</b>	0.017
		Orange	<b>ZB5AV053E</b>	0.017
		Blue	<b>ZB5AV063E</b>	0.017
■ With grooved lens (4)				
 <b>Protected LED</b>	Integral LED only	White	<b>ZB5AV013S</b>	0.017
		Green	<b>ZB5AV033S</b>	0.017
		Red	<b>ZB5AV043S</b>	0.017
		Orange	<b>ZB5AV053S</b>	0.017
		Blue	<b>ZB5AV063S</b>	0.017

### Heads only, square (1)



ZB5CV063

■ With plain lens				
 <b>Protected LED</b>	Integral LED only	White	<b>ZB5CV013</b>	0.020
		Green	<b>ZB5CV033</b>	0.020
		Red	<b>ZB5CV043</b>	0.020
		Orange	<b>ZB5CV053</b>	0.020
		Blue	<b>ZB5CV063</b>	0.020
		5 colors (2)	<b>ZB5CV003</b>	0.028

(1) Only for use with bodies comprised of a light source with integral LED.

(2) Head supplied with 5 different colored lenses (white, green, red, orange, blue) not fitted, for insertion of legend.

(3) For legend ordering information: see page 138.

(4) For use in bright ambient light conditions (outdoors in sunlight, for example).

Note: For contact block and mounting collar ordering information, see pages 122, 124, 125 and 126.

For light module ordering information, see pages 123, 124 and 125.

# Harmony™ XB5 plastic 22 mm push buttons

Pilot lights with integral LED and with BA 9s base fitting

Assembly of other products using light block sub-assemblies, see page 130; accessories, see pages 134 and 138

## Pilot lights with integral LED and transformer (1.2 VA, 24 V secondary)

Screw clamp terminal connections (Schneider Electric anti-retightening system)

Shape of head	Supply voltage V	Color	Reference (1)	Weight kg
<b>Complete units - With plain lens</b>				
	~ 400 - 50 Hz (1)	White	<b>XB5AV5B1</b>	0.133
		Green	<b>XB5AV5B3</b>	0.133
		Red	<b>XB5AV5B4</b>	0.133
		Orange	<b>XB5AV5B5</b>	0.133
		Blue	<b>XB5AV5B6</b>	0.133





XB5AV5B●

Protected  
LED

## Pilot lights with BA 9s base fitting, with plain or grooved lens

Screw clamp terminal connections (Schneider Electric anti-retightening system)

Shape of head	Supply voltage V	Color	Reference	Weight kg
<b>Complete units - With plain lens</b>				
■ Direct supply, for BA 9s bulb, U ≤ 250 V, 2.4 W max (bulb not included)				
	≤ 250	White	<b>XB5AV61</b> (ZB5AV6 + ZB5AV01)	0.037
		Green	<b>XB5AV63</b> (ZB5AV6 + ZB5AV03)	0.037
		Red	<b>XB5AV64</b> (ZB5AV6 + ZB5AV04)	0.037
		Orange	<b>XB5AV65</b> (ZB5AV6 + ZB5AV05)	0.037
■ Via integral transformer, 1.2 VA, 6 V secondary, with BA 9s incandescent bulb (included)				
	~ 110 to 120 - 50/60 Hz	White	<b>XB5AV31</b> (ZB5AV3 + ZB5AV01)	0.109
		Green	<b>XB5AV33</b> (ZB5AV3 + ZB5AV03)	0.109
		Red	<b>XB5AV34</b> (ZB5AV3 + ZB5AV04)	0.109
		Orange	<b>XB5AV35</b> (ZB5AV3 + ZB5AV05)	0.109
	~ 230 - 50 Hz	White	<b>XB5AV41</b> (ZB5AV4 + ZB5AV01)	0.110
	~ 220 to 240 - 60 Hz	Green	<b>XB5AV43</b> (ZB5AV4 + ZB5AV03)	0.110
		Red	<b>XB5AV44</b> (ZB5AV4 + ZB5AV04)	0.110
		Orange	<b>XB5AV45</b> (ZB5AV4 + ZB5AV05)	0.110



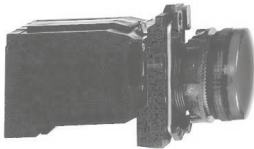

XB5AV63



XB5AV34

## Heads only (1)

Shape of head	For use with body comprised of light source type	Color of lens	Reference	Weight kg
■ With plain lens				
	<b>With BA 9s base fitting</b>	White	<b>ZB5AV01</b>	0.018
		Green	<b>ZB5AV03</b>	0.018
		Red	<b>ZB5AV04</b>	0.018
		Orange	<b>ZB5AV05</b>	0.018
		Blue	<b>ZB5AV06</b>	0.018
		Clear	<b>ZB5AV07</b>	0.018
■ With grooved lens (2)				
	<b>With BA 9s base fitting</b>	White	<b>ZB5AV01S</b>	0.017
		Green	<b>ZB5AV03S</b>	0.017
		Red	<b>ZB5AV04S</b>	0.017
		Orange	<b>ZB5AV05S</b>	0.017
		Blue	<b>ZB5AV06S</b>	0.017
		Clear	<b>ZB5AV07S</b>	0.017



ZB5AV01

(1) To order ~ 440 to 460 V - 60 Hz transformer blocks, please replace "5" in the reference by "8". Example: XB5AV5B1 becomes XB5AV8B1. To order ~ 550 to 600 V - 60 Hz blocks, please replace "5" by "9". Example: XB5AV5B1 becomes XB5AV9B1.

(2) Only for use with bodies comprised of a light source with BA 9s base fitting (incandescent, neon or LED).

(3) For use in bright ambient light conditions (outdoors in sunlight, for example).

Note: For contact block and mounting collar ordering information, see pages 122, 124, 125 and 126.



For light module ordering information, see pages 123, 124 and 125.

# Harmony™ XB5 plastic 22 mm push buttons

Push buttons for manual overload reset, hour counters, buzzers, fuse carrier

Assembly of other products using body/contact assemblies, see page 122; accessories, see page 138

## Manual overload reset buttons (travel 10 mm)

Shape of head	Actuation distance mm	Marking	Color	Reference	Weight kg	
<b>Without cap (1)</b>						
	17 to 120	–	–	<b>XB5AA801</b>	0.027	
	120 to 257	–	–	<b>XB5AA802</b>	0.040	
<b>With flush push</b>						
	17 to 120	Without	Green	<b>XB5AA831</b>	0.027	
			Red	<b>XB5AA841</b>	0.027	
			Blue	<b>XB5AA861</b>	0.027	
	120 to 257	Without	O	Red	<b>XB5AA84101</b>	0.027
			R	Blue	<b>XB5AA86102</b>	0.027
			Green	<b>XB5AA832</b>	0.040	
			Red	<b>XB5AA842</b>	0.040	
	120 to 257	Without	Blue	<b>XB5AA862</b>	0.040	
			O	Red	<b>XB5AA84201</b>	0.040
	120 to 257	Without	R	Blue	<b>XB5AA86202</b>	0.040
<b>With projecting push</b>						
	17 to 120	O	Red	<b>XB5AL84101</b>	0.027	
	120 to 257	O	Red	<b>XB5AL84201</b>	0.040	



XB5AA

## Heads + mounting base for potentiometer (2)

Shape of head	Description	For use with	Reference	Weight kg
	For potentiometer with shaft length 45 to 50 mm	6 mm shaft	<b>ZB5AD912</b>	0.032
		6.35 mm shaft	<b>ZB5AD922</b>	0.032



ZB5AD

## Hour counters

Specifications	Supply voltage V	Reference	Weight kg
Indication 0 to 9999.9	~ 12 to 24 - 50/60 Hz	<b>XB5DSB</b>	0.045
	~ 120 - 60 Hz	<b>XB5DSG</b>	0.045
	~ 230 to 240 - 50 Hz	<b>XB5DSM</b>	0.045



XB5DS●

## Annunciators (IP 40 NEMA 1)

85 db buzzer: 4 kHz, with continuous or intermittent operation (connection diagram: see page 148)	~ 24 - 50/60 Hz	<b>XB5KSB</b>	0.035
	~ 120 - 50/60 Hz	<b>XB5KSG</b>	0.035
	~ 230 to 240 - 50 Hz	<b>XB5KSM</b>	0.035



XB5KS●

## Fuse carrier

Description	For use with	Reference	Weight kg
Fuse carrier	5 x 20 mm fuse 6.3 A - 250 V	<b>XB5DT1S</b>	0.022



XB5DT1S

(1) Colored cap to be ordered separately: see page 134.

(2) Potentiometer not included.

Note: For contact block and mounting collar ordering information, see pages 122, 124, 125 and 126.

# Harmony™ XB5 plastic 22 mm push buttons Joystick controllers

Assembly of other products using accessories, see page 138



XD5PA12



ZD5PA103

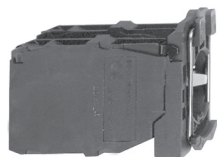

ZD5PA203



ZD5PA12

## Joystick controllers (with 54 mm long operating shaft) (1) Screw clamp terminal connections (Schneider Electric anti-retightening system)

Description	Operation	Spring return to zero position	Reference	Weight kg
<b>Complete products</b>				
2-direction	1 notch 1 N/O contact per direction	Without	<b>XD5PA12</b>	0.060
		With	<b>XD5PA22</b>	0.060
4-direction	1 notch 1 N/O contact per direction	Without	<b>XD5PA14</b>	0.077
		With	<b>XD5PA24</b>	0.077

## Sub-assemblies for joystick controllers

Description	For use with	Reference	Weight kg	
<b>Complete body/contact assemblies</b>	2-direction	<b>ZD5PA103</b>	0.049	
	4-direction	<b>ZD5PA203</b>	0.058	
<b>Complete head assemblies with operating shaft</b>	2-direction, stay put	<b>ZD5PA12</b>	0.022	
	2-direction, spring return to zero position	<b>ZD5PA22</b>	0.022	
	4-direction, stay put	<b>ZD5PA14</b>	0.022	
	4-direction, spring return to zero position	<b>ZD5PA24</b>	0.022	
<b>Legends 30 x 48 mm for engraving</b>	2-direction	Black one side Red reverse	<b>ZBG2201</b>	0.001
		White one side Yellow reverse	<b>ZBG2401</b>	0.001
		<b>ZBG2401</b>	0.001	
<b>Legends 48 x 48 mm for engraving</b>	4-direction	Black one side Red reverse	<b>ZBG4201</b>	0.002
		White one side Yellow reverse	<b>ZBG4401</b>	0.002
		<b>ZBG4401</b>	0.002	

(1) Must not be used with standard contact blocks ZBE10● (single) or ZBE20● (double).

Note: For contact block and mounting collar ordering information, see pages 122, 124, 125 and 126.

**Other versions** Joystick controllers and complete body/contact assemblies for joystick controllers with Faston® connector terminals (6.35 or 2 x 2.8). Please consult your Regional Sales Office.



# Harmony™ XB5 plastic 22 mm push buttons

Body/contact assemblies  
Screw clamp terminal connections

To combine with heads, see pages 98 to 121



ZB5AZ009



ZBE101



ZBE203



ZB5AZ101

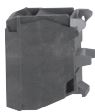

ZBE201



ZB5AZ106

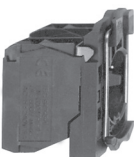

ZB5AZ107

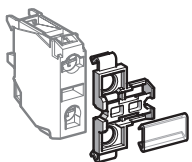

ZBZ001

### Body/mounting collar

For use with	Sold in lots of	Unit reference	Weight kg
Electrical block (contact or light)	10	ZB5AZ009	0.006

### Contact functions (1)

Screw clamp terminal connections (Schneider Electric anti-retightening system)

#### Contacts for standard applications

Description	Type of contact	N/O	N/C	Sold in lots of	Unit reference	Weight kg	
Contact blocks	Single	1	–	5	ZBE101	0.011	
		–	1	5	ZBE102	0.011	
	Double	2	–	5	ZBE203	0.020	
		–	2	5	ZBE204	0.020	
	Single with body/mounting collar	1	1	5	ZBE205	0.020	
		1	–	1	ZB5AZ101	0.021	
		–	1	1	ZB5AZ102	0.021	
		2	–	1	ZB5AZ103	0.030	
		–	2	1	ZB5AZ104	0.030	
		1	1	1	ZB5AZ105	0.030	
			1	2	1	ZB5AZ141	0.040

#### Contacts for specific applications

Application	Type of contact	Description	N/O	N/C	Sold in lots of	Unit reference	Weight kg	
Low power switching	Single	Standard	1	–	5	ZBE1016	0.012	
			–	1	5	ZBE1026	0.012	
		Dusty environment (2) (IP5X, 50 µm dust)	1	–	5	ZBE1016P	0.012	
			–	1	5	ZBE1026P	0.012	
Staggered contacts	Single	Early make N/O	1	–	5	ZBE201	0.011	
			–	1	5	ZBE202	0.011	
		Single with body/ mounting collar	Overlapping N/O+N/C	1	1	5	ZB5AZ106	0.030
			Staggered N/O+N/C	2	–	5	ZB5AZ107	0.030

### Clip-on legend holder, sheet of blank legends and labelling software (4)

Description	Sold in lots of	Unit reference	Weight kg
Clip-on legend-holder for electrical blocks with screw clamp terminal connections (4). For identification of an XB5A control or signaling unit	10	ZBZ001	0.001
Sheet of 50 blank legends for legend holder ZBZ001	10	ZBY001	0.023

(1) The contact blocks enable variable composition of body/contact assemblies. Maximum number of rows possible: 3. Either 3 rows of 3 single contacts or 1 row of 3 double contacts + 1 row of 3 single contacts (double contacts occupy the first 2 rows). Maximum number of contacts is specified on page 96.

(2) It is not possible to fit an additional contact block on the back of these contact blocks.

(3) It is not possible to fit an additional contact block on the back of these contact blocks or to use these contacts with light blocks.

(4) This legend holder is not compatible with high power switching contacts.



# Harmony™ XB5 plastic 22 mm push buttons

## Light blocks

### “Remote test light” - Protection

To combine with heads, see page 102

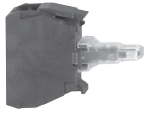

ZBVB●

Light blocks with screw clamp terminal connections (Schneider Electric anti-retightening system)						
Description	Supply voltage V	Color of light source	Sold in lots of	Unit reference	Weight kg	
Integral LED (to combine with heads for integral LED)	~ 12 (50/60 Hz)	White	5	ZBVJ1	0.017	
		Green	5	ZBVJ3	0.017	
		Red	5	ZBVJ4	0.017	
		Orange	5	ZBVJ5	0.017	
		Blue	5	ZBVJ6	0.017	
		White	5	ZVB1	0.017	
	~ 24 (50/60 Hz)	Green	5	ZVB3	0.017	
		Red	5	ZVB4	0.017	
		Orange	5	ZVB5	0.017	
		Blue	5	ZVB6	0.017	
		~ 24 to 120 (50/60 Hz)	White	5	ZVBG1	0.017
			Green	5	ZVBG3	0.017
Red	5		ZVBG4	0.017		
Orange	5		ZVBG5	0.017		
Blue	5		ZVBG6	0.017		
~ 110 to 120 (50/60 Hz)	White		5	ZVG1	0.017	
	Green	5	ZVG3	0.017		
	Red	5	ZVG4	0.017		
	Orange	5	ZVG5	0.017		
	Blue	5	ZVG6	0.017		
	~ 230 to 240 (50/60 Hz)	White	5	ZVM1	0.017	
Green		5	ZVM3	0.017		
Red		5	ZVM4	0.017		
Orange		5	ZVM5	0.017		
Blue		5	ZVM6	0.017		

Flashing light blocks with screw clamp terminal connections (Schneider Electric anti-retightening system)					
Description	Supply voltage V	Color of light source	Sold in lots of	Unit reference	Weight kg
Integral LED (to combine with heads for integral LED)	~ 24 (50/60 Hz)	White	5	ZBV18B1	0.017
		Green	5	ZBV18B3	0.017
		Red	5	ZBV18B4	0.017
		Orange	5	ZBV18B5	0.017
		Blue	5	ZBV18B6	0.017
		~ 110 to 120 (50/60 Hz)	White	5	ZBV18G1
	Green		5	ZBV18G3	0.017
	Red		5	ZBV18G4	0.017
	Orange		5	ZBV18G5	0.017
	Blue		5	ZBV18G6	0.017
	~ 230 to 240 (50/60 Hz)		White	5	ZBV18M1
		Green	5	ZBV18M3	0.017
Red		5	ZBV18M4	0.017	
Orange		5	ZBV18M5	0.017	
Blue		5	ZBV18M6	0.017	



ZBV 5B



ZBZG156



ZBZM156



ZBZV●

Transformer blocks for 24 V light blocks				
For use with	Supply voltage V	Description	Reference	Weight kg
Light blocks with integral LED	~ 400 V - 50 Hz	Transformers 400 V - 24 V ~	ZBV5B (1)	0.090

Light blocks for “remote test” function				
Light blocks	Supply voltage V	Description	Reference	Weight kg
Light blocks with integral LED	~ 12 and 24	Single module, 1 connecting wire	ZBZG156 (2)	0.010
	~ 24 to 120			
Light blocks with integral LED	~ 48 to 230	Double module, with connecting wires	ZBZM156 (3)	0.010

LED suppressors				
For use with	Supply voltage V	Level of protection	Reference	Weight kg
Light blocks with integral LED fitted with screw clamp terminal connections	~ 120	25 to 120 VA	ZBZVG	0.010
	~ 230	30 to 230 VA	ZBZVM	0.010

(1) To order ~ 440 to 460 V - 60 Hz transformer blocks, please replace «5» in the reference by «8»: ZBV 5B becomes ZBV 8B.

To order ~ 550 to 600 V - 60 Hz transformer blocks, please replace «5» by «9»: ZBV 5B becomes ZBV 9B.

(2) Block for use with ~ light blocks with integral LED types ZBVJ●, ZVB●, ZVBG● or with direct supply light block for BA 9s bulb, ZBV6.

(3) Block for use ~ light blocks integral LED types ZVG●, ZVM●, see connection on page 156.

# Harmony™ XB5 plastic 22 mm push buttons

Body/contact assemblies

Spring clamp terminal connections

To combine with heads, see pages 98 to 121



ZB5AZ009

### Body/mounting collar

For use with	Sold in lots of	Unit reference	Weight kg
Electrical block (contact or light)	10	ZB5AZ009	0.006



ZBE 1015

### Contact functions

#### Spring clamp terminal connections (1)

#### Contacts for standard applications

Description	Type of contact	Circuit symbols		Sold in lots of	Unit reference	Weight kg
		N/O	N/C			
Contact blocks	Single	1	–	4	ZBE1015	0.011
		–	1	4	ZBE1025	0.011
Contact blocks	Single with body/mounting collar	1	–	1	ZB5AZ1015	0.021
		–	1	1	ZB5AZ1025	0.021
		2	–	1	ZB5AZ1035	0.030
		–	2	1	ZB5AZ1045	0.030
		1	1	1	ZB5AZ1055	0.030



ZB5AZ1015

### Light blocks

#### Spring clamp terminal connections (1)

Description	Supply voltage V	Color of light source	Sold in lots of	Unit reference	Weight kg
Integral LED (to combine with heads for integral LED)	≈ 12 (50/60 Hz)	White	4	ZBVJ15	0.016
		Green	4	ZBVJ35	0.016
		Red	4	ZBVJ45	0.016
		Orange	4	ZBVJ55	0.016
		Blue	4	ZBVJ65	0.016
Protected LED	≈ 24 (50/60 Hz)	White	4	ZBVB15	0.016
		Green	4	ZBVB35	0.016
		Red	4	ZBVB45	0.016
		Orange	4	ZBVB55	0.016
		Blue	4	ZBVB65	0.016
	~ 110 to 120 (50/60 Hz)	White	4	ZBVG15	0.016
		Green	4	ZBVG35	0.016
		Red	4	ZBVG45	0.016
		Orange	4	ZBVG55	0.016
		Blue	4	ZBVG65	0.016
	~ 230 to 240 (50/60 Hz)	White	4	ZBVM15	0.016
		Green	4	ZBVM35	0.016
		Red	4	ZBVM45	0.016
		Orange	4	ZBVM55	0.016
		Blue	4	ZBVM65	0.016

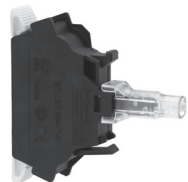

ZBV B35

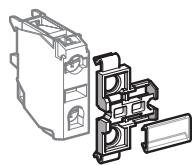

ZBZ001

### Sheet of 50 blank legends

For use with	Sold in lots of	Unit reference	Weight kg
Legend holder ZBZ001	10	ZBY001	0.023

(1) It is not possible to fit an additional block on the back of these contact or light blocks.

# Harmony™ XB5 plastic 22 mm push buttons Body/contact assemblies For printed circuit board

To combine with heads, see pages 98 to 121



ZB5AZ009

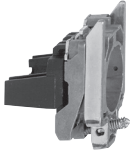

ZB5AZ079 + ZB5AZ009

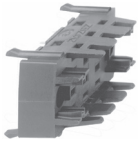

ZBZ010



ZBE701



ZBE702



ZBVB07

## Body/mounting collar and accessories specifically for printed circuit board mounting (1)

### Accessories required when using adaptor (socket) ZBZ010

Description	For use with	Sold in lots of	Unit reference	Weight kg
Body/mounting collar	Electrical block (contact or light)	10	ZB5AZ009	0.006
Mounting collar/pillar	Printed circuit board support (mounting screw ZBZ006 to be ordered separately)	10	ZB5AZ079	0.003
Mounting screw for printed circuit board	Mounting collar/pillar ZB5AZ079	10	ZBZ006	0.011

### Adapter (socket) (1)

For use with	Thickness of printed circuit board (mm)	Sold in lots of	Unit reference	Weight kg
Electrical block (contact or light)	1.6 ± 0.2	10	ZBZ010	0.008
	2.2 ± 0.2	10	ZBZ011	0.008
	3.2 ± 0.2	10	ZBZ012	0.008

## Contact functions (1)

### Contacts for standard applications

Description	Type of contact			Sold in lots of	Unit reference	Weight kg
Contact blocks	Single	N/O	N/C	5	ZBE701	0.011
		1	–			
		–	1	5	ZBE702	0.011

### Contacts for specific applications

Application	Type of contact			Sold in lots of	Unit reference	Weight kg
Low power switching	Single	N/O	N/C	5	ZBE7016	0.012
		1	–			
		–	1	5	ZBE7026	0.012

## Light blocks (1)

Description	Supply voltage V	Color of LED	Sold in lots of	Unit reference	Weight kg
Integral LED (to combine with heads for integral LED)	≈ 24 (50/60 Hz)	White	5	ZBVB17	0.004
		Green	5	ZBVB37	0.004
		Red	5	ZBVB47	0.004
		Orange	5	ZBVB57	0.004
		Blue	5	ZBVB67	0.004



(1) For details of support drilling and of printed circuit board: see page 159

# Harmony™ XB5 plastic 22 mm push buttons

Body/contact assemblies  
Faston® connectors

To combine with heads, see pages 98 to 121

## Contact functions (1) Faston connectors (6.35 or 2 x 2.8 mm)

### Contacts for standard applications

Description	Type of contact	Symbol		Sold in lots of	Unit reference	Weight kg
		N/O	N/C			
Contact blocks	Single	1	–	5	ZBE1013	0.011
		–	1	5	ZBE1023	0.011
	Double	2	–	5	ZBE2033	0.020
		–	2	5	ZBE2043	0.020
		1	1	5	ZBE2053	0.020
	Single with body/mounting collar	1	–	1	ZB5AZ1013 (2)	0.021
		–	1	1	ZB5AZ1023 (2)	0.021
		2	–	1	ZB5AZ1033	0.030
		–	2	1	ZB5AZ1043	0.030
1		1	1	ZB5AZ1053	0.030	



ZBE 1023

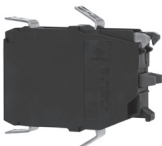

ZBE 2043

### Contacts for specific applications

Application	Type of contact	Description	Symbol		Sold in lots of	Unit reference	Weight kg
			N/O	N/C			
Low power switching	Single	Standard	1	–	5	ZBE10163 (2)	0.012
			–	1	5	ZBE10263 (2)	0.012
		Dusty environments (3) (IP5X, 50 µm dust)	1	–	5	ZBE1016P3 (2)	0.012
			–	1	5	ZBE1026P3 (2)	0.012
Staggered contacts	Single	Early make	1	–	5	ZBE2013 (2)	0.011
			–	1	5	ZBE2023 (2)	0.011
		Late break	–	1	5	ZBE2023 (2)	0.011
			1	1	1	ZBE5053	0.033
High power switching	Single	Standard (4)	1	–	1	ZBE5013	0.021
			–	1	1	ZBE5023	0.021
			2	–	1	ZBE5033	0.033
			–	2	1	ZBE5043	0.033
			1	1	1	ZBE5053	0.033



ZBE 5043

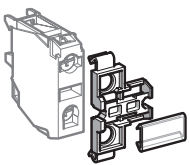

ZBZ001

### Clip-on legend holder for electrical blocks with screw clamp terminal connections (5)

For use with	Sold in lots of	Unit reference	Weight kg
Identification of an XB5A control or signaling unit	10	ZBZ001	0.001
Sheet of 50 blank legends	10	ZBY001	0.023

(1) The contact blocks enable variable composition of body/contact assemblies. Maximum number of rows possible: 3. Either 3 rows of 3 single contacts or 1 row of 3 double contacts + 1 row of 3 single contacts (double contacts occupy the first 2 rows).  
 (2) To order products with screw clamp terminal connections for lugs, replace the 3 at the end of the reference with a 9. Example: ZBE1013 becomes ZBE1019.  
 (3) It is not possible to fit an additional contact block on the back of these contact blocks.  
 (4) It is not possible to fit an additional contact block on the back of these contact blocks or to use these contacts with light blocks.  
 (5) This legend holder is not compatible with high power switching contacts.

# Harmony™ XB5 plastic 22 mm push buttons

Body/contact assemblies  
Plug-in connector

To combine with heads, see pages 98 to 121



ZB5AZ009



ZBE1014



ZBE1024



ZB5AZ1014



ZB5AZ1024



ZBVB4

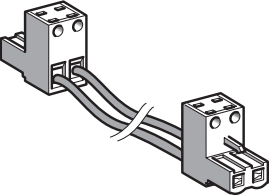

APE1C2250

### Body/mounting collar

For use with	Sold in lots of	Unit reference	Weight kg
Electrical block (contact or light)	10	ZB5AZ009	0.006

### Contact functions Plug-in connector (1)

#### Contacts for standard applications

Description	Type of contact	Circuit symbols		Sold in lots of	Unit reference	Weight kg
		N/O	N/C			
Contact blocks	Single	1	–	5	ZBE1014	0.011
		–	1	5	ZBE1024	0.011
Contact blocks	Single with body/mounting collar	1	–	1	ZB5AZ1014	0.018
		–	1	1	ZB5AZ1024	0.018
		2	–	1	ZB5AZ1034	0.026
		–	2	1	ZB5AZ1044	0.026
		1	1	1	ZB5AZ1054	0.026
		1	2	1	ZB5AZ1414	0.036

### Light blocks Plug-in connector

Description	Supply voltage (V)	Color of light source	Sold in lots of	Unit reference	Weight kg
Integral LED (to combine with heads for integral LED)	≈ 24 (50/60 Hz)	White	5	ZBVB14	0.016
		Green	5	ZBVB34	0.016
		Red	5	ZBVB44	0.016
		Orange	5	ZBVB54	0.016
		Blue	5	ZBVB64	0.016
		Protected LED	~ 110 to 120 (50/60 Hz)	White	5
Green	5			ZBVG34	0.016
Red	5			ZBVG44	0.016
Orange	5			ZBVG54	0.016
Blue	5			ZBVG64	0.016
Protected LED	~ 230 to 240 (50/60 Hz)			White	5
		Green	5	ZBVM34	0.016
		Red	5	ZBVM44	0.016
		Orange	5	ZBVM54	0.016
		Blue	5	ZBVM64	0.016

### Connecting cables and connector



Description	Number of connectors	Wire c.s.a. mm²	Length mm	Sold in lots of	Unit reference	Weight kg
Cables with connectors 2-pin, 5.08 mm pitch	1	0.75	500	8	APE1C2150	0.120
	2	0.75	500	8	APE1C2250	0.180
Spring terminal connector 2-pin, 5.08 mm pitch	–	0.2 to 2.5	–	10	APE1PRE21	0.003

(1) It is not possible to fit an additional contact block on the back of these contact blocks.

# Harmony™ XB5 plastic 22 mm push buttons

Body/contact assemblies + light blocks with integral LED

To combine with heads, see pages 103 to 117; contacts, see page 122

Complete body/contact assemblies and light blocks (1)						
Screw clamp terminal connections (Schneider Electric anti-retightening system)						
Light source	Supply voltage	Type of contact		Color of light source	Reference	Weight
	V					kg
		N/O	N/C			
<b>Direct supply</b>						
<b>Integral LED</b> 	≈ 24 (50/60 Hz)	1	–	White	<b>ZB5AW0B11</b>	0.032
				Green	<b>ZB5AW0B31</b>	0.032
				Red	<b>ZB5AW0B41</b>	0.032
				Orange	<b>ZB5AW0B51</b>	0.032
				Blue	<b>ZB5AW0B61</b>	0.032
		–	1	White	<b>ZB5AW0B12</b>	0.032
				Green	<b>ZB5AW0B32</b>	0.032
				Red	<b>ZB5AW0B42</b>	0.032
				Orange	<b>ZB5AW0B52</b>	0.032
				Blue	<b>ZB5AW0B62</b>	0.032
	2	–	White	<b>ZB5AW0B13</b>	0.042	
			Green	<b>ZB5AW0B33</b>	0.042	
			Red	<b>ZB5AW0B43</b>	0.042	
			Orange	<b>ZB5AW0B53</b>	0.042	
			Blue	<b>ZB5AW0B63</b>	0.042	
	1	1	White	<b>ZB5AW0B15</b>	0.042	
			Green	<b>ZB5AW0B35</b>	0.042	
			Red	<b>ZB5AW0B45</b>	0.042	
			Orange	<b>ZB5AW0B55</b>	0.042	
			Blue	<b>ZB5AW0B65</b>	0.042	
~ 110 to 120 (50/60 Hz)	1	–	White	<b>ZB5AW0G11</b>	0.032	
			Green	<b>ZB5AW0G31</b>	0.032	
			Red	<b>ZB5AW0G41</b>	0.032	
			Orange	<b>ZB5AW0G51</b>	0.032	
			Blue	<b>ZB5AW0G61</b>	0.032	
	–	1	White	<b>ZB5AW0G12</b>	0.032	
			Green	<b>ZB5AW0G32</b>	0.032	
			Red	<b>ZB5AW0G42</b>	0.032	
			Orange	<b>ZB5AW0G52</b>	0.032	
			Blue	<b>ZB5AW0G62</b>	0.032	
2	–	White	<b>ZB5AW0G13</b>	0.042		
		Green	<b>ZB5AW0G33</b>	0.042		
		Red	<b>ZB5AW0G43</b>	0.042		
		Orange	<b>ZB5AW0G53</b>	0.042		
		Blue	<b>ZB5AW0G63</b>	0.042		
1	1	White	<b>ZB5AW0G15</b>	0.042		
		Green	<b>ZB5AW0G35</b>	0.042		
		Red	<b>ZB5AW0G45</b>	0.042		
		Orange	<b>ZB5AW0G55</b>	0.042		
		Blue	<b>ZB5AW0G65</b>	0.042		



ZB5AW0...1

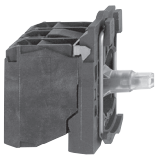

ZB5AW0...3

(1) Can be fitted with additional contact blocks: see page 122.

**Other versions**



Complete bodies with Faston® connector terminals (6.35 or 2 x 2.8). Please consult your Regional Sales Office.

# Harmony™ XB5 plastic 22 mm push buttons

Body/contact assemblies + light blocks  
with integral LED

To combine with heads, see pages 103 to 117; contacts, see page 122

## Complete body/contact assemblies and light blocks (1) (continued) Screw clamp terminal connections (Schneider Electric anti-retightening system)

Light source	Supply voltage	Type of contact		Color of light source	Reference	Weight
		 N/O	 N/C			
	V					kg
<b>Direct supply (continued)</b>						
Integral LED <b>Protected LED</b>	~ 230 to 240 (50/60 Hz)	1	–	White	<b>ZB5AW0M11</b>	0.032
				Green	<b>ZB5AW0M31</b>	0.032
				Red	<b>ZB5AW0M41</b>	0.032
				Orange	<b>ZB5AW0M51</b>	0.032
				Blue	<b>ZB5AW0M61</b>	0.032
		–	1	White	<b>ZB5AW0M12</b>	0.032
				Green	<b>ZB5AW0M32</b>	0.032
				Red	<b>ZB5AW0M42</b>	0.032
				Orange	<b>ZB5AW0M52</b>	0.032
				Blue	<b>ZB5AW0M62</b>	0.032
		2	–	White	<b>ZB5AW0M13</b>	0.042
				Green	<b>ZB5AW0M33</b>	0.042
				Red	<b>ZB5AW0M43</b>	0.042
				Orange	<b>ZB5AW0M53</b>	0.042
				Blue	<b>ZB5AW0M63</b>	0.042
1	1	White	<b>ZB5AW0M15</b>	0.042		
		Green	<b>ZB5AW0M35</b>	0.042		
		Red	<b>ZB5AW0M45</b>	0.042		
		Orange	<b>ZB5AW0M55</b>	0.042		
		Blue	<b>ZB5AW0M65</b>	0.042		

(1) Can be fitted with additional contact blocks: see page 122.

### Other versions

Complete bodies with Faston® connector terminals (6.35 or 2 x 2.8).  
Please consult your Regional Sales Office.

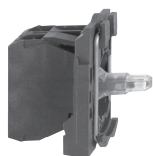

ZB5AW0M11

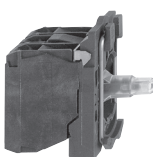

ZB5AW0M33



# Harmony™ XB5 plastic 22 mm push buttons

Body/light assemblies for pilot lights  
with integral LED

To combine with heads, see page 118; contacts, see page 122

**Complete light bodies** (mounting collar + light block with integral LED)  
**Screw clamp terminal connections** (Schneider Electric anti-retightening system)

Light source	Supply voltage V	Color of light source	Reference	Weight kg
Integral LED	≈ 12 (50/60 Hz)	White	<b>ZB5AVJ1</b>	0.022
		Green	<b>ZB5AVJ3</b>	0.022
		Red	<b>ZB5AVJ4</b>	0.022
		Orange	<b>ZB5AVJ5</b>	0.022
		Blue	<b>ZB5AVJ6</b>	0.022
		≈ 24 (1) (50/60 Hz)	White	<b>ZB5AVB1</b>
Green	<b>ZB5AVB3</b>		0.022	
Red	<b>ZB5AVB4</b>		0.022	
Orange	<b>ZB5AVB5</b>		0.022	
Blue	<b>ZB5AVB6</b>		0.022	
≈ 24 to 120 (50/60 Hz)	White		<b>ZB5AVBG1</b>	0.022
	Green	<b>ZB5AVBG3</b>	0.022	
	Red	<b>ZB5AVBG4</b>	0.022	
	Orange	<b>ZB5AVBG5</b>	0.022	
	Blue	<b>ZB5AVBG6</b>	0.022	
	≈ 110 to 120 (1) (50/60 Hz)	White	<b>ZB5AVG1</b>	0.022
Green		<b>ZB5AVG3</b>	0.022	
Red		<b>ZB5AVG4</b>	0.022	
Orange		<b>ZB5AVG5</b>	0.022	
Blue		<b>ZB5AVG6</b>	0.022	
≈ 230 to 240 (1) (50/60 Hz)		White	<b>ZB5AVM1</b>	0.022
	Green	<b>ZB5AVM3</b>	0.022	
	Red	<b>ZB5AVM4</b>	0.022	
	Orange	<b>ZB5AVM5</b>	0.022	
	Blue	<b>ZB5AVM6</b>	0.022	



ZB5AV●●

Protected  
LED

(1) Complete bodies with Faston® connector terminals (6.35 or 2 x 2.8), see page 123.

# Harmony™ XB5 plastic 22 mm push buttons

Body/light assemblies for pilot lights  
with integral LED

To combine with heads, see page 118; contacts, see page 122



ZB5AVB●156

## Complete light bodies with 3-terminal "remote test" function (mounting collar + light block with integral LED + pre-wired block for "remote test light" function) Screw clamp terminal connections (Schneider Electric anti-retightening system)

Light source	Supply voltage V	Color of light source	Reference	Weight kg
Integral LED <b>Protected LED</b>	≈ 24 (1) (50/60 Hz)	White	ZB5AVB1156	0.022
		Green	ZB5AVB3156	0.022
		Red	ZB5AVB4156	0.022
		Orange	ZB5AVB5156	0.022
		Blue	ZB5AVB6156	0.022

## Complete bodies with flashing pilot light (mounting collar + light block with integral LED) Screw clamp terminal connections (Schneider Electric anti-retightening system)

Light source	Supply voltage V	Color of light source	Reference	Weight kg
Integral LED <b>Protected LED</b>	≈ 24 (50/60 Hz)	White	ZB5AV18B1	0.022
		Green	ZB5AV18B3	0.022
		Red	ZB5AV18B4	0.022
		Orange	ZB5AV18B5	0.022
		Blue	ZB5AV18B6	0.022
	≈ 110 to 120 (50/60 Hz)	White	ZB5AV18G1	0.022
		Green	ZB5AV18G3	0.022
		Red	ZB5AV18G4	0.022
		Orange	ZB5AV18G5	0.022
		Blue	ZB5AV18G6	0.022
	≈ 230 to 240 (50/60 Hz)	White	ZB5AV18M1	0.022
		Green	ZB5AV18M3	0.022
		Red	ZB5AV18M4	0.022
		Orange	ZB5AV18M5	0.022
		Blue	ZB5AV18M6	0.022

(1) For a ~ 120 or 230 V supply, use complete body ZB5AVG● or ZB5AVM● with block for "remote test light" function type ZBZM156, see page 123.

# Harmony™ XB5 plastic 22 mm push buttons

Body/contact assemblies + light blocks  
with BA 9s base fitting

To combine with heads, see page 102 to 115; contacts, see page 122

Complete body/contact assemblies and light blocks <sup>(1)</sup>							
For bulb with BA 9s base fitting (incandescent, neon or LED)							
Screw clamp terminal connections (Schneider Electric anti-retightening system)							
Light source	Supply voltage	Type of contact		Color of light source	Reference	Weight	
		N/O	N/C				
	V					kg	
<b>Direct supply</b>							
BA 9s base fitting bulb, 2.4 W max., not included <sup>(2)</sup>	≤ 250	1	–	–	ZB5AW061	0.031	
		–	1	–	ZB5AW062	0.031	
		2	–	–	ZB5AW063	0.041	
		1	1	–	ZB5AW065	0.041	
<b>Supply via integral transformer (1.2 VA, 6 V secondary)</b>							
Incandescent BA 9s base fitting bulb, included	~ 110 to 120 50/60 Hz	1	–	–	ZB5AW031	0.110	
		1	1	–	ZB5AW035	0.119	
	~ 230 50 Hz	1	–	–	ZB5AW041	0.110	
		1	1	–	ZB5AW045	0.119	
	~ 220 to 240 60 Hz	1	–	–	ZB5AW051	0.110	
		1	1	–	ZB5AW055	0.119	
	BA9s base fitting LED, included	~ 110 to 120 50/60 Hz	1	1	White	ZB5AW03D15	0.119
					Green	ZB5AW03D35	0.119
					Red	ZB5AW03D45	0.119
					Orange	ZB5AW03D55	0.119
Blue					ZB5AW03D65	0.119	
~ 230 50 Hz		1	1	White	ZB5AW04D15	0.119	
				Green	ZB5AW04D35	0.119	
				Red	ZB5AW04D45	0.119	
				Orange	ZB5AW04D55	0.119	
				Blue	ZB5AW04D65	0.119	
~ 220 to 240 60 Hz		1	1	White	ZB5AW05D15	0.120	
				Green	ZB5AW05D35	0.120	
				Red	ZB5AW05D45	0.120	
				Orange	ZB5AW05D55	0.120	
				Blue	ZB5AW05D65	0.120	



ZB5AW065

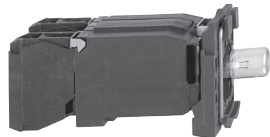

ZB5AW035

(1) Can be fitted with additional contact blocks: see page 122.  
(2) Bulb to be ordered separately: see page 146.

**Other versions**

Complete bodies with integral transformer incorporating Faston® connector terminals (6.35 or 2 x 2.8). Please consult your Regional Sales Office.

# Harmony™ XB5 plastic 22 mm push buttons

Light bodies for pilot lights  
with BA 9s base fitting

To combine with heads, see page 123; contacts, see page 122

**Light blocks**  
**Screw clamp terminal connections** (Schneider Electric anti-retightening system)

Description	Supply voltage V	Sold in lots of	Unit reference	Weight kg
Direct supply for BA 9s base fitting bulb, 2.4 W max., not included (1)	≤ 250	5	ZBV6	0.016

**Complete light bodies** (mounting collar + light block )  
**For bulb with BA 9s base fitting (incandescent, neon or LED)**  
**Screw clamp terminal connections** (Schneider Electric anti-retightening system)

Light source	Supply voltage V	Color of light source	Reference	Weight kg
<b>Direct supply</b>				
BA 9s base fitting bulb, 2.4 W max, not included (1)	≤ 250	–	ZB5AV6	0.022
<b>Supply via integral transformer (1.2 VA, 6 V secondary)</b>				
BA 9s base fitting incandescent bulb, included	~ 110 to 120 -50/60 Hz	–	ZB5AV3	0.099
	~ 230 - 50 Hz	–	ZB5AV4	0.099
	~ 220 to 240 - 60 Hz	–	ZB5AV5	0.099
	~ 400 - 50 Hz	–	ZB5AV5	0.099
	~ 440 to 480 - 60 Hz	–	ZB5AV8	0.099
	~ 550 to 600 - 60 Hz	–	ZB5AV9	0.099



ZB5AV6

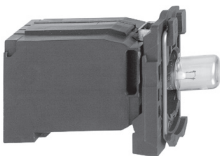

ZB5AV3

BA 9s base fitting LED, included	~ 110 to 120 - 50/60 Hz	White	ZB5AV3D1	0.102
		Green	ZB5AV3D3	0.102
		Red	ZB5AV3D4	0.102
		Orange	ZB5AV3D5	0.102
		Blue	ZB5AV3D6	0.102
		Blue	ZB5AV3D6	0.102
	~ 230 - 50 Hz ~ 220 to 240 - 60 Hz	White	ZB5AV4D1	0.102
		Green	ZB5AV4D3	0.102
		Red	ZB5AV4D4	0.102
		Orange	ZB5AV4D5	0.102
		Blue	ZB5AV4D6	0.102
		Blue	ZB5AV4D6	0.102
	~ 400 - 50/60 Hz	White	ZB5AV5D1	0.102
		Green	ZB5AV5D3	0.102
		Red	ZB5AV5D4	0.102
		Orange	ZB5AV5D5	0.102
		Blue	ZB5AV5D6	0.102
		Blue	ZB5AV5D6	0.102

**Complete light bodies with 3-terminal “remote test” function** (mounting collar + light block)  
**For bulb with BA 9s base fitting (incandescent, neon or LED)**  
**Screw clamp terminal connections** (Schneider Electric anti-retightening system)

Light source	Supply voltage V	Reference	Weight kg
<b>Direct supply</b>			
BA 9s base fitting bulb, 2.4 W max, not included (1)	≤ 250	ZB5AV156	0.021

(1) Bulb to be ordered separately, see page 146.



ZB5AV156

**Other versions** Complete bodies with Faston® connector terminals (6.35 or 2 x 2.8), see page 123.

# Harmony™ XB5 plastic 22 mm push buttons

## Accessories for heads Caps



ZBA●



ZBL●

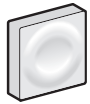

ZBC 1

Push button caps - unmarked					
For use with	Type of push	Color	Sold in lots of	Unit reference	Weight kg
ZB5AA0 circular push button heads supplied without cap	Flush	White	10	ZBA1	0.001
		Black	10	ZBA2	0.001
		Green	10	ZBA3	0.001
		Red	10	ZBA4	0.001
		Yellow	10	ZBA5	0.001
		Blue	10	ZBA6	0.001
		6 colors (1)	1	ZBA9	0.006
	Projecting	White	10	ZBL1	0.001
		Black	10	ZBL2	0.001
		Green	10	ZBL3	0.001
		Red	10	ZBL4	0.001
		Yellow	10	ZBL5	0.001
		Blue	10	ZBL6	0.001
		6 colors (1)	1	ZBL9	0.006
ZB5CA0 square push button heads supplied without cap	Flush	White	10	ZBC1	0.001
		Black	10	ZBC2	0.001
		Green	10	ZBC3	0.001
		Red	10	ZBC4	0.001
		Yellow	10	ZBC5	0.001
		Blue	10	ZBC6	0.001

(1) Set of 6 different colored caps: white, black, green, red, yellow, blue.



# Harmony™ XB5 plastic 22 mm push buttons

Accessories for heads  
Marked push button caps



ZBA●33

## Push button caps - marked

For use with	Type of push	Marking		Color of cap	Unit reference	Weight kg
		Text	Color			
ZB5AA0 circular push button heads supplied without cap (sold in lots of 10)	Flush	I (1)	White	Green	ZBA331	0.001
			Black	White	ZBA131	0.001
		II	White	Green	ZBA336	0.001
			Black	White	ZBA136	0.001
		III	White	Green	ZBA337	0.001
			Black	White	ZBA137	0.001
		IV	White	Green	ZBA338	0.001
			Black	White	ZBL138	0.001
START (1)			White	Green	ZBA333	0.001
			Black	White	ZBA133	0.001
ON			White	Green	ZBA341	0.001
			Black	White	ZBA141	0.001
UP (1)			Black	White	ZBA343	0.001
DOWN (1)			White	Black	ZBA344	0.001
 (1)			White	Black	ZBA245	0.001
			Black	White	ZBA145	0.001
↑ (2)			White	Black	ZBA335	0.001
			Black	White	ZBA334	0.001
O (1)			White	Red	ZBA432	0.001
				Black	ZBA232	0.001
ARRET			White	Red	ZBA433	0.001
				Black	ZBA233	0.001
STOP (1)			White	Red	ZBA434	0.001
				Black	ZBA234	0.001
OFF			White	Red	ZBA435	0.001
				Black	ZBA235	0.001
			White	Green	ZBA346	0.001
R (1)			White	Blue	ZBA639	0.001
+			White	Black	ZBA2934	0.001
-			White	Black	ZBA2935	0.001

(1) Double injection molded marking.

(2) Can be clipped-in at 90° steps, through 360°

# Harmony™ XB5 plastic 22 mm push buttons

## Accessories for heads

### Boots



ZBP0

#### Transparent boots for push buttons <sup>(1)</sup>

Description	For use with push button types	Sold in lots of	Unit reference	Weight kg
Single boots	Flush with circular head	10	ZBPA	0.002
	Projecting with circular head	10	ZBP0	0.002
	Flush or projecting with circular head for food industry applications	10	ZBP0A	0.002

#### Colored boots

Description	Color	Sold in lots of	Unit reference	Weight kg
Colored boots (can be replaced without dismantling the head)	Black	10	ZB2BP012	0.003
	Green	10	ZB2BP013	0.003
	Red	10	ZB2BP014	0.003
	Orange	10	ZB2BP015	0.003
	Blue	10	ZB2BP016	0.003

(1) Boots for multiple-headed push buttons: see page 107.



# Harmony™ XB5 plastic 22 mm push buttons

Accessories for heads

Lens caps



ZBV01●3

Lens caps				
For use with	Color	Sold in lots of	Unit reference	Weight kg
<b>Circular lens caps for light sources with integral LED</b>				
Pilot lights	White	10	ZBV0113	0.002
	Green	10	ZBV0133	0.002
	Red	10	ZBV0143	0.002
	Orange	10	ZBV0153	0.002
	Blue	10	ZBV0163	0.002
	5 different colored grooved lenses (1)	1	ZBV0103S	0.010
Illuminated push buttons, with flush push	White	10	ZBW9113	0.002
	Green	10	ZBW9133	0.002
	Red	10	ZBW9143	0.002
	Orange	10	ZBW9153	0.002
	Blue	10	ZBW9163	0.002
Illuminated push buttons, with projecting push	White	10	ZBW9313	0.002
	Green	10	ZBW9333	0.002
	Red	10	ZBW9343	0.002
	Orange	10	ZBW9353	0.002
	Blue	10	ZBW9363	0.002
<b>Square lens caps for light sources with integral LED</b>				
Pilot lights	White	10	ZBCV0113	0.002
	Green	10	ZBCV0133	0.002
	Red	10	ZBCV0143	0.002
	Orange	10	ZBCV0153	0.002
	Blue	10	ZBCV0163	0.002
Illuminated push buttons, with flush push	White	10	ZBCW9113	0.002
	Green	10	ZBCW9133	0.002
	Red	10	ZBCW9143	0.002
	Orange	10	ZBCW9153	0.002
	Blue	10	ZBCW9163	0.002
Illuminated push buttons, with projecting push	White	10	ZBCW9313	0.002
	Green	10	ZBCW9333	0.002
	Red	10	ZBCW9343	0.002
	Orange	10	ZBCW9353	0.002
	Blue	10	ZBCW9363	0.002
<b>Circular lens caps for light sources with BA 9s base fitting</b>				
Pilot lights	White	10	ZBV011	0.002
	Green	10	ZBV013	0.002
	Red	10	ZBV014	0.002
	Orange	10	ZBV015	0.002
	Blue	10	ZBV016	0.002
	Clear	10	ZBV017	0.002
	Illuminated push buttons, with flush push	White	10	ZBW911
Green		10	ZBW913	0.002
Red		10	ZBW914	0.002
Orange		10	ZBW915	0.002
Blue		10	ZBW916	0.002
Clear		10	ZBW917	0.002
Illuminated push buttons, with projecting push	White	10	ZBW931	0.002
	Green	10	ZBW933	0.002
	Red	10	ZBW934	0.002
	Orange	10	ZBW935	0.002
	Blue	10	ZBW936	0.002
	Clear	10	ZBW937	0.002

(1) Clear, green, red, orange, blue.



ZBV01●

# Harmony™ XB5 plastic 22 mm push buttons

8 x 27 mm legends with  
30 x 40 mm legend holders



ZBZ34



ZBYH101

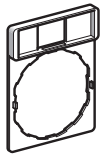

ZBZ32

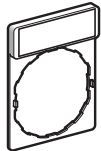

ZBY101

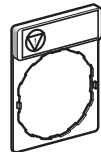

ZBY4140

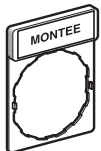

ZBY2107

### 30 x 40 mm legend holders (flush mounting with bezel) for 8 x 27 mm legends (1)

Description	Legend		Sold in lots of	Unit reference	Weight kg
	Color	Marking			
Without legend	–	–	10	ZBZ34	0.003
With blank legend	Black or red background	–	10	ZBY2H101	0.004
	White or yellow background	–	10	ZBY4H101	0.004

### Standard (30 x 40 mm) legend holders for 8 x 27 mm legends (1)

Description	Legend		Sold in lots of	Unit reference	Weight kg		
	Color	Marking					
Without legend	–	–	10	ZBZ32	0.001		
With blank legend (for engraving)	Black or red background	–	10	ZBY2101	0.002		
	White or yellow background	–	10	ZBY4101	0.002		
With 8 x 27 mm legend (with International marking)	Black or red background (2)	O (black background)	1	ZBY2146	0.002		
		O (red background)	1	ZBY2931	0.002		
		I	1	ZBY2147	0.002		
		II	1	ZBY2148	0.002		
		O-I	1	ZBY2178	0.002		
		I-II	1	ZBY2179	0.002		
		I-O-II	1	ZBY2186	0.002		
		AUTO	1	ZBY2115	0.002		
		STOP	1	ZBY2304	0.002		
		Yellow background		1	ZBY4140 (3)	0.002	
		With 8 x 27 mm legend (with French language marking)	Black or red background (2)	ARRET (red backgr.)	1	ZBY2104	0.002
				ARRET (black backgr.)	1	ZBY0104	0.002
				ARRET GENERAL	1	ZBY2129	0.002
				ARRET REARMEMENT	1	ZBY2133	0.002
				ARRET-MARCHE	1	ZBY2166	0.002
				ARRIERE	1	ZBY2106	0.002
AUTO CYCLE-CYCLE	1			ZBY2198	0.002		
AUTO CYCLE-MAIN	1			ZBY2199	0.002		
AUTO-MAIN	1			ZBY2164	0.002		
AUTO-O-MAIN	1			ZBY2185	0.002		
AVANT	1			ZBY2105	0.002		
AVANT-O-ARRIERE	1			ZBY2184	0.002		
C-P-C-NORMAL	1			ZBY2165	0.002		
CYCLE-MAIN	1			ZBY2197	0.002		
DECLENCHEMENT	1			ZBY2132	0.002		
DEFAUT (black backgr.)	1			ZBY2134	0.002		
DEFAUT (red backgr.)	1			ZBY2135	0.002		
DEPART CYCLE	1			ZBY2195	0.002		
DESCENTE	1			ZBY2108	0.002		
DROITE	1			ZBY2109	0.002		
ENCLENCHEMENT	1			ZBY2131	0.002		
EN SERVICE	1			ZBY2111	0.002		
FERMETURE	1			ZBY2114	0.002		
GAUCHE	1			ZBY2110	0.002		
HORS SERVICE	1			ZBY2112	0.002		
HORS-EN	1			ZBY2167	0.002		
LENT	1			ZBY2127	0.002		
MAIN	1			ZBY2116	0.002		
MARCHE	1			ZBY2103	0.002		
MONTEE	1			ZBY2107	0.002		
OUVERTURE	1			ZBY2113	0.002		
PHASE / PHASE	1			ZBY2196	0.002		
REARMEMENT (red background)	1			ZBY2123	0.002		
REARMEMENT (black background)	1	ZBY0123	0.002				
SOUS TENSION	1	ZBY2126	0.002				
VITE	1	ZBY2128	0.002				
Red background	ARRET D'URGENCE	1	ZBY2130 (3)	0.002			

(1) For legends, see pages 140 to 142.

(2) "Start" functions: white letters on black background. "Stop" functions: white letters on red background (unless otherwise specified above).

(3) For complying with ISO 13850:2006 standard, paragraph 4.4.6., Emergency Stop function logo has been added.

# Harmony™ XB5 plastic 22 mm push buttons

8 x 27 mm legends with  
30 x 40 mm legend holders



ZBY2303

## Standard (30 x 40 mm) legend holders with 8 x 27 mm legends (continued)

Description	Legend Color	Marking	Reference	Weight kg		
With legend (with English language marking)	Black or red background (1)	AUTO-HAND	ZBY2364	0.002		
		AUTO-O-HAND	ZBY2385	0.002		
		CLOSE	ZBY2314	0.002		
		DOWN	ZBY2308	0.002		
		FAST	ZBY2328	0.002		
		FORWARD	ZBY2305	0.002		
		HAND	ZBY2316	0.002		
		HAND-OFF-AUTO	ZBY2387	0.002		
		INCH	ZBY2321	0.002		
		LEFT	ZBY2310	0.002		
		OFF	ZBY2312	0.002		
		OFF-ON	ZBY2367	0.002		
		ON	ZBY2311	0.002		
		OPEN	ZBY2313	0.002		
		POWER ON	ZBY2326	0.002		
		RESET (red background)	ZBY2323	0.002		
		RESET (black background)	ZBY2322	0.002		
		REVERSE	ZBY2306	0.002		
		RIGHT	ZBY2309	0.002		
		RUN	ZBY2334	0.002		
		SLOW	ZBY2327	0.002		
		START	ZBY2303	0.002		
		STOP-START	ZBY2366	0.002		
		UP	ZBY2307	0.002		
			Red background	EMERGENCY STOP	ZBY2330 (2)	0.002
		With legend (with German language marking)	Black or red background (1)	AB	ZBY2208	0.002
AUF	ZBY2207			0.002		
AUS	ZBY2204			0.002		
AUS-EIN	ZBY2266			0.002		
AUS-IN BETRIEB	ZBY2267			0.002		
AUS-RÜCKSTELLUNG	ZBY2233			0.002		
AUSSCHALTEN	ZBY2232			0.002		
AUTO-HAND	ZBY2364			0.002		
AUTO-O-HAND	ZBY2385			0.002		
AUTOZYKL-HAND	ZBY2299			0.002		
AUTOZYKL- 1 ZYKL	ZBY2298			0.002		
C-P-C-NORMAL	ZBY2265			0.002		
EIN	ZBY2203			0.002		
EINSCHALTEN	ZBY2231			0.002		
HAND	ZBY2316			0.002		
LANGSAM	ZBY2227			0.002		
LINKS	ZBY2210			0.002		
NOT-AUS (red background)	ZBY2230			0.002		
ÖFFNEN	ZBY2213			0.002		
RECHTS	ZBY2209			0.002		
RÜCKSTELLUNG	ZBY2223			0.002		
SCHLIESSEN	ZBY2214			0.002		
SCHNELL	ZBY2228			0.002		
SPANNUNG EIN	ZBY2226			0.002		
STEUERUNG AUS	ZBY2212			0.002		
STEUERUNG EIN	ZBY2211			0.002		
STÖRUNG (black background)	ZBY2234			0.002		
STÖRUNG (red background)	ZBY2235			0.002		
VOR	ZBY2205			0.002		
VOR-O-ZURÜCK	ZBY2284			0.002		
ZURÜCK	ZBY2206			0.002		
ZYKLUS-HAND	ZBY2297			0.002		
ZYKLUSSTART	ZBY2295			0.002		
	Red background	NOT-HALT	ZBY2229 (2)	0.002		
	Yellow background	NOT-HALT	ZBY22420001 (2)	0.002		

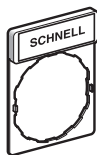

ZBY2228

(1) "Start" functions: white letters on black background. "Stop" functions: white letters on red background (unless otherwise specified above).  
 (2) For complying with ISO 13850:2006 standard, paragraph 4.4.6., Emergency Stop function logo  has been added.

# Harmony™ XB5 plastic 22 mm push buttons 8 x 27 mm legends

8 x 27 mm marked legends (for 30 x 40 mm legend holders ZBZ32 and ZBZ34)						
Color	Marking		Reference	Weight kg		
Without	White or yellow	O (black background)	ZBY0102	0.001		
International	Black or red (1)	O (black background)	ZBY02146	0.001		
		O (red background)	ZBY02931	0.001		
		I	ZBY02147	0.001		
		II	ZBY02148	0.001		
		O-I	ZBY02178	0.001		
		I-II	ZBY02179	0.001		
		I-O-II	ZBY02186	0.001		
		AUTO	ZBY02115	0.001		
		STOP	ZBY02304	0.001		
		Red		ZBY0140 (2)	0.001	
		French	Black or red (1)	ARRET (red background)	ZBY02104	0.001
				ARRET (black background)	ZBY00104	0.001
ARRET GENERAL	ZBY02129			0.001		
ARRET REARMEMENT	ZBY02133			0.001		
ARRET-MARCHE	ZBY02166			0.001		
ARRIERE	ZBY02106			0.001		
AUTO CYCLE-CYCLE	ZBY02198			0.001		
AUTO CYCLE-MAIN	ZBY02199			0.001		
AUTO-MAIN	ZBY02164			0.001		
AUTO-O-MAIN	ZBY02185			0.001		
AVANT	ZBY02105			0.001		
AVANT-O-ARRIERE	ZBY02184			0.001		
C-P-C-NORMAL	ZBY02165			0.001		
CYCLE-MAIN	ZBY02197			0.001		
DECLENCHEMENT	ZBY02132			0.001		
DEFAUT (black background)	ZBY02134			0.001		
DEFAUT (red background)	ZBY02135			0.001		
DEPART CYCLE	ZBY02195			0.001		
DESCENTE	ZBY02108			0.001		
DROITE	ZBY02109			0.001		
ENCLANCHEMENT	ZBY02131			0.001		
EN SERVICE	ZBY02111			0.001		
FERMETURE	ZBY02114			0.001		
GAUCHE	ZBY02110			0.001		
HORS SERVICE	ZBY02112			0.001		
HORS-EN	ZBY02167			0.001		
LENT	ZBY02127			0.001		
MAIN	ZBY02116			0.001		
MARCHE	ZBY02103			0.001		
MONTEE	ZBY02107			0.001		
OUVERTURE	ZBY02113			0.001		
PHASE / PHASE	ZBY02196			0.001		
REARMEMENT (red background)	ZBY02123			0.001		
REARMEMENT (black background)	ZBY00123			0.001		
SOUS TENSION	ZBY02126	0.001				
VITE	ZBY02128	0.001				
Red	ARRET D'URGENCE	ZBY02130	0.001			

(1) "Start" functions: white letters on black background. "Stop" functions: white letters on red background (unless otherwise specified above)  
 (2) For complying with ISO 13850:2006 standard, paragraph 4.4.6., Emergency Stop function logo  has been added.



# Harmony™ XB5 plastic 22 mm push buttons 8 x 27 mm legends

## 8 x 27 mm marked legends (for 30 x 40 mm legend holders ZBZ32 and ZBZ34) (continued)

Color	Marking	Reference	Weight kg		
English	Black or red (1)	AUTO-HAND	ZBY02364	0.001	
		AUTO-O-HAND	ZBY02385	0.001	
		CLOSE	ZBY02314	0.001	
		DOWN	ZBY02308	0.001	
		EMERGENCY STOP	ZBY02330	0.001	
		FAST	ZBY02328	0.001	
		FORWARD	ZBY02305	0.001	
		HAND	ZBY02316	0.001	
		HAND-OFF-AUTO	ZBY02387	0.001	
		INCH	ZBY02321	0.001	
		LEFT	ZBY02310	0.001	
		OFF	ZBY02312	0.001	
		OFF-ON	ZBY02367	0.001	
		ON	ZBY02311	0.001	
		OPEN	ZBY02313	0.001	
		POWER ON	ZBY02326	0.001	
		RESET (red background)	ZBY02323	0.001	
		RESET (black background)	ZBY02322	0.001	
		REVERSE	ZBY02306	0.001	
		RIGHT	ZBY02309	0.001	
		RUN	ZBY02334	0.001	
		SLOW	ZBY02327	0.001	
		START	ZBY02303	0.001	
		STOP-START	ZBY02366	0.001	
		UP	ZBY02307	0.001	
		Red	EMERGENCY STOP	ZBY02330 (2)	0.001
German	Black or red (1)	AB	ZBY02208	0.001	
		AUF	ZBY02207	0.001	
		AUS	ZBY02204	0.001	
		AUS-EIN	ZBY02266	0.001	
		AUS-IN BETRIEB	ZBY02267	0.001	
		AUS-RÜCKSTELLUNG	ZBY02233	0.001	
		AUSSCHALTEN	ZBY02232	0.001	
		AUTO-HAND	ZBY02364	0.001	
		AUTO-O-HAND	ZBY02385	0.001	
		AUTOZYKL-HAND	ZBY02299	0.001	
		AUTOZYKL- 1 ZYKL	ZBY02298	0.001	
		C-P-C-NORMAL	ZBY02265	0.001	
		EIN	ZBY02203	0.001	
		EINSCHALTEN	ZBY02231	0.001	
		HAND	ZBY02316	0.001	
		LANGSAM	ZBY02227	0.001	
		LINKS	ZBY02210	0.001	
		NOT-AUS (red background)	ZBY02230	0.001	
		ÖFFNEN	ZBY02213	0.001	
		RECHTS	ZBY02209	0.001	
		RÜCKSTELLUNG	ZBY02223	0.001	
		SCHLIESSEN	ZBY02214	0.001	
		SCHNELL	ZBY02228	0.001	
		SPANNUNG EIN	ZBY02226	0.001	
		STEUERUNG AUS	ZBY02212	0.001	
		STEUERUNG EIN	ZBY02211	0.001	
		STÖRUNG (black background)	ZBY02234	0.001	
		STÖRUNG (red background)	ZBY02235	0.001	
		VOR	ZBY02205	0.001	
		VOR-O-ZURÜCK	ZBY02284	0.001	
		ZURÜCK	ZBY02206	0.001	
		ZYKLUS-HAND	ZBY02297	0.001	
		ZYKLUSSTART	ZBY02295	0.001	
		Red	NOT-HALT	ZBY02229 (2)	0.001
		Yellow	NOT-HALT	ZBY022420001 (2)	0.001

## Sheets of peel-off legends (with backing board and protective transparent cover)

Description	For use with	Sold in lots of	Unit reference	Weight kg
Sheet of 76 legends 8 x 27 mm	30 x 40 mm legend holder ZBZ32 and ZBZ34	10	ZBY4100	0.043

(1) "Start" functions: white letters on black background. "Stop" functions: white letters on red background (unless otherwise specified above).

(2) For complying with ISO 13850:2006 standard, paragraph 4.4.6., Emergency Stop function logo  has been added.

START

ZBY02303

SCHNELL

ZBY02228

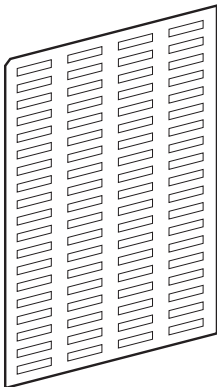

ZBY4100

# Harmony™ XB5 plastic 22 mm push buttons

Legend holders for 18 x 27 mm legends  
18 x 27 mm legends for engraving or printing



ZBZ33

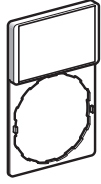

ZBY610●

Standard (30 x 50 mm) legend holders for 18 x 27 mm legends				
Description	Color of background	Sold in lots of	Unit reference	Weight kg
Without legend	–	10	ZBZ33	0.001
With blank legend	Black or red	10	ZBY6101	0.002
	White or yellow	10	ZBY6102	0.002
	Yellow	10	ZBY6140 (1)	0.002



ZBZ35



ZBY6H10●

30 x 50 mm legend holder (flush mounting with bezel) for 18 x 27 mm legends				
Description	Color of background	Sold in lots of	Unit reference	Weight kg
Without legend	–	10	ZBZ35	0.003
With blank legend	Black or red	10	ZBY6H101	0.004
	White or yellow	10	ZBY6H102	0.004

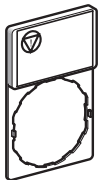

ZBY5140

18 x 27 mm legends for engraving (for 30 x 50 mm legend-holders)					
Description mm	Language	Marking	Sold in lots of	Unit reference	Weight kg
Black or red background	–	Without	10	ZBY0501	0.001
White or yellow background	–	Without	10	ZBY0502	0.001
Red background	International		10	ZBY5140 (1)	0.001
	French	ARRET D'URGENCE	10	ZBY55130 (1)	0.001
	English	EMERGENCY STOP	10	ZBY55330 (1)	0.001

Sheets of peel-off legends (with backing board and protective transparent cover)				
Description	For use with	Sold in lots of	Unit reference	Weight kg
Sheet of 40 18 x 27 mm legends	30 x 50 mm legend holder ZBZ33 and ZBZ35	10	ZBY5100	0.044



ZBY42101



ZBY62101

Nameplates, 30 x 40 mm, blank		
Text color	Background color	Unit reference
White	Black	ZBY42101
White	Red	ZBY44101
Black	Yellow	ZBY41101
Black	White	ZBY45101

Nameplates, 30 x 50 mm, blank		
Text color	Background color	Unit reference
White	Black	ZBY62101
White	Red	ZBY64101
Black	Yellow	ZBY61101
Black	White	ZBY65101

(1) For complying with ISO 13850:2006 standard, paragraph 4.4.6., Emergency Stop function logo has been added.

# Harmony™ XB5 plastic 22 mm push buttons

Legends, for insertion, for printing, pre-printed, labelling software, circular legends

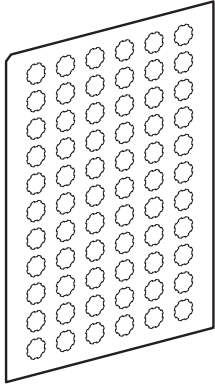

ZBY1101

Legends for XB5A push buttons, illuminated push buttons and pilot lights					
Description	Language	Marking	Sold in lots of	Unit reference	Weight kg
Sheets of 66 circular peel-off, transparent, self-adhesive legends	–	Without	10	ZBY1101	0.017
Strips of 66 circular peel-off, transparent, self-adhesive legends	International	O	10	ZBY1146	0.017
		I	10	ZBY1147	0.017
		II	10	ZBY1148	0.017
		III	10	ZBY1149	0.017
		STOP	10	ZBY1304	0.017
		†	10	ZBY1912	0.017
	French	ARRET	10	ZBY1104	0.017
		ARRIERE	10	ZBY1106	0.017
		AUTO	10	ZBY1115	0.017
		AVANT	10	ZBY1105	0.017
		DESCENTE	10	ZBY1108	0.017
		MAIN	10	ZBY1116	0.017
		MARCHE	10	ZBY1103	0.017
		MONTEE	10	ZBY1107	0.017
	English	HAND	10	ZBY1316	0.017
		OFF	10	ZBY1312	0.017
		ON	10	ZBY1311	0.017
		START	10	ZBY1303	0.017
German	AB	10	ZBY1208	0.017	
	AUF	10	ZBY1207	0.017	
	AUS	10	ZBY1204	0.017	
	EIN	10	ZBY1203	0.017	
	ZU	10	ZBY1214	0.017	

### Circular yellow legends for mushroom head push buttons

Used for “Emergency stop” function				
Diameter mm	Conforming to standards	Marking on yellow background	Reference	Weight kg
60	EN/IEC 60204-1 and EN/ISO 13850:2006	–	ZBY9140	0.004
		ARRET D'URGENCE	ZBY9130	0.004
		EMERGENCY STOP	ZBY9330	0.004
		NOT-HALT	ZBY9230	0.004
		PARADA DE EMERGENCIA	ZBY9430	0.004
		ARRESTO DE EMERGENZA	ZBY9630	0.004
90	EN/IEC 60204-1 and EN/ISO 13850:2006	–	ZBY8140	0.008
		ARRET D'URGENCE	ZBY8130	0.008
		EMERGENCY STOP	ZBY8330	0.008
		NOT-HALT	ZBY8230	0.008
		PARADA DE EMERGENCIA	ZBY8430	0.008
		ARRESTO DE EMERGENZA	ZBY8630	0.008



ZBY9330

Used for “Emergency switching off” function				
Diameter mm	Conforming to standards	Marking on yellow background	Reference	Weight kg
60	EN/IEC 60204-1	–	ZBY9101	0.004
		COUPURE D'URGENCE	ZBY9160	0.004
		EMERGENCY SWITCHING OFF	ZBY9360	0.004
		NOT-AUS	ZBY9260	0.004
		DESCONEXION DE EMERGENCIA	ZBY9460	0.004
		INTERRUZIONE DI EMERGENZA	ZBY9660	0.004
90	EN/IEC 60204-1	–	ZBY8101	0.008
		COUPURE D'URGENCE	ZBY8160	0.008
		EMERGENCY SWITCHING OFF	ZBY8360	0.008
		NOT-AUS	ZBY8260	0.008
		DESCONEXION DE EMERGENCIA	ZBY8460	0.008
		INTERRUZIONE DI EMERGENZA	ZBY8660	0.008



ZBY9360

(1) For complying with ISO 13850:2006 standard, paragraph 4.4.6., Emergency Stop function logo  has been added.



# Harmony™ XB5 plastic 22 mm push buttons

## Accessories for push buttons

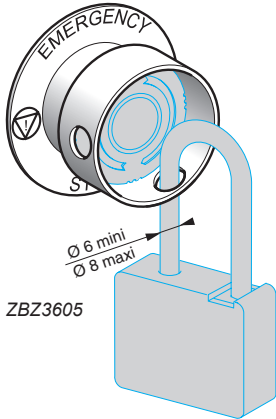

ZBZ3605



ZBY9330T

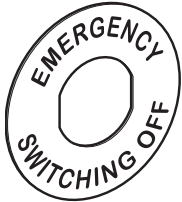

ZBY9360T

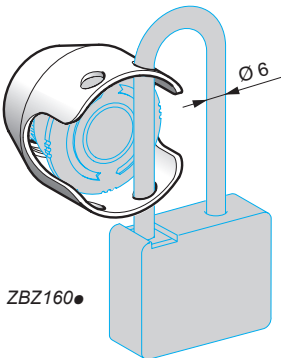

ZBZ160

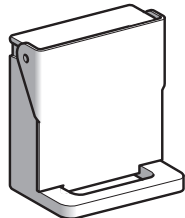

ZB4BZ64

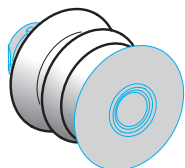

ZBZ8

### Accessories for mushroom head push buttons

Used for Emergency stop (1) or Emergency switching off function (2)

Description	For use with	Color	Reference	Weight kg
Padlocking kit (3) (4) (padlockable)	Emergency stop (1) and Emergency switching off function (2), only with the following Ø 40 trigger action push buttons: XB5AS844●, XB5AS944●, ZB5AS844, ZB5AS944●.	Yellow	ZBZ3605	0.045

Description	Marking	Color	Reference	Weight kg
Ø 60 mm legend for padlocking device ZBZ3605 For Emergency stop function (1)	-	Yellow	ZBY9140T	0.004
	ARRET D'URGENCE	Yellow	ZBY9130T	0.004
	EMERGENCY STOP	Yellow	ZBY9330T	0.004
	NOT-HALT	Yellow	ZBY9230T	0.004
Ø 60 mm legend for padlocking device ZBZ3605 For Emergency switching off function (2)	-	Yellow	ZBY9101T	0.004
	COUPURE D'URGENCE	Yellow	ZBY9160T	0.004
	EMERGENCY SWITCHING OFF	Yellow	ZBY9360T	0.004
	NOT-AUS	Yellow	ZBY9260T	0.004
Metal guards Padlockable (4)	Emergency stop function (1) only with the following Ø 40 trigger action push buttons: XB5AT845, XB5AS844 XB5AS9445, ZB5AT84, ZB5AS844, ZB5AS944.	Chromium plated	ZBZ1600	0.046
		Black	ZBZ1602	0.046
		Red	ZBZ1604	0.046
		Blue	ZBZ1606	0.046

### Other accessories

Description	For use with	Color	Reference	Weight kg
Plastic guard	Selector switches and key switches	Black	ZBZ2102	0.005
Padlockable flaps	Push buttons	Black	ZB4BZ62	0.076
		Red	ZB4BZ64	0.076
		Yellow	ZB4BZ65	0.076
		Blue	ZB4BZ66	0.076

Description	Application	Material	Color	Sold in lots of	Unit reference	Weight kg
Bellows seals for harsh environments (IP 69K) (5)	Environments subject to humidity, dust, high-pressure cleaning etc...	Silicone	Red	2	ZBZ48	0.009
		EPDM	Black	2	ZBZ28	0.009
			Yellow	2	ZBZ58	0.009

(1) Ensures conformity with standards EN/IEC 60204-1 and EN/ISO 13850:2006.  
 (2) Ensures conformity with standard EN/IEC 60204-1.  
 (3) Standard circular legends are not compatible with this product. Use special legends ZBY9●●●T.  
 (4) No isolation function is possible when this guard is fitted.  
 (5) Only when mounted on control stations. Use legends ZBY9●●●T.

# Harmony™ XB5 plastic 22 mm push buttons

Accessories for push buttons



Other accessories (continued)					
Description	For use with	Color	Sold in lots of	Unit reference	Weight kg
Black plastic square blanking plug (with mounting nut) (1)	Ø 22 mm control and signaling units	Chromium plated	10	ZB5SZ5	0.009
		Black	10	ZB5SZ37	0.009
Black plastic circular blanking plug (with mounting nut)	Ø 22 mm control and signaling units		10	ZB5SZ3	0.009
Liquid spray protective washer to be fitted in the head	Ø 22 mm control and signaling units	Chromium plated	50	ZB4BZ007	0.010
		Black	50	ZB4BZ0077	0.010

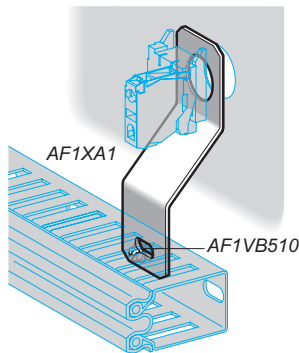

Description	Application	Sold in lots of	Unit reference	Weight kg
Cable ducting support	Mounting beneath head	10	AF1XA1	0.030
M5 x 10 screw, with hexagonal slotted head	For mounting cable ducting	100	AF1VB510	0.003
Support	For XB5A push buttons, switches and pilot lights	1	DX1AP52	0.160

(1) Body/mounting collar ZB5AZ009 required for mounting must be ordered separately, see page 125.

# Harmony™ XB5 plastic 22 mm push buttons

Accessories for illuminated push buttons  
Bulbs



DL1CJ0●●●



DL1CE●●●



DL1CF●●●



XBFX13



ZBZ8



ZB5AZ31

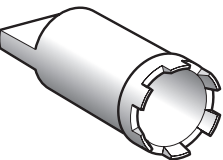

ZB5AZ905



ZB5AZ902

### Bulbs with BA 9s base fitting and associated accessories

Description	Specifications	Color	Sold in lots of	Unit reference	Weight kg
LEDs	≈ 24 V	White	1	DL1CJ0241	0.002
		Green	1	DL1CJ0243	0.002
		Red	1	DL1CJ0244	0.002
		Orange	1	DL1CJ0245	0.002
		Blue	1	DL1CJ0246	0.002
	≈ 48 V	Green	1	DL1CJ0483	0.002
		Red	1	DL1CJ0484	0.002
		Orange	1	DL1CJ0485	0.002
	6 V - 1.2 W	White	1	DL1CD0061	0.002
		Green	1	DL1CD0063	0.002
		Red	1	DL1CD0064	0.002
		Orange	1	DL1CD0065	0.002
		Blue	1	DL1CD0066	0.002
Incandescent bulbs	6 V - 1.2 W	–	10	DL1CB006	0.002
	24 V - 2 W	–	10	DL1CE024	0.002
	120 to 130 V 2.4 W	–	10	DL1CE130	0.002
Neon bulbs	120 to 130 V	–	10	DL1CF110	0.002
	230 to 240 V	–	10	DL1CF220	0.002
Bulb extractor	–	–	1	XBFX13	0.005
Lens cap tightening tool	Illuminated push buttons, with flush push	–	1	ZBZ8	0.009
Add-on square trim	Gives a square appearance to ZB5A circular heads	–	10	ZB5AZ31	0.002
Nut	Head mounting	–	10	ZB5AZ901	0.002
Bezel tool	Tightening head mounting nut ZB5AZ901	–	1	ZB5AZ905	0.016
Anti-rotation plate	Prevents rotation of the head	–	10	ZB5AZ902	0.008

# Harmony™ XB5 plastic 22 mm push buttons

Accessories for push buttons

Keys

## Replacement keys

Description	Key number	Reference	Weight kg
<b>For latching mushroom head push buttons and selector switches</b>			
Sets of 2 keys	455	ZBG455	0.013
	421E	ZBG421E	0.014
	458A	ZBG458A	0.014
	520E	ZBG520E	0.014
	3131A	ZBG3131A	0.014
	4A185	ZBDA185	0.014
	LU1	ZBDLU1	0.014
	LU2	ZBDLU2	0.014
	LU3	ZBDLU3	0.014
	LU4	ZBDLU4	0.014
	LU5	ZBDLU5	0.014
	LU6	ZBDLU6	0.014
	LU7	ZBDLU7	0.014
	LU8	ZBDLU8	0.014
	LU9	ZBDLU9	0.014
	LU10	ZBDLU10	0.014
	LU11	ZBDLU11	0.014
	LU12	ZBDLU12	0.014
	LU13	ZBDLU13	0.014
	LU14	ZBDLU14	0.014
	8D1	ZBD8D1	0.014

## For booted selector switches

Sets of 2 keys, one of which supplied booted (rubber boot)	455	ZBG455P	–
	421E	ZBG421EP	–
	458A	ZBG458AP	–
	520E	ZBG520EP	–
	3131A	ZBG3131AP	–



ZBG 455P

## Accessory for key switches (1)

Description	Function	Reference	Weight kg
Keyhole cover (rubber boot)	Protection of lock barrel when no key inserted in lock	ZBGP	0.005

(1) Not compatible with products with key TEC10.

# Harmony™ XB5 plastic 22 mm push buttons

Push buttons, switches and pilot lights:  
complete units, XB5A

## Push buttons, spring return

**XB5AA●●**

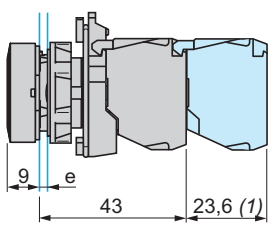

**XB5AL●●**

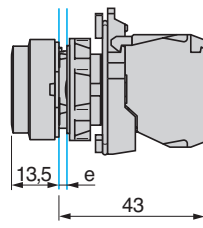

Common face view

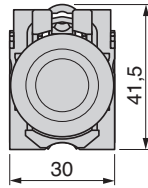

**XB5AP●●**

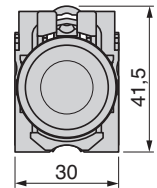
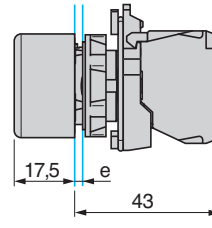

e: clamping thickness: 1 to 6 mm  
(1) Additional row of contacts or double contact.

e: clamping thickness: 1 to 6 mm

## Mushroom head push buttons, spring return

**XB5AC21**

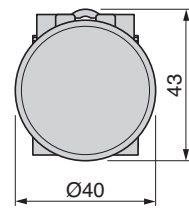
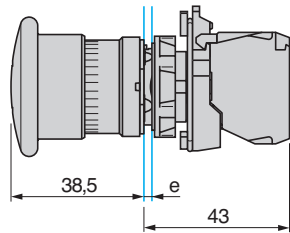

e: clamping thickness: 1 to 6 mm

## Multiple-headed push buttons (double or triple), spring return

**XB5AL73415, XB5AW73731●5**

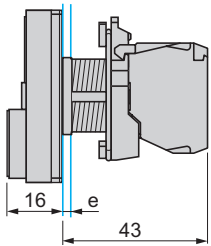

**XB5AA731327, XB5AA711237**

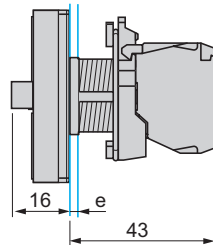

Common face view

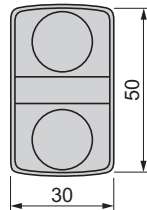

e: clamping thickness: 1 to 6 mm

## Emergency stop mushroom head push buttons, trigger action and mechanical latching

**XB5AT845**

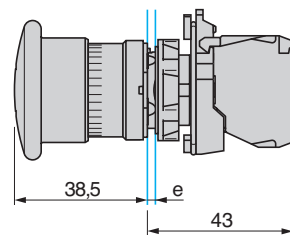

**XB5AS8445**

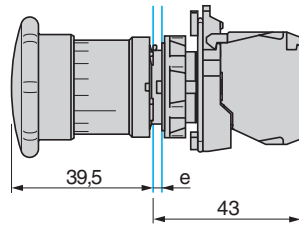

**XB5AS9445**

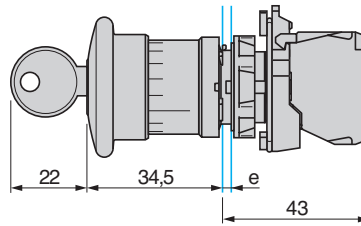

Common face view

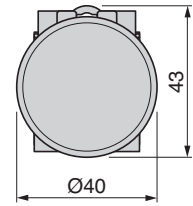

e: clamping thickness: 1 to 6 mm

e: clamping thickness: 1 to 6 mm

## Emergency switching off mushroom head push buttons, mechanical latching

**XB5AT42**

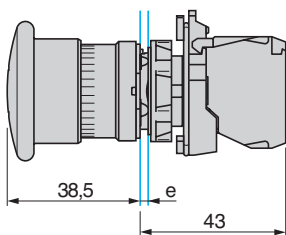

**XB5AS542**

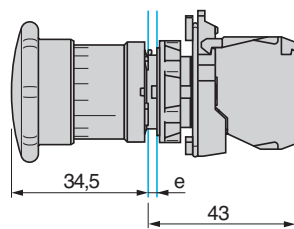

**XB5AS142**

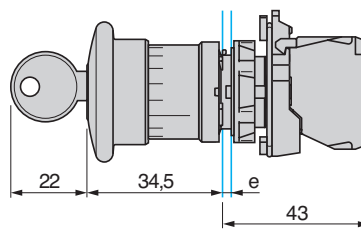

Common face view

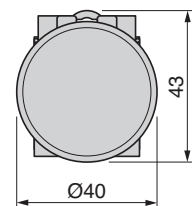

e: clamping thickness: 1 to 6 mm

e: clamping thickness: 1 to 6 mm

# Harmony™ XB5 plastic 22 mm push buttons

Push buttons, switches and pilot lights:  
complete units, XB5A

## Selector switches

### Standard handle operator

XB5AD●●

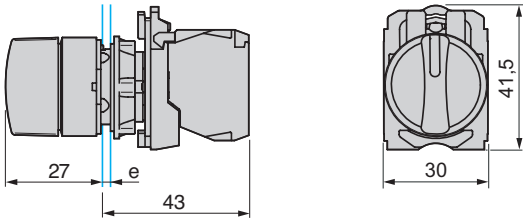

e: clamping thickness: 1 to 6 mm

### Long handle operator

XB5AJ●●

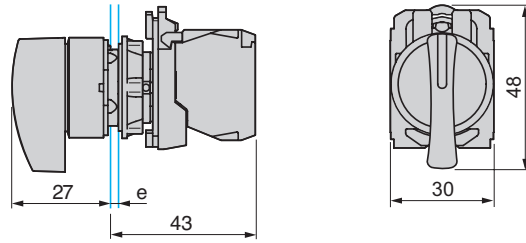

e: clamping thickness: 1 to 6 mm

## Key switches

XB5AG●●

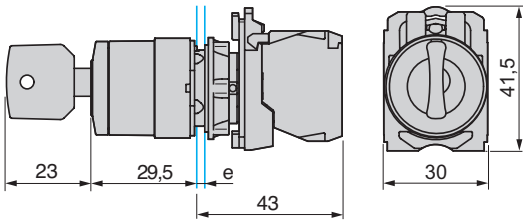

e: clamping thickness: 1 to 6 mm

# Harmony™ XB5 plastic 22 mm push buttons

Push buttons, switches and pilot lights:  
complete units, XB5A

## Pilot lights

### Integral LED

XB5AVB●, AVG●, AVM●

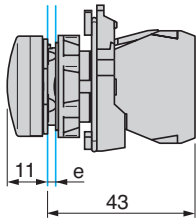

### Direct supply

XB5AV6●

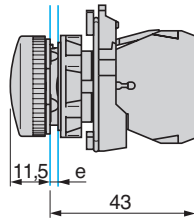

### Via integral transformer

XB5AV3●, AV4●

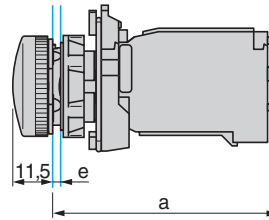

Common face view

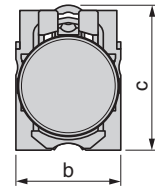

	a	b	c
XB5AV●●	43	30	41.5
XB5AV5B●	89.6	40	45

e: clamping thickness: 1 to 6 mm

e: clamping thickness: 1 to 6 mm

## Illuminated push buttons

### Integral LED

XB5AW3●●5

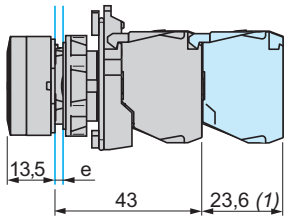

### Direct supply

XB5AW3●65

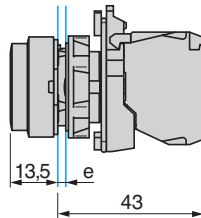

### Via integral transformer

XB5AW3●●5

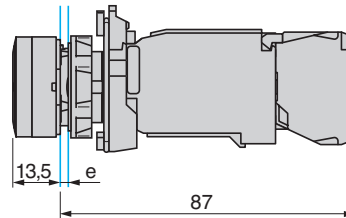

Common face view

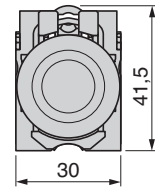

e: clamping thickness: 1 to 6 mm  
(1) Additional row of contacts or double contact.

e: clamping thickness: 1 to 6 mm

## Illuminated selector switches

### Integral LED

XB5AK12●●5

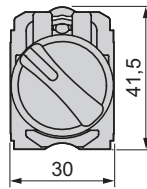
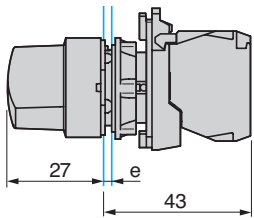

e: clamping thickness: 1 to 6 mm

## Panel cut-out for push buttons, switches and pilot lights (finished holes, ready for installation)

### Connection by screw clamp terminals or plug-in connectors or on printed circuit board

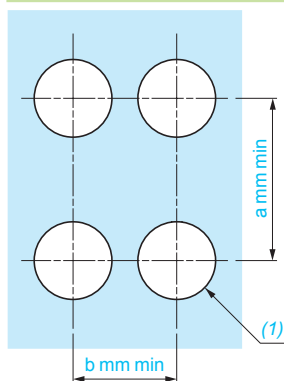

(1) (2) 22.5 mm recommended (22.3<sup>+0.4</sup>)

(1) Diameter on finished panel or support.

(2) For selector switches and Emergency stop buttons, use of an anti-rotation plate type ZB5AZ902 is recommended, see page 146.

### Detail of lug recess

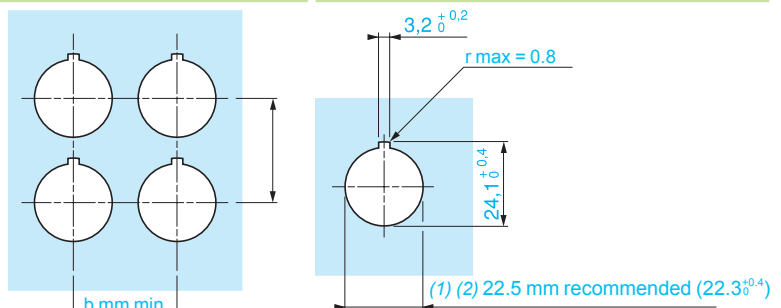

Connections	a	b
By screw clamp terminals or plug-in connector	40	30
By Faston® connectors	45	32
On printed circuit board	30	30



# Harmony™ XB5 plastic 22 mm push buttons

Push buttons, switches and pilot lights:  
sub-assemblies, ZB5A

### Heads for spring return push buttons

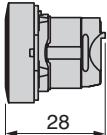
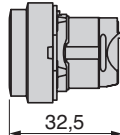
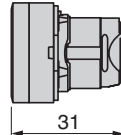
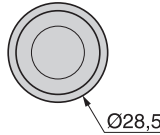
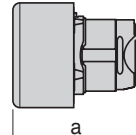
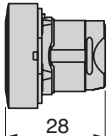
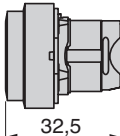
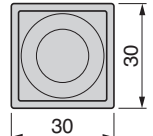
ZB5AA●, AA●●●, ZB5AA●8	ZB5AL●, ZB5AL●●●	ZB5AA●4, ZB5AA●6	Common face view	ZB5AP●●, ZB5AP●S, ZB5AP●83, ZB5AP●
				
28	32,5	31	Ø28,5	a
ZB5CA●, ZB5CA0	ZB5CL●	Common face view		
				
28	32,5	30		

ZB5	a
AP●●	36.5
AP●S	33
AP●83	32
AP●	35

### Mushroom heads for spring return push buttons

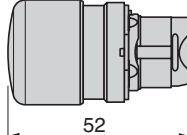
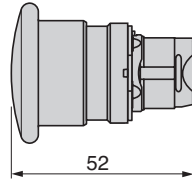
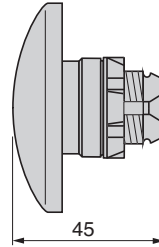
ZB5AC●4	ZB5AC●, AR●	ZB5AR●16
		
52	52	45
Ø30	Ø	Ø60

ZB5	Dia. (mm)
AC●	40
AR●	60

### Heads for double-headed, spring return push buttons

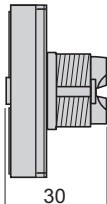
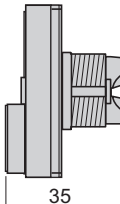
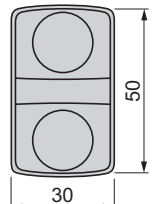
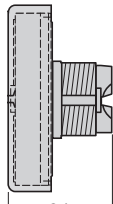
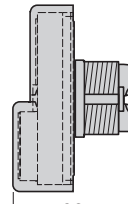
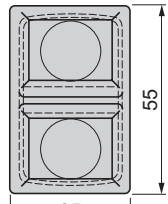
ZB5AA712●, ZB5AA734●, ZB5AA79	ZB5AL734●	Common face view	ZB5AA712●, ZB5AA734●, ZB5AA79, + boot ZBA 708	ZB5AL734● + boot ZBA710	Common face view
					
30	35	30	31	36	35
		50			55

### Heads for triple-headed, spring return push buttons

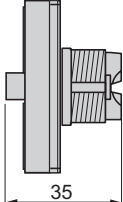
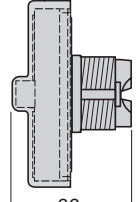
ZB5AA7313●, ZB5AA711●●, ZB5AA72124, ZB5AA791	ZB5AA7313●, ZB5AA711●●, ZB5AA72124, ZB5AA791 + boot ZBA709
	
35	36
50	55
30	35

### Heads for lockable, Push-turn push buttons

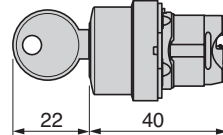
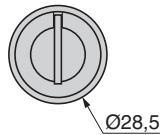
ZB5AFD	
	
22	40
	Ø28,5

# Harmony™ XB5 plastic 22 mm push buttons

Push buttons, switches and pilot lights:  
sub-assemblies, ZB5A

**Mushroom heads for Emergency stop, trigger action and mechanical latching push buttons**

**Push-pull**

ZB5AT84

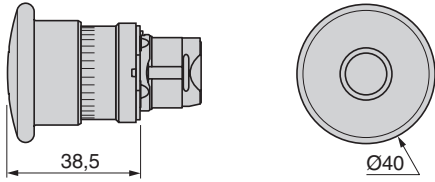

**Turn to release**

ZB5AS834

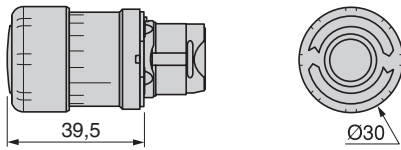

ZB5AS844

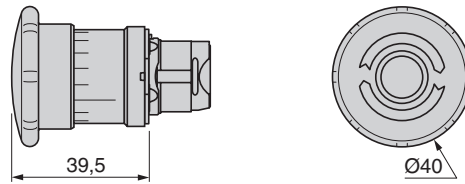

**Key release**

ZB5AS934

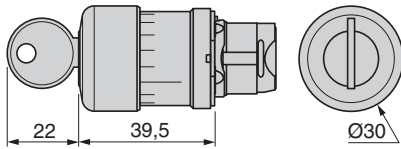

ZB5AS944

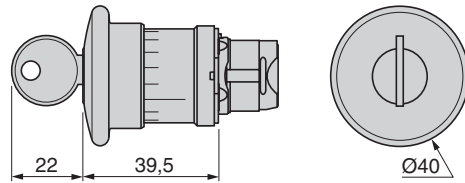

ZB5AS964

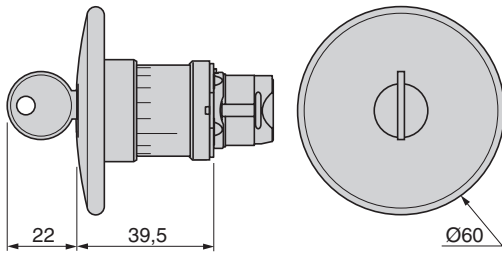

ZB5AS944D

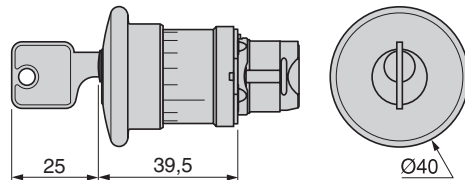

**Illuminated mushroom heads for Emergency stop, trigger action and mechanical latching push buttons**

**Push-pull with pilot light and mechanical state indicator**

ZB5AT8643M

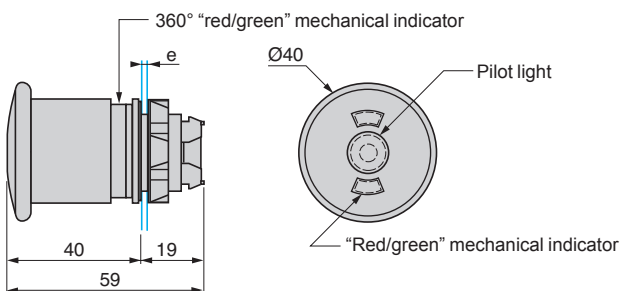

e: panel thickness 1 to 6 mm

# Harmony™ XB5 plastic 22 mm push buttons

Push buttons, switches and pilot lights:  
sub-assemblies, ZB5A

**Mushroom heads for Emergency switching off, mechanical latching push buttons**

**Push-pull**

ZB5AT4

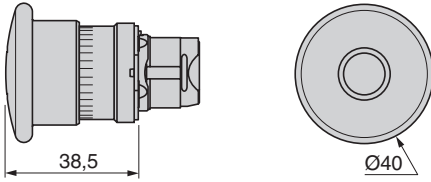

ZB5AX4

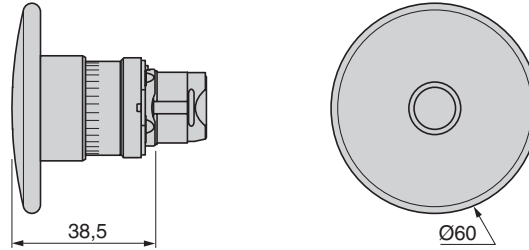

**Turn to release**

ZB5AS44

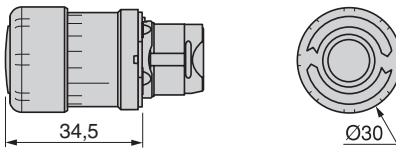

ZB5AS54

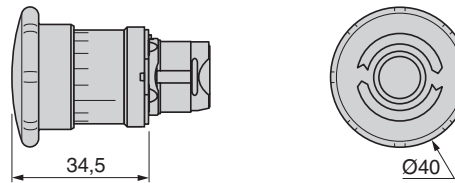

ZB5AS64

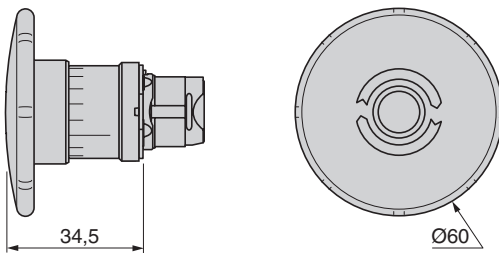

**Key release**

ZB5AS74

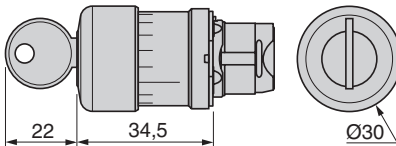

ZB5AS14

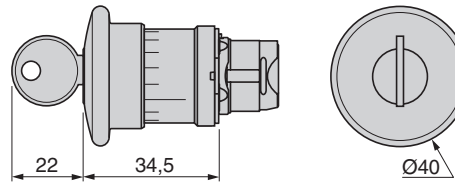

ZB5AS24

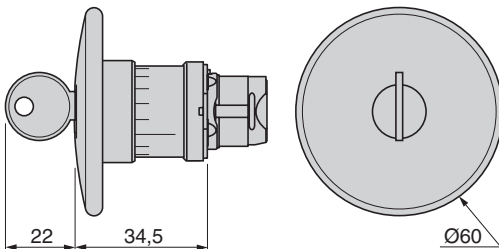

ZB5AS14D

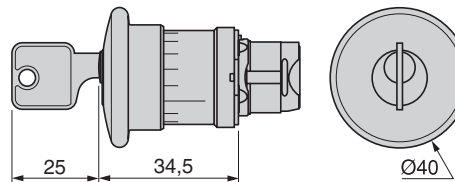

# Harmony™ XB5 plastic 22 mm push buttons

Push buttons, switches and pilot lights:  
sub-assemblies, ZB5A

## Mushroom heads for latching push buttons (1)

### Push-pull

ZB5AT24

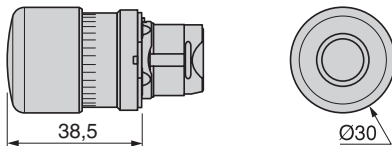

ZB5AT2

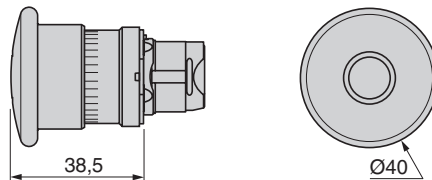

ZB5AX2

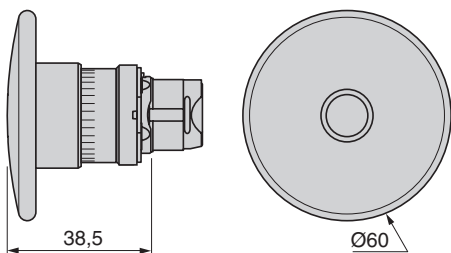

### Turn to release

ZB5AS42

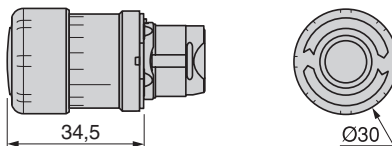

ZB5AS52, ZB5AS55

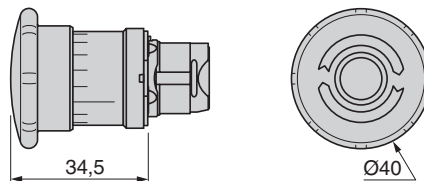

ZB5AS62

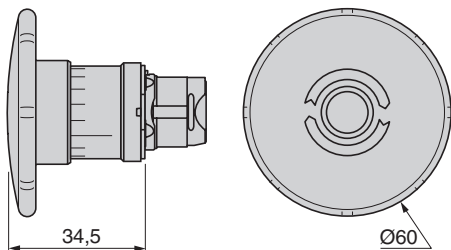

### Key release

ZB5AS72

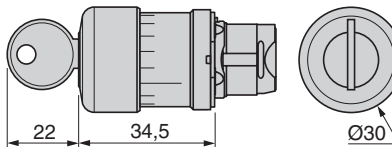

ZB5AS12

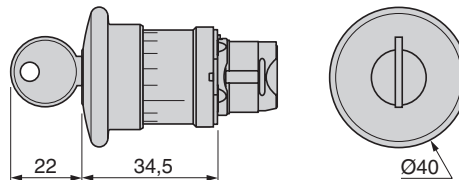

ZB5AS22

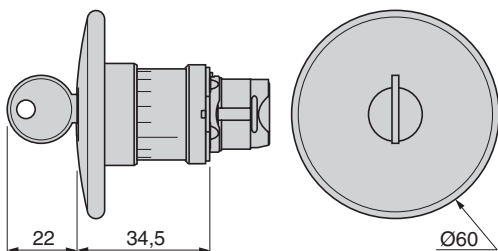

(1) Red mushroom heads for Emergency stop and Emergency switching off, latching push buttons: see pages 152 and 153.

# Harmony™ XB5 plastic 22 mm push buttons

Push buttons, switches and pilot lights:  
sub-assemblies, ZB5A

## Heads for selector switches

### Standard handle operator

ZB5AD●, ZB5AD●M

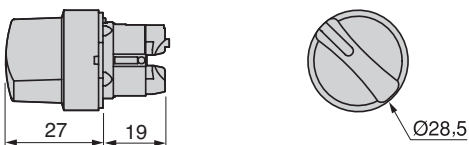

### Long handle operator

ZB5AJ●, ZB5AJ●M

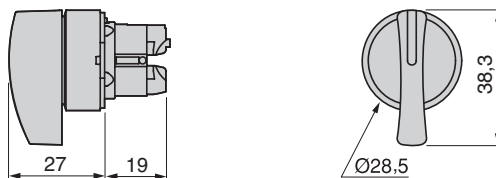

### Black knurled knob

ZB5AD●9

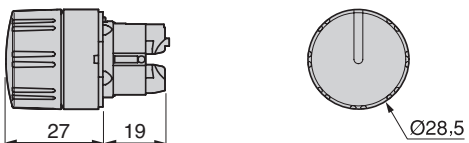

### Key switch (Ronis no. 455)

ZB5AG●, ZB5AG0●, ZB5AG●M

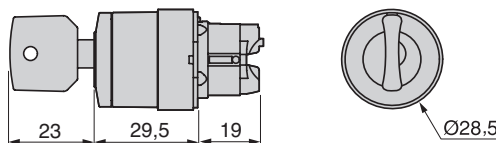

### Key switch (DOM no. 8D1)

ZB5AGD

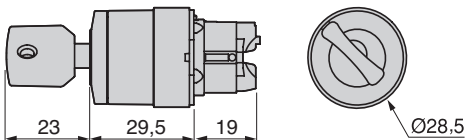

## Heads for toggle switches

ZB5AD●8

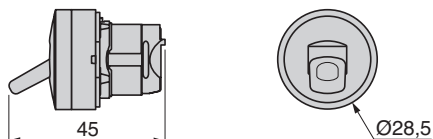

## Bodies for push buttons and switches

### Screw clamp terminal connections

ZB5AZ10●, ZB5AZ141

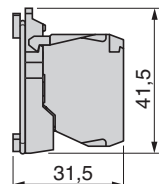

### Spring terminal connections

ZB5AZ10●5

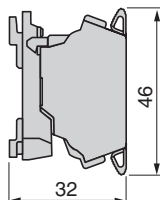

### Plug-in connector

ZB5AZ10●4, ZB5AZ1414

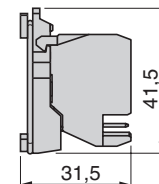

### High power switching with screw clamp terminal connections

ZBE 50● block + ZB5AZ009 body

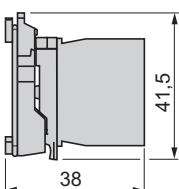

# Harmony™ XB5 plastic 22 mm push buttons

Push buttons, switches and pilot lights:  
sub-assemblies, ZB5A and ZBV

## Heads for pilot lights, with light source

### Integral LED

ZB5AV0●3

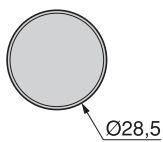
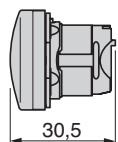

### Incandescent, neon or LED

ZB5AV0●, AV0●S

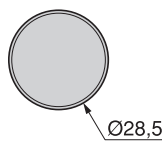
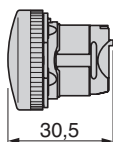

ZB5 CV0●3, CH3●3

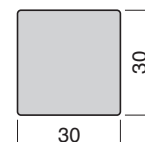
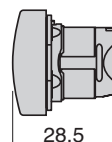

## Bodies for pilot lights, screw clamp terminal connections

### Integral LED

ZB5AV●●

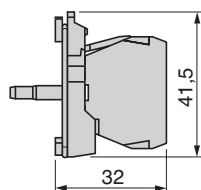

### Direct supply, for BA 9s bulb

ZB5AV6

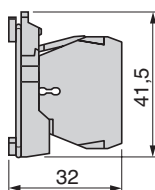

### With integral transformer, for BA9s bulb

ZB5AV●, AV●D●

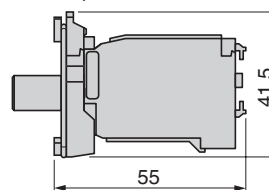

## Light block + body/mounting collar for pilot lights, plug-in connector

### Integral LED

ZBV●●4 light block + ZB5AZ009 body/mounting collar

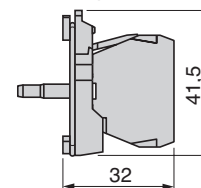

### Transformer blocks

For 24 V light blocks with integral LED

ZBV 5B, ZBV 8B, ZBV 9B

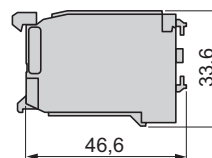

## Light block + body/mounting collar for pilot lights, spring terminal connections

### Integral LED

ZBV●●5 light block + ZB5AZ009 body/mounting collar

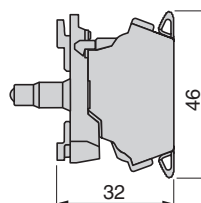

## Blocks for "remote test light" function

### Connections

ZBZG156

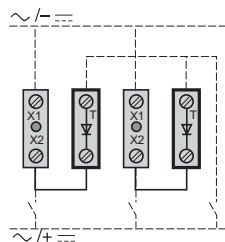

ZBZM156

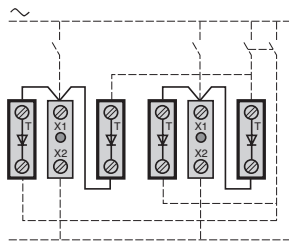

# Harmony™ XB5 plastic 22 mm push buttons

Push buttons, switches and pilot lights:  
sub-assemblies, ZB5A

**Heads for spring return illuminated push buttons, for light source types:**

**LED**

ZB5AW3●3, AW3●3S,  
ZB5AA●8

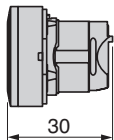

ZB5AW1●3, ZB5AW1●3S,  
ZB5AL●8

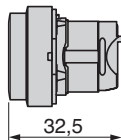

Common face view

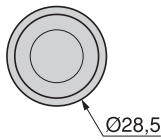

ZB5AW9●3

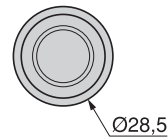
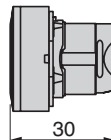

ZB5AW5●3

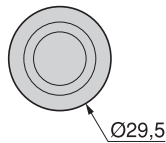
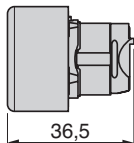

ZB5 CW3●3

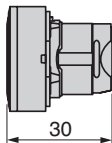

ZB5 CW1●3

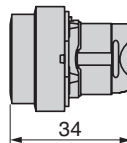

Common face view

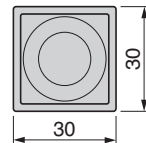

**Bulb with BA9s base fitting**

ZB5AW3●, AW3●S

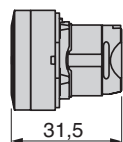

ZB5AW1●, ZB5AW1●S

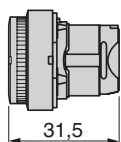

Common face view

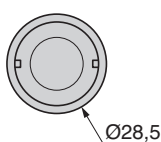

**Heads for double-headed push buttons + pilot light**

ZB5AW7A374●, ZB5AW7A17●●, ZB5AW7A9

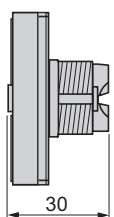

ZB5AW7L374●

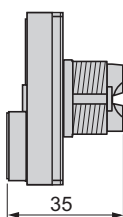

Common face view

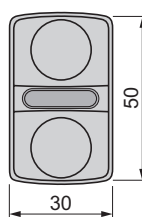

ZB5AW7A374●, ZB5AW7A17●●, ZB5AW7A9  
+ boot ZBA 708

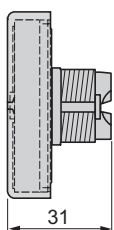

ZB5AW7L374●  
+ boot ZBA 710

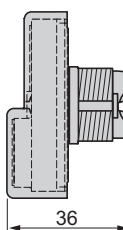

Common face view

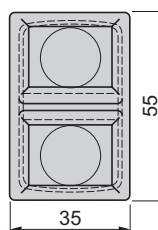

**Heads for illuminated, latching, mushroom head push buttons**

ZB5AW7●3

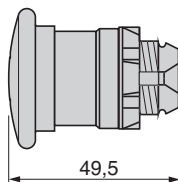
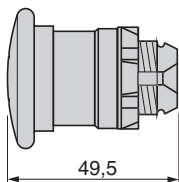

**Heads for illuminated selector switches with standard handle**

ZB5AK1●●●3

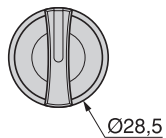
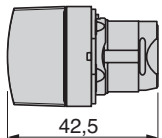



# Harmony™ XB5 plastic 22 mm push buttons

Push buttons, switches and pilot lights:  
complete units or sub-assemblies

**Bodies for illuminated push buttons and selector switches, screw clamp terminal connections**

**Integral LED**

ZB5AW0●●●

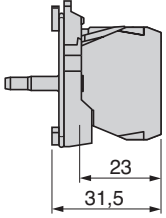

**Direct supply for BA9s bulb**

ZB5AW0●●

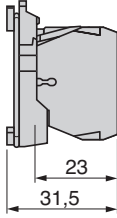

**With integral transformer for BA9s bulb**

ZB5AW0●●, ZB5AW0●D●●

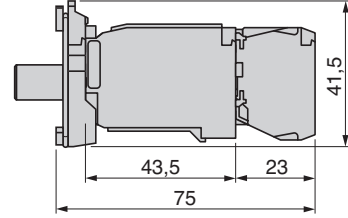

**Bodies for illuminated push buttons and selector switches, plug-in connector**

**Integral LED**

ZB5AW0●●●4

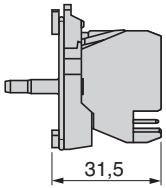

**Manual overload reset buttons**

XB5A8●●●

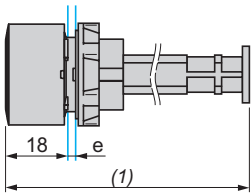

e: panel thickness 1 to 6 mm

XB5AL8●●●

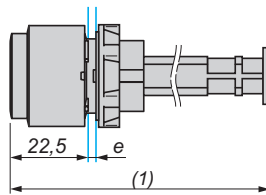

(1) Value not yet communicated

Common face view

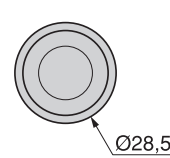

**Head + mounting base for potentiometer**

ZB5AD9●2

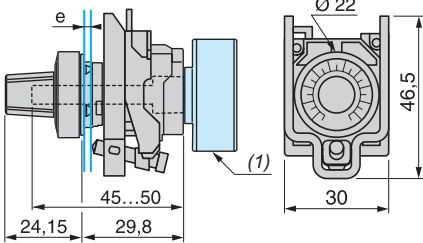

(1) Potentiometer not included.

**Joystick controllers**

XD5 PA●2

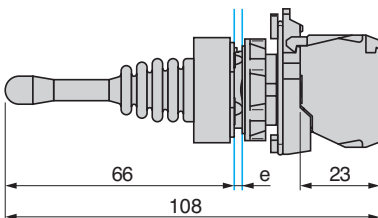

e: panel thickness 1 to 6 mm

XD5 PA●4

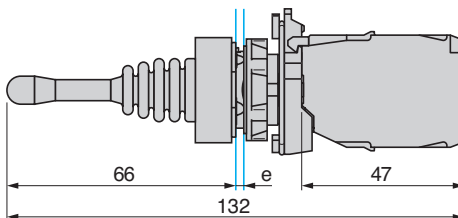

Common face view

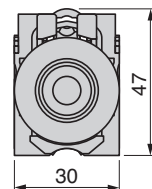

**Hour counters**

XB5 DS●

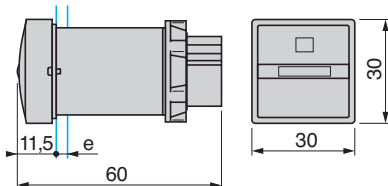

e: panel thickness 1 to 6 mm

**Annunciators**

XB5 KS●

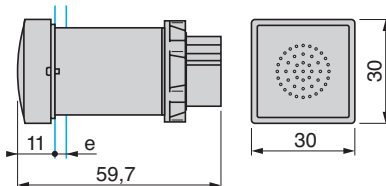

**Cabling**

XB5 KS●

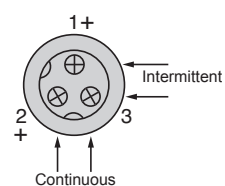

# Harmony™ XB5 plastic 22 mm push buttons

Push buttons, switches and pilot lights  
for printed circuit board connection

**Push buttons, switches and pilot lights for printed circuit board connection**

**Panel cut-outs (viewed from installer's side)**

Dimensions in mm

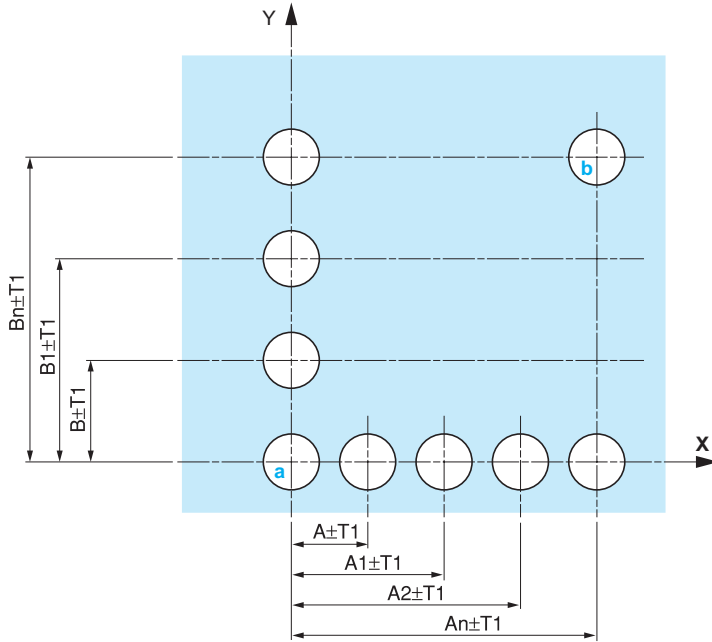

**Printed circuit board cut-outs (viewed from electrical block side)**

Dimensions in mm

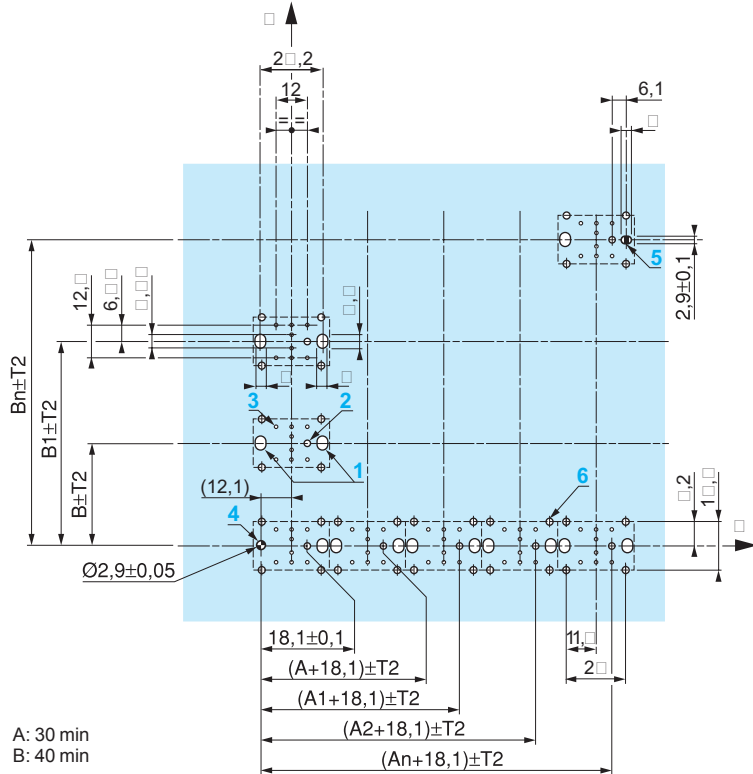

**General tolerances of the panel and printed circuit board**

The cumulative tolerance must not exceed 0.3 mm: T1 + T2= 0.3 mm max.

■ Installation information:

- Minimum thickness of circuit board: 1.6 mm.
- Cut-out diameter: 22.4 mm ± 0.1 mm.
- Orientation of body/mounting collar ZB5 BZ079: ± 2° 30' (excluding cut-outs marked **a** and **b**).
- Tightening torque of screws ZBZ006: 0.6 N.m. max.
- Allow for one ZB5BZ079 mounting collar/pillar and its mounting screws:
  - every 90 mm horizontally (X), and 120 mm vertically (Y),
  - with each selector switch head (ZB5AD●, ZB5AJ●, ZB5AG●).

The mounting centers marked **a** and **b** are diagonally opposed and must align with those marked **4** and **5**.

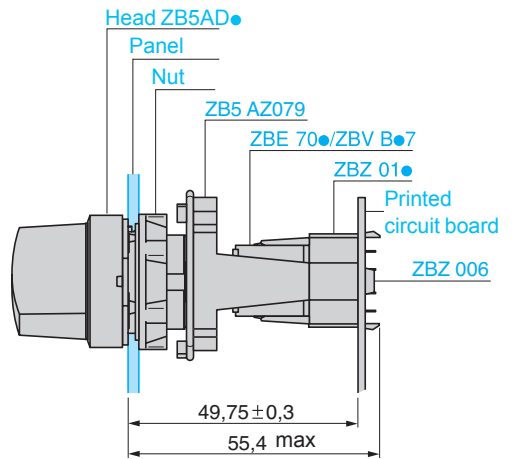

Mounting of adapter (socket) ZBZ01●:

- 1 2 elongated holes for ZBZ006 screw access.
- 2 1 hole 2.4 mm ± 0.05 for centering adapter ZBZ01●.
- 3 8 x 1.2 mm holes.
- 4 1 hole 2.9 mm ± 0.05, for aligning the printed circuit board (with cut-out marked **a**).
- 5 1 elongated hole for aligning the printed circuit board (with cut-out marked **b**).
- 6 4 holes 2.4 mm for clipping in adapter ZBZ01●.

Dimensions An + 18.1 relate to the 2.4 mm ± 0.05 holes for centering adapter ZBZ01●.



# Harmony™ XB5S Biometric Switch





# Improving the security of your daily operations...

The Harmony™ XB5S Biometric Switch is an innovative security solution that uses fingerprint authentication technology to control access to your machines, vehicles, processes, and work areas. Its database of authorized users can be managed directly on the device, or externally via a PC or HMI. The Harmony XB5S enables you to determine an individual's level of access to specific work areas and HMI menu tabs.



## Quick and reliable access verification...

With its fingerprint recognition technology, the [Harmony XB5S Biometric Switch](#) is a superior alternative to other access control systems that provide marginal levels of protection for your process functions and personnel.

## Simple and efficient...

The Harmony XB5S enables you to restrict access to sensitive zones and machine functions – starting, adjustment, maintenance – to authorized personnel only.



## Mitigates the risk of unauthorized use and associated downtime...

The Harmony XB5S biometric switch is an automated solution that ensures that only authorized persons have access to your key process areas...

**...allowing you to prevent unwarranted machine use, and to protect your staff, equipment, and the continuity of your production process.**



### **Your fingerprint is a unique access controller!**

Fingerprint recognition technology is one of the fastest and most accurate ways of verifying access rights.

# Control access to your critical assets and areas...



## Protect your specific processes...

With Harmony™ XB5S, you can **identify**, **authorize** and **track** user operations on HMIs.



## Safeguard your automation line...

With Harmony XB5S, you can **improve security** of your automated lines and tool machines.



## Restrict access to your technology...

With Harmony XB5S, you can **control** access to **restricted areas**.



## Limit the unauthorized operation of specific equipment...

With Harmony XB5S, you can prevent unwarranted access to the **start function** of special **vehicles**.

# Rely on flexible and secure user permissions management...

## Simple to manage with:

### Harmony™ XB5S1/2

- Parameterizes and records directly on the front face of the device using LED signalling

### Harmony XB5S3/4/5

- Provides visualization, saving and duplication of the authorized user database via HMI or PC, and dedicated software
- Add and delete user permissions easily
- Data transfer is secured by administrator approval
- Database is encrypted to prevent unwarranted use of personal data



Managed with Vijeo™ Designer™ and Harmony XB5S Software

## Harmony XB5S product range

Stand-alone product:  
Harmony XB5S1/2

Configured by PC:  
Harmony XB5S3/4

Configured by HMI:  
Harmony XB5S5



**< 1 second**  
to authenticate  
an operator and  
authorize or  
refuse access

Improve control of access to equipment and restricted areas.

Manage embedded database of authorized users directly on the switch.

Restrict use of special machines and vehicles.

Manage user database via a PC interface.

Define different profiles of authorized users on HMIs to enhance security control.

Manage user database easily via HMI. Track and store access data of recorded users.

<b>Applications</b>	Simple access control for indoor industrial restricted areas
<b>Type of products</b>	Stand-alone biometric switch



<b>Functions</b>	<ul style="list-style-type: none"> <li>■ 1 level of authorization</li> <li>■ Authorizes user through fingerprint recognition</li> </ul>
<b>Static Output</b>	<ul style="list-style-type: none"> <li>■ Maintained output, machine operation at 2 fixed states</li> <li>■ Momentary output, machine operation at pulse control</li> </ul>
<b>Power</b>	24 Vdc
<b>Connection</b>	<ul style="list-style-type: none"> <li>■ Pre-wired 3 wire cable (2 m/6.56 ft long) or</li> <li>■ M12 connector</li> </ul>
<b>Memory capacity</b>	<ul style="list-style-type: none"> <li>■ 200 records of fingerprints</li> <li>■ 100 authorized users with each registering 2 fingerprints or 200 authorized users with each registering 1 fingerprint</li> </ul>
<b>Communication</b>	No communication
<b>Database management software tools</b>	None
<b>User database update</b>	Stand-alone as updates are done directly on the biometric switch
<b>Associated accessories</b>	<ul style="list-style-type: none"> <li>■ Translucent protective cover</li> <li>■ Mounting nut</li> <li>■ Legend plate</li> </ul>
<b>Type references</b>	<b>XB5S1, XB5S2</b>

(1) Compatible with Magelis™ iPC, STU, OT, GXO, GT (except GT1000 series), GK, GH and GTO models .

(2) Compatible with all versions of Harmony™ XB5SSoft application. The XB5SSoft is a freeware application and can be downloaded from our website [www.schneider-electric.com](http://www.schneider-electric.com).



<ul style="list-style-type: none"> <li>Secure the control of automated lines and tool machines</li> <li>Protect the start function of special vehicles</li> </ul>	<ul style="list-style-type: none"> <li>Identify and authorize the user for HMI operations</li> <li>Trace the HMI operations of each user</li> </ul>
Stand-alone USB biometric switch	USB biometric switch dedicated to Schneider HMI (1)



<ul style="list-style-type: none"> <li>1 level of authorization</li> <li>Authorizes user through fingerprint recognition</li> </ul>	<ul style="list-style-type: none"> <li>Provides access to HMI pages based on the user profile</li> <li>Several levels of authorization associated with HMI</li> <li>Traceability of users and operations by HMI</li> </ul>
<ul style="list-style-type: none"> <li>Maintained output, machine operation at 2 fixed states</li> <li>Momentary output, machine operation at pulse control</li> </ul>	None
24 Vdc	24 Vdc
<ul style="list-style-type: none"> <li>Pre-wired 3 wire cable (2 m/6.56 ft long) or</li> <li>M12 connector</li> </ul>	Pre-wired 2 wire cable (2 m/6.56 ft long)
<ul style="list-style-type: none"> <li>400 records of fingerprints</li> <li>200 authorized users with each registering 1 or 2 fingerprints</li> </ul>	<ul style="list-style-type: none"> <li>400 records of fingerprints</li> <li>200 authorized users with each registering 2 fingerprints</li> </ul>
Connects with a PC via the USB port for database management when required	Connects with a HMI via the USB port permanently
With Harmony™ XB5SSoft (2) on a PC	With Vijeo™ Designer™ (3) and Harmony XB5SSoft (2)
<ul style="list-style-type: none"> <li>Should be connected to a PC</li> <li>Download the new user database to the biometric switch from Harmony XB5SSoft application (4)</li> </ul>	<ul style="list-style-type: none"> <li>With Vijeo Designer in Run time on HMI (4)</li> <li>With Vijeo Designer in Build time on PC (4)</li> </ul>
<ul style="list-style-type: none"> <li>Translucent protective cover</li> <li>Mounting nut</li> <li>Legend plate</li> <li>Female/Female USB extension cable with a female USB port of Ø 22 mm/0.866 in. on one end for panel mount</li> </ul>	<ul style="list-style-type: none"> <li>Translucent protective cover</li> <li>Mounting nut</li> <li>Legend plate</li> </ul>
<b>XB5S3, XB5S4</b>	<b>XB5S5</b>

(3) Compatible with Vijeo™ Designer™ HMI editor software V6.1, Service pack 2.

(4) The user database cannot be uploaded from biometric switch to the PC.



Stand-alone biometric switch (XB5S1/XB5S2)



Stand-alone USB biometric switch (XB5S3/XB5S4)



USB biometric switch dedicated to Schneider HMI (XB5S5)

### Introduction

Harmony™ XB5S Biometric Switches are designed to control and secure access to systems and machines by checking a user's authorization, via fingerprint recognition technology.

The following types of biometric switches are available:

- Stand-alone biometric switches
  - type XB5S1, with 2 fixed states (maintained)
  - type XB5S2, with pulse control (momentary)
- Stand-alone USB biometric switches
  - type XB5S3, with 2 fixed states (maintained)
  - type XB5S4, with pulse control (momentary)
- USB biometric switches dedicated to Schneider Electric HMI
  - type XB5S5, connected permanently with HMI

The two types of users of the XB5S are:

- Administrators, who decide and manage the list of users
  - the only people who can record the fingerprints in the device memory
- Users, who are authorized to use the biometric switch as a control unit
  - at least 1 of their fingerprints should be recorded in the device memory
  - access is granted when the finger is placed on the sensing screen

The USB switches communicate with the PC/HMI via the USB port to manage the user database. This database can be visualized, saved, and duplicated by PC/HMI with XB5SSoft application (1) (2). The fingerprint records can also be erased in the absence of users.

The Schneider Electric HMI (3) with Vijeo™ Designer™ software (4) enables the switches to authorize different access levels and trace HMI operations of each user.

The switch operates on 24 Vdc and provides protection against:

- Reverse polarity
- Overload and short-circuit (switching capacity ≤ 200 mA)

### Mounting

The product is of monolithic design (a single plastic housing) and is mounted by means of a nut (hand-tightened without need for tools) in a standard 22.5 mm/0.886 in. diameter hole. It can be installed on a flat, horizontal, or vertical surface.

A protective cover is available as an accessory to protect the active face of the sensing screen. This cover is mounted using a self-adhesive hinge.

A female/female USB extension cable makes it possible for the USB biometric switch to have the female USB port within a 22 mm/0.866 in. diameter hole on the control panel front.

### Environment

Conformity to standards: UL, CSA, GOST, and CE.

Product certifications:

- CSA C22-2 n° 14
- UL 508
- IEC 61000-6-2 and IEC 61000-6-4

Degree of protection conforming to standard IEC 60529:

- IP 65
- UL Type 12, NEMA 12

Ambient air temperature:

- For storage: - 25 to + 70 °C
- For operation: - 5 to + 50 °C

(1) Compatible with all versions of Harmony XB5SSoft application. The XB5SSoft is a freeware application and can be downloaded from our website [www.schneider-electric.com](http://www.schneider-electric.com).

(2) The user database cannot be uploaded from USB biometric switch to the PC.

(3) Compatible with Magelis™ iPC, STU, OT, GXO, GT (except GT1000 series), GK, GH, and GTO models.

(4) Compatible with Vijeo Designer HMI editor software V6.1, Service pack 2.

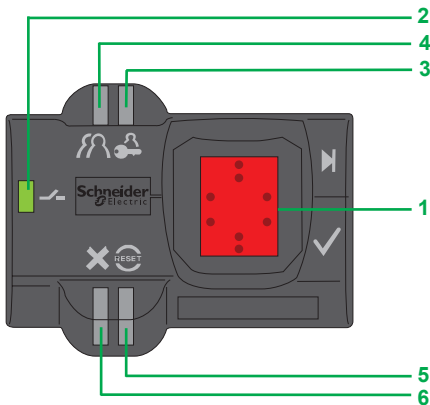

XB5S1B●●●●



XB5S3B●●●●



XB5SFFUSBEXT



ZB5SZ70

### Description

The stand-alone biometric switch (XB5S1/XB5S2) consists of a dark gray housing, with the following on its front face:

- Sensing screen **1** that allows the registration and subsequent recognition of registered fingerprints,
- Green LED output state indicator **2** that illuminates when the output is activated (solid-state NO contact),
- Orange LED **3**, indicating an administrator's "Registration" mode,
- Orange LED **4**, indicating an operator's "Registration" mode,
- Red "RESET" LED **5** which indicates, in "Delete" mode, that the administrator is deleting all or part of the memory,
- Red LED **6** which flashes when the reader is presented with an "unrecognized" fingerprint or in the event of incorrect operation.

The stand-alone USB biometric switch (XB5S3/XB5S4) consists of a dark gray housing with a sensing screen **1** for fingerprints, a green LED **2** for indicating the output state, and a red LED **6** for the unrecognized fingerprint on its front face.

The USB biometric switch dedicated to Schneider Electric HMI (XB5S5) consists of a dark gray housing with a sensing screen **1** for fingerprints on its front face.

### References

#### Complete units

Description	Connection	Reference	Weight kg/lb
Maintained biometric switch 24 Vdc PNP output	By 2 m/6.56 ft cable	<b>XB5S1B2L2</b>	0.170/0.375
	By M12 connector	<b>XB5S1B2M12</b>	0.183/0.403
Momentary biometric switch 24 Vdc PNP output	By 2 m/6.56 ft cable	<b>XB5S2B2L2</b>	0.170/0.375
	By M12 connector	<b>XB5S2B2M12</b>	0.183/0.403
Maintained USB biometric switch 24 Vdc PNP output	By 2 m/6.56 ft cable	<b>XB5S3B2L2</b>	0.202/0.445
	By M12 connector	<b>XB5S3B2M12</b>	0.215/0.474
Momentary USB biometric switch 24 Vdc PNP output	By 2 m/6.56 ft cable	<b>XB5S4B2L2</b>	0.202/0.445
	By M12 connector	<b>XB5S4B2M12</b>	0.215/0.474
USB biometric switch dedicated to Schneider Electric HMI 24 Vdc	By 2 m/6.56 ft cable	<b>XB5S5B2L2</b>	0.202/0.445

#### Accessories

Description	Function	Reference	Weight kg/lb
Female/female USB extension cable with Ø 22 mm/0.866 in. female USB port on one end	For connecting biometric switch to the PC via the Ø 22 mm/0.866 in. hole on the control panel front	<b>XB5SFFUSBEXT</b>	0.108/0.238
Protective cover, translucent and self-adhesive	Protection of sensing screen	<b>ZB5SZ70</b>	0.020/0.044
Mounting nut Ø 22 mm/0.866 in.	Spare part	<b>ZB5SZ71</b>	0.030/0.066
Legend plate, 27 x 8 mm/ 1.06 x 0.32 in., self-adhesive, blank, black background, for engraving	—	<b>ZBY0101T</b>	0.005/0.011

### Specifications

Biometric switch type		XB5S1B●●●●, XB5S2B●●●●, XB5S3B●●●●, XB5S4B●●●●, and XB5S5B●●●●	
Product certifications		UL, CSA, CE, IEC 61000-6-2 / IEC 61000-6-4	
Degree of protection	Conforming to EN/IEC 60529	IP 65, UL Type 12, NEMA 12	
Ambient air temperature	Storage	°C	- 25 to + 70
	Operation	°C	- 5 to + 50
Vibration resistance	Conforming to IEC 60068-2-6	1 gn, 9 to 500 Hz, Amplitude 3 mm, 5 to 9 Hz	
Electric shock resistance	Conforming to IEC 60068-2-27	50 gn, duration 11 ms	
Connection method	Cable	Length: 2 m, 3-wire, pre-wired	
	Connector	M12	
Materials	Housing	Polyamide PA66	
	Cable	PvR 3 x 0.34 mm <sup>2</sup>	
Memory capacity	200 records (100 users, operators or administrators, each registering 2 fingerprints)		
Output state indicator	Green LED		
Short-circuit protection	By gG fuse, 250 mA		
Rated supply voltage	Vdc	24 with protection against reverse polarity	
Voltage limits (including ripple)	Vdc	20 to 30	
Switching capacity	mA	≤ 200 with protection against overloads and short-circuits	
Residual voltage, closed state	V	≤ 1	
No-load current consumption	mA	≤ 50	
Delays	First-up	s	< 2
	Response time	s	< 1
	Recovery time	s	< 1

### Connections

#### Connector

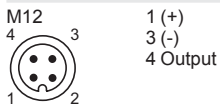

#### Cable with PNP output

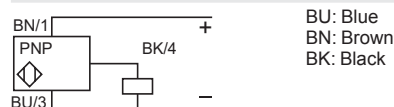

### Dimensions

#### XB5 Biometric Switch

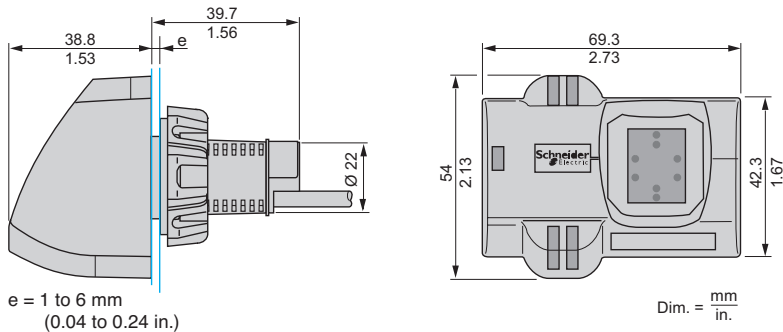

#### Stainless-Steel Cover

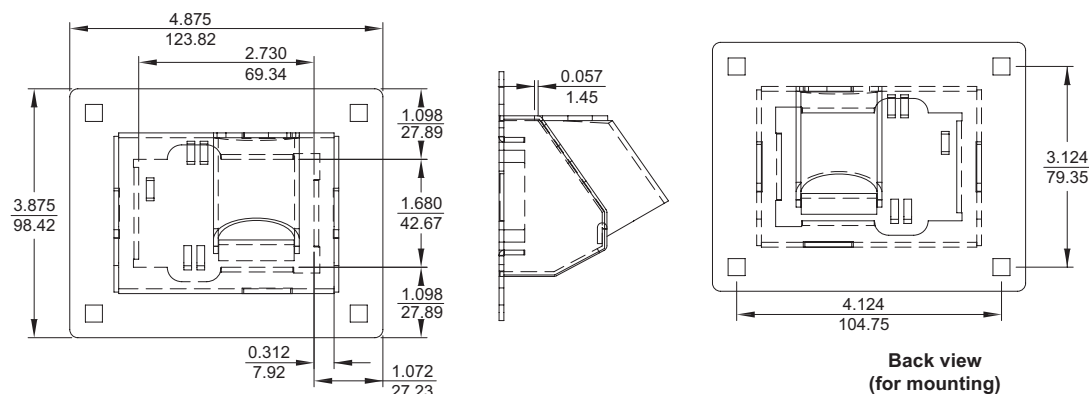



# Harmony™ XB5R plastic and XB4R metal wireless, batteryless push buttons

 It all adds up to the Simple Solution  
for your advanced Push Button  
requirements.



# Reduce installation time with Harmony™ wireless, batteryless XB5R and XB4R push buttons

By totally eliminating cabling and components between the push button and the electrical cabinet, you save installation time, and reduce your installation costs.

- > **Simplified machine cabling**  
with completely wireless push buttons
- > **Easier integration through open protocols**  
by serial link Modbus™ and Ethernet Modbus/TCP
- > **Architecture solutions**  
for integration into industrial and building environments





# Simplified cabling +

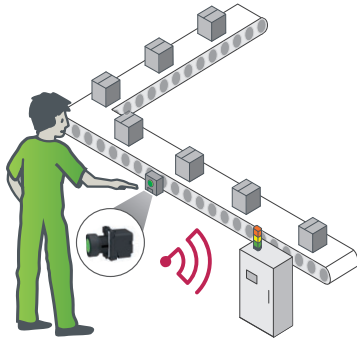

Installing a new hard-wired push button quickly on your conveyor system can be challenging.

You have to take many factors into account: (a) the length of cable and connections to the push button, (b) the cabling and connections in the cabinet, and (c) the time required for fitting the cables in covers or existing cable ducting.

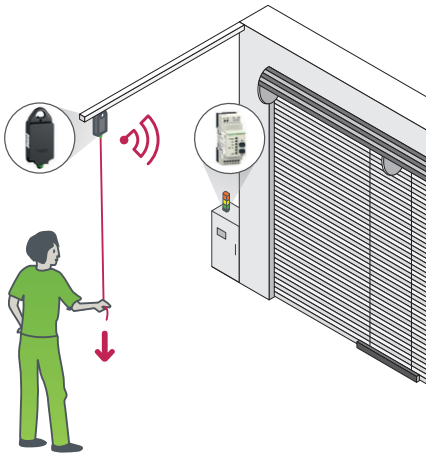

Using the new Harmony™ wireless, batteryless XB5R and XB4R push buttons, or ZBRP1 rope pull switch, the only cabling required is for the receiver in the cabinet.

## Proven reliability

- Continuous availability of control function
- Reduced maintenance with no battery to replace, recharge or recycle
- Energy-efficient, thanks to a non-current consuming transmitter

## Robust functionality

- High resistance to contamination from dust (no cable entry)
- No risk of cable damage or loosened screws on the transmitter
- Proven quality and high performance of the Harmony product range



**no** battery to replace

## Economical and flexible

- Reduction in installation costs and time
- No configuration required, thanks to ready-to-use packs
- Freedom of movement
- Ideal solution when you need to add or move a control function

**20% less** installation costs compared to a hard-wired solution

# Easy integration and open protocols

## Integration into industrial automation systems via a field bus link

- Modbus™ serial link: found on all Schneider Electric PLCs
- Modbus/TCP: integrated into the latest models of Schneider Electric PLCs and HMIs

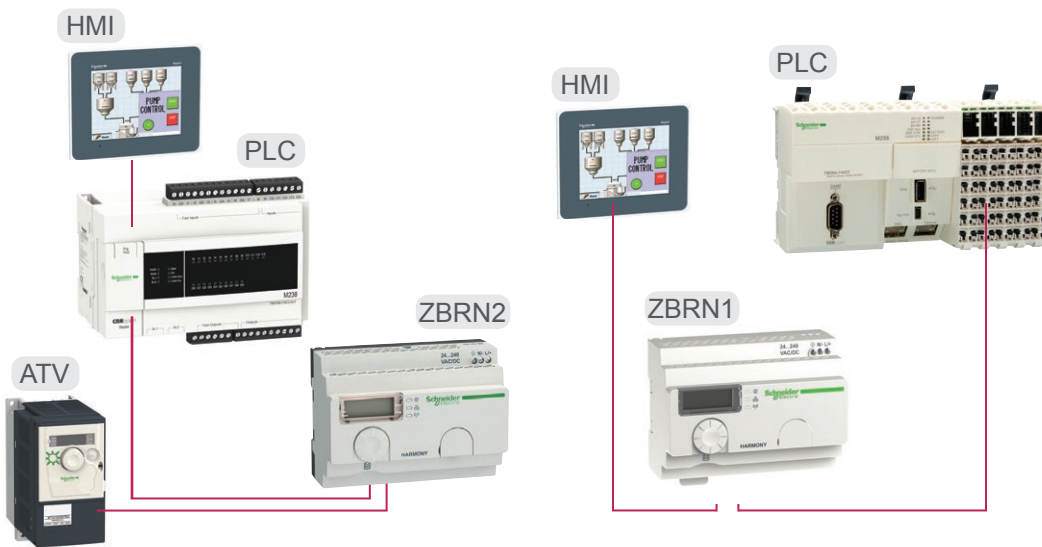

**2**  
Open standard protocols

## Simple and economical

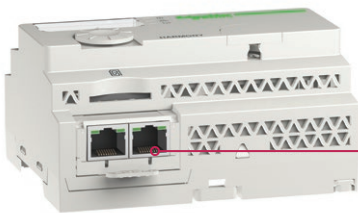

Double RJ45 port enables network continuity without using hubs or switches

Up to **60**  
transmitters  
connected on the  
same bus

## Easy set up

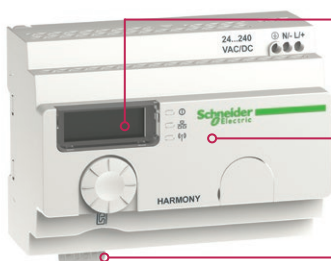

Manual parameter interface

DTM interface and web pages with PC

SD card + csv files with PC

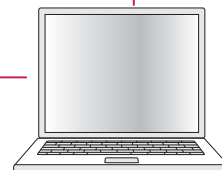

**3**  
setting modes

# Solutions architecture +

Harmony™ XB5R and XB4R Push Buttons are designed to easily integrate into MachineStruxure™ architectures for OEM machine builders and into PlantStruxure™ architectures for process environments.



Examples of architectures – Machine

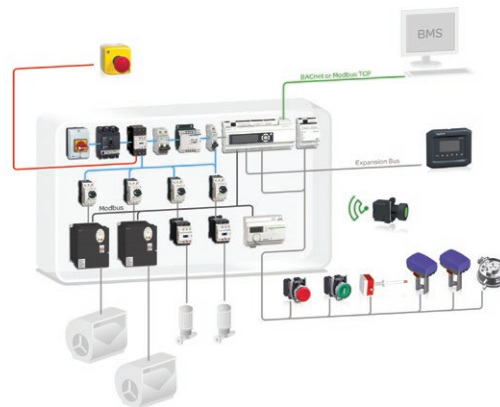

Examples of architectures – HVAC

## Industrial applications

Suitable for a wide range of industrial applications, including explosive atmospheres for dust and gas environments.



## Building applications

Compliant with DIN 43380 standard.



Packaging



Cement

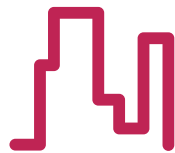

Automatic doors



Hospital



Food & Beverage



Automotive



Hotel



Lighting

# Comprehensive product range +

From individual products to ready-to-use packs

				Ethernet Modbus™ / TCP Module
				<b>ZBRN1</b>
Push button	Rope pull switch	Mushroom head push button	Receiver	Ethernet Modbus serial module
<b>ZB5RTA2</b>	<b>ZBRP1</b>	<b>ZB5RTC2</b>	<b>ZBRRA</b>	<b>ZBRN2</b>
				

## Ready-to-use solution packs

- Designed to meet the requirements of most applications
- Simple to order with only one reference number
- Easy to install with factory pre-programmed transmitter and receiver

Only 1 transmitter per receiver		Up to 32 transmitters per receiver	
	Plastic head		Plastic head
	<b>XB5RFB01</b>		Metal head
	Metal head		Metal head
	<b>XB4RFB01</b>		<b>XB4RFA02</b>
	<ul style="list-style-type: none"> <li>• Transmitter with plastic or metal push button</li> <li>• Non-programmable receiver, 1 relay output</li> </ul>		<ul style="list-style-type: none"> <li>• Transmitter with plastic or metal push button</li> <li>• Set of 10 push button caps</li> <li>• Programmable receiver, 2 relay outputs</li> </ul>
	Plastic head		Plastic head
	<b>XB5RMB03</b>		Metal head
	Metal head		Metal head
	<b>XB5RMB03</b>		<b>XB5RMA04</b>
	<ul style="list-style-type: none"> <li>• Transmitter with plastic push button ZB5R in ergonomic enclosure</li> <li>• Non-programmable receiver, 1 relay output</li> </ul>		<ul style="list-style-type: none"> <li>• Transmitter with plastic push button ZB5R in ergonomic enclosure</li> <li>• Set of 10 push button caps</li> <li>• Programmable receiver, 2 relay outputs</li> </ul>

# Harmony™ XB5R plastic/XB4R metal wireless, batteryless 22 mm push buttons

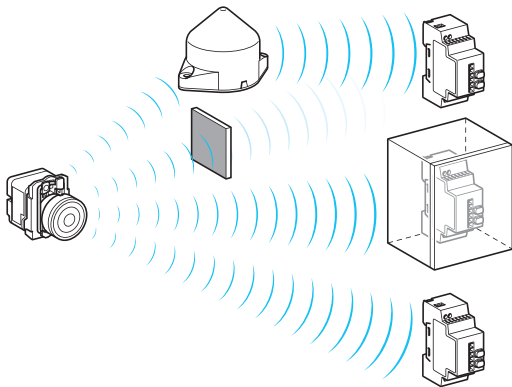

Figure A: radio transmission between 1 transmitter and 3 receivers

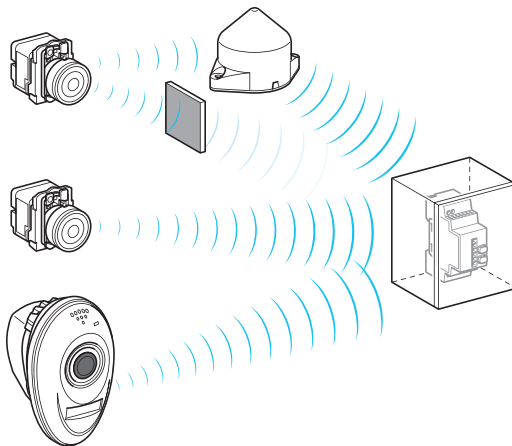

Figure B: radio transmission between 3 transmitters and 1 receiver

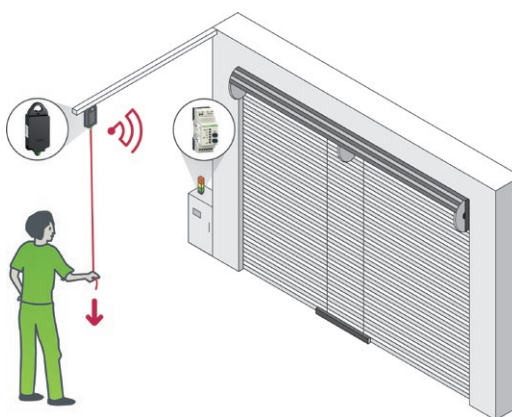

Figure C: rope pull switch for automatic doors

## Introduction

The Harmony wireless, batteryless push button product range enables remote control of a relay (receiver) by means of a push button (transmitter). The control is by radio transmission, where the transmitter is fitted with a “dynamo” type generator that converts mechanical energy – produced when the push button is pressed – to electrical energy. A radio-encoded message with a unique ID code is sent as a single pulse to one or more receivers located several dozen metres away (see figure A). A single receiver can also be actuated by up to 32 different transmitters (see figure B).

Depending on the application, a relay-antenna can be used to “transmit around” an obstacle that impedes transmission, or to increase the range (see figures A and B).

The possible distance (1) between a transmitter and a receiver is approximately:

- 100 m/328 ft where there are no obstacles,
- 25 m/82 ft if the receiver is installed in a metal housing or in a closed metal enclosure,
- 300 m/984 ft if a relay-antenna is located between the transmitter and the receiver (receiver installed in a metal housing or in a closed metal enclosure).

The wireless, batteryless push button reduces installation time and costs, by eliminating wiring and associated equipment between the transmitters and the control panel.

This technology also allows an operator to be mobile or have a control mounted on-board a vehicle (trolley, truck). The push button is always available and requires no maintenance (no battery needed).

The mobile boxes ZBRM21 or ZBRM22 associated with its support function are adapted for static and mobile applications which will be mounted on vehicles.

The new wireless, batteryless ZBRP1 rope pull switch is designed for easy operation of automatic doors. This switch can be either mounted directly on the panel or between two ropes close to the automatic door. This enables the forklift driver or pedestrian to open or close the door by pulling the rope, where the mechanical energy produced is transmitted as a radio message to the receiver placed in the control panel (see figure C).

This technology (radio-encoded message sent as a single pulse) cannot be used for hoisting applications (“up/down”, “right-left” movements, etc) or safety applications (Emergency Stop push buttons). For these applications, it is recommended that Harmony XB4 and XB5 wired push buttons or the XAC range of pendant control stations be used.

## Environment

The performance features of the XB5R range conform to the following specifications:

- International standards and approvals:
  - Wireless, batteryless push buttons: EN/IEC 60947-1, EN/IEC 60947-5-1, UL 508, CSA C22-2 N° 14
  - Transmitter/Receiver system: BT 2006/95/EC, CE: R&TTE 1999/5/EC, EMC 2004/108/EC
- International certifications: UL, CSA, C-Tick, GOST, CCC
- Radio agreements: ANATEL (Brazil), SRRC (China), FCC (USA), RSS (Canada), ICASA (South Africa), ARIB T66 (Japan)

For more technical information, please refer to our website [www.schneider-electric.com](http://www.schneider-electric.com).

(1) Typical values which can be affected by the application environment.

# Harmony™ XB5R plastic/XB4R metal wireless, batteryless 22 mm push buttons

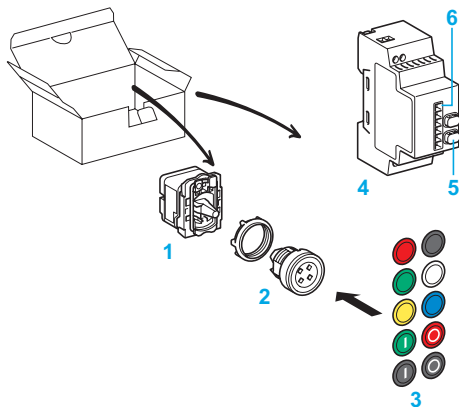

Figure D: pack with transmitter and programmable receiver

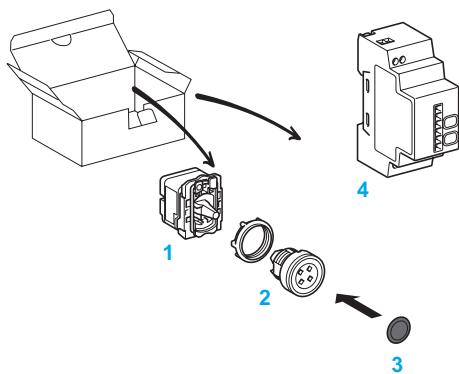

Figure E: pack with transmitter and non-programmable receiver

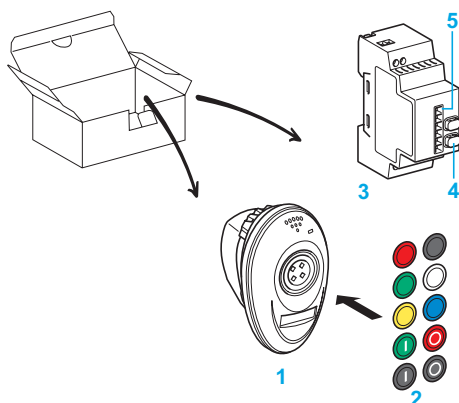

Figure F: pack with transmitter in handy box and programmable receiver

## Description of “ready-to-use packs” product ranges (1)

### Pack with Programmable receiver (see figure D)

The pack includes:

- 1 Transmitter with a mounting collar for assembly with a push button head and mounting in a  $\varnothing 22 \text{ mm}/0.866 \text{ in.}$  hole.
- 2 Flush, spring return, plastic or metal push button head.
- 3 Set of 10 different colored caps, which can be clipped onto the push button head.
- 4  $\approx 24$  to 240 V Programmable receiver, 2 relay outputs, with 2 buttons (teach and parameter setting) 5 and 6 indicating LEDs 6.

### Pack with Non-programmable receiver (see figure E) (1)

The pack includes:

- 1 Transmitter with a mounting collar for assembly with a push button head and mounting in a  $\varnothing 22 \text{ mm}/0.866 \text{ in.}$  hole.
- 2 Flush, spring return, plastic or metal push button head.
- 3 Black cap that can be clipped onto the push button head.
- 4  $\approx 24$  V Non-programmable receiver, 1 relay output, without indicating LED or button.

### Pack with handy box and Programmable receiver (see figure F)

The pack includes:

- 1 Handy box containing a wireless, batteryless push button with plastic head.
- 2 Set of 10 different colored caps, which can be clipped onto the push button head.
- 3  $\approx 24$  to 240 V Programmable receiver, 2 relay outputs, with 2 buttons (teach and parameter setting) 4 and 6 indicating LEDs 5

(1) Wireless, batteryless push button and the receiver are pre-programmed.



# Harmony™ XB5R plastic/XB4R metal wireless, batteryless 22 mm push buttons

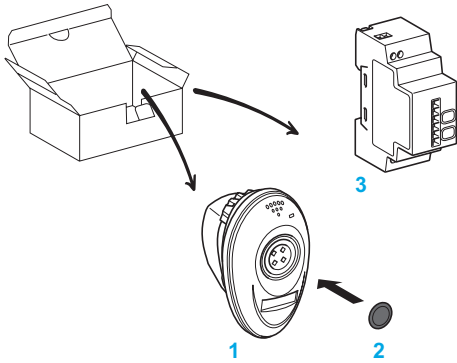

Figure G: pack with transmitter in handy box and non-programmable receiver

## Description of “ready-to-use packs” product ranges (1) (continued)

### Pack with handy box and Non-programmable receiver (see figure G)

The pack includes:

- 1 Handy box containing a wireless, batteryless push button with plastic head.
- 2 Black cap that can be clipped onto the push button head.
- 3 ≡ 24 V Non-programmable receiver, 1 relay output, without indicating LED or button.

## Description of the components

Components are sold separately to allow completion of existing applications or creation of specific applications:

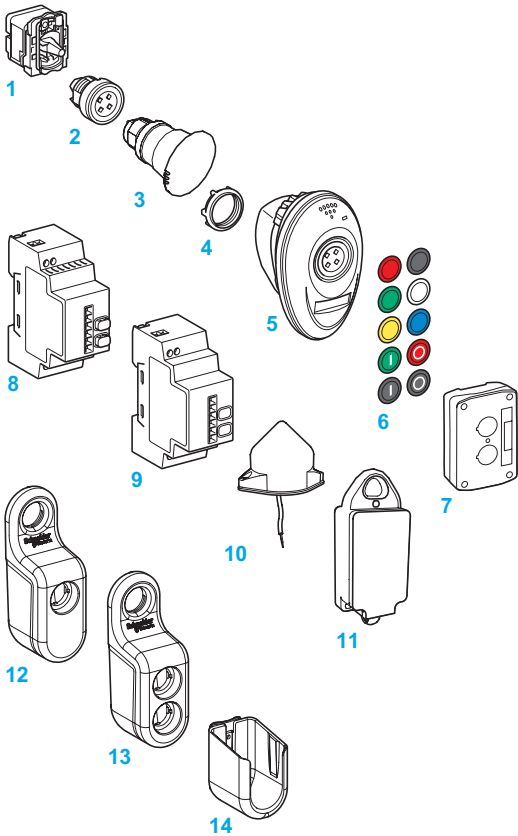

- 1 Transmitter for assembly with push button head and mounting in a  $\varnothing$  22 mm / 0.866 in. hole
- 2 Flush, spring return, push button head, metal or plastic version
- 3 Mushroom head, plastic version
- 4 Plastic or metal mounting collar
- 5 Empty handy box
- 6 Set of 10 different colored caps or set of 10 same color caps, that can be clipped onto the push button head
- 7 Empty plastic boxes (1 or 2 cut-outs) for wall mounting or on-board applications
- 8 ≡ 24 to 240 V Programmable receiver, 2 relay outputs, with 2 buttons (teach and parameter setting) and 6 indicating LEDs
- 9 ≡ 24 V Programmable receiver, 4 PNP outputs, with 2 buttons (teach and parameter setting) and 6 indicating LEDs
- 10 Relay-antenna
- 11 Rope pull switch
- 12 ZBRM21 mobile box for 1 push button
- 13 ZBRM22 mobile box for 2 push buttons
- 14 ZBRACS support for mobile box

(1) Wireless, batteryless push button and the receiver are pre-programmed.



# Harmony™ XB5R plastic/XB4R metal wireless, batteryless 22 mm push buttons

## Specifications of wireless, batteryless push buttons

### Environment specifications

<b>Conforming to standards</b>	Wireless, batteryless push button		EN/IEC 60947-1, EN/IEC 60947-5-1, UL 508, CSA C22-2 n°14
	Transmitter/receiver system		CE : R&TTE 1999/5/EC, BT 2006/95/EC, EMC 2004/108/EC
	Radio frequency		EN300-440-1, EN300-440-2, FCC part. 15, RSS210, ANATEL (resolution 506), SRRC, EMC: EN301-489-1, EN301-489-3 SAR (Specific Absorption Rate) compliant. Power transmitted by the button < 3 mw
<b>Product certifications and radio agreements</b>			UL, FCC (USA), CSA, RSS (Canada), C-Tick (Australia), GOST (Russia), ANATEL (Brazil), SRRC (China), CE (Europe)
<b>Protective treatment standard version</b>			"TH"
<b>Ambient air temperature around the device</b>	Storage	°C	- 40 to + 70
	Operation	°C	- 25 to + 70
<b>Relative humidity permissible</b>	Transmitter block		+ 95% RH at 70° C (without condensation)
<b>Degree of protection</b>	Conforming to IEC 60529		IP 65 (front face) IP 30 (back face)
	Conforming to UL / CSA		Type 12
	Conforming to IEC 50102		IK 03
<b>Mechanical shock protection</b>	Conforming to IEC 50102		IK 03
<b>Free fall resistance</b>	Conforming to IEC 60068-2-32	mm	1 000

### Mechanical specifications

<b>Operating travel (when sending information)</b>	Push button	mm	Total travel: 4.3 Instruction sent when wireless, batteryless push button clicks
<b>Operating force</b>	Spring return push button with its transmitter	N	< 25
<b>Mechanical durability (in millions of operating cycles)</b>	Spring return push button with its transmitter		1
<b>Vibration resistance conforming to IEC 60068-2-6</b>	Frequency: 2 to 11Hz	mm	± 10
	Frequency: 11 to 500Hz	gn	5
<b>Shock resistance conforming to IEC 60068-2-27</b>	Half sine wave acceleration 11 ms	gn	50
	Half sine wave acceleration 18 ms	gn	30
<b>Repetitive shocks resistance</b>	Conforming to IEC 60068-2-27	gn	25 (duration: 6 ms - 6 000 shocks)
<b>Head tightening torque</b>	Plastic head (nut)		2.2 N.m (± 0.2) / 9.5 lb.in (± 1.8)
	Metal head (base screw)		0.8 N.m (max 1.2) / 7.5 lb.in (max 10.6)

### Radio transmission specifications

<b>Frequency</b>		GHz	2.4
<b>Protocol</b>			ZigBee® Green Power compatible (transmitter and receiver can work with other ZigBee® Green Power products)
<b>Range</b>		m	Approx. 100 (transmitter and receiver in free space)
			Approx. 25 (transmitter in a plastic box type XALD and receiver in a metal enclosure)
			Approx. 40 (transmitter in plastic box type XALD, receiver in a metal enclosure and use of a relay-antenna)
<b>Transmission power</b>		mW	3
<b>Activation time</b>		ms	2
<b>Transmission time</b>		ms	< 2
<b>Type</b>	Conforming to EN 301-489-3 § 4.1 - Equipment		Type III
<b>Class</b>	Conforming to EN 301-489-3 § 6.1 - Equipment		Class 2
<b>Category</b>	Conforming to EN 300-440-1 § 5.4.1.2 - Temperature	°C	Category 1: - 20 to + 55

### Electromagnetic immunity and emissions

<b>Resistance to electrostatic discharges</b>	Conforming to IEC 61000-4-2	kV	8: on insulating parts (in free air) 6: on metal parts (contact)
	Conforming to EN/IEC 60947-5-1 and IEC 61000-4-3	V/m	10: for 80 MHz to 2 000 MHz
<b>Resistance to electromagnetic fields</b>	Conforming to IEC 61000-4-3, EN 301-489-3 and EN 301-489-1	V/m	3: for 80 MHz to 2 700 MHz and distance = 20 m
	Conforming to EN 300-440-1 and EN 300-440-2		Compliant

# Harmony™ XB5R plastic/XB4R metal wireless, batteryless 22 mm push buttons

## Specifications of receiver for wireless, batteryless push buttons (continued)

### Environment specifications

<b>Conforming to standards</b>	Receiver		EN/IEC 60947-1, EN/IEC 60947-5-1, UL 508, CSA C22-2 n° 14, IEC 61000-4-2, IEC 61000-4-3, IEC 61000-4-4, IEC 61000-4-5, IEC 61000-4-6, IEC 61000-4-11
	Transmitter/receiver system		CE: R&TTE 1999/5/EC, BT 2006/95/EC, EMC 2004/108/EC
	Radio frequency		EN300-440-1, EN300-440-2, FCC part. 15, RSS210, ANATEL (resolution 506), SRRC, EMC: EN301-489-1, EN301-489-3
<b>Product certifications and radio agreements</b>			UL, FCC (USA), CSA, RSS (Canada), C-Tick (Australia), GOST (Russia), ANATEL (Brazil), SRRC (China), CE (Europe)
<b>Ambient air temperature around the device</b>	Storage	°C	- 40 to + 70
	Operation	°C	- 25 to + 55
<b>Permissible relative humidity</b>			+ 90 % RH at + 55 °C (without condensation)
<b>Vibration resistance conforming to IEC 60068-2-6</b>	Frequency: 5 to 8.14 Hz	mm	± 7.5
	Frequency: 8.14 to 150 Hz	gn	2
<b>Shock resistance conforming to IEC 60068-2-27</b>	Half sine wave acceleration: 11 ms	gn	30
<b>Repetitive shocks resistance</b>	Conforming to IEC 60068-2-27	gn	10 (duration: 16 ms - 6 000 shocks)
<b>Degree of protection</b>	Conforming to IEC 60529		IP 20
<b>Degree of pollution</b>	Conforming to IEC 60664-1		2
<b>Housing material</b>			Self-extinguishing plastic
<b>Mounting position without derating (temperature)</b>			Any position
<b>Mounting</b>			On DIN rail conforming to EN/IEC 60715 On mounting plate

### Electrical specifications

<b>Overvoltage category</b>	Conforming to IEC 60664-1		II (AC/DC receiver), III (DC receiver)
<b>Insulation resistance</b>	Conforming to NFC 20030		> 500 MΩ, --- 500 V
<b>Rated insulation voltage</b>	Conforming to IEC 60664-1	V	250 (receivers with relay outputs), < 60 (relay with PNP outputs)
<b>Insulation test voltage conforming to EN/IEC 60947-5-1</b>	Dielectric test	Hz/KV	AC/DC receiver: 50 / 1.5 (1 minute)
			DC receiver: 50 / 1 (1 minute)
	Surge	kV	DC receiver: Uimp = 0.8 (1.2 / 50 μs) AC/DC receiver: Uimp = 4 (1.2 / 50 μs)
<b>Cabling Maximum c.s.a. conforming to EN/IEC 60947-1</b>	Solid cable without cable end	mm²	1 conductor: 0.14 to 2.5 (AWG 26 to AWG 14) 2 conductors: 0.14 to 1.5 (AWG 26 to AWG 16)
	Flexible cable with cable end	mm²	1 conductor: 0.14 to 4 (AWG 26 to AWG 12) 2 conductors: 0.14 to 1.5 (AWG 26 to AWG 16)
<b>Tightening torque</b>	Conforming to EN/IEC 60947-1		0.5 N.m/4.43 Lbf.In
<b>Power ON indicator</b>			Green LED
<b>Output indicators</b>			Green LED (relay outputs and PNP outputs)
<b>Received signal strength</b>			Green LED: optimum reception Yellow LED: acceptable reception

### Supply specifications

Receiver type	ZBRRC	Receiver included in packs XB4RFB01, XB5RFB01 and XB5RMB03	ZBRRA
<b>Supply voltage Ue</b>	V	--- 24 (+ 20/- 15 %)	~/--- 24 to 240 (+/- 10 %)
<b>Frequency</b>	Of the power supply circuit	Hz	50/60 ± 10 %
<b>Galvanic isolation</b>	Power supply/output		Yes
<b>Maximum power drawn</b>		W	20
<b>Short-circuit protection</b>			Fast-blow fuse 400 mA
<b>Immunity to microbreaks</b>		ms	7 (total output current 800 mA) 10 (total output current 500 mA)

### Electromagnetic immunity and emissions

<b>Resistance to electrostatic discharges</b>	Conforming to IEC 61000-4-2	kV	8: on insulating parts (in free air) 6: on metal parts (contact)
<b>Resistance to electromagnetic fields</b>	Conforming to EN/IEC 60947-5-1 and IEC 61000-4-3	V/m	10: for 80 MHz to 2 000 MHz
	Conforming to IEC 61000-4-3, EN 301-489-3 and EN 301-489-1	V/m	3: for 80 MHz to 2 700 MHz and distance = 20 m
<b>Resistance to fast transients</b>	Conforming to IEC 61000-4-4	kV	1 (PNP output wires) 2 (power supply wires)
<b>Hybrid surge withstand conforming to IEC 61000-4-5</b>	Differential mode	kV	0.5
	Common mode	kV	1
<b>Resistance to conducted disturbance</b>	Conforming to IEC 61000-4-6	V	10
<b>Emissions</b>	Conducted emissions conforming to EN 300-489-3, EN 300-489-1		As per class B method CISPR22
	Radiated emissions conforming to EN 300-440-1, EN 300-440-2		Compliant

# Harmony™ XB5R plastic/XB4R metal wireless, batteryless 22 mm push buttons

**Specifications of wireless, batteryless push buttons (continued)**

Radio transmission specifications				
Receiver type		ZBRRC	ZBRRB	Receiver included in packs XB4RFB01, XB5RFB01 and XB5RMB03
Frequency	GHz	2.4		
Protocol		ZigBee® Green Power compatible (transmitter and receiver can work with other ZigBee® Green Power products)		
Range	m	Approx. 100 (transmitter and receiver in free space)		
		Approx. 25 (transmitter in a plastic box type XALD and receiver in a metal enclosure)		
		Approx. 40 (transmitter in a plastic box type XALD, receiver in a metal enclosure and use of a relay-antenna)		
Relay-antenna		To increase the range or to get round an obstacle		
Response time	ms	< 30 after the transmitter "clicks"		
Number of transmitter ID codes that can be stored		32 max. per receiver or 32 max. per output (example on 2-output receiver: 32/0, 16/16, etc.)		
Type	Conforming to EN 301-489-3 § 4.1 - Equipment	Type III		
Class	Conforming to EN 301-489-3 § 6.1 - Equipment	Class 2		
Reliability	Conforming to EN 300 440-1 § 4.1.1 - Reliability	Category 2		
Temperature	Conforming to EN 300 440-1 § 5.4.1.2 - Temperature	°C Category I : - 20 to + 55		
Output specifications				
Output type		4 PNP outputs 200 mA/24 V	2 relay outputs type RT 3A	1 relay output type RT 3A
Output function		Monostable (500 ms ± 15 %)	Monostable (500 ms ± 15%). Programmable to bistable or Start/Stop	Monostable (500 ms ± 15%)
Nominal current I <sub>e</sub> conforming to EN/IEC 60947-5-1 and UL 508 / CSA C22-2 n°14	DC supply conforming to EN/IEC 60947-5-1	A	2	0.3 / 48 V DC
	DC supply conforming to UL 508 / CSA C22-2 n°14	A	–	3 / 24 V DC
	AC supply conforming to EN/IEC 60947-5-1	A	–	1.5 / 240 V AC 3 / 120 V AC
	AC supply conforming to UL 508 / CSA C22-2 n°14	A	–	3 / 240 V AC
Voltage drop		V	< 2	–
Maximum switching voltage		V	–	~/∞ 250
Nominal breaking capacity			4.8 W (0.2 A x 24 V DC) per output	750 VA (3 A x 250 V AC) 15 W (0.3 A x 48 V DC)
Minimum current I <sub>th</sub>	Conforming to EN/IEC 60947-5-1	mA	10 / ∞ 5 V	
Maximum current		A	–	5
Electrical durability			–	1 x 10 <sup>5</sup> operating cycles
Mechanical durability			–	10 x 10 <sup>5</sup> operating cycles
Maximum operating rate		Hz	2	
Utilization categories	Conforming to EN/IEC 60947-5-1		DC13	AC15: B300
				DC12

# Harmony™ XB5R plastic/XB4R metal wireless, batteryless 22 mm push buttons

## Specifications of relay-antenna for wireless, batteryless push buttons - Works with transmitter(s) and receiver(s)

### Environment specifications

Conforming to standards	Antenna		EN/IEC 60947-1, EN/IEC 60947-5-1, UL 508, CSA C22-2 n° 14, IEC 61000-4-2, IEC 61000-4-3, IEC 61000-4-4, IEC 61000-4-5, IEC 61000-4-6, IEC 61000-4-11
	Transmitter /antenna / receiver system		CE: R&TTE 1999/5/EC, BT 2006/95/EC, EMC 2004/108/EC
	Radio frequency		EN300-440-1, EN300-440-2, FCC part. 15, RSS210, ANATEL (resolution 506), SRRC, EMC: EN301-489-1, EN301-489-3
Product certifications and radio agreements			UL, FCC (USA), CSA, RSS (Canada), C-Tick (Australia), GOST (Russia), ANATEL (Brazil), SRRC (China), CE (Europe)
Ambient air temperature around the device	Storage	°C	- 40 to + 70
	Operation	°C	- 25 to + 55
Electric shock protection	Conforming to IEC 61140		Class II
Permissible relative humidity			+ 90 % RH at + 55 °C (without condensation)
Vibration resistance conforming to IEC 60068-2-6	Frequency: 10 to 55 Hz	mm	± 0.5
	Frequency: 55 to 500 Hz	gn	6
Shock resistance	Conforming to IEC 60068-2-27		Half sine wave acceleration: 11 ms / 15 gn
Repetitive shocks resistance	Conforming to IEC 60068-2-27	gn	25 (duration: 6 ms - 6 000 shocks)
Degree of protection	Conforming to IEC 60529, UL/CSA		IP 65 - type 12
Degree of pollution	Conforming to IEC 60664-1		3
Overvoltage category	Conforming to IEC 60664-1		III
Insulation resistance	Conforming to NFC 20030		> 500 MΩ, --- 500 V
Rated insulation voltage	Conforming to IEC 60664-1	V	250
Insulation test voltage conforming to EN/IEC 60947-5-1	Dielectric test	Hz/KV	50 / 4 (1 minute)
	Surge	kV	Uimp = 4 (1.2 / 50 μs)
Cabling (flexible cable)	Conforming to EN/IEC 60947-1	m	5 (2 x 0.34 mm <sup>2</sup> )
Screw tightening torque	Conforming to EN/IEC 60947-1		0.6 ± 0.1 Nm / 5.3 ± 0.9 Lb.-In
Housing material			Self-extinguishing plastic
Indication	Power ON		1 green LED
	Transmission/reception		2 green LEDs at 180°
Mounting position			See instructions for assembly

### Supply specifications

Supply voltage Ue		V	~/-: 24 to 240 (± 10 %)
Frequency	Of the power supply circuit	Hz	50/60 ± 10 %
Maximum power drawn		W	< 4
Short-circuit protection		mA	400 with fast-blow fuse 400 mA
Resistance to microbreaks			Conforming to IEC 61000-4-11

### Electromagnetic immunity and emissions

Resistance to electrostatic discharges	Conforming to IEC 61000-4-2	kV	8: on insulating parts (in free air) 6: on metal parts (contact)
Resistance to electromagnetic fields	Conforming to EN/IEC 60947-5-1 and IEC 61000-4-3	V/m	10: for 80 MHz to 2 000 MHz
	Conforming to IEC 61000-4-3, EN 301-489-3 and EN 301-489-1	V/m	3: for 80 MHz to 2 700 MHz and distance = 20 m
Resistance to fast transients	Conforming to IEC 61000-4-4	kV	2
Hybrid surge withstand conforming to IEC 61000-4-5	Differential mode	kV	1
	Common mode	kV	2
Resistance to conducted disturbance	Conforming to IEC 61000-4-6	V	10
Emissions	Conducted emissions conforming to EN 300-489-3, EN 300-489-1		As per class B method CISPR22
	Radiated emissions conforming to EN 300-440-1, EN 300-440-2		Compliant

### Radio transmission specifications

Frequency		GHz	2.4
Protocol			ZigBee® Green Power compatible (transmitter and receiver can work with other ZigBee® Green Power products)
Range		m	Approx. 40 m (transmitter in a plastic box type XAL D, receiver in a metal enclosure and use of a relay-antenna)
Transmission power		mW	< 3
Type	Conforming to EN 301-489-3 § 4.1 - Equipment		Type III
Class	Conforming to EN 301-489-3 § 6.1 - Equipment		Class 2
Reliability	Conforming to EN 300-440-1 § 4.1.1 - Reliability		Category 2
Temperature	Conforming to EN 300-440-1 § 5.4.1.2 - Temperature	°C	Category I: - 20 to + 55

# Harmony™ XB5R plastic/XB4R metal wireless, batteryless 22 mm push buttons



Ready-to-use packs (1)						
Description	Transmitter type	Voltage receiver V	Receiver type	Reference	Weight kg/lb	
<b>Packs include:</b> - 1 <b>Wireless, batteryless</b> push button assembled on mounting collar, - 1 <b>receiver</b> push button and receiver are pre-programmed.	Wireless, batteryless push button + Ø 22 mm/0.866 in. <b>plastic</b> head + 1 set of 10 different colored caps (1 cap to be selected and fitted)	≈ 24 to 240	Programmable receiver ZBRRA equipped with: - choice of 3 output functions (momentary, maintained, stop/start) - 2 relay outputs type RT 3A (2), - 2 buttons (teach, parameter setting) - 6 indicating LEDs (power ON, function modes, output status, signal strength)	<b>XB5RFA02</b>	0.230/0.507	
	Wireless, batteryless push button + Ø 22 mm/0.866 in. <b>metallic</b> head + 1 set of 10 different colored caps (1 cap to be selected and fitted)			Non-programmable receiver equipped with momentary output function: - 1 relay output type RT 3A - without button - without indicating LED	<b>XB4RFA02</b>	0.245/0.540
	Wireless, batteryless push button + Ø 22 mm/0.866 in. <b>plastic</b> head + 1 black cap not fitted		≈ 24	Programmable receiver ZBRRA equipped with: - choice of 3 output functions (momentary, maintained, stop/start) - 2 relay outputs type RT 3A (2), - 2 buttons (teach, parameter setting) - 6 indicating LEDs (power ON, function modes, output status, signal strength)	<b>XB5RFB01</b>	0.230/0.507
	Wireless, batteryless push button + Ø 22 mm/0.866 in. <b>metallic</b> head + 1 black cap not fitted			Non-programmable receiver equipped with momentary output function: - with 1 relay output type RT 3A - without button - without indicating LED	<b>XB4RFB01</b>	0.245/0.540
<b>Packs include:</b> - 1 <b>Wireless, batteryless</b> push button assembled on mounting collar, in handy box (3), - 1 <b>receiver</b> push button and receiver are pre-programmed.	Wireless, batteryless push button + Ø 22 mm/0.866 in. <b>plastic</b> head mounted in a handy box + 1 set of 10 different colored caps (1 cap to be selected and fitted)	≈ 24 to 240	Programmable receiver ZBRRA equipped with: - choice of 3 output functions (momentary, maintained, stop/start) - 2 relay outputs type RT 3A (2), - 2 buttons (teach, parameter setting) - 6 indicating LEDs (power ON, function modes, output status, signal strength)	<b>XB5RMA04</b>	0.250/0.551	
	Wireless, batteryless push button + Ø 22 mm/0.866 in. <b>plastic</b> head mounted in a handy box + 1 black cap not fitted		≈ 24	Non-programmable receiver equipped with momentary output function: - with 1 relay output type RT 3A - without button - without indicating LED	<b>XB5RMB03</b>	0.250/0.551

(1) Wireless, batteryless push button and the receiver are pre-programmed.  
 (2) Receivers supplied are set to momentary output function. The user can configure it to maintained and stop/start functions.  
 (3) Supplied with a magnet to be attached by the customer.

# Harmony™ XB5R plastic/XB4R metal wireless, batteryless 22 mm push buttons



## Transmitter components for wireless, batteryless push buttons

Description	Type of push	Color	Reference	Weight kg/lb	
Transmitter for wireless, batteryless push button (1) (2)	1 radio frame sent at the push of the button	–	ZBRT1	0.025/0.055	
	1 radio frame sent at the push of the button 1 radio frame sent at the release of the button	–	ZBRT2 ▲ (5)	0.025/0.055	
Spring return push button heads for transmitter ZBRT1	Flush (plastic)	Without cap (3)	ZB5RZA0	0.015/0.033	
	Flush (metal)	Without cap (3)	ZB4RZA0	0.030/0.066	
Spring return mushroom head for transmitter ZBRT1	Mushroom 40 mm/1.58 in. (plastic)	Black	ZB5RZC2	0.025/0.055	
Wireless, batteryless push button including: - a transmitter fitted with mounting collar - a spring return mushroom head	Mushroom 40 mm/1.58 in. (plastic)	Black	ZB5RTC2	0.055/0.121	
Wireless, batteryless push buttons including: - a transmitter fitted with mounting collar - a spring return push button head with clipped-in cap (4)	Flush (plastic)	White	ZB5RTA1	0.045/0.099	
		Black	ZB5RTA2	0.045/0.099	
		Green	ZB5RTA3	0.045/0.099	
		White I on green background	ZB5RTA331	0.045/0.099	
		Red	ZB5RTA4	0.045/0.099	
		White O on red background	ZB5RTA432	0.045/0.099	
		Yellow	ZB5RTA5	0.045/0.099	
		Blue	ZB5RTA6	0.045/0.099	
		Flush (metal)	White	ZB4RTA1	0.085/0.187
			Black	ZB4RTA2	0.085/0.187
Green	ZB4RTA3		0.085/0.187		
White I on green background	ZB4RTA331		0.085/0.187		
Red	ZB4RTA4		0.085/0.187		
White O on red background	ZB4RTA432		0.085/0.187		
Flush (metal)	Yellow	ZB4RTA5	0.085/0.187		
	Blue	ZB4RTA6	0.085/0.187		

## Transmitter components for wireless, batteryless rope pull switch

Description	Application	Reference	Weight kg/lb
Rope pull switch with wireless, batteryless transmitter	For automatic doors: The rope pull switch sends a radio message to the receiver placed in the control panel to open and close the door.	ZBRP1	0.150/0.331

(1) Mounting collar ZB5AZ009 (plastic) or ZB4BZ009 (metal) to be ordered separately.  
 (2) Only heads ZB4RZA0 and ZB5RZA0 are mechanically compatible.  
 (3) Cap to be ordered separately. Refer to the "Accessories" table on page 185.  
 (4) This cap is fitted by Schneider Electric and cannot be removed (risk of damage).  
 (5) This transmitter is only compatible with receiver ZBRR▲ version ≥ 2.0, relay antenna ZBRA1 version ≥ 2.0 and access point ZBRN▲ version > 1.2.

▲ Available: May 2014.



# Harmony™ XB5R plastic/XB4R metal wireless, batteryless 22 mm push buttons



ZBRRA



ZBA7235



ZBA7331



ZBA7432



ZBA79



ZBRM22



ZBRACS



ZBRM01



XALD02



ZBRA1

## Programmable receivers

Description	Output function	Output type	Receiver voltage V	Reference	Weight kg/lb
<b>Programmable receivers (1) equipped with:</b> - 2 buttons (teach and parameter setting) - 6 indicating LEDs (power ON, function modes, output status, signal strength)	Momentary	4 PNP outputs, 200 mA /24 V	24	ZBRRC	0.130/0.287
	Momentary, Maintained	2 relay outputs type RT 3A (2)	24 to 240	ZBRRD	0.130/0.287
	Momentary, Maintained, Stop/Start	2 relay outputs type RT 3A (2)	24 to 240	ZBRRA	0.130/0.287

## Accessories

### Caps for Harmony push button heads ZB5RZA0 and ZB4RZA0

Description	Background color	Marking	Sold in lots of	Unit reference	Weight kg/lb
<b>Sets of 10 different colored caps with identical marking (3)</b>	White	Without	10	ZBA71	0.010/0.022
		"I" (black)	10	ZBA7131	0.010/0.022
		"↑" (black)	10	ZBA7134	0.010/0.022
	Black	"+" (black)	10	ZBA7138	0.010/0.022
		Without	10	ZBA72	0.010/0.022
		"O" (white)	10	ZBA7232	0.010/0.022
	Green	"+" (white)	10	ZBA7233	0.010/0.022
		"↓" (white)	10	ZBA7235	0.010/0.022
		"I" (white)	10	ZBA7237	0.010/0.022
	Red	Without	10	ZBA73	0.010/0.022
		"I" (white)	10	ZBA7331	0.010/0.022
		"+" (white)	10	ZBA7333	0.010/0.022
	Yellow	"↑" white	10	ZBA7335	0.010/0.022
		"II" (white)	10	ZBA7336	0.010/0.022
		Without	10	ZBA74	0.010/0.022
	Blue	"O" (white)	10	ZBA7432	0.010/0.022
		Without	10	ZBA75	0.010/0.022
		Without	10	ZBA76	0.010/0.022
<b>Set of 10 different colored caps with different markings (3)</b>	White, black, green, red, yellow, blue, white "I" on green background, black "I" on white background, white "O" on red background, white "O" on black background		1	ZBA79	0.010/0.022

<b>Set of 6 different colored caps</b>	White, black, green, red, yellow, blue	1	ZBA80	0.010/0.022
--	--	---	-------	-------------

### Boxes for wireless, batteryless push buttons

Product	Application	Description	Sold in lots of	Unit reference	Weight kg/lb
<b>Handy box, plastic, empty (4) (8)</b>	For mobile and mount applications with wireless, batteryless push buttons	1 cut-out	1	ZBRM21	0.109/0.240
		2 cut-outs	1	ZBRM22	0.110/0.243
		Support for tube or wall specific for ZBRM21 and ZBRM22	1	ZBRACS	0.064/0.141
<b>Mobile box, plastic, empty (4) (5) (8)</b>	For mobile wireless, batteryless push buttons	1 cut-out	1	ZBRM01	0.040/0.088
<b>Empty plastic boxes for wireless, batteryless push buttons (6)</b>	For mounted or on-board wireless, batteryless push buttons	1 cut-out	1	XALD01	0.136/0.300
		2 cut-outs	1	XALD02	0.193/0.426

### Accessories

<b>Relay-antenna (7)</b>	Between transmitter and receiver Used to increase the range and/or get round obstacles	24 to 240 V - 5 m /16.4 ft cable - 1 power-ON LED - 2 LEDs reception/transmission	1	ZBRA1	0.200/0.441
<b>Mounting collar</b>	-	Plastic	10	ZB5AZ009	0.038/0.084
		Metal	10	ZB4BZ009	0.038/0.084
<b>Legend plate, 27 x 8 mm/ 1.06 x 0.32 in., for engraving</b>	For attaching to handy box ZBRM01, ZBRM21 and ZBRM22	Self-adhesive, blank, Black background	10	ZBY0101T	0.005/0.011

(1) Each receiver can be actuated by up to 32 transmitters.

(2) Receivers supplied are set to momentary output function. The user can configure it to maintained and stop/start functions.

(3) Cap can be snapped on at 90° intervals, through 360°.

(4) Cannot be used for wired contacts (no cable gland outlet)

(5) Supplied with a magnet to be attached by the customer.

(6) Box equipped with cable gland outlets, compatible with Harmony ZB5 push button heads.

(7) Not wired to the receiver.

(8) Compatible with ZBR1 and ZBR2.



# Harmony™ XB5R plastic/XB4R metal wireless, batteryless 22 mm push buttons

## Dimensions

### Wireless, batteryless push buttons - Transmitter

**ZB5RTA●●●, with plastic push button and cap**

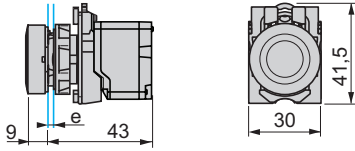

e: panel thickness 1 to 6 mm

**ZB4RTA●●●, with metal push button and cap**

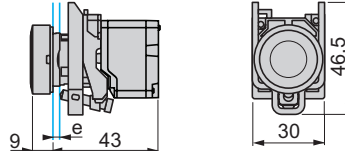

e: panel thickness 1 to 6 mm

### ZBRM01, Plastic handy box for mobile use

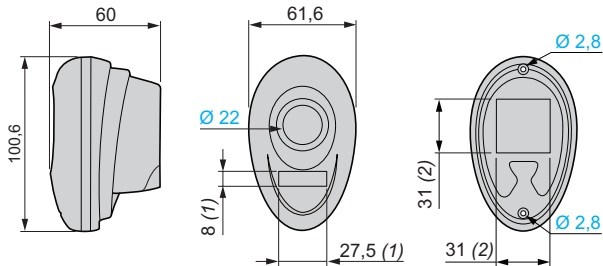

### XALD01, Plastic box, single-hole for mounted or on-board installation

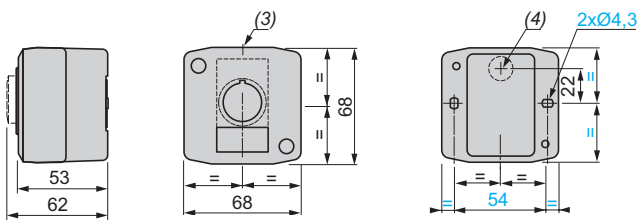

### XALD02, Plastic box, 2-hole for mounted or on-board installation

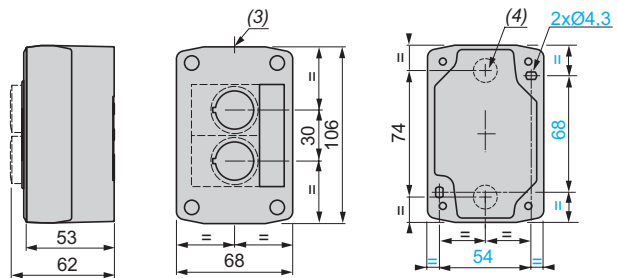

- (1) Location for ZBY0101T legend.
- (2) Location for magnet to be attached by customer.

- (3) 2 knock-outs for Pg 13.5 cable gland, maximum capacity 12 mm.
- (4) Knock-out for wire routing, maximum capacity 14 mm.

### Non-programmable receiver

Receiver contained in packs XB4RFB01, XB5RFB01 and XB5RMB03

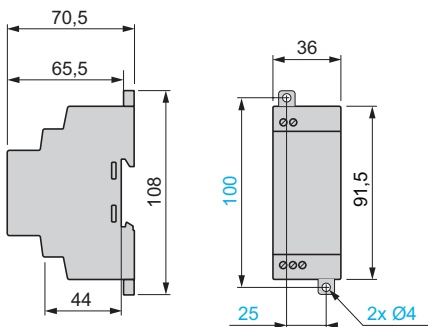

### Programmable receivers

Receivers ZBRR● (contained in packs XB4RFA02, XB5RFA02 and XB5RMA04)

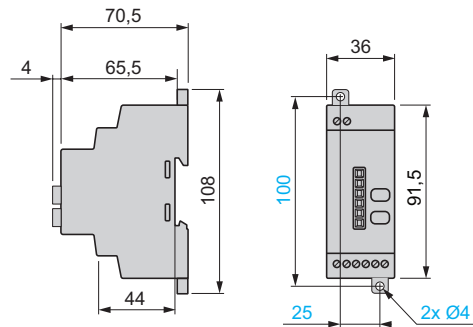

### Relay-antenna

ZBRA1

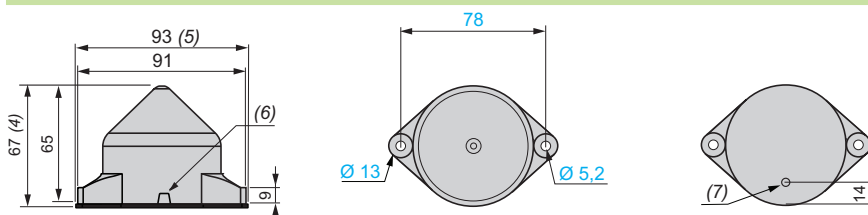

- (5) With seal.
- (6) Radial cable route.

- (7) Axial cable route.

## Wiring diagrams

### Non-programmable receiver

Receiver contained in packs XB5RFB01 and XB5RMB03

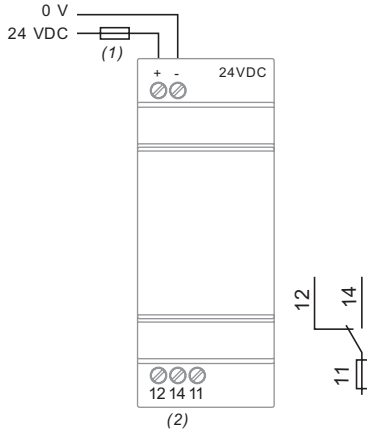

(1) 125 mA fast-blow fuse.  
(2)  $I_{max} = 3\text{ A}$ .

### Programmable receivers

Receiver ZBRRR (contained in packs XB4RFA02, XB5RFA02 and XB5RMA04)

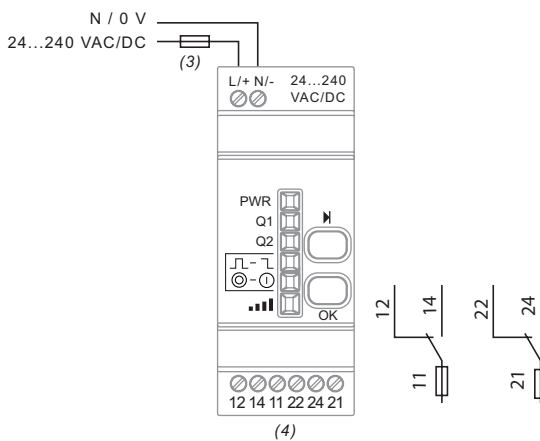

(3) 400 mA fast-blow fuse.  
(4)  $I_{max} = 3\text{ A}$ .

Receiver ZBRRC

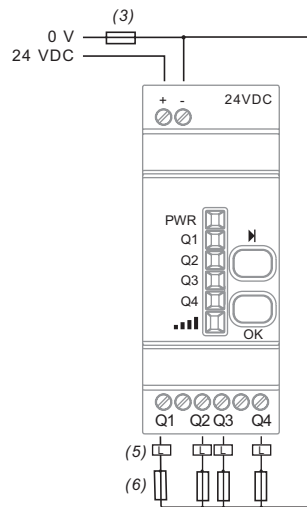

(3) 400 mA fast-blow fuse.  
(5)  $I_{max} = 200\text{ mA}$   
(6)  $I_{max} = 300\text{ mA}$ .

### Relay-antenna

ZBRA1

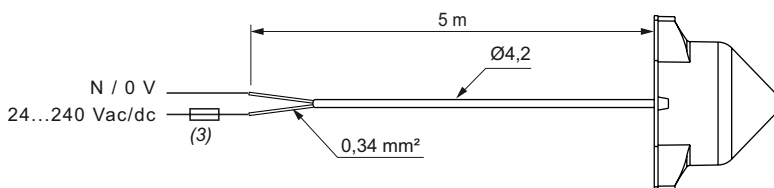

(3) 400 mA fast-blow fuse.

# Harmony™ XB5R plastic/XB4R metal wireless, batteryless 22 mm push buttons

## ZBRN1 and ZBRN2 Access points

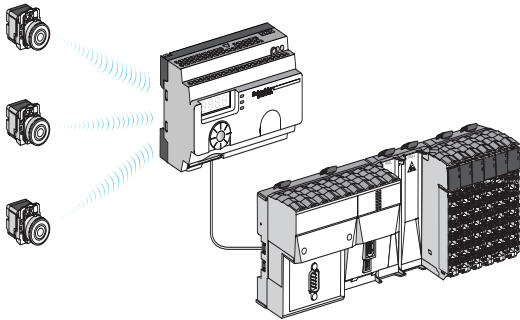

Figure A: radio transmission between 3 transmitters and 1 Access Point

### Introduction

The access point for Harmony™ wireless, batteryless push buttons provides network connectivity by operating as intermediate equipment between the transmitter and the PLC (Programmable Logic Controller). The access point receives radio signals from the transmitters and converts them to communication protocols. Based on the model, it is connected to the PLC using either RS485 Modbus Serial line or Modbus/TCP protocol.

The access point can be used with transmitters such as XB4R and XB5R wireless, batteryless push buttons, rope pull switch, mushroom head push button (1), and all PLCs that support Modbus Serial line over RS485 or Modbus/TCP protocols.

Depending on the application, an external or a relay antenna can be used to improve signal reception. An access point can support up to 60 radio transmitters.

The Access point can be configured:

- through jog dial and 7-segment display (configuration and diagnostic modes),
- through web pages for ZBRN1 (Modbus/TCP communication module),
- through SoMachine™, Unity™ Pro software, or third party FDT container using DTM (Device Type Manager) files (2) (3),
- through SD card and csv files for communication and radio configuration.

The possible distance (4) between a transmitter and an access point is approximately:

- 100 m/328 ft where there are no obstacles,
- 25 m/82 ft if the access point is installed in a metal housing or in a closed metal enclosure,
- 300 m/984 ft if a Repeater is located between the transmitter and the access point (installed in a metal housing or in a closed metal enclosure),
- 60 m/197 ft if an external antenna is connected to the access point.

### Description

#### Standard access point with communication module (see figure B)

The access point ZBRN1 has an empty slot for the ZBRCETH communication module to support Modbus™/TCP protocol. This communication module has 2 standard Ethernet RJ45 connectors that provide connectivity for daisy chain operation and daisy chain loop operation (when used with Schneider Electric ConneXium™ Ethernet switches) and thus avoids the use of an external switch or hub.

- 1 ZBRN1 standard access point (5)
- 2 ZBRN1 instruction sheet
- 3 ZBRCETH Modbus/TCP network communication module
- 4 ZBRCETH instruction sheet

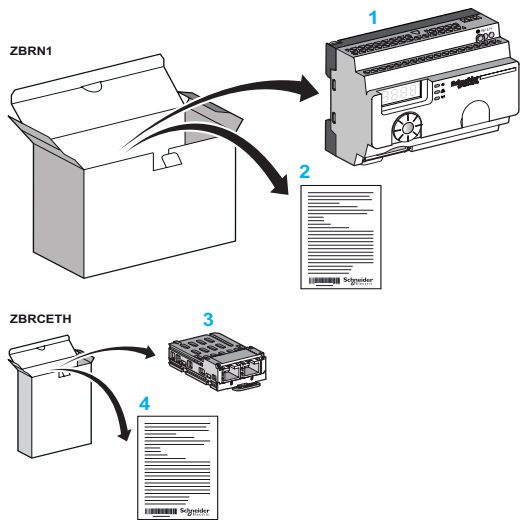

Figure B: standard access point with communication module

(1) Please refer to the References table on page 184 for the compatible list of transmitters.

(2) For more information on SoMachine and Unity Pro software, please refer to our website [www.schneider-electric.com](http://www.schneider-electric.com).

(3) DTM is a software component file that enables the SoMachine or Unity Pro software to communicate with the connected system.

(4) Typical values which can be affected by the application environment.

(5) ZBRN1 must be plugged with a communication module, reference ZBRCETH for Modbus/TCP protocol.

# Harmony™ XB5R plastic/XB4R metal wireless, batteryless 22 mm push buttons

## ZBRN1 and ZBRN2 Access points

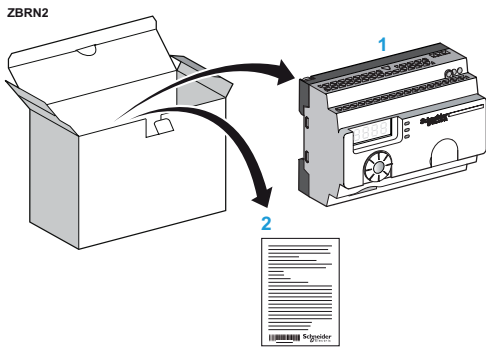

Figure C: access point for Modbus Serial line connection



ZBRN2



ZBRN1



ZBRCETH



ZBRA2

### Description

Access point for Modbus™ serial line protocol (see figure C)

The access point ZBRN2 has 2 embedded RS485 connectors that avoid the use of an external hub for RS485 Serial line connection. The supported baud rates are 1200 bps, 2400 bps, 4800 bps, 9200 bps, 9600 bps, 38,400 bps, and 115,200 bps.

- 1 ZBRN2 access point
- 2 ZBRN2 instruction sheet

### Programmable access points

Description	Data function	Output type	Receiver voltage V	Reference	Weight kg/lb
Programmable access points equipped with: - 7-segment display - jog dial - 8 indicating LEDs (power ON, functions mode, communication status, signal strength) - external antenna connector and protective plug	Momentary (adjustable from 100 ms to 1 s)	2 RS485 connectors that provides connectivity for Modbus RS485 Serial line	~ 24 to 240	<b>ZBRN2</b>	0.270/ 0.595
	Momentary (adjustable from 100 ms to 1 s)	1 slot for communication module ZBRCETH (should be ordered separately)	~ 24 to 240	<b>ZBRN1</b>	0.263/ 0.580

### Communication module

Description	Characteristics	Communication port	Reference	Weight kg/lb
Modbus/TCP network communication module	Modbus/TCP protocol with embedded Web pages in 5 languages for configuration, monitoring and diagnostics	2 RJ45 connectors that provides connectivity for daisy chain and daisy chain loop operation	<b>ZBRCETH</b>	0.044/ 0.097

### Accessories

Product	Application	Description	Reference	Weight kg/lb
External antenna	Connected to the access point (ZBRN1 or ZBRN2) Used to increase the distance of transmission	2 m/6.56 ft cable 1 RF connector	<b>ZBRA2</b>	0.040/ 0.088

**Note:** The ZBRN2 has embedded communication port for Modbus Serial Line, while the ZBRN1 must be plugged with a communication module to support different protocols.



# Harmony™ XB7 Monolithic push buttons



# Harmony™ XB7: Compact, robust, monolithic 22 mm push buttons for your machines

For your control systems that require high-performance, compact, and easy-to-install components...Harmony XB7 push buttons are your ideal solution. The new Emergency Stop push button design allows immediate identification of safety functions and status of contacts.

## > Simple installation, simple integration...

Easy to install and to integrate into your Control Systems

## > Designed for quality and conformity...

Conforms to industry standards and Machinery Directive

## > High performance for industrial applications...

Robust, durable controls for industry and buildings

Make the most of your energy<sup>SM</sup>





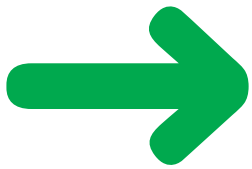

## Simple installation...

The monolithic design of the Harmony™ XB7 makes it **easy to mount** on machines or control panels with only one ring nut.

The 4 top-down terminals enable **easy wiring** with finger protection (IP 20).



**IEC 60529**  
compliant



## Simple integration...

New ergonomic design in 6 colors, plus illuminated functions with **integrated LED**.

**Complete**  
product range



Push buttons ○ ● ● ● ● ● ● ●



Pilot lights ● ● ● ● ● ● ● ●

Long life: a duration of more than **70,000 hours** on pilot lights and **1 million** operations for push buttons.



Illuminated push buttons ● ● ● ● ● ● ● ●



Handle selectors ●



Key selectors ●



Emergency stop push buttons ●

**1 reference** = **1 function**

## Electrical reliability

Contact functions are designed for **load switching** (I/O interface) and resistance to vibrations.

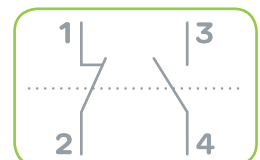



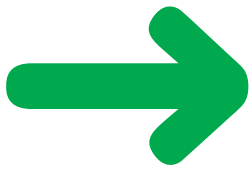

# Designed for quality and conformity...

Harmony™ XB7 “Emergency stop” push buttons comply with EN/IEC and UL standards, EN 13850, EN/IEC 60947-5-5 and are designed for machines and industrial control panels. The emergency stop function consists of:

Red trigger action



Standardized yellow legend

Green mark on body allows contact state visualization



Off



On

**Green**  
mark for contact state



Worldwide availability



Conforming to  
**EN/IEC 60947-5-5**

International certifications:  
**CE, UL, CSA, CCC, GOST**



# High performance for industrial applications...

The Harmony XB7 push button is perfect for industry applications like packaging and other machine processes, and building applications, including: HVAC, electrical distribution, and lighting.

Assembly lines



Packaging machines



HVAC



Buildings

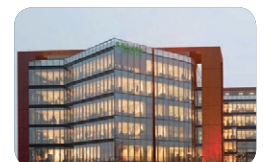

Degree of protection  
**IP 65**

# Harmony™ XB7 plastic 22 mm push buttons

Monolithic push buttons, switches and pilot lights

## Complete products: Contact functions

### Spring return push buttons with/without marking

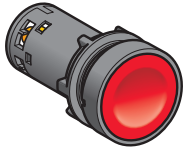

Flush  
XB7 NA●●●●: see page 197

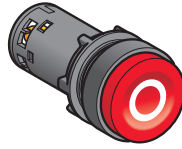

Projecting  
XB7 NL●●●●: see page 197



### Latching push buttons without marking

Flush  
XB7 NH●●: see page 197

### Selector switches and key switches

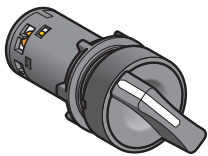

Standard handle, black  
XB7 ND●●: see page 200



Key operated  
XB7 NG●●: see page 200

### Emergency Stop push buttons

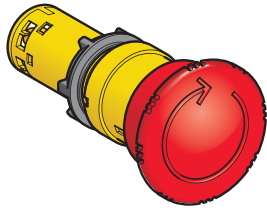

Turn to release/ Push-pull/ Key release  
XB7 NS●●●●/XB7 NT●●●: see page 200

## Complete products: Signalling functions

### Pilot lights



With integral LED  
XB7 EV0●●P: see page 199



### Illuminated push buttons, with projecting push

With integral LED, spring return or latching  
XB7 NW●●●●, XB7 NJ●●●●1: see page 199

## Legend holders, legends, and accessories

See pages 201 and 202

# Harmony™ XB7 plastic 22 mm push buttons

Monolithic push buttons, switches and pilot lights

Environment			
<b>Protective treatment</b>	Standard version		"TH"
<b>Ambient air temperature around the device</b>	For storage	°C	-40 to +70
	For operation	°C	-25 to +70 for integral LED version
<b>Electric shock protection</b>	Conforming to IEC 61140		Class II
<b>Degree of protection</b>	Conforming to IEC 60529		Front face: <input type="checkbox"/> IP 65 for push buttons, illuminated push buttons, pilot lights, selector switches and Emergency Stop push buttons  Rear face: <input type="checkbox"/> IP 20 (protection against direct contact)
	Conforming to UL 50E		<input type="checkbox"/> Suitable for enclosure type 3: push buttons, illuminated push buttons, selector switches, Emergency Stop push buttons <input type="checkbox"/> Suitable for enclosure type 4: pilot lights with integral LED <input type="checkbox"/> Suitable for enclosure type 12: Emergency Stop push buttons, pilot lights with integral LED
<b>Conformity to standards</b>	Generic standards UL, CSA, GOST, CCC and CE		<input type="checkbox"/> EN/IEC 60947-1, EN/IEC 60947-5-1 for push buttons, pilot lights, illuminated push buttons and selector switches <input type="checkbox"/> UL, EN/IEC 60947-1, EN/IEC 60947-5-1, EN/IEC 60947-5-5, EN/IEC 60204-1 and EN/ISO 13850 for Emergency Stop trigger action push buttons <input type="checkbox"/> UL 508, CSA C22 n° 14, CCC, GB 14048.5 for all XB7 range
<b>Terminal referencing</b>	Conforming to EN 50005 and EN 50013		Conforms

General specifications			
<b>Mechanical durability</b> (in operating cycles)			<input type="checkbox"/> Push buttons: 1,000,000 <input type="checkbox"/> Illuminated push buttons, spring return and latch type: 300,000 <input type="checkbox"/> Selector switches and key switches: 300,000 <input type="checkbox"/> Emergency Stop: 100,000
<b>Vibration resistance</b>	Conforming to IEC 60068-2-6		5 gn (frequency 2 to 500 Hz)
<b>Mechanical shock resistance</b>	Conforming to IEC 60068-2-27		Half sine wave acceleration 11 ms: 50 gn Half sine wave acceleration 18 ms: 30 gn Half sine wave acceleration 11 ms: - 15 gn for Emergency Stop push buttons
<b>Mounting</b> Conforming to EN/IEC 60947-5-1	Finished mounting hole	mm	22.5, recommended (22.3 + 0.4/0)
	Mounting center	mm	<input type="checkbox"/> 30 x 40 for all products (except Emergency Stop push buttons) <input type="checkbox"/> 40 x 40 for Emergency Stop push buttons
	Support panel thickness	mm	<input type="checkbox"/> Metal: 1 to 6 <input type="checkbox"/> Plastic: 2 to 6
	Mounting nut: head tightening torque	N•m	<input type="checkbox"/> 2.2 (+/-0.2)
<b>Cablings capacity</b> Conforming to EN/IEC 60947-1	Screw clamp terminal connection	mm <sup>2</sup>	For all types of push buttons and pilot lights: <input type="checkbox"/> min: 1 x 0.34 mm <sup>2</sup> without cable end <input type="checkbox"/> max: 2 x 1.5 mm <sup>2</sup> with cable end or 2 x 2.5 mm <sup>2</sup> without cable end
	Forked "U" type tag connection		2 max., fitted head to tail (for all types of push buttons and pilot lights) Recommended fork width: 6.5 mm (7 mm max.) for M3 screw
	Faston clip connection	mm	Type 6.35 x 0.8 mm (for pilot lights only)
<b>Tightening torque of mounting screws</b>		N•m	<input type="checkbox"/> 0.8 (nominal recommended) <input type="checkbox"/> 1.2 (max.)  Screw heads compatible with Pozidriv, Phillips or JIS screwdrivers (size 1) and flat tipped screwdrivers (4 and 5.5 mm)

# Harmony™ XB7 plastic 22 mm push buttons

Monolithic push buttons, switches and pilot lights

Contact function specifications			
Type of contact	N/C, N/O or N/C+N/O		<input type="checkbox"/> Slow break <input type="checkbox"/> Snap action for Emergency Stop push buttons
Positive operation	Conforming to EN/IEC 60947-5-1 Appendix K		All functions incorporating a N/C contact are positive opening operation
Short-circuit protection	Conforming to EN/IEC 60947-5-1	A	4 (using gG cartridge fuse conforming to IEC 269-1)
Rated insulation voltage	Conforming to EN/IEC 60947-1	V	Ui = 250 (degree of pollution 3)
Rated impulse withstand voltage	Conforming to EN/IEC 60947-1	kV	Uimp = 6
Rated operational specifications conforming to EN/IEC 60947-5-1	a.c. supply: utilization category AC14, D300		Ue = 240 V and Ie = 0.3 A or Ue = 120 V and Ie = 0.6 A
	AC15, C300		Ue = 120 V and Ie = 1.5 A or Ue = 240 V and Ie = 0.75 A (Emergency Stop only)
	DC13, R300		Ue = 250 V and Ie = 0.1 A or Ue = 125 V and Ie = 0.22 A
Electrical reliability at 17 V and 5 mA	Failure rate in accordance with EN/IEC 60947-5-4		<input type="checkbox"/> $\lambda \leq 10^{-6}$ <input type="checkbox"/> $\lambda \leq 5 \times 10^{-7}$ (Emergency Stop only)

Light function specifications					
Type of signaling units			Illuminated push buttons		Pilot lights
Integral LED					
Current consumption	For all colors	$\overline{\sim}$ / $\sim$ 24 V	mA	18 (27 max.)	20 (27 max.)
		$\sim$ 120 V	mA	12 (17 max.)	18 (21 max.)
		$\sim$ 230 V	mA	22 (27 max.)	16 (20 max.)
Voltage limits	At nominal voltage	$\overline{\sim}$ 24 V	V	19.2 to 30	
		$\sim$ 24 V	V	21.6 to 26.4	
		$\sim$ 120 V	V	100 to 132	
		$\sim$ 230–240 V	V	195 to 264	
Service life	At nominal voltage and at an ambient temperature of 25 °C		Hr	70,000	
Overvoltage withstand	Level of protection	$\sim$ 120 V	VA	100	
		$\sim$ 230 V	VA	200	
Resistance to electrostatic discharges	Conforming to IEC 61000-4-2		kV	6: on contact, on metal parts 8: in free air, in insulating parts	
Resistance to electromagnetic fields	Conforming to IEC 61000-4-3		V/m	10	
Resistance to fast transients	Conforming to IEC 61000-4-4		KV	2	
Surge withstand	Conforming to IEC 61000-4-5		KV	1	
Immunity to conducted disturbances	Conforming to IEC 61000-4-6		V	10	
Brightness	At nominal voltage and for all colors		Lux	> 200	

# Harmony™ XB7 plastic 22 mm push buttons

Monolithic push buttons, switches and pilot lights



XB7NA31



XB7NL4









XB7NH2

Push buttons									
Shape of head	Type of push	Type of contact		Marking		Color of push	Sold in lots of	Unit reference	Weight
		N/O	N/C	Text	Color				
<b>Spring return push button without marking</b>									
	Flush	1	–	–	–	White	10	XB7NA11	0.021
		1	–	–	–	Black	10	XB7NA21	0.021
		1	–	–	–	Green	10	XB7NA31	0.021
		1	–	–	–	Yellow	10	XB7NA81	0.021
		1	1	–	–	White	10	XB7NA15	0.021
		1	1	–	–	Black	10	XB7NA25	0.021
		1	1	–	–	Green	10	XB7NA35	0.021
		1	1	–	–	Red	10	XB7NA45	0.021
		1	1	–	–	Blue	10	XB7NA65	0.021
		1	1	–	–	Yellow	10	XB7NA85	0.021
		–	1	–	–	Red	10	XB7NA42	0.021
		2	–	–	–	Black	10	XB7NA23	0.021
		2	–	–	–	Green	10	XB7NA33	0.021
–	2	–	–	Red	10	XB7NA44	0.021		
	Projecting	–	1	–	–	Red	10	XB7NL42	0.021
		1	1	–	–	Red	10	XB7NL45	0.021
		–	2	–	–	Red	10	XB7NL44	0.021
<b>Latch type push button without marking</b>									
	Flush	1	–	–	–	Black	10	XB7NH21	0.021
		1	–	–	–	Green	10	XB7NH31	0.021
		1	1	–	–	Black	10	XB7NH25	0.021
		1	1	–	–	Green	10	XB7NH35	0.021
		1	–	–	–	Yellow	10	XB7NH81	0.021

# Harmony™ XB7 plastic 22 mm push buttons

Monolithic push buttons, switches and pilot lights

Push buttons (continued)											
Shape of head	Type of push	Type of contact		Marking		Color of push	Sold in lots of	Unit reference	Weight		
		N/O	N/C	Text	Color						
<b>Spring return push button with marking</b>											
	Flush		1	–	I	White	Green	10	<b>XB7NA3131</b>	0.021	
			1	–	II	White	Green	10	<b>XB7NA3136</b>	0.021	
			1	–	START	White	Green	10	<b>XB7NA3133</b>	0.021	
			1	–	↓	Black	White	10	<b>XB7NA11343</b>	0.021	
			1	–	↑	Black	White	10	<b>XB7NA11341</b>	0.021	
			1	–	↓	White	Black	10	<b>XB7NA21343</b>	0.021	
			1	–	↑	White	Black	10	<b>XB7NA21341</b>	0.021	
		Projecting		–	1	O	White	Red	10	<b>XB7NA4232</b>	0.021
				–	1	STOP	White	Red	10	<b>XB7NA4234</b>	0.021
				2	–	I	White	Green	10	<b>XB7NA3331</b>	0.021
				2	–	II	White	Green	10	<b>XB7NA3336</b>	0.021
				2	–	START	White	Green	10	<b>XB7NA3333</b>	0.021
				1	1	O	White	Red	10	<b>XB7NA4532</b>	0.021
				1	1	STOP	White	Red	10	<b>XB7NA4534</b>	0.021
				1	1	↓	Black	White	10	<b>XB7NA15343</b>	0.021
				1	1	↑	Black	White	10	<b>XB7NA15341</b>	0.021
				1	1	↓	White	Black	10	<b>XB7NA25343</b>	0.021
1	1	↑	White	Black	10	<b>XB7NA25341</b>	0.021				
	Projecting		–	1	O	White	Red	10	<b>XB7NL4232</b>	0.021	
			–	1	STOP	White	Red	10	<b>XB7NL4234</b>	0.021	
			1	1	O	White	Red	10	<b>XB7NL4532</b>	0.021	
			1	1	STOP	White	Red	10	<b>XB7NL4534</b>	0.021	

# Harmony™ XB7 plastic 22 mm push buttons

## Monolithic push buttons, switches and pilot lights



XB7NW33•1

Illuminated push buttons, projecting push							
with integral LED							
Shape of head	Type of push and contacts	Color of lens	Sold in lots of	Unit reference by supply voltage (1)			Weight kg
				~ / ∴ 24 V	~ 120 V	~ 230 V	
○	Spring return push with N/O or N/C contacts (1)	Green	10	XB7NW33B1	XB7NW33G1	XB7NW33M1	0.023
		Red	10	XB7NW34B1	XB7NW34G1	XB7NW34M1	0.023
			10	XB7NW34B2	XB7NW34G2	XB7NW34M2	0.023
		Orange	10	XB7NW35B1	XB7NW35G1	XB7NW35M1	0.023
		Blue	10	XB7NW36B1	XB7NW36G1	XB7NW36M1	0.023
		Clear	10	XB7NW37B1	XB7NW37G1	XB7NW37M1	0.023
		Yellow	10	XB7NW38B1	XB7NW38G1	XB7NW38M1	0.023
	Latch push	Green	10	XB7NJ03B1	XB7NJ03G1	XB7NJ03M1	0.023
		Red	10	XB7NJ04B1	XB7NJ04G1	XB7NJ04M1	0.023
			10	XB7NJ04B2	XB7NJ04G2	XB7NJ04M2	0.023
		Orange	10	XB7NJ05B1	XB7NJ05G1	XB7NJ05M1	0.023
		Blue	10	XB7NJ06B1	XB7NJ06G1	XB7NJ06M1	0.023
		Clear	10	XB7NJ07B1	XB7NJ07G1	XB7NJ07M1	0.023
		Yellow	10	XB7NJ08B1	XB7NJ08G1	XB7NJ08M1	0.023



XB7EV08•P

Pilot lights							
with integral LED							
Shape of head	Type of light source (included)	Color of lens	Sold in lots of	Unit reference by supply voltage (2)			Weight kg
				~ / ∴ 24 V	~ 120 V	~ 230 V	
○	Integral LED	Green	10	XB7EV03BP	XB7EV03GP	XB7EV03MP	0.020
		Red	10	XB7EV04BP	XB7EV04GP	XB7EV04MP	0.020
		Yellow	10	XB7EV05BP	XB7EV05GP	XB7EV05MP	0.020
		Blue	10	XB7EV06BP	XB7EV06GP	XB7EV06MP	0.020
		Clear	10	XB7EV07BP	XB7EV07GP	XB7EV07MP	0.020
		Orange	10	XB7EV08BP	XB7EV08GP	XB7EV08MP	0.020



(1) All product references ending with "1" correspond to products with N/O contacts (Example: XB7NW34B1). All product references ending with "2" correspond to products with N/C contacts (Example: XB7NW34B2).

(2) For Faston® connection version (1 x 6.35 mm and 2 x 2.8 mm), add the number "3" to the end of the reference. Example: XB7EV07BP becomes XB7EV07BP3.





# Harmony™ XB7 plastic 22 mm push buttons

Monolithic push buttons, switches and pilot lights

Selector switches and key switches								
Shape of head	Type of operator	Type of contact		Number and type of positions (1)	Sold in lots of	Unit reference	Weight	kg
		NO	NC					
	Standard handle, black	1	–	2, stay put	✓	<b>XB7ND21</b>	0.026	
		1	1	2, stay put	✓	<b>XB7ND25</b>	0.026	
		2	–	3, stay put	✓	<b>XB7ND33</b>	0.026	
	Key (key n° 455)	1	–	2, key withdrawal in LH position	✓	<b>XB7NG21</b>	0.050	
		2	–	3, key withdrawal in center position	✓	<b>XB7NG33</b>	0.050	

Ø 40 mm Emergency stop trigger action and mechanically latching push buttons									
Shape of head	Type of push	Standards	Type of contact		Color of push	Sold in lots of	Unit reference	Weight	kg
			NO	NC					
	Turn to release	EN/IEC 60204-1, EN/ISO 13850, EN/IEC 60947-5-5, Machinery directive 2006/42/EC and UL	–	1	Red	10	<b>XB7NS8442</b>	0.045	
			1	1	Red	10	<b>XB7NS8445</b>	0.045	
			–	2	Red	10	<b>XB7NS8444</b>	0.045	
	Push-pull	EN/IEC 60204-1, EN/ISO 13850, EN/IEC 60947-5-5, Machinery directive 2006/42/EC and UL	–	1	Red	10	<b>XB7NT842</b>	0.040	
			1	1	Red	10	<b>XB7NT845</b>	0.040	
			–	2	Red	10	<b>XB7NT844</b>	0.040	
	Key release (n° 455)	EN/IEC 60204-1, EN/ISO 13850, EN/IEC 60947-5-5, Machinery directive 2006/42/EC and UL	–	2	Red	10	<b>XB7NS9444</b>	0.072	
			–	1	Red	10	<b>XB7NS9445</b>	0.072	

(1) The symbol "⌘" indicates key withdrawal position.

# Harmony™ XB7 plastic 22 mm push buttons

Monolithic push buttons, switches and pilot lights



ZBY 2101

### Standard (30 x 40 mm) legend holders for 8 x 27 mm legends

Text	Sold in lots of	Unit reference	Weight kg
Without legend	10	ZBZ32	0.001

### Legend holder, 30 x 40 mm with legend (black or red background)

#### with blank legend

Text	Sold in lots of	Unit reference	Weight kg
Without	10	ZBY2101	0.001

#### with marked legend (sold singly)

Start functions: White characters on black background.  
Stop functions: White characters on red background.

Text	Unit reference	Weight kg	Text	Unit reference	Weight kg
Auto	ZBY2115	0.001	Reset	ZBY2323	0.001
Down	ZBY2308	0.001	Reverse	ZBY2306	0.001
Forward	ZBY2305	0.001	Right	ZBY2309	0.001
Hand	ZBY2316	0.001	Start	ZBY2303	0.001
Inch	ZBY2321	0.001	Stop	ZBY2304	0.001
Left	ZBY2310	0.001	Up	ZBY2307	0.001
Off	ZBY2312	0.001	O	ZBY2146	0.001
On	ZBY2311	0.001	I	ZBY2147	0.001
Power on	ZBY2326	0.001	O-I	ZBY2178	0.001

### Standard (30 x 50 mm) legend holders for 18 x 27 mm legends

Text	Sold in lots of	Unit reference	Weight kg
Without legend	10	ZBZ 3	0.001



ZBY9330

### Circular legends, yellow, for mushroom head push buttons

#### used for "Emergency stop" function (1)

Conforming to standards	Diameter mm	Marking on yellow background	Unit reference	Weight kg
EN/IEC 60204-1 and EN/ISO 13850 (1)	60	–	ZBY9140	0.004
	90	EMERGENCY STOP	ZBY9330	0.004
	90	–	ZBY8140	0.008
		EMERGENCY STOP	ZBY8330	0.008



ZBY9360

#### used for "Emergency switching off" function

Conforming to standard	Diameter mm	Marking on yellow background	Unit reference	Weight kg
EN/IEC 60204-1	60	–	ZBY9101	0.004
	90	EMERGENCY SWITCHING OFF	ZBY9360	0.004
	90	–	ZBY8101	0.008
		EMERGENCY SWITCHING OFF	ZBY8360	0.008

### Nameplates, 30 x 40 mm, blank

Text color	Background color	Unit reference
White	Black	ZBY42101
White	Red	ZBY44101
Black	Yellow	ZBY41101
Black	White	ZBY45101

### Nameplates, 30 x 50 mm, blank

Text color	Background color	Unit reference
White	Black	ZBY62101
White	Red	ZBY64101
Black	Yellow	ZBY61101
Black	White	ZBY65101



ZBY42101



ZBY62101

(1) For complying with ISO 13850:2006 standard, paragraph 4.4.6., Emergency Stop function logo (V) has been added.

# Harmony™ XB7 plastic 22 mm push buttons

Monolithic push buttons, switches and pilot lights

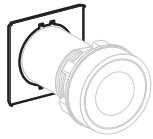

ZB5AZ902



ZB5AZ901

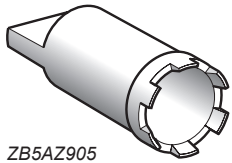

ZB5AZ905



ZB5SZ3

## Accessories

Description	Color	Sold in lots of	Unit reference	Weight kg
Anti-rotation plate	–	10	ZB5AZ902	0.008
Mounting nut	–	10	ZB5AZ901	0.002
Mounting nut tightening tool	–	1	ZB5AZ905	0.016
Plastic circular blanking plug (with mounting nut)	Black	10	ZB5SZ3	0.009

# Harmony™ XB7 plastic 22 mm push buttons

Monolithic push buttons, switches and pilot lights

## Dimensions

### Push buttons, flush type

**XB7NA●●●●, XB7NH●●**

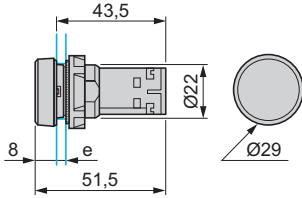

### Push buttons, projecting type

**XB7NL●●●●**

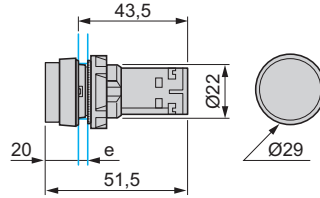

e : support panel thickness: 1 to 6 mm (metal), 2 to 6 mm (plastic).

### Selector switches, standard handle

**XB7ND●●**

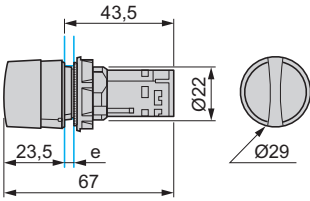

### Key switches

**XB7NG●●**

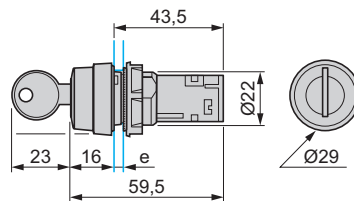

e : support panel thickness: 1 to 6 mm (metal), 2 to 6 mm (plastic).

### Emergency Stop push buttons (Turn to release)

**XB7NS84●●**

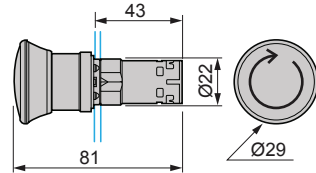

### Emergency Stop push buttons (Push-pull)

**XB7NT84●**

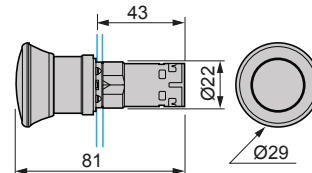

### Emergency Stop push buttons with key

**XB7NS94●●**

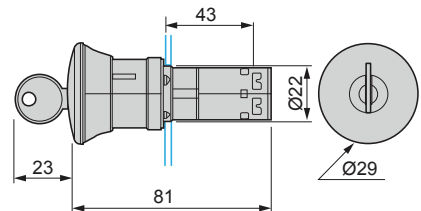

e : support panel thickness: 1 to 6 mm (metal), 2 to 6 mm (plastic).

## Dimensions (continued)

Pilot lights with screw terminal  
XB7EV●●●P

Pilot lights with Faston® terminal  
XB7EV●●●P3

Illuminated push buttons  
XB7NW●●●●, XB7NJ●●●●

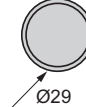
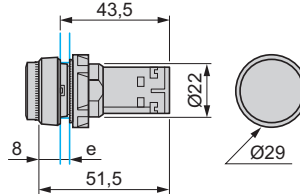
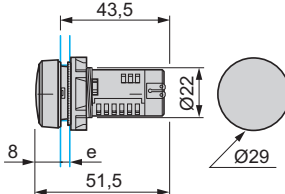
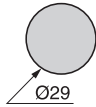
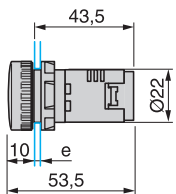

e : support panel thickness: 1 to 6 mm (metal), 2 to 6 mm (plastic).

## Faston clip connection (for pilot lights only)

## "U" type tag connection

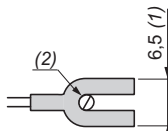
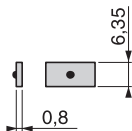

(1) 6.5 recommended, 7 mm max.  
(2) M3 screw clamp terminal.

## Mounting

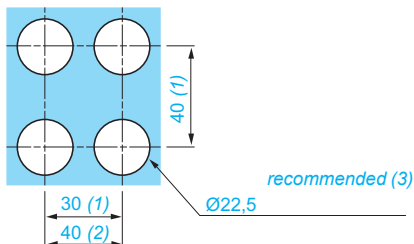

### Diameter of finished mounting holes



(1) Minimum value.  
(2) 40 mm for Emergency Stop push buttons only.  
(3) Standard value: Ø 22.3 (0; + 0.4).



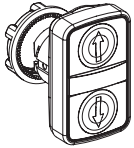
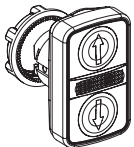

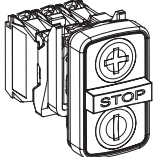
# Multiple head, spring return push button substitution table

Product type	Old version	New version IP66 only	Notes	
<b>Plastic head Double-headed push button</b>  	ZB5 AA8112	ZB5 AA7120		
	ZB5 AA8212	ZB5 AA7121		
	ZB5 AA8134	ZB5 AA7340		
	ZB5 AA8234	ZB5 AA7341		
	ZB5 AL8334	ZB5 AL7340		
	ZB5 AL8434	ZB5 AL7341		
	ZB5 AL8312		equivalent: ZB5AL7340 or ZB5AA7120	
	ZB5 AL8412		equivalent: ZB5AL7341 or ZB5AA7121	
		ZB5 AA79	new function	
	ZB5 AA9112	ZB5 AA7120		
	ZB5 AA9212	ZB5 AA7121		
	ZB5 AA9134	ZB5 AA7340		
	ZB5 AA9234	ZB5 AA7341		
	ZB5 AL9334	ZB5 AL7340		
	ZB5 AL9434	ZB5 AL7341		
	ZB5 AL9312		equivalent: ZB5AL7340 or ZB5AA7120	
	ZB5 AL9412		equivalent: ZB5AL7341 or ZB5AA7121	
		ZB5 AA79	new function	
	<b>Plastic head Double-headed push button + central pilot light</b>  	ZB5 AW811723	ZB5 AW7A1720	
		ZB5 AW821723	ZB5 AW7A1721	
ZB5 AW813743		ZB5 AW7A3740		
ZB5 AW823743		ZB5 AW7A3741		
ZB5 AW812743			equivalent: ZB5AW7A3740	
ZB5 AW822743			equivalent: ZBAW77A3741	
ZB5 AW833743		ZB5 AW7L3740		
ZB5 AW843743		ZB5 AW7L3741		
ZB5 AW831723			equivalent: ZB5AW7L3740 or ZB5AW7A1720	
ZB5 AW841723			equivalent: ZB5AW7L3741 or ZB5AW7A1721	
ZB5 AW832743			equivalent: ZB5AW7L3740	
ZB5 AW842743			equivalent: ZB5AW7L3741	
		ZB5 AW7A1724	new function	
		ZB5 AW7A1715	new function	
		ZB5 AW7A9	new function	
<b>Plastic head Triple-headed push button</b>  		ZB5 AA73132	new function	
		ZB5 AA73133	new function	
		ZB5 AA73134	new function	
		ZB5 AA73135	new function	
		ZB5 AA71115	new function	
		ZB5 AA71123	new function	
		ZB5 AA71124	new function	
		ZB5 AA72124	new function	
		ZB5 AA791	new function	
	<b>Complete plastic bezel product</b>  	XB5 AL845	XB5 AL73415	
		XB5 AA731327	new function	
		XB5 AA711237	new function	
XB5 AW84B5		XB5 AW73731B5		
XB5 AW84G5		XB5 AW73731G5		
XB5 AW84M5		XB5 AW73731M5		
XB5 AL945		XB5 AL73415		

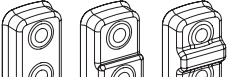

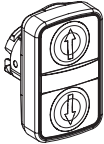
Product type	Old version	New version	Notes
<b>Silicone boot</b> 	ZBW008	ZBA710	
	ZBW008F	ZBA708	
		ZBA709	new function

Product type	Old version	New version IP66 only	Notes
<b>Metal head Double-headed push button</b>  	ZB4 BA8112	ZB4 BA7120	
	ZB4 BA8212	ZB4 BA7121	
	ZB4 BA8134	ZB4 BA7340	
	ZB4 BA8234	ZB4 BA7341	
	ZB4 BL8334	ZB4 BL7340	
	ZB4 BL8434	ZB4 BL7341	
	ZB4 BL8312		equivalent: ZB4BL7340 or ZB4BA7120
	ZB4 BL8412		equivalent: ZB4BL7341 or ZB4BA7121
		ZB4 BA79	new function
	ZB4 BA9112	ZB4 BA7120	
	ZB4 BA9212	ZB4 BA7121	
	ZB4 BA9134	ZB4 BA7340	
	ZB4 BA9234	ZB4 BA7341	
	ZB4 BL9334	ZB4 BL7340	
	ZB4 BL9434	ZB4 BL7341	
	ZB4 BL9312		equivalent: ZB4BL7340 or ZB4BA7120
	ZB4 BL9412		equivalent: ZB4BL7341 or ZB4BA7121
		ZB4 BA79	new function

<b>Metal head Double-headed push button + central pilot light</b>  	ZB4 BW811723	ZB4 BW7A1720	
	ZB4 BW821723	ZB4 BW7A1721	
	ZB4 BW813743	ZB4 BW7A3740	
	ZB4 BW823743	ZB4 BW7A3741	
	ZB4 BW812743		equivalent: ZB4BW7A3740
	ZB4 BW822743		equivalent: ZB4BW7A3741
	ZB4 BW833743	ZB4 BW7L3740	
	ZB4 BW843743	ZB4 BW7L3741	
	ZB4 BW831723		equivalent: ZB4 BW7L3740 or ZB4 BW7A1720
	ZB4 BW841723		equivalent: ZB4 BW7L3741 or ZB4 BW7A1721
	ZB4 BW832743		equivalent: ZB4BW7L3740
	ZB4 BW842743		equivalent: ZB4 BW7L3741
		ZB4 BW7A1724	new function
	ZB4 BW7A1715	new function	
	ZB4 BW7A9	new function	

<b>Metal head Triple-headed push button</b>  		ZB4 BA73132	new function
		ZB4 BA73133	new function
		ZB4 BA73134	new function
		ZB4 BA73135	new function
		ZB4 BA71115	new function
		ZB4 BA71123	new function
		ZB4 BA71124	new function
		ZB4 BA72124	new function
		ZB4 BA791	new function

<b>Complete metal bezel product</b>  	XB4 BL845	XB4 BL73415	
		XB4 BA731327	new function
		XB4 BA711237	new function
	XB4 BW84B5	XB4 BW73731B5	
	XB4 BW84G5	XB4 BW73731G5	
	XB4 BW84M5	XB4 BW73731M5	
	XB4 BL945	XB4 BL73415	

<b>AF1</b>							
AF1VB510	69, 145	XB4BK124B5	42	XB4BW3435	31	XB5AK135B5	116
AF1XA1	69, 145	XB4BK124G5	42	XB4BW3445	31	XB5AK135G5	116
<b>APE</b>		XB4BK124M5	42	XB4BW3465	31	XB5AK135M5	116
APE1C2150	53, 127	XB4BK125B5	42	XB4BW34G5	29	XB5AL42	100
APE1C2250	53, 127	XB4BK125G5	42	XB4BW34M5	29	XB5AL4322	102
APE1PRE21	53, 127	XB4BK125M5	42	XB4BW3535	31	XB5AL73415	106
<b>DL1</b>		XB4BK133B5	42	XB4BW3545	31	XB5AL84101	120
DL1CB006	70, 146	XB4BK133G5	42	XB4BW3565	31	XB5AL84201	120
DL1CD0061	70, 146	XB4BK133M5	42	XB4BW35B5	29	XB5AP21	101
DL1CD0063	70, 146	XB4BK134B5	42	XB4BW35G5	29	XB5AP31	101
DL1CD0064	70, 146	XB4BK134G5	42	XB4BW35M5	29	XB5AP42	101
DL1CD0065	70, 146	XB4BK134M5	42	XB4BW36B5	29	XB5AP51	101
DL1CD0066	70, 146	XB4BK135B5	42	XB4BW36G5	29	XB5AP61	101
DL1CE024	70, 146	XB4BK135G5	42	XB4BW36M5	29	XB5AS142	111
DL1CE130	70, 146	XB4BK135M5	42	XB4BW73731B5	32	XB5AS542	111
DL1CF110	70, 146	XB4BL42	26	XB4BW73731G5	32	XB5AS8444	110
DL1CF220	70, 146	XB4BL4322	28	XB4BW73731M5	32	XB5AS8445	110
DL1CJ0241	70, 146	XB4BL73415	32	XB4RFA02	183	XB5AS9445	110
DL1CJ0243	70, 146	XB4BP21	27	XB4RFB01	183	XB5AT42	111
DL1CJ0244	70, 146	XB4BP31	27	<b>XB5</b>		XB5AT845	110
DL1CJ0245	70, 146	XB4BP42	27	XB5AA11	98	XB5AV31	119
DL1CJ0246	70, 146	XB4BP51	27	XB5AA21	98	XB5AV33	119
DL1CJ0247	70, 146	XB4BP61	27	XB5AA31	98	XB5AV34	119
DL1CJ0483	70, 146	XB4BS142	37	XB5AA3311	102	XB5AV35	119
DL1CJ0484	70, 146	XB4BS542	37	XB5AA3341	102	XB5AV41	119
DL1CJ0485	70, 146	XB4BS8444	36	XB5AA3351	102	XB5AV43	119
<b>DX1</b>		XB4BS84441	36	XB5AA42	98	XB5AV44	119
DX1AP52	69, 145	XB4BS8445	36	XB5AA4322	102	XB5AV45	119
<b>XAL</b>		XB4BS9445	36	XB5AA51	98	XB5AV5B1	119
XALD01	185	XB4BT42	37	XB5AA61	98	XB5AV5B3	119
XALD02	185	XB4BT845	36	XB5AA711237	107	XB5AV5B4	119
<b>XB4</b>		XB4BV31	45	XB5AA731327	107	XB5AV5B5	119
XB4BA11	26	XB4BV33	45	XB5AA801	120	XB5AV5B6	119
XB4BA21	26	XB4BV34	45	XB5AA802	120	XB5AV61	119
XB4BA31	26	XB4BV35	45	XB5AA831	120	XB5AV63	119
XB4BA3311	28	XB4BV41	45	XB5AA832	120	XB5AV64	119
XB4BA3341	28	XB4BV43	45	XB5AA841	120	XB5AV65	119
XB4BA3351	28	XB4BV44	45	XB5AA84101	120	XB5AVB1	118
XB4BA42	26	XB4BV45	45	XB5AA842	120	XB5AVB3	118
XB4BA4322	28	XB4BV5B1	45	XB5AA84201	120	XB5AVB4	118
XB4BA51	26	XB4BV5B3	45	XB5AA861	120	XB5AVB5	118
XB4BA61	26	XB4BV5B4	45	XB5AA86102	120	XB5AVB6	118
XB4BA711237	33	XB4BV5B5	45	XB5AA862	120	XB5AVG1	118
XB4BA731327	33	XB4BV5B6	45	XB5AA86202	120	XB5AVG3	118
XB4BA821	46	XB4BV61	45	XB5AC21	108	XB5AVG4	118
XB4BA822	46	XB4BV63	45	XB5AD21	113	XB5AVG5	118
XB4BA841	46	XB4BV64	45	XB5AD25	113	XB5AVG6	118
XB4BA842	46	XB4BV65	45	XB5AD33	113	XB5AVM1	118
XB4BA861	46	XB4VB1	44	XB5AD41	113	XB5AVM3	118
XB4BA862	46	XB4VB3	44	XB5AD53	113	XB5AVM4	118
XB4BA921	46	XB4VB4	44	XB5AG03	114	XB5AVM5	118
XB4BA922	46	XB4VB5	44	XB5AG21	114	XB5AVM6	118
XB4BA941	46	XB4VB6	44	XB5AG33	114	XB5AW3135	105
XB4BA942	46	XB4VG1	44	XB5AG41	114	XB5AW3145	105
XB4BA961	46	XB4VG3	44	XB5AG61	114	XB5AW3165	105
XB4BA962	46	XB4VG4	44	XB5AJ21	113	XB5AW31B5	103
XB4BC21	34	XB4VG5	44	XB5AJ33	113	XB5AW31G5	103
XB4BD21	38	XB4VG6	44	XB5AJ53	113	XB5AW31M5	103
XB4BD25	38	XB4BVM1	44	XB5AK123B5	116	XB5AW3335	105
XB4BD33	38	XB4BVM3	44	XB5AK123G5	116	XB5AW3345	105
XB4BD41	38	XB4BVM4	44	XB5AK123M5	116	XB5AW3365	105
XB4BD53	38	XB4BVM5	44	XB5AK124B5	116	XB5AW33B5	103
XB4BG03	40	XB4BVM6	44	XB5AK124G5	116	XB5AW33G5	103
XB4BG21	40	XB4BW3135	31	XB5AK124M5	116	XB5AW33M5	103
XB4BG33	40	XB4BW3145	31	XB5AK125B5	116	XB5AW3435	105
XB4BG41	40	XB4BW3165	31	XB5AK125G5	116	XB5AW3445	105
XB4BG61	40	XB4BW31B5	29	XB5AK125M5	116	XB5AW3465	105
XB4BJ21	39	XB4BW31M5	29	XB5AK133B5	116	XB5AW34B5	103
XB4BJ33	39	XB4BW3335	31	XB5AK133G5	116	XB5AW34G5	103
XB4BJ53	39	XB4BW3345	31	XB5AK133M5	116	XB5AW34M5	103
XB4BK123B5	42	XB4BW3365	31	XB5AK134B5	116	XB5AW3535	105
XB4BK123G5	42	XB4BW33G5	29	XB5AK134G5	116	XB5AW3545	105
XB4BK123M5	42	XB4BW33M5	29	XB5AK134M5	116	XB5AW3565	105
						XB5AW35B5	103
						XB5AW35G5	103
						XB5AW35M5	103
						XB5AW36B5	103
						XB5AW36G5	103
						XB5AW36M5	103
						XB5AW73731B5	106
						XB5AW73731G5	106
						XB5AW73731M5	106
						XB5DSB	46, 120
						XB5DSG	46, 120
						XB5DSM	46, 120
						XB5DT1S	46, 120
						XB5KSB	46, 120
						XB5KSG	46, 120
						XB5KSM	46, 120
						XB5KSM	120
						XB5RFA02	183
						XB5RFB01	183
						XB5RMA04	183
						XB5RMB03	183
						XB5S1B2L2	167
						XB5S1B2M12	167
						XB5S2B2L2	167
						XB5S2B2M12	167
						XB5S3B2L2	167
						XB5S3B2M12	167
						XB5S4B2L2	167
						XB5S4B2M12	167
						XB5S5B2L2	167
						XB5SFFUSBEXT	167
						<b>XB7</b>	
						XB7EV03BP	199
						XB7EV03GP	199
						XB7EV03MP	199
						XB7EV04BP	199
						XB7EV04GP	199
						XB7EV04MP	199
						XB7EV05BP	199
						XB7EV05GP	199
						XB7EV05MP	199
						XB7EV06BP	199
						XB7EV06GP	199
						XB7EV06MP	199
						XB7EV07BP	199
						XB7EV07GP	199
						XB7EV07MP	199
						XB7EV08BP	199
						XB7EV08GP	199
						XB7EV08MP	199
						XB7NA11	197
						XB7NA11341	198
						XB7NA11343	198
						XB7NA15	197
						XB7NA15341	198
						XB7NA15343	198
						XB7NA21	197
						XB7NA21341	198
						XB7NA21343	198
						XB7NA23	197
						XB7NA25	197
						XB7NA25341	198
						XB7NA25343	198
						XB7NA31	197
						XB7NA3131	198
						XB7NA3133	198
						XB7NA3136	198
						XB7NA33	197
						XB7NA3331	198
						XB7NA3333	198
						XB7NA3336	198
						XB7NA35	197
						XB7NA42	197

XB7NA4232	198	XB7NW38B1	199	ZB4BA73134	33	ZB4BJ397	39	ZB4BP583	27
XB7NA4234	198	XB7NW38G1	199	ZB4BA73135	33	ZB4BJ4	39	ZB4BP5S	27
XB7NA44	197	XB7NW38M1	199	ZB4BA7340	32	ZB4BJ491	39	ZB4BP6	27
XB7NA45	197	<b>XBF</b>		ZB4BA7341	32	ZB4BJ5	39	ZB4BP68	27
XB7NA4532	198	XBFX13	70, 146	ZB4BA79	32	ZB4BJ593	39	ZB4BP683	27
XB7NA4534	198	<b>XD4</b>		ZB4BA791	33	ZB4BJ7	39	ZB4BP6S	27
XB7NA65	197	XD4PA12	47	ZB4BA8	26	ZB4BJ792	39	ZB4BPA1	27
XB7NA81	197	XD4PA14	47	ZB4BA9	26	ZB4BJ793	39	ZB4BPA2	27
XB7NA85	197	XD4PA22	47	ZB4BB2	47	ZB4BJ796	39	ZB4BPA3	27
XB7ND21	200	XD4PA24	47	ZB4BB4	47	ZB4BJ8	39	ZB4BPA4	27
XB7ND25	200	<b>XD5</b>		ZB4BC2	34	ZB4BJ891	39	ZB4BPA5	27
XB7ND33	200	XD5PA12	121	ZB4BC24	34	ZB4BJ893	39	ZB4BPA6	27
XB7NG21	200	XD5PA14	121	ZB4BC3	34	ZB4BJ895	39	ZB4BR2	34
XB7NG33	200	XD5PA22	121	ZB4BC34	34	ZB4BK1213	43	ZB4BR216	34
XB7NH21	197	XD5PA24	121	ZB4BC4	34	ZB4BK1233	43	ZB4BR3	34
XB7NH25	197	<b>ZB2</b>		ZB4BC44	34	ZB4BK1243	43	ZB4BR316	34
XB7NH31	197	ZB2BP012	61, 136	ZB4BC5	34	ZB4BK1253	43	ZB4BR4	34
XB7NH35	197	ZB2BP013	61, 136	ZB4BC54	34	ZB4BK1263	43	ZB4BR416	34
XB7NH81	197	ZB2BP014	61, 136	ZB4BC6	34	ZB4BK1313	43	ZB4BR5	34
XB7NJ03B1	199	ZB2BP015	61, 136	ZB4BC64	34	ZB4BK1333	43	ZB4BR516	34
XB7NJ03G1	199	ZB2BP016	61, 136	ZB4BD2	38	ZB4BK1343	43	ZB4BR6	34
XB7NJ03M1	199	<b>ZB4</b>		ZB4BD28	41	ZB4BK1353	43	ZB4BR616	34
XB7NJ04B1	199	ZB4BA0	26	ZB4BD29	41	ZB4BK1363	43	ZB4BS12	35
XB7NJ04B2	199	ZB4BA1	26	ZB4BD3	38	ZB4BK1413	43	ZB4BS14	37
XB7NJ04G1	199	ZB4BA131	28	ZB4BD39	41	ZB4BK1433	43	ZB4BS22	35
XB7NJ04G2	199	ZB4BA133	28	ZB4BD4	38	ZB4BK1443	43	ZB4BS24	37
XB7NJ04M1	199	ZB4BA136	28	ZB4BD48	41	ZB4BK1453	43	ZB4BS42	35
XB7NJ04M2	199	ZB4BA14	26	ZB4BD49	41	ZB4BK1463	43	ZB4BS44	37
XB7NJ05B1	199	ZB4BA141	28	ZB4BD5	38	ZB4BK1513	43	ZB4BS52	35
XB7NJ05G1	199	ZB4BA142	28	ZB4BD59	41	ZB4BK1533	43	ZB4BS54	37
XB7NJ05M1	199	ZB4BA145	28	ZB4BD7	38	ZB4BK1543	43	ZB4BS55	35
XB7NJ06B1	199	ZB4BA16	27	ZB4BD79	41	ZB4BK1553	43	ZB4BS62	35
XB7NJ06G1	199	ZB4BA18	26, 30	ZB4BD8	38	ZB4BK1563	43	ZB4BS64	37
XB7NJ06M1	199	ZB4BA2	26	ZB4BD89	41	ZB4BK1713	43	ZB4BS72	35
XB7NJ07B1	199	ZB4BA232	28	ZB4BD912	46	ZB4BK1733	43	ZB4BS74	37
XB7NJ07G1	199	ZB4BA234	28	ZB4BD922	46	ZB4BK1743	43	ZB4BS834	36
XB7NJ07M1	199	ZB4BA235	28	ZB4BG0	40	ZB4BK1753	43	ZB4BS844	36
XB7NJ08B1	199	ZB4BA24	26	ZB4BG01	40	ZB4BK1763	43	ZB4BS864	36
XB7NJ08G1	199	ZB4BA245	28	ZB4BG02	40	ZB4BK1813	43	ZB4BS934	36
XB7NJ08M1	199	ZB4BA26	27	ZB4BG03	40	ZB4BK1833	43	ZB4BS944	36
XB7NL42	197	ZB4BA3	26	ZB4BG04	40	ZB4BK1843	43	ZB4BS964	36
XB7NL4232	198	ZB4BA331	28	ZB4BG05	40	ZB4BK1853	43	ZB4BT2	35
XB7NL4234	198	ZB4BA333	28	ZB4BG05TEC10	41	ZB4BK1863	43	ZB4BT4	37
XB7NL44	197	ZB4BA334	28	ZB4BG08	40	ZB4BL1	26	ZB4BT44	37
XB7NL45	197	ZB4BA335	28	ZB4BG09	40	ZB4BL2	26	ZB4BT84	36
XB7NL4532	198	ZB4BA336	28	ZB4BG0TEC10	41	ZB4BL232	28	ZB4BT844	36
XB7NL4534	198	ZB4BA34	26	ZB4BG1	40	ZB4BL234	28	ZB4BV003	44
XB7NS8442	200	ZB4BA341	28	ZB4BG2	40	ZB4BL235	28	ZB4BV01	45
XB7NS8444	200	ZB4BA36	27	ZB4BG2TEC10	41	ZB4BL3	26	ZB4BV013	44
XB7NS8445	200	ZB4BA38	26, 30	ZB4BG3	40	ZB4BL4	26	ZB4BV013E	44
XB7NS9444	200	ZB4BA4	26	ZB4BG3TEC10	41	ZB4BL432	28	ZB4BV013S	44
XB7NS9445	200	ZB4BA432	28	ZB4BG4	40	ZB4BL434	28	ZB4BV01S	45
XB7NT842	200	ZB4BA434	28	ZB4BG4TEC10	41	ZB4BL435	28	ZB4BV03	45
XB7NT844	200	ZB4BA435	28	ZB4BG5	40	ZB4BL5	26	ZB4BV033	44
XB7NT845	200	ZB4BA44	26	ZB4BG5TEC10	41	ZB4BL6	26	ZB4BV033E	44
XB7NW33B1	199	ZB4BA46	27	ZB4BG6	40	ZB4BL7340	32	ZB4BV033S	44
XB7NW33G1	199	ZB4BA48	26, 30	ZB4BG6TEC10	41	ZB4BL7341	32	ZB4BV03S	45
XB7NW33M1	199	ZB4BA5	26	ZB4BG7	40	ZB4BP1	27	ZB4BV04	45
XB7NW34B1	199	ZB4BA54	26	ZB4BG7TEC10	41	ZB4BP18	27	ZB4BV043	44
XB7NW34B2	199	ZB4BA56	27	ZB4BG8	40	ZB4BP183	27	ZB4BV043E	44
XB7NW34G1	199	ZB4BA58	26, 30	ZB4BG9	40	ZB4BP1S	27	ZB4BV043S	44
XB7NW34G2	199	ZB4BA6	26	ZB4BG9TEC10	41	ZB4BP2	27	ZB4BV04S	45
XB7NW34M1	199	ZB4BA64	26	ZB4BJ2	39	ZB4BP2S	27	ZB4BV05	45
XB7NW34M2	199	ZB4BA66	27	ZB4BJ291	39	ZB4BP3	27	ZB4BV053	44
XB7NW35B1	199	ZB4BA68	26, 30	ZB4BJ292	39	ZB4BP38	27	ZB4BV053E	44
XB7NW35G1	199	ZB4BA71115	33	ZB4BJ294	39	ZB4BP383	27	ZB4BV053S	44
XB7NW35M1	199	ZB4BA71123	33	ZB4BJ3	39	ZB4BP3S	27	ZB4BV05S	45
XB7NW36B1	199	ZB4BA71124	33	ZB4BJ391	39	ZB4BP4	27	ZB4BV06	45
XB7NW36G1	199	ZB4BA7120	32	ZB4BJ392	39	ZB4BP48	27	ZB4BV063	44
XB7NW36M1	199	ZB4BA7121	32	ZB4BJ393	39	ZB4BP483	27	ZB4BV063E	44
XB7NW37B1	199	ZB4BA72124	33	ZB4BJ394	39	ZB4BP4S	27	ZB4BV063S	44
XB7NW37G1	199	ZB4BA73132	33	ZB4BJ395	39	ZB4BP5	27	ZB4BV06S	45
XB7NW37M1	199	ZB4BA73133	33	ZB4BJ396	39	ZB4BP58	27	ZB4BV07	45

ZB4BV07S	45	ZB4BW03D55	58	ZB4BW0M52	55	ZB4BW7L3740	32	ZB5AA26	99
ZB4BV156	59	ZB4BW03D65	58	ZB4BW0M53	55	ZB4BW7L3741	32	ZB5AA3	98
ZB4BV18B1	57	ZB4BW041	58	ZB4BW0M55	55	ZB4BW913	30	ZB5AA331	102
ZB4BV18B3	57	ZB4BW045	58	ZB4BW0M61	55	ZB4BW933	30	ZB5AA333	102
ZB4BV18B4	57	ZB4BW04D15	58	ZB4BW0M62	55	ZB4BW943	30	ZB5AA334	102
ZB4BV18B5	57	ZB4BW04D35	58	ZB4BW0M63	55	ZB4BW953	30	ZB5AA335	102
ZB4BV18B6	57	ZB4BW04D45	58	ZB4BW0M65	55	ZB4BW963	30	ZB5AA336	102
ZB4BV18G1	57	ZB4BW04D55	58	ZB4BW11	31	ZB4BX2	35	ZB5AA34	98
ZB4BV18G3	57	ZB4BW04D65	58	ZB4BW113	30	ZB4BX4	37	ZB5AA341	102
ZB4BV18G4	57	ZB4BW051	58	ZB4BW113S	30	ZB4BX84	36	ZB5AA343	102
ZB4BV18G5	57	ZB4BW055	58	ZB4BW11S	31	ZB4BZ007	69, 145	ZB5AA344	102
ZB4BV18G6	57	ZB4BW05D15	58	ZB4BW13	31	ZB4BZ0077	69, 145	ZB5AA36	99
ZB4BV18M1	57	ZB4BW05D35	58	ZB4BW133	30	ZB4BZ009	48, 50, 51, 53, 185	ZB5AA38	98, 104
ZB4BV18M3	57	ZB4BW05D45	58	ZB4BW133S	30	ZB4BZ011	69	ZB5AA4	98
ZB4BV18M4	57	ZB4BW05D55	58	ZB4BW13S	31	ZB4BZ0117	69	ZB5AA432	102
ZB4BV18M5	57	ZB4BW05D65	58	ZB4BW14	31	ZB4BZ0179	51	ZB5AA434	102
ZB4BV18M6	57	ZB4BW061	58	ZB4BW143	30	ZB4BZ101	48	ZB5AA435	102
ZB4BV3	59	ZB4BW062	58	ZB4BW143S	30	ZB4BZ1013	52	ZB5AA44	98
ZB4BV3D1	59	ZB4BW063	58	ZB4BW14S	31	ZB4BZ1014	53	ZB5AA46	99
ZB4BV3D3	59	ZB4BW065	58	ZB4BW15	31	ZB4BZ1015	50	ZB5AA48	98, 104
ZB4BV3D4	59	ZB4BW0B11	54	ZB4BW153	30	ZB4BZ102	48	ZB5AA5	98
ZB4BV3D5	59	ZB4BW0B12	54	ZB4BW153S	30	ZB4BZ1023	52	ZB5AA54	98
ZB4BV3D6	59	ZB4BW0B13	54	ZB4BW15S	31	ZB4BZ1024	53	ZB5AA56	99
ZB4BV4	59	ZB4BW0B15	54	ZB4BW16	31	ZB4BZ1025	50	ZB5AA58	98, 104
ZB4BV4D1	59	ZB4BW0B31	54	ZB4BW163	30	ZB4BZ103	48	ZB5AA6	98
ZB4BV4D3	59	ZB4BW0B32	54	ZB4BW163S	30	ZB4BZ1033	52	ZB5AA64	98
ZB4BV4D4	59	ZB4BW0B33	54	ZB4BW16S	31	ZB4BZ1034	53	ZB5AA66	99
ZB4BV4D5	59	ZB4BW0B35	54	ZB4BW17	31	ZB4BZ1035	50	ZB5AA68	98, 104
ZB4BV4D6	59	ZB4BW0B41	54	ZB4BW17S	31	ZB4BZ104	48	ZB5AA71115	107
ZB4BV5	59	ZB4BW0B42	54	ZB4BW31	31	ZB4BZ1043	52	ZB5AA71123	107
ZB4BV5D1	59	ZB4BW0B43	54	ZB4BW313	30	ZB4BZ1044	53	ZB5AA71124	107
ZB4BV5D3	59	ZB4BW0B45	54	ZB4BW313S	30	ZB4BZ1045	50	ZB5AA7120	106
ZB4BV5D4	59	ZB4BW0B51	54	ZB4BW31S	31	ZB4BZ105	48	ZB5AA7121	106
ZB4BV5D5	59	ZB4BW0B52	54	ZB4BW33	31	ZB4BZ1053	52	ZB5AA72124	107
ZB4BV5D6	59	ZB4BW0B53	54	ZB4BW333	30	ZB4BZ1054	53	ZB5AA73132	107
ZB4BV6	59	ZB4BW0B55	54	ZB4BW333S	30	ZB4BZ1055	50	ZB5AA73133	107
ZB4BV8	59	ZB4BW0B61	54	ZB4BW33S	31	ZB4BZ106	48	ZB5AA73134	107
ZB4BV9	59	ZB4BW0B62	54	ZB4BW34	31	ZB4BZ107	48	ZB5AA73135	107
ZB4BVB1	56	ZB4BW0B63	54	ZB4BW343	30	ZB4BZ141	48	ZB5AA7340	106
ZB4BVB1156	57	ZB4BW0B65	54	ZB4BW343S	30	ZB4BZ1414	53	ZB5AA7341	106
ZB4BVB3	56	ZB4BW0G11	54	ZB4BW34S	31	ZB4BZ262	68, 144	ZB5AA791	107
ZB4BVB3156	57	ZB4BW0G12	54	ZB4BW35	31	ZB4BZ264	68, 144	ZB5AA8	98
ZB4BVB4	56	ZB4BW0G13	54	ZB4BW353	30	ZB4BZ265	68, 144	ZB5AA9	98
ZB4BVB4156	57	ZB4BW0G15	54	ZB4BW353S	30	ZB4BZ266	68, 144	ZB5AC2	108
ZB4BVB5	56	ZB4BW0G31	54	ZB4BW35S	31	ZB4RTA1	184	ZB5AC24	108
ZB4BVB5156	57	ZB4BW0G32	54	ZB4BW36	31	ZB4RTA2	184	ZB5AC3	108
ZB4BVB6	56	ZB4BW0G33	54	ZB4BW363	30	ZB4RTA3	184	ZB5AC34	108
ZB4BVB6156	57	ZB4BW0G35	54	ZB4BW363S	30	ZB4RTA331	184	ZB5AC4	108
ZB4BVBG1	56	ZB4BW0G41	54	ZB4BW36S	31	ZB4RTA4	184	ZB5AC44	108
ZB4BVBG3	56	ZB4BW0G42	54	ZB4BW37	31	ZB4RTA432	184	ZB5AC5	108
ZB4BVBG4	56	ZB4BW0G43	54	ZB4BW37S	31	ZB4RTA5	184	ZB5AC54	108
ZB4BVBG5	56	ZB4BW0G45	54	ZB4BW413	34	ZB4RTA6	184	ZB5AC6	108
ZB4BVBG6	56	ZB4BW0G51	54	ZB4BW433	34	ZB4RZA0	184	ZB5AC64	108
ZB4BVG1	56	ZB4BW0G52	54	ZB4BW443	34	ZB4SZ3	69	ZB5AD2	113
ZB4BVG3	56	ZB4BW0G53	54	ZB4BW453	34	ZB4SZ37	69	ZB5AD28	115
ZB4BVG4	56	ZB4BW0G55	54	ZB4BW463	34	ZB5		ZB5AD2801	115
ZB4BVG5	56	ZB4BW0G61	54	ZB4BW513	30	ZB5AA0	98	ZB5AD2804	115
ZB4BVG6	56	ZB4BW0G62	54	ZB4BW533	30	ZB5AA1	98	ZB5AD2806	115
ZB4BVJ1	56	ZB4BW0G63	54	ZB4BW543	30	ZB5AA131	102	ZB5AD29	115
ZB4BVJ3	56	ZB4BW0G65	54	ZB4BW553	30	ZB5AA133	102	ZB5AD3	113
ZB4BVJ4	56	ZB4BW0M11	55	ZB4BW563	30	ZB5AA136	102	ZB5AD39	115
ZB4BVJ5	56	ZB4BW0M12	55	ZB4BW613	35	ZB5AA14	98	ZB5AD4	113
ZB4BVJ6	56	ZB4BW0M13	55	ZB4BW633	35	ZB5AA141	102	ZB5AD48	115
ZB4BVM1	56	ZB4BW0M15	55	ZB4BW643	37	ZB5AA145	102	ZB5AD49	115
ZB4BVM3	56	ZB4BW0M31	55	ZB4BW653	35	ZB5AA16	99	ZB5AD5	113
ZB4BVM4	56	ZB4BW0M32	55	ZB4BW663	35	ZB5AA18	98, 104	ZB5AD59	115
ZB4BVM5	56	ZB4BW0M33	55	ZB4BW7A1715	32	ZB5AA2	98	ZB5AD7	113
ZB4BVM6	56	ZB4BW0M35	55	ZB4BW7A1720	32	ZB5AA232	102	ZB5AD79	115
ZB4BW031	58	ZB4BW0M41	55	ZB4BW7A1721	32	ZB5AA234	102	ZB5AD8	113
ZB4BW035	58	ZB4BW0M42	55	ZB4BW7A1724	32	ZB5AA235	102	ZB5AD89	115
ZB4BW03D15	58	ZB4BW0M43	55	ZB4BW7A3740	32	ZB5AA24	98	ZB5AD912	120
ZB4BW03D35	58	ZB4BW0M45	55	ZB4BW7A3741	32	ZB5AA245	102	ZB5AD922	120
ZB4BW03D45	58	ZB4BW0M51	55	ZB4BW7A9	32				



ZB5AF	112	ZB5AK1463	117	ZB5AS42	109	ZB5AV5	133	ZB5AW0B42	128
ZB5AF351	112	ZB5AK1513	117	ZB5AS44	111	ZB5AV5D1	133	ZB5AW0B43	128
ZB5AFDA	112	ZB5AK1533	117	ZB5AS52	109	ZB5AV5D3	133	ZB5AW0B45	128
ZB5AFDB	112	ZB5AK1543	117	ZB5AS54	111	ZB5AV5D4	133	ZB5AW0B51	128
ZB5AFDC	112	ZB5AK1553	117	ZB5AS55	109	ZB5AV5D5	133	ZB5AW0B52	128
ZB5AFDD	112	ZB5AK1563	117	ZB5AS62	109	ZB5AV5D6	133	ZB5AW0B53	128
ZB5AFDE01	112	ZB5AK1713	117	ZB5AS64	111	ZB5AV6	133	ZB5AW0B55	128
ZB5AFDE02	112	ZB5AK1733	117	ZB5AS72	109	ZB5AV8	133	ZB5AW0B61	128
ZB5AFDE03	112	ZB5AK1743	117	ZB5AS74	111	ZB5AV9	133	ZB5AW0B62	128
ZB5AFDE04	112	ZB5AK1753	117	ZB5AS834	110	ZB5AVB1	130	ZB5AW0B63	128
ZB5AFDE05	112	ZB5AK1763	117	ZB5AS844	110	ZB5AVB1156	131	ZB5AW0B65	128
ZB5AFDE06	112	ZB5AK1813	117	ZB5AS934	110	ZB5AVB3	130	ZB5AW0G11	128
ZB5AFDE07	112	ZB5AK1833	117	ZB5AS944	110	ZB5AVB3156	131	ZB5AW0G12	128
ZB5AFDE08	112	ZB5AK1843	117	ZB5AS944D	110	ZB5AVB4	130	ZB5AW0G13	128
ZB5AFDE09	112	ZB5AK1853	117	ZB5AS964	110	ZB5AVB4156	131	ZB5AW0G15	128
ZB5AFDE10	112	ZB5AK1863	117	ZB5AT2	109	ZB5AVB5	130	ZB5AW0G31	128
ZB5AFDE11	112	ZB5AL1	100	ZB5AT24	109	ZB5AVB5156	131	ZB5AW0G32	128
ZB5AFDE12	112	ZB5AL2	100	ZB5AT4	111	ZB5AVB6	130	ZB5AW0G33	128
ZB5AFDE13	112	ZB5AL232	102	ZB5AT44	111	ZB5AVB6156	131	ZB5AW0G35	128
ZB5AFDE14	112	ZB5AL234	102	ZB5AT84	110	ZB5AVBG1	130	ZB5AW0G41	128
ZB5AFDE15	112	ZB5AL235	102	ZB5AT844	110	ZB5AVBG3	130	ZB5AW0G42	128
ZB5AG0	114	ZB5AL3	100	ZB5AT8643M	110	ZB5AVBG4	130	ZB5AW0G43	128
ZB5AG02	114	ZB5AL4	100	ZB5AV003	118	ZB5AVBG5	130	ZB5AW0G45	128
ZB5AG02D	115	ZB5AL432	102	ZB5AV01	119	ZB5AVBG6	130	ZB5AW0G51	128
ZB5AG03D	115	ZB5AL434	102	ZB5AV013	118	ZB5AVG1	130	ZB5AW0G52	128
ZB5AG04D	115	ZB5AL435	102	ZB5AV013E	118	ZB5AVG3	130	ZB5AW0G53	128
ZB5AG05	114	ZB5AL5	100	ZB5AV01S	119	ZB5AVG4	130	ZB5AW0G55	128
ZB5AG05D	115	ZB5AL6	100	ZB5AV03	119	ZB5AVG5	130	ZB5AW0G61	128
ZB5AG06D	115	ZB5AL7340	106	ZB5AV033	118	ZB5AVG6	130	ZB5AW0G62	128
ZB5AG07D	115	ZB5AL7341	106	ZB5AV033E	118	ZB5AVJ1	130	ZB5AW0G63	128
ZB5AG08	114	ZB5AP1	101	ZB5AV03S	119	ZB5AVJ3	130	ZB5AW0G65	128
ZB5AG08D	115	ZB5AP18	101	ZB5AV04	119	ZB5AVJ4	130	ZB5AW0M11	129
ZB5AG09	114	ZB5AP183	101	ZB5AV043	118	ZB5AVJ5	130	ZB5AW0M12	129
ZB5AG09D	115	ZB5AP1S	101	ZB5AV043E	118	ZB5AVJ6	130	ZB5AW0M13	129
ZB5AG0D	115	ZB5AP2	101	ZB5AV04S	119	ZB5AVM1	130	ZB5AW0M15	129
ZB5AG1	114	ZB5AP2S	101	ZB5AV05	119	ZB5AVM3	130	ZB5AW0M31	129
ZB5AG1D	115	ZB5AP3	101	ZB5AV053	118	ZB5AVM4	130	ZB5AW0M32	129
ZB5AG2	114	ZB5AP38	101	ZB5AV053E	118	ZB5AVM5	130	ZB5AW0M33	129
ZB5AG2D	115	ZB5AP383	101	ZB5AV05S	119	ZB5AVM6	130	ZB5AW0M35	129
ZB5AG3	114	ZB5AP3S	101	ZB5AV06	119	ZB5AW031	132	ZB5AW0M41	129
ZB5AG3D	115	ZB5AP4	101	ZB5AV063	118	ZB5AW035	132	ZB5AW0M42	129
ZB5AG4	114	ZB5AP48	101	ZB5AV063E	118	ZB5AW03D15	132	ZB5AW0M43	129
ZB5AG4D	115	ZB5AP483	101	ZB5AV06S	119	ZB5AW03D35	132	ZB5AW0M45	129
ZB5AG5	114	ZB5AP4S	101	ZB5AV07	119	ZB5AW03D45	132	ZB5AW0M51	129
ZB5AG5D	115	ZB5AP5	101	ZB5AV07S	119	ZB5AW03D55	132	ZB5AW0M52	129
ZB5AG6	114	ZB5AP58	101	ZB5AV156	133	ZB5AW03D65	132	ZB5AW0M53	129
ZB5AG6D	115	ZB5AP583	101	ZB5AV18B1	131	ZB5AW041	132	ZB5AW0M55	129
ZB5AG7	114	ZB5AP5S	101	ZB5AV18B3	131	ZB5AW045	132	ZB5AW0M61	129
ZB5AG7D	115	ZB5AP6	101	ZB5AV18B4	131	ZB5AW04D15	132	ZB5AW0M62	129
ZB5AG8	114	ZB5AP68	101	ZB5AV18B5	131	ZB5AW04D35	132	ZB5AW0M63	129
ZB5AG8D	115	ZB5AP683	101	ZB5AV18B6	131	ZB5AW04D45	132	ZB5AW0M65	129
ZB5AG9	114	ZB5AP6S	101	ZB5AV18G1	131	ZB5AW04D55	132	ZB5AW11	105
ZB5AG9D	115	ZB5APA1	101	ZB5AV18G3	131	ZB5AW04D65	132	ZB5AW113	104
ZB5AJ2	113	ZB5APA2	101	ZB5AV18G4	131	ZB5AW051	132	ZB5AW113S	104
ZB5AJ3	113	ZB5APA3	101	ZB5AV18G5	131	ZB5AW055	132	ZB5AW11S	105
ZB5AJ4	113	ZB5APA4	101	ZB5AV18G6	131	ZB5AW05D15	132	ZB5AW13	105
ZB5AJ5	113	ZB5APA5	101	ZB5AV18M1	131	ZB5AW05D35	132	ZB5AW133	104
ZB5AJ7	113	ZB5APA6	101	ZB5AV18M3	131	ZB5AW05D45	132	ZB5AW133S	104
ZB5AJ8	113	ZB5AR2	108	ZB5AV18M4	131	ZB5AW05D55	132	ZB5AW13S	105
ZB5AK1213	117	ZB5AR216	108	ZB5AV18M5	131	ZB5AW05D65	132	ZB5AW14	105
ZB5AK1233	117	ZB5AR3	108	ZB5AV18M6	131	ZB5AW061	132	ZB5AW143	104
ZB5AK1243	117	ZB5AR316	108	ZB5AV3	133	ZB5AW062	132	ZB5AW143S	104
ZB5AK1253	117	ZB5AR4	108	ZB5AV3D1	133	ZB5AW063	132	ZB5AW14S	105
ZB5AK1263	117	ZB5AR416	108	ZB5AV3D3	133	ZB5AW065	132	ZB5AW15	105
ZB5AK1313	117	ZB5AR5	108	ZB5AV3D4	133	ZB5AW0B11	128	ZB5AW153	104
ZB5AK1333	117	ZB5AR516	108	ZB5AV3D5	133	ZB5AW0B12	128	ZB5AW153S	104
ZB5AK1343	117	ZB5AR6	108	ZB5AV3D6	133	ZB5AW0B13	128	ZB5AW15S	105
ZB5AK1353	117	ZB5AR616	108	ZB5AV4	133	ZB5AW0B15	128	ZB5AW16	105
ZB5AK1363	117	ZB5AS12	109	ZB5AV4D1	133	ZB5AW0B31	128	ZB5AW163	104
ZB5AK1413	117	ZB5AS14	111	ZB5AV4D3	133	ZB5AW0B32	128	ZB5AW163S	104
ZB5AK1433	117	ZB5AS14D	111	ZB5AV4D4	133	ZB5AW0B33	128	ZB5AW16S	105
ZB5AK1443	117	ZB5AS22	109	ZB5AV4D5	133	ZB5AW0B35	128	ZB5AW17	105
ZB5AK1453	117	ZB5AS24	111	ZB5AV4D6	133	ZB5AW0B41	128	ZB5AW17S	105

ZB5AW31	105	ZB5AZ107	122	ZBA137	60, 135	ZBCW9313	137	ZBG520EP	71, 147
ZB5AW313	104	ZB5AZ141	122	ZBA138	60	ZBCW9333	137	ZBGP	71, 147
ZB5AW313S	104	ZB5AZ1414	127	ZBA141	60, 135	ZBCW9343	137	<b>ZBL</b>	
ZB5AW31S	105	ZB5AZ31	146	ZBA145	60, 135	ZBCW9353	137	ZBL1	60, 134
ZB5AW33	105	ZB5AZ901	146, 202	ZBA2	60, 134	ZBCW9363	137	ZBL138	135
ZB5AW333	104	ZB5AZ902	146, 202	ZBA232	60, 135	<b>ZBD</b>		ZBL2	60, 134
ZB5AW333S	104	ZB5AZ905	146, 202	ZBA233	135	ZBD8D1	71, 147	ZBL3	60, 134
ZB5AW33S	105	ZB5CA0	98	ZBA234	60, 135	ZBDA185	71, 147	ZBL4	60, 134
ZB5AW34	105	ZB5CA1	98	ZBA235	60, 135	ZBDD2	71	ZBL5	60, 134
ZB5AW343	104	ZB5CA16	99	ZBA245	60, 135	ZBDLU1	71, 147	ZBL6	60, 134
ZB5AW343S	104	ZB5CA2	98	ZBA2934	60, 135	ZBDLU10	71, 147	ZBL9	60, 134
ZB5AW34S	105	ZB5CA26	99	ZBA2935	60, 135	ZBDLU11	71, 147	<b>ZBP</b>	
ZB5AW35	105	ZB5CA2912	102	ZBA3	60, 134	ZBDLU12	71, 147	ZBP0	61, 136
ZB5AW353	104	ZB5CA2934	102	ZBA331	60, 135	ZBDLU13	71, 147	ZBP0A	61, 136
ZB5AW353S	104	ZB5CA3	98	ZBA333	60, 135	ZBDLU14	71, 147	ZBPA	61, 136
ZB5AW35S	105	ZB5CA331	102	ZBA334	60, 135	ZBDLU2	71, 147	<b>ZBR</b>	
ZB5AW36	105	ZB5CA36	99	ZBA335	60, 135	ZBDLU3	71, 147	ZBRA1	185
ZB5AW363	104	ZB5CA4	98	ZBA336	60, 135	ZBDLU4	71, 147	ZBRA2	189
ZB5AW363S	104	ZB5CA432	102	ZBA337	60, 135	ZBDLU5	71, 147	ZBRACS	185
ZB5AW36S	105	ZB5CA46	99	ZBA338	60, 135	ZBDLU6	71, 147	ZBRCETH	189
ZB5AW37	105	ZB5CA5	98	ZBA341	60, 135	ZBDLU7	71, 147	ZBRM01	185
ZB5AW37S	105	ZB5CA56	99	ZBA343	60, 135	ZBDLU8	71, 147	ZBRM21	185
ZB5AW513	104	ZB5CA6	98	ZBA344	60, 135	ZBDLU9	71, 147	ZBRM22	185
ZB5AW533	104	ZB5CA66	99	ZBA346	60, 135	<b>ZBE</b>		ZBRN1	189
ZB5AW543	104	ZB5CA6939	102	ZBA4	60, 134	ZBE101	48, 122	ZBRN2	189
ZB5AW553	104	ZB5CL1	100	ZBA432	60, 135	ZBE1013	52, 126	ZBRP1	184
ZB5AW563	104	ZB5CL2	100	ZBA433	135	ZBE1014	53, 127	ZBRRR	185
ZB5AW713	109	ZB5CL3	100	ZBA434	60, 135	ZBE1015	50, 124	ZBRRC	185
ZB5AW733	109	ZB5CL4	100	ZBA435	60, 135	ZBE1016	48, 122	ZBRRD	185
ZB5AW743	111	ZB5CL5	100	ZBA5	60, 134	ZBE10163	52, 126	ZBRT1	184
ZB5AW753	109	ZB5CL6	100	ZBA6	60, 134	ZBE1016P	48, 122	ZBRT2	184
ZB5AW763	109	ZB5CV003	118	ZBA639	60, 135	ZBE1016P3	52, 126	<b>ZBV</b>	
ZB5AW7A1715	106	ZB5CV013	118	ZBA708	33, 107	ZBE102	48, 122	ZBV0103S	61, 137
ZB5AW7A1720	106	ZB5CV033	118	ZBA709	33, 107	ZBE1023	52, 126	ZBV0103S	61, 137
ZB5AW7A1721	106	ZB5CV043	118	ZBA71	33, 107, 185	ZBE1024	53, 127	ZBV011	61, 137
ZB5AW7A1724	106	ZB5CV053	118	ZBA710	33, 107, 185	ZBE1025	50, 124	ZBV0113	61, 137
ZB5AW7A3740	106	ZB5CV063	118	ZBA7131	33, 107	ZBE1026	48, 122	ZBV013	61, 137
ZB5AW7A3741	106	ZB5CW113	104	ZBA7134	33, 107, 185	ZBE10263	52, 126	ZBV0133	61, 137
ZB5AW7A9	106	ZB5CW133	104	ZBA7138	33, 107, 185	ZBE1026P	48, 122	ZBV014	61, 137
ZB5AW7L3740	106	ZB5CW143	104	ZBA72	33, 107, 185	ZBE1026P3	52, 126	ZBV0143	61, 137
ZB5AW7L3741	106	ZB5CW153	104	ZBA7232	33, 107, 185	ZBE201	48, 122	ZBV015	61, 137
ZB5AW913	104	ZB5CW163	104	ZBA7233	33, 107, 185	ZBE2013	52, 126	ZBV0153	61, 137
ZB5AW933	104	ZB5CW313	104	ZBA7235	33, 107, 185	ZBE202	48, 122	ZBV016	61, 137
ZB5AW943	104	ZB5CW3136	104	ZBA7237	33, 107, 185	ZBE2023	52, 126	ZBV0163	61, 137
ZB5AW953	104	ZB5CW333	104	ZBA73	33, 107, 185	ZBE203	48, 122	ZBV017	61, 137
ZB5AW963	104	ZB5CW3336	104	ZBA7331	33, 107, 185	ZBE2033	52, 126	ZBV18B1	49, 123
ZB5AX2	109	ZB5CW343	104	ZBA7333	33, 107, 185	ZBE204	48, 122	ZBV18B3	49, 123
ZB5AX4	111	ZB5CW3436	104	ZBA7335	33, 107, 185	ZBE2043	52, 126	ZBV18B4	49, 123
ZB5AX84	110	ZB5CW353	104	ZBA7336	33, 107, 185	ZBE205	48, 122	ZBV18B5	49, 123
ZB5AZ009	122, 124, 125, 127, 185	ZB5CW3536	104	ZBA74	33, 107, 185	ZBE2053	52, 126	ZBV18B6	49, 123
ZB5AZ079	125	ZB5CW363	104	ZBA7432	33, 107, 185	ZBE5013	52, 126	ZBV18G1	49, 123
ZB5AZ101	122	ZB5RTA1	184	ZBA75	33, 107, 185	ZBE5023	52, 126	ZBV18G3	49, 123
ZB5AZ1013	126	ZB5RTA2	184	ZBA76	33, 107, 185	ZBE5033	52, 126	ZBV18G4	49, 123
ZB5AZ1014	127	ZB5RTA3	184	ZBA79	185	ZBE5043	52, 126	ZBV18G5	49, 123
ZB5AZ1015	124	ZB5RTA331	184	ZBA80	185	ZBE5053	52, 126	ZBV18G6	49, 123
ZB5AZ102	122	ZB5RTA4	184	ZBA9	60, 134	ZBE701	51, 125	ZBV18M1	49, 123
ZB5AZ1023	126	ZB5RTA432	184	<b>ZBC</b>		ZBE7016	51, 125	ZBV18M3	49, 123
ZB5AZ1024	127	ZB5RTA5	184	ZBC1	134	ZBE702	51, 125	ZBV18M4	49, 123
ZB5AZ1025	124	ZB5RTA6	184	ZBC2	134	ZBE7026	51, 125	ZBV18M5	49, 123
ZB5AZ103	122	ZB5RTC2	184	ZBC3	134	<b>ZBG</b>		ZBV18M6	49, 123
ZB5AZ1033	126	ZB5RZA0	184	ZBC4	134	ZBG2201	47, 121	ZBV5B	49, 123
ZB5AZ1034	127	ZB5RZC2	184	ZBC5	134	ZBG2401	47, 121	ZBV6	59, 133
ZB5AZ1035	124	ZB5SZ3	69, 145, 202	ZBC6	134	ZBG3131A	71, 147	ZBVB1	49, 123
ZB5AZ104	122	ZB5SZ37	145	ZBCV0113	137	ZBG3131AP	71, 147	ZBVB14	53, 127
ZB5AZ1043	126	ZB5SZ5	145	ZBCV0133	137	ZBG4201	47, 121	ZBVB15	50, 124
ZB5AZ1044	127	ZB5SZ70	167	ZBCV0143	137	ZBG421E	71, 147	ZBVB17	51, 125
ZB5AZ1045	124	ZB5SZ71	167	ZBCV0153	137	ZBG421EP	71, 147	ZBVB3	49, 123
ZB5AZ105	122	<b>ZBA</b>		ZBCV0163	137	ZBG4401	47, 121	ZBVB34	53, 127
ZB5AZ1053	126	ZBA1	60, 134	ZBCW9113	137	ZBG455	71, 147	ZBVB35	50, 124
ZB5AZ1054	127	ZBA131	60, 135	ZBCW9133	137	ZBG455P	71, 147	ZBVB37	51, 125
ZB5AZ1055	124	ZBA133	60, 135	ZBCW9143	137	ZBG458A	71, 147	ZBVB4	49, 123
ZB5AZ106	122	ZBA136	60, 135	ZBCW9153	137	ZBG458AP	71, 147	ZBVB44	53, 127
				ZBCW9163	137	ZBG520E	71, 147	ZBVB45	50, 124

ZBVB47	51, 125	ZBW9353	61, 137	ZBY02230	65, 141	ZBY2107	62, 138	ZBY2306	63, 139, 201
ZBVB5	49, 123	ZBW936	61, 137	ZBY02231	65, 141	ZBY2108	62, 138	ZBY2307	63, 139, 201
ZBVB54	53, 127	ZBW9363	61, 137	ZBY02232	65, 141	ZBY2109	62, 138	ZBY2308	63, 139, 201
ZBVB55	50, 124	ZBW937	61, 137	ZBY02233	65, 141	ZBY2110	62, 138	ZBY2309	63, 139, 201
ZBVB57	51, 125	<b>ZBY</b>		ZBY02234	65, 141	ZBY2111	62, 138	ZBY2310	63, 139, 201
ZBVB6	49, 123	ZBY001	48, 50, 52, 122, 124, 126	ZBY02235	65, 141	ZBY2112	62, 138	ZBY2311	63, 139, 201
ZBVB64	53, 127	ZBY00104	64, 140	ZBY022420001	65, 141	ZBY2113	62, 138	ZBY2312	63, 139, 201
ZBVB65	50, 124	ZBY00102	64, 140	ZBY02265	65, 141	ZBY2114	62, 138	ZBY2313	63, 139
ZBVB67	51, 125	ZBY00123	64, 140	ZBY02266	65, 141	ZBY2115	62, 138, 201	ZBY2314	63, 139
ZBVBG1	49, 123	ZBY0101T	167, 185	ZBY02267	65, 141	ZBY2116	62, 138	ZBY2316	63, 139, 201
ZBVBG3	49, 123	ZBY0102	64, 140	ZBY02284	65, 141	ZBY2123	62, 138	ZBY2321	63, 139, 201
ZBVBG4	49, 123	ZBY0104	62, 138	ZBY02295	65, 141	ZBY2126	62, 138	ZBY2322	63, 139
ZBVBG5	49, 123	ZBY0123	62, 138	ZBY02297	65, 141	ZBY2127	62, 138	ZBY2323	63, 139, 201
ZBVBG6	49, 123	ZBY0140	64, 140	ZBY02298	65, 141	ZBY2128	62, 138	ZBY2326	63, 139, 201
ZBVG1	49, 123	ZBY02103	64, 140	ZBY02299	65, 141	ZBY2129	62, 138	ZBY2327	63, 139
ZBVG14	53, 127	ZBY02104	64, 140	ZBY02303	65, 141	ZBY2130	62, 138	ZBY2328	63, 139
ZBVG15	50, 124	ZBY02105	64, 140	ZBY02304	65, 141	ZBY2131	62, 138	ZBY2330	63, 139
ZBVG3	49, 123	ZBY02106	64, 140	ZBY02305	65, 141	ZBY2132	62, 138	ZBY2334	63, 139
ZBVG34	53, 127	ZBY02107	64, 140	ZBY02306	65, 141	ZBY2133	62, 138	ZBY2364	63, 139
ZBVG35	50, 124	ZBY02108	64, 140	ZBY02307	65, 141	ZBY2134	62, 138	ZBY2366	63, 139
ZBVG4	49, 123	ZBY02109	64, 140	ZBY02308	65, 141	ZBY2135	62, 138	ZBY2367	63, 139
ZBVG44	53, 127	ZBY02110	64, 140	ZBY02309	65, 141	ZBY2146	62, 138, 201	ZBY2385	63, 139
ZBVG45	50, 124	ZBY02111	64, 140	ZBY02310	65, 141	ZBY2147	62, 138, 201	ZBY2387	63, 139
ZBVG5	49, 123	ZBY02112	64, 140	ZBY02311	65, 141	ZBY2148	62, 138	ZBY2931	62, 138
ZBVG54	53, 127	ZBY02113	64, 140	ZBY02312	65, 141	ZBY2164	62, 138	ZBY2H101	62, 138
ZBVG55	50, 124	ZBY02114	64, 140	ZBY02313	65, 141	ZBY2165	62, 138	ZBY4100	65, 141
ZBVG6	49, 123	ZBY02115	64, 140	ZBY02314	65, 141	ZBY2166	62, 138	ZBY4101	62, 138, 201
ZBVG64	53, 127	ZBY02116	64, 140	ZBY02316	65, 141	ZBY2167	62, 138	ZBY4140	62, 138, 201
ZBVG65	50, 124	ZBY02123	64, 140	ZBY02321	65, 141	ZBY2178	62, 138, 201	ZBY41101	66, 142, 201
ZBVJ1	49, 123	ZBY02126	64, 140	ZBY02322	65, 141	ZBY2179	62, 138	ZBY42101	66, 142, 201
ZBVJ15	50, 124	ZBY02127	64, 140	ZBY02323	65, 141	ZBY2184	62, 138	ZBY44101	66, 142, 201
ZBVJ3	49, 123	ZBY02128	64, 140	ZBY02326	65, 141	ZBY2185	62, 138	ZBY45101	66, 142, 201
ZBVJ35	50, 124	ZBY02129	64, 140	ZBY02327	65, 141	ZBY2186	62, 138	ZBY4H101	62, 138
ZBVJ4	49, 123	ZBY02130	64, 140	ZBY02328	65, 141	ZBY2195	62, 138	ZBY5100	66, 142
ZBVJ45	50, 124	ZBY02131	64, 140	ZBY02330	65, 141	ZBY2196	62, 138	ZBY5140	66, 142
ZBVJ5	49, 123	ZBY02132	64, 140	ZBY02334	65, 141	ZBY2197	62, 138	ZBY55130	66, 142
ZBVJ55	50, 124	ZBY02133	64, 140	ZBY02364	65, 141	ZBY2198	62, 138	ZBY55330	66, 142
ZBVJ6	49, 123	ZBY02134	64, 140	ZBY02366	65, 141	ZBY2199	62, 138	ZBY6101	66, 142
ZBVJ65	50, 124	ZBY02135	64, 140	ZBY02367	65, 141	ZBY2203	63, 139	ZBY6102	66, 142
ZBVM1	49, 123	ZBY02146	64, 140	ZBY02385	65, 141	ZBY2204	63, 139	ZBY6140	66, 142
ZBVM14	53, 127	ZBY02147	64, 140	ZBY02387	65, 141	ZBY2205	63, 139	ZBY61101	66, 142, 201
ZBVM15	50, 124	ZBY02148	64, 140	ZBY02931	64, 140	ZBY2206	63, 139	ZBY62101	66, 142, 201
ZBVM3	49, 123	ZBY02164	64, 140	ZBY0501	66, 142	ZBY2207	63, 139	ZBY64101	66, 142, 201
ZBVM34	53, 127	ZBY02165	64, 140	ZBY0502	66, 142	ZBY2208	63, 139	ZBY65101	66, 142, 201
ZBVM35	50, 124	ZBY02166	64, 140	ZBY1101	67, 143	ZBY2209	63, 139	ZBY6H101	66, 142
ZBVM4	49, 123	ZBY02167	64, 140	ZBY1103	67, 143	ZBY2210	63, 139	ZBY6H102	66, 142
ZBVM44	53, 127	ZBY02178	64, 140	ZBY1104	67, 143	ZBY2211	63, 139	ZBY8101	67, 143, 201
ZBVM45	50, 124	ZBY02179	64, 140	ZBY1105	67, 143	ZBY2212	63, 139	ZBY8130	67, 143, 201
ZBVM5	49, 123	ZBY02184	64, 140	ZBY1106	67, 143	ZBY2213	63, 139	ZBY8140	67, 143
ZBVM54	53, 127	ZBY02185	64, 140	ZBY1107	67, 143	ZBY2214	63, 139	ZBY8160	67, 143
ZBVM55	50, 124	ZBY02186	64, 140	ZBY1108	67, 143	ZBY2223	63, 139	ZBY8230	67, 143
ZBVM6	49, 123	ZBY02195	64, 140	ZBY1115	67, 143	ZBY2226	63, 139	ZBY8260	67, 143
ZBVM64	53, 127	ZBY02196	64, 140	ZBY1116	67, 143	ZBY2227	63, 139	ZBY8330	67, 143, 201
ZBVM65	50, 124	ZBY02197	64, 140	ZBY1146	67, 143	ZBY2228	63, 139	ZBY8360	67, 143, 201
<b>ZBW</b>		ZBY02198	64, 140	ZBY1147	67, 143	ZBY2229	63, 139	ZBY8430	67, 143
ZBW911	61, 137	ZBY02199	64, 140	ZBY1148	67, 143	ZBY2230	63, 139	ZBY8460	67, 143
ZBW9113	61, 137	ZBY02203	65, 141	ZBY1149	67, 143	ZBY2231	63, 139	ZBY8630	67, 143
ZBW913	61, 137	ZBY02204	65, 141	ZBY1203	67, 143	ZBY2232	63, 139	ZBY8660	67, 143
ZBW9133	61, 137	ZBY02205	65, 141	ZBY1204	67, 143	ZBY2233	63, 139	ZBY9101	67, 143, 201
ZBW914	61, 137	ZBY02206	65, 141	ZBY1207	67, 143	ZBY2234	63, 139	ZBY9101T	68, 144
ZBW9143	61, 137	ZBY02207	65, 141	ZBY1208	67, 143	ZBY2235	63, 139	ZBY9130	67, 143
ZBW915	61, 137	ZBY02208	65, 141	ZBY1214	67, 143	ZBY2242000	63, 139	ZBY9130T	68, 144
ZBW9153	61, 137	ZBY02209	65, 141	ZBY1303	67, 143	ZBY2265	63, 139	ZBY9140	67, 143, 201
ZBW916	61, 137	ZBY02210	65, 141	ZBY1304	67, 143	ZBY2266	63, 139	ZBY9140T	68, 144
ZBW9163	61, 137	ZBY02211	65, 141	ZBY1311	67, 143	ZBY2267	63, 139	ZBY9160	67, 143
ZBW917	61, 137	ZBY02212	65, 141	ZBY1312	67, 143	ZBY2284	63, 139	ZBY9160T	68, 144
ZBW931	61, 137	ZBY02213	65, 141	ZBY1316	67, 143	ZBY2295	63, 139	ZBY9230	67, 143
ZBW9313	61, 137	ZBY02214	65, 141	ZBY1912	67, 143	ZBY2297	63, 139	ZBY9230T	68, 144
ZBW933	61, 137	ZBY02223	65, 141	ZBY2101	62, 138, 201	ZBY2298	63, 139	ZBY9260	67, 143
ZBW9333	61, 137	ZBY02226	65, 141	ZBY2103	62, 138	ZBY2299	63, 139, 201	ZBY9260T	68, 144
ZBW934	61, 137	ZBY02227	65, 141	ZBY2104	62, 138	ZBY2303	63, 139	ZBY9330	67, 143, 201
ZBW9343	61, 137	ZBY02228	65, 141	ZBY2105	62, 138	ZBY2304	62, 138, 201	ZBY9330T	68, 144
ZBW935	61, 137	ZBY02229	65, 141	ZBY2106	62, 138	ZBY2305	63, 139, 201	ZBY9360	67, 143, 201



---

ZBY9360T	68, 144
ZBY9430	67, 143
ZBY9460	67, 143
ZBY9630	67, 143
ZBY9660	67, 143
<b>ZBZ</b>	
ZBZ001	48, 52, 122, 126
ZBZ001	52, 122, 126
ZBZ006	51, 125
ZBZ010	51, 125
ZBZ011	51, 125
ZBZ012	51, 125
ZBZ1600	68, 144
ZBZ1602	68, 144
ZBZ1604	68, 144
ZBZ1606	68, 144
ZBZ2102	68, 144
ZBZ28	36, 68, 110, 144
ZBZ3	201
ZBZ32	62, 138, 201
ZBZ33	66, 142
ZBZ34	62, 138
ZBZ35	66, 142
ZBZ3605	68, 144
ZBZ48	36, 68, 110, 144
ZBZ58	36, 68, 110, 144
ZBZ8	70, 146
ZBZG156	49, 123
ZBZM156	49, 123
ZBZVG	49, 123
ZBZVM	49, 123
<b>ZD4</b>	
ZD4PA103	47
ZD4PA12	47
ZD4PA14	47
ZD4PA203	47
ZD4PA22	47
ZD4PA24	47
<b>ZD5</b>	
ZD5PA103	121
ZD5PA12	121
ZD5PA14	121
ZD5PA203	121
ZD5PA22	121
ZD5PA24	121







[www.schneider-electric.com](http://www.schneider-electric.com)

**Schneider Electric USA, Inc.**

8001 Knightdale Blvd.  
Knightdale, NC 27545

USA Customer Care Center  
Tel: 888-778-2733

**Schneider Electric Canada**

5985 McLaughlin Rd.  
Mississauga, Ontario, Canada L5R 1B8

Canada Customer Care Center  
Tel: 800-565-6699

The information and dimensions in this catalog are provided for the convenience of our customers. While this information is believed to be accurate, Schneider Electric reserves the right to make updates and changes without prior notification and assumes no liability for any errors or omissions.

Harmony, Schneider Electric and logo are trademarks or registered trademarks of Schneider Electric or its affiliates in the United States and other countries. Other trademarks used herein are the property of their respective owners.

Design: Schneider Electric  
Photos: Schneider Electric





2014

Harmony™ XB4/XB5/XB7 22 mm push buttons

