



Your problem: Today, you need a time-delay power fuse that can handle normal surges. Tomorrow, it's a power fuse with a high interrupting rating and the added security of rejection dimensions. The day after that, one of those economical one-time power fuses will do the trick. And what if you need to provide fuses for a global solution? Where do you turn?

Our solution: Mersen's comprehensive power fuse offering covers a complete range of applications and a complete range of circuit-protection needs. Whether it's the characteristics of our Tri-Onic® Time-delay fuses, the high current-limiting capacity of our original Amp-Trap® power fuses, the cost-efficient protection of our One-Time fuses, or any of our complete line of North American and European fuses, Mersen has the fuse you need.

Want more information fast? For more technical or application-specific information, please call our power fuse experts at 978-465-4853 or visit our website at ep.mersen.com.

UL/CSA Listed Power Fuses

THE MOST POPULAR
UL/CSA LISTED
POWER FUSES TO
MEET THE MOST
POPULAR PROTECTION
PRIORITIES

Class L

- A4BQ PF 2
- A4BY PF 4
- A4BT PF 6

Class RK1

- A2D-R & A6D-R PF 8
- A2K-R & A6K-R PF 10

Class RK5

- TR-R & TRS-R PF 12
- TRS-RDC PF 14

Class J

- AJT PF 16
- AJT Reducer Fuses PF 18
- HSJ PF 20
- A4J PF 22

Class CC

- ATDR PF 24
- ATQR PF 26
- ATMR PF 28

Class G

- AG PF 29

Class K-5

- OT/OTN/OTS PF 30

Class T

- A3T & A6T PF 32

Canadian Fuses

- Class C PF 34
- Class H NRN/NRS PF 36
- Class H CRN/CRS PF 37

Accessories

- Fuse Pullers/Clip Clamps... PF 38



A4BQ

Time Delay/Class L

UL/CSA LISTED POWER FUSES

PUT THE HIGHEST CURRENT-LIMITATION...
AT YOUR SERVICE



Amp-Trap 2000® A4BQ fuses are 20% more current-limiting than any other Class L fuse on the market. When correctly coordinated, they bring a superior level of protection to service entrance equipment. Downstream circuit components have maximum protection against short circuit let-thru current. A4BQ's built-in, 4-second time-delay characteristic (at 500% of rated current) accommodates harmless inrush currents without nuisance opening.

FEATURES/BENEFITS:

- Fastest operation under short circuit conditions: Let-thru currents are typically 20% lower, with a corresponding let-thru energy (clearing I^2t) up to 40% lower than the next fastest Class L fuse
- Time-delay for high inrush loads such as motors and transformers, without nuisance opening
- 300kA interrupting rating - self-certified, UL witnessed tests
- Most current-limiting for lowest peak let-thru current; even at fault currents up to 300kA
- Recommended for Arc Flash energy reduction
- Pure silver links ensure lowest let-thru current and longer fuse life
- Easy 2-to-1 selectivity for prevention of nuisance shutdowns and "blackouts"
- Rejection-style design prevents replacement errors
- High-visibility orange label gives instant brand recognition
- Reduced inventory because A4BQ can replace all older types of Class L fuses now in-service (continued on next page)

RATINGS:

Volts: 600VAC, 500VDC

Amps: AC - 100 to 6000A,
DC - 100 to 3000A

IR: 200kA I.R. AC, 100kA
I.R. DC (Self-certified for
600VAC, 300kA I.R., UL
witnessed).

APPLICATIONS:

- Mains
- Feeders
- Large motors
- Lighting, heating & general loads
- Circuit breaker back-up
- DC rated: UPS DC links, battery disconnects, other DC applications

APPROVALS:

A4BQ (100-6000)

- UL listed to standard 248-10 File E2137
- DC listed to UL standard 248 (100-2000A)
- CSA certified to standard C22.2 No. 248.10 (601-6000A)

A4BQ (100-6000) - TA

- UL listed



FEATURES/BENEFITS (CONTINUED):

- Metal-embossed date and catalog number for traceability and lasting identification
- Fiberglass body provides dimensional stability in harsh industrial settings
- High-grade silica filler ensures fast arc quenching
- Optional mechanical TA indicator (100-6000A). Please contact factory for special trigger actuator

CATALOG NUMBERS (AMPS) RECOMMENDED FUSE BLOCKS FOR AMP-TRAP® CLASS L FUSES

A4BQ100	A4BQ500	A4BQ1000	A4BQ2000
A4BQ150	A4BQ600	A4BQ1200	A4BQ2500
A4BQ200	A4BQ601	A4BQ1350	A4BQ2501
A4BQ250	A4BQ650	A4BQ1400	A4BQ3000
A4BQ300	A4BQ700	A4BQ1500	A4BQ3500
A4BQ350	A4BQ750	A4BQ1600	A4BQ3800
A4BQ400	A4BQ800	A4BQ1800	A4BQ4000
A4BQ450	A4BQ900	A4BQ1900	A4BQ5000
			A4BQ6000

Fuse Ampere Rating	Catalog Number 600V or Less 3 Pole
100-800	P48F
801-1200	P412F

Catalog number P48F is UL recognized
Catalog number P412F is self-certified

Note: For remote blown fuse trigger actuator option add "-TA" to end of catalog number. Example: A4BQ1600-TA

DIMENSIONS

Ampere Rating	A		B		C		D		E	
	in	mm	in	mm	in	mm	in	mm	in	mm
100-600	8-5/8	219	2	51	5/16	8	1-5/8	41	2-13/32	61
601-800	8-5/8	219	2-1/2	63	3/8	9	2	51	2-13/32	61
801-1200	10-3/4	273	2-1/2	63	3/8	9	2	51	3-15/32	88
1201-1600	10-3/4	273	3	76	7/16	11	2-3/8	60	3-15/32	88
1601-2000	10-3/4	273	3-1/2	89	1/2	12	2-3/4	70	3-15/32	88
2001-2500	10-3/4	273	4-1/2	114	3/4	19	3-1/2	89	3-15/32	88
2501-3000	10-3/4	273	5	127	3/4	19	4	102	3-15/32	88
3001-4000	10-3/4	273	5-3/4	146	3/4	19	4-3/4	121	3-15/32	88
4001-5000	10-3/4	273	6-1/4	159	1	25	5-1/4	133	3-15/32	88
5001-6000	10-3/4	273	7-1/8	181	1	25	5-3/4	146	3-15/32	88

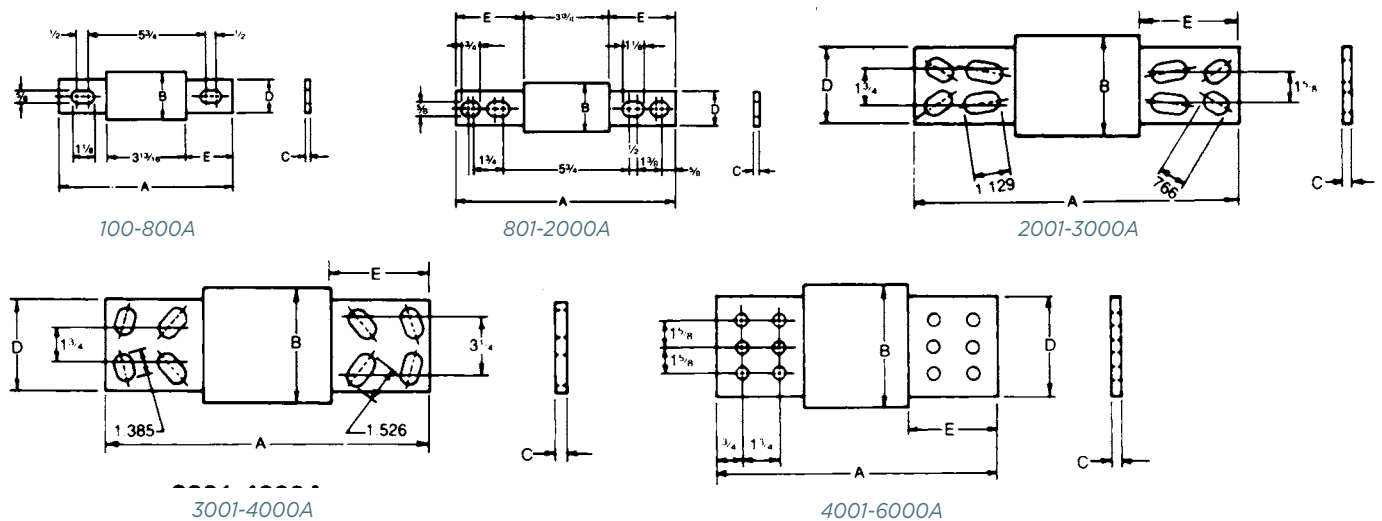

Safety Note: Class L fuses are dimensioned for one-way interchangeability.
A Class L fuse of any lower ampere rating can be substituted for a given Class L fuse.

A4BY

Class L

UL/CSA LISTED POWER FUSES

COUNT ON THE HIGH INTERRUPTING RATING
OF OUR MOST WIDELY USED CLASS L FUSE



When it comes to protecting service entrance equipment, feeder circuits, and circuit breakers, A4BY fuses are the industry's favorite. The A4BY is a 100% rated device and may be applied at continuous currents up to its ampere rating. A 4-second minimum time-delay at 500% rating allows the A4BY to pass normal current surges and to coordinate with ground fault relays.

FEATURES/BENEFITS:

- Unique dimensions prevent replacement by other fuse classes
- Blade stamped catalog numbers for permanent identification
- Glass melamine body and plated terminals provide superior reliability in harsh environments

RATINGS:

- **Volts:** 600VAC, 300VDC
- **Amps:** 200 to 6,000A (AC), 200 to 2,500A (DC)
- **IR:** 200kA.I.R. AC, 100kA I.R. DC

HIGHLIGHTS:

- Current-limiting
- 4-second time-delay
- DC ratings
- Uniform characteristics in all ampere ratings

APPLICATIONS:

- Mains, feeders
- Circuit breakers
- Load centers
- Panelboards
- Switchboards
- Metering centers

APPROVALS:

- UL listed to standard 248-10 (601-6000A) File E2137
- CSA certified to standard C22.2 No. 248.10 (601-6000A)
- Self-certified for DC per UL248 (601-6000A)



CATALOG NUMBERS (AMPS)

A4BY200	A4BY700	A4BY1350	A4BY2500
A4BY250	A4BY750	A4BY1400	A4BY3000
A4BY300	A4BY800	A4BY1500	A4BY3001
A4BY350	A4BY801	A4BY1600	A4BY3500
A4BY400	A4BY900	A4BY1601	A4BY4000
A4BY450	A4BY1000	A4BY1800	A4BY4001
A4BY500	A4BY1100	A4BY2000	A4BY4500
A4BY600	A4BY1200	A4BY2001	A4BY5000
A4BY601	A4BY1201	A4BY2200	A4BY6000
A4BY650			

Note: For optional blown fuse trigger indicator add "-TI" to the end of part number.
Example: A4BY1600-TI. Consult factory for availability.

RECOMMENDED FUSE BLOCKS FOR AMP-TRAP® CLASS L FUSES

Fuse Ampere Rating	Catalog Number 600V or Less 3-Pole
100-800	P48F
801-1200	P412F

Catalog number P48F is UL recognized
Catalog number P412F is self-certified

A variety of pole configurations and termination provisions are available. Refer to Section FB for details.

DIMENSIONS

Ampere Rating	A		B		C		D		E	
	in	mm	in	mm	in	mm	in	mm	in	mm
200-600	8-5/8	219	2	51	5/16	8	1-5/8	41	2-13/32	61
601-800	8-5/8	219	2-1/2	63	3/8	9	2	51	2-13/32	61
801-1200	10-3/4	273	2-1/2	63	3/8	9	2	51	3-15/32	88
1201-1600	10-3/4	273	3	76	7/16	11	2-3/8	60	3-15/32	88
1601-2000	10-3/4	273	3-1/2	89	1/2	13	2-3/4	70	3-15/32	88
2001-2500	10-3/4	273	4-1/2	114	3/4	19	3-1/2	89	3-15/32	88
2501-3000	10-3/4	273	5	127	3/4	19	4	102	3-15/32	88
3001-4000	10-3/4	273	5-3/4	146	3/4	19	4-3/4	121	3-15/32	88
4001-5000	10-3/4	273	6-1/4	159	1	25	5-1/4	133	3-15/32	88
5001-6000	10-3/4	273	7-1/8	181	1	25	5-3/4	146	3-15/32	88

Safety Note: Class L fuses are dimensioned for one-way interchangeability.
A Class L fuse of any lower ampere rating can be substituted for a given Class L fuse.

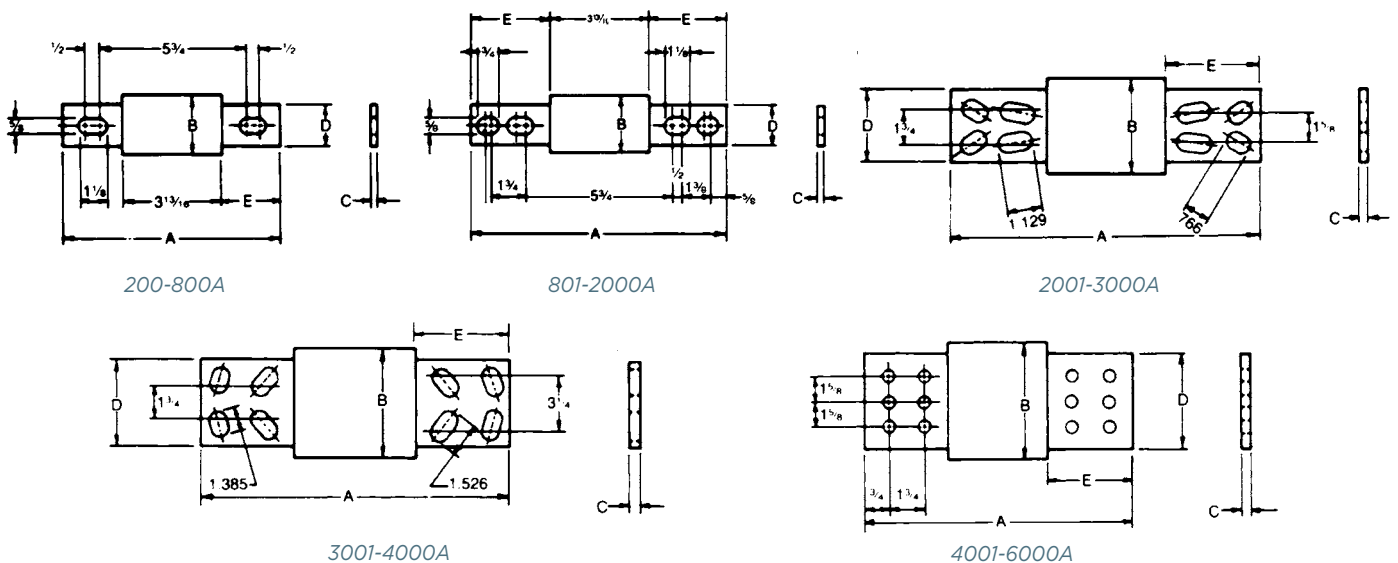

A4BT

Time Delay/Class L

UL/CSA LISTED POWER FUSES

WHEN YOUR HEAVIER LOADS NEED PROTECTION,
A4BT FUSES WON'T LET YOU DOWN



The high interrupting rating of A4BT current-limiting fuses is ideally suited for protecting mains, feeders, and general circuits. The 10-second time-delay at 500% of fuse rating is ideal for large motors and other loads with a high inrush. A4BT fuses are suitable for DC applications up to 500VDC. An A4BT fuse can be applied to normal loads up to its full ampere rating to allow 100% rating of equipment, while also providing superior current-limiting ability.

FEATURES/BENEFITS:

- Unique dimensions prevent replacement by other fuse classes.
- Blade-stamped catalog numbers for permanent identification
- Glass melamine body and plated terminals provide superior reliability in harsh environments

RATINGS:

- **Volts:** 600VAC, 500VDC
- **Amps:** 200 to 2,000A
- **IR:** 200kA I.R. AC, 100kA I.R. DC

HIGHLIGHTS:

- Current-limiting
- Full 10-second delay
- DC ratings
- Uniform characteristics in all ampere ratings

APPLICATIONS:

- Motors
- Motor controllers
- Transformers
- Mains
- Feeders

APPROVALS:

- UL Listed to standard 248-10 (601-2000A) File E2137
- CSA Certified to standard C22.2 No. 248.10 (601-2000A)
- Self-certified for DC per UL248 (601-2000)



CATALOG NUMBERS (AMPS)

A4BT200	A4BT500	A4BT800	A4BT1400
A4BT250	A4BT600	A4BT900	A4BT1500
A4BT300	A4BT601	A4BT1000	A4BT1600
A4BT350	A4BT650	A4BT1100	A4BT1800
A4BT400	A4BT700	A4BT1200	A4BT2000
A4BT450	A4BT750		

RECOMMENDED FUSE BLOCKS
FOR AMP-TRAP® CLASS L FUSES

Fuse Ampere Rating	Catalog Number 600V or Less 3-Pole
100-800	P48F
801-1200	P412F

Catalog number P48F is UL recognized
Catalog number P412F is self-certified

A variety of pole configurations and termination provisions are available. Refer to Section FB for details.

DIMENSIONS

Ampere Rating	A		B		C		D		E	
	in	mm	in	mm	in	mm	in	mm	in	mm
200-600	8-5/8	219	2	51	5/16	8	1-5/8	41	2-13/32	61
601-800	8-5/8	219	2-1/2	63	3/8	9	2	51	2-13/32	61
801-1200	10-3/4	273	2-1/2	63	3/8	9	2	51	3-15/32	88
1201-1600	10-3/4	273	3	76	7/16	11	2-3/8	60	3-15/32	88
1601-2000	10-3/4	273	3-1/2	89	1/2	13	2-3/4	70	3-15/32	88

Safety Note: Class L fuses are dimensioned for one-way interchangeability.
A Class L fuse of any lower ampere rating can be substituted for a given Class L fuse.

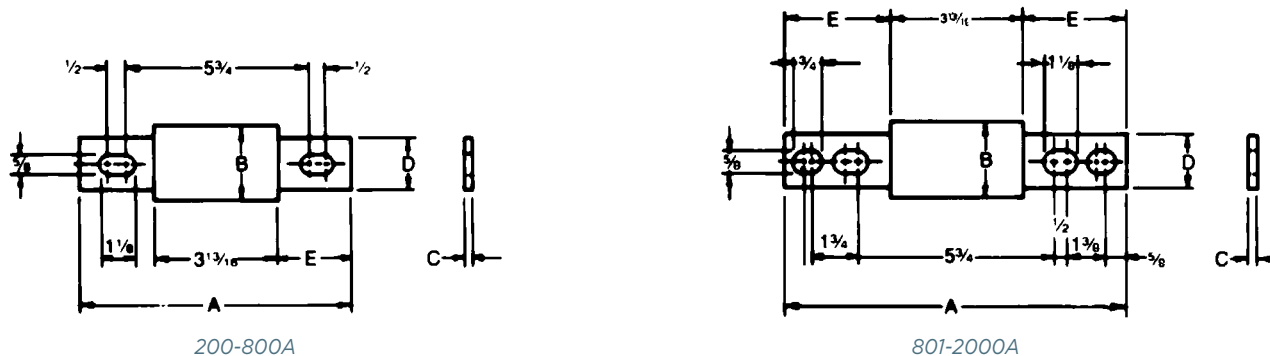

A2D-R & A6D-R

Time Delay/Class RK1

UL/CSA LISTED POWER FUSES

UPGRADE YESTERDAY'S CIRCUITS TO
TODAY'S TYPE 2 PROTECTION



The Amp-Trap 2000® SmartSpot® A2D-R and A6D-R fuses feature a visual open fuse indicator and provide IEC Type 2 No Damage protection to main, feeder, and branch circuits for all types of loads. With time-delay characteristics for handling harmless inrush currents, current-limiting ability and a wide range of ratings (from 1 to 600 Amperes), A2D-R and A6D-R fuses give excellent protection for all your applications.

FEATURES/BENEFITS:

- Solid state SmartSpot visual blown fuse indicator
- Time-delay for motor starting and transformer inrush currents without nuisance opening
- 600VAC & 600VDC dual rated
- 300kA interrupting rating - self-certified, UL witnessed tests
- Extremely current-limiting for low peak let-thru current
- Recommended for Arc Flash energy reduction
- Easy 2-to-1 selectivity for prevention of nuisance shut downs and “black outs”
- Rejection-style design prevents replacement errors (when used with recommended fuse blocks)
- High-visibility orange label gives instant brand recognition
- Reduced inventory by taking the place of class RK5, K, and H fuses
- Metal-embossed date and catalog number for easier traceability and lasting identification
- Fiberglass body provides dimensional stability in harsh industrial settings

RATINGS:

A2D-R

Volts: 250VAC/DC

Amps: 1/10 to 600A (AC),
15 to 600A (DC)

IR: 200kA I.R. AC,
100kA I.R. DC

A6D-R

Volts: 600VAC/DC

Amps: 1/10 to 600A

IR: 200kA I.R. AC, 100kA I.R.
DC (Self-certified for 300kA
I.R., UL witnessed.)

APPLICATIONS:

- Motors
- Safety switches
- Transformers
- Branch circuit protection
- Disconnects
- Control panels
- All general-purpose circuits

Note: See motor fuse applications tables on page P7

APPROVALS:

- UL listed to standard 248-12 File E2137
- DC listed to UL standard 248
- CSA certified to standard C22.2 No. 248.12



CATALOG NUMBERS (AMPS)

250V			600V		
A2D1/10R	A2D3-1/2R	A2D50R	A6D1/10R	A6D3-1/2R	A6D50R
A2D15/100R	A2D4R	A2D60R	A6D15/100R	A6D4R	A6D60R
A2D2/10R	A2D4-1/2R	A2D70R	A6D2/10R	A6D4-1/2R	A6D70R
A2D3/10R	A2D5R	A2D75R	A6D3/10R	A6D5R	-
A2D4/10R	A2D5-6/10R	A2D80R	A6D4/10R	A6D5-6/10R	A6D80R
A2D1/2R	A2D6R	A2D90R	A6D1/2R	A6D6R	A6D90R
A2D6/10R	A2D6-1/4R	A2D100R	A6D6/10R	A6D6-1/4R	A6D100R
A2D8/10R	A2D7R	A2D110R	A6D8/10R	A6D7R	A6D110R
A2D1R	A2D8R	A2D125R	A6D1R	A6D8R	A6D125R
A2D1-1/8R	A2D9R	A2D150R	A6D1-1/8R	A6D9R	A6D150R
A2D1-1/4R	A2D10R	A2D175R	A6D1-1/4R	A6D10R	A6D175R
A2D1-4/10R	A2D12R	A2D200R	A6D1-4/10R	A6D12R	A6D200R
A2D1-6/10R	A2D15R	A2D225R	A6D1-6/10R	A6D15R	A6D225R
A2D1-8/10R	A2D17-1/2R	A2D250R	A6D1-8/10R	A6D17-1/2R	A6D250R
A2D2R	A2D20R	A2D300R	A6D2R	A6D20R	A6D300R
A2D2-1/4R	A2D25R	A2D350R	A6D2-1/4R	A6D25R	A6D350R
A2D2-1/2R	A2D30R	A2D400R	A6D2-1/2R	A6D30R	A6D400R
A2D2-8/10R	A2D35R	A2D450R	A6D2-8/10R	A6D35R	A6D450R
A2D3R	A2D40R	A2D500R	A6D3R	A6D40R	A6D500R
A2D3-2/10R	A2D45R	A2D600R	A6D3-2/10R	A6D45R	A6D600R

Note: SmartSpot visual indicator is not available (1/10-7A)

RECOMMENDED
FUSE BLOCKS WITH
BOX CONNECTORS FOR
AMP-TRAP® CLASS RK1
FUSES

Fuse Ampere Rating	Catalog Number			
	250V or Less		600V or Less	
	1 Pole	3 Pole	1 Pole	3 Pole
0-30	20306R	20308R	60306R	60308R
31-60	20606R	20608R	60606R	60608R
61-100	21036R	21038R	61036R	61038R
101-200	22001R	22003R	62001R	62003R
201-400	24001R	24003R	64001R	64003R
401-600	2631R	2633R	6631R	6633R

A variety of pole configurations and termination provisions are available. Refer to Section FB for details.

DIMENSIONS

Ampere Rating	A		B		C		D		E	
	In	mm	In	mm	In	mm	In	mm	In	mm
250V-A2D										
0-30	2	51	9/16	14	-	-	-	-	-	-
31-60	3	76	13/16	21	-	-	-	-	-	-
61-100	5-7/8	149	1-1/16	27	1/8	3	3/4	19	1	25
101-200	7-1/8	181	1-9/16	40	3/16	5	1-1/8	28	1-3/8	35
201-400	8-5/8	219	2-1/16	53	1/4	6	1-5/8	41	1-7/8	48
401-600	10-3/8	264	2-9/16	66	1/4	6	2	51	2-1/4	57
600V-A6D										
0-30	5	127	13/16	21	-	-	-	-	-	-
31-60	5-1/2	139	1-1/16	27	-	-	-	-	-	-
61-100	7-7/8	200	1-5/16	34	1/8	3	3/4	19	1	25
101-200	9-5/8	244	1-13/16	46	3/16	5	1-1/8	28	1-3/8	35
201-400	11-5/8	295	2-9/16	66	1/4	6	1-5/8	41	1-7/8	48
401-600	13-3/8	340	3-1/8	80	1/4	6	2	51	2-1/4	57

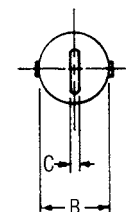
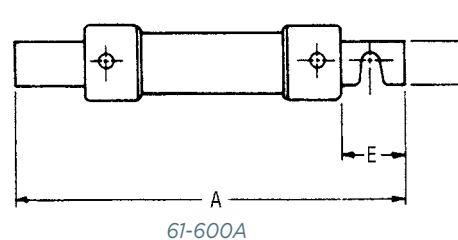
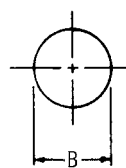
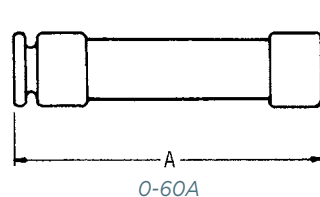

A2K-R & A6K-R

Fast Acting/Class RK1

UL/CSA LISTED POWER FUSES

THESE FAST-ACTING FUSES DELIVER A HIGH DEGREE OF CURRENT LIMITATION WHERE YOU NEED IT MOST



Current-limiting A2K and A6K fuses provide excellent protection where high available short circuit currents exist. These fast-acting fuses are particularly good for branch/feeder circuits and back-up protection.

FEATURES/BENEFITS:

- Rejection style design prevents replacement by other fuse classes
- Fiberglass body provides dimensional stability in harsh industrial environments
- Easy-to-read imprint label for quick recognition and replacement
- High degree of current limitation for low peak let-thru current

RATINGS:

A2K

- **Volts:** 250VAC / DC
- **Amps:** 1 to 600A
- **IR:** 200kA I.R. AC, 20kA I.R. DC

A6K

- **Volts:** 600VAC / 300VDC
- **Amps:** 1 to 600A
- **IR:** 200kA I.R. AC, 20kA I.R. DC

HIGHLIGHTS

- Highly current-limiting
- Fast-acting
- Rejection style

APPLICATIONS:

- Loadcenters
- Panelboards
- Switchboards
- Bus duct
- Feeder circuits
- Non-inductive loads
- Lighting circuits

APPROVALS:

- UL listed to standard 248-12 File E2137
- CSA certified to standard C22.2 No. 248.12
- Self-certified for DC per UL248



CATALOG NUMBERS (AMPS)

250V			600V		
A2K1R	A2K35R	A2K175R	A6K1R	A6K35R	A6K175R
A2K3R	A2K40R	A2K200R	A6K3R	A6K40R	A6K200R
-	A2K45R	A2K225R	A6K4R	A6K45R	A6K225R
A2K5R	A2K50R	A2K250R	A6K5R	A6K50R	A6K250R
A2K6R	A2K60R	A2K300R	A6K6R	A6K60R	A6K300R
-	A2K70R	A2K350R	A6K8R	A6K70R	A6K350R
A2K10R	A2K80R	A2K400R	A6K10R	A6K80R	A6K400R
A2K15R	A2K100R	A2K500R	A6K15R	A6K100R	A6K500R
A2K20R	A2K110R	A2K600R	A6K20R	A6K110R	A6K600R
A2K25R	A2K125R		A6K25R	A6K125R	
A2K30R	A2K150R		A6K30R	A6K150R	

RECOMMENDED FUSE BLOCKS
WITH BOX CONNECTORS FOR
AMP-TRAP® CLASS RK1 FUSES

Fuse Ampere Rating	Catalog Number			
	250V		600V	
	1-Pole	3-Pole	1-Pole	3-Pole
0-30	20306R	20308R	60306R	60308R
31-60	20606R	20608R	60606R	60608R
61-100	21036R	21038R	61036R	61038R
101-200	22001R	22003R	62001R	62003R
201-400	24001R	24003R	64001R	64003R
401-600	2631R	2633R	6631R	6633R

A variety of pole configurations and termination provisions are available. Refer to Section FB for details.

DIMENSIONS

Ampere Rating	A		B		C		D		E	
	in	mm	in	mm	in	mm	in	mm	in	mm
250V-A2K Fuses										
0-30	2	51	9/16	14	-	-	-	-	-	-
31-60	3	76	13/16	21	-	-	-	-	-	-
61-100	5-7/8	149	1-1/16	27	1/8	3	3/4	19	1	25
101-200	7-1/8	181	1-9/16	40	3/16	5	1-1/8	28	1-3/8	35
201-400	8-5/8	219	2-1/16	53	1/4	6	1-5/8	41	1-7/8	48
401-600	10-3/8	264	2-9/16	66	1/4	6	2	51	2-1/4	57
600V-A6K Fuses										
0-30	5	127	13/16	21	-	-	-	-	-	-
31-60	5-1/2	139	1-1/16	27	-	-	-	-	-	-
61-100	7-7/8	200	1-5/16	34	1/8	3	3/4	19	1	25
101-200	9-5/8	244	1-13/16	46	3/16	5	1-1/8	28	1-3/8	35
201-400	11-5/8	295	2-9/16	66	1/4	6	1-5/8	41	1-7/8	48
401-600	13-3/8	340	3-1/8	80	1/4	6	2	51	2-1/4	57

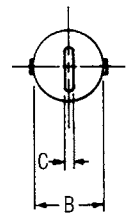
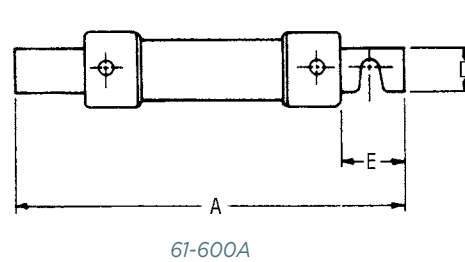
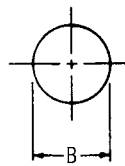
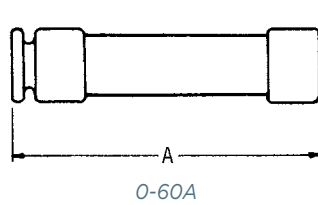

TR-R & TRS-R

Time Delay/Class RK5

UL/CSA LISTED POWER FUSES

THE INDUSTRY'S MOST POPULAR FUSE
FOR MOTOR CIRCUIT PROTECTION



With advanced material technology added to the existing product, the Tri-Onic® TR and TRS current-limiting time-delay fuses are engineered for overcurrent protection of motors and transformers, service entrance equipment, feeder and branch circuits. Tri-Onic fuse's proven time-delay characteristic safely handles harmless starting currents and inrush currents associated with today's motors and transformers. Now available with optional SmartSpot® blown fuse indication technology.

FEATURES/BENEFITS:

- Time-delay
- Current-limiting
- AC & DC rated
- Optional solid state SmartSpot blown fuse indicator
- Time-delay for motor start-ups and transformer inrush currents without nuisance opening
- Current-limiting for low peak let-thru current
- Rejection-style design prevents replacement errors (when used with recommended fuse blocks)
- Easy-to-read label for quick brand recognition and replacement
- Metal-embossed date and catalog number for traceability and lasting identification
- Fiberglass body provides dimensional stability in harsh industrial settings
- High-grade silica filler ensures fast arc quenching and high current limitation

RATINGS:

TR-R

- **Volts:** 250VAC;
250VDC (.1-2.8A; 35-400A);
160VDC (3-30A; 450-600A)
- **Amps:** 1/10 to 600A
- **IR:** 200kA I.R. AC / 20kA I.R. DC

TRS-R

- **Volts:** 600VAC;
600VDC (.1-12A; 70-600A);
300VDC (15-60A)
- **Amps:** 1/10 to 600A
- **IR:** 200kA I.R. AC; 1/10A to 60A
-> 20kA I.R. DC; 70A to 600A
-> 100kA I.R. DC

APPLICATIONS:

- Motor circuits
- Mains
- Feeders
- Branch circuits
- Transformers
- Service entrance equipment
- General-purpose equipment

APPROVALS:

- UL listed to standard 248-12
File E2137
- CSA certified to standard
C22.2 no. 248.12
- DC listed to UL standard
248 TRS only



CATALOG NUMBERS (AMPS)

250V			600V		
TR1/10R*	TR3-1/2R*	TR50R	TRS1/10R*	TRS3-1/2R*	TRS50R
TR15/100R*	TR4R*	TR60R	TRS15/100R*	TRS4R*	TRS60R
TR2/10R*	TR4-1/2R*	TR70R	TRS2/10R*	TRS4-1/2R*	TRS70R
TR3/10R*	TR5R*	TR75R*	TRS3/10R*	TRS5R*	TRS75R*
TR4/10R*	TR5-6/10R*	TR80R	TRS4/10R*	TRS5-6/10R*	TRS80R
TR1/2R*	TR6R*	TR90R	TRS1/2R*	TRS6R*	TRS90R
TR6/10R*	TR6-1/4R*	TR100R	TRS6/10R*	TRS6-1/4R*	TRS100R
TR8/10R*	TR7R*	TR110R	TRS8/10R*	TRS7R*	TRS110R
TR1R*	TR8R	TR125R	TRS1R*	TRS8R	TRS125R
TR1-1/8R*	TR9R	TR150R	TRS1-1/8R*	TRS9R	TRS150R
TR1-1/4R*	TR10R	TR175R	TRS1-1/4R*	TRS10R	TRS175R
TR1-4/10R*	TR12R	TR200R	TRS1-4/10R*	TRS12R	TRS200R
TR1-6/10R*	TR15R	TR225R	TRS1-6/10R*	TRS15R	TRS225R
TR1-8/10R*	TR17-1/2R	TR250R	TRS1-8/10R*	TRS17-1/2R	TRS250R
TR2R*	TR20R	TR300R	TRS2R*	TRS20R	TRS300R
TR2-1/4R*	TR25R	TR350R	TRS2-1/4R*	TRS25R	TRS350R
TR2-1/2R*	TR30R	TR400R	TRS2-1/2R*	TRS30R	TRS400R
TR2-8/10R*	TR35R	TR450R	TRS2-8/10R*	TRS35R	TRS450R
TR3R*	TR40R	TR500R	TRS3R*	TRS40R	TRS500R
TR3-2/10R*	TR45R	TR600R	TRS3-2/10R*	TRS45R	TRS600R

RECOMMENDED
FUSE BLOCKS WITH
BOX CONNECTORS FOR
TRI-ONIC® CLASS RK5 FUSES

Fuse Ampere Rating	Catalog Number			
	250V		600V	
	1-Pole	3-Pole	1-Pole	3-Pole
0-30	20306R	20308R	60306R	60308R
31-60	20606R	20608R	60606R	60608R
61-100	21036R	21038R	61036R	61038R
101-200	22001R	22003R	62001R	62003R
201-400	24001R	24003R	64001R	64003R
401-600	2631R	2633R	6631R	6633R

A variety of pole configurations and termination provisions are available. Refer to Section FB for details.

Note: Optional blown fuse visual indication available. To order, place "ID" at the end of the catalog number. Example: #TRS30RID

* Not available with optional blow fuse indicator.

Tin plated end caps are available on Non-ID fuses less than 60A. Example Part # TRP30R, TRSP30R

DIMENSIONS

Ampere Rating	A		B		C		D		E	
	In.	mm	In.	mm	In.	mm	In.	mm	In.	mm
250V-TR Fuses										
0-30	2	51	9/16	14	-	-	-	-	-	-
31-60	3	76	13/16	21	-	-	-	-	-	-
61-100	5-7/8	149	1-1/16	27	1/8	3	3/4	19	1	25
101-200	7-1/8	181	1-9/16	40	3/16	5	1-1/8	28	1-3/8	35
201-400	8-5/8	219	2-1/16	53	1/4	6	1-5/8	41	1-7/8	48
401-600	10-3/8	264	2-9/16	66	1/4	6	2	51	2-1/4	57
600V-TRS Fuses										
0-30	5	127	13/16	21	-	-	-	-	-	-
31-60	5-1/2	139	1-1/16	27	-	-	-	-	-	-
61-100	7-7/8	200	1-5/16	34	1/8	3	3/4	19	1	25
101-200	9-5/8	244	1-13/16	46	3/16	5	1-1/8	28	1-3/8	35
201-400	11-5/8	295	2-9/16	66	1/4	6	1-5/8	41	1-7/8	48
401-600	13-3/8	340	3-1/8	80	1/4	6	2	51	2-1/4	57

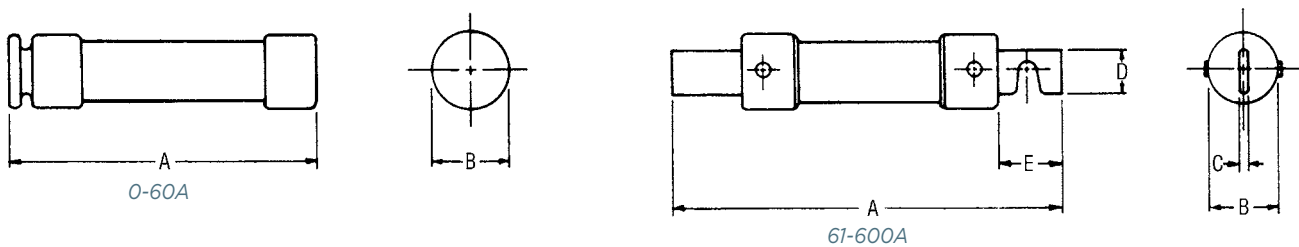

TRS-RDC

Time Delay/Class RK5

UL/CSA LISTED POWER FUSES

DC RATED FOR TOUGH DC APPLICATIONS



The Tri-Onic® DC fuse series is designed for DC circuit protection in surface and underground mines. The TRS-RDC is MSHA approved and meets the industry's most severe third party requirements for 600VDC rated fuses. The TRS-RDC is a time-delay fuse with essentially the same time-current characteristics as the standard Tri-Onic fuse.

FEATURES/BENEFITS:

- DC rated for mine duty and other long time-constant applications
- Time-delay for motor start-ups and high inrush loads without nuisance opening
- Rugged glass melamine body for superior reliability in harsh environments

RATINGS:

- **Volts:** 300VDC (0.1 to 30A); 600VDC (35 to 400A)
- **Amps:** 1/10 to 400A
- **IR:** 20kA I.R. DC

HIGHLIGHTS:

- Time-delay
- DC rated

APPLICATIONS:

- Mine circuits
- Trailing cables
- Pump motors
- Rail heaters

APPROVALS:

- MSHA approval no. 28-26-0

CATALOG NUMBERS (AMPS)

TRS1/10RDC	TRS1-8/10RDC	TRS6-1/4RDC	TRS60RDC
TRS15/100RDC	TRS2RDC	TRS8RDC	TRS70RDC
TRS2/10RDC	TRS2-1/4RDC	TRS9RDC	TRS80RDC
TRS3/10RDC	TRS2-1/2RDC	TRS10RDC	TRS90RDC
TRS4/10RDC	TRS2-8/10RDC	TRS12RDC	TRS100RDC
TRS1/2RDC	TRS3RDC	TRS15RDC	TRS125RDC
TRS6/10RDC	TRS3-2/10RDC	TRS17-1/2RDC	TRS150RDC
TRS8/10RDC	TRS3-1/2RDC	TRS20RDC	TRS175RDC
TRS1RDC	TRS4RDC	TRS30RDC	TRS200RDC
TRS1-1/8RDC	TRS4-1/2RDC	TRS35RDC	TRS250RDC
TRS1-1/4RDC	TRS5RDC	TRS40RDC	TRS300RDC
TRS1-4/10RDC	TRS5-6/10RDC	TRS45RDC	TRS400RDC
TRS1-6/10RDC	TRS6RDC	TRS50RDC	

RECOMMENDED
FUSE BLOCKS WITH
BOX CONNECTORS FOR
TRI-ONIC® CLASS RK5 FUSES

Fuse Ampere Rating	Catalog Number			
	250V		600V	
	1-Pole	3-Pole	1-Pole	3-Pole
0-30	20306R	20308R	60306R	60308R
31-60	20606R	20608R	60606R	60608R
61-100	21036R	21038R	61036R	61038R
101-200	22001R	22003R	62001R	62003R
201-400	24001R	24003R	64001R	64003R

A variety of pole configurations and termination provisions are available. Refer to Section FB for details.

DIMENSIONS

Ampere Rating	A		B		C		D		E	
	In.	mm	In.	mm	In.	mm	In.	mm	In.	mm
0-30	5	127	13/16	21	-	-	-	-	-	-
31-60	5-1/2	139	1-1/16	27	-	-	-	-	-	-
61-100	7-7/8	200	1-5/16	34	1/8	3	3/4	19	1	25
101-200	9-5/8	244	1-13/16	46	3/16	5	1-1/8	28	1-3/8	35
201-400	11-5/8	295	2-9/16	66	1/4	6	1-5/8	41	1-7/8	48

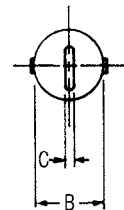
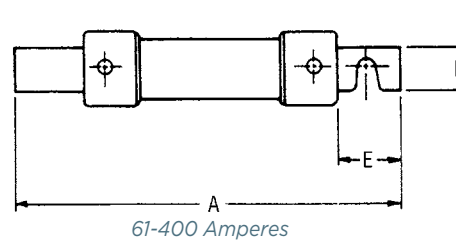
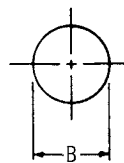
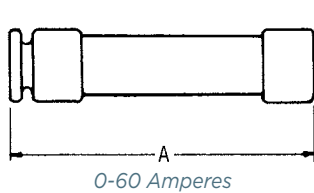

AJT

Time Delay/Class J

UL/CSA LISTED POWER FUSES

SMARTSPOT® WITH MAXIMUM CIRCUIT PROTECTION



Amp-Trap 2000® SmartSpot AJT fuses now provide a visual open fuse indicator. With advanced material technology the AJT fuse provides IEC Type 2 No Damage protection to main, feeder, and branch circuits, for all types of loads – yet, they require only half the mounting space needed for 600VAC Class RK fuses. AJT's time-delay characteristics are ideal for handling typical motor and transformer inrush currents, while also providing superior current-limiting ability.

FEATURES/BENEFITS:

- Solid state SmartSpot visual blown fuse indicator
- Time-delay for motor starting and transformer inrush
- 300kA interrupting rating - self-certified, UL witnessed tests
- Extremely current-limiting for low peak let-thru current
- Most current-limiting UL class fuse
- Recommended for Arc Flash energy reduction
- Small footprint requires less mounting space and allows smaller, more economical fuse blocks
- Easy 2-to-1 selectivity for prevention of nuisance shutdowns
- Unique Class J dimensions prevent replacement errors
- High-visibility orange label gives instant brand recognition
- Metal-embossed date and catalog number for traceability and lasting identification
- Fiberglass body provides dimensional stability in harsh industrial settings
- High-grade silica filler ensures fast arc quenching
- Optional EI indicator/switch mount for AJT70 to 600 open fuse indication

RATINGS:

- **Volts:** 600VAC or less, 500VDC or less
- **Amps:** 1 to 600A
- **IR:** 200kA I.R. AC, 100kA I.R. DC (Self-certified for 600VAC, 300kA I.R., UL witnessed).

APPLICATIONS:

- Motor circuits
- Mains
- Feeders
- Branch circuits
- Lighting, heating & general loads
- Transformers
- Control panels
- Circuit breaker back-up
- Bus duct
- Load centers

APPROVALS:

AJT (1-600):

- UL listed to standard 248-8 File E2137
- DC listed to UL standard 248
- CSA certified to standard C22.2 No. 248.8
- IEC 269-2-1

AJT (70-600) EI:

- UL listed
- DC tested to UL standard 248



CATALOG NUMBERS (AMPS)

AJT1	AJT4-1/2	AJT25	AJT125
AJT1-1/4	AJT5	AJT30	AJT150
AJT1-1/2	AJT5-6/10	AJT35	AJT175
AJT1-6/10	AJT6	AJT40	AJT200
AJT1-8/10	AJT6-1/4	AJT45	AJT225
AJT2	AJT7	AJT50	AJT250
AJT2-1/4	AJT8	AJT60	AJT300
AJT2-1/2	AJT9	AJT70	AJT350
AJT2-8/10	AJT10	AJT80	AJT400
AJT3	AJT12	AJT90	AJT450
AJT3-2/10	AJT15	AJT100	AJT500
AJT3-1/2	AJT17-1/2	AJT110	AJT600
AJT4	AJT20		

Note: SmartSpot visual indicator is not available (1-7A)

RECOMMENDED FUSE BLOCKS
WITH BOX CONNECTORS FOR
AMP-TRAP® CLASS J FUSES

Fuse Ampere Rating	Catalog Number 600V or Less	
	1 Pole	3 Pole
0-30	US3J1I	US3J3I
31-60	US6J1I	US6J3I
61-100	61036J	61038J
101-200	62001J	62003J
201-400	64031J	64033J
401-600	6631J	6633J

A variety of pole configurations and termination provisions are available. Refer to Section FB for details.

DIMENSIONS

Ampere Rating	A		B		C		D		E		F		G		H	
	in	mm	in	mm	in	mm	in	mm	in	mm	in	mm	in	mm	in	mm
1-30	2-1/4	57	13/16	21	-	-	-	-	-	-	-	-	-	-	-	-
31-60	2-3/8	60	1-1/16	27	-	-	-	-	-	-	-	-	-	-	-	-
61-100	4-5/8	117	1-1/16	27	1/8	3.2	3/4	19	1	25	3-5/8	92	3/8	10	9/32	?
101-200	5-3/4	146	1-5/8	41	3/16	4.8	1-1/8	29	1-3/8	35	4-3/8	111	3/8	10	9/32	?
201-400	7-1/8	181	2-1/8	54	1/4	6.3	1-5/8	41	1-7/8	48	5-1/4	133	17/32	14	13/32	10
401-600	8	203	2-1/2	64	3/8	9.5	2	51	2-1/8	54	6	152	11/16	18	17/32	13

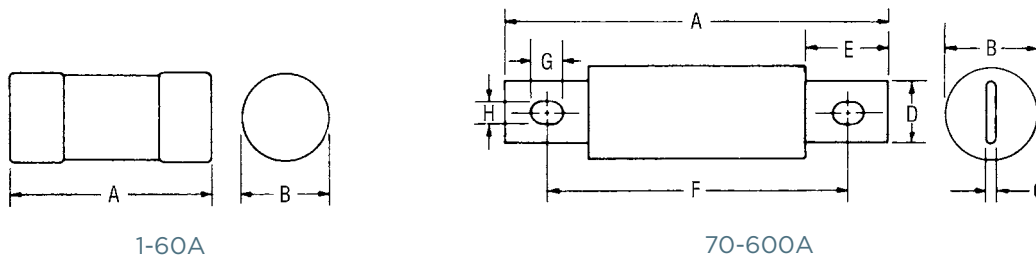

OPTIONAL INDICATOR/MICROSWITCH MOUNT (EI) DIMENSIONS:

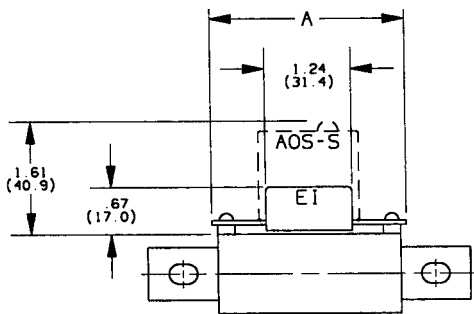

Note: Fuses with the EI option are designed to work with the AOS-S or AOS-Q add-on switch (ordered separately).



Catalog Number	A
AJT (70-100)-EI	2.8 in (71.0 mm)
AJT (110-200)-EI	3.22 in (81.8 mm)
AJT (225-400)-EI	3.24 in (82.2 mm)
AJT (450-600)-EI	3.61 in (91.8 mm)

AJT Reducer Fuses

Time Delay/Class J

UL/CSA LISTED POWER FUSES

DECREASE YOUR CURRENT RATING WITHOUT USING A FUSE REDUCER



AJT Reducer Fuses are a safe permanent solution for decreasing your current rating without using a Fuse Reducer accessory, which is designed for temporary use only. These special purpose UL Listed reduced rating Class J fuses provide the same trusted protection levels as a traditional AJT fuses, but in a larger body.

FEATURES/BENEFITS:

- Replaces traditional temporary-use only Fuse Reducer accessories
- Recommended for Arc Flash energy reduction
- Extremely current-limiting for low peak let-thru current
- Most current-limiting UL class fuse
- Time-delay for motor starting and transformer inrush
- High-visibility orange label gives instant brand recognition
- Metal-embossed date and catalog number for traceability and lasting identification
- Fiberglass body provides dimensional stability in harsh industrial settings
- High-grade silica filler ensures fast arc quenching
- Optional EI indicator/switch

HIGHLIGHTS:

- Class J Reduced Rating
- Arc Flash mitigating
- Highly current-limiting
- Time-delay
- DC ratings
- Optional mechanical indicator

RATINGS:

Volts: 600VAC, 500VDC

Amps: 125 to 200A (in 400A body), 250 to 400A (in 600A body)

IR: 200kA I.R. AC, 100kA I.R. DC (Self-certified for 600VAC, 300kA I.R., UL witnessed).

APPLICATIONS:

- Motor circuits
- Mains
- Feeders
- Branch circuits
- Lighting, heating & general loads
- Transformers
- Control panels
- Circuit breaker back-up
- Bus duct
- Load centers

Note: See motor fuse applications tables for additional information

APPROVALS:

AJT (1-600):

- UL Listed to standard 248-8 File E2137
- IEC 269-2-1



CATALOG NUMBERS (AMPS) RECOMMENDED FUSE BLOCKS WITH BOX CONNECTORS FOR AMP-TRAP® CLASS J FUSES

Catalog Numbers	Amp Rating	Body Size
AJT125/400	125A	400A
AJT150/400	150A	
AJT175/400	175A	
AJT200/400	200A	
AJT250/600	250A	600A
AJT300/600	300A	
AJT350/600	350A	
AJT400/600	400A	

Amp Rating/ Body Size	Catalog Number 600V or Less	
	1 Pole	3 Pole
125/400-200/400	64031J	64033J
250/600-400/600	6631J	6633J

A variety of pole configurations and termination provisions are available. Refer to Section FB for details.

DIMENSIONS

Ampere Rating	A		B		C		D		E		F		G		H	
	in	mm	in	mm	in	mm	in	mm	in	mm	in	mm	in	mm	in	mm
125-200	7-1/8	181	2-1/8	54	1/4	6.3	1-5/8	41	1-7/8	48	5-1/4	133	17/32	14	13/32	10
250-400	8	203	2-1/2	64	3/8	9.5	2	51	2-1/8	54	6	152	11/16	18	17/32	13

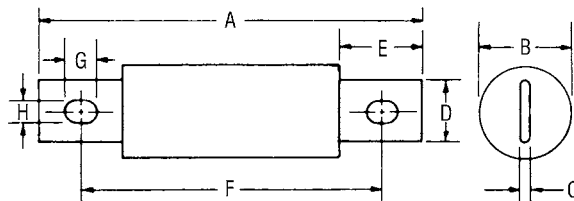

70-600A

HSJ

High Speed/Class J

UL/CSA LISTED POWER FUSES

PROTECT YOUR WIRING AND POWER
SEMICONDUCTORS WITH A SINGLE FUSE



The High Speed J (HSJ) fuse combines the low I^2t of a semiconductor fuse and the branch circuit performance of a Class J UL listed fuse. This fuse was designed for the starting characteristics of solid state motor controllers. The HSJ can provide branch circuit protection per NEC requirements, as well as very low I^2t for protection of power semiconductors such as Diodes, SCRs, GTOs and SSRs.

FEATURES/BENEFITS:

- Optimized over-load capability for withstanding elevated levels of current during electronic motor controller starts
- Low I^2t (low thermal energy)
- Excellent cycling ability for frequent starts/stops without nuisance opening

RATINGS:

- **Volts:** 600VAC, 500VDC
- **Amps:** 1 to 600A (AC), 15 to 600A (DC)
- **IR:** 200kA I.R. AC, 100kA I.R. DC, L/R =10mS or less (Self Certified for 600VAC, 300kA I.R., UL witnessed.)

HIGHLIGHTS:

- Current-limiting
- AC & DC ratings
- Low I^2t
- Compact size

APPLICATIONS:

- Branch circuits
- Control panels
- Electronic motor controllers
- Phase controllers
- Drives
- Soft-starters
- Solid state relays

APPROVALS:

- UL listed to standard 248-8 File E2137
- CSA certified to standard C22.2 no. 248.8
- DC listed to UL 248



CATALOG NUMBERS (AMPS)

HSJ1	HSJ30	HSJ90	HSJ250
HSJ3	HSJ35	HSJ100	HSJ300
HSJ6	HSJ40	HSJ110	HSJ350
HSJ10	HSJ45	HSJ125	HSJ400
HSJ15	HSJ50	HSJ150	HSJ450
HSJ17-1/2	HSJ60	HSJ175	HSJ500
HSJ20	HSJ70	HSJ200	HSJ600
HSJ25	HSJ80	HSJ225	

RECOMMENDED FUSE BLOCKS
WITH BOX CONNECTORS FOR
AMP-TRAP® CLASS J FUSES

Fuse Ampere Rating	Catalog Number 600V or Less	
	1-Pole	3-Pole
0-30	US3J1I	US3J3I
31-60	US6J1I	US6J3I
61-100	61036J	61038J
101-200	62001J	62003J
201-400	64031J	64033J
401-600	6631J	6633J

A variety of pole configurations and termination provisions are available. Refer to Section FB for details.

DIMENSIONS

Ampere Rating	A		B		C		D		E		F		G		H	
	in	mm	in	mm	in	mm	in	mm	in	mm	in	mm	in	mm	in	mm
1-30	2-1/4	57	13/16	21	-	-	-	-	-	-	-	-	-	-	-	-
31-60	2-3/8	60	1-1/16	27	-	-	-	-	-	-	-	-	-	-	-	-
61-100	4-4/8	117	1-1/8	29	1/8	3.2	3/4	19	1	25	3-5/8	92	3/8	10	9/32	7
101-200	5-3/4	146	1-5/8	41	3/16	4.8	1-1/8	29	1-3/8	35	4-3/8	111	3/8	10	9/32	7
201-400	7-1/8	181	2-1/8	54	1/4	6.3	1-5/8	41	1-7/8	48	5-1/4	133	17/32	13	13/32	10
401-600	8	203	2-1/2	64	3/8	9.5	2	51	2-1/8	54	6	152	11/16	18	17/32	13

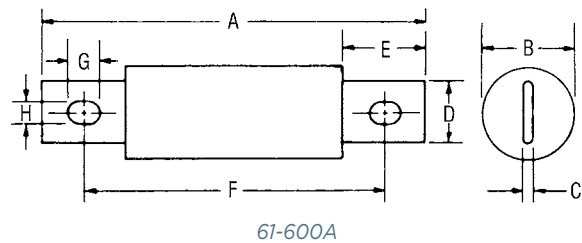
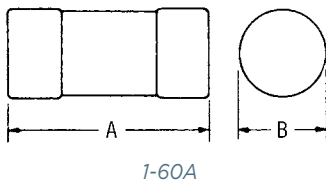

A4J

Fast Acting/Class J

UL/CSA LISTED POWER FUSES

FOR EXCELLENT CURRENT-LIMITING PROTECTION



A4J Class J fuses deliver excellent current-limiting protection to a wide variety of applications. Their unique dimensions prevent the substitution of other fuses with lower voltage ratings, interrupting ratings, or current-limiting capability.

FEATURES/BENEFITS:

- High current limitation for low peak let-thru current
- Unique dimensions prevent replacement by other fuse classes
- Fiberglass body provides dimensional stability in harsh industrial environments
- Easy-to-read imprint label for quick recognition and replacement

RATINGS:

- **Volts:** 600VAC, 300VDC
- **Amps:** 1 to 600A
- **IR:** 200kA I.R. AC, 100kA I.R. DC

HIGHLIGHTS:

- Fast-acting
- Very current-limiting
- DC ratings

APPLICATIONS:

- Capacitors
- Load centers
- Panelboards
- Switchboards
- Bus duct
- Feeder circuits
- Circuit breakers
- Lighting, heating, and general loads

APPROVALS:

- UL listed to standard 248-8 File E2137
- CSA certified to standard C22.2 no. 248.8
- DC listed to UL 248
- IEC 269-2-1



CATALOG NUMBERS (AMPS)

A4J1	A4J35	A4J90	A4J250
A4J3	A4J40	A4J100	A4J300
A4J6	A4J45	A4J110	A4J350
A4J10	A4J50	A4J125	A4J400
A4J15	A4J60	A4J150	A4J450
A4J20	A4J70	A4J175	A4J500
A4J25	A4J75	A4J200	A4J600
A4J30	A4J80	A4J225	

RECOMMENDED FUSE BLOCKS
WITH BOX CONNECTORS FOR
AMP-TRAP® CLASS J FUSES

Fuse Ampere Rating	Catalog Number 600V or Less	
	1-Pole	3-Pole
0-30	US3J1I	US3J3I
31-60	US6J1I	US6J3I
61-100	61036J	61038J
101-200	62001J	62003J
201-400	64031J	64033J
401-600	6631J	

A variety of pole configurations and termination provisions are available. Refer to Section FB for details.

DIMENSIONS

Ampere Rating	A		B		C		D		E		F		G		H	
	in	mm	in	mm	in	mm	in	mm	in	mm	in	mm	in	mm	in	mm
1-30	2-1/4	57	13/16	21	-	-	-	-	-	-	-	-	-	-	-	-
31-60	2-3/8	60	1-1/16	27	-	-	-	-	-	-	-	-	-	-	-	-
61-100	4-4/8	117	1-1/8	29	1/8	3.2	3/4	19	1	25	3-5/8	92	3/8	10	9/32	7
101-200	5-3/4	146	1-5/8	41	3/16	4.8	1-1/8	29	1-3/8	35	4-3/8	111	3/8	10	9/32	7
201-400	7-1/8	181	2-1/8	54	1/4	6.3	1-5/8	41	1-7/8	48	5-1/4	133	17/32	13	13/32	10
401-600	8	203	2-1/2	64	3/8	9.5	2	51	2-1/8	54	6	152	11/16	18	17/32	13

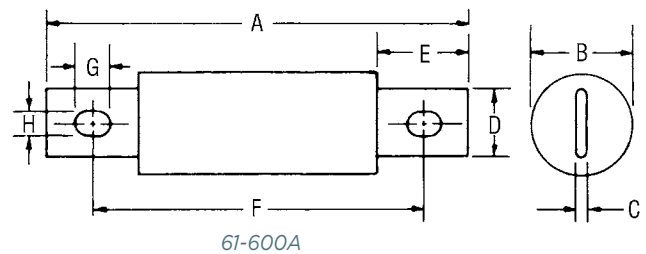
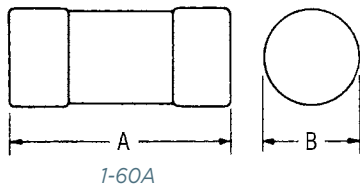

ATDR

Time Delay/Class CC

UL/CSA LISTED POWER FUSES

THE BEST PROTECTION FOR TODAY'S SMALL MOTORS



Amp-Trap 2000® ATDR small-dimension fuses can provide IEC Type 2 No Damage protection to your facility's increasingly sensitive branch circuit components and small motors - minimizing the risk of fault-related damage. ATDR Class CC fuses deliver the best time-delay characteristics in their class with excellent cycling ability for small motor loads.

FEATURES/BENEFITS:

- Time-delay for motor starting inrush currents without nuisance opening
- Highly current-limiting for low peak let-thru current
- Improved cycling ability for frequent motor starts/stops without nuisance fuse opening
- Rejection-style design prevents replacement errors (when used with recommended fuse blocks)
- High-visibility orange label ensures instant brand recognition, simplifies replacement
- Metal-embossed date and catalog number for traceability and lasting identification
- Fiberglass body provides dimensional stability in harsh industrial settings
- High-grade silica filler ensures fast arc quenching and optimum current-limitation

RATINGS:

Volts: 600VAC, 300VDC

Amps: 1/4 to 30A

IR: 200kA I.R. AC,
100kA I.R. DC

APPLICATIONS:

- Small motors
- Contactors
- Lighting, heating & general loads
- Branch circuit protection

Note: See motor fuse applications tables for more information

APPROVALS:

- UL listed to standard 248-4 File E2137
- CSA certified to standard C22.2 No. 248.4
- DC listed to UL standard 248



HIGHLIGHTS:

- Time-delay
- Best choice for small motor protection
- Highly current-limiting
- AC & DC rated

CATALOG NUMBERS (AMPS)

ATDR1/4	ATDR1-1/2	ATDR3	ATDR6	ATDR12
ATDR1/2	ATDR1-6/10	ATDR3-2/10	ATDR6-1/4	ATDR15
ATDR8/10	ATDR1-8/10	ATDR3-1/2	ATDR7	ATDR17-1/2
ATDR1	ATDR2	ATDR4	ATDR7-1/2	ATDR20
ATDR1-1/8	ATDR2-1/4	ATDR4-1/2	ATDR8	ATDR25
ATDR1-1/4	ATDR2-1/2	ATDR5	ATDR9	ATDR30
ATDR1-4/10	ATDR2-8/10	ATDR5-6/10	ATDR10	

RECOMMENDED FUSE BLOCKS FOR CLASS CC FUSES

Number of Poles	Catalog Numbers			
	UltraSafe™ Indicating Fuse Holder	Screw Connector w/ Double Quick Connects	Pressure Plate Connector w/ Double Quick Connects	Copper Box Connector
ADDER		30310R	30320R	30350R
1	USCC1I	30311R	30321R	30351R
2	USCC2I	30312R	30322R	30352R
3	USCC3I	30313R	30323R	30353R
3	USFMCCI			

DIMENSIONS

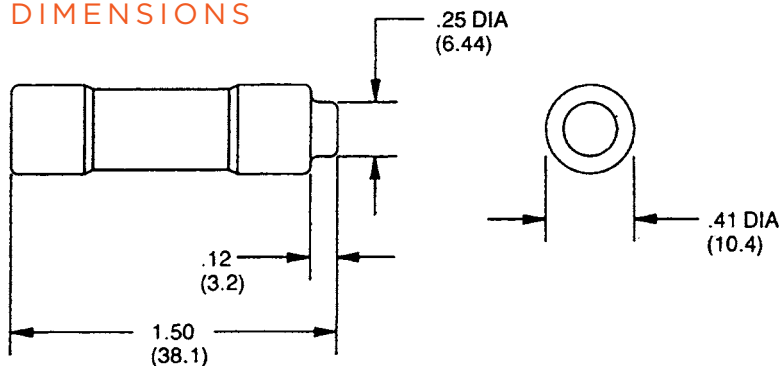

ATQR

Time Delay/Class CC

UL/CSA LISTED POWER FUSES

TAKE CONTROL OF FAULT CURRENTS HEADED FOR YOUR CONTROL TRANSFORMER



ATQR small-dimension fuses feature time-delay characteristics ideally suited for the high inrush currents of control transformers, solenoids, and similar inductive loads. Mersen's ATQR fuses provide superior protection for the branch circuits of electrical distribution systems.

FEATURES/BENEFITS:

- Time-delay for control transformer inrush loads without nuisance opening
- Highly current-limiting for low peak let-thru current
- Rejection-style design prevents replacement errors (when used with recommended fuse blocks)
- High visibility orange label ensures instant brand recognition, and simplifies replacement
- Metal-embossed date and catalog number for traceability and lasting identification
- Fiberglass body provides dimensional stability in harsh industrial settings
- High-grade silica filler ensures fast arc quenching and high current limitation

HIGHLIGHTS:

- Time-delay
- Best choice for small transformer protection
- Current-limiting

RATINGS:

Volts: 600VAC (1/10-30A), 300VDC (3-2/10 - 30A)

Amps: 1/10 to 30A

IR: 200kA I.R. AC, 100kA I.R. DC

APPLICATIONS:

- Control transformers
- Solenoids
- Inductive loads
- Lighting, heating & general-purpose loads

Note: See motor fuse applications tables for more information

APPROVALS:

- UL listed to standard 248-4 File E2137
- DC listed to UL standard 248
- CSA certified to standard C22.2 No. 248.4



CATALOG NUMBERS (AMPS)

ATOR1/10	ATOR8/10	ATOR2-8/10	ATOR7-1/2
ATOR1/8	ATOR1	ATOR3	ATOR8
ATOR3/16	ATOR1-1/8	ATOR3-2/10	ATOR9
ATOR2/10	ATOR1-1/4	ATOR3-1/2	ATOR10
ATOR1/4	ATOR1-4/10	ATOR4	ATOR12
ATOR3/10	ATOR1-1/2	ATOR4-1/2	ATOR15
ATOR4/10	ATOR1-6/10	ATOR5	ATOR17-1/2
ATOR1/2	ATOR1-8/10	ATOR5-6/10	ATOR20
ATOR6/10	ATOR2	ATOR6	ATOR25
ATOR3/4	ATOR2-1/4	ATOR6-1/4	ATOR30
	ATOR2-1/2	ATOR7	

RECOMMENDED FUSE BLOCKS
FOR CLASS CC FUSES

Number of Poles	Catalog Numbers			
	UltraSafe™ Indicating Fuse Holder	Screw Connector w/ Double Quick Connects	Pressure Plate Connector w/ Double Quick Connects	Copper Box Connector
ADDER		30310R	30320R	30350R
1	USCC1I	30311R	30321R	30351R
2	USCC2I	30312R	30322R	30352R
3	USCC3I	30313R	30323R	30353R
3	USFMCCI			

DIMENSIONS

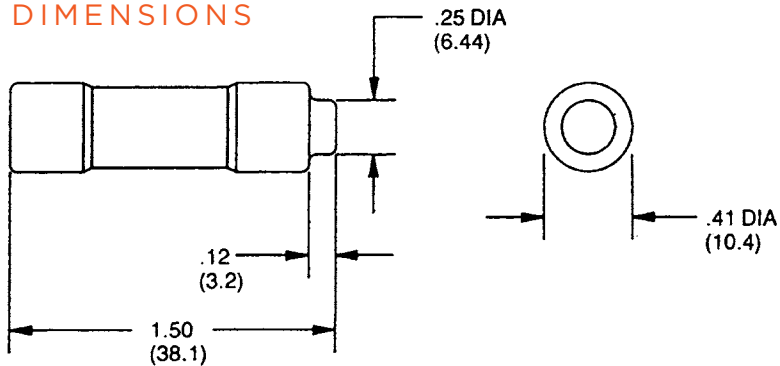

ATMR

Fast Acting/Class CC

UL/CSA LISTED POWER FUSES

SMALL FUSE - BIG PROTECTION
FOR GENERAL CIRCUITS



Amp-Trap® ATMR fuses, in the Class CC family, are the smallest dimension 600VAC/DC fuses suitable for branch circuit protection. The ATMR is a popular choice for economical protection of control circuits and control circuit transformers where available short circuit currents exceed 10,000 amperes. ATMR's rejection dimensions prevent substitution by lesser rated fuses. These fast acting fuses give current-limiting protection to general circuits.

CATALOG NUMBERS (AMPS) DIMENSIONS

ATMR1/10	ATMR1	ATMR4	ATMR10
ATMR1/8	ATMR1-1/4	ATMR5	ATMR12
ATMR2/10	ATMR1-1/2	ATMR6	ATMR15
ATMR1/4	ATMR2	ATMR7	ATMR20
ATMR3/10	ATMR2-1/2	ATMR8	ATMR25
ATMR1/2	ATMR3	ATMR9	ATMR30
ATMR3/4	ATMR3-1/2		

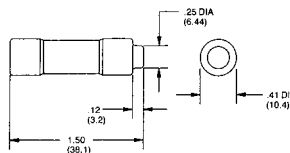

RECOMMENDED FUSE BLOCKS FOR AMP-TRAP® CLASS CC FUSES

Number of Poles	UltraSafe™ Indicating Fuse Holders	Screw Connector with Double Quick Connects	Pressure Plate Connector with Double Quick Connects	Cooper Box Connector
Adder	—	30310R	30320R	30350R
1	USCC1I	30311R	30321R	30351R
2	USCC2I	30312R	30322R	30352R
3	USCC3I	30313R	30323R	30353R
3	USFMCCI	—	—	—

A variety of pole configurations and termination provisions are available. Refer to Section FB for details.

RATINGS:

- **Volts:** 600VAC / DC
- **Amps:** 1/10 to 30A
- **IR:** 200kA I.R. AC, 100kA I.R. DC

HIGHLIGHTS:

- Fast-acting
- Very current-limiting

FEATURES/ BENEFITS:

- Rejection-style design prevents replacement errors when used with recommended fuse blocks
- Versatile design for individual component and branch circuit protection

APPLICATIONS:

- Control circuits
- Lighting
- General loads
- Branch circuit protection

APPROVALS:

- UL Listed to Standard 248-4 File E2137
- CSA Certified to Standard C22.2 No. 248.4
- DC listed to UL Standard 248



AG

Class G

UL/CSA LISTED POWER FUSES

AMP-TRAP® AG FUSES FIT RIGHT INTO A WIDE VARIETY OF INDUSTRIAL APPLICATIONS



The Mersen Amp-Trap AG fuse series is a complete line of Class G fuses. AG fuses safely fit a wide variety of applications. Class G fuses are made in four physical sizes and provide superior branch-circuit protection for lighting, heating, and appliance circuits.

FEATURES/BENEFITS:

- Four unique sizes from 1/2-60 amperes do not allow inter-changeability with other fuse classes
- Fiberglass bodies provide dimensional stability in harsh industrial settings

CATALOG NUMBERS (AMPS)

AG1/2	AG2	AG5	AG10	AG25	AG40	AG50
AG1	AG3	AG6	AG15	AG30	AG45	AG60
AG1-1/2	AG4	AG8	AG20	AG35		

DIMENSIONS

Ampere Rating	A		B		C	
	in	mm	in	mm	in	mm
1/2-15A	1.31	33.3	.406	10.3	.28	7.1
20A	1.41	35.8	.406	10.3	.28	7.1
25, 30A	1.62	41.2	.406	10.3	.28	7.1
35-60A	2.25	57.2	.406	10.3	.50	

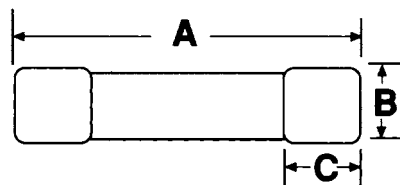

Cross Reference: AG will replace the following fuses: Bussmann SC, Littelfuse SLC

RATINGS:

- **Volts:** 600VAC (1/2 to 20A), 480VAC (25 to 60A)
- **Amps:** 1/2 to 60A
- **IR:** 100kA I.R. AC

HIGHLIGHTS:

- Current-limiting
- Time-delay (above 5A)

APPLICATIONS:

- Lighting
- Heating*
- Appliances

*except in Canada where fuses must be "P" or "D" type.

APPROVALS:

- UL listed to standard 248-5 File E2137
- CSA certified to standard C22.2 No. 248.5



OT/OTN/OTS

Class K-5

UL/CSA LISTED POWER FUSES

FOR VERSATILITY AND ECONOMY, THESE GENERAL PURPOSE FUSES ARE HARD TO BEAT



OT, OTN and OTS general purpose fuses provide low cost protection for feeder and branch circuits serving lighting, heating, and other non-motor loads. OT, OTN and OTS fuses will safely interrupt available short circuit currents up to 50,000 amperes in all ratings. OT, OTN and OTS fuses are not rejection fuses – care should be taken to ensure that replacement fuses do not have lower interrupting ratings than original fuses. OTN 15 through 60 satisfy the Canadian electrical code requirement for Type “P,” low melting-point, non-time-delay fuses.

FEATURES/BENEFITS:

- Easy to read imprint label for quick recognition and replacement
- Low cost for high protection value

APPLICATIONS:

- Feeders
- Branch circuits
- Resistive heating
- Residential and small commercial installations

RATINGS:

OT

- **Volts:** 250VAC / DC
- **Amps:** 1 to 600A
- **IR:** 50kA I.R. AC, 20kA I.R. DC

OTN (Canada)*

- **Volts:** 250VAC
- **Amps:** 15 to 60A
- **IR:** 50kA I.R. AC

OTS

- **Volts:** 600VAC / 300VDC
- **Amps:** 1 to 600A
- **IR:** 50kA I.R. AC, 20kA I.R. DC

HIGHLIGHTS:

- Versatile
- Lowest cost protection for circuits serving non-inductive loads

APPROVALS:

- UL Listed to Standard 248-9 File E2137
- CSA Certified to Standard C22.2 No. 248.9*
- Self-certified for DC per UL248



*The Canadian Electrical Code requires these fuses in ratings 15 through 60A to be of the low melting point design; use OTN 15-60.

CATALOG NUMBERS (AMPS)

250V			600V		
OT1	OT30, OTN30*	OT125	OTS1	OTS30	OTS125
OT2	OT35, OTN35*	OT150	OTS2	OTS35	OTS150
OT3	OT40, OTN40*	OT175	OTS3	OTS40	OTS175
OT4	OT45, OTN45*	OT200	OTS4	OTS45	OTS200
OT5	OT50, OTN50*	OT225	OTS5	OTS50	OTS225
OT6	OT60, OTN60*	OT250	OTS6	OTS60	OTS250
OT7	OT65	OT300	-	-	OTS300
OT8	OT70	OT350	OTS8	OTS70	OTS350
OT10	OT75	OT400	OTS10	OTS75	OTS400
OT12	OT80	OT450	OTS12	OTS80	OTS450
OT15, OTN15*	OT90	OT500	OTS15	OTS90	OTS500
OT20, OTN20*	OT100	OT600	OTS20	OTS100	OTS600
OT25, OTN25*	OT110		OTS25	OTS110	

* In Canada

RECOMMENDED FUSE BLOCKS
WITH BOX CONNECTORS FOR
ONE-TIME CLASS K-5 FUSES

Ampere Fuse Rating	Catalog Number			
	250V		600V	
	1-Pole	3-Pole	1-Pole	3-Pole
0-30	20306	20308	60306	60308
31-60	20606	20608	60606	60608
61-100	21036	21038	61036	61038
101-200	22001	22003	62001	62003
201-400	24001	24003	64001	64003
401-600	2631	2633	6631	6633

A variety of pole configurations and termination provisions are available. Refer to Section FB for details.

DIMENSIONS

Ampere Rating	A		B		C		D		E	
	in	mm	in	mm	in	mm	in	mm	in	mm
250V-OT, OTN Fuses										
0-30	2	51	9/16	14	-	-	-	-	-	-
31-60	3	76	13/16	21	-	-	-	-	-	-
61-100	5-7/8	149	1-1/16	27	1/8	3	3/4	19	1	25
101-200	7-1/8	181	1-9/16	40	3/16	5	1-1/8	28	1-3/8	35
201-400	8-5/8	219	2-1/16	53	1/4	6	1-5/8	41	1-7/8	48
401-600	10-3/8	264	2-9/16	66	1/4	6	2	51	2-1/4	57
600V-OTS Fuses										
0-30	5	127	13/16	21	-	-	-	-	-	-
31-60	5-1/2	139	1-1/16	27	-	-	-	-	-	-
61-100	7-7/8	200	1-5/16	34	1/8	3	3/4	19	1	25
101-200	9-5/8	244	1-13/16	46	3/16	5	1-1/8	28	1-3/8	35
201-400	11-5/8	295	2-9/16	66	1/4	6	1-5/8	41	1-7/8	48
401-600	13-3/8	340	3-1/8	80	1/4	6	2	51	2-1/4	57

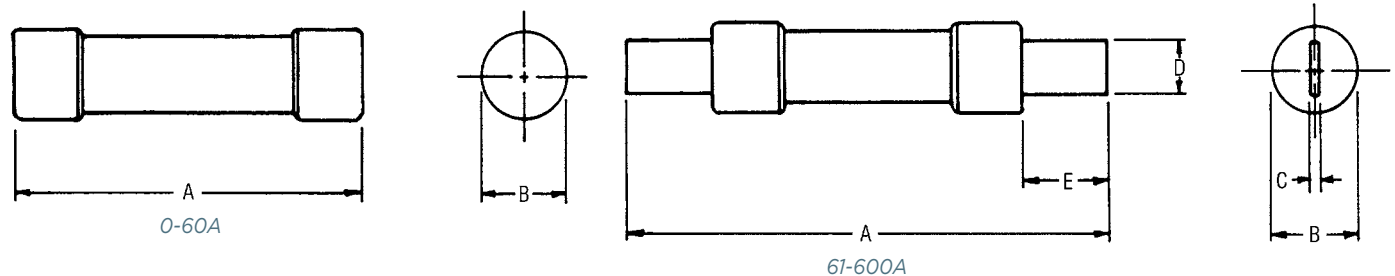

A3T & A6T

Fast Acting/Class T

UL/CSA LISTED POWER FUSES

THESE SMALL DIMENSION FUSES ARE
THE RIGHT FIT... FOR A TIGHT FIT



Fast-acting A3T and A6T Class T fuses combine two highly desirable features - high current limitation and a small physical size. Their unique dimensions prevent the substitution of other fuses with lower voltage ratings or current-limiting capability.

These fuses have glass melamine bodies for superior dimensional stability and catalog numbers stamped into the blades for permanent identification.

FEATURES/BENEFITS:

- Extremely current-limiting for low peak let-thru current
- Unique dimensions prevent replacement by other fuse classes
- Blade-stamped catalog numbers for permanent identification
- Small physical size for greater design flexibility

RATINGS:

A3T

- **Volts:** 300VAC / 160VDC
- **Amps:** 1 to 1200A
- **IR:** 200kA I.R. AC, 50kA I.R. DC

A6T

- **Volts:** 600VAC / 300VDC
- **Amps:** 1 to 800A
- **IR:** 200kA I.R. AC, 100kA I.R. DC

HIGHLIGHTS:

- Fast-acting
- Extremely current-limiting
- Small physical size
- DC ratings

APPLICATIONS:

- Loadcenters
- Panelboards
- Switchboards
- Circuit breakers
- Metering centers

APPROVALS:

- UL listed to standard 248-15 File E2137
- CSA certified to standard C22.2 no. 248.15
- DC listed to UL standard 248



CATALOG NUMBERS (AMPS)

300V			600V		
A3T1	A3T60	A3T300	A6T1	A6T60	A6T300
A3T3	A3T70	A3T350	A6T3	A6T70	A6T350
A3T6	A3T80	A3T400	A6T6	A6T80	A6T400
A3T10	A3T90	A3T450	A6T10	A6T90	A6T450
A3T15	A3T100	A3T500	A6T15	A6T100	A6T500
A3T20	A3T110	A3T600	A6T20	A6T110	A6T600
A3T25	A3T125	A3T700	A6T25	A6T125	A6T700
A3T30	A3T150	A3T800	A6T30	A6T150	A6T800
A3T35	A3T175	A3T1000	A6T35	A6T175	
A3T40	A3T200	A3T1200	A6T40	A6T200	
A3T45	A3T225		A6T45	A6T225	
A3T50	A3T250		A6T50	A6T250	

RECOMMENDED FUSE BLOCKS
WITH BOX CONNECTORS FOR
AMP-TRAP® CLASS T FUSES

Ampere Rating	Catalog Number			
	300V		600V	
	1-Pole	3-Pole	1-Pole	3-Pole
1-30	30306T	30308T	60306T	60308T
31-60	30606T	30608T	60606T	60608T
61-100	31001T	31003T	61031T	61033T
101-200	32031T	32033T	62031T	62033T
201-400	34031T	34033T	64031T	-
401-600	36031T	-	66031T	-

A variety of pole configurations and termination provisions are available. Refer to Section FB for details.

DIMENSIONS

Ampere Rating	A		B		C		D		E		F		G	
	in	mm	in	mm	in	mm	in	mm	in	mm	in	mm	in	mm
300V-A3T Fuses														
1-30	.88	22.4	.41	10.3	-	-	-	-	-	-	-	-	-	-
31-60	.88	22.4	.56	14.1	-	-	-	-	-	-	-	-	-	-
61-100	2.16	54.9	.81	20.6	.12	3.2	.75	19.0	1.56	39.6	.28	7.1	.82	20.8
101-200	2.44	62.0	1.06	26.9	.19	4.8	.88	22.4	1.70	43.2	.34	8.6	.83	21.1
201-400	2.75	69.8	1.33	33.8	.25	6.4	1.00	25.4	1.84	46.7	.41	10.4	.84	21.3
401-600	3.06	77.7	1.62	41.1	.31	7.8	1.25	31.8	2.03	51.6	.48	12.2	.84	21.3
601-800	3.38	85.8	2.08	52.8	.38	9.7	1.75	44.4	2.22	56.4	.55	14.0	.88	22.4
801-1200	4.00	102	2.52	64.0	.44	11.2	2.00	50.8	2.53	64.3	.61	15.5	1.03	26.2
600V-A6T Fuses														
1-30	1.50	38.1	.57	14.5	-	-	-	-	-	-	-	-	-	-
31-60	1.57	39.9	.81	20.6	1.51	38.4	1.00	25.4	-	-	-	-	-	-
61-100	2.95	75.0	.82	20.8	.12	3.2	.75	19.0	2.35	59.7	.28	7.1	1.58	40.1
101-200	3.26	82.8	1.07	27.2	.19	4.8	.88	22.4	2.51	63.7	.34	8.6	1.61	41.0
201-400	3.62	92.1	1.62	41.3	.25	6.4	1.00	25.4	2.72	69.1	.41	10.4	1.70	43.2
401-600	3.98	101.2	2.06	52.4	.31	7.9	1.25	31.8	2.95	75.0	.48	12.2	1.70	43.2
601-800	4.33	110.0	2.50	63.5	.37	9.5	1.75	44.4	3.17	80.5	.56	14.1	1.70	43.2

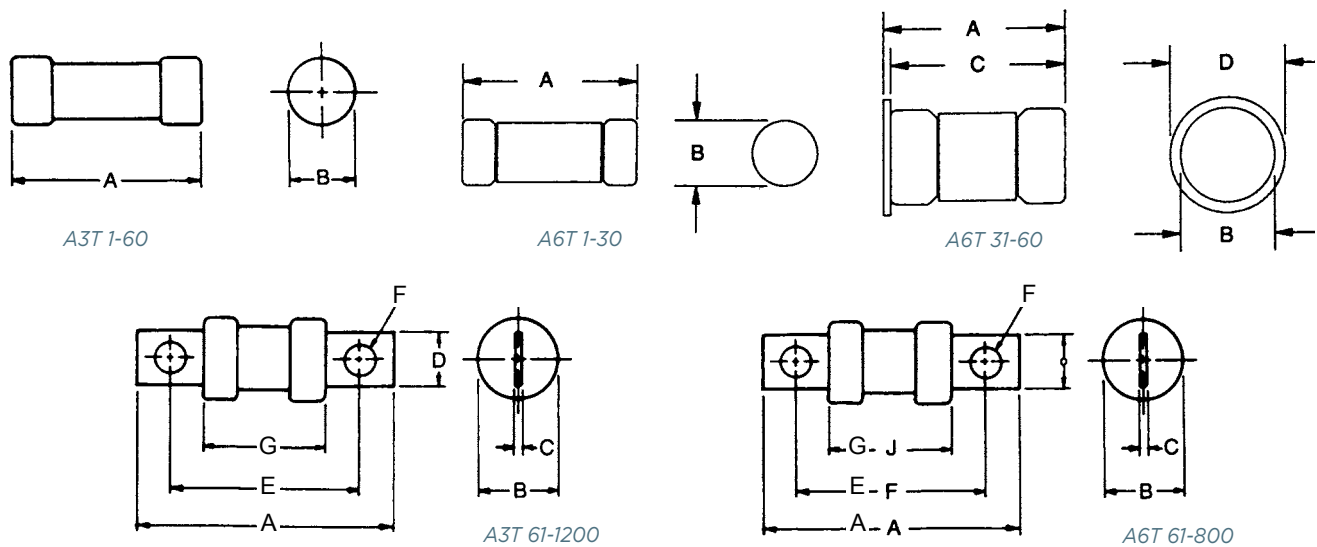

Class C

Canadian Fuses

UL/CSA LISTED POWER FUSES



Mersen Class C fuses have British standard (BS88) dimensions and are exact replacements for the British fuses and older HRCII-C fuses. Class C fuses are not dimensionally or electrically interchangeable with other North American fuses. They feature ceramic bodies and bolt-in mounting. They are for short-circuit protection only, in motor controllers, for example, where overload protection is provided by an overload relay.

* Ceramic version available upon request

HIGHLIGHTS:

- BS88 dimensions
- Fast-acting

APPLICATIONS:

- Short circuit and back-up protection of motor controllers and components

CATALOG NUMBERS (AMPS)

FES2	FES25	FES100	FESC100	FESF300	FESC350
FES4	FES30	FES125	FESC125	FESF350	FESC400
FES6	FES40	FES150	FESC150	FESF400	FESC450
FES10	FES50	FES200	FESC200	FESC250	FESC500
FES15	FES60	FESC80	FESF250	FESC300	FESC600
FES20	FES80				

RATINGS:

- **Volts:** 600VAC, 460VDC, 450VDC, 350VDC
- **Amps:** 2 to 600A
- **I.R.:** 200kA I.R. AC (2-600A), 40kA I.R. DC
- **460VDC:** FES (2-60A), FESF (250-400A), FESC (250-400A)
- **450VDC:** FESC (450-600A)
- **350VDC:** FES (80-100A), FESC (80-200A)

APPROVALS:

- CSA Certified HRCII-MISC IEC 269-2-1



CLASS C DIMENSIONS INCHES (MM)

Catalog No.	A	B	D	E	F	G	H	K
FES 2-30	2.06 (52.3)	0.81 (20.6)	3.31 (84.1)	0.35 (8.9)	0.06 (1.6)	2.83 (71.9)	0.20 (5.2)	0.84 (21.3)
FES 40-60	2.19 (55.6)	1.06 (26.9)	3.44 (87.4)	0.50 (12.7)	0.06 (1.6)	2.77 (70.4)	0.20 (5.2)	1.07 (27.2)
FES 80-100	2.69 (68.3)	1.34 (34.0)	4.31 (109.5)	0.75 (19.1)	0.13 (3.2)	3.64 (92.5)	0.34 (8.7)	1.43 (36.3)
FES 125-200	2.69 (68.3)	1.58 (40.1)	4.31 (109.5)	0.75 (19.1)	0.13 (3.2)	3.64 (92.5)	0.34 (8.7)	1.69 (42.9)
FESC 80-100	2.44 (61.9)	1.34 (33.9)	5.31 (134.9)	0.75 (19.1)	0.13 (3.2)	4.28 (108.7)		
FESC 125-200	2.44 (61.9)	1.59 (40.3)	5.31 (134.9)	0.75 (19.1)	0.13 (3.2)	4.28 (108.7)		
FESF 250-400	3.00 (76.2)	2.00 (50.8)	5.38 (136.7)	1.00 (25.4)	0.25 (6.4)	4.25 (108.0)	0.41 (10.4)	
FESC 250-400	3.00 (76.2)	2.00 (50.8)	8.25 (209.6)	1.00 (25.4)	0.25 (6.4)	5.16 (131.0)		
FESC 450-600	3.00 (76.2)	2.88 (73.0)	8.25 (209.6)	1.00 (25.4)	0.38 (9.5)	5.06 (128.6)		

FES2-30
FES40-60
FES80-100
FES125-200

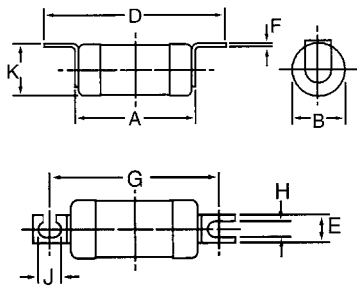

FESC80-100
FESC125-200
FESF250-400

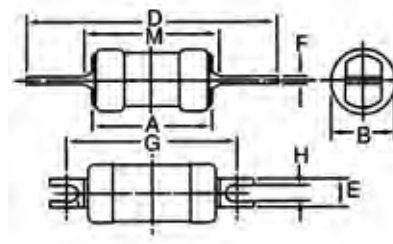

FESC250-400
FESC450-600

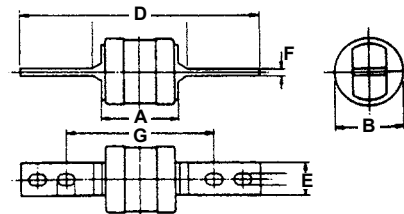

NRN/NRS Class H

Canadian Fuses

UL/CSA LISTED POWER FUSES

NON-TIME DELAY FUSES



Mersen NRN (250V) and NRS (600V) fuses are standard non-time delay fuses, with a 10kA short circuit rating. 250 Volt NRN15 through NRN60 fuses are certified as Type “P” fuses, satisfying the Canadian Electrical Code for low melting-point non-time delay fuses. Also qualifying for Type “P” are OTN15 through OTN60, which are Class K-5 fuses with a 50kA short circuit rating (found in the OT/OTS section of this catalog).

DIMENSIONS - INCHES (MM)

250V NRN Fuses					
Ampere Rating	A	B	C	D	E
1-30	2.00 [50.8]	0.56 [14.2]			0.50 [12.7]
35-60	3.00 [76.2]	0.81 [20.6]			0.63 [16.0]
70-100	5.88 [149]	1.06 [26.9]	0.13 [3.18]	0.75 [19.1]	1.00 [25.4]
110-200	7.13 [181]	1.63 [41.4]	0.19 [4.76]	1.13 [28.7]	1.38 [35.1]
225-400	8.63 [219]	2.13 [54.1]	0.25 [6.35]	1.63 [41.4]	1.88 [47.8]
450-600	10.4 [264]	2.63 [66.8]	0.25 [6.35]	2.00 [50.8]	2.25 [57.2]
600V NRS Fuses					
1-30	5.00 [127]	0.81 [20.6]			0.63 [16.0]
35-60	5.50 [139]	1.06 [26.9]			0.63 [16.0]
70-100	7.88 [200]	1.38 [35.1]	0.13 [3.18]	0.75 [19.1]	1.00 [25.4]
110-200	9.63 [244]	1.88 [47.8]	0.19 [4.76]	1.13 [28.7]	1.38 [35.1]
225-400	11.6 [295]	2.63 [66.8]	0.25 [6.35]	1.63 [41.4]	1.88 [47.8]
450-600	13.4 [340]	3.13 [79.5]	0.25 [6.35]	2.00 [50.8]	2.25 [57.2]

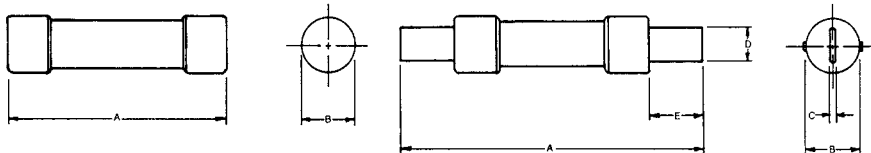

CATALOG NUMBERS

250V Fuse Ampere Ratings	
NRN1	NRN80
NRN2	NRN90
NRN3	NRN100
NRN4	NRN110
NRN5	NRN125
NRN6	NRN150
NRN10	NRN175
NRN15*	NRN200
NRN20*	NRN250
NRN25*	NRN250
NRN30*	NRN300
NRN35*	NRN350
NRN40*	NRN400
NRN45*	NRN450
NRN50*	NRN500
NRN60*	NRN600
NRN70	* CSA Type “P”
600V Fuse Ampere Ratings	
NRS1	NRS80
NRS2	NRS90
NRS3	NRS100
NRS4	NRS110
NRS5	NRS125
NRS6	NRS150
NRS10	NRS175
NRS15	NRS200
NRS20	NRS250
NRS25	NRS250
NRS30	NRS300
NRS35	NRS350
NRS40	NRS400
NRS45	NRS450
NRS50	NRS500
NRS60	NRS600
NRS70	

CRN/CRS Class H

Canadian Fuses

UL/CSA LISTED POWER FUSES

TIME DELAY FUSES



CRN & CRS TIME DELAY FUSES

Mersen CRN and CRS fuses are standard fuses, Type “D”, with 10kA short circuit rating. Type “D” fuses satisfy the Canadian Electrical Code requirement for low melting-point fuses.

DIMENSIONS - INCHES (MM)

250V CRN Fuses					
Ampere Rating	A	B	C	D	E
15-30	2.00 [50.8]	0.56 [14.2]			0.50 [12.7]
35-60	3.00 [76.2]	0.81 [20.6]			0.63 [16.0]
70-100	5.88 [149]	1.06 [26.9]	0.13 [3.18]	0.75 [19.1]	1.00 [25.4]
110-200	7.13 [181]	1.63 [41.4]	0.19 [4.76]	1.13 [28.7]	1.38 [35.1]
225-400	8.63 [219]	2.13 [54.1]	0.25 [6.35]	1.63 [41.4]	1.88 [47.8]
450-600	10.4 [264]	2.63 [66.8]	0.25 [6.35]	2.00 [50.8]	2.25 [57.2]
600V CRS Fuses					
15-30	5.00 [127]	0.81 [20.6]			0.63 [16.0]
35-60	5.50 [139]	1.06 [26.9]			0.63 [16.0]
70-100	7.88 [200]	1.38 [35.1]	0.13 [3.18]	0.75 [19.1]	1.00 [25.4]
110-200	9.63 [244]	1.88 [47.8]	0.19 [4.76]	1.13 [28.7]	1.38 [35.1]
225-400	11.6 [295]	2.63 [66.8]	0.25 [6.35]	1.63 [41.4]	1.88 [47.8]
450-600	13.4 [340]	3.13 [79.5]	0.25 [6.35]	2.00 [50.8]	2.25 [57.2]

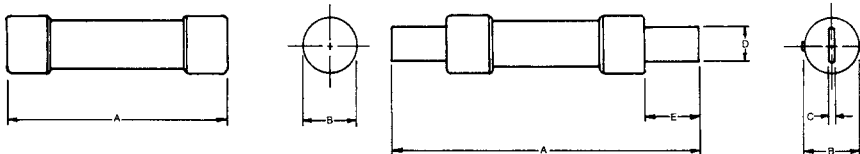

RATINGS:

CRN

- **Volts:** 250VAC
- **Amps:** 15 to 600A
- **I.R.:** 10kA I.R. AC

CRS

- **Volts:** 600VAC
- **Amps:** 15 to 600A
- **I.R.:** 10kA I.R. AC

APPROVALS:

- CSA Certified Type “D” 

CATALOG NUMBERS

250V Fuse Ampere Ratings*		
CRN15	CRN60	CRN200
CRN17-1/2	CRN70	CRN225
CRN20	CRN80	CRN250
CRN25	CRN90	CRN300
CRN30	CRN100	CRN350
CRN35	CRN110	CRN400
CRN40	CRN125	CRN450
CRN45	CRN150	CRN500
CRN50	CRN175	CRN600

* For 1/10 - 12A ratings use Tri-onic TR-R.

600V Fuse Ampere Ratings**		
CRS15	CRS60	CRS200
CRS17-1/2	CRS70	CRS225
CRS20	CRS80	CRS250
CRS25	CRS90	CRS300
CRS30	CRS100	CRS350
CRS35	CRS110	CRS400
CRS40	CRS125	CRS450
CRS45	CRS150	CRS500
CRS50	CRS175	CRS600

** For 1/10 - 12 ratings use Tri-onic TRS-R.

Fuse Pullers/Clip Clamps

CIRCUIT PROTECTION ACCESSORIES

PLASTIC FUSE PULLERS

Mersen plastic fuse pullers are fully insulated, made of high-dielectric, reinforced plastic with notched handles to provide a safe grip. Stronger and more durable than fiber pullers, they are permanently marked with the recommended fuse ampere range. Yellow color for safety.

Catalog No.	Description		Use with Fuses		
	Size	Length (in)	Ampere	Volts	Diameter (in)
34-001G	small	5	0-30	32-250	9/32-1/2
34-002G	pocket	7-1/2	0-100	250 600	-
34-003G	large	11-3/4	31-600 31-400	250 600	-

PLASTIC FUSE CLAMPS

Mersen fuse clip clamps are used to clamp fuse clips together onto a fuse ferrule or blade. An easy twist of the cap tightens the jaws against the clip, preventing heating by reducing resistance at the point where fuse and clip make contact. This helps prevent loss of spring tension due to annealing from overheating.

Catalog No.	Use with Fuse Clips			Weight (ounces)
	Type	Ampere	Volts	
32-001G	Ferrule	30	250	2
32-002G	Ferrule	60	250	
32-002G	Ferrule	30	600	
32-003G	Ferrule	60	600	
32-004G	knife blade	100	250	2
32-005G		200	or	2
32-006G*		400	600	8
32-007G		600		8

* Wide jaws permit clamping split clips.

NYLON FUSE PULLERS

Mersen nylon fuse pullers are fully insulated, made of high-dielectric, high impact nylon with no-slip handles and protective finger stops for greater safety when inserting fuses. Yellow color for safety.

Catalog No.	Description		Use with Fuses	
	Size	Length (in)	Ampere	Volts
34-015G	small	5	0-30	250
34-016G	medium	7-1/4	0-100 0-60	250 600

