

Precision Cylinder

MTS Series

ø8, ø12, ø16, ø20, ø25, ø32, ø40

Cylinder with ball spline



- MXH
- MXS
- MXQ
- MXQ
- MXF
- MXW
- MXJ
- MXP
- MXY
- MTS

Series Variations

Model	Standard stroke (mm)												Rod end configuration	Cushion	End lock	Made to Order	
	5	10	15	20	25	30	50	75	100	125	150	175				200	Rod through-hole
MTS8	●	●	●	●	●	●										●	●
MTS12					●	●	●	●	●								●
MTS16					●	●	●	●	●	●							●
MTS20					●	●	●	●	●	●	●	●	●				●
MTS25					●	●	●	●	●	●	●	●	●	●	●		●
MTS32					●	●	●	●	●	●	●	●	●	●	●	●	●
MTS40					●	●	●	●	●	●	●	●	●	●	●	●	●

- D-
- X



Precision Cylinder

Precision Cylinder

Non-rotating accuracy: 0.1° or less
(0.2° or less for $\varnothing 8$, within allowable torque values)

MTS8

Small size $\varnothing 8$ introduced to series

- Rod through-hole allows vacuum piping (Made-to-order). Lifting and transfer of small electronic parts is possible with short mounting pitch.

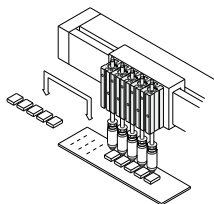

- Piping is possible from two directions.

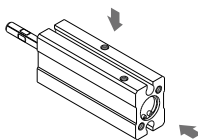

- Short mounting pitch: 15 mm

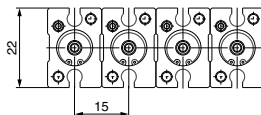

- Uses new type compact auto switches ($\varnothing 8$ only). Two auto switches can be mounted even with the minimum 5 stroke (mm).



Mounting space reduced

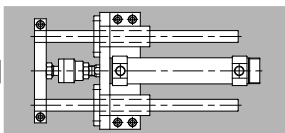
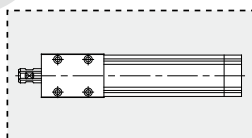

Two types of rod end configuration

Standard: Rod end female threads
Option: Rod end male thread (Using stud bolt)

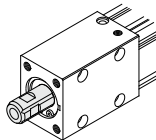

Rod end female thread

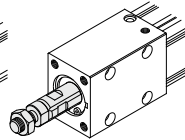

Rod end male thread

Auto switch capable on four sides
(Two sides for $\varnothing 8$)

Three types of mounting are possible

— Tapped holes mounting —

— Through-holes mounting —

Bottom mounting

Front mounting

Both sides mounting

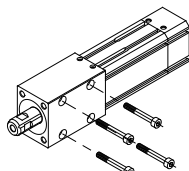
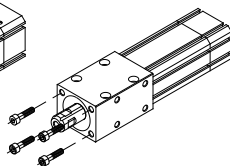
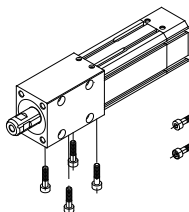

(Side mounting is not possible for size $\varnothing 8$.)

with Internal Guide Function.

MTS Series

Deflection: 0.1 mm or less
(For MTS12-25, within allowable lateral load values)

Reduced labor for design and assembly

Mounting is possible in high accuracy.

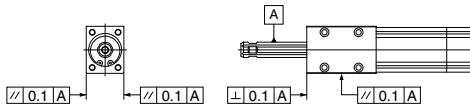

Parallelism of mounting surfaces (side, bottom) to rod: 0.1 mm or less
Squareness of mounting surface (front) to rod: 0.1 mm or less

Air cushion standardized
(ø8 equipped with rubber bumper)

Rear end lock type added to series (ø12 to ø40)



Sealing and durability equivalent to current round rod models have been achieved with a specially configured rod seal.

Stroke adjustment mechanism/ Made to Order Specifications

Stroke adjustment is possible on the rod extension side.
Stroke adjustment range: 0 to 10 mm (ø8)
: 0 to 25 mm (ø12 to ø40)

Application Example

●Picking & placing

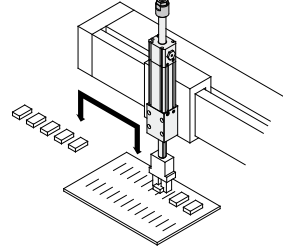

●Transferring of workpieces

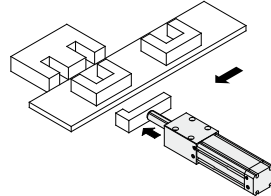

●Positioning of pins

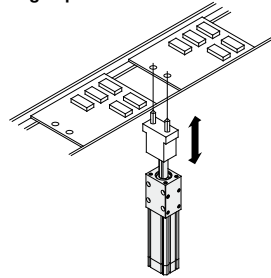

MXH

MXS

MXQ

MXQ

MXF

MXW

MXJ

MPX

MXY

MTS

D-

-X



Model Selection

⚠ Caution Confirmation of theoretical output is required separately.
Refer to “Theoretical Output” on page 385.

Selection Conditions Follow the tables below in order to determine selection conditions and choose one selection graph.

Vertical Mounting

Mounting orientation								
	Maximum speed (mm/s)	Up to 100	Up to 200	Up to 300	Up to 400	Up to 500	Up to 600	Up to 800
Stroke (mm)	All strokes							
Selection graph	ø8	(1)	—	(2)	—	(3)	—	—
	ø12 to ø40	—	(4)	—	(5)	—	(6)	(7)

Horizontal Mounting

Mounting orientation															
	* Direction for L can be up, down, left, right, or diagonal.														
Maximum speed (mm/s)	Up to 300			Up to 500			Up to 600				Up to 800				
Stroke (mm)	Up to 10	Up to 20	Up to 30	Up to 10	Up to 20	Up to 30	Up to 50	Up to 100	Up to 150	Up to 200	Up to 50	Up to 100	Up to 150	Up to 200	
Selection graph	ø8	(8)	(9)	(10)	(11)	(12)	(13)	—	—	—	—	—	—	—	
	ø12 to ø40	—	—	—	—	—	—	(14)	(15)	(16)	(17)	(18)	(19)	(20)	(21)

* L: Overhang The distance between the cylinder's central axis and the load center of gravity

⚠ Caution

- In the case of horizontal mounting, when the load center of gravity is beyond the rod end, add that distance to the stroke to select a graph.

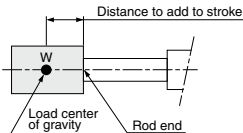

Selection Example

1. Selection conditions
- Mounting: Vertical
 - Maximum speed: 800 mm/s
 - Overhang: 50 mm
 - Load mass: 2 kg

Refer to graph (7) based on vertical mounting and the maximum speed of 800 mm/s. On graph (7), find the intersecting point for the overhang of 50 mm and the load mass of 2 kg to determine ø32.

2. Selection conditions
- Mounting: Horizontal
 - Maximum speed: 600 mm/s
 - Stroke: 125 mm
 - Overhang: 80 mm
 - Load mass: 0.7 kg

Refer to graph (16) based on horizontal mounting, the maximum speed of 600 mm/s, and 125 mm stroke. On graph (16), find the intersecting point for the overhang of 80 mm and the load mass of 0.7 kg to determine ø25.

Vertical Mounting

ø8

Graph (1) Maximum Speed: Up to 100 (mm/s)

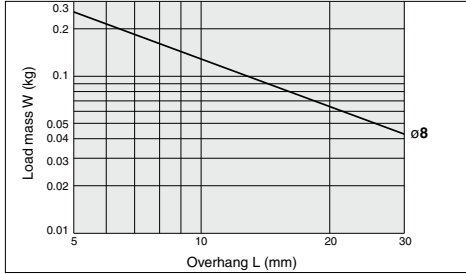

Graph (2) Maximum Speed: Up to 300 (mm/s)

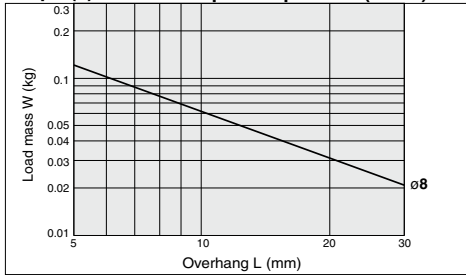

Graph (3) Maximum Speed: Up to 500 (mm/s)

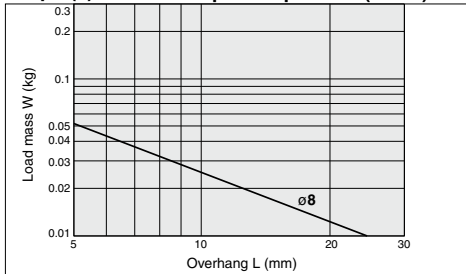

ø12 to ø40

Graph (4) Maximum Speed: Up to 200 (mm/s)

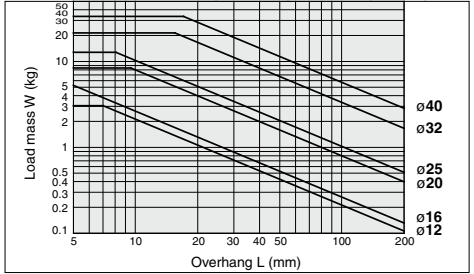

Graph (5) Maximum Speed: Up to 400 (mm/s)

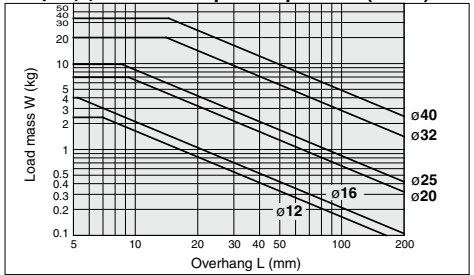

Graph (6) Maximum Speed: Up to 600 (mm/s)

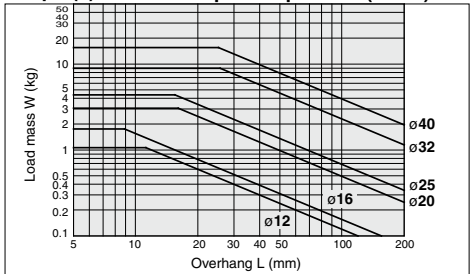

Graph (7) Maximum Speed: Up to 800 (mm/s)

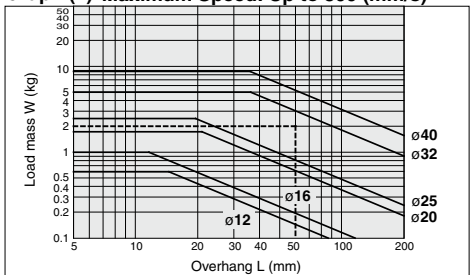

- MXH
- MXS
- MXQ
- MXF
- MXW
- MXJ
- MXP
- MXY
- MTS

- D-
- X

Horizontal Mounting

ø8

Maximum speed: Up to 300 mm/s

Graph (8) Stroke: Up to 10 stroke

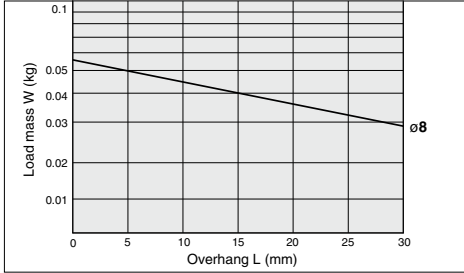

Graph (9) Stroke: Up to 20 stroke

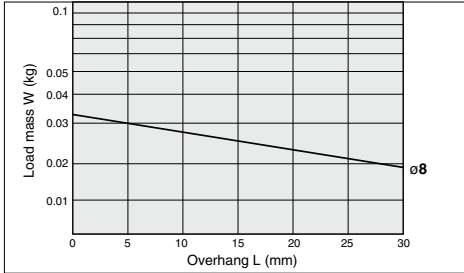

Graph (10) Stroke: Up to 30 stroke

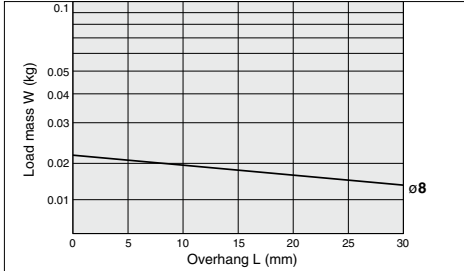

Maximum speed: Up to 500 mm/s

Graph (11) Stroke: Up to 10 stroke

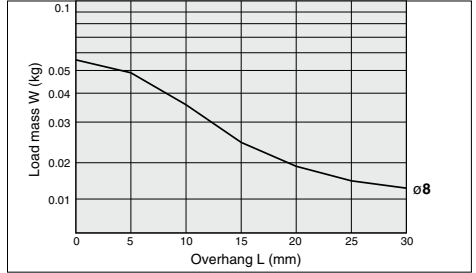

Graph (12) Stroke: Up to 20 stroke

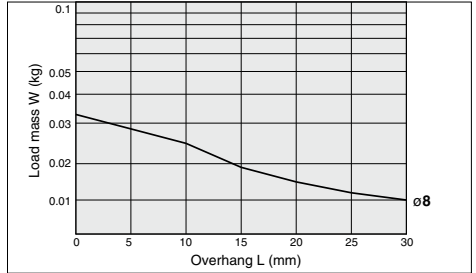

Graph (13) Stroke: Up to 30 stroke

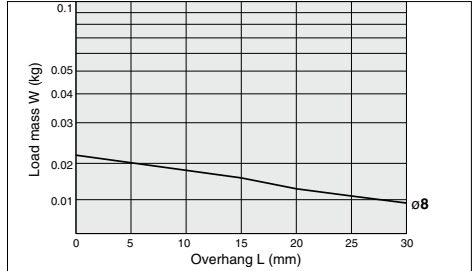

ø12 to ø40

Maximum speed: Up to 600 mm/s

Graph (14) Stroke: Up to 50 stroke

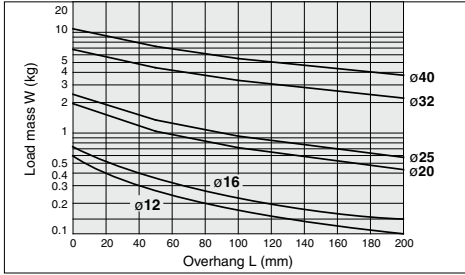

Graph (15) Stroke: Up to 100 stroke

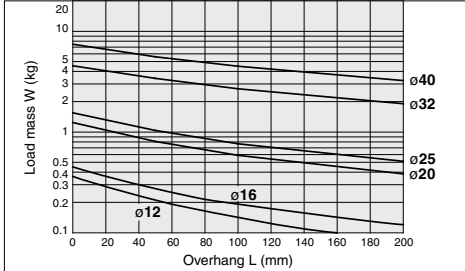

Graph (16) Stroke: Up to 150 stroke

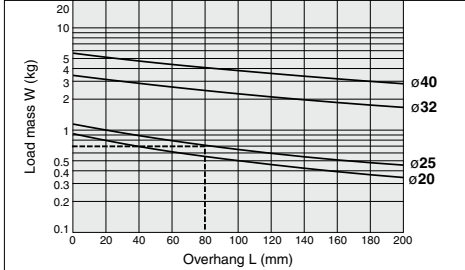

Graph (17) Stroke: Up to 200 stroke

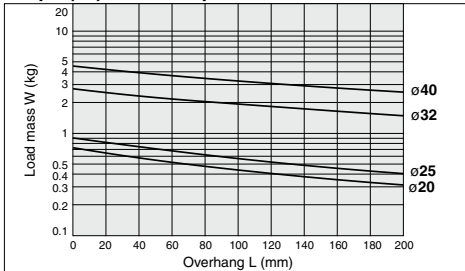

Maximum speed: Up to 800 mm/s

Graph (18) Stroke: Up to 50 stroke

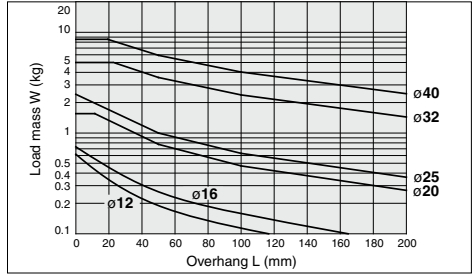

Graph (19) Stroke: Up to 100 stroke

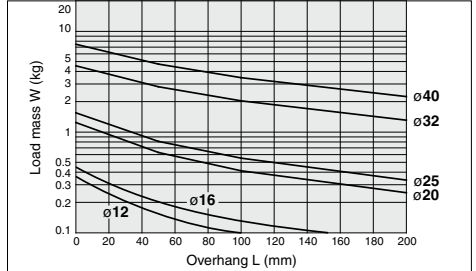

Graph (20) Stroke: Up to 150 stroke

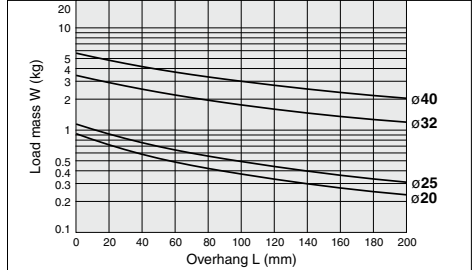

Graph (21) Stroke: Up to 200 stroke

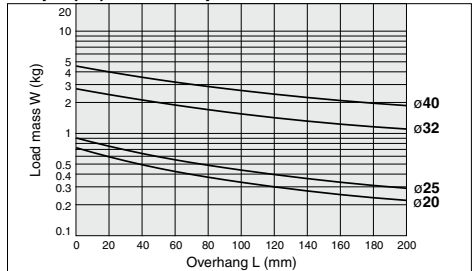

- MXH
- MXS
- MXQ
- MXF
- MXW
- MXJ
- MXP
- MXY
- MTS

- D-
- X

Spline Rod Displacement

Warp Angle

Displacement angle of spline rod due to torque load

The displacement angle when a static load is applied in the direction of the arrow, with the spline rod retracted.

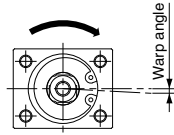

ø8

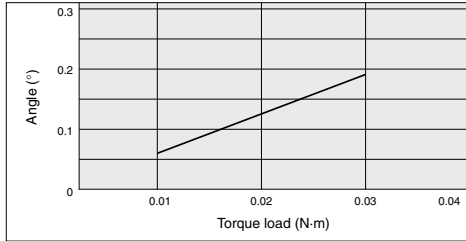

ø25

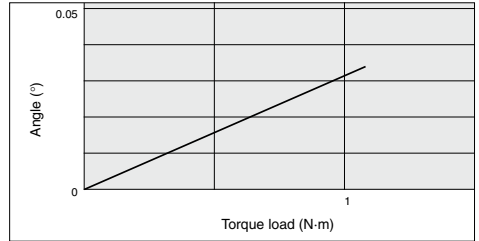

ø12

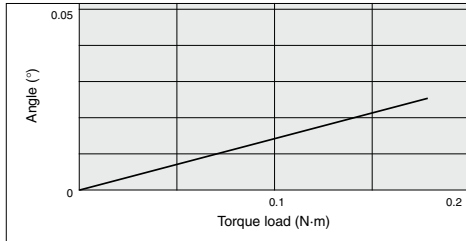

ø32

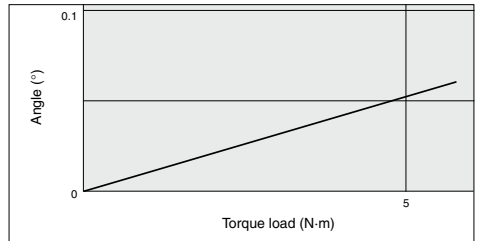

ø16

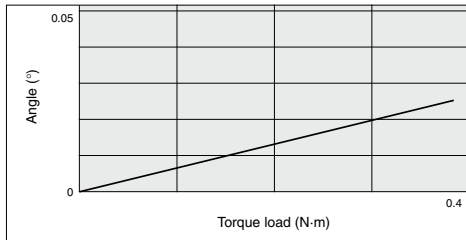

ø40

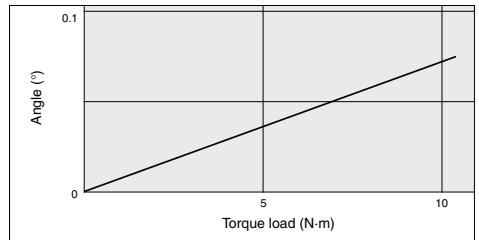

ø20

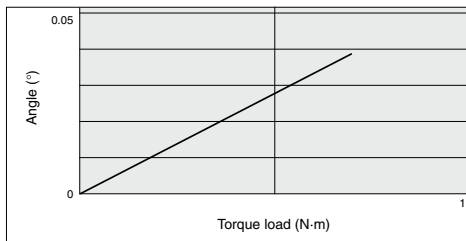

Deflection Amount

Displacement of spline rod due to pitch moment load
 Displacement of the rod end when a static load is applied in the direction of the arrow, with the spline rod fully extended.

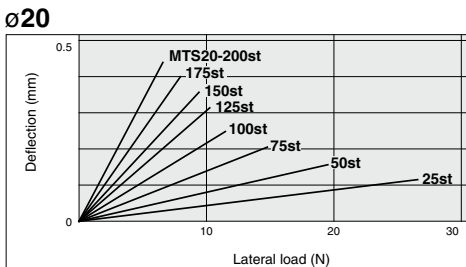
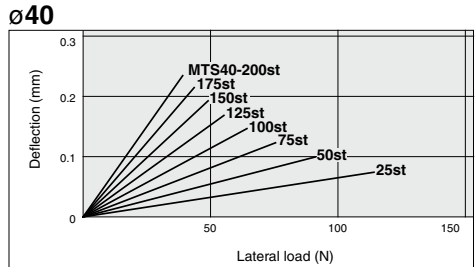
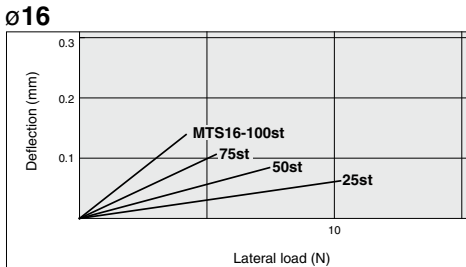
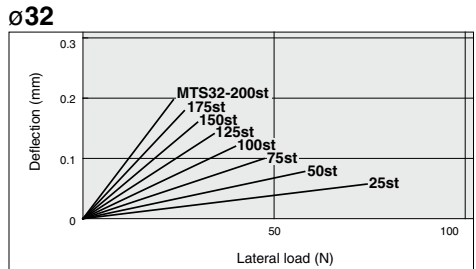
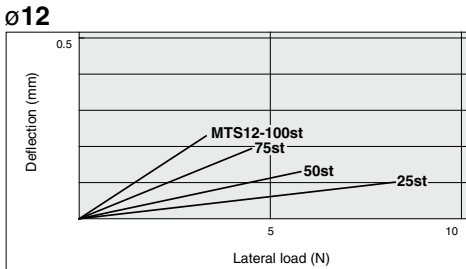
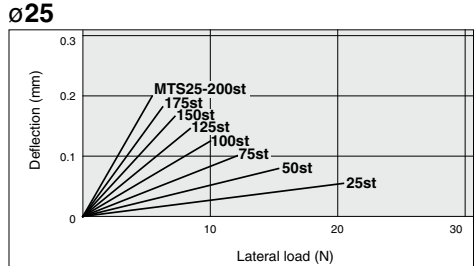
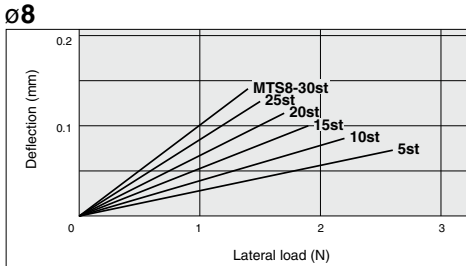
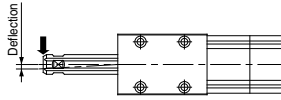

Caution on Design

⚠ Caution

1. Displacement may increase after an impact load has been applied.

If an impact load is applied to the spline rod, the guide unit may be permanently deformed and displacement may increase.

- MXH
- MXS
- MXQ
- MXQ
- MXF
- MXW
- MXJ
- MXP
- MXY
- MTS

- D-
- X

Precision Cylinder

MTS Series

ø8, ø12, ø16, ø20, ø25, ø32, ø40

How to Order

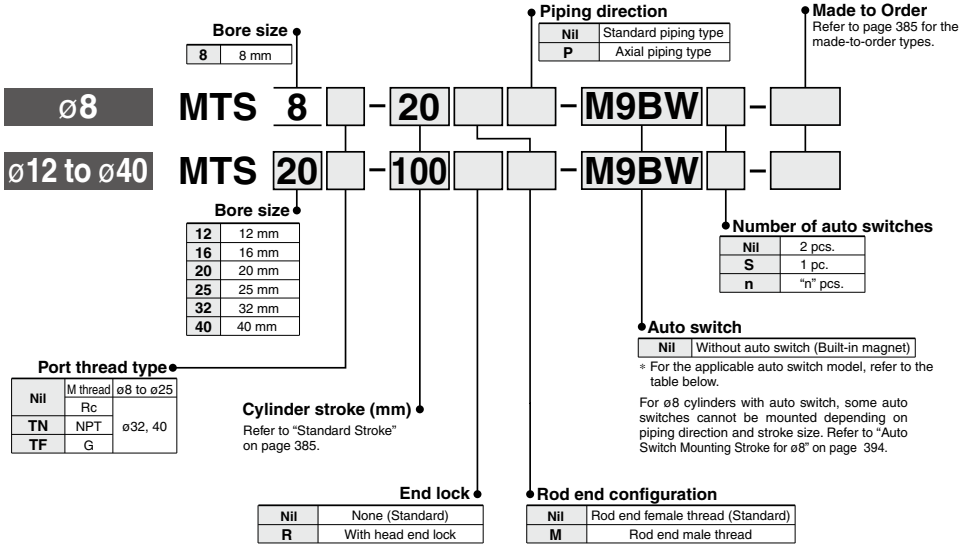

Applicable Auto Switches

Refer to pages 1119 to 1245 for further information on auto switches.

Type	Special function	Electrical entry	Indicator light	Wiring (Output)	Load voltage		Auto switch model		Lead wire length (m)			Pre-wired connector	Applicable load				
					DC	AC	Perpendicular	In-line	0.5 (Nil)	1 (M)	3 (L)		5 (Z)				
Solid state auto switch	—	Grommet	Yes	3-wire (NPN)	5 V, 12 V	—	M9NV	M9N	●	●	●	○	○	IC circuit	Relay, PLC		
				3-wire (PNP)			M9PV	M9P	●	●	●	○	○				
	2-wire			M9BV	M9B		●	●	●	○	○	—					
	3-wire (NPN)			M9NVV	M9NW		●	●	●	○	○	IC circuit					
	3-wire (PNP)			M9PWW	M9PW		●	●	●	○	○	—					
	2-wire			M9BWW	M9BW		●	●	●	○	○	—					
Reed auto switch	—	Grommet	Yes	3-wire (NPN)	5 V	—	M9AV ^{*1}	M9NA ^{*1}	○	○	●	○	○	IC circuit	—		
				3-wire (PNP)			M9PAV ^{*1}	M9PA ^{*1}	○	○	●	○	○				
	2-wire			M9BAV ^{*1}	M9BA ^{*1}		○	○	●	○	○	—					
	3-wire (NPN equivalent)			24 V	12 V		A96V	A96	●	—	●	—	—			IC circuit	—
							100 V	A93V ^{*2}	A93	●	●	●	●			—	—
	No			24 V	12 V		100 V or less	A90V	A90	●	—	●	—			—	IC circuit

*1 Water resistant type auto switches can be mounted on the above models, but in such case SMC cannot guarantee water resistance.

Consult with SMC regarding water resistant types with the above model numbers.

*2 1 m type lead wire is only applicable to D-A93.

* Lead wire length symbols: 0.5 m..... Nil (Example) M9NW
 1 m..... M (Example) M9NWM
 3 m..... L (Example) M9NWL
 5 m..... Z (Example) M9NWX

* Solid state auto switches marked with "○" are produced upon receipt of order.

* Since there are other applicable auto switches than listed, refer to page 395 for details.

* For details about auto switches with pre-wired connector, refer to pages 1192 and 1193.

* Auto switches are shipped together (not assembled).

Specifications



Made to Order
Made to Order Specifications
 (For details, refer to pages 1247 to 1440.)

Symbol	Specifications
-XC8	Adjustable stroke cylinder/Adjustable extension type
-XC38	Vacuum (Rod through-hole)

Bore size (mm)		8	12	16	20	25	32	40
Spine rod size (mm)		4	6	8	10	13	16	20
Fluid		Air						
Min. operating pressure	Without end lock pressure	0.15 MPa	0.12 MPa		0.1 MPa			
	With end lock *	—	0.17 MPa		0.15 MPa			
Maximum operating pressure		0.7 MPa						
Proof pressure		1.0 MPa						
Ambient and fluid temperature		-10 to 60° (No freezing)						
Bearing type		Ball spline						
Cushion		Rubber bumper	Air cushion					
Effective cushion length (mm)		—	9	10	11	12	17	17
Lubrication		Not required (Non-lube)						
Piston speed (mm/s)		50 to 500		50 to 800				
Allowable kinetic energy (J)		0.02	0.19	0.32	0.55	0.78	1.6	2.8
Stroke tolerance		+1.0 0 mm						
Non-rotating accuracy		0.2° or less (Within allowable torque values)		0.1° or less (Within allowable torque values)				
Piping port size	—	M3 x 0.5	M5 x 0.8	M5 x 0.8	M5 x 0.8	M5 x 0.8	Rc 1/8	Rc 1/8
	TN	—	—	—	—	—	NPT 1/8	NPT 1/8
	TF	—	—	—	—	—	G 1/8	G 1/8

* Except lock unit, 0.12 MPa for ø12 and 16; 0.10 MPa for ø20 to 40 respectively.

Standard Stroke

Bore size (mm)	Standard stroke (mm)
8	5, 10, 15, 20, 25, 30
12, 16	25, 50, 75, 100
20, 25, 32, 40	25, 50, 75, 100, 125, 150, 175, 200

* Strokes other than the above are produced upon receipt of order.

End Lock Specifications

Bore size (mm)	12	16	20	25	32	40
Lock position	Head end only					
Holding force (Max.) (N)	29	53	82	125	211	329
Backlash	1 mm					
Manual release	Non-lock type only					

Stud Bolt Part No.

Bore size (mm)	Part no.
8	MT-S8
12	MT-S12
16	MT-S16
20	MT-S20
25	MT-S25
32	MT-S32
40	MT-S40

* Replacement parts for rod end male thread.
 * Rod end nut is attached.

⚠ Caution

Mounting

* When attaching or removing loads, be sure to do so while securing the spline rod's width across flats and not to apply a rotating torque on the spline nut.
 If rotational torque must be applied due to unavoidable circumstances, use the table below to make sure the allowable rotational torque is not exceeded.

Bore size (mm)	8	12	16	20	25	32	40
Allowable rotating torque (N·m)	0.03	0.18	0.38	0.69	1.08	5.75	10.4

Theoretical Output

Bore size (mm)	Operating direction	Piston area (mm ²)	Operating pressure (MPa)						
			0.2	0.3	0.4	0.5	0.6	0.7	
8	OUT	50	10	15	20	25	30	35	
	IN	37	8	11	15	19	22	26	
12	OUT	113	23	34	45	57	68	79	
	IN	84	17	25	34	42	50	59	
16	OUT	201	40	60	80	101	121	141	
	IN	150	30	45	60	75	90	105	
20	OUT	314	63	94	126	157	188	220	
	IN	235	47	71	94	118	141	165	
25	OUT	490	98	147	196	245	294	343	
	IN	358	72	107	143	179	215	251	
32	OUT	804	161	241	322	402	482	563	
	IN	603	121	181	241	302	362	422	
40	OUT	1,256	251	377	502	628	754	879	
	IN	942	188	283	377	471	565	659	

⚠ Caution Do not apply a load that is 50% or more of the theoretical output.

Weight

Model	Standard stroke (mm)												End lock additional weight	
	5	10	15	20	25	30	50	75	100	125	150	175		200
MTS8	36	40	44	48	52	56	—	—	—	—	—	—	—	—
MTS12	—	—	—	—	138	—	157	175	194	—	—	—	—	29
MTS16	—	—	—	—	186	—	222	258	294	—	—	—	—	34
MTS20	—	—	—	—	350	—	400	450	500	549	599	649	699	42
MTS25	—	—	—	—	487	—	547	608	669	729	790	851	912	55
MTS32	—	—	—	—	918	—	1,000	1,083	1,165	1,247	1,330	1,412	1,495	90
MTS40	—	—	—	—	1,420	—	1,533	1,645	1,758	1,870	1,983	2,095	2,208	133

MXH
 MXS
 MXQ
 MXQ
 MXF
 MXW
 MXJ
 MXP
 MXY
 MTS

D-□
 -X□

MTS Series

Construction

Basic type

ø8

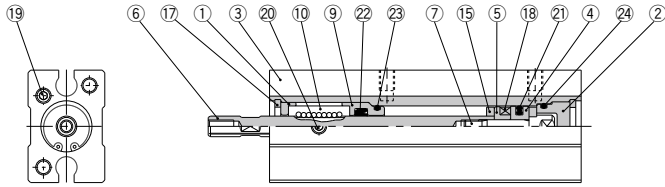

ø12 to ø40



Rod cross section for ø12, ø16, ø20, and ø25

Rod cross section for ø32 and ø40

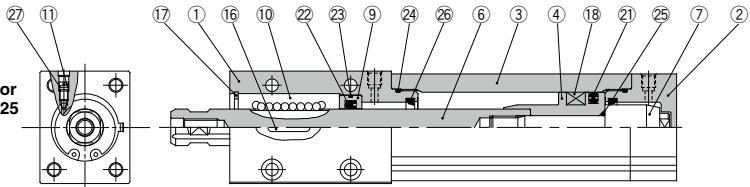

With end lock

ø12 to ø40

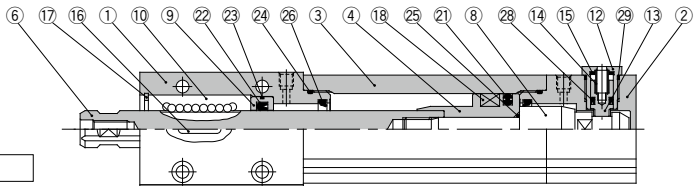

⚠ Caution

Not able to disassemble.

A special tool is required when disassembling or reassembling the cylinder. When replacing the seal, this work needs to be carried out at SMC's factory. Please contact SMC sales representatives.

Component Parts

No.	Description	Material	Qty.	Note
1	Rod cover	Aluminum alloy	1	Clear anodized
2	Head cover	Aluminum alloy	1	Clear anodized
3	Cylinder tube	Aluminum alloy	1	Hard anodized
4	Piston	Aluminum alloy	1	
5	Spacer for switch type	Aluminum alloy	1	Chromated
6	Spline rod	Stainless steel	1	ø8: Quenched
		Carbon steel	1	ø12 to ø40: Quenched/Hard chrome plated
7	Cushion bolt	Stainless steel	1	ø8 to ø16
		Carbon steel	1	ø20 to ø40: Zinc chromated
8	End lock bolt	Carbon steel	1	Quenched/Zinc chromated
9	Collar	Aluminum alloy	1	Chromated
10	Spline nut	—	1	
11	Cushion needle	Carbon steel	2	Nickel plated
12	Cap	Copper alloy	1	Nickel plated
13	Lock piston	Carbon steel	1	Quenched/Hard chrome plated
14	Lock spring	Steel wire	1	Zinc chromated

No.	Description	Material	Qty.	Note
15	Bumper	Urethane	2	ø8
			1	ø12 to ø40
16	Key	Carbon steel	1	
17	Type C retaining ring for hole	Carbon tool steel	2	ø8: Phosphate coated
			1	ø12 to ø40: Phosphate coated
18	Magnet	—	1	
19	Plug	Alloy steel	3	Nickel plated
20	Hexagon socket head set screw	Alloy steel	1	Black zinc chromated
21	Piston seal	NBR	1	
22	Spline seal	NBR	1	Rod seal for ø8
23	Collar gasket	NBR	1	
24	Tube gasket	NBR	1	ø8
			2	ø12 to ø40
25	Piston gasket	NBR	1	
26	Cushion seal	Urethane	2	
27	Needle gasket	NBR	2	
28	Piston seal for lock	NBR	1	
29	Cap gasket	NBR	1	

Dimensions: $\varnothing 8$

MTS8

Basic type

Note) Spline rod's width across flats have nothing to do with the position of the body mounting face.

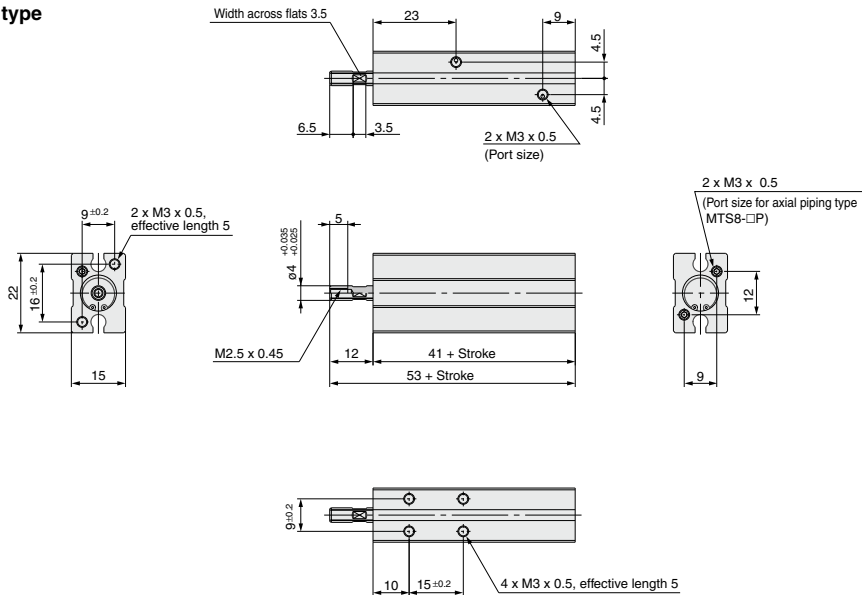

Rod end male thread

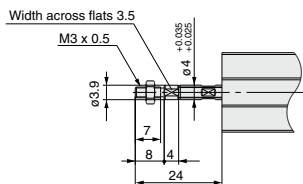

Stud bolt part no.: MT-S8
Material: Chromium molybdenum steel
(Nickel plated)

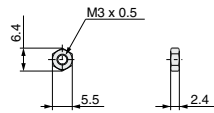

Rod end nut part no.: NTJ-006A
Material: Carbon steel
(Zinc chromated)

- MXH**
- MXS**
- MXQ** □
- MXQ**
- MXF**
- MXW**
- MXJ**
- MXP**
- MXY**
- MTS**

- D**-□
- X**□

Dimensions: $\varnothing 12$

MTS12

Basic type

Note) Spline rod's width across flats have nothing to do with the position of the body mounting face.

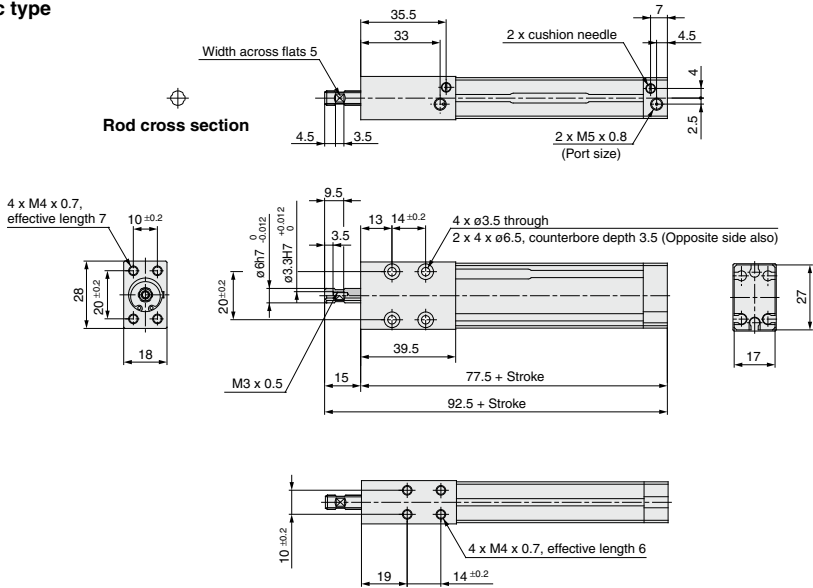

Rod end male thread

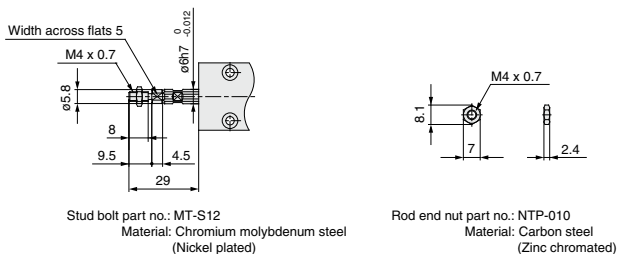

With end lock

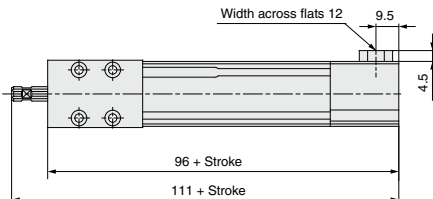

Dimensions: $\phi 16$

MTS16

Basic type

Note) Spline rod's width across flats have nothing to do with the position of the body mounting face.

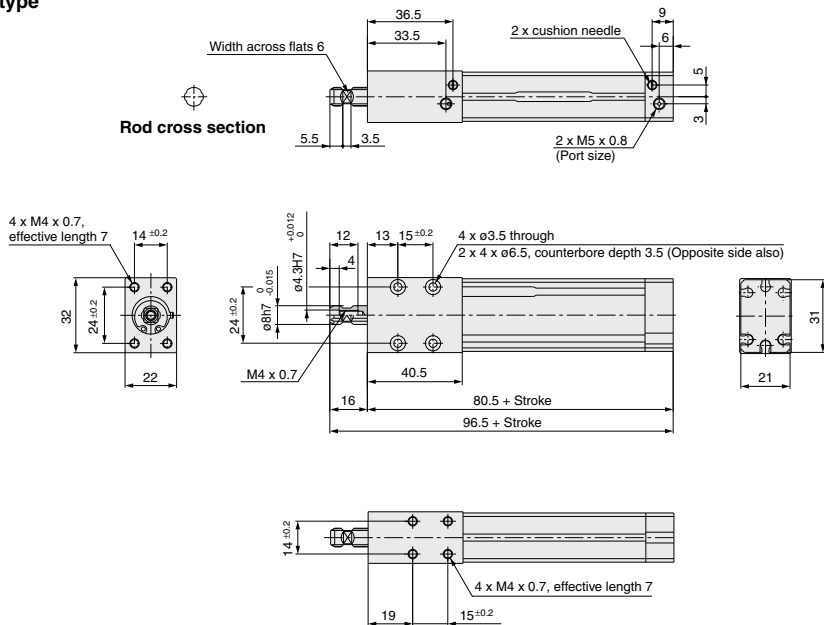

- MXH
- MXS
- MXQ
- MXQ
- MXF
- MXW
- MXJ
- MXP
- MXY
- MTS

Rod end male thread

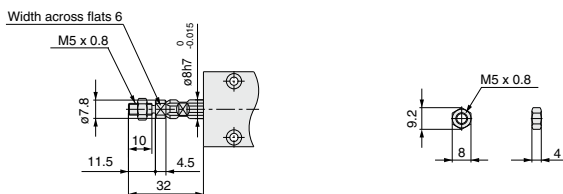

Stud bolt part no.: MT-S16
Material: Chromium molybdenum steel
(Nickel plated)

Rod end nut part no.: NTJ-015A
Material: Carbon steel
(Zinc chromated)

With end lock

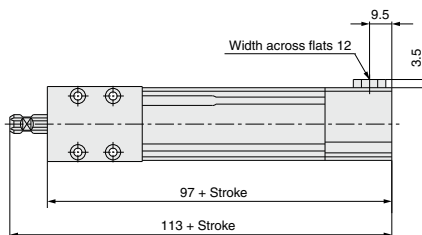

- D-
- X

MTS Series

Dimensions: $\phi 20$

MTS20

Basic type

Note) Spline rod's width across flats have nothing to do with the position of the body mounting face.

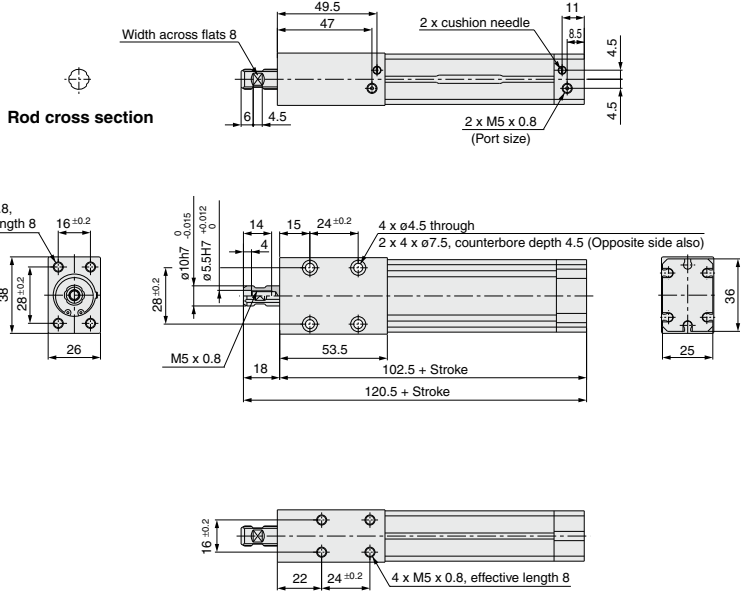

Rod end male thread

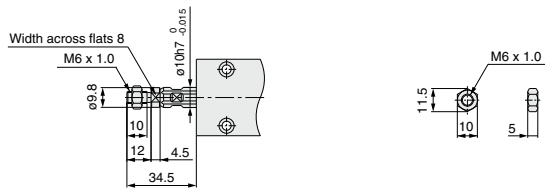

Stud bolt part no.: MT-S20
Material: Chromium molybdenum steel
(Nickel plated)

Rod end nut part no.: NT-015A
Material: Carbon steel
(Zinc chromated)

With end lock

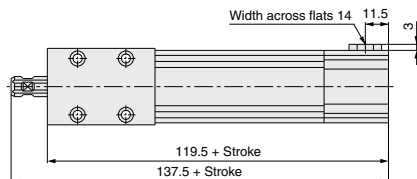

Dimensions: $\varnothing 25$

MTS25

Basic type

Note) Spline rod's width across flats have nothing to do with the position of the body mounting face.

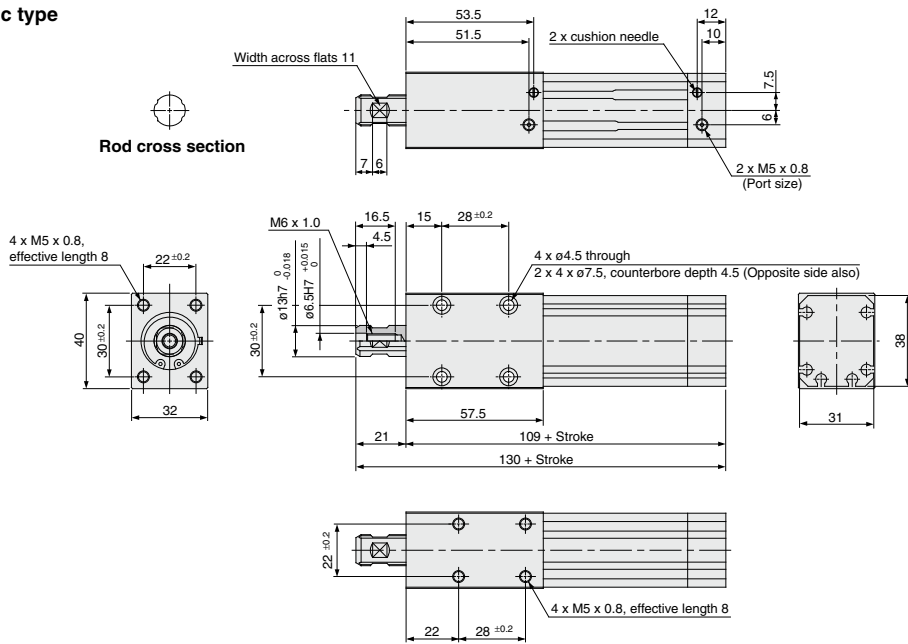

- MXH
- MXS
- MXQ
- MXQ
- MXF
- MXW
- MXJ
- MXP
- MXY
- MTS

Rod end male thread

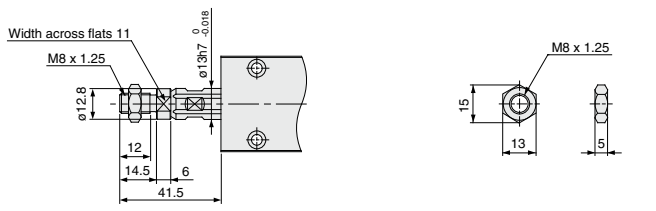

Stud bolt part no.: MT-S25
Material: Chromium molybdenum steel (Nickel plated)

Rod end nut part no.: NT-02
Material: Carbon steel (Zinc chromated)

With end lock

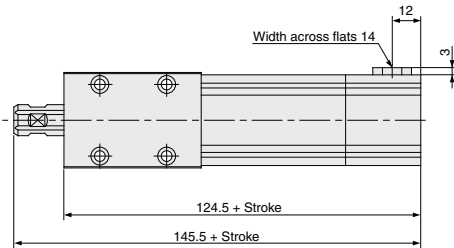

- D-
- X



MTS Series

Dimensions: $\phi 32$

Note) Spline rod's width across flats have nothing to do with the position of the body mounting face.

MTS32

Basic style

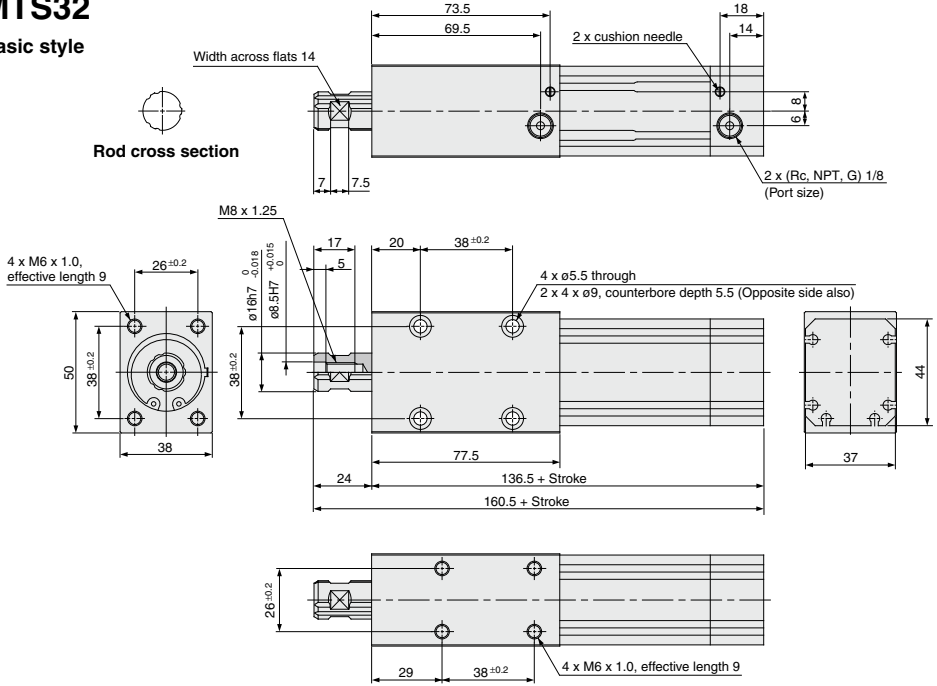

Rod end male thread

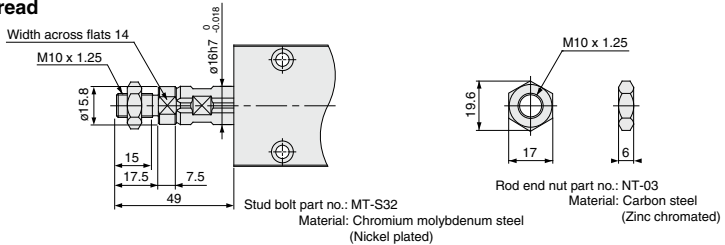

With end lock

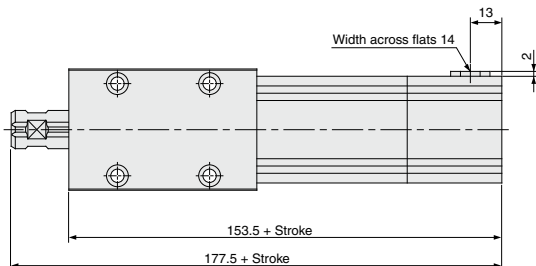

Dimensions: $\phi 40$

Note) Spline rod's width across flats have nothing to do with the position of the body mounting face.

MTS40

Basic type

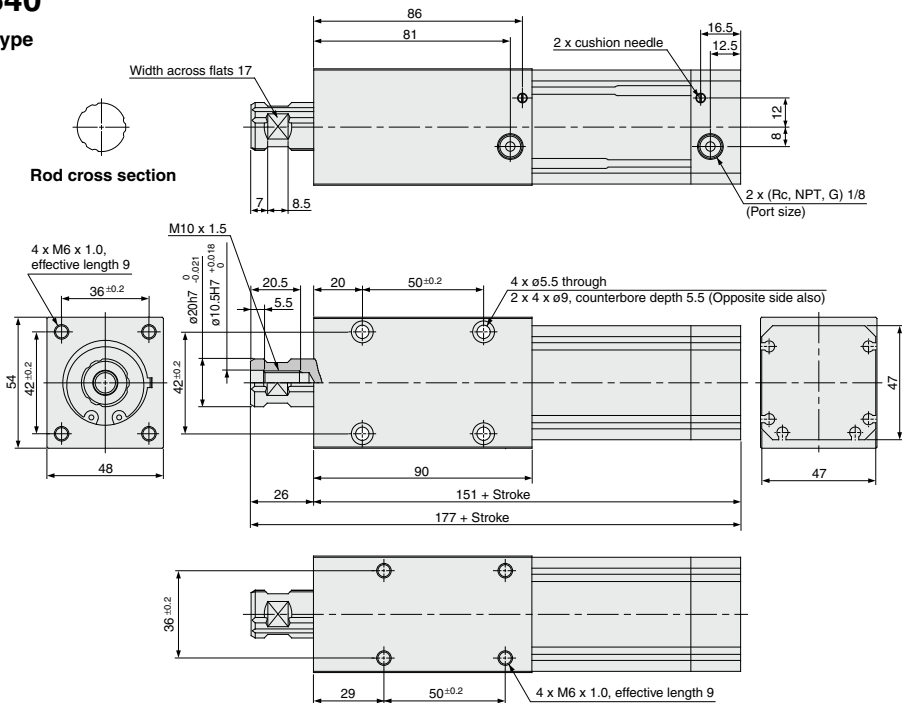

- MXH
- MXS
- MXQ
- MXQ
- MXF
- MXW
- MXJ
- MXP
- MXY
- MTS

Rod end male thread

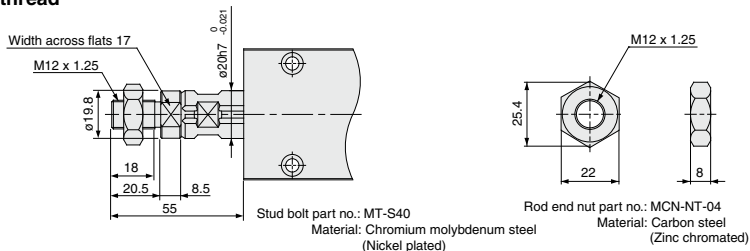

With end lock

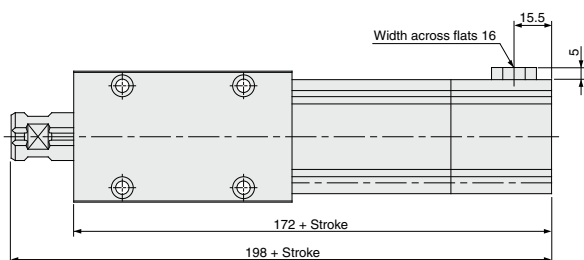

- D-
- X



Auto Switch Mounting 1

Auto Switch Proper Mounting Position (Detection at Stroke End) and Its Mounting Height

ø8

D-A9□
D-M9□
D-M9□W
D-M9□A

D-A9□V
D-M9□V
D-M9□WV
D-M9□AV

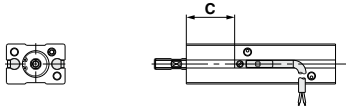
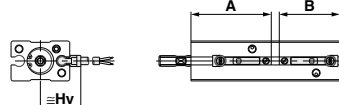
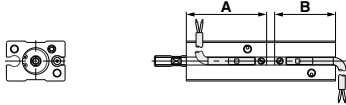

D-F8□

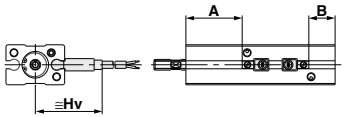

Operating Range

(mm)

Auto switch model	Bore size						
	8	12	16	20	25	32	40
D-A9□/A9□V	5	6	7.5	7.5	8	7	8
D-M9□/M9□V D-M9□W/M9□WV D-M9□A/M9□AV	3.0	4.5	4	4.5	5	4.5	5.5
D-F8□	2.5	4	4.5	4.5	4.5	4.5	5

* Since this is a guideline including hysteresis, not meant to be guaranteed. (Assuming approximately 30% dispersion.) There may be the case it will vary substantially depending on an ambient environment.

Auto Switch Proper Mounting Position

(mm)

Bore size (mm)	Reed auto switch						Solid state auto switch						2-color indicator solid state auto switch								
	D-A9□		D-A9□V		D-M9□		D-M9□V		D-F8□		D-M9□W, D-M9□A		D-M9□WV, D-M9□AV								
	A	B	C	A	B	Hv	A	B	C	A	B	Hv	A	B	C	A	B	Hv			
8	36	25	16	36	25	15	32	21	20	32	21	17.5	18	7	25	32	21	20	32	21	17.5

Note) Adjust the auto switch after confirming the operating conditions in the actual setting.

Auto Switch Mounting Stroke for ø8

Piping direction	Mounting condition	Applicable auto switch	Stroke (mm)						Note
			5	10	15	20	25	30	
Standard piping type ⁽¹⁾ 	2 pcs. on same side 	D-A9□	×	×	×	○	○	○	(2)
		D-M9□, D-M9□W, D-M9□A	×	×	×	○	○	○	(2)
		D-A9□V	×	×	×	○	○	○	
	1 pc. each on 2 sides 	D-A9□	×	○	○	○	○	○	(2)
		D-M9□, D-M9□W, D-M9□A	○	○	○	○	○	○	(2)
		D-A9□V	×	○	○	○	○	○	
Axial piping type 	2 pcs. on same side 	D-A9□	×	×	×	○	○	○	(2)
		D-M9□, D-M9□W, D-M9□A	×	×	×	○	○	○	(2)
		D-A9□V	×	×	×	○	○	○	
	1 pc. each on 2 sides 	D-M9□V, D-M9□WV, D-M9□AV	×	×	○	○	○	○	
		D-F8□	○	○	○	○	○	○	
		D-A9□	×	○	○	○	○	○	(2)
	D-M9□, D-M9□W, D-M9□A	○	○	○	○	○	○	(2)	
	D-A9□V	×	○	○	○	○	○		
	D-M9□V, D-M9□WV, D-M9□AV	○	○	○	○	○	○		
		D-F8□	○	○	○	○	○		

Note 1) With the standard piping type, solid state auto switches D-F8□, D-M9□V, D-M9□WV and D-M9□AV with perpendicular electrical entry cannot be mounted due to the interference of the fitting and speed controller.

○ ... Mountable
× ... Not mountable

Note 2) When mounting auto switches with in-line electrical entry, allow a space of 10 mm or more at the rear end to prevent lead wire interference.

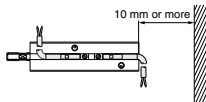

Auto Switch Proper Mounting Position (Detection at Stroke End) and Its Mounting Height

ø12 to ø40

D-A9□
D-M9□
D-M9□W
D-M9□A

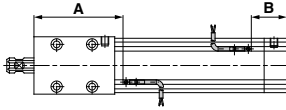

ø12/16/20

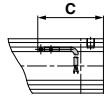

ø25/32/40

D-A9□V
D-M9□V
D-M9□WV
D-M9□AV

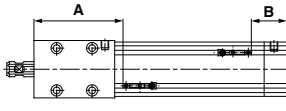

ø12/16/20

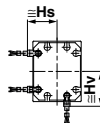

ø25/32/40

- MXH
- MXS
- MXQ□
- MXQ
- MXF
- MXW
- MXJ
- MXP
- MXY
- MTS

Auto Switch Proper Mounting Position

Bore size (mm)	Reed auto switch								Solid state auto switch								2-color indicator solid state auto switch							
	D-A9□			D-A9□V					D-M9□			D-M9□V					D-M9□W/D-M9□A			D-M9□WV/D-M9□AV				
	A	B	C	A	B	Hs	Hv	A	B	C	A	B	Hs	Hv	A	B	C	A	B	Hs	Hv			
12	42	15.5	35.5	42	15.5	13	18	46	19.5	31.5	46	19.5	15	20	46	19.5	31.5	46	19.5	15	20			
16	43.5	17	37	43.5	17	15	20	47.5	21	33	47.5	21	17	22	47.5	21	33	47.5	21	17	22			
20	59.5	23	43	59.5	23	17	22.5	63.5	27	39	63.5	27	19	24.5	63.5	27	39	63.5	27	19	24.5			
25	63	26	46	63	26	20	23.5	67	30	42	67	30	22	25.5	67	30	42	67	30	22	25.5			
32	84.5	32	52	84.5	32	23	26.5	88.5	36	48	88.5	36	25	28.5	88.5	36	48	88.5	36	25	28.5			
40	98.5	32.5	52.5	98.5	32.5	28	28	102.5	36.5	48.5	102.5	36.5	30	30	102.5	36.5	48.5	102.5	36.5	30	30			

Note) Adjust the auto switch after confirming the operating conditions in the actual setting.

Other than the applicable auto switches listed in "How to Order", the following auto switches can be mounted. For detailed specifications, refer to pages 1119 to 1245.

Auto switch type	Model	Electrical entry (Fetching direction)	Features	Applicable bore size (mm)
Solid state	D-F8N	Grommet (Perpendicular)	With indicator light	ø8 to ø40
	D-F8P			
	D-F8B			

* Normally closed (NC = b contact), solid state auto switch (D-F9G/F9H type) are also available. For details, refer to page 1137.

- D-□
- X□

Auto Switch Mounting 2

Caution on Installing in Close Proximity to Each Other

⚠ Caution

1. When cylinders are used in close proximity to one another as in mounting patterns (1) through (4), the magnetic force of the auto switch magnets in cylinder B may have an effect on the operation of the auto switches on cylinder A. The mounting pitch of cylinders should be at least the values given in the table below.

When using cylinders with different orientations or bore sizes in proximity to one another, consult with SMC.

ø8

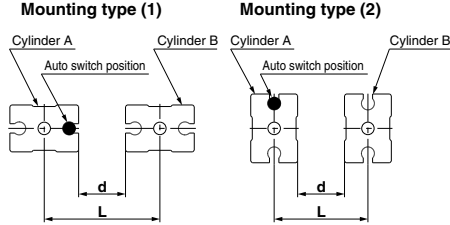

Dimensions by Mounting Type

Bore size (mm)	Auto switch model	(1)		(2)	
		L	d	L	d
8	D-A9□, D-A9□V	27 (37)	5 (15)	15	0
	D-M9□, D-M9□V	27 (39)	5 (17)	15	0
	D-F8□	47	25	15	0
	D-M9□W, D-M9□WV D-M9□A, D-M9□AV	27 (39)	5 (17)	15	0

(): Denotes the values of D-A9□V, D-M9□V, D-M9□WV and D-M9□AV.

ø12 to ø40

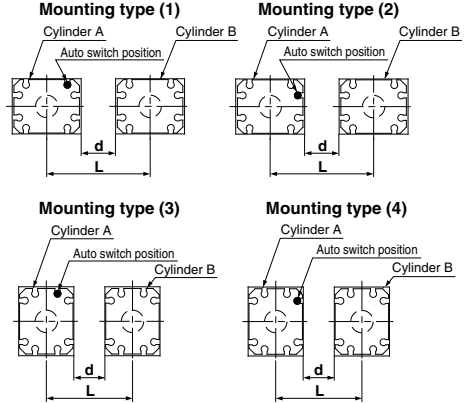

Dimensions by Mounting Type

Bore size (mm)	Auto switch model	(1)		(2)		(3)		(4)	
		L	d	L	d	L	d	L	d
12	D-A9□, D-A9□V	28	0	28 (43)	0 (15)	18	0	18 (33)	0 (15)
	D-M9□, D-M9□V	28	0	33 (45)	5 (17)	18	0	28 (35)	10 (17)
	D-M9□W, D-M9□WV D-M9□A, D-M9□AV	28	0	33 (45)	5 (17)	18	0	28 (35)	10 (17)
16	D-A9□, D-A9□V	32	0	32 (47)	0 (15)	22	0	22 (37)	0 (15)
	D-M9□, D-M9□V	32	0	37 (49)	5 (17)	22	0	32 (39)	10 (17)
	D-M9□W, D-M9□WV D-M9□A, D-M9□AV	32	0	37 (49)	5 (17)	22	0	32 (39)	10 (17)
20	D-A9□, D-A9□V	38	0	38 (53)	0 (15)	26	0	26 (41)	0 (15)
	D-M9□, D-M9□V	38	0	38 (55)	0 (17)	26	0	56 (63)	30 (37)
	D-M9□W, D-M9□WV D-M9□A, D-M9□AV	38	0	38 (55)	0 (17)	26	0	56 (63)	30 (37)
25	D-A9□, D-A9□V	40	0	40 (55)	0 (15)	32	0	32 (47)	0 (15)
	D-M9□, D-M9□V	40	0	50 (57)	10 (17)	47	15	72 (74)	40 (42)
	D-M9□W, D-M9□WV D-M9□A, D-M9□AV	40	0	50 (57)	10 (17)	47	15	72 (74)	40 (42)
32	D-A9□, D-A9□V	50	0	50 (61)	0 (11)	38	0	38 (53)	0 (15)
	D-M9□, D-M9□V	50	0	55 (63)	5 (13)	38	0	48 (55)	10 (17)
	D-M9□W, D-M9□WV D-M9□A, D-M9□AV	50	0	55 (63)	5 (13)	38	0	48 (55)	10 (17)
40	D-A9□, D-A9□V	54	0	54 (64)	0 (10)	48	0	48 (63)	0 (15)
	D-M9□, D-M9□V	54	0	59 (66)	5 (12)	48	0	63 (70)	15 (22)
	D-M9□W, D-M9□WV D-M9□A, D-M9□AV	54	0	59 (66)	5 (12)	48	0	63 (70)	15 (22)

(): Denotes the values of D-A9□V, D-M9□V, D-M9□WV and D-M9□AV.
If cylinders are used with a mounting pitch less than shown above, they must be shielded with iron plates or the separately sold magnetic shielding plate (part no.: MU-S025). Please contact SMC for further information.

2. Avoid wiring patterns in which bending stress and pulling force are repeatedly applied to the lead wires.

When a bending stress is repeatedly applied to the lead wires, be sure to secure the lead wire close to the switch and to maintain a bending radius of R40 to R80 or more as a guideline.

Applying a stress or pulling force to the connection part of a lead wire and an auto switch may cause broken wires, or a sheath to be dropped outs. Be sure that no force of any kind is applied to the connection part.



MTS Series

Specific Product Precautions

Be sure to read this before handling the products.

Refer to back page 50 for Safety Instructions and pages 3 to 12 for Actuator and Auto Switch Precautions.

Caution on Using End Lock Type

Operating Precautions

Caution

1. Do not use 3 position solenoid valves.

Avoid use in combination with 3 position solenoid valves (especially closed center metal seal types). If pressure is trapped in the port on the lock mechanism side, the cylinder cannot be locked.

Furthermore, even after being locked, the lock may be released after some time, due to air leaking from the solenoid valve and entering the cylinder.

2. Back pressure is required when releasing the lock.

Before starting operation, be sure to control the system so that air is supplied to the side without the lock mechanism. There is a possibility that the lock may not be released. (Refer to the section on releasing the lock.)

3. Release the lock when mounting or adjusting the cylinder.

If mounting or other work is performed when the cylinder is locked, the lock unit may be damaged.

4. Operate with a load ratio of 50% or less.

If the load ratio exceeds 50%, this may cause problems such as failure of the lock to release, or damage to the lock unit.

5. Do not operate multiple cylinders in synchronization.

Avoid applications in which two or more end lock cylinders are synchronized to move one workpiece, as one of the cylinder locks may not be able to release when required.

6. Use a speed controller with meter-out control.

It may not be possible to release the lock with meter-in control.

7. Be sure to operate completely to the cylinder stroke end on the side with the lock.

If the cylinder piston does not reach the end of the stroke, locking and unlocking may not be possible.

Operating Pressure

Caution

1. Apply air pressure of at least that shown in the table below to the port on the lock mechanism side. This is necessary to release the lock.

Bore size (mm)	Operating pressure (MPa)
12, 16	0.17
20, 25, 32, 40	0.15

Exhaust Speed

Caution

1. Locking will occur automatically if the pressure applied to the port on the lock mechanism side falls to 0.05 MPa or less. In the cases where the piping on the lock mechanism side is long and thin, or the speed controller is separated at some distance from the cylinder port, the exhaust speed will be reduced. Take note that some time may be required for the lock to engage. In addition, clogging of a silencer mounted on the solenoid valve exhaust port can produce the same effect.

Relation to Cushion

Caution

1. When the cushion valve on the lock mechanism side is closed or nearly closed, the spline rod may not reach the stroke end, and consequently the lock may not engage. Moreover, if the lock does engage when the cushion valve is nearly closed, it may not be possible for the lock to release. Therefore, the cushion valve should be adjusted properly.

Releasing the Lock

Warning

1. Before releasing the lock, be sure to supply air to the side without the lock mechanism, so that there is no load applied to the lock mechanism when it is released. If the lock is released when the port on the other side is in an exhaust state, and with a load applied to the lock unit, the lock unit may be subjected to an excessive force and may be damaged. Furthermore, sudden movement of the spline rod is very dangerous.

Manual Release

Caution

1. Insert the bolt, screw it into the lock piston, and then pull it to release the lock. If you stop pulling the bolt, the lock will return to an operational state. Thread sizes, pulling forces and strokes are as shown below.

Bore size (mm)	Thread size	Pulling force (N)	Stroke (mm)
12, 16	M2 x 0.4 x 15 L or more	2	1.5
20, 25, 32	M3 x 0.5 x 30 L or more	3	2
40	M3 x 0.5 x 30 L or more	4	3

* Remove the bolt for normal operation. It can cause lock malfunction or faulty release.

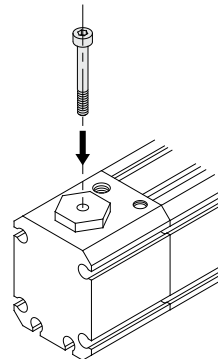

MXH

MXS

MXQ

MXQ

MXF

MXW

MXJ

MXP

MXY

MTS

D-□

-X□