

# Compact Cylinder with Air Cushion

## RQ Series

ø20, ø25, ø32, ø40, ø50, ø63, ø80, ø100

Uses a unique air cushion mechanism with no cushion ring.



The **new standard** for the future  
New Air Cushion Cylinder

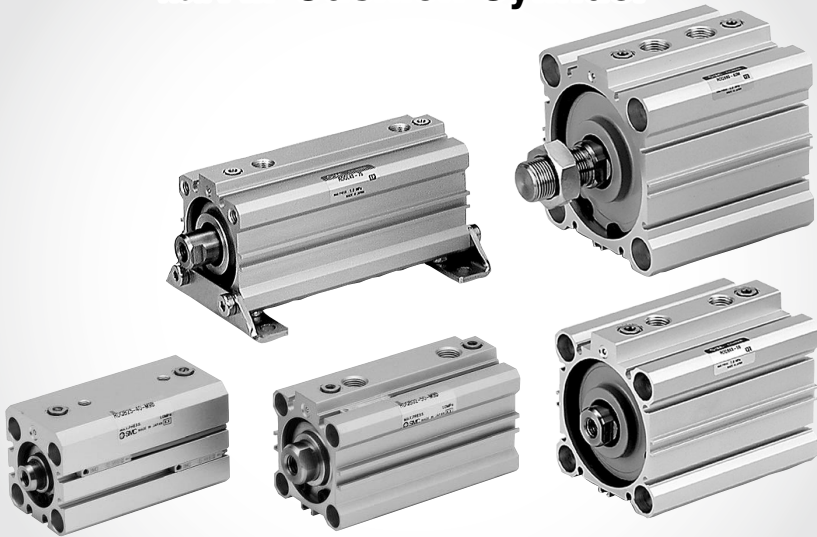

- CUJ
- CU
- CQS
- JCQ
- CQ2
- RQ
- CQM
- CQU
- MU

Model	Mounting	Rod end configuration	Standard stroke								Auto switch
			15	20	25	30	40	50	75	100	
R(D)Q□20	<ul style="list-style-type: none"> <li>•Through-hole</li> <li>•Double end tapped</li> <li>•Foot type (*1)</li> <li>•Rod side flange type</li> <li>•Head side flange type</li> <li>•Double clevis type</li> </ul>	<ul style="list-style-type: none"> <li>•Female thread</li> <li>•Male thread</li> </ul>									<ul style="list-style-type: none"> <li>•Direct mounting auto switch (ø20 to ø100)</li> <li>•Rail mounting auto switch (ø32 to ø100)</li> </ul>
R(D)Q□25											
R(D)Q□32											
R(D)Q□40											
R(D)Q□50											
R(D)Q□63											
R(D)Q□80											
R(D)Q□100											

\* Size ø20 and ø25 have through-holes and double end taps in common.  
\* 1) A compact foot type with the overall width shortened is newly added.

- D-□
- X□
- Technical Data



# Future new standard for shock elimination,



Employs a new construction  
for the air cushion mechanism.



Compact Cylinder with Air Cushion

## RQ Series



## Unique air cushion construction with no cushion ring

Elimination of the cushion ring used in current cushion ring type air cushions has made it possible to reduce the overall length of the cylinder. This produces an air cushion cylinder which retains the merits of a compact design.

### Working principle

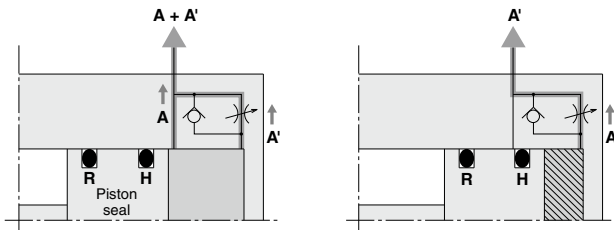

- ① When the piston is retracting, exhaust is discharged from both A and A' until piston seal H passes the air passage A.
- ② After piston seal H has passed the air passage A, exhaust is discharged only from A'. The section marked with diagonal lines becomes a cushion chamber, and a cushioning effect is achieved.
- ③ When air is supplied for piston extension, the check seal opens and the piston starts with no delay.

# noise reduction and improvement in repeatability

## Minimal extended dimensions from +2.5 mm to 13 mm

(Compared with series CDQS/CDQ2 of the same bore size with auto switches)

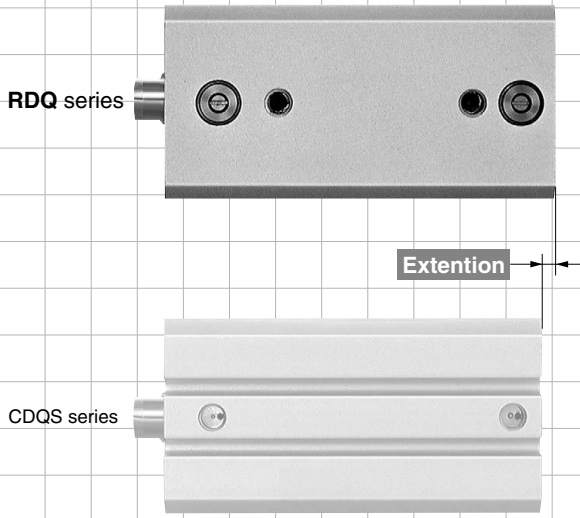

Series	Bore size	Extended dimension	Comparable cylinder
RDQ series	20	+2.5 mm	CDQS series
	25	+4 mm	
	32	+4 mm	
	40	+4.5 mm	CDQ2 series
	50	+9 mm	
	63	+9 mm	
80	+10 mm		
100	+13 mm		

## Nearly three times the allowable kinetic energy

(Compared to the CQS/CQ2 series with rubber bumper)  
Improved energy absorption allows selection of a cylinder that is two sizes smaller for the same kinetic energy.

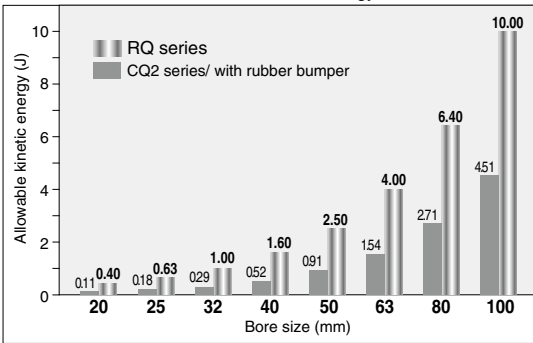

## Interchangeable mounting

The mounting dimension "M" is the same as the compact cylinder CQS/CQ2 series.  
(CQS/CQ2 mounting brackets can be used without any changes.)

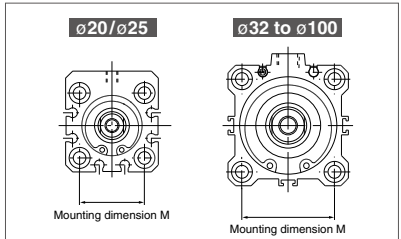

## Improved repeatability

The piston contact surface at the stroke end is metal, providing improved repeatability for the stopping position as compared with a rubber bumper.

## Improved noise reduction (Stroke end impact noise reduced)

- Decrease of 19dB or more (Compared with the CQ2 series without cushion)
- Decrease of 14dB or more (Compared with the CQ2 series with rubber bumper)

- CUJ
- CU
- CQS
- JCQ
- CQ2
- RQ
- CQM
- CQU
- MU

- D-□
- X□
- Technical Data



# Added compact type foot brackets

- Compact foot bracket has the same width as the cylinder. Overall width reduced by up to **42%** (for  $\phi 20$ )

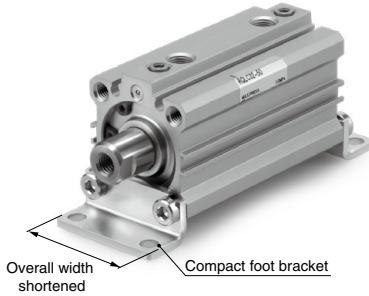

## ■ More compact installation space possible

- Short pitch mounting is possible.
- Allows installation close against a wall.

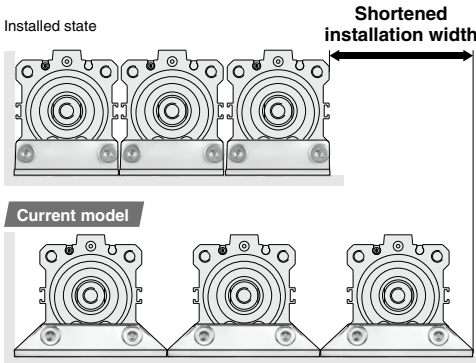

Bore size (mm)	Compact foot type width A (mm)	Current foot type width B (mm)	Reduced width for short pitch mounting (mm)		
			1 unit	2 units	3 units
20	36	62	26	52	78
25	40	66	26	52	78
32	45	71	26	52	78
40	52	78	26	52	78
50	64	95	31	62	93
63	77	113	36	72	108
80	98	140	42	84	126
100	117	162	45	90	135

\* Short pitch mounting is possible only without auto switch. Consult with SMC for mounting with auto switch.

## ■ Height from the bottom of brackets to the center of a cylinder is the same as the current model.

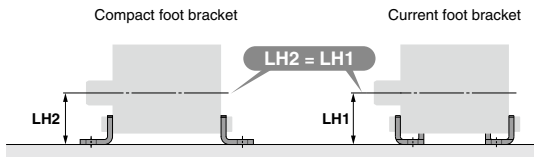

# Compact Cylinder with Air Cushion

# RQ Series

ø20, ø25, ø32, ø40, ø50, ø63, ø80, ø100

## How to Order

**With auto switch**

**With auto switch**  
(Built-in magnet)

**Mounting bracket**

<b>B</b> Through-hole (Standard)	<b>F</b> Rod side flange type
<b>A</b> Both ends tapped type	<b>G</b> Head side flange type
<b>L</b> Foot type	<b>D</b> Double clevis type
<b>LC</b> Compact foot type	

Note 1) Mounting brackets are packed together when shi-pped (unassembled).  
 Note 2) Since sizes ø20 and ø25 have a body with type B (Through-hole) and type A (Both ends tapped type) in common, there is no type A part number. Example) RQA 20-30 does not exist.  
 Note 3) Cylinder mounting bolts are not included. Order them separately referring to Mounting Bolts for RQB on page 987.

**Number of auto switches**

<b>Nil</b>	2 pcs.
<b>S</b>	1 pc
<b>n</b>	"n" pcs.

**Body option**

<b>Nil</b>	Rod end female thread (Standard)
<b>M</b>	Rod end male thread

**Auto switch**

<b>Nil</b>	Without auto switch
------------	---------------------

\* Refer to the table below for the applicable auto switch model.

**Cylinder stroke (mm)**  
Refer to "Standard Stroke" on page 986.

**Thread type**

<b>Nil</b>	M thread	ø20, 25
	Rc	
<b>TN</b>	NPT	ø32 to ø100
<b>TF</b>	G	

**Bore size**

<b>20</b>	20 mm	<b>50</b>	50 mm
<b>25</b>	25 mm	<b>63</b>	63 mm
<b>32</b>	32 mm	<b>80</b>	80 mm
<b>40</b>	40 mm	<b>100</b>	100 mm

**Built-in Magnet Cylinder Model**

If a built-in magnet cylinder without an auto switch is required, there is no need to enter the symbol for the auto switch. (Example) RDQL40-50

## Applicable Auto Switches

Refer to pages 1575 to 1701 for further information on auto switches.

Type	Special function	Electrical entry	Indicator light	Wiring (Output)	Load voltage		Auto switch model				Lead wire length (m)				Pre-wired connector	Applicable load											
					DC	AC	Perpendicular		In-line		0.5 (Nil)	1 (M)	3 (L)	None (Z)													
							ø20, ø25	ø32 to ø100	ø20, ø25	ø32 to ø100																	
Solid state auto switch	Grommet	Connector	No	3-wire (NPN)	24 V	5 V, 12 V	—	M9NV	M9N	●	●	●	○	○	IC circuit	Relay, PLC											
				3-wire (PNP)				M9PV	M9P	●	●	●	○	○													
				2-wire				M9BV	M9B	●	●	●	○	○													
				2-wire				M9V	M9	●	●	●	○	○													
	Grommet	Yes	Grommet	Yes	3-wire (NPN)	24 V	5 V, 12 V	—	M9NW <sup>1</sup>	M9NW	●	●	●	○	○	IC circuit	Relay, PLC										
					3-wire (PNP)				M9PW	M9PW	●	●	●	○	○												
					2-wire				M9BWW	M9BW	●	●	●	○	○												
					3-wire (NPN)				M9NAV <sup>*1</sup>	M9NA <sup>*1</sup>	○	○	●	○	○												
					3-wire (PNP)				M9PAV <sup>*1</sup>	M9PA <sup>*1</sup>	○	○	●	○	○												
					2-wire				M9BAV <sup>*1</sup>	M9BA <sup>*1</sup>	○	○	●	○	○												
Grommet	Yes	Grommet	Yes	2-wire	24 V	5 V, 12 V	—	—	F79F	●	●	○	○	IC circuit	Relay, PLC												
				2-wire (Non-polar)				—	P3DWA <sup>**</sup>	●	●	●	○			○											
				Connector				No	Grommet	Yes	3-wire (NPN equiv.)	24 V	5 V			—	A96V	A96	●	●	●	○	IC circuit	Relay, PLC			
											—						200 V	—	A72	—	A72H	●			●	●	○
											12 V						100 V	—	A93V <sup>*2</sup>	—	A93	●			●	●	○
											5 V, 12 V						100 V or less	—	A90V	—	A90	●			●	●	○
Grommet	Yes	Grommet	Yes	2-wire	24 V	12 V	—	A73C	—	●	●	●	○	IC circuit	Relay, PLC												
				—				5 V, 12 V	24 V or less	A80C	—	●	●			●	○										
Grommet	Yes	Grommet	Yes	2-wire	24 V	12 V	—	A79W	—	●	●	●	○	IC circuit	Relay, PLC												
				—				5 V, 12 V	24 V or less	A80C	—	●	●			●	○										

\*1 Water resistant type auto switches can be mounted on the above models, but in such case SMC cannot guarantee water resistance.

Consult with SMC regarding water resistant types with the above model numbers.

\*2 1 m type lead wire is only applicable to D-A93.

\* Lead wire length symbols: 0.5 m..... Nil (Example) M9NW  
 1 m..... M (Example) M9NWM  
 3 m..... L (Example) M9NWL  
 5 m..... Z (Example) M9NWZ  
 None..... N (Example) J79CN

\* Solid state auto switches marked with a "O" are produced upon receipt of order.

\*\* The D-P3DWA is mountable on bore size ø25 to ø100.

\* Besides the models in the above catalog, there are some other auto switches that are applicable. For more information, refer to page 1002.

\* Refer to pages 1649 and 1649 for the details of auto switches with a pre-wired connector.

\* When mounting D-A93(V)/M93C(V)/M93C(V)/M93C(V) types on a side other than the port side with ø32 to ø50 cylinders, order auto switch mounting brackets separately.

Refer to page 1002 for details.

\* When mounting brackets (foot/flange type) are used, then in some cases auto switches cannot be retrofitted.



CUJ

CU

CQS

JCQ

CQ2

RQ

CQM

CQU

MU

D-□

-X□

Technical Data



**Symbol**  
Air cushion



### Made to Order

(For details, refer to pages 1703 to 1896.)

Symbol	Specifications
-XA <input type="checkbox"/>	Change of Rod End Shape
-XC4	With heavy duty scraper
-XC35	With coil scraper (For ø32 to 100 only)

### Allowable kinetic energy

Refer to "Selection" on page 1003 regarding the allowable kinetic energy.

### Effective Cushion Length

Bore size (mm)	20	25	32	40	50	63	80	100
Effective cushion length (mm)	5.8	6.1	6.6	6.6	7.1	7	7.5	8

### Mounting Bracket Part No.

Bore size (mm)	Foot <sup>Note 1)</sup>	Compact foot	Flange	Double clevis
20	CQS-L020	CQS-LC020	CQS-F020	CQS-D020
25	CQS-L025	CQS-LC025	CQS-F025	CQS-D025
32	CQ-L032	CQ-LC032	CQ-F032	CQ-D032
40	CQ-L040	CQ-LC040	CQ-F040	CQ-D040
50	CQ-L050	CQ-LC050	CQ-F050	CQ-D050
63	CQ-L063	CQ-LC063	CQ-F063	CQ-D063
80	CQ-L080	CQ-LC080	CQ-F080	CQ-D080
100	CQ-L100	CQ-LC100	CQ-F100	CQ-D100

Note 1) When ordering foot/compact foot brackets, order 2 pieces per cylinder.

Note 2) The following parts are included with each bracket.

Foot/Compact foot/Flange : Body mounting bolts.

Double clevis: Clevis pins, type C retaining ring for axis, and Body mounting bolts.

## Specifications

Bore size (mm)	20	25	32	40	50	63	80	100
Lubrication	Not required (non-lube)							
Fluid	Air							
Proof pressure	1.5 MPa							
Maximum operating pressure	1.0 MPa							
Minimum operating pressure	0.05 MPa							
Ambient and fluid temperature	Without auto switch: -10°C to 70°C (No freezing)							
	With auto switch: -10°C to 60°C (No freezing)							
Rod end thread	Female thread							
Stroke length tolerance	+1.0 0							
Mounting	Through-hole							
Piston speed	50 to 500 mm/s							

## Standard Stroke

Bore size (mm)	Standard stroke (mm)
20, 25	15, 20, 25, 30, 40, 50
32, 40	20, 25, 30, 40, 50, 75, 100
50, 63	30, 40, 50, 75, 100
80, 100	40, 50, 75, 100

## Manufacture of Intermediate Stroke

Description	Exclusive body	
Part no.	Refer to "How to Order" for standard model	
Method	Available in stroke increments of 1mm, using an exclusive body for the specified stroke.	
Stroke range	Bore size	Stroke range
	20, 25	16 to 49
	32, 40	21 to 99
	50, 63	31 to 99
Example	80, 100	41 to 99
	Part no.: RQB32-47 A special tube is manufactured for a 47mm stroke.	

## Theoretical Output

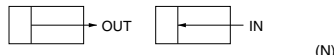

Bore size (mm)	Operating direction	Operating pressure (MPa)		
		0.3	0.5	0.7
20	IN	71	118	165
	OUT	94	157	220
25	IN	113	189	264
	OUT	147	245	344
32	IN	181	302	422
	OUT	241	402	563
40	IN	317	528	739
	OUT	377	628	880
50	IN	495	825	1150
	OUT	589	982	1370
63	IN	841	1400	1960
	OUT	935	1560	2180
80	IN	1360	2270	3170
	OUT	1510	2510	3520
100	IN	2140	3570	5000
	OUT	2360	3930	5500

**Weight**

**Basic Weight**

(g)

Bore size (mm)	Standard stroke (mm)							
	15	20	25	30	40	50	75	100
<b>20</b>	141	156	171	186	216	245	—	—
<b>25</b>	203	221	239	258	294	331	—	—
<b>32</b>	—	271	291	312	353	394	496	598
<b>40</b>	—	390	413	436	482	528	643	758
<b>50</b>	—	—	—	731	803	875	1055	1235
<b>63</b>	—	—	—	940	1019	1099	1297	1495
<b>80</b>	—	—	—	—	1819	1950	2278	2606
<b>100</b>	—	—	—	—	2859	3038	3483	3928

**Additional Weight**

(g)

Bore size (mm)	20	25	32	40	50	63	80	100
Magnet	5	6	11	13	14	22	24	35
Both ends tapped type	—	—	6	6	6	19	45	45
Rod end male thread	Male thread		6	12	26	27	53	53
	Nut		4	8	17	17	32	32
Foot type (including bolt)	159	181	143	155	243	324	696	1062
Compact foot type (including bolt)	97	116	99	114	177	241	501	770
Rod side flange type (including bolt)	143	180	180	214	373	559	1056	1365
Head side flange type (including bolt)	137	171	165	198	348	534	1017	1309
Double clevis type (including pin, retaining ring and bolt)	92	127	151	196	393	554	1109	1887

Calculation example) **RQD32-20M**

- Basic weight : RQB32-20 271 g
- Additional weight : Double end tapped 6 g
- Rod end male thread 43 g
- Double clevis 151 g
- 471 g

**Mounting Bolts for R(D)QB**

Through-hole type mounting bolts for R(D)QB are available. Refer to the following for ordering procedures. Order the actual number of bolts that will be used.

**Example) CQ-M5x50L 4 pcs.**

Material: Chromium molybdenum steel  
Surface treatment: Zinc chromated

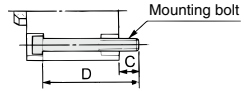

Cylinder model	C	D	Mounting bolt Part no.
<b>R(D)QB20-15</b>	9	50	CQ5 x 50L
<b>-20</b>		55	x 55L
<b>-25</b>		60	x 60L
<b>-30</b>		65	x 65L
<b>-40</b>		75	x 75L
<b>-50</b>		85	x 85L
<b>R(D)QB25-15</b>	9.5	55	CQ-M5 x 55L
<b>-20</b>		60	x 60L
<b>-25</b>		65	x 65L
<b>-30</b>		70	x 70L
<b>-40</b>		80	x 80L
<b>-50</b>		90	x 90L
<b>R(D)QB32-20</b>	10	60	CQ-M5 x 60L
<b>-25</b>		65	x 65L
<b>-30</b>		70	x 70L
<b>-40</b>		80	x 80L
<b>-50</b>		90	x 90L
<b>-75</b>		115	x 115L
<b>-100</b>	140	x 140L	

Cylinder model	C	D	Mounting bolt Part no.	
<b>R(D)QB40-20</b>	8	65	CQ-M5 x 65L	
<b>-25</b>		70	x 70L	
<b>-30</b>		75	x 75L	
<b>-40</b>		85	x 85L	
<b>-50</b>		95	x 95L	
<b>-75</b>		120	x 120L	
<b>-100</b>	145	x 145L		
<b>R(D)QB50-30</b>	13.5	85	CQ-M6 x 85L	
<b>-40</b>		95	x 95L	
<b>-50</b>		105	x 105L	
<b>-75</b>		130	x 130L	
<b>-100</b>		155	x 155L	
<b>R(D)QB63-30</b>		15.5	90	CQ-M8 x 90L
<b>-40</b>	100		x 100L	
<b>-50</b>	110		x 110L	
<b>-75</b>	135		x 135L	
<b>-100</b>	160		x 160L	
<b>R(D)QB80-40</b>	15		105	CQ-M10 x 105L
<b>-50</b>		115	x 115L	
<b>-75</b>		140	x 140L	
<b>-100</b>		165	x 165L	
<b>R(D)QB100-40</b>		17.5	120	CQ-M10 x 120L
<b>-50</b>			130	x 130L
<b>-75</b>	155		x 155L	
<b>-100</b>	180		x 180L	

**CUJ**

**CU**

**CQS**

**JCQ**

**CQ2**

**RQ**

**CQM**

**CQU**

**MU**

**D-□**

**-X□**

Technical Data

# RQ Series

## Construction

ø20 to ø40

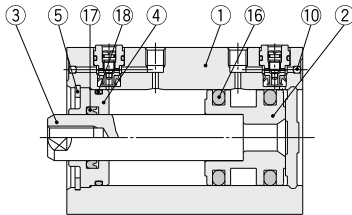

With auto switch (Built-in magnet)

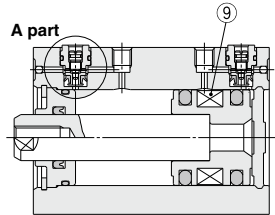

ø50 to ø100

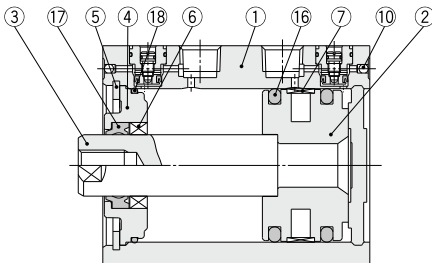

With auto switch (Built-in magnet)

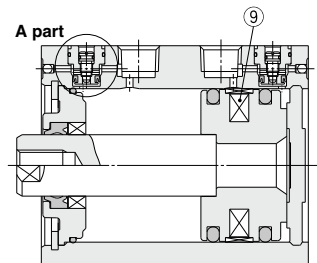

M: Rod end male thread

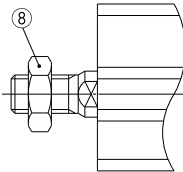

Details of A part

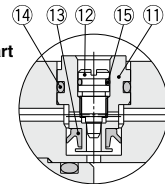

## Component Parts

No.	Description	Material	Note
1	Cylinder tube	Aluminum alloy	Hard anodized
2	Piston	Aluminum alloy	
3	Piston rod	Stainless steel	ø20, ø25
		Carbon steel	ø32 to ø100, Hard chrome plated
4	Collar	Aluminum alloy	ø20 to ø40, Anodized
		Aluminum alloy casted	ø50 to ø100, Chromated, Painted
5	Retaining ring	Carbon tool steel	Phosphate coating
6	Bushing	Bearing alloy	ø50 to ø100
7	Wear ring	Resin	ø63 to ø100
8	Rod end nut	Carbon steel	Nickel plated
9	Magnet	—	
10	Steel ball	High carbon chrome bearing steel	
11	Check seal retainer	Brass	Electroless nickel plated
12	Cushion needle	Stainless steel	
13	Check seal	NBR	
14	Check gasket	NBR	
15	Needle gasket	NBR	
16	Piston seal	NBR	
17	Rod seal	NBR	
18	Tube gasket	NBR	

## Replacement Parts/Seal Kit

Bore size (mm)	Part no.	Contents
20	RQB20-PS	Set of nos. above (16, 17, 18).
25	RQB25-PS	
32	RQB32-PS	
40	RQB40-PS	
50	RQB50-PS	
63	RQB63-PS	
80	RQB80-PS	
100	RQB100-PS	

\* Seal kit includes 16, 17 and 18. Order the seal kit, based on each bore size.

\* Since the seal kit does not include a grease pack, order it separately.

Grease pack part no.: GR-S-010 (10 g)



## Dimensions: $\varnothing 20, \varnothing 25$

\* For the auto switch mounting position and its mounting height, refer to pages 1000 and 1001.

### Basic type (Through-hole/Both ends tapped common): RQB/RDQB

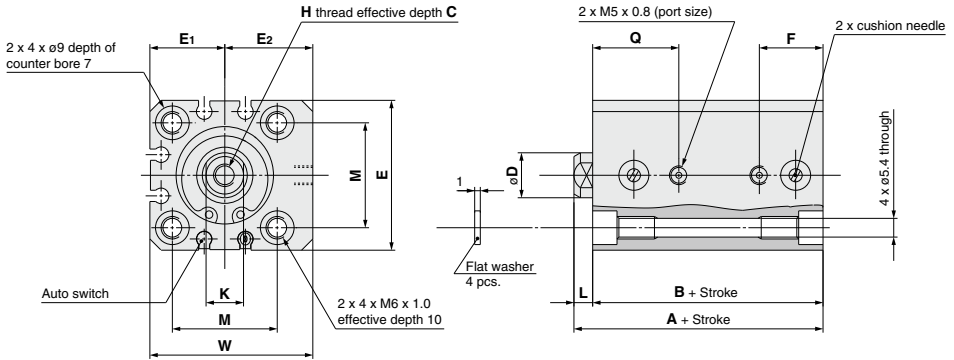

### Rod end male thread

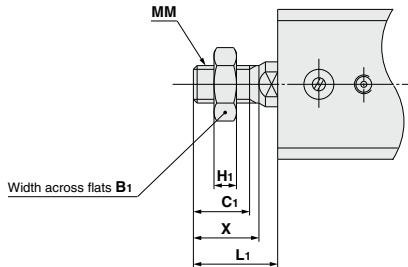

### Rod End Male Thread

Bore size (mm)	B <sub>1</sub>	H <sub>1</sub>	C <sub>1</sub>	X	MM	L <sub>1</sub>
20	13	5	12	14	M8 x 1.25	18.5
25	17	6	15	17.5	M10 x 1.25	22.5

### Basic Type

Bore size (mm)	Stroke range (mm)	A	B	C	D	E	E <sub>1</sub>	E <sub>2</sub>	F	H	K	L	M	Q	W
20	15 to 50	36.5	32	7	10	36	18	21	15.5	M5 x 0.8	8	4.5	25.5	21	39
25	15 to 50	41.5	36.5	12	12	40	20	23.5	17	M6 x 1.0	10	5	28	23	43.5

\* Refer to page 998 for details on rod end nut and accessories.

• Add the stroke to calculate the length of intermediate strokes.

CUJ

CU

CQS

JCQ

CQ2

**RQ**

CQM

CQU

MU

D-□

-X□

Technical Data

# RQ Series

## Mounting Bracket Dimensions

### Foot type: RQL/RDQL

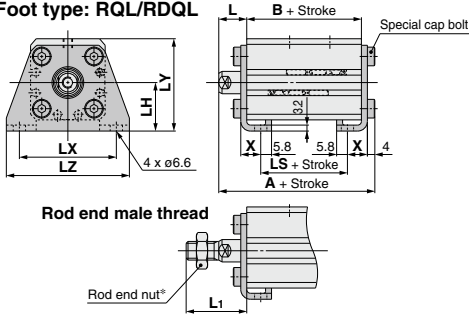

### Foot Type

Bore size (mm)	Stroke range (mm)	A	B	LS	L
20	15 to 50	53.7	32	20	14.5
25	15 to 50	58.7	36.5	21.5	15

Bore size (mm)	L1	LH	LX	LY	LZ	X
20	28.5	24	48	45	62	9.2
25	32.5	26	52	49.5	66	10.7

Foot bracket material: Carbon steel  
Surface treatment: Nickel plated

### Compact foot type: RQLC/RDQLC

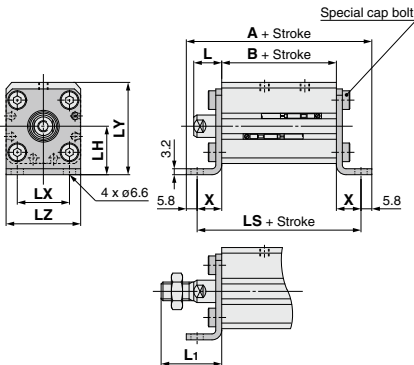

### Compact Foot Type

Bore size (mm)	Stroke range (mm)	A	B	LS	L
20	15 to 50	70	32	58.4	14.5
25	15 to 50	74.5	36.5	62.9	15

Bore size (mm)	L1	LH	LX	LY	LZ	X
20	28.5	24	25.5	45	36	13.2
25	32.5	26	28	49.5	40	13.2

Foot bracket material: Carbon steel  
Surface treatment: Zinc chromated

### Rod side flange type: RQF/RDQF

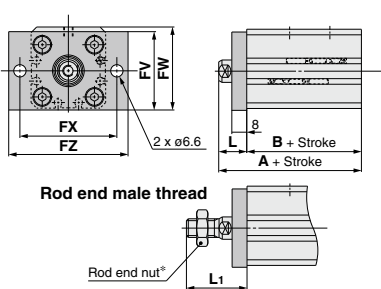

### Rod Side Flange Type

Bore size (mm)	Stroke range (mm)	A	B	L
20	15 to 50	46.5	32	14.5
25	15 to 50	51.5	36.5	15

Bore size (mm)	L1	FV	FW	FX	FZ
20	28.5	39	40.5	48	60
25	32.5	42	44.5	52	64

Flange material: Carbon steel  
Surface treatment: Nickel plated

## Mounting Bracket Dimensions

### Head side flange type: RQG/RDQG

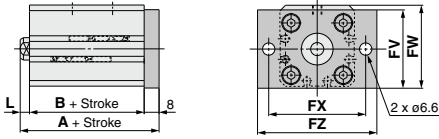

#### Rod end male thread

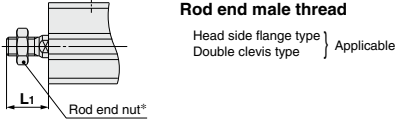

### Head Side Flange Type

Bore size (mm)	Stroke range (mm)	A	L	L <sub>1</sub>
20	15 to 50	44.5	4.5	18.5
25	15 to 50	49.5	5	22.5

\* All dimensions but A, L and L<sub>1</sub> are identical to those of the rod side flange type.

Flange material: Carbon steel  
Surface treatment: Nickel plated

### Double clevis type: RQD/RDQD

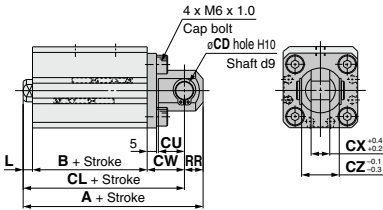

### Double Clevis Type

Bore size (mm)	Stroke range (mm)	A	B	CL	CD	CU
20	15 to 50	63.5	32	54.5	8	12
25	15 to 50	71.5	36.5	61.5	10	14

Bore size (mm)	CW	CX	CZ	L	L <sub>1</sub>	RR
20	18	8	16	4.5	18.5	9
25	20	10	20	5	22.5	10

\* Double clevis pins and retaining rings are included in the package.  
\* Refer to page 998 for details on rod end nut and accessories.

Double clevis bracket material: Carbon steel  
Surface treatment: Nickel plated

CUJ

CU

CQS

JCQ

CQ2

**RQ**

CQM

CQU

MU

D-□

-X□

Technical Data

# RQ Series

## Dimensions: $\varnothing 32$ , $\varnothing 40$ , $\varnothing 50$

\* For the auto switch mounting position and its mounting height, refer to pages 1000 and 1001.

### Basic type (Through-hole): RQB/RDQB

#### Double end tapped

Bore size (mm)	OA	RA
32	M6 x 1.0	10
40	M6 x 1.0	10
50	M8 x 1.25	14

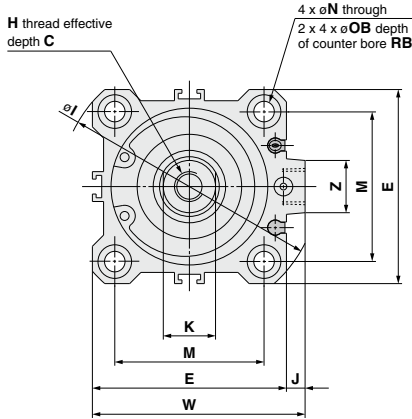

#### Both ends tapped type: RQA/RDQA

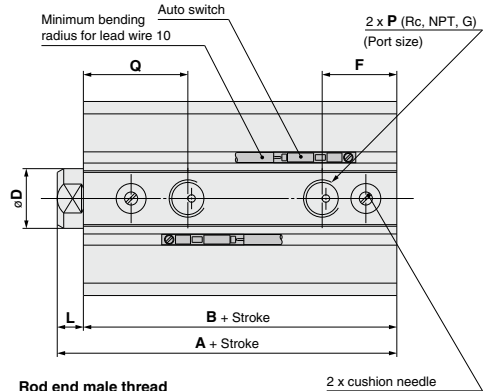
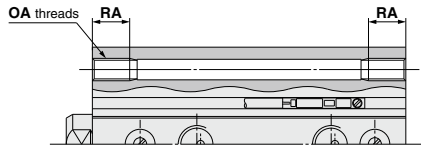

#### Rod end male thread

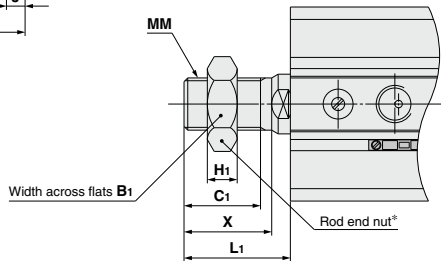

#### Rod End Male Thread

Bore size (mm)	B <sub>1</sub>	H <sub>1</sub>	C <sub>1</sub>	X	MM	L <sub>1</sub>
32	22	8	20.5	23.5	M14 x 1.5	28.5
40	22	8	20.5	23.5	M14 x 1.5	28.5
50	27	11	26	28.5	M18 x 1.5	33.5

### Basic Type

Bore size (mm)	Stroke range (mm)	A	B	C	D	E	F	H	I	J	K	L	M	N
32	20 to 100	44	37	13	16	45	18.5	M8 x 1.25	60	4.5	14	7	34	5.5
40	20 to 100	51	44	13	16	52	20	M8 x 1.25	69	5	14	7	40	5.5
50	30 to 100	57.5	49.5	15	20	64	28.5	M10 x 1.5	86	7	17	8	50	6.6

Bore size (mm)	OB	P	Q	RB	W	Z
32	9	1/8	23	7	49.5	14
40	9	1/8	28	7	57	14
50	11	1/4	31.5	8	71	19

\* Refer to page 998 for details on rod end nut and accessories.

\* Add the stroke to calculate the length of intermediate strokes.

## Mounting Bracket Dimensions

### Foot type: RQL/RDQL

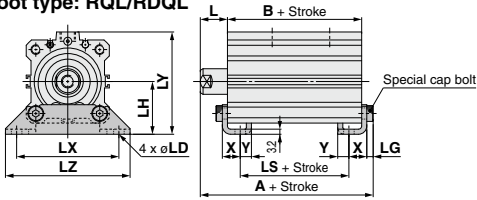

Rod end male thread

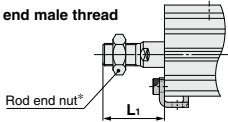

### Foot Type

Bore size (mm)	Stroke range (mm)	A	B	LS	L	L1	LD
32	20 to 100	61.2	37	21	17	38.5	6.6
40	20 to 100	68.2	44	28	17	38.5	6.6
50	30 to 100	75.7	49.5	26.5	18	43.5	9

Bore size (mm)	LG	LH	LX	LY	LZ	X	Y
32	4	30	57	57	71	11.2	5.8
40	4	33	64	64	78	11.2	7
50	5	39	79	78	95	14.7	8

Foot bracket material: Carbon steel  
Surface treatment: Nickel plated

### Compact foot type: RQLC/RDQLC

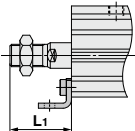
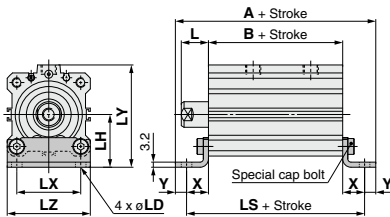

### Compact Foot Type

Bore size (mm)	Stroke range (mm)	A	B	LS	L	L1	LD
32	20 to 100	76	37	64.4	17	38.5	6.6
40	20 to 100	85.4	44	71.4	17	38.5	6.6
50	30 to 100	98.9	49.5	82.9	18	43.5	9

Bore size (mm)	LH	LX	LY	LZ	X	Y
32	30	34	57	45	13.7	5.8
40	33	40	64	52	13.7	7
50	39	50	78	64	16.7	8

Foot bracket material: Carbon steel  
Surface treatment: Zinc chromated

### Rod side flange type: RQF/RDQF

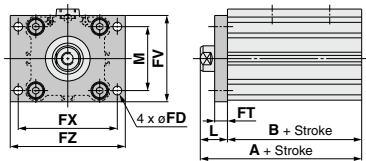

Rod end male thread

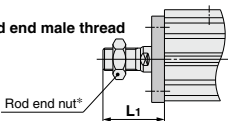

### Rod Side Flange Type

Bore size (mm)	Stroke range (mm)	A	B	FD	FT	FV
32	20 to 100	54	37	5.5	8	48
40	20 to 100	61	44	5.5	8	54
50	30 to 100	67.5	49.5	6.6	9	67

Bore size (mm)	FX	FZ	L	L1	M
32	56	65	17	38.5	34
40	62	72	17	38.5	40
50	76	89	18	43.5	50

Flange bracket material: Carbon steel  
Surface treatment: Nickel plated

CJ

CU

CQS

JCQ

CQ2

RQ

CQM

CQU

MU

D-□

-X□

Technical Data

## Mounting Bracket Dimensions

### Head side flange type: RQG/RDQG

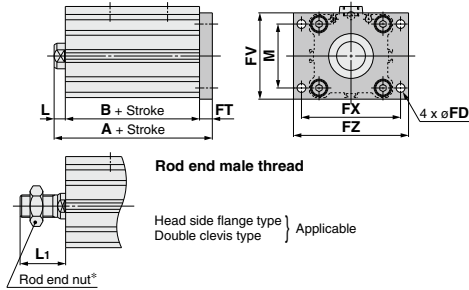

### Head Side Flange Type

Bore size (mm)	Stroke range (mm)	A	L	L1
32	20 to 100	52	7	28.5
40	20 to 100	59	7	28.5
50	30 to 100	66.5	8	33.5

\* All dimensions but A, L and L1 are identical to those of the rod side flange type. Flange bracket material: Carbon steel  
Surface treatment: Nickel plated

### Double clevis type: RQD/RDQD

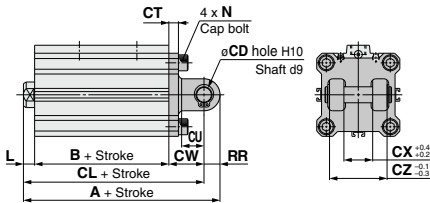

### Double Clevis Type

Bore size (mm)	Stroke range (mm)	A	B	CL	CD	CT	CU
32	20 to 100	74	37	64	10	5	14
40	20 to 100	83	44	73	10	6	14
50	30 to 100	99.5	49.5	85.5	14	7	20

Bore size (mm)	CW	CX	CZ	L	L1	N	RR
32	20	18	36	7	28.5	M6 x 1.0	10
40	22	18	36	7	28.5	M6 x 1.0	10
50	28	22	44	8	33.5	M8 x 1.25	14

\* Double clevis pins and retaining rings are included in the package.

\* Refer to page 998 for details on rod end nut and accessories.

Double clevis bracket material: Cast iron  
Surface treatment: Painted

## Dimensions: $\phi 63$ to $\phi 100$

\* For the auto switch mounting position and its mounting height, refer to pages 1000 and 1001.

### Basic type (Through-hole)

#### Both Ends Tapped Type

Bore size (mm)	OA	RA
63	M10 x 1.5	18
80	M12 x 1.75	22
100	M12 x 1.75	22

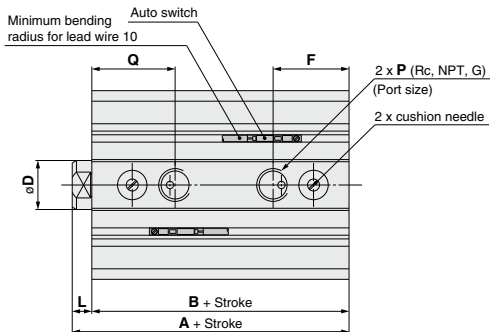
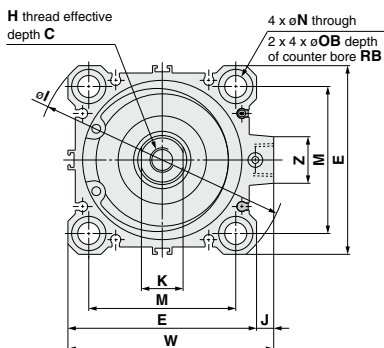
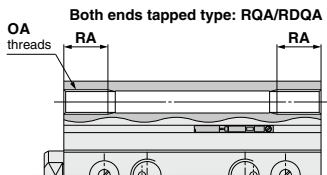

#### Rod end male thread

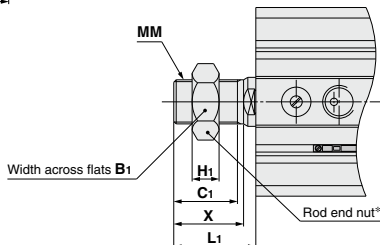

#### Rod End Male Thread

Bore size (mm)	B1	H1	C1	X	MM	L1
63	27	11	26	28.5	M18 x 1.5	33.5
80	32	13	32.5	35.5	M22 x 1.5	43.5
100	41	16	32.5	35.5	M26 x 1.5	43.5

### Basic Type

Bore size (mm)	Stroke range (mm)	A	B	C	D	E	F	H	I	J	K	L	M	N	OB	P
63	30 to 100	63	55	15	20	77	31	M10 x 1.5	103	7	17	8	60	9	14	1/4
80	40 to 100	73.5	63.5	21	25	98	35.5	M16 x 2.0	132	6	22	10	77	11	17.5	3/8
100	40 to 100	88	76	27	30	117	40	M20 x 2.5	156	6.5	27	12	94	11	17.5	3/8

Bore size (mm)	Q	RB	W	Z
63	34	10.5	84	19
80	39	13.5	104	26
100	43	13.5	123.5	26

\* Refer to page 998 for details on rod end nut and accessories.

• Add the stroke to calculate the length of intermediate strokes.

CUJ

CU

CQS

JCQ

CQ2

**RQ**

CQM

CQU

MU

D-□

-X□

Technical Data

# RQ Series

## Mounting Bracket Dimensions

### Foot type: RQL/RDQL

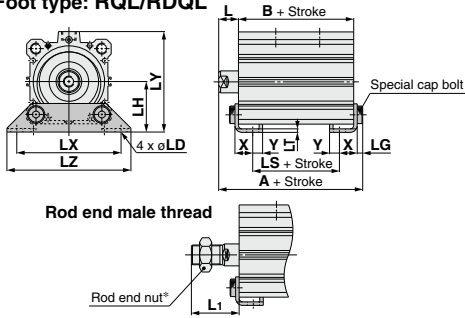

### Foot Type

Bore size (mm)	Stroke range (mm)	A	B	LS	L	L1	LD	LG	LH	LT
63	30 to 100	81.2	55	29	18	43.5	11	5	46	3.2
80	40 to 100	95	63.5	33.5	20	53.5	13	7	59	4.5
100	40 to 100	111	76	42	22	53.5	13	7	71	6

Bore size (mm)	LX	LY	LZ	X	Y
63	95	91.5	113	16.2	9
80	118	114	140	19.5	11
100	137	136	162	23	12.5

Foot bracket material: Carbon steel  
Surface treatment: Nickel plated

### Compact foot type: RQLC/RDQLC

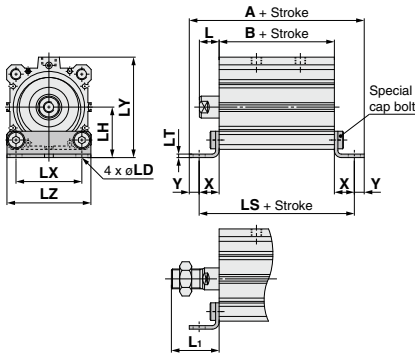

### Compact Foot Type

Bore size (mm)	Stroke range (mm)	A	B	LS	L	L1	LD	LH	LT
63	30 to 100	109.4	55	91.4	18	43.5	11	46	3.2
80	40 to 100	130.5	63.5	108.5	20	53.5	13	59	4.5
100	40 to 100	149	76	124	22	53.5	13	71	6

Bore size (mm)	LX	LY	LZ	X	Y
63	60	91.5	77	18.2	9
80	77	114	98	22.5	11
100	94	136	117	24	12.5

Foot bracket material: Carbon steel  
Surface treatment: Zinc chromated

### Rod side flange type: RQF/RDQF

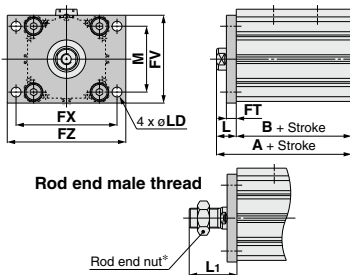

### Rod Side Flange Type

Bore size (mm)	Stroke range (mm)	A	B	FD	FT	FV	FX	FZ	L	L1	M
63	30 to 100	73	55	9	9	80	92	108	18	43.5	60
80	40 to 100	83.5	63.5	11	11	99	116	134	20	53.5	77
100	40 to 100	98	76	11	11	117	136	154	22	53.5	94

Flange bracket material: Carbon steel  
Surface treatment: Nickel plated



## Mounting Bracket Dimensions

### Head side flange type: RQG/RDQG

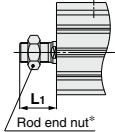
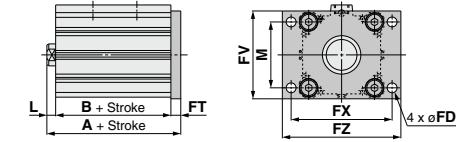

Rod end male thread

Head side flange type } Applicable  
Double clevis type }

### Head Side Flange Type

Bore size (mm)	Stroke range (mm)	A	L	L <sub>1</sub>
63	30 to 100	72	8	33.5
80	40 to 100	84.5	10	43.5
100	40 to 100	99	12	43.5

\* All dimensions but A, L and L<sub>1</sub> are identical to those of the rod side flange type. Flange bracket material: Carbon steel  
Surface treatment: Nickel plated

### Double clevis type: RQD/RDQD

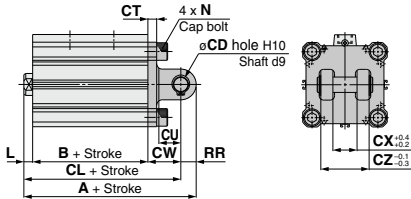

### Double Clevis Type

Bore size (mm)	Stroke range (mm)	A	B	CL	CD	CT	CU	CW	CX	CZ	L
63	30 to 100	107	55	93	14	8	20	30	22	44	8
80	40 to 100	129.5	63.5	111.5	18	10	27	38	28	56	10
100	40 to 100	155	76	133	22	13	31	45	32	64	12

Bore size (mm)	L <sub>1</sub>	N	RR
63	33.5	M10 x 1.5	14
80	43.5	M12 x 1.75	18
100	43.5	M12 x 1.75	22

\* Double clevis pins and retaining rings are included in the package.  
\* Refer to page 998 for details on rod end nut and accessories.

Double clevis bracket material: Cast iron  
Surface treatment: Painted

CUJ

CU

CQS

JCQ

CQ2

RQ

CQM

CQU

MU

D-□

-X□

Technical Data

# Accessory Bracket Dimensions

## Single Knuckle Joint

For I-G02, I-G03

For I-G04, I-G05  
I-G08, I-G10

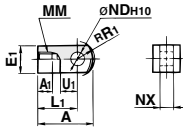

Material: Carbon steel  
Surface treatment: Nickel plated

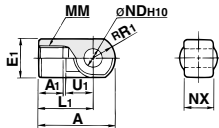

Material: Cast iron  
Surface treatment: Nickel plated

## Double Knuckle Joint

For Y-G02, Y-G03

For Y-G04, Y-G05  
Y-G08, Y-G10

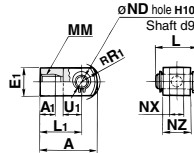

Material: Carbon steel  
Surface treatment: Nickel plated

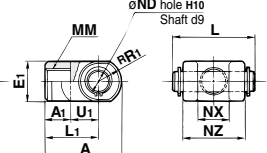

Material: Cast iron  
Surface treatment: Nickel plated

Part no.	Applicable bore size (mm)	A	A1	E1	L1	MM	R <sub>R1</sub>	U1	ND	NX
I-G02	20	34	8.5	□16	25	M8 x 1.25	10.3	11.5	8 <sup>+0.058</sup> <sub>0</sub>	8 <sup>-0.2</sup> <sub>-0.4</sub>
I-G03	25	41	10.5	□20	30	M10 x 1.25	12.8	14	10 <sup>+0.058</sup> <sub>0</sub>	10 <sup>-0.2</sup> <sub>-0.4</sub>
I-G04	32, 40	42	14	ø22	30	M14 x 1.5	12	14	10 <sup>+0.058</sup> <sub>0</sub>	18 <sup>-0.3</sup> <sub>-0.5</sub>
I-G05	50, 63	56	18	ø28	40	M18 x 1.5	16	20	14 <sup>+0.070</sup> <sub>0</sub>	22 <sup>-0.3</sup> <sub>-0.5</sub>
I-G08	80	71	21	ø38	50	M22 x 1.5	21	27	18 <sup>+0.070</sup> <sub>0</sub>	28 <sup>-0.3</sup> <sub>-0.5</sub>
I-G10	100	79	21	ø44	55	M26 x 1.5	24	31	22 <sup>+0.084</sup> <sub>0</sub>	32 <sup>-0.3</sup> <sub>-0.5</sub>

Part no.	Applicable bore size (mm)	A	A1	E1	L1	MM	R <sub>R1</sub>	U1	ND	NX	NZ	L	Applicable pin no.
Y-G02	20	34	8.5	□16	25	M8 x 1.25	10.3	11.5	8 <sup>+0.058</sup> <sub>0</sub>	8 <sup>+0.4</sup> <sub>-0.2</sub>	16	21	IY-G02
Y-G03	25	41	10.5	□20	30	M10 x 1.25	12.8	14	10 <sup>+0.058</sup> <sub>0</sub>	10 <sup>+0.2</sup> <sub>-0.2</sub>	20	25	IY-G03
Y-G04	32, 40	42	16	ø22	30	M14 x 1.5	12	14	10 <sup>+0.058</sup> <sub>0</sub>	18 <sup>+0.3</sup> <sub>-0.3</sub>	36	41	IY-G04
Y-G05	50, 63	56	20	ø28	40	M18 x 1.5	16	20	14 <sup>+0.070</sup> <sub>0</sub>	22 <sup>+0.3</sup> <sub>-0.3</sub>	44	50	IY-G05
Y-G08	80	71	23	ø38	50	M22 x 1.5	21	27	18 <sup>+0.070</sup> <sub>0</sub>	28 <sup>+0.3</sup> <sub>-0.3</sub>	56	64	IY-G08
Y-G10	100	79	24	ø44	55	M26 x 1.5	24	31	22 <sup>+0.084</sup> <sub>0</sub>	32 <sup>+0.3</sup> <sub>-0.3</sub>	64	72	IY-G10

\* Knuckle pin and retaining ring are included.

## Knuckle Pin (Common with double clevis pin)

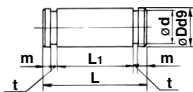

Material: Carbon steel  
mm

Part no.	Applicable bore size (mm)	D	L	d	L1	m	t	Retaining ring
IY-G02	20	8 <sup>-0.040</sup> <sub>-0.076</sub>	21	7.6	16.2	1.5	0.9	C8 type for pivot
IY-G03	25	10 <sup>-0.040</sup> <sub>-0.076</sub>	25.6	9.6	20.2	1.55	1.15	C10 type for pivot
IY-G04	32, 40	10 <sup>-0.040</sup> <sub>-0.076</sub>	41.6	9.6	36.2	1.55	1.15	C10 type for pivot
IY-G05	50, 63	14 <sup>-0.050</sup> <sub>-0.093</sub>	50.6	13.4	44.2	2.05	1.15	C14 type for pivot
IY-G08	80	18 <sup>-0.050</sup> <sub>-0.093</sub>	64	17	56.2	2.55	1.35	C18 type for pivot
IY-G10	100	22 <sup>-0.085</sup> <sub>-0.117</sub>	72	21	64.2	2.55	1.35	C22 type for pivot

\* Type C retaining rings for axis are included.

## Rod End Nut

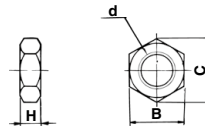

Material: Carbon steel  
Surface treatment: Zinc chromated  
mm

Part no.	Applicable bore size (mm)	d	H	B	C
NT-02	20	M8 x 1.25	5	13	15.0
NT-03	25	M10 x 1.25	6	17	19.6
NT-04	32, 40	M14 x 1.5	8	22	25.4
NT-05	50, 63	M18 x 1.5	11	27	31.2
NT-08	80	M22 x 1.5	13	32	37.0
NT-10	100	M26 x 1.5	16	41	47.3

## Simple Joint: $\phi 32$ to $\phi 100$



### Joint and Mounting Bracket (Type A, Type B) Part No.

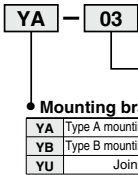

### Allowable Eccentricity

Bore size (mm)	32	40	50	63	80	100
Eccentricity tolerance	$\pm 1$			$\pm 1.5$ $\pm 2$		
Backlash	0.5					

<Ordering>

- Joints are not included with the A or B type mounting brackets. Order them separately.

(Example)

- Bore size  $\phi 40$  Part no. ....
- Type A mounting bracket ..... YA-03
- Joint ..... YU-03

### Joint and Mounting Bracket (A and B Types) Part No.

Bore size (mm)	Joint	Applicable mounting bracket	
		Type A mounting bracket	Type B mounting bracket
32, 40	YU-03	YA-03	YB-03
50, 63	YU-05	YA-05	YB-05
80	YU-08	YA-08	YB-08
100	YU-10	YA-10	YB-10

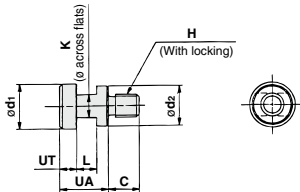

Material: Chrome molybdenum steel (Nickel plated)

Part no.	Applicable bore size (mm)	UA		C	d <sub>1</sub>	d <sub>2</sub>	H	K	L	UT	Weight (g)
		UT	UA								
YU-03	32, 40	17	11	15.8	14	M8 x 1.25	8	7	6	25	
YU-05	50, 63	17	13	19.8	18	M10 x 1.5	10	7	6	40	
YU-08	80	22	20	24.8	23	M16 x 2	13	9	8	90	
YU-10	100	26	26	29.8	28	M20 x 2.5	14	11	10	160	

### Type A Mounting Bracket

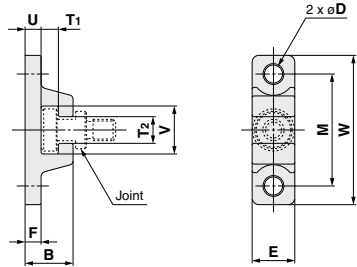

Material: Chrome molybdenum steel (Nickel plated) mm

Part no.	Bore size (mm)	B	D	E	F	M	T <sub>1</sub>	T <sub>2</sub>
YA-03	32, 40	18	6.8	16	6	42	6.5	10
YA-05	50, 63	20	9	20	8	50	6.5	12
YA-08	80	26	11	25	10	62	8.5	16
YA-10	100	31	14	30	12	76	10.5	18

Part no.	Bore size (mm)	U	V	W	Weight (g)
YA-03	32, 40	6	18	56	55
YA-05	50, 63	8	22	67	100
YA-08	80	10	28	83	195
YA-10	100	12	36	100	340

### Type B Mounting Bracket

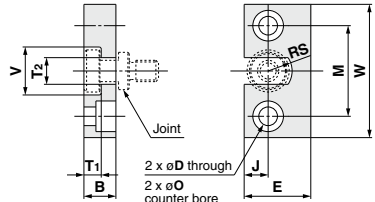

Material: Stainless steel mm

Part no.	Bore size (mm)	B	D	E	J	M	O
YB-03	32, 40	12	7	25	9	34	11.5 depth 7.5
YB-05	50, 63	12	9	32	11	42	14.5 depth 8.5
YB-08	80	16	11	38	13	52	18 depth 12
YB-10	100	19	14	50	17	62	21 depth 14

Part no.	Bore size (mm)	T <sub>1</sub>	T <sub>2</sub>	V	W	RS	Weight (g)
YB-03	32, 40	6.5	10	18	50	9	80
YB-05	50, 63	6.5	12	22	60	11	120
YB-08	80	8.5	16	28	75	14	230
YB-10	100	10.5	18	36	90	18	455

CUJ

CU

CQS

JCQ

CQ2

RQ

CQM

CQU

MU

D-□

-X□

Technical Data

# RQ Series

# Auto Switch Mounting 1

## Minimum Auto Switch Mounting Stroke

No. of auto switch mounted	D-M9□		D-M9□A		D-A7□/A80		D-F7□V		D-A79W	D-F7□W		D-F7NT		D-P3DWA
	D-M9□V	D-M9□AV	D-M9□W	D-A9□	D-A73C/A80C	D-J79C	D-A7□H/A80H	D-F7□WV		D-F7□W	D-J79W	D-F7BA	D-F79F	
1 pc.	15		15		15		15		15	20 (15)		15		
2 pcs.	15		15		15		15		20	20		15		

Note) The dimension stated in ( ) shows the minimum mountable stroke when the auto switch does not project from the end face of the cylinder body and the lead wire bending space is not hindered. (Refer to the figure on the right.) Order auto switches and auto switch mounting brackets separately.

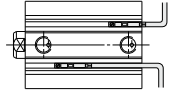

## Proper Auto Switch Mounting Position (Detection at stroke end) and Its Mounting Height

ø20/ø25

D-M9□  
D-M9□W  
D-M9□A  
D-A9□

D-M9□V  
D-M9□WV  
D-M9□AV  
D-A9□V

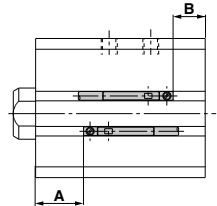
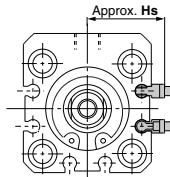
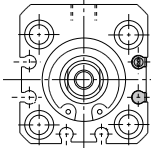

ø32 to ø100

D-M9□  
D-M9□W  
D-M9□A  
D-A9□

D-M9□V  
D-M9□WV  
D-M9□AV  
D-A9□V

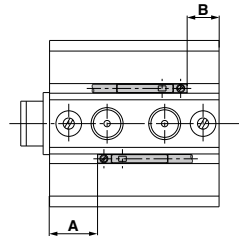
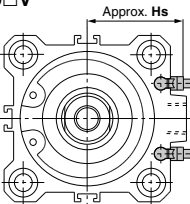
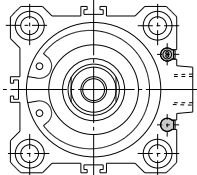

### Proper Auto Switch Mounting Positions (mm)

Auto switch model	D-M9□		D-M9□WV		D-A9□	
	D-M9□V	D-M9□AV	D-M9□W	D-M9□AV	A	B
Bore size	A	B	A	B	A	B
20	13.5	7	9.5	3	9.5	3
25	15	9.5	11	5.5	11	5.5
32	16.5	8.5	12.5	4.5	12.5	4.5
40	21	11	17	7	17	7
50	21	16.5	17	12.5	17	12.5
63	23.5	19.5	19.5	15.5	19.5	15.5
80	28.5	23	24.5	19	24.5	19
100	35	29	31	25	31	25

### Auto Switch Mounting Height (mm)

Auto switch model	D-M9□		D-M9□WV		D-A9□	
	D-M9□V	D-M9□AV	D-M9□W	D-M9□AV	Hs	Hs
Bore size	Hs		Hs		Hs	
20	24.5		22.5		22.5	
25	26.5		24.5		24.5	
32	29		27		27	
40	32.5		30.5		30.5	
50	38.5		36.5		36.5	
63	42		40		40	
80	52		50		50	
100	62		60		60	

Note) Adjust the auto switch after confirming the operating condition in the actual setting.

1000



**Proper Auto Switch Mounting Position (Detection at stroke end) and Its Mounting Height**

ø32 to ø100

- D-A7□
- D-A80
- D-A7□H
- D-A80H
- D-F7□
- D-J79
- D-F7□W
- D-J79W
- D-F79F
- D-F7NT
- D-F7BA
- D-A73C
- D-A80C
- D-J79C
- D-A79W
- D-F7□V
- D-F7□WV
- D-F7BAV

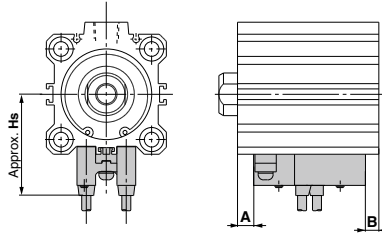

ø25

D-P3DWA

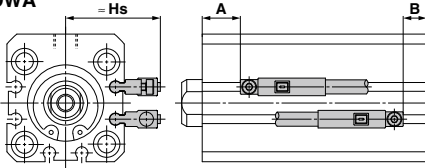

ø32 to ø100

D-P3DWA

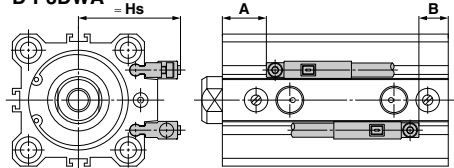

**Proper Auto Switch Mounting Position**

(mm)

Auto switch model	D-A73 D-A80		D-A72/A7□H D-A80H/A73C D-A80C/F7□ D-F7□V/F79F D-J79/J79C D-J79W D-F7□WV D-J79W D-F7BA D-F7BAV		D-A79W		D-F7NT		D-P3DWA	
	A	B	A	B	A	B	A	B	A	B
20	—	—	—	—	—	—	—	—	—	—
25	—	—	—	—	—	—	—	—	10.5	5
32	13.5	5.5	14	6	11	3	19	11	12	4
40	18	8	18.5	8.5	15.5	5.5	23.5	13.5	16.5	6.5
50	18	13.5	18.5	14	15.5	11	23.5	19	16.5	12
63	20.5	16.5	21	17	18	14	26	22	19	15
80	25.5	20	26	20.5	23	17.5	31	25.5	24	18.5
100	32	26	32.5	26.5	29.5	23.5	37.5	31.5	30.5	24.5

Note 1) Adjust the auto switch after confirming the operating condition in the actual setting.  
 Note 2) For bore sizes ø32 to ø50, the D-P3DWA is mountable only on the port side.

**Auto Switch Mounting Height**

(mm)

Auto switch model	D-A7□ D-A80		D-A73C D-A80C		D-F7□V D-F7□W D-F7BA D-F79F D-F7NT		D-J79C		D-A79W		D-P3DWA	
	Hs	Hs	Hs	Hs	Hs	Hs	Hs	Hs	Hs	Hs	Hs	
20	—	—	—	—	—	—	—	—	—	—	—	—
25	—	—	—	—	—	—	—	—	—	—	—	33
32	31.5	32.5	38.5	35	38	34	35.5	37.5	39	—	—	—
40	35	36	42	38.5	41.5	37.5	39	—	—	—	—	—
50	41	42	48	44.5	47.5	43.5	45	—	—	—	—	—
63	47.5	48.5	54.5	51	54	50	48.5	—	—	—	—	—
80	57.5	58.5	64.5	61	64	60	58.5	—	—	—	—	—
100	67.5	68.5	74.5	71	74	70	68.5	—	—	—	—	—

**Operating Range**

(mm)

Auto switch model	Bore size							
	20	25	32	40	50	63	80	100
D-M9□/M9□V D-M9□W/M9□WV D-M9□A/M9□AV	5.5	6	6	6	7	9.5	10	11
D-A9□/A9□V	10	10	9.5	9.5	9.5	11.5	9	11.5
D-A7□/A80 D-A7□H/A80H D-A73C/A80C	—	—	12	11	10	12	12	13
D-A79W	—	—	6	14	14	16	15	17
D-F7□/F7□V D-J79/J79C/J79W D-F7□W/F7□WV D-F79F/F7BA D-F7BAV/F7NT	—	—	13	6	6	6.5	6.5	7
D-P3DWA	—	6	6	6	6	8.5	9	9

\* Since the operating range is provided as a guideline including hysteresis, it cannot be guaranteed (assuming approximately ±30% dispersion). It may vary substantially depending on an ambient environment.

\* Auto switch mounting brackets BQ2-012 are not used for sizes over ø32 of D-A9□(V)/M9□(V)/M9□W(V)/M9□A(V) types. The above values indicate the operating range when mounted with the current auto switch installation groove.

CUJ

CU

CQS

JCQ

CQ2

RQ

CQM

CQU

MU

D-□

-X□

Technical Data

# Auto Switch Mounting 2

## Auto Switch Mounting Bracket: Part No.

Auto switch mounting surface	Bore size (mm)		
	ø20, ø25	ø32, ø40, ø50	ø63, ø80, ø100
Auto switch model	Auto switch mounting surface A, B, C sides	Port side	Auto switch mounting surface A, B, C sides
<b>D-M9□</b> <b>D-M9□V</b> <b>D-M9□W</b> <b>D-M9□WV</b> <b>D-M9□A</b> <b>D-M9□AV</b> <b>D-A9□</b> <b>D-A9□V</b>	Auto switch mounting bracket not required.	Auto switch mounting bracket not required.	① BQ-2 ② BQ2-012 Two kinds of auto switch mounting brackets are used as a set. 
<b>D-P3DWA</b>	—	—	—

Note 1) For each cylinder series, when a compact auto switch is mounted on the three sides (A, B and C above) other than the port side of bore sizes ø32 to ø50, the auto switch mounting brackets above are required. Order them separately from cylinders.  
 (The above is also applicable when a compact auto switch is mounted using an auto switch mounting rail, but not using a compact auto switch installation groove for ø63 to ø100 cylinders.)

Order example  
 RDQB32-50-M9BW.....1  
 BQ-2.....2 pcs.  
 BQ2-012.....2 pcs.

Note 2) When shipping cylinders, auto switch mounting brackets and auto switches are shipped together.

Auto switch model	Bore size (mm)					
	32	40	50	63	80	100
<b>D-A7□/A80</b> <b>D-A73C/A80C</b> <b>D-A7□H/A80H</b> <b>D-A79W</b> <b>D-F7□/J79</b> <b>D-F7□V</b> <b>D-J79C</b> <b>D-F7□W/J79W</b> <b>D-F7□WV</b> <b>D-F7BA/F7BAV</b> <b>D-F79F/F7NT</b>	BQ-2					

Note 3) When shipping auto cylinders, auto switch mounting brackets and auto switches are shipped together.

### [Mounting screw set made of stainless steel]

The following set of mounting screws made of stainless steel (including nuts) is available. Use it in accordance with the operating environment. (Please order BQ-2 separately, since auto switch spacers (for BQ-2) are not included.)

BBA2: For D-A7/A8/F7/J7 types

Water resistant auto switches D-F7BA/F7BAV are mounted on the cylinder with the stainless steel screws above when shipped. When an auto switch is shipped independently, BBA2 is attached.

Note 4) Refer to page 1685 for the details of BBA2 screws.

Note 5) When D-M9□A(V) type is mounted on a side other than ø32, ø40 and ø50 port sides, order auto switch mounting brackets BQ2-012S and BQ-2, and a stainless steel screw set BBA2.

### Auto Switch Mounting Bracket Weight

Mounting bracket part no.	Weight (g)
BQ-2	1.5
BQ2-012	5

Other than the applicable auto switches listed in "How to Order", the following auto switches can be mounted.

### Other Applicable Auto Switches

Type	Model	Electrical entry (Fetching direction)	Features
Reed auto switch	D-A73	Grommet (perpendicular)	—
	D-A80		Without indicator light
	D-A73H, A76H	Grommet (in-line)	—
	D-A80H		Without indicator light
	D-F7NV, F7PV, F7BV		—
Solid state auto switch	D-F7NWV, F7BWW	Grommet (perpendicular)	Diagnostic indication (2-color indicator)
	D-F7BAV		Water resistance (2-color indicator)
	D-F79, F7P, J79		—
	D-F79W, F7PW, J79W	Grommet (in-line)	Diagnostic indication (2-color indicator)
	D-F7BA		Water resistance (2-color indicator)
	D-F7NT		With timer

- For solid state auto switches, auto switches with a pre-wired connector are also available. Refer to pages 1648 and 1649 for details.
- Normally closed (NC = b contact) solid state auto switches (D-F9G/F9H types) are also available. Refer to page 1593 for details.
- D-A7/A8/F7/J7 types cannot be mounted on ø20 and ø25.



# RQ Series

## Specific Product Precautions

Be sure to read this before handling the products.

Refer to back page 50 for Safety Instructions and pages 3 to 12 for Actuator and Auto Switch Precautions.

### Installation and Removal of Retaining Ring

#### ⚠ Caution

1. Use appropriate pliers (Type C retaining ring installing tool) for installation and removal.
2. Even when using appropriate pliers (Type C retaining ring installing tool), proceed with caution as there is a danger of the retaining ring flying off the end of the pliers (Type C retaining ring installing tool) and causing human injury or damage to nearby equipment. After installation, confirm that the retaining ring is securely seated into the retaining ring groove before supplying air.

### Selection

#### ⚠ Caution

1. Operate the cylinder to the stroke end.  
When the stroke is restricted by an external stopper or a clamped work piece, satisfactory cushioning and noise reduction may not be achieved.
2. Strictly observe the limiting ranges for load mass and maximum speed (Graph (1)). Also, the limiting ranges are based on operation of the cylinder to the stroke end and proper adjustment of the cushion needle.

If operated beyond the limiting ranges, excessive impact will occur and this may cause damage to equipment.

Graph (1)

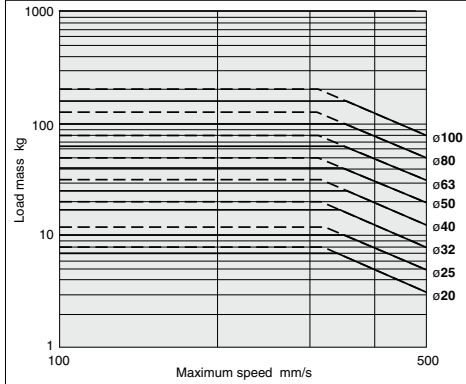

3. Adjust the cushion needle to reduce excessive kinetic energy from the piston impact at the stroke end by absorbing enough kinetic energy during the cushion stroke.

If the piston impacts the stroke end with excessive kinetic energy (values in Table 1 or more), an excessive impact will occur and this may cause damage to equipment.

Table (1) Allowable Kinetic Energy At Piston Impact Unit: [J]

Piston speed	20	25	32	40	50	63	80	100
Allowable kinetic energy	0.055	0.09	0.15	0.26	0.46	0.77	1.30	2.27

### Selection

#### ⚠ Caution

4. Strictly observe the limiting ranges for the piston rod lateral load (Graph (2)).

If operated beyond the limiting ranges, this may cause the equipment life to be reduced or damage to equipment may occur.

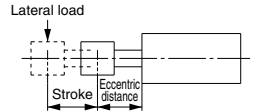

Graph (2)

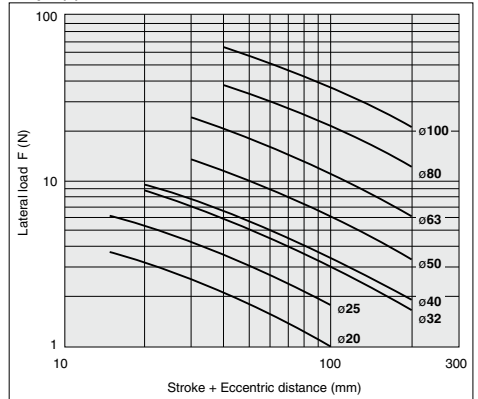

### Cushion Needle Adjustment

#### ⚠ Caution

1. Readjust with a Cushion Needle

When the product is shipped, the cushion needle is open 1/4 to 1/2 turn from the fully closed position. Readjust the position depending on the load or operating speed before using. Note that the needle must be fully closed first, and then gradually reopened when adjusting.

2. Keep the adjustment range for the cushion needle between the closed position and the rotations shown below.

	Rotations
ø20 to ø100	2.5 rotations or less

Use a 3 mm flat head watchmakers screw driver to adjust the cushion needle. The adjustment range for the cushion needle must be between the closed position and the open position ranges above. A retaining mechanism prevents the cushion needle from coming out, however, it may spring out during operation if it is rotated beyond the ranges shown above.

CUJ

CU

CQS

JCQ

CQ2

RQ

CQM

CQU

MU

D-□

-X□

Technical Data

