

MAIN CATALOG 2019

# Motor protection and control

Manual motor starters,  
contactors and overload relays







# Motor protection and control

Manual motor starters,  
contactors and overload relays

**OVERVIEW**

**MANUAL MOTOR STARTERS  
AND TRANSFORMER  
PROTECTION**

**AF, EK CONTACTORS AND  
NF CONTACTOR RELAYS**

**B MINI CONTACTORS,  
K MINI CONTACTOR RELAYS**

**AS CONTACTORS AND  
NS CONTACTOR RELAYS**

**OVERLOAD RELAYS**

**THERMISTOR PROTECTION  
RELAYS**

**SELF RESETTING CURRENT  
LIMITING MODULE**

**DRAS AND DRAF  
ENCLOSED STARTERS**

**ELECTRONIC  
COMPACT STARTERS**

**UNIVERSAL  
MOTOR CONTROLLER**

**CUSTOMER MADE MOTOR  
STARTING SOLUTION**

**CERTIFICATIONS AND  
APPROVALS - GENERAL  
TECHNICAL DATA**

**INDEX**

**MARKETING MATERIAL**

# Protection and control

To keep things running you need control

02

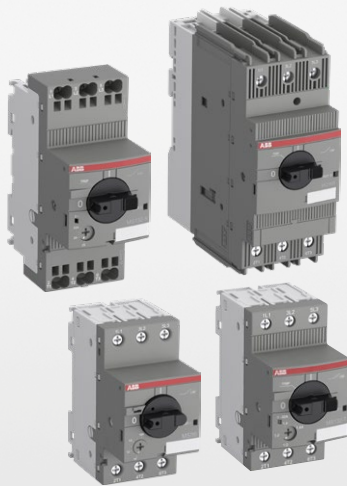

**Manual motor starters and transformer protection**

- Fuseless motor and transformer protection up to 80 A
- Designed to perfectly combine with ABB contactors
- Harmonized accessory range

03



**Contactors and contactor relays**

- 3-pole and 4-pole AC / DC electronic control coil from 9 up to 2850 A AC-1, 500 kW AC-3
- GAF contactors for solar application
- UA...UA...RA for capacitor switching
- AFS contactors for safety applications

04



**Mini contactors and mini contactor relays**

- Up to 20 A AC-1 / 5.5 kW AC-3 400 V
- Flattest mini contactors on the market
- 3 different connecting terminals available
- Wide accessories assortment

05



**Contactors and contactor relays designed for OEM's**

- Compact and powerful - up to 7.5 kW AC-3
- Designed for OEM's
- Specially suitable for motor control application

06



**Overload relays**

- Thermal and electronic type
- Up to 200 A (thermal) and 1250 A (electronic)
- Direct mounting to AF contactors

07



**Thermistor protection relays**

- Monitoring of the winding temperature of motors which have PTC temperature sensors installed
- Evaluation of various motor conditions such as overheating, overload and insufficient cooling
- ATEX approval available for the use in hazardous areas

08

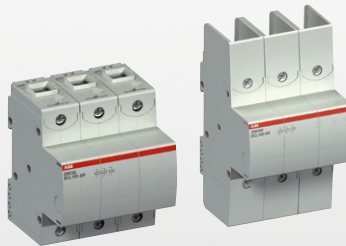

**Self resetting current limiting module**

- Increases the short-circuit breaking capacity of downstream devices
- Ideal solution for group protection

09



**Enclosed starters**

- For machine or wall mounting motor starter
- Up to 7.5 kW
- Robust IP66 and type 4X enclosure

10



**Electronic compact starters**

- Forward and reverse running, motor protection, emergency stop
- Space saving up to 90% with only 22.5mm width
- Up to 75% reduced time in wiring and installation: less error-prone wiring

11

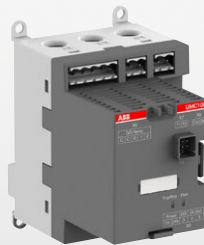

**Universal motor controller**

- Provision of detailed operational, diagnostic and service data continuously
- Effective data source for modern predictive maintenance systems in any plant
- Seamless integration into ABB Ability™ System 800xA platform

12

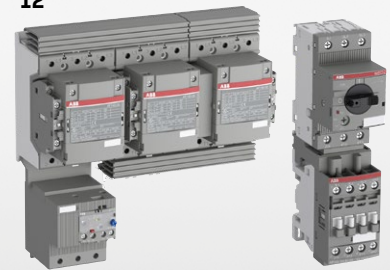

**Customer made motor starting solution guide**

- Coordination type 1 and 2 for
  - Direct-on-line starting
  - Reversing starters
  - Start-delta starters
- Full range of connecting kits

## Protection and control

To keep things running you need control

ABB's protection and control solutions set the standard in sustainable performance, reliability and shapes your daily life. ABB certified products and processes make it easier to design and service equipment through easy engineering, optimized logistics, simple installations, energy savings, reduced maintenance and long lasting solutions.

—  
01



—  
02



—  
03



—  
01 Appliances  
—  
02 Elevator  
—  
03 Food & beverage



# From small controls to power distribution

For system integrators, OEMs, engineering consultants and distributors to panel builders and industrial end-users, ABB's comprehensive range of motor starting solutions, products and services delivers the certainty of consistent quality and performance.



—  
04



—  
05



—  
06

- 04 EV charging
- 05 Wind power
- 06 Solar power

Control matters, productivity and safety relies on keeping things running. ABB's control and protection solutions ensure performance when it is needed the most.

# Manual motor starters

A complete motor protection concept  
Up to 80 A

## Protect equipment and installations with manual motor starters

Manual motor starters, are mainly used to switch motors ON/OFF manually and to provide fuseless protection against short-circuit, overload and phase failures. ABB manual motor starters save costs, space and ensure a quick reaction under short-circuit condition by switching the motor off within milliseconds.

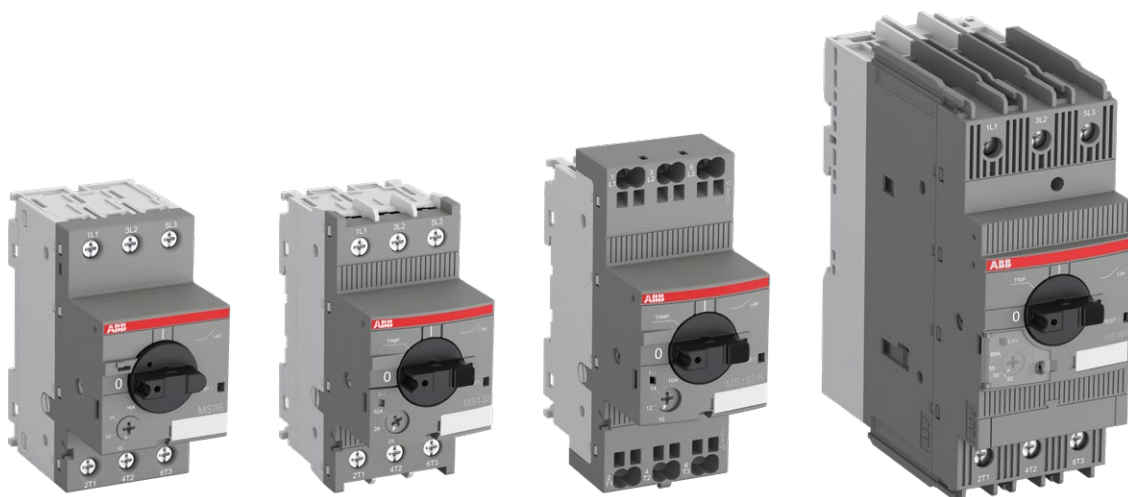

### Well coordinated and IE3 ready starter combinations

ABB provides coordination tables for the selection of low voltage equipment specifically designed for starting and protecting IE2 and IE3 motors.

ABB's SOC tool (Selected Optimized Coordination) is available at:  
<https://applications.it.abb.com/SOC/Page/Selection.aspx>

### Combines naturally with ABB contactor ranges

ABB manual motor starters match perfectly and are easy to connect with ABB motor control devices, to create type 1 or type 2 motor starting solutions



## AF contactors

One range for motor starting and power switching  
Up to 2850 A AC-1

### Featuring AF technology as standard

ABB range of AF contactors is the industry benchmark. The integrated electronically controlled coil offers multiple benefits over conventional alternatives, and together with ABB's wide product offering an optimal configuration, every time.

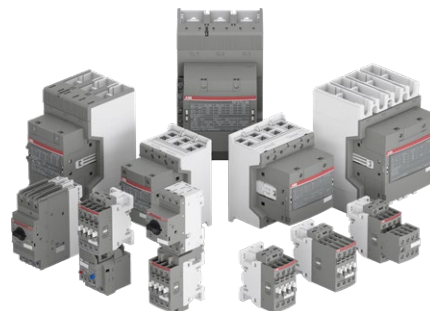

#### Complete global range

AF contactor range features a full assortment of accessories, thermal or electronic overload relays, connecting accessories, is available as standard globally and meets all major international and national standards, and marine applications

#### 3-pole and 4-pole range

AF is available as 3-pole contactors from 9A up to 1060 A AC-3 or up to 2850 A AC-1 and as 4-pole contactors up to 525 A AC-1 all with AC / DC wide operational voltage range coils.

## Just push-it

The next generation of spring technology  
Up to 38 A

### Reliable as ever connections for manual motor starters and for contactors

With the new Push-in Spring motor starting solution, one push is all you need for extremely fast wiring. No tool is required, so you can save up to 50% wiring time with Push-in Spring compared to conventional spring solutions, and the connections are just as reliable. So for speed, ease and reliability, just push it.



### Faster than ever installation, Easier than ever wiring



#### Push-in mode or spring mode in the same terminal

For the very first time on the market, ABB's 2-in-1 connection allows you to use ferruled and rigid cables (Push-in mode) or cables without ferrules (Spring mode) in the same terminal. In Push-in mode, cables can be inserted by just simply pushing them in by hand.

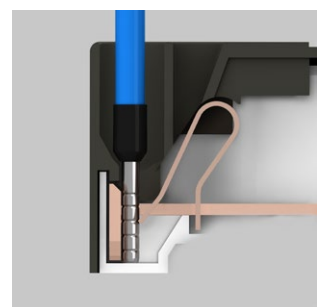
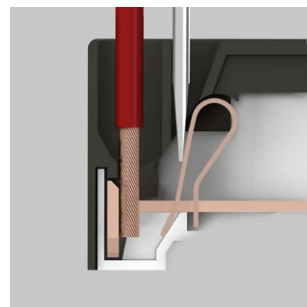

# AFS contactors

Because safety matters  
Up to 96 A

## Contactors dedicated for safety application

Easy to identify with its yellow signature, while enjoying the latest AF technology on board, AFS contactor is the chain link specially dedicated for safety application systems.



**Designed for machine safety applications,** AFS contactors come with fixed front auxiliary contact blocks, making them ideal for monitoring and controlling circuits.

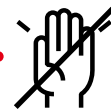
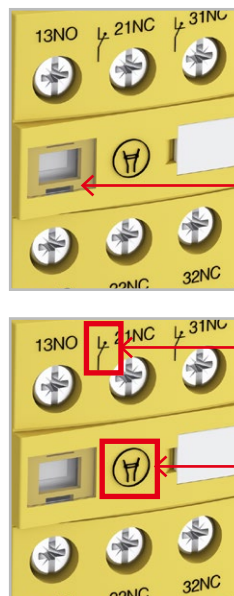

Factory-mounted, non-removable, safety cap

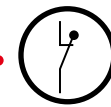

Mechanically linked and mirror contacts



### Safety down to the detail

Contactors status is guaranteed with mechanically linked and mirror contacts . Non removable safety cap prevent unexpected manual operation.



## B mini contactors

Efficient and space saving  
Up to 5.5 kW AC-3

### The flattest mini contactor on the market

B mini contactors are ideally suited for applications where reliability is a must and space is at a premium. The dimensions, technical features and the variety of the assortment provide customers a high flexibility in a wide-range of applications.



#### Hides in any place

B mini contactors can be used in any place such as for house or hotel fittings, small house equipment, swimming pools, your workshop or garage door as well as for bakeries or any machine that requires a very small control device.

Mini contactors has its marine approvals like any other ABB big brother.

#### Small in all variants

B mini contactors or mini interface relays have screw, flat pin or soldering pin terminals; noise free AC or DC operated coil always within the same small dimensions and its compact reversing starter has no spacing required for its built-in mechanical interlock. Its screw or din rail mount also helps make it simple to engineer compact panels.

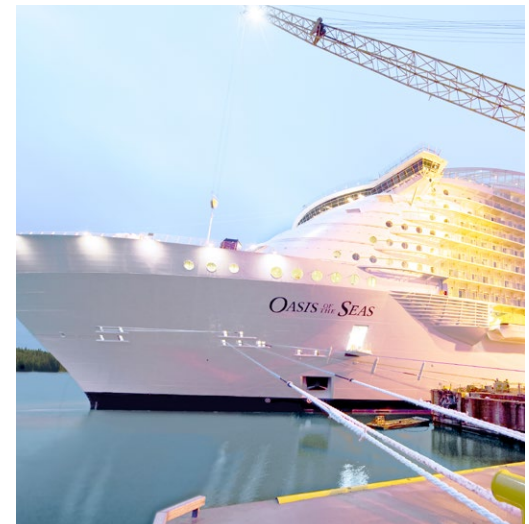

# AS contactors

Compact and powerful  
Up to 16 A AC-3

## Designed for OEMs

AS solution has been specially designed for OEM applications. It allows to assemble starting solutions in compact size either with AC coil or DC coil and with screw terminals or spring terminals.

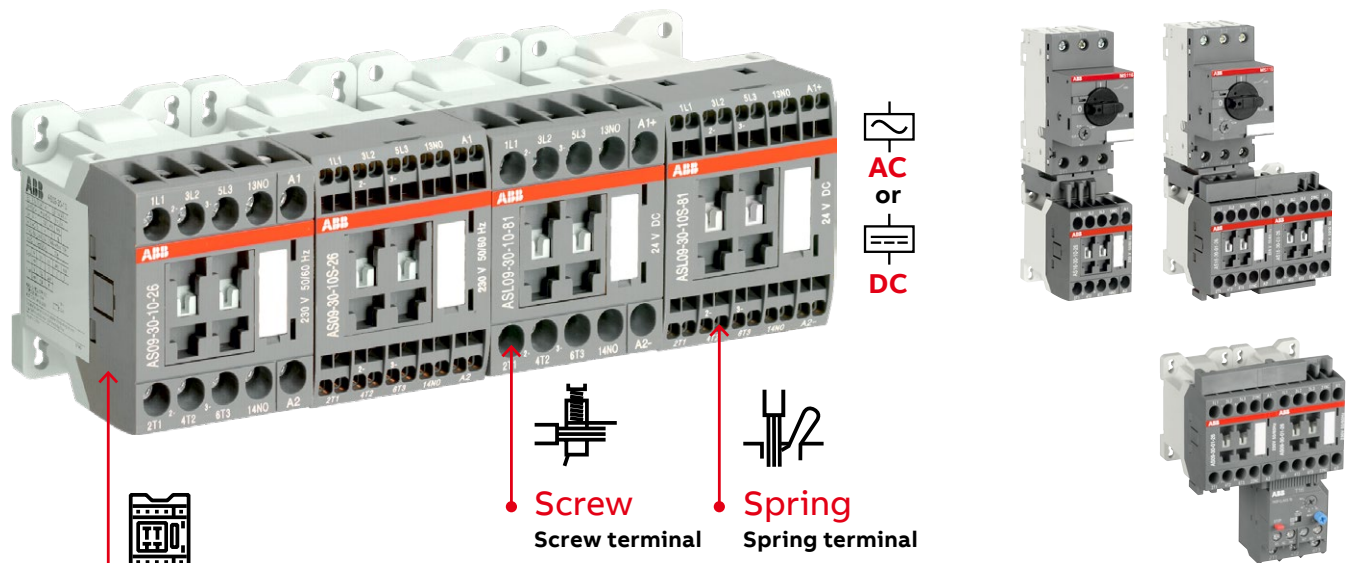

**W 45 x H 68 x D 72.5 mm**

**All in same dimensions**

AS contactors feature AC and DC control circuits, screw or spring terminals all in 45 mm width modules with no spacing required even when they are combined with motor protection devices for direct-on-line reversing or star delta starters.



**Screw**  
Screw terminal



**Spring**  
Spring terminal

### Mainly for motor control

Combined with motor protection devices, AS 3-pole contactors are specially suitable for motor control applications such as ventilation systems, air conditioning, small pumps, escalators, laundries or food and baking equipment

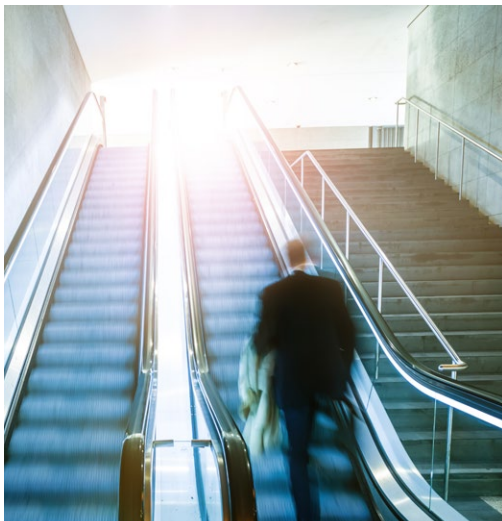



## GF and GAF contactors

A compact and efficient way to switch DC loads

### Optimal for central inverters

ABB offers the widest range of compact contactors for DC load switching in low voltage power distribution. Thanks to their breaking performance of DC circuits, GF contactors will switch DC-PV3 inverter loads up to 1325 A 1500 V DC and GAF contactors will switch DC loads up to 2050 A 1000 V DC-1.

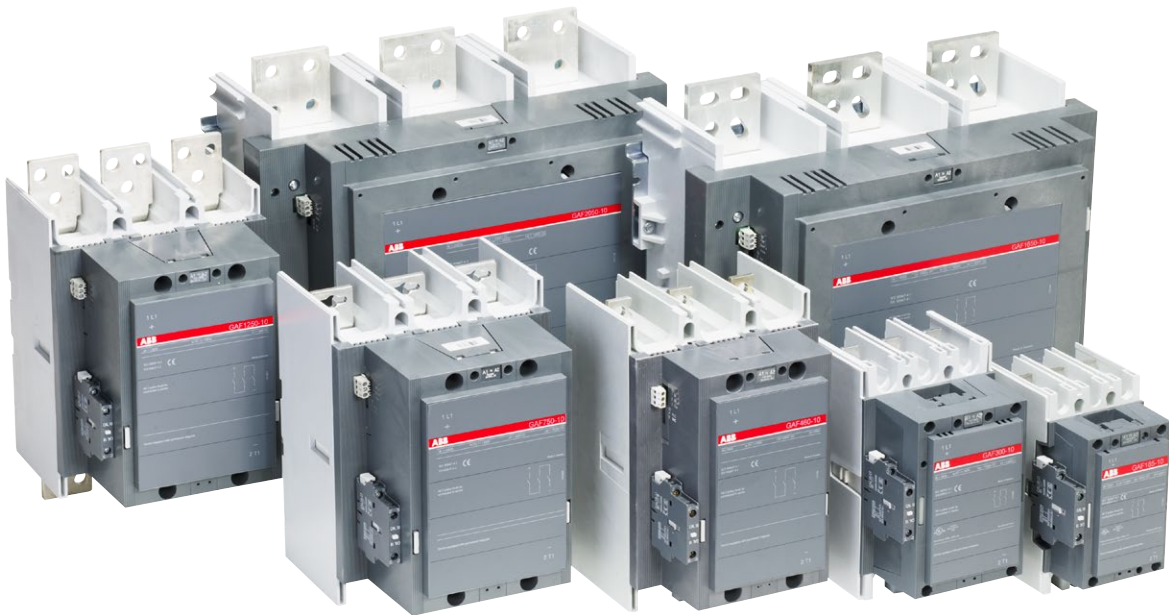

### PV solar plant

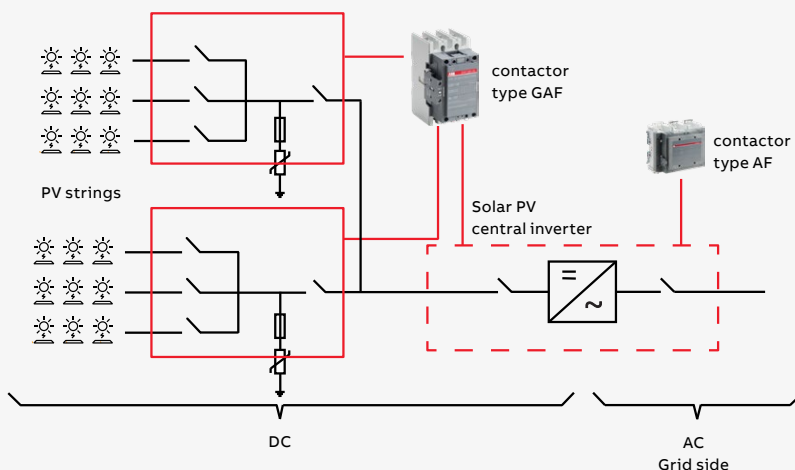



# UA and UA..RA contactors

## For capacitor switching up to 80 kvar

### Safely switch your capacitor banks without contacts welding

ABB offers the widest contactor range on the market for the capacitor switching demanding application. UA..RA contactors with damping resistors, are used when inrush peak currents are far exceeding 100 times. UA contactors is a simple solution used when peak currents are less or equal to 100 times nominal rms current.

#### Power factor correction

Industrial sites have low power efficiency due to motor winding inductances. Capacitor bank panels are added for power factor correction. An automatic power factor correction system consists of several capacitor banks of identical or different ratings (several steps), energized separately according to the value of the power factor to be corrected.

The inrush current peak, in the case of automatic correction, depends on the power of the steps already on duty, and can reach 100 times the nominal current of the step to be energized.

Switching capacitors banks with standard contactors may cause electrical damages like contact welding, coil burning or even fire on the installation.

ABB provides a choice of contactors dedicated for capacitor switching applications and CAPCAL a selection tool, available on the ABB Website:

<https://new.abb.com/low-voltage/products/motor-protection/contactors-for-capacitor-switching>

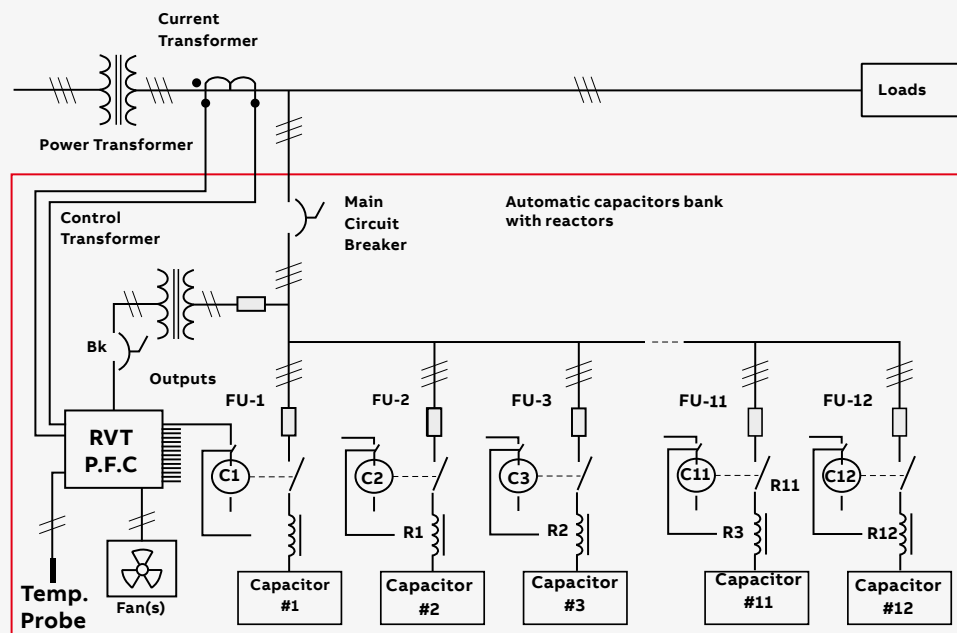
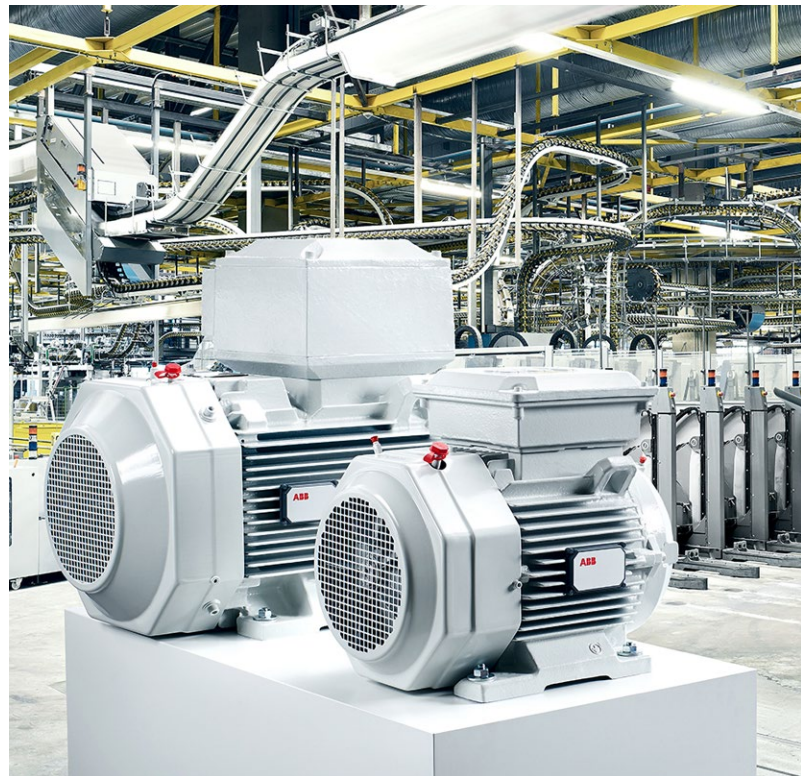

# HF range

Great functionality in only 22.5 mm

## Electronic compact starters

Direct-on-line, reverse start, overload protection and emergency stop is all integrated in one compact device of only 22.5 mm width. Reliable 30 millions switching cycles for motors up to 3 kW / 400 V AC, reduced wiring time and faults are additional benefits.

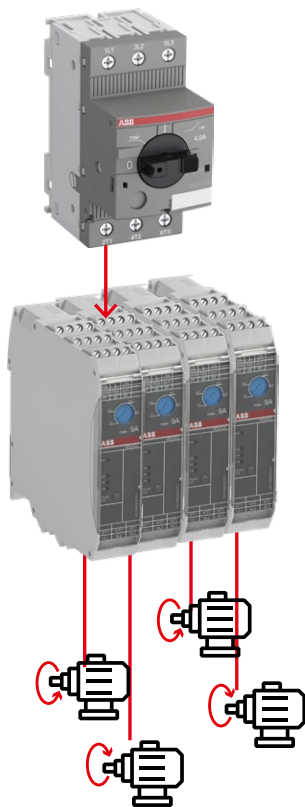

### Short circuit protection

Coordinated short circuit protection for single and group mounting with manual motor starters is available.

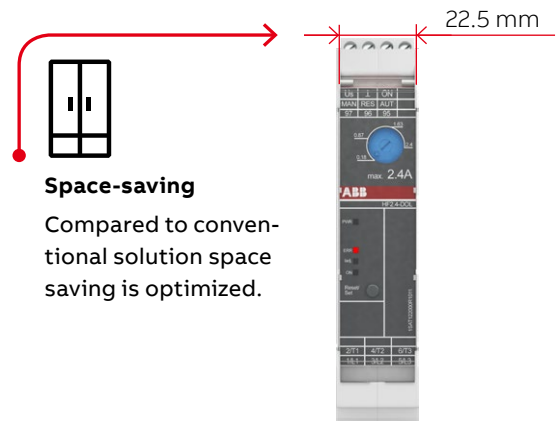

### Space-saving

Compared to conventional solution space saving is optimized.

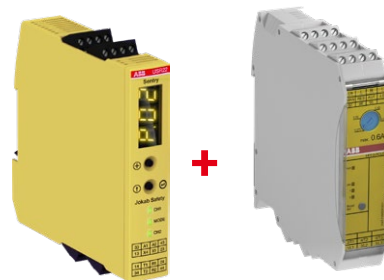

### Safety and ATEX

In combination with Sentry safety relays the HF-Starter reaches SIL3, PL e certification. Feel free to use safety tools like FSDT and Sistema. The libraries are online on ABB.com. Additionally safety variants are ATEX certified.



### Control of cooling tanks

The HF range is used to control pumps and compressor for cooling.



### Solar tracker

The panels follow the sun and need to be switched frequently in a small cabinet.



### Snow canons

Similar to the solar tracker the snow canon is switched left and right to ensure equal snow conditions.



### Straightening metal

The metal is unrolled directly from the coil. The motor needs to be switched frequently.

# Contactors and motor protection for rolling stock

## Sustainable mobility for a better world

Specifically designed and manufactured for rolling stock applications (1), our products can be installed in any environment including passenger or driver cabins, for main or urban line trains, underground trains or trams circulating frequently in tunnels or underground passages.

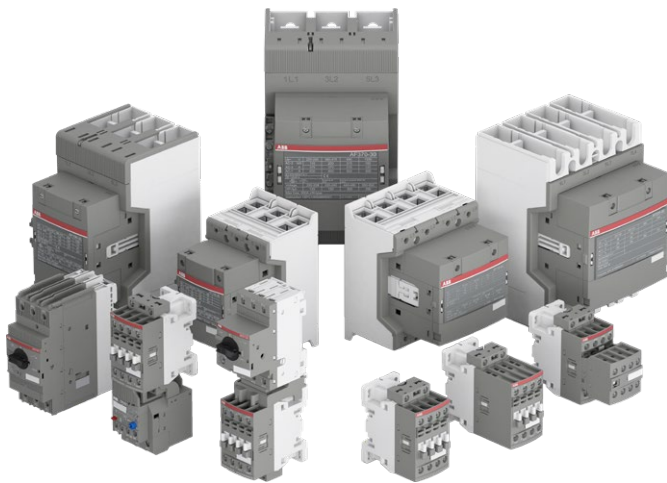

**With the latest technology in our product for rolling stock you can**

- Simplify your installation thanks to compact solution and modular frame size
- Reduce train energy consumption with lighter devices increasing passenger capacity and less coil energy consumption improving power management.
- Optimize your logistics and stocks
- Protect persons and equipment with products specifically designed to meet the latest rolling stock requirements
- Secure uptime thanks to AF technology, handle the large voltage fluctuation to battery use
- Reduce maintenance costs, downtimes and make troubleshooting easier with real motor protection.

(1) Important notice:  
Standard contactors are not suitable for rolling stock applications due to the specific requirements in terms of norms, performance and approvals.  
For rolling stock applications, please contact your local ABB sales representative.

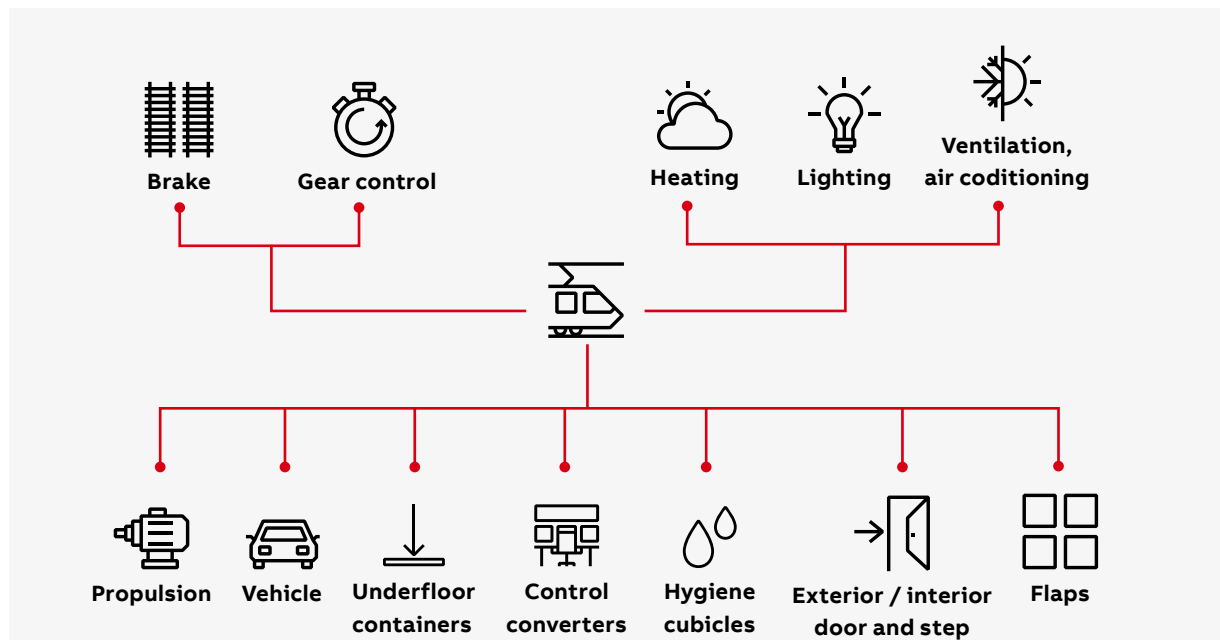

# How to use this catalog

## Product image

Click on the product to zoom in.



AF146-30-00



AF146-30-00B

## Product type

Click on the product type to get 2D and/or 3D drawings.

ABB MOTOR PROTECTION AND CONTROL

3/17

### AF116 ... AF146 3-pole contactors

55 to 75 kW  
AC / DC operated

AF116 ... AF140 contactors are mainly used for controlling 3-phase motors and power circuits up to 690 V AC, AF146 up to 1000 V AC and AF116 ... AF146 up to 260 V DC. These contactors are of the block type design with 3 main poles.

- control circuit: AC or DC operated with electronic coil interface accepting a wide control voltage range (e.g. 100...250 V AC and DC), only 4 coils to cover control voltages between 24...500 V 50/60 Hz and 20...500 V DC
- can manage large control voltage variations
- reduced panel energy consumption
- very distinct closing and opening
- can withstand short voltage dips and voltage sags (SEMI F47 conditions of use on request).
- built-in surge suppression
- add-on auxiliary contact blocks for side mounting and a wide range of accessories.

IEC Rated operational power	UL / CSA 3-phase motor rating	General use rating	Rated control circuit voltage	Auxiliary contacts fitted	Type (1)	Order code	Weight
400 V AC-3 kW	AC-1 A	hp A	Uc min... Uc max. V 50/60 Hz V DC				Pkg (1 pce) kg

#### For connection with built-in cable clamps

55	160	75	160	24...60	20...60	0 0	AF116-30-00-11	1SFL427001R1100	1.750
				48...130	48...130	0 0	AF116-30-00-12	1SFL427001R1200	1.750
				100...250	100...250	0 0	AF116-30-00-13	1SFL427001R1300	1.750
75	200	100	200	24...60	20...60	0 0	AF140-30-00-11	1SFL447001R1100	1.750
				48...130	48...130	0 0	AF140-30-00-12	1SFL447001R1200	1.750
				100...250	100...250	0 0	AF140-30-00-13	1SFL447001R1300	1.750
75	225	100	200	24...60	20...60	0 0	AF146-30-00-11	1SFL467001R1100	1.750
				48...130	48...130	0 0	AF146-30-00-12	1SFL467001R1200	1.750
				100...250	100...250	0 0	AF146-30-00-13	1SFL467001R1300	1.750
				250...500	250...500	0 0	AF146-30-00-14	1SFL467001R1400	1.750

#### With bar connections

55	160	75	160	24...60	20...60	0 0	AF116-30-00B-11	1SFL427002R1100	1.500
				48...130	48...130	0 0	AF116-30-00B-12	1SFL427002R1200	1.500
				100...250	100...250	0 0	AF116-30-00B-13	1SFL427002R1300	1.500
75	200	100	200	24...60	20...60	0 0	AF140-30-00B-11	1SFL447002R1100	1.500
				48...130	48...130	0 0	AF140-30-00B-12	1SFL447002R1200	1.500
				100...250	100...250	0 0	AF140-30-00B-13	1SFL447002R1300	1.500
75	225	100	200	24...60	20...60	0 0	AF146-30-00B-11	1SFL447002R1100	1.500
				48...130	48...130	0 0	AF146-30-00B-12	1SFL447002R1200	1.500
				100...250	100...250	0 0	AF146-30-00B-13	1SFL447002R1300	1.500
				250...500	250...500	0 0	AF146-30-00B-14	1SFL467002R1400	1.500

(1) For other auxiliary contacts arrangements, please contact your ABB local sales organization.

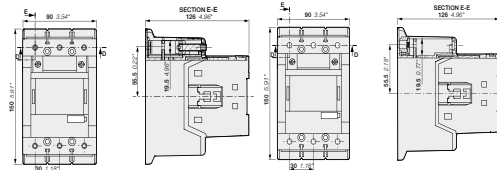

AF116, AF140, AF146-30-00

Main dimensions mm, inches

AF116, AF140, AF146-30-00B



Find more information on our marketing material page.



Chart and datas of motor rated operational powers and currents are available in the customer made motor starting solutions chapter.

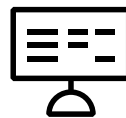

The products in this catalogue can also be found together with product news life cycle status, data sheets, certificates and tools at:

<https://new.abb.com/low-voltage/products/motor-protection>



**Product order code**  
click on the product order code to obtain the data sheet, the agreement and all technical information regarding that reference.



**Product order code**  
For direct product details information, use product type or order code, ex:  
[www.abb.com/product-details/AF09-30-10-13](http://www.abb.com/product-details/AF09-30-10-13) or  
[www.abb.com/product-details/1SBL137001R1310](http://www.abb.com/product-details/1SBL137001R1310)

Web catalog

Print catalog

## Ordering details

Orders can be placed either using the type code or the order code. The type codes or ordering codes generally relate to single devices like a contactor, overload relays or an accessory but they can sometimes relate to an indivisible set (ex: connecting kits) or a bag (ex 50 function markers). See the description of the device.

## Packaging unit

Products are generally packed as single units but very small products or accessories are often proposed in collective packs. Please refer to the “Package quantity” in the ordering detail charts.

## Standards and approvals for the products

Products in this catalogue are designed tested and have third party approvals and markings in compliance with major international or local standards such as EN/IEC 60947-1, EN /IEC947-4-1, EN/IEC 60947-2, EN/IEC 60947-5-1 or UL 60947-4-1. See approvals and certification section.

## Standards and approvals for design and manufacturing

ABB has set up a quality assurance organization in compliance with the requirements of ISO 9001 standard and ABB factories are ISO 9001 approved.

## Guarantee

The information contained in this catalogue reflects the current state of our knowledge and aims to present our products and their possible applications as defined with the standards. The product data, ratings and utilization conditions are indicated in their respective sections, thus the information does not guarantee special utilizations or combination of characteristics that have not been defined or tested according to normalized values or test conditions defined with the standards.

## Liability

The devices in this catalogue do not endanger safety when they are selected, mounted, commissioned used maintained and deposed with the rules and standards that apply to them.



## Railways applications for rolling stock are not covered with this catalogue

The products in this catalog do generally not meet the special requirements and approvals for rolling stock applications. ABB offers specifically approved products processes and support for this application.

### For rolling stock application see our dedicated portal



<https://new.abb.com/low-voltage/products/motor-protection/contactors-and-motor-protection-for-railway-applications>



# Main online tools

## 2D and 3D CAD models, ABB CAD Download center

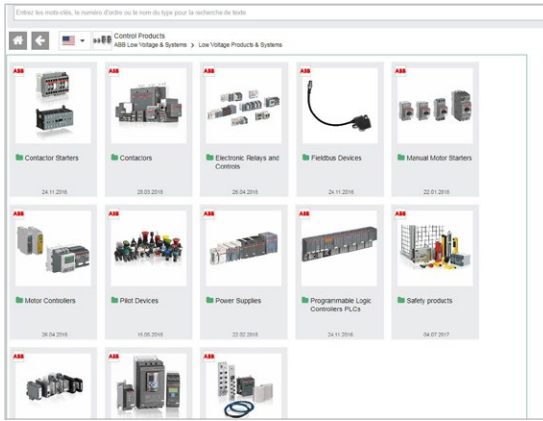

Cadenas portal: Download 2D or 3D files according to your needs (STEP, IGES...)



## Selected Optimized Coordination tables - SOC

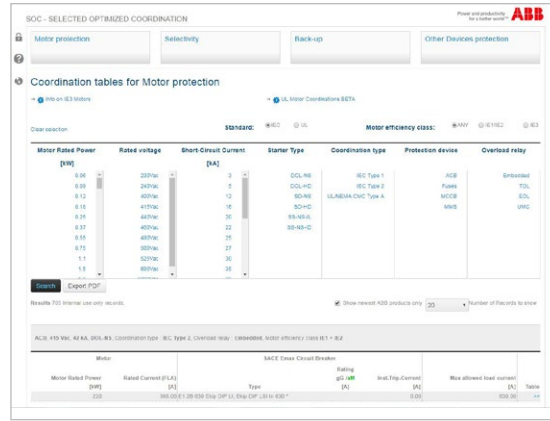

Selected Optimized Coordination tables SOC



## Data sheets instructions, manuals and certificates

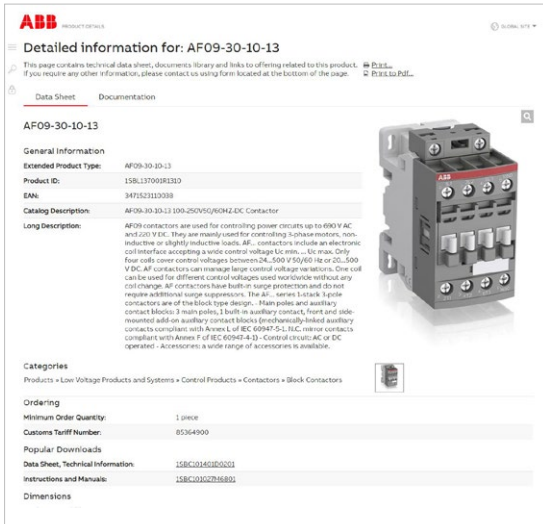

For direct product details information, use product type or order code, EX:  
[www.abb.com/productdetails/AF09-30-10-13](http://www.abb.com/productdetails/AF09-30-10-13) or  
[www.abb.com/productdetails/15L137001R1310](http://www.abb.com/productdetails/15L137001R1310)

## Configurators e-Configure

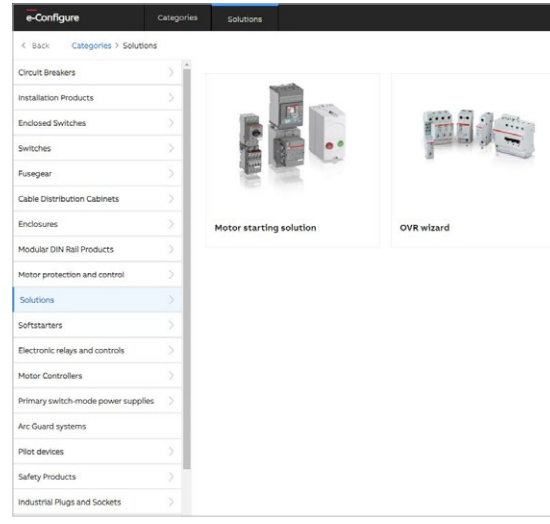

<https://econfigure.xe.abb.com/global/#/categories/cfg-solution-Configurators>



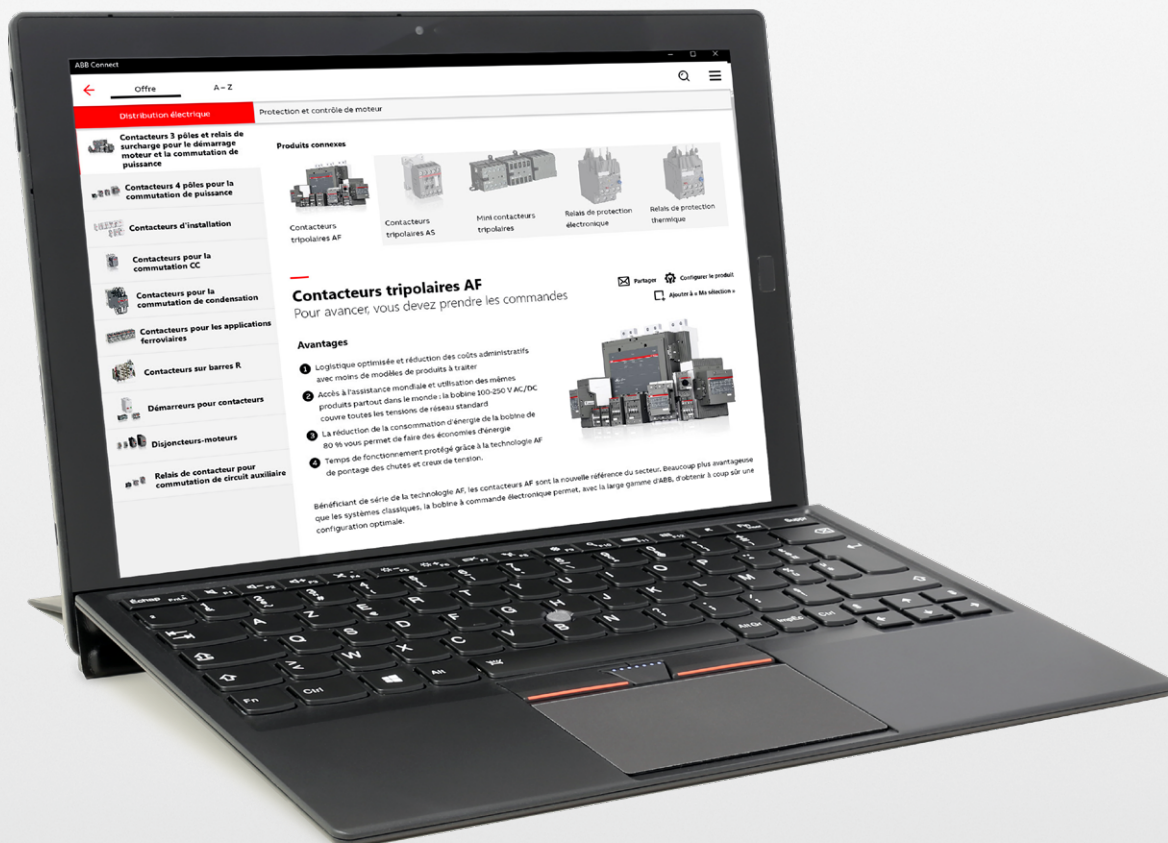

## ABB Connect

### Your digital assistant

Connect to your electrification solutions with your digital assistant, access the latest news and create your own digital workspace; search '**ABB Connect**' on the Apple App Store, Google Play Store or Microsoft Store and download today.



Find the latest product details



Make your phone or tablet your workspace



Tap and stay connected to all the latest information



Scan and download ABB Connect for iOS, Android or Windows 10

[new.abb.com/low-voltage/service/abb-connect](https://new.abb.com/low-voltage/service/abb-connect)



# General overview motor protection and control

## 3-pole contactors

## Mini contactors

## Contactors



<b>IEC (1)</b>	<b>AC-3 Rated operational power</b>	$\theta \leq 60^\circ\text{C}$ (2), 400 V	<b>kW</b>	4	5.5	4	5.5	7.5	4	5.5	7.5	11	15	18.5
<b>UL/CSA</b>	<b>3-phase motor rating</b>	480 V	<b>hp</b>	3	5	5	7.5	10	5	7.5	10	15	20	25
<b>AC / DC Control supply</b>		Type	—	—	—	—	—	—	AF09	AF12	AF16	AF26	AF30	AF38
<b>AC Control supply</b>		Type	<b>B6</b>	<b>B7</b>	<b>AS09</b>	<b>AS12</b>	<b>AS16</b>	<b>AF09</b>	<b>AF12</b>	<b>AF16</b>	<b>AF26</b>	<b>AF30</b>	<b>AF38</b>	
<b>DC Control supply</b>		Type	<b>BC6</b>	<b>BC7</b>	<b>ASL09</b>	<b>ASL12</b>	<b>ASL16</b>	<b>AF09</b>	<b>AF12</b>	<b>AF16</b>	<b>AF26</b>	<b>AF30</b>	<b>AF38</b>	
<b>IEC</b>	<b>AC-3 Rated operational current</b>	$\theta \leq 60^\circ\text{C}$ (2), 400 V	<b>A</b>	8.5	11.5	9	12	15.5	9	12	18	26	32	38
	<b>AC-1 Rated operational current</b>	$\theta \leq 40^\circ\text{C}$ , 690 V	<b>A</b>	20 (400 V)	20 (400 V)	22	24	24	25	28	30	45	50	50
<b>UL/CSA</b>	<b>General use rating</b>	600 V	<b>A</b>	12 (300 V)	16	20	20	20	25	28	30	45	50	50
<b>NEMA</b>	<b>NEMA Size</b>		—	—	00	00	0	00	0	—	1	—	—	

(1) 1000 V IEC ratings available for AF80, AF96 and AF146 ... AF2650 contactors.

(2)  $\theta \leq 55^\circ\text{C}$  for mini contactors and AF400 ... AF2650 contactors.

## Main accessories

<b>Auxiliary contact blocks</b>	Front mounting	<b>CAF6</b>	<b>CA3-10</b> (1 x N.O.) <b>CA3-01</b> (1 x N.C.)	<b>CA4-10</b> (1 x N.O.) <b>CA4-01</b> (1 x N.C.)
	Side mounting	<b>CA6</b>		<b>CAL4-11</b> (1 x N.O. + 1 x N.C.)
<b>Timers</b>	Electronic		<b>TEF3-ON</b> <b>TEF3-OFF</b>	<b>TEF4-ON</b> <b>TEF4-OFF</b>
<b>Interlocking units (3)</b>	Mechanical		<b>VM3</b>	<b>VM4</b>
	Mechanical / Electrical			<b>VEM4</b>
<b>Connection sets</b>	For reversing contactors	<b>BSM6-30</b>	<b>BER16C-3</b>	<b>BER16-4</b> <b>BER38-4</b>
<b>Surge suppressors</b>	Varistor (AC/DC)	<b>RV-BC6</b>	<b>RV5</b> (24...440 V)	<b>Built-in surge protection</b>
	RC type (AC)		<b>RC5-1</b> (24...440 V)	
	Transil diode (DC)	<b>RD7</b>	<b>RT5</b> (12...264 V)	

(3) See available reversing contactors VB6, VB7 and VAS09 ... VAS16.

## Overload relays

<b>Thermal relays</b>		Class 10 (Class 10A for TF140, TA200DU)	<b>T16</b> (0.10...16 A)	<b>T16</b> (0.10...16 A)	<b>TF42</b> (0.10...38 A)
<b>Electronic relays</b>		Class 10E, 20E, 30E	<b>E16DU</b> (0.10...18.9 A)		<b>EF19</b> (0.10...18.9 A) <b>EF19</b> (0.10...18.9 A) <b>EF45</b> (9...45 A)

## Manual motor starters

	Thermal / magnetic protection Class 10	<b>MS116</b> (0.10...32 A) lcs up to 50 kA for class 10A	<b>MS116</b> (0.10...32 A) lcs up to 50 kA for class 10A	<b>MS165</b> (10...80 A) lcs up to 100 kA
	Magnetic only types	<b>MS132</b> (0.10...32 A) lcs up to 100 kA	<b>MS132</b> (0.10...32 A) lcs up to 100 kA	<b>MO165</b> (16...80 A) lcs up to 100 kA
		<b>MO132</b> (0.16...32 A)	<b>MO132</b> (0.16...32 A) lcs up to 100 kA	
<b>Accessories</b>	For contactor mounting	<b>BEA7/132</b>	<b>BEA16-3</b> <b>BEA16-4</b> <b>BEA38-4</b>	

(4) BEA65-4 suitable for MS165 and MO165 only.

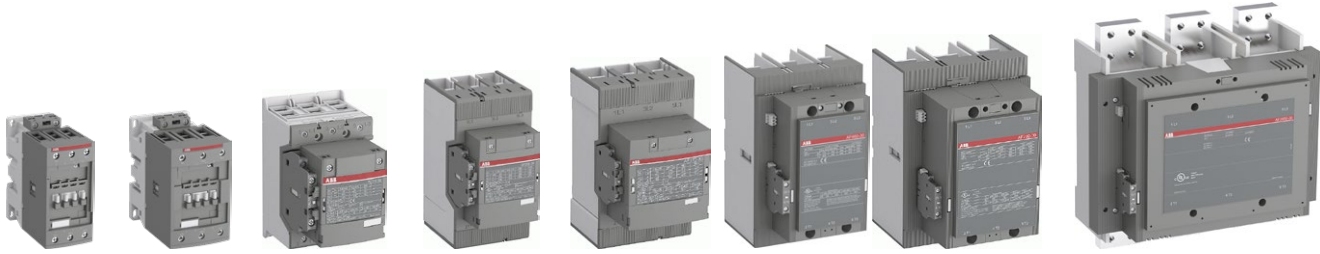

18.5	22	30	37	45	55	75	75	90	110	132	160	200	200	250	315	400	—	475	560	—	—	—																							
30	40	50	60	60	75	100	100	125	150	200	250	300	350	400	500	600	—	800	900	—	—	—																							
AF40		AF52		AF65		AF80		AF96		AF116		AF140		AF146		AF190		AF205		AF265		AF305		AF370		AF400		AF460		AF580		AF750		AF1250		AF1350		AF1650		AF2050		AF2650		AF2850	
AF40		AF52		AF65		AF80		AF96		AF116		AF140		AF146		AF190		AF205		AF265		AF305		AF370		AF400		AF460		AF580		AF750		AF1250		AF1350		AF1650		AF2050		AF2650		AF2850	
AF40		AF52		AF65		AF80		AF96		AF116		AF140		AF146		AF190		AF205		AF265		AF305		AF370		AF400		AF460		AF580		AF750		AF1250		AF1350		AF1650		AF2050		AF2650		AF2850	
40	53	65	80	96	116	140	146	190	205	265	305	370	400	460	580	750	—	860	1060	—	—	—																							
70	100	105	125	130	160	200	225	275	350	400	500	600	600	700	800	1050	1260	1350	1650	2050	2650	2850																							
60	80	90	105	115	160	200	200	250	300	350	400	520	550	650	750	900	1210	1350	1650	2100	2700	2850																							
2	—	—	3	—	—	4	—	—	—	5	—	—	—	6	—	7	—	—	8	—	—	—																							

		<b>CAL19-11</b> (1 x N.O. + 1 x N.C.)				<b>CAL18-11</b> (1 x N.O. + 1 x N.C.)											
<b>VM96-4</b>		<b>VM19</b> (for same size contactors)				<b>VM750H</b> <b>VM750V</b>				<b>VM1650H</b>							
<b>BER65-4</b>		<b>BER96-4</b>		<b>BER140-4</b>		<b>BER205-4</b>		<b>BER370-4</b>		<b>BEM460-30</b>		<b>BEM750-30</b>					

<b>TF65</b> (22...67 A)	<b>TF96</b> (40...96 A)	<b>TF140DU</b> (66...142 A) θ ≤ 55 °C	<b>TA200DU</b> (66...200 A) θ ≤ 55 °C				
<b>EF65</b> (20...70 A)	<b>EF96</b> (20...100 A)	<b>EF146</b> (54...150 A)	<b>EF205</b> (63...210 A)	<b>EF370</b> (115...380 A)	<b>EF460</b> (150...500 A)	<b>EF750</b> (250...800 A)	<b>EF1250DU</b> (350...1250 A)



**BEA65-4 (4)**

# General overview motor protection and control

## 4-pole contactors

### Mini contactors









IEC	AC-1 Rated operational current	$\theta \leq 40^\circ\text{C}, 690\text{ V}$	A	16	20
UL/CSA	General use rating	600 V	A	12 (300 V)	16
AC / DC Control supply			Type	—	—
AC Control supply			Type	B6	B7
DC Control supply			Type	BC6	BC7

## Contactor relays

### Mini contactor relays



IEC	AC-15 Rated operational current	400 V	A	3		
UL/CSA	Pilot duty			A600		
						
						
AC Control supply			Type	K6-22Z	K6-31Z	K6-40E
DC Control supply			Type	KC6-22Z	KC6-31Z	KC6-40E
AC / DC Control supply			Type	—	—	—

## Specific contactors

### DC Circuit switching



100 A, 440 V, DC-1  
GA75, GAE75 types



275 to 2050 A, 1000 V, DC-1  
GAF185 to GAF2050 types

## Contactors



25	30	45	55	70	100	125	160	200	275	350	400	500	525	800	1000
25	30	45	55	60	80	105	160	175	230	250	300	350	420	540	—
<b>AF09</b>	<b>AF16</b>	<b>AF26</b>	<b>AF38</b>	<b>AF40</b>	<b>AF52</b>	<b>AF80</b>	<b>AF116</b>	<b>AF140</b>	<b>AF190</b>	<b>AF205</b>	<b>AF265</b>	<b>AF305</b>	<b>AF370</b>	—	—
<b>AF09</b>	<b>AF16</b>	<b>AF26</b>	<b>AF38</b>	<b>AF40</b>	<b>AF52</b>	<b>AF80</b>	<b>AF116</b>	<b>AF140</b>	<b>AF190</b>	<b>AF205</b>	<b>AF265</b>	<b>AF305</b>	<b>AF370</b>	<b>EK550</b>	<b>EK1000</b>
<b>AF09</b>	<b>AF16</b>	<b>AF26</b>	<b>AF38</b>	<b>AF40</b>	<b>AF52</b>	<b>AF80</b>	<b>AF116</b>	<b>AF140</b>	<b>AF190</b>	<b>AF205</b>	<b>AF265</b>	<b>AF305</b>	<b>AF370</b>	<b>EK550</b>	<b>EK1000</b>

## Contactor relays



<b>3</b>			<b>3</b>		
<b>A600, Q300</b>			<b>A600, Q600</b>		
<b>NS22E</b>	<b>NS31E</b>	<b>NS40E</b>	<b>NF22E</b>	<b>NF31E</b>	<b>NF40E</b>
<b>NSL22E</b>	<b>NSL31E</b>	<b>NSL40E</b>	<b>NF22E</b>	<b>NF31E</b>	<b>NF40E</b>
—	—	—	<b>NF22E</b>	<b>NF31E</b>	<b>NF40E</b>

## Capacitor switching



12.5 to 80 kvar  
 UA16..RA to UA110..RA types  
 UA16 to UA110 types



**For more information please find our electronic data sheets online, for example:**

[www.abb.com/productdetails/MS116-0.16](http://www.abb.com/productdetails/MS116-0.16)

or

[www.abb.com/productdetails/1SAM250000R1001](http://www.abb.com/productdetails/1SAM250000R1001)



# Manual motor starters & circuit breakers for transformer protection

## Manual motor starters

**2/3** Presentation

**2/8** Overview

### With thermal and electromagnetic protection

#### Ordering details - 0.10 to 80 A

**2/10** MS116 manual motor starters

**2/11** MS132 manual motor starters

**2/12** MS132-K manual motor starters with Push-in Spring terminals

**2/13** MS165 manual motor starters

### With electromagnetic protection

#### Ordering details - 0.16 to 80 A

**2/14** MO132 manual motor starters magnetic only

**2/15** MO165 manual motor starters magnetic only

**2/16** Technical data

**2/28** Circuit breakers for transformer protection

### With thermal and electromagnetic protection

#### Ordering details - 0.10 to 25 A

**2/29** MS132-T circuit breakers for transformer protection

**2/30** MS132-KT circuit breakers for transformer protection  
with Push-in Spring terminals

**2/31** Technical data

**2/34** Accessories



# MS and MO manual motor starters

## A complete motor protection concept



Fuseless protection saves costs, space and ensures a quick reaction under overload and short-circuit condition by switching off the motor within milliseconds. The full range of motor starters offers protection from 0.1 A to up to 100 A. The new family range has a harmonized range of accessories and offers the same features up to 80 A.



### Protection and control

#### Protect equipment and installations

ABB offers a broad range of manual motor starters, for protection and control in almost every situation including hazardous areas, protecting installations from short-circuits, overloads and phase failures while also controlling the current flow through a simple ON/OFF switch.



### Continuous operation

#### Secure uptime

Fuseless motor protection reduces maintenance costs and downtimes by avoiding fuse replacement after faults. Furthermore, MS132 and MS165 feature a magnetic trip indicator making troubleshooting easier.



### Speed up your projects

#### Simplified design

Manual motor starters can be connected easily with ABB contactors or soft starters using the respective accessory. Additionally, the main range of accessories is shared across multiple starters (both with screw and Push-in Spring terminals available), making logistics and planning simpler.

# MS and MO manual motor starters

## A complete motor protection concept

**Right solution for your application**  
MS116 offers protection up to 32 A and a breaking capacity up to 100 kA – all in a 45 mm wide housing. They are designed to meet requirements of most standard applications.

**All-in-one**  
ABB offers fuseless protection against short-circuits, phase failures and overloads including disconnect function – all in one single compact product.

**Troubleshooting made easy**  
MS132 and MS165 feature a magnetic trip indicator. This way, every tripping event will be distinguished, making troubleshooting a lot easier and faster.

**High performance in compact size**  
MS132 and MS165 manual motor starters cover short-circuit breaking capacities up to 100 kA. In addition, every manual motor starter is temperature compensated up to 60 °C.



**Protection wherever you are**  
Manual motor starters are suitable for worldwide use. The wide range of certifications covers standards like IEC (CB), cULus, CCC, EAC and various ship approvals. MS132 and MS165 also apply to ATEX standards for hazardous areas.



**Ready for IE3 motors**  
MS116/MS132/MO132/MS165/MO165 comply with the latest standards. They are "IE3 ready" and will protect the new generation of high efficiency motors.



**Just push it**  
With the new Push-in Spring terminals, one push is all you need for a faster than ever installation, an easier than ever wiring and a reliable as ever connection.

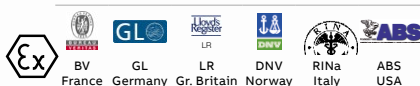



# Protection and control

## The right accessories for your applications

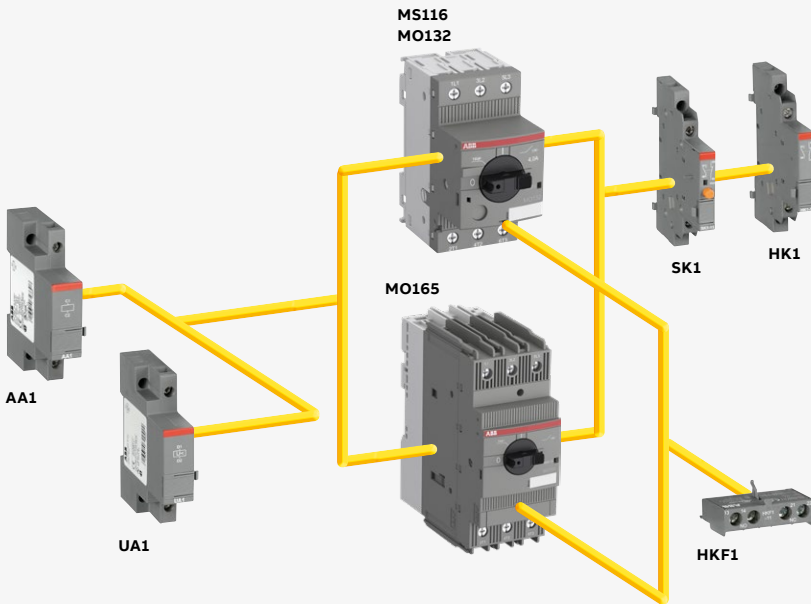

**Harmonized range of accessories**  
 All types up to 80 A share the same main accessories like auxiliary contacts, signaling contacts, shunt trips and undervoltage releases. This significantly reduces the part list and makes selection of the right accessories easy.



**Save wiring time**  
 and avoid mistakes by using a connecting link



**Up to 5 manual motor starters**  
 can be fitted next to each other



**With a lockable handle**  
 maintenance will be safe for every technician

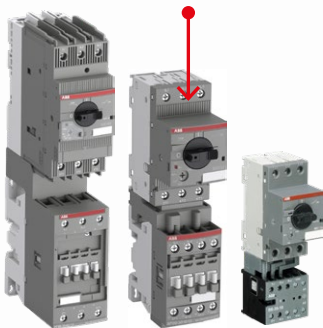

**Easy to connect**  
 Save wiring time and avoid mistakes by using a connecting link between ABB manual motor starters and soft starters or contactors. This creates harmonious and compact starter combinations that are easy to mount.

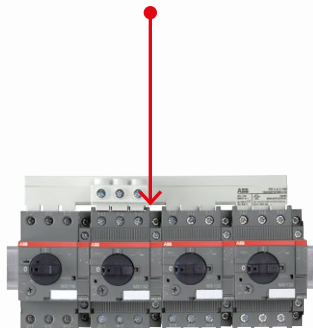

**Busbar connectors and enclosures**  
 With busbar connectors, up to 5 manual motor starters can be fitted next to each other with optional spacing for auxiliary contacts. Enclosures or door handle kits are available as well.



**Safety at work**  
 With a lockable handle maintenance will be safe for every technician. For MS132 and MS165 a lock can seal the handle without the need for an additional accessory.

## Application examples

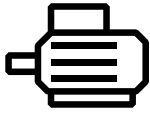

### Motor protection

No matter what type of starter is required by the application (direct-on-line, star-delta, soft starter or variable frequency drive), MS and MO manual motor starters (also known as motor protection circuit breakers or manual motor protectors) are the right protection devices for electric motors from 100 mA up to 100 A.

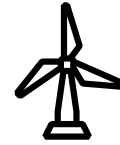

### Starter protection

MO (magnetic-only) manual motor starters are typically used, when motor overload protection is provided by a separate overload protection device. This setup is specially beneficial for applications that require auto- or remote-reset of the starter in case of an overload tripping event (e.g. windmills or HVAC fans).



### Circuit protection and control

ABB's manual motor starters are fuseless circuit breakers (approved acc. to IEC60947-2) that can be used to control circuits and protect cables / lines in industrial and commercial applications from overloads and short-circuits. The built-in disconnect function allows the usage as main On-/Off-switch, typically for de-centralized applications (e.g. small machinery or laboratory systems).



Courtesy of Steven Engineering, Inc - (800) 258-9200 - sales@steveneng.com - www.stevenengineering.com



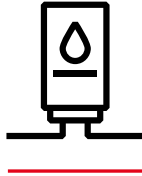

Resistive loads

Manual motor starters are not only for motors! They are also an efficient solution for AC-1 applications, where it is required to protect and switch resistive loads (for example resistive furnaces or heaters).

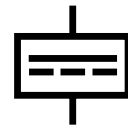

DC loads

Manual motor starters are not only for AC applications! MS132 and MS165 manual motor starters are also rated for direct current loads (e.g. for motors used in solar panel tracking systems).

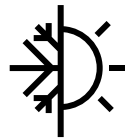

Extreme conditions

Regardless if high-altitudes, shock and vibration environments or hazardous areas, ABB's manual motor starters are designed and certified to withstand harsh conditions. Specific versions for rolling stock applications are part of our offer.



# Manual motor starters

## Overview



### Type

	MS116	MS132	MS165
Thermal and electromagnetic protection	Yes	Yes	Yes
Electromagnetic protection	-	-	-
Phase loss sensitivity	Yes	Yes	Yes
Switch position	ON/OFF	ON/OFF/TRIP	ON/OFF/TRIP
Magnetic trip indication	-	Yes	Yes
Lockable handle without accessories	-	Yes	Yes
Disconnecting feature	Yes	Yes	Yes
Width	45 mm	45 mm	55 mm
Rated operational current Ie	0.10 ... 32 A	0.10 ... 32 A	10 ... 80 A
Setting range	0.10 ... 32 A	0.10 ... 32 A	10 ... 80 A
Ambient air temperature	-25 ... +55 °C (1)	-25 ... +60 °C (1)	-25 ... +60 °C (1)

(1) Compensated

### Accessories

Auxiliary contact	HKF1, HK1		
Signaling contact for tripped alarm	SK1		
Signaling contact for short-circuit alarm	-	CK1	
Shunt trip	AA1		
Undervoltage release	UA1		

### Table for short-circuit ratings for 400/415 V AC

	Standard range MS116	Performance range MS132, MS165
--	-------------------------	-----------------------------------

### Selection parameters

Rated operational power	Setting range for thermal release	Type	Short-circuit breaking capacity		Type	Short-circuit breaking capacity	
			Icu	Ics		Icu	Ics
0.03 kW (1)	0.1 ... 0.16 A	MS116-0.16	100 kA	50 kA	MS132-0.16 (2)	100 kA	100 kA
0.06 kW	0.16 ... 0.25 A	MS116-0.25	100 kA	50 kA	MS132-0.25 (2)	100 kA	100 kA
0.09 kW	0.25 ... 0.4 A	MS116-0.4	100 kA	50 kA	MS132-0.4 (2)	100 kA	100 kA
0.18 kW	0.4 ... 0.63 A	MS116-0.63	100 kA	50 kA	MS132-0.63 (2)	100 kA	100 kA
0.25 kW	0.63 ... 1.0 A	MS116-1.0	100 kA	50 kA	MS132-1.0 (2)	100 kA	100 kA
0.55 kW	1.0...1.6 A	MS116-1.6	100 kA	50 kA	MS132-1.6 (2)	100 kA	100 kA
0.75 kW	1.6...2.5 A	MS116-2.5	75 kA	50 kA	MS132-2.5 (2)	100 kA	100 kA
1.5 kW	2.5...4.0 A	MS116-4.0	75 kA	50 kA	MS132-4.0 (2)	100 kA	100 kA
2.2 kW	4.0...6.3 A	MS116-6.3	50 kA	50 kA	MS132-6.3 (2)	100 kA	100 kA
4.0 kW	6.3...10 A	MS116-10	10 kA	50 kA	MS132-10 (2)	100 kA	100 kA
5.5 kW	8...12 A	MS116-12	50 kA	25 kA	MS132-12	100 kA	100 kA
7.5 kW	10...16 A	MS116-16	16 kA	16 kA	MS132-16 (2) / MS165-16	100 kA	100 kA
7.5 kW	14 ... 20 A				MS165-20	100 kA	100 kA
7.5 kW	16...20 A	MS116-20	16 kA	10 kA	MS132-20 (2)	100 kA	100 kA
11 kW	18 ... 25 A				MS165-25	100 kA	100 kA
11 kW	20...25 A	MS116-25	16 kA	10 kA	MS132-25 (2)	50 kA	50 kA
15 kW	25...32 A	MS116-32	16 kA	10 kA	MS132-32 (2)	50 kA	25 kA
15 kW	23 ... 32 A				MS165-32	100 kA	100 kA
22 kW	30 ... 42 A				MS165-42	50 kA	50 kA
22 kW	40 ... 54 A				MS165-54	50 kA	30 kA
25 kW	-						
30 kW	52 ... 65 A				MS165-65	50 kA	30 kA
37 kW	62 ... 73 A				MS165-73	30 kA	30 kA
45 kW	70 ... 80 A				MS165-80	30 kA	30 kA

(1) 690 V AC

(2) Available with Push-in Spring terminals.





**MO132**



**MO165**



**MS132-T**

-	-	Yes
Yes	Yes	-
-	-	Yes
ON/OFF/TRIP	ON/OFF/TRIP	ON/OFF/TRIP
-	-	Yes
Yes	Yes	Yes
Yes	Yes	Yes
45 mm	55 mm	45 mm
0.16 ... 32 A	16 ... 80 A	0.16 ... 25 A
-	-	0.10 ... 25 A
-25 ... +60 °C	-25 ... +60 °C	-25 ... +60 °C (1)

HKF1, HK1	HKF1, HK1
SK1	SK1
-	CK1
AA1	AA1
UA1	UA1

<b>Performance range</b> MO132, MO165	<b>Transformer protection</b> MS132-T
--	--

Type	Short-circuit breaking capacity		Type	Short-circuit breaking capacity	
	Icu	Ics		Icu / Ics	
MO132-0.16	100 kA	100 kA	MS132-0.16T (2)	100 kA	
MO132-0.25	100 kA	100 kA	MS132-0.25T (2)	100 kA	
MO132-0.4	100 kA	100 kA	MS132-0.4T (2)	100 kA	
MO132-0.63	100 kA	100 kA	MS132-0.63T (2)	100 kA	
MO132-1.0	100 kA	100 kA	MS132-1.0T (2)	100 kA	
MO132-1.6	100 kA	100 kA	MS132-1.6T (2)	100 kA	
MO132-2.5	100 kA	100 kA	MS132-2.5T (2)	100 kA	
MO132-4.0	100 kA	100 kA	MS132-4.0T (2)	100 kA	
MO132-6.3	100 kA	100 kA	MS132-6.3T (2)	100 kA	
MO132-10	100 kA	100 kA	MS132-10T (2)	100 kA	
MO132-12	100 kA	100 kA	MS132-12T	100 kA	
MO132-16 / MO165-16	100 kA	100 kA	MS132-16T (2)	100 kA	
MO165-20	100 kA	100 kA			
MO132-20	100 kA	100 kA	MS132-20T (2)	100 kA	
MO132-25 / MO165-25	50 kA / 100 kA	50 kA / 100 kA	MS132-25T (2)	50 kA	
MO132-32	50 kA	25 kA			
MO165-32	100 kA	100 kA			
MO165-42	50 kA	50 kA			
MO165-54	50 kA	30 kA			
MO165-65	50 kA	30 kA			
MO165-73	30 kA	30 kA			
MO165-80	30 kA	30 kA			

Transformer protection:  
The instantaneous short-circuit current setting is 20 times the rated operational current.

# MS116 manual motor starters

0.10 to 32 A – with thermal and electromagnetic protection



MS116-16

2CDC241004V00017



MS116-25

2CDC24101TV00017



MS116-0.16-HKF1-11

2CDC241019V00017



MS116-32-HKF1-11

2CDC241020V00017

MS116 is a compact and economic range for motor protection up to 15 kW (400 V) / 32 A in width of 45 mm. Further features are the built-in disconnect function, temperature compensation, trip-free mechanism and a rotary handle with a clear switch position indication. The manual motor starter is suitable for three- and single-phase applications. Auxiliary contacts, signaling contacts, undervoltage releases, shunt trips, power in-feed blocks and locking devices for protection against unauthorized changes are available as accessory. These are suitable throughout the MS116/MS132/MS165-range.

Rated operational power 400 V	Setting range	Short-circuit breaking capacity Ics at 400 V AC	Rated instantaneous short-circuit current setting Ii	Type	Order code	Weight (1 pce)
kW	A	kA	A			kg
0.03 (1)	0.10 ... 0.16	50	2.00	MS116-0.16	1SAM250000R1001	0.225
0.06	0.16 ... 0.25	50	3.10	MS116-0.25	1SAM250000R1002	0.225
0.09	0.25 ... 0.40	50	5.00	MS116-0.4	1SAM250000R1003	0.225
0.18	0.40 ... 0.63	50	7.90	MS116-0.63	1SAM250000R1004	0.225
0.25	0.63 ... 1.00	50	12.5	MS116-1.0	1SAM250000R1005	0.225
0.55	1.00 ... 1.60	50	20.0	MS116-1.6	1SAM250000R1006	0.265
0.75	1.60 ... 2.50	50	31.3	MS116-2.5	1SAM250000R1007	0.265
1.50	2.50 ... 4.00	50	50.0	MS116-4.0	1SAM250000R1008	0.265
2.20	4.00 ... 6.30	50	78.8	MS116-6.3	1SAM250000R1009	0.265
4.00	6.30 ... 10.0	50	150	MS116-10	1SAM250000R1010	0.265
5.50	8.00 ... 12.0	25	180	MS116-12	1SAM250000R1012	0.265
7.50	10.0 ... 16.0	16	240	MS116-16	1SAM250000R1011	0.265
7.50	16.0 ... 20.0	10	300	MS116-20	1SAM250000R1013	0.310
11.0	20.0 ... 25.0	10	375	MS116-25	1SAM250000R1014	0.310
15.0	25.0 ... 32.0	10	480	MS116-32	1SAM250000R1015	0.310

### Mounted Auxiliary Contacts 1 N.O. + 1 N.C.

0.03 (1)	0.10 ... 0.16	50	2.00	MS116-0.16-HKF1-11	1SAM250005R1001	0.240
0.06	0.16 ... 0.25	50	3.10	MS116-0.25-HKF1-11	1SAM250005R1002	0.240
0.09	0.25 ... 0.40	50	5.00	MS116-0.4-HKF1-11	1SAM250005R1003	0.240
0.18	0.40 ... 0.63	50	7.90	MS116-0.63-HKF1-11	1SAM250005R1004	0.240
0.25	0.63 ... 1.00	50	12.5	MS116-1.0-HKF1-11	1SAM250005R1005	0.240
0.55	1.00 ... 1.60	50	20.0	MS116-1.6-HKF1-11	1SAM250005R1006	0.280
0.75	1.60 ... 2.50	50	31.3	MS116-2.5-HKF1-11	1SAM250005R1007	0.280
1.50	2.50 ... 4.00	50	50.0	MS116-4.0-HKF1-11	1SAM250005R1008	0.280
2.20	4.00 ... 6.30	50	78.8	MS116-6.3-HKF1-11	1SAM250005R1009	0.280
4.00	6.30 ... 10.0	50	150	MS116-10.0-HKF1-11	1SAM250005R1010	0.280
5.50	8.00 ... 12.0	25	180	MS116-12.0-HKF1-11	1SAM250005R1012	0.280
7.50	10.0 ... 16.0	16	240	MS116-16.0-HKF1-11	1SAM250005R1011	0.280
7.50	16.0 ... 20.0	10	300	MS116-20-HKF1-11	1SAM250005R1013	0.326
11.0	20.0 ... 25.0	10	375	MS116-25-HKF1-11	1SAM250005R1014	0.326
15.0	25.0 ... 32.0	10	480	MS116-32-HKF1-11	1SAM250005R1015	0.326

Note: Manual motor starters should always be selected so that the actual motor current is within the setting range.  
(1) 690 V

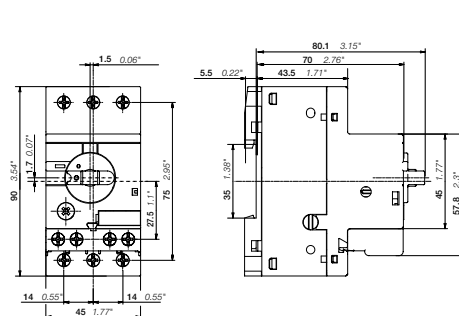

MS116 ≤ 16 A & MS116-HKF1-11 ≤ 16 A

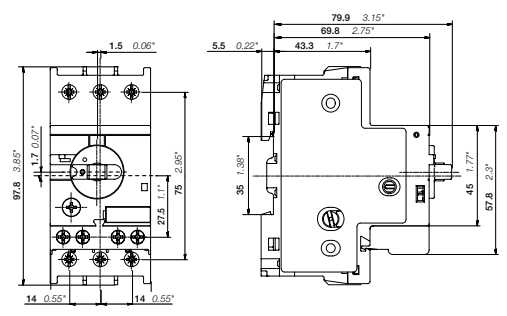

MS116 ≥ 20 A & MS116-HKF1-11 ≥ 20 A

Main dimensions mm, inches

2CDC131062C0201

# MS132 manual motor starters

0.10 to 32 A – with thermal and electromagnetic protection



MS132-10

ZCDC41002V0013



MS132-32

ZCDC41006V0017



MS132-0.16-HKF1-11

ZCDC41021V0017



MS132-32-HKF1-11

MS132 is a compact and powerful range for motor protection up to 15 kW (400 V) / 32 A in width of 45 mm. This type has also a clear and reliable indication of fault in a separate window in the event of short-circuit tripping. Further features are the built-in disconnect function, temperature compensation, trip-free mechanism and a rotary handle with a clear switch position indication. The manual motor starter is suitable for three- and single-phase applications. The handle is lockable to protect against unauthorized changes. Auxiliary contacts, signaling contacts, undervoltage releases, shunt trips, power in-feed blocks are available as accessory. These are suitable throughout the MS116/MS132/MS165-range.

Rated operational power 400 V	Setting range	Short-circuit breaking capacity Ics at 400 V AC	Rated instantaneous short-circuit current setting li	Type	Order code	Weight (1 pce)
kW	A	kA	A			kg
0.03 (1)	0.10 ... 0.16	100	2.00	MS132-0.16	1SAM350000R1001	0.215
0.06	0.16 ... 0.25	100	3.10	MS132-0.25	1SAM350000R1002	0.215
0.09	0.25 ... 0.40	100	5.00	MS132-0.4	1SAM350000R1003	0.215
0.18	0.40 ... 0.63	100	7.90	MS132-0.63	1SAM350000R1004	0.215
0.25	0.63 ... 1.00	100	12.5	MS132-1.0	1SAM350000R1005	0.215
0.55	1.00 ... 1.60	100	20.0	MS132-1.6	1SAM350000R1006	0.265
0.75	1.60 ... 2.50	100	31.3	MS132-2.5	1SAM350000R1007	0.265
1.50	2.50 ... 4.00	100	50.0	MS132-4.0	1SAM350000R1008	0.265
2.20	4.00 ... 6.30	100	78.8	MS132-6.3	1SAM350000R1009	0.265
4.00	6.30 ... 10.0	100	150	MS132-10	1SAM350000R1010	0.265
5.50	8.00 ... 12.0	100	180	MS132-12	1SAM350000R1012	0.310
7.50	10.0 ... 16.0	100	240	MS132-16	1SAM350000R1011	0.310
7.50	16.0 ... 20.0	100	300	MS132-20	1SAM350000R1013	0.310
11.0	20.0 ... 25.0	50	375	MS132-25	1SAM350000R1014	0.310
15.0	25.0 ... 32.0	25	480	MS132-32	1SAM350000R1015	0.310

### Mounted Auxiliary Contacts 1 N.O. + 1 N.C.

0.03 (1)	0.10 ... 0.16	100	2.00	MS132-0.16-HKF1-11	1SAM350005R1001	0.231
0.06	0.16 ... 0.25	100	3.10	MS132-0.25-HKF1-11	1SAM350005R1002	0.231
0.09	0.25 ... 0.40	100	5.0	MS132-0.4-HKF1-11	1SAM350005R1003	0.231
0.18	0.40 ... 0.63	100	7.90	MS132-0.63-HKF1-11	1SAM350005R1004	0.231
0.25	0.63 ... 1.00	100	12.5	MS132-1.0-HKF1-11	1SAM350005R1005	0.231
0.55	1.00 ... 1.60	100	20.0	MS132-1.6-HKF1-11	1SAM350005R1006	0.281
0.75	1.60 ... 2.50	100	31.3	MS132-2.5-HKF1-11	1SAM350005R1007	0.281
1.50	2.50 ... 4.00	100	50.0	MS132-4.0-HKF1-11	1SAM350005R1008	0.281
2.20	4.00 ... 6.30	100	78.8	MS132-6.3-HKF1-11	1SAM350005R1009	0.281
4.00	6.30 ... 10.0	100	150	MS132-10.0-HKF1-11	1SAM350005R1010	0.281
5.50	8.00 ... 12.0	100	180	MS132-12.0-HKF1-11	1SAM350005R1012	0.326
7.50	10.0 ... 16.0	100	240	MS132-16.0-HKF1-11	1SAM350005R1011	0.326
7.50	16.0 ... 20.0	100	300	MS132-20-HKF1-11	1SAM350005R1013	0.326
11.0	20.0 ... 25.0	50	375	MS132-25-HKF1-11	1SAM350005R1014	0.326
15.0	25.0 ... 32.0	25	480	MS132-32-HKF1-11	1SAM350005R1015	0.326

### Mounted Auxiliary Contacts 2 N.O. + 0 N.C.

7.50	10 ... 16	100	240	MS132-16-HKF1-20	1SAM350006R1011	0.326
------	-----------	-----	-----	------------------	-----------------	-------

Note: Manual motor starters should always be selected so that the actual motor current is within the setting range.  
(1) 690 V

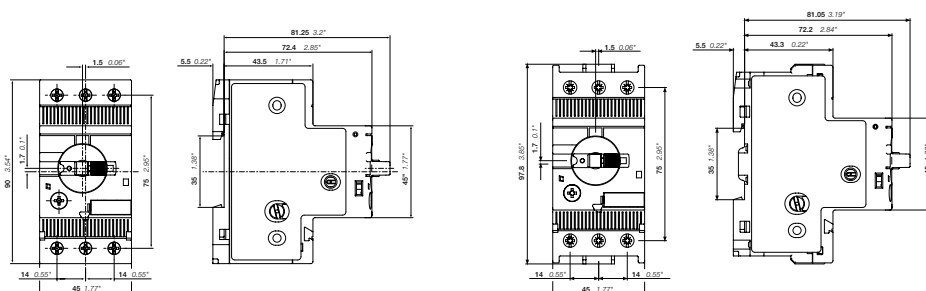

MS132 ≤ 10 A

MS132 ≥ 12 A

Main dimensions mm, inches

# MS132-K manual motor starters with Push-in Spring terminals

0.10 to 32 A – with thermal and electromagnetic protection



MS132-32K

2CDC241025V0017

The MS132-K series is a compact and powerful range for motor protection up to 15 kW (400 V) / 32 A with a width of only 45 mm. The innovative Push-in Spring terminals enable tool-free wiring and eliminate the need for routine re-tightening.

The MS132-K also has a clear and reliable indication of fault in a separate window in the event of short-circuit tripping. Further features are the built-in disconnect function, temperature compensation, trip-free mechanism and a rotary handle with a clear switch position indication.

The manual motor starter is suitable for three- and single-phase applications. The handle is lockable to protect against unauthorized changes. Auxiliary contacts, signaling contacts, undervoltage releases, shunt trips, power in-feed blocks are available as accessory. These are suitable throughout the MS116/MS132/MS165-range.

Rated operational power 400 V AC-3 kW	Setting range A	Short-circuit breaking capacity Ics at 400 V AC kA	Rated instantaneous short-circuit current setting Ii A	Type	Order code	Weight (1 pce) kg
0.03(1)	0.10 ... 0.16	100	2.00	MS132-0.16K	1SAM350010R1001	0.256
0.06	0.16 ... 0.25	100	3.10	MS132-0.25K	1SAM350010R1002	0.256
0.09	0.25 ... 0.40	100	5.00	MS132-0.4K	1SAM350010R1003	0.256
0.18	0.40 ... 0.63	100	7.90	MS132-0.63K	1SAM350010R1004	0.256
0.25	0.63 ... 1.00	100	12.5	MS132-1.0K	1SAM350010R1005	0.256
0.55	1.00 ... 1.60	100	20.0	MS132-1.6K	1SAM350010R1006	0.298
0.75	1.60 ... 2.50	100	31.3	MS132-2.5K	1SAM350010R1007	0.280
1.50	2.50 ... 4.00	100	50.0	MS132-4.0K	1SAM350010R1008	0.286
2.20	4.00 ... 6.30	100	78.8	MS132-6.3K	1SAM350010R1009	0.289
4.00	6.30 ... 10.0	100	150	MS132-10K	1SAM350010R1010	0.296
7.50	10.0 ... 16.0	100	240	MS132-16K	1SAM350010R1011	0.316
7.50	16.0 ... 20.0	100	300	MS132-20K	1SAM350010R1013	0.317
11.0	20.0 ... 25.0	50	375	MS132-25K	1SAM350010R1014	0.316
15.0	25.0 ... 32.0	25	480	MS132-32K	1SAM350010R1015	0.316

Note: Manual motor starters should always be selected so that the actual motor current is within the setting range.  
(1) 690 V

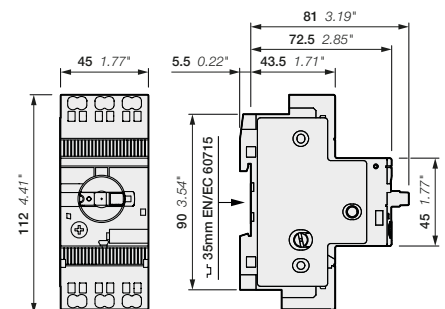
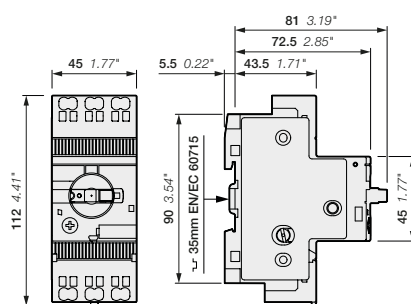

Main dimensions mm, inches

2CDC131062C0201



# MS165 manual motor starters

10 to 80 A – with thermal and electromagnetic protection



MS165-65

2CDC241007V0017

MS165 is a compact and powerful range for motor protection up to 45 kW (400 V) / 80 A in width of 55 mm. This type has also a clear and reliable indication of fault in a separate window in the event of short-circuit tripping. Further features are the built-in disconnect function, temperature compensation, trip-free mechanism and a rotary handle with a clear switch position indication. The manual motor starter is suitable for three- and single-phase applications. The handle is lockable to protect against unauthorized changes. Auxiliary contacts, signaling contacts, undervoltage releases, shunt trips, power in-feed blocks are available as accessory. These are suitable throughout the MS116/MS132/MS165-range.

Rated operational power 400 V	Setting range	Short-circuit breaking capacity Ics at 400 V AC	Rated instantaneous short-circuit current setting Ii	Type	Order code	Weight (1 pce)
AC-3 kW	A	kA	A			kg
7.5	10 ... 16	100	240	MS165-16	1SAM451000R1011	0.950
7.5	14 ... 20	100	300	MS165-20	1SAM451000R1012	0.950
11	18 ... 25	100	375	MS165-25	1SAM451000R1013	0.960
15	23 ... 32	100	480	MS165-32	1SAM451000R1014	0.970
22	30 ... 42	50	630	MS165-42	1SAM451000R1015	0.970
22	40 ... 54	30	810	MS165-54	1SAM451000R1016	0.970
30	52 ... 65	30	975	MS165-65	1SAM451000R1017	0.980
37	62 ... 73	30	1022	MS165-73	1SAM451000R1018	1.000
45	70 ... 80	30	1120	MS165-80	1SAM451000R1019	1.000

Note: Manual motor starters should always be selected so that the actual motor current is within the setting range.

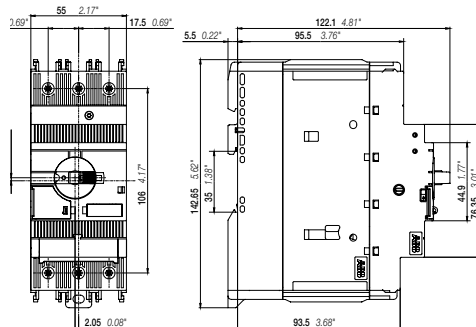

MS165  
Main dimensions mm, inches

2CDC131062C0201

# MO132 manual motor starters magnetic only

0.16 to 32 A – with electromagnetic protection



2CDC24101BV0017

MO132-6.3



2CDC241015V0017

MO132-32

The MO132 manual motor starter magnetic only is a compact and powerful range for motor protection up to 15 kW (400 V AC) in width of 45 mm. The devices are used to manually switch on and off loads/motors and to protect them reliably and without the need for a fuse from short-circuits.

The manual motor starter offers a rated service short-circuit breaking capacity up to 100 kA at 400 V AC. A combination together with overload relays or motor controllers allows the protection of motors. Further features are the built-in disconnect function, trip-free mechanism and a rotary handle with a clear switch position indication. The manual motor starters magnetic only are suitable for three- and single-phase applications. The handle is lockable to protect against unauthorized changes. Auxiliary contacts, signaling contacts, undervoltage releases, shunt trips, 3-phase busbars and power in-feed blocks are available as accessory.

Rated operational power 400 V AC-3	Rated operational current	Short-circuit breaking capacity Ics at 400 V AC	Rated instantaneous short-circuit current setting Ii	Type	Order code	Weight (1 pce)
kW	A	kA	A			kg
0.03 (1)	0.16	100	2.00	MO132-0.16	1SAM360000R1001	0.215
0.06	0.25	100	3.10	MO132-0.25	1SAM360000R1002	0.215
0.09	0.40	100	5.00	MO132-0.4	1SAM360000R1003	0.215
0.12	0.63	100	7.90	MO132-0.63	1SAM360000R1004	0.215
0.25	1.0	100	12.5	MO132-1.0	1SAM360000R1005	0.215
0.55	1.6	100	20.0	MO132-1.6	1SAM360000R1006	0.265
0.75	2.5	100	31.3	MO132-2.5	1SAM360000R1007	0.265
1.5	4.0	100	50.0	MO132-4.0	1SAM360000R1008	0.265
2.2	6.3	100	78.8	MO132-6.3	1SAM360000R1009	0.265
4.0	10	100	125	MO132-10	1SAM360000R1010	0.265
5.5	12	100	150	MO132-12	1SAM360000R1012	0.310
7.5	16	100	200	MO132-16	1SAM360000R1011	0.310
7.5	20	100	250	MO132-20	1SAM360000R1013	0.310
11	25	50	313	MO132-25	1SAM360000R1014	0.310
15	32	25	400	MO132-32	1SAM360000R1015	0.310

Note: For overload protection of motors, an appropriate thermal or electronic overload relay must be used.  
(1) 690 V

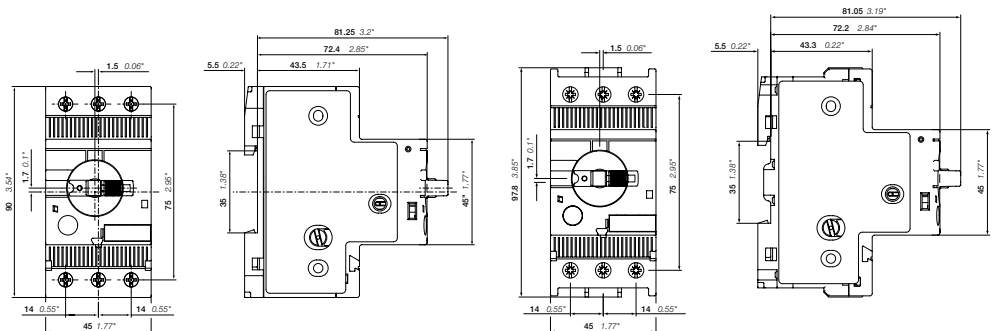

MO132 ≤ 10 A

MO132 ≥ 12 A

Main dimensions mm, inches

2CDC131062C0201

# MO165 manual motor starters magnetic only

16 to 80 A – with electromagnetic protection

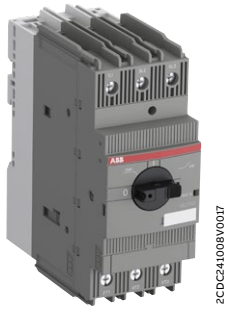

MO165-65

2CDC241008V0017

The MO165 manual motor starter magnetic only is a compact and powerful range for motor protection up to 45 kW (400 V AC) in width of 55 mm. The devices are used to manually switch on and off loads/motors and to protect them reliably and without the need for a fuse from short-circuits. The manual motor starter offers a rated service short-circuit breaking capacity up to 100 kA at 400 V AC. A combination together with overload relays or motor controllers allows the protection of motors. Further features are the built-in disconnect function, trip-free mechanism and a rotary handle with a clear switch position indication.

The manual motor starters magnetic only are suitable for three- and single-phase applications. The handle is lockable to protect against unauthorized changes. Auxiliary contacts, signaling contacts, undervoltage releases, shunt trips, 3-phase bus bars and power in-feed blocks are available as accessory.

Rated operational power 400 V	Rated operational current	Short-circuit breaking capacity Ics at 400 V AC	Rated instantaneous short-circuit current setting Ii	Type	Order code	Weight (1 pce)
AC-3 kW	A	kA	A			kg
7.5	16	100	240	MO165-16	1SAM461000R1011	0.950
7.5	20	100	300	MO165-20	1SAM461000R1012	0.950
11	25	100	375	MO165-25	1SAM461000R1013	0.960
15	32	100	480	MO165-32	1SAM461000R1014	0.970
22	42	50	630	MO165-42	1SAM461000R1015	0.970
22	54	30	810	MO165-54	1SAM461000R1016	0.970
30	65	30	975	MO165-65	1SAM461000R1017	0.980
37	73	30	1022	MO165-73	1SAM461000R1018	1.000
45	80	30	1120	MO165-80	1SAM461000R1019	1.000

Note: For overload protection of motors, an appropriate thermal or electronic overload relay must be used.

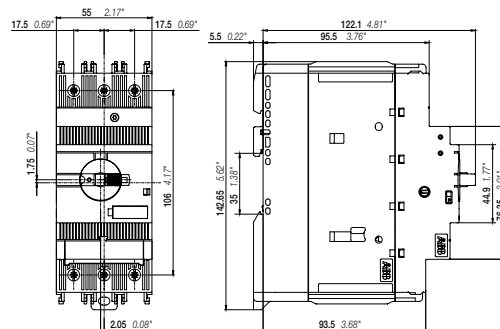

MO165

Main dimensions mm, inches

2CDC131062C0201

# MS116, MS132, MS165, MO132, MO165

## Technical data

### Main circuit – Utilization characteristics according to IEC/EN

Type	MS116	MS132	MS165	MO132	MO165
Standards	IEC/EN 60947-2, IEC/EN 60947-4-1, IEC/EN 60947-1				
Rated operational voltage Ue	690 V AC	690 V AC / 250 V DC	690 V AC / 250 V DC	690 V AC	690 V AC / 250 V DC
Rated frequency	50/60 Hz	DC, 50/60 Hz	DC, 50/60 Hz	50/60 Hz	DC, 50/60 Hz
Operational frequency	50/60 Hz	0 ... 400 Hz	0 ... 400 Hz	0 ... 400 Hz	0 ... 400 Hz
Trip class	10A	10	10	-	-
Number of poles	3				
Duty time	100%				
Mechanical durability	100000 cycles	100000 cycles	50000 cycles	100000 cycles	50000 cycles
Electrical durability	up to 10 A	up to 100000 cycles	up to 25000 cycles	up to 100000 cycles	up to 50000 cycles
	up to 16 A	100000 cycles	50000 cycles	50000 cycles	25000 cycles
	20 ... 65 A	50000 cycles	50000 cycles	50000 cycles	25000 cycles
	65 ... 80 A	-	-	20000 cycles	-
Rated impulse withstand voltage Uimp	6 kV	6 kV	8 kV	6 kV	8 kV
Rated insulation voltage Ui	690 V	690 V	1000 V	690 V	1000 V
Rated operational current Ie	See ordering details				
Rated operational current DC-5 Ie 3 conducting paths in series up to 250 V	-	See "Rated operational current Ie"	See "Rated operational current Ie"	-	See "Rated operational current Ie"
Rated instantaneous short-circuit current setting Ii	See ordering details				
Rated service short-circuit breaking capacity Ics	See table "Short-circuit breaking capacity and back-up fuses"				
Rated ultimate short-circuit breaking capacity Icu	See table "Short-circuit breaking capacity and back-up fuses"				
Rated service short-circuit breaking capacity DC Ics 3 conducting paths in series up to 250 V	-	10 kA	100 kA	-	100 kA

### Short-circuit breaking capacity and back-up fuses

Ics Rated service short-circuit breaking capacity

Icu Rated ultimate short-circuit breaking capacity

Icc Prospective short-circuit current at installation location

Note: Maximum rated current of the back-up fuses if Icc > Ics

Type	230 V AC			400 V AC			440 V AC			500 V AC			690 V AC		
	Ics kA	Icu kA	gG, aM A	Ics kA	Icu kA	gG, aM A	Ics kA	Icu kA	gG, aM A	Ics kA	Icu kA	gG, aM A	Ics kA	Icu kA	gG, aM A
MS116-0.16	50	100	-(1)	50	100	-(1)	30	100	-(1)	30	100	-(1)	30	100	-(1)
MS116-0.25	50	100	-(1)	50	100	-(1)	30	100	-(1)	30	100	-(1)	30	100	-(1)
MS116-0.4	50	100	-(1)	50	100	-(1)	30	100	-(1)	30	100	-(1)	30	100	-(1)
MS116-0.63	50	100	-(1)	50	100	-(1)	30	100	-(1)	30	100	-(1)	30	100	-(1)
MS116-1.0	50	100	-(1)	50	100	-(1)	30	100	-(1)	30	100	-(1)	30	100	-(1)
MS116-1.6	50	100	-(1)	50	100	-(1)	30	100	-(1)	30	100	-(1)	30	100	-(1)
MS116-2.5	50	75	-(1)	50	75	-(1)	10	30	25 (2)	10	20	25 (2)	5	10	25 (2)
MS116-4.0	50	75	-(1)	50	75	-(1)	6	18	25 (2)	6	15	25 (2)	2	3	25 (2)
MS116-6.3	50	50	-(1)	50	50	-(1)	6	18	63 (2)	6	10	63 (2)	2	3	40 (2)
MS116-10	50	50	-(1)	50	50	-(1)	6	18	63 (2)	6	10	63 (2)	2	3	50 (2)
MS116-12	25	50	80 (2)	25	50	80 (2)	6	15	63 (2)	6	10	63 (2)	2	3	50 (2)
MS116-16	16	16	80 (2)	16	16	80 (2)	6	15	63 (2)	4	10	63 (2)	2	3	63 (2)
MS116-20	10	16	125 (2)	10	16	125 (2)	3	15	125 (2)	3	10	125 (2)	2	3	80 (2)
MS116-25	10	16	125 (2)	10	16	125 (2)	3	15	125 (2)	3	10	125 (2)	2	3	100 (2)
MS116-32	10	16	125 (2)	10	16	125 (2)	3	15	125 (2)	3	10	125 (2)	2	3	100 (2)

(1) No back-up fuse required, because short-circuit proof up to 50 kA

(2) Rated back-up fuse for short-circuit up to 50 kA



# MS116, MS132, MS165, MO132, MO165

## Technical data

### Short-circuit breaking capacity and back-up fuses

Type	230 V AC			400 V AC			440 V AC			500 V AC			690 V AC		
	Ics kA	Icu kA	gG, aM A	Ics kA	Icu kA	gG, aM A	Ics kA	Icu kA	gG, aM A	Ics kA	Icu kA	gG, aM A	Ics kA	Icu kA	gG, aM A
MS132-0.16	100	100	-(1)	100	100	-(1)	100	100	-(1)	100	100	-(1)	100	100	-(1)
MS132-0.25	100	100	-(1)	100	100	-(1)	100	100	-(1)	100	100	-(1)	100	100	-(1)
MS132-0.4	100	100	-(1)	100	100	-(1)	100	100	-(1)	100	100	-(1)	100	100	-(1)
MS132-0.63	100	100	-(1)	100	100	-(1)	100	100	-(1)	100	100	-(1)	100	100	-(1)
MS132-1.0	100	100	-(1)	100	100	-(1)	100	100	-(1)	100	100	-(1)	100	100	-(1)
MS132-1.6	100	100	-(1)	100	100	-(1)	100	100	-(1)	100	100	-(1)	100	100	-(1)
MS132-2.5	100	100	-(1)	100	100	-(1)	100	100	-(1)	100	100	-(1)	100	100	-(1)
MS132-4.0	100	100	-(1)	100	100	-(1)	30	30	35 (2)	20	20	35 (2)	3	3	32 (2)
MS132-6.3	100	100	-(1)	100	100	-(1)	30	30	63 (2)	20	20	63 (2)	3	3	50 (2)
MS132-10	100	100	-(1)	100	100	-(1)	20	20	100 (2)	20	20	100 (2)	3	3	50 (2)
MS132-12	100	100	-(1)	100	100	-(1)	20	20	100 (2)	20	20	100 (2)	3	3	63 (2)
MS132-16	100	100	-(1)	100	100	-(1)	20	20	125 (2)	20	20	125 (2)	3	3	63 (2)
MS132-20	100	100	-(1)	100	100	-(1)	20	20	125 (2)	20	20	125 (2)	3	3	80 (2)
MS132-25	50	50	125 (2)	50	50	125 (2)	20	20	125 (2)	10	10	125 (2)	3	3	100 (2)
MS132-32	25	50	125 (2)	25	50	125 (2)	20	20	125 (2)	10	10	125 (2)	3	3	100 (2)

(1) No back-up fuse required, because short-circuit proof up to 100 kA  
 (2) Rated back-up fuse for short-circuit up to 100 kA

Type	230 V AC			400 V AC			440 V AC			500 V AC			690 V AC			250 V DC (3)		
	Ics kA	Icu kA	gG A	Ics kA	Icu kA	gG A	Ics kA	Icu kA	gG A	Ics kA	Icu kA	gG A	Ics kA	Icu kA	gG A	Ics kA	Icu kA	gG A
MS165-16	100	100	-(1)	100	100	-(1)	75	75	125 (2)	40	40	125 (2)	10	10	63 (2)	100	100	-(1)
MS165-20	100	100	-(1)	100	100	-(1)	75	75	125 (2)	40	40	125 (2)	10	10	63 (2)	100	100	-(1)
MS165-25	100	100	-(1)	100	100	-(1)	50	50	125 (2)	30	30	125 (2)	10	10	80 (2)	100	100	-(1)
MS165-32	100	100	-(1)	100	100	-(1)	50	50	125 (2)	30	30	125 (2)	10	10	100 (2)	100	100	-(1)
MS165-42	50	50	125 (2)	50	50	125 (2)	50	50	125 (2)	30	30	125 (2)	10	10	100 (2)	100	100	-(1)
MS165-54	30	50	125 (2)	30	50	125 (2)	30	45	125 (2)	20	20	125 (2)	6	8	100 (2)	100	100	-(1)
MS165-65	30	50	125 (2)	30	50	125 (2)	30	45	125 (2)	20	20	125 (2)	6	8	100 (2)	100	100	-(1)
MS165-73	30	30		30	30		6	8		6	8		6	8				
MS165-80	30	30		30	30		6	8		6	8		6	8				

(1) No back-up fuse required, short-circuit proof up to 100 kA  
 (2) Rated back-up fuse for short-circuit up to 100 kA  
 (3) 3 poles in series

Type	230 V AC			400 V AC			440 V AC			500 V AC			690 V AC		
	Ics kA	Icu kA	gG, aM A	Ics kA	Icu kA	gG, aM A	Ics kA	Icu kA	gG, aM A	Ics kA	Icu kA	gG, aM A	Ics kA	Icu kA	gG, aM A
MO132-0.16	100	100	-(1)	100	100	-(1)	100	100	-(1)	100	100	-(1)	100	100	-(1)
MO132-0.25	100	100	-(1)	100	100	-(1)	100	100	-(1)	100	100	-(1)	100	100	-(1)
MO132-0.4	100	100	-(1)	100	100	-(1)	100	100	-(1)	100	100	-(1)	100	100	-(1)
MO132-0.63	100	100	-(1)	100	100	-(1)	100	100	-(1)	100	100	-(1)	100	100	-(1)
MO132-1.0	100	100	-(1)	100	100	-(1)	100	100	-(1)	100	100	-(1)	100	100	-(1)
MO132-1.6	100	100	-(1)	100	100	-(1)	100	100	-(1)	100	100	-(1)	100	100	-(1)
MO132-2.5	100	100	-(1)	100	100	-(1)	100	100	-(1)	100	100	-(1)	100	100	-(1)
MO132-4.0	100	100	-(1)	100	100	-(1)	30	30	35 (2)	20	20	35 (2)	3	3	32 (2)
MO132-6.3	100	100	-(1)	100	100	-(1)	30	30	63 (2)	20	20	63 (2)	3	3	50 (2)
MO132-10	100	100	-(1)	100	100	-(1)	20	20	100 (2)	20	20	100 (2)	3	3	50 (2)
MO132-12	100	100	-(1)	100	100	-(1)	20	20	100 (2)	20	20	100 (2)	3	3	63 (2)
MO132-16	100	100	-(1)	100	100	-(1)	20	20	125 (2)	20	20	125 (2)	3	3	63 (2)
MO132-20	100	100	-(1)	100	100	-(1)	20	20	125 (2)	20	20	125 (2)	3	3	80 (2)
MO132-25	50	50	125 (2)	50	50	125 (2)	10	10	125 (2)	10	10	125 (2)	3	3	100 (2)
MO132-32	25	50	125 (2)	25	50	125 (2)	10	10	125 (2)	10	10	125 (2)	3	3	100 (2)

(1) No back-up fuse required, because short-circuit proof up to 100 kA  
 (2) Rated back-up fuse for short-circuit up to 100 kA

# MS116, MS132, MS165, MO132, MO165

## Technical data

### Short-circuit breaking capacity and back-up fuses

Type	230 V AC			400 V AC			440 V AC			500 V AC			690 V AC			250 V DC (3)		
	Ics kA	Icu kA	gG A	Ics kA	Icu kA	gG A	Ics kA	Icu kA	gG A	Ics kA	Icu kA	gG A	Ics kA	Icu kA	gG A	Ics kA	Icu kA	gG A
MO165-16	100	100	-(1)	100	100	-(1)	75	75	125 (2)	40	40	125 (2)	10	10	63 (2)	100	100	-(1)
MO165-20	100	100	-(1)	100	100	-(1)	75	75	125 (2)	40	40	125 (2)	10	10	63 (2)	100	100	-(1)
MO165-25	100	100	-(1)	100	100	-(1)	50	50	125 (2)	30	30	125 (2)	10	10	80 (2)	100	100	-(1)
MO165-32	100	100	-(1)	100	100	-(1)	50	50	125 (2)	30	30	125 (2)	10	10	100 (2)	100	100	-(1)
MO165-42	50	50	125 (2)	50	50	125 (2)	50	50	125 (2)	30	30	125 (2)	10	10	100 (2)	100	100	-(1)
MO165-54	30	50	125 (2)	30	50	125 (2)	30	45	125 (2)	20	20	125 (2)	6	8	100 (2)	100	100	-(1)
MO165-65	30	50	125 (2)	30	50	125 (2)	30	45	125 (2)	20	20	125 (2)	6	8	100 (2)	100	100	-(1)
MO165-73	30	30		30	30		6	8		6	8		6	8				
MO165-80	30	30		30	30		6	8		6	8		6	8				

(1) No back-up fuse required, short-circuit proof up to 100 kA

(2) Rated back-up fuse for short-circuit up to 100 kA

(3) 3 poles in series

### Main circuit – Utilization characteristics according to UL/CSA

Type	MS116	MS132	MS165	MO132	MO165
Standards	UL 60947-1, UL 60947-4-1 (UL 508), CSA C22.2 No.60947-4-1 (CSA C22.2 No.14)				
Rated operational voltage Ue acc. to UL/CSA	600 V AC	600 V AC	600 V AC	600 V AC	600 V AC
Trip class	10A	10		-	
Motor ratings (1)	See table "Motor ratings, three phase"				
Horsepower	See table "Motor ratings, three phase"				
Full Load Amps (FLA)	See table "Motor ratings, three phase"				
Locked Rotor Amps (LRA)	See table "Motor ratings, three phase"				

(1) See product data sheets for UL/CSA single phase motor and general use ratings.

### UL/CSA ratings overview

Type	MS116	MS132	MS165	MO132	MO165
Manual Motor Controller	x	x	x	x	x
Manual Motor Controller, Suitable as Motor Disconnect	x	x	x	x	x
Manual Motor Controller, Suitable for use in Group Installations	x	x	x	x	x
Manual Motor Controller, Suitable for Tap Conductor Protection in Group Installations	-	x	x	x	x
Manual self-protected Combination Motor Controller (Type E)	-	x	x (up to 65 A)	-	-
Combination Motor Controller (Type F)	-	with AF contactor	with AF contactor (up to 65 A)	with AF contactor and EOL	with AF contactor and EOL (up to 65 A)

# MS116, MS132, MS165, MO132, MO165

## Technical data

### UL/CSA Motor ratings, three phase – MS116

Type	200 V AC			208 V AC			220 ... 240 V AC			440 ... 480 V AC			550 ... 600 V AC		
	hp	FLA	LRA	hp	FLA	LRA	hp	FLA	LRA	hp	FLA	LRA	hp	FLA	LRA
MS116-0.16	-	0.16	0.96	-	0.16	0.96	-	0.16	0.96	-	0.16	0.96	-	0.16	0.96
MS116-0.25	-	0.25	1.5	-	0.25	1.5	-	0.25	1.5	-	0.25	1.5	-	0.25	1.5
MS116-0.40	-	0.4	2.4	-	0.4	2.4	-	0.4	2.4	-	0.4	2.4	-	0.4	2.4
MS116-0.63	-	0.63	3.78	-	0.63	3.78	-	0.63	3.78	-	0.63	3.78	-	0.63	3.78
MS116-1.0	-	1	6	-	1	6	-	1	6	-	1	6	1/2	0.9	8
MS116-1.6	-	1.6	9.6	-	1.6	9.6	-	1.6	9.6	3/4	1.6	9.6	3/4	1.6	9.6
MS116-2.5	1/2	2.5	15	1/2	2.5	15	1/2	2.5	15	1	2.5	15	1 1/2	2.5	15
MS116-4.0	3/4	4	24	3/4	4	24	1	4	24	2	4	24	3	3.9	25.6
MS116-6.3	1	6.3	37.8	1	6.3	37.8	1 1/2	6.3	37.8	3	4.8	32	5	6.1	36.8
MS116-10	2	7.8	57.5	2	7.5	55	3	9.6	64	5	7.6	46	7 1/2	9	50.8
MS116-12	3	11	73.6	3	10.6	71	3	9.6	64	7 1/2	11	63.5	10	11	64.8
MS116-16	3	11	73.6	3	10.6	71	5	15.2	92	10	14	81	10	11	64.8
MS116-20	5	17.5	105.8	5	16.7	102	5	15.2	92	10	14	81	15	17	93
MS116-25	5	17.5	105.8	7 1/2	24.2	140	7 1/2	22	127	15	21	116	20	22	116
MS116-32	7 1/2	25.3	146	10	30.8	179	10	28	162	20	27	145	25	27	146

### UL/CSA Motor ratings, three phase – MS132

Type	200 V AC			208 V AC			220 ... 240 V AC			440 ... 480 V AC			550 ... 600 V AC		
	hp	FLA	LRA	hp	FLA	LRA	hp	FLA	LRA	hp	FLA	LRA	hp	FLA	LRA
MS132-0.16	-	0.16	0.96	-	0.16	0.96	-	0.16	0.96	-	0.16	0.96	-	0.16	0.96
MS132-0.25	-	0.25	1.5	-	0.25	1.5	-	0.25	1.5	-	0.25	1.5	-	0.25	1.5
MS132-0.40	-	0.4	2.4	-	0.4	2.4	-	0.4	2.4	-	0.4	2.4	-	0.4	2.4
MS132-0.63	-	0.63	3.78	-	0.63	3.78	-	0.63	3.78	-	0.63	3.78	-	0.63	3.78
MS132-1.0	-	1	6	-	1	6	-	1	6	-	1	6	1/2	1	6
MS132-1.6	-	1.6	9.6	-	1.6	9.6	-	1.6	9.6	3/4	1.6	9.6	3/4	1.6	9.6
MS132-2.5	1/2	2.5	15	1/2	2.5	15	1/2	2.5	15	1	2.5	15	1-1/2	2.5	15
MS132-4.0	3/4	4	24	3/4	4	24	1	4	24	2	4	24	3	3.9	25.6
MS132-6.3	1	6.3	37.8	1	6.3	37.8	1 1/2	6.3	37.8	3	4.8	32	5	6.1	36.8
MS132-10	2	7.8	57.5	2	7.5	55	3	9.6	64	5	7.6	46	7 1/2	9	50.8
MS132-12	3	11	73.6	3	10.6	71	3	9.6	64	7 1/2	11	63.5	10	11	64.8
MS132-16	3	11	73.6	3	10.6	71	5	15.2	92	10	14	81	10	11	64.8
MS132-20	5	17.5	105.8	5	16.7	102	5	15.2	92	10	14	81	15	17	93
MS132-25	5	17.5	105.8	7 1/2	24.2	140	7 1/2	22	127	15	21	116	20	22	116
MS132-32	7 1/2	25.3	146	10	30.8	179	10	28	162	20	27	145	25	27	146

### UL/CSA Motor ratings, three phase – MS165

Type	200 V AC			208 V AC			220 ... 240 V AC			440 ... 480 V AC			550 ... 600 V AC		
	hp	FLA	LRA	hp	FLA	LRA	hp	FLA	LRA	hp	FLA	LRA	hp	FLA	LRA
MS165-16	3	11	73.6	3	10.6	71	5	15.2	92	10	14	81	10	11	64.8
MS165-20	5	17.5	105.8	5	16.7	102	5	15.2	92	10	14	81	15	17	93
MS165-25	5	17.5	105.8	7 1/2	24.2	140	7 1/2	22	127	15	21	116	20	22	116
MS165-32	7 1/2	25.3	146	10	30.8	179	10	28	162	20	27	145	30	32	174
MS165-42	10	32.2	186.3	10	30.8	179	15	42	232	30	40	218	40	41	232
MS165-54	15	48.3	267	15	46.2	257	20	54	290	40	52	290	50	52	290
MS165-65	20	62.1	334	20	59.4	321	20	54	290	50	65	363	60	62	348
MS165-73	20	62.1	334	20	59.4	321	25	68	365	50	65	363	60	62	348
MS165-80	25	78.2	420	25	74.8	404	30	80	435	60	77	435	75	77	434

hp Horsepower  
 FLA Full Load Amps  
 LRA Locked Rotor Amps

Note: Manual motor starters should always be selected so that the actual motor current is within the setting range; see ordering detail pages. Horsepower (hp) ratings are for reference only.

## MS116, MS132, MS165, MO132, MO165

### Technical data

#### UL/CSA Motor ratings, three phase – MO132

Type	200 V AC			208 V AC			220 ... 240 V AC			440 ... 480 V AC			550 ... 600 V AC		
	hp	FLA	LRA	hp	FLA	LRA	hp	FLA	LRA	hp	FLA	LRA	hp	FLA	LRA
MO132-0.16	-	0.16	0.96	-	0.16	0.96	-	0.16	0.96	-	0.16	0.96	-	0.16	0.96
MO132-0.25	-	0.25	1.5	-	0.25	1.5	-	0.25	1.5	-	0.25	1.5	-	0.25	1.5
MO132-0.40	-	0.4	2.4	-	0.4	2.4	-	0.4	2.4	-	0.4	2.4	-	0.4	2.4
MO132-0.63	-	0.63	3.78	-	0.63	3.78	-	0.63	3.78	-	0.63	3.78	-	0.63	3.78
MO132-1.0	-	1	6	-	1	6	-	1	6	-	1	6	1/2	1	6
MO132-1.6	-	1.6	9.6	-	1.6	9.6	-	1.6	9.6	3/4	1.6	9.6	3/4	1.6	9.6
MO132-2.5	1/2	2.5	15	1/2	2.5	15	1/2	2.5	15	1	2.5	15	1 1/2	2.5	15
MO132-4.0	3/4	4	24	3/4	4	24	1	4	24	2	4	24	3	3.9	25.6
MO132-6.3	1	6.3	37.8	1	6.3	37.8	1 1/2	6.3	37.8	3	4.8	32	5	6.1	36.8
MO132-10	2	7.8	57.5	2	7.5	55	3	9.6	64	5	7.6	46	7 1/2	9	50.8
MO132-12	3	11	73.6	3	10.6	71	3	9.6	64	7 1/2	11	63.5	10	11	64.8
MO132-16	3	11	73.6	3	10.6	71	5	15.2	92	10	14	81	10	11	64.8
MO132-20	5	17.5	105.8	5	16.7	102	5	15.2	92	10	14	81	15	17	93
MO132-25	5	17.5	105.8	7 1/2	24.2	140	7 1/2	22	127	15	21	116	20	22	116
MO132-32	7 1/2	25.3	146	10	30.8	179	10	28	162	20	27	145	25	27	146

#### UL/CSA Motor ratings, three phase – MO165

Type	200 V AC			208 V AC			220 ... 240 V AC			440 ... 480 V AC			550 ... 600 V AC		
	hp	FLA	LRA	hp	FLA	LRA	hp	FLA	LRA	hp	FLA	LRA	hp	FLA	LRA
MO165-16	3	11	73.6	3	10.6	71	5	15.2	92	10	14	81	10	11	64.8
MO165-20	5	17.5	105.8	5	16.7	102	5	15.2	92	10	14	81	15	17	93
MO165-25	5	17.5	105.8	7 1/2	24.2	140	7 1/2	22	127	15	21	116	20	22	116
MO165-32	7 1/2	25.3	146	10	30.8	179	10	28	162	20	27	145	30	32	174
MO165-42	10	32.2	186.3	10	30.8	179	15	42	232	30	40	218	40	41	232
MO165-54	15	48.3	267	15	46.2	257	20	54	290	40	52	290	50	52	290
MO165-65	20	62.1	334	20	59.4	321	20	54	290	50	65	363	60	62	348
MO165-73	20	62.1	334	20	59.4	321	25	68	365	50	65	363	60	62	348
MO165-80	25	78.2	420	25	74.8	404	30	80	435	60	77	435	75	77	434

# MS116, MS132, MS165, MO132, MO165

## Technical data

### UL/CSA Maximum short-circuit current ratings – MS116

Type	Manual Motor Controllers					
	Branch circuit protection, max. size per NEC/CEC (1)		for motor disconnect (2)		for group installations	
	Fuses A	Circuit breaker A	480 V kA	600 V kA	480 V kA	600 V kA
MS116-0.16	Any listed fuses. Size per NEC/CEC	Any listed UL489 / CSA C22.2 N° 5 circuit breaker. Size per NEC/CEC	30	5	30	5
MS116-0.25			30	5	30	5
MS116-0.40			30	5	30	5
MS116-0.63			30	5	30	5
MS116-1.0			30	5	30	5
MS116-1.6			30	5	30	5
MS116-2.5			30	5	30	5
MS116-4.0			18	5	18	5
MS116-6.3			18	5	18	5
MS116-10			18	5	18	5
MS116-12			18	5	18	5
MS116-16			18	5	18	5
MS116-20			18	5	18	5
MS116-25			18	5	18	5
MS116-32			18	5	18	5

(1) NEC: NFPA®70 National Electrical Code®; CEC: CSA C22.1 Canadian Electrical Code.  
 (2) Suitable as motor disconnect with padlock adaptor SA1 or SA3.

### UL/CSA Maximum short-circuit current ratings – MS132

Type	Manual Motor Controllers									
	Branch circuit protection, max. size per NEC/CEC (1)		for motor disconnect		for group installations		for tap conductor protection in group installations		Manual self-protected Combination Motor Controllers (Type E) (2)	
	Fuses A	Circuit breaker A	480 V kA	600 V kA	480 V kA	600 V kA	480 V kA	600 V kA	480Y / 277 V kA	600Y / 347 V kA
MS132-0.16	Any Listed fuses. Size per NEC/CEC	Any Listed UL489 / CSA C22.2 No.5 circuit breaker. Size per NEC/CEC	65	47	65	47	65	47	65	47
MS132-0.25			65	47	65	47	65	47	65	47
MS132-0.40			65	47	65	47	65	47	65	47
MS132-0.63			65	47	65	47	65	47	65	47
MS132-1.0			65	47	65	47	65	47	65	47
MS132-1.6			65	47	65	47	65	47	65	47
MS132-2.5			65	47	65	47	65	47	65	47
MS132-4.0			65	47	65	47	65	47	65	47
MS132-6.3			65	18	65	35	65	18	65	18
MS132-10			65	18	65	35	65	18	65	18
MS132-12			30	18	35	35	30	18	30	-
MS132-16			30	18	35	35	30	18	30	-
MS132-20			30	18	35	35	30	18	30	-
MS132-25			30	18	35	35	30	18	30	-
MS132-32			30	18	35	35	30	18	30	-

(1) NEC: NFPA®70 National Electrical Code®; CEC: CSA C22.1 Canadian Electrical Code.  
 (2) Requires the use of S1-M3-xx line-side terminal feeder block.



# MS116, MS132, MS165, MO132, MO165

## Technical data

### UL/CSA Maximum short-circuit current ratings – MS132 with AF contactors

Type	Combination Motor Controllers (Type F) (1)		
	Coordination type 1 Minimum contactor size	480Y / 277 V kA	600Y / 347 V kA
MS132-0.16	AF09 ... AF38	100	50
MS132-0.25	AF09 ... AF38	100	50
MS132-0.40	AF09 ... AF38	100	50
MS132-0.63	AF09 ... AF38	100	50
MS132-1.0	AF09 ... AF38	100	50
MS132-1.6	AF09 ... AF38	100	50
MS132-2.5	AF09 ... AF38	100	50
MS132-4.0	AF09 ... AF38	100	50
MS132-6.3	AF09 ... AF38	100	47
MS132-10	AF09 ... AF38	100	30
MS132-12	AF09 ... AF38	65	30
MS132-16	AF12 ... AF38	65	30
MS132-20	AF26 ... AF38	65	-
MS132-25	AF26 ... AF38	50	-
MS132-32	AF38	50	-
	Coordination type 2		
MS132-0.16	AF26 ... AF38	65	47
MS132-0.25	AF26 ... AF38	65	47
MS132-0.40	AF26 ... AF38	65	47
MS132-0.63	AF26 ... AF38	65	47
MS132-1.0	AF26 ... AF38	65	47
MS132-1.6	AF26 ... AF38	65	47
MS132-2.5	AF26 ... AF38	65	47
MS132-4.0	AF26 ... AF38	65	47
MS132-6.3	AF26 ... AF38	65	47
MS132-10	AF26 ... AF38	65	47
MS132-12	AF26 ... AF38	30	-
MS132-16	AF26 ... AF38	30	-
MS132-20	AF26 ... AF38	30	-
MS132-25	AF26 ... AF38	30	-
MS132-32	AF26 ... AF38	30	-

### UL/CSA Maximum short-circuit current ratings – MO132 with electronic overload relays and AF contactors

Type	EOL	Combination Motor Controllers (Type F) (1)		
		Coordination type 1 Minimum contactor size	480Y / 277 V kA	600Y / 347 V kA
MO132-0.16	EF19	AF09 ... AF38	100	50
MO132-0.25	EF19	AF09 ... AF38	100	50
MO132-0.40	EF19	AF09 ... AF38	100	50
MO132-0.63	EF19	AF09 ... AF38	100	50
MO132-1.0	EF19	AF09 ... AF38	100	50
MO132-1.6	EF19	AF09 ... AF38	100	50
MO132-2.5	EF19	AF09 ... AF38	100	50
MO132-4.0	EF19	AF09 ... AF38	100	50
MO132-6.3	EF19	AF09 ... AF38	100	50
MO132-10	EF19	AF09 ... AF38	100	30
MO132-12	EF19	AF09 ... AF38	65	30
MO132-16	EF19	AF12 ... AF38	65	30
MO132-20	EF19	AF16 ... AF38	65	-
MO132-25	EF45-30	AF26 ... AF38	50	-
MO132-32	EF45-45	AF38 ... AF38	50	-

NOTE : More coordination tables are available in our SOC (selected optimized coordination) tool: <https://applications.it.abb.com/SOC/Motor>.

(1) Requires the use of S1-M3-xx line-side terminal feeder block.

# MS116, MS132, MS165, MO132, MO165

## Technical data

### UL/CSA Maximum short-circuit current ratings – MS165

Type	Manual Motor Controllers								Manual self-protected Combination Motor Controllers (Type E)		
	Branch circuit protection, max. size per NEC/CEC (1)		for motor disconnect		for group installations		for tap conductor protection in group installations				
	Fuses A	Circuit breaker A	480 V kA	600 V kA	480 V kA	600 V kA	480 V kA	600 V kA	480Y / 277 V kA	600Y / 347 V kA	
MS165-16	Any Listed fuses. Size per NEC/CEC	Any Listed UL489 / CSA C22.2 No.5 circuit breaker. Size per NEC/CEC	65	30	65	30	65	30	65	30	
MS165-20			65	30	65	30	65	30	65	30	
MS165-25			65	30	65	30	65	30	65	30	
MS165-32			65	30	65	30	65	30	65	30	
MS165-42			65	30	65	30	65	30	65	30	
MS165-54			65	30	65	30	65	30	65	30	
MS165-65			65	30	65	30	65	30	65	30	
MS165-73			50	10	50	10					
MS165-80			50	10	50	10					

(1) NEC: NFPA®70 National Electrical Code®; CEC: CSA C22.1 Canadian Electrical Code.

### UL/CSA Maximum short-circuit current ratings – MS165 with AF contactors

Type	Manual self-protected Combination Motor Controllers (Type F) Coordination type 1				Manual self-protected Combination Motor Controllers (Type F) Coordination type 2			
	Minimum contactor size	480Y / 277 V kA	Minimum contactor size	600Y / 347 V kA	Minimum contactor size	480Y / 277 V kA	Minimum contactor size	600Y / 347 V kA
	MS165-16	AF09...AF38	65	AF09...AF38	50	AF26...AF38	65	AF09...AF38
MS165-20	AF26...AF38	65	AF26...AF38	50	AF26...AF38	65	AF09...AF38	30
MS165-25	AF26...AF38	65	AF26...AF38	50	AF26...AF38	65	AF40...AF65	30
MS165-32	AF26...AF38	65	AF26...AF38	50	AF26...AF38	65	AF40...AF65	30
MS165-42	AF40...AF65	65	AF40...AF65	30	AF40...AF65	65	AF40...AF65	30
MS165-54	AF40...AF65	65	AF40...AF65	30	AF40...AF65	65	AF40...AF65	30
MS165-65	AF40...AF65	65	AF40...AF65	30	AF40...AF65	65	AF40...AF65	30
MS165-73								
MS165-80								

More coordination tables are available in our SOC (selected optimized coordination) tool: <https://applications.it.abb.com/SOC/Motor>

### UL/CSA Maximum short-circuit current ratings – MO132

Type	Manual Motor Controllers							
	Branch circuit protection, max. size per NEC/CEC (1)		for motor disconnect		for group installations		for tap conductor protection in group installations	
	Fuses A	Circuit breaker A	480 V kA	600 V kA	480 V kA	600 V kA	480 V kA	600 V kA
MO132-0.16	Any Listed fuses. Size per NEC/CEC	Any Listed UL489 / CSA C22.2 No.5 circuit breaker. Size per NEC/CEC	65	47	65	47	65	47
MO132-0.25			65	47	65	47	65	47
MO132-0.40			65	47	65	47	65	47
MO132-0.63			65	47	65	47	65	47
MO132-1.0			65	47	65	47	65	47
MO132-1.6			65	47	65	47	65	47
MO132-2.5			65	47	65	47	65	47
MO132-4.0			65	47	65	47	65	47
MO132-6.3			65	18	65	35	65	18
MO132-10			65	18	65	35	65	18
MO132-12			30	18	35	35	30	18
MO132-16			30	18	35	35	30	18
MO132-20			30	18	35	35	30	18
MO132-25			30	18	35	35	30	18
MO132-32			30	18	35	35	30	18

(1) NEC: NFPA®70 National Electrical Code®; CEC: CSA C22.1 Canadian Electrical Code.

# MS116, MS132, MS165, MO132, MO165

## Technical data

### UL/CSA Maximum short-circuit current ratings – MO165

Type	Manual Motor Controllers							
	Branch circuit protection, max. size per NEC/CEC (1)		for motor disconnect		for group installations		for tap conductor protection in group installations	
	Fuses A	Circuit breaker A	480 V kA	600 V kA	480 V kA	600 V kA	480 V kA	600 V kA
MO165-16	Any Listed fuses. Size per NEC/CEC	Any Listed UL489 / CSA C22.2 No.5 circuit breaker. Size per NEC/CEC	65	30	65	30	65	30
MO165-20			65	30	65	30	65	30
MO165-25			65	30	65	30	65	30
MO165-32			65	30	65	30	65	30
MO165-42			65	30	65	30	65	30
MO165-54			65	30	65	30	65	30
MO165-65			65	30	65	30	65	30
MO165-73			50	10	50	10		
MO165-80			50	10	50	10		

(1) NEC: NFPA®70 National Electrical Code®; CEC: CSA C22.1 Canadian Electrical Code.

### UL/CSA Maximum short-circuit current ratings – MO165 with AF contactors

Type	Combination Motor Controllers (Type F)					
	Coordination type 1					
	480Y / 277 V kA	OL Relay	Contactor	600Y / 347 V kA	OL Relay	Contactor
MO165-16	65	EF19-18.9	AF09...AF38	50	EF19-18.9	AF09...AF38
MO165-20	65	EF45-30	AF26...AF38	50	EF45-30	AF26...AF38
MO165-25	65	EF45-30	AF26...AF38	50	EF45-30	AF26...AF38
MO165-32	65	EF45-45	AF26...AF38	50	EF45-45	AF26...AF38
MO165-42	65	EF65	AF40...AF65	30	EF65	AF40...AF65
MO165-54	65	EF65	AF40...AF65	30	EF65	AF40...AF65
MO165-65	65	EF65	AF40...AF65	30	EF65	AF40...AF65
MO165-73						
MO165-80						

### UL/CSA Maximum short-circuit current ratings – MO165 with AF contactors

Type	Combination Motor Controllers (Type F)					
	Coordination type 2					
	480Y / 277 V kA	OL Relay	Contactor	600Y / 347 V kA	OL Relay	Contactor
MO165-16	65	TF42	AF09...AF38	30	TF42	AF09...AF38
MO165-20	65	TF42	AF26...AF38	30	TF42	AF09...AF38
MO165-25	65	TF42	AF26...AF38	50	TF42	AF26...AF38
MO165-32	65	TF42	AF26...AF38	50	TF42	AF26...AF38
MO165-42	65	TF65	AF40...AF65	30	TF65	AF40...AF65
MO165-54	65	TF65	AF40...AF65	30	TF65	AF40...AF65
MO165-65	65	TF65	AF40...AF65	30	TF65	AF40...AF65
MO165-73						
MO165-80						

# MS116, MS132, MS165, MO132, MO165





## Technical data





### General technical data





Type	MS116	MS132	MS165	MO132	MO165
Pollution degree	3	3	3	3	3
Phase loss sensitivity	Yes	Yes	Yes	No	No
Disconnect function acc. to IEC/EN 60947-2	Yes	Yes	Yes	Yes	Yes
Ambient air temperature					
Operation					
Open - compensated	-25 ... +55 °C	-25 ... +60 °C	-25 ... +60 °C	-	-
Open	-25 ... +70 °C	-25 ... +70 °C	-25 ... +60 °C	-25 ... +60 °C	-25 ... +60 °C
Enclosed (IB132)	0 ... +40 °C	0 ... +40 °C	-	-	-
Storage	-50 ... +80 °C	-50 ... +80 °C	-50 ... +80 °C	-50 ... +80 °C	-50 ... +80 °C
Ambient air temperature compensation	Acc. to IEC/EN60947-4-1	Acc. to IEC/EN60947-4-1	Acc. to IEC/EN60947-4-1	-	-
Maximum operating altitude permissible	2000 m	2000 m	2000 m	2000 m	2000 m
Resistance to shock acc. to IEC 60068-2-27	25g / 11 ms	25g / 11 ms	25g / 11 ms	25g / 11 ms	25g / 11 ms
Resistance to vibrations acc. to IEC 60068-2-6	5g / 3 ... 150 Hz	5g / 3 ... 150 Hz	5g / 3 ... 150 Hz	5g / 3 ... 150 Hz	5g / 3 ... 150 Hz
Mounting position	Position 1-6 (optional for single mounting)	Position 1-6 (optional for single mounting)	Position 1-6 (optional for single mounting)	Position 1-6 (optional for single mounting)	Position 1-6 (optional for single mounting)
Mounting	DIN-rail (EN 60715)	DIN-rail (EN 60715)	DIN-rail (EN 60715)	DIN-rail (EN 60715)	DIN-rail (EN 60715)
Group mounting	On request	On request	On request	On request	On request
Recommended screw for mounting plate	-	-	M4	-	M4
Screw torque for mounting plate	-	-	2 Nm	-	2 Nm
Minimum distance to other units same type					
Horizontal	0 mm	0 mm	0 mm	0 mm	0 mm
Vertical	150 mm	150 mm	150 mm	150 mm	150 mm
Minimum distance to electrical conductive board					
Horizontal, up to 400 V	0 mm	0 mm	0 mm	0 mm	0 mm
Horizontal, up to 690 V	> 1.5 mm	> 1.5 mm	> 1.5 mm	> 1.5 mm	> 1.5 mm
Vertical	75 mm	75 mm	75 mm	75 mm	75 mm
Degree of protection					
Housing	IP20	IP20	IP20	IP20	IP20
Main circuit terminals	IP10	IP10 (1)	IP10	IP10	IP10

(1) Push-in Spring terminals : IP20

### Connecting characteristics - Main circuit

Type	MS116 ≤ 16 A	MS116 ≥ 20 A
Connecting capacity		
 Rigid	1 or 2 x 1 ... 4 mm <sup>2</sup>	2.5 ... 6 mm <sup>2</sup>
 Flexible with ferrule	1 or 2 x 0.75 ... 2.5 mm <sup>2</sup>	1 ... 6 mm <sup>2</sup>
 Flexible with insulated ferrule	1 or 2 x 0.75 ... 2.5 mm <sup>2</sup>	1 ... 6 mm <sup>2</sup>
 Flexible	1 or 2 x 0.75 ... 2.5 mm <sup>2</sup>	1 ... 6 mm <sup>2</sup>
Stranded acc. to UL/CSA	1 or 2 x AWG 16-12	AWG 16-8
Stripping length	9 mm	10 mm
Tightening torque	0.8 ... 1.2 Nm / 10 ... 12 lb.in	2.0 Nm / 18 lb.in
Recommended screwdriver	Pozidriv 2	Pozidriv 2





Type	MS132 ≤ 10 A	MS132 ≥ 12 A
Connecting capacity		
 Rigid	1 or 2 x 1 ... 4 mm <sup>2</sup>	1 ... 2.5 mm <sup>2</sup> 2.5 ... 6 mm <sup>2</sup>
 Flexible with ferrule	1 or 2 x 0.75 ... 2.5 mm <sup>2</sup>	0.75 ... 6 mm <sup>2</sup>
 Flexible with insulated ferrule	1 or 2 x 0.75 ... 2.5 mm <sup>2</sup>	0.75 ... 6 mm <sup>2</sup>
 Flexible	1 or 2 x 0.75 ... 2.5 mm <sup>2</sup>	1 ... 2.5 mm <sup>2</sup> 2.5 ... 6 mm <sup>2</sup>
Stranded acc. to UL/CSA	1 or 2 x AWG 16-12	AWG 16-8
Stripping length	9 mm	10 mm
Tightening torque	0.8 ... 1.2 Nm / 10 ... 12 lb.in	2.0 Nm / 18 lb.in
Recommended screwdriver	Pozidriv 2	Pozidriv 2





Type	MS132-K with Push-in Spring terminals
Connecting capacity	
 Rigid solid	1 or 2 x 1 ... 2.5 mm <sup>2</sup>
 Rigid stranded	1 or 2 x 1 ... 6 mm <sup>2</sup>
 Flexible with ferrule	1 or 2 x 0.5 ... 4 mm <sup>2</sup>
 Flexible with insulated ferrule	1 x 0.5 ... 4 mm <sup>2</sup> 1/2 x 0.5 ... 2.5 mm <sup>2</sup>
 Flexible	1 or 2 x 0.75 ... 4 mm <sup>2</sup>
Stranded acc. to UL/CSA	1/2 x AWG 18 ... AWG 10 1 x AWG 8
Wire stripping length	12 mm
Screwdriver	Flat Ø 3 mm x 0.5 mm





## MS116, MS132, MS165, MO132, MO165

### Technical data

#### Connecting characteristics - Main circuit

Type	MS165	
Connecting capacity		
 Rigid stranded	1 or 2 x	1 ... 50 mm <sup>2</sup>
 Flexible with ferrule	1 or 2 x	1 ... 35 mm <sup>2</sup>
 Flexible with insulated ferrule	1 or 2 x	1 ... 35 mm <sup>2</sup>
 Flexible	1 or 2 x	1 ... 35 mm <sup>2</sup>
Stranded acc. to UL/CSA	1 or 2 x	AWG 16-0
Stripping length		16 mm
Tightening torque		4.0 Nm / 35 lb.in
Recommended screw driver		Pozidriv 2

Type	MO132 ≤ 10 A		MO132 ≥ 12 A
Connecting capacity			
 Rigid	1 or 2 x	1 ... 4 mm <sup>2</sup>	1 ... 2.5 mm <sup>2</sup> 2.5 ... 6 mm <sup>2</sup>
 Flexible with ferrule	1 or 2 x	0.75 ... 2.5 mm <sup>2</sup>	0.75 ... 6 mm <sup>2</sup>
 Flexible with insulated ferrule	1 or 2 x	0.75 ... 2.5 mm <sup>2</sup>	0.75 ... 6 mm <sup>2</sup>
 Flexible	1 or 2 x	0.75 ... 2.5 mm <sup>2</sup>	1 ... 2.5 mm <sup>2</sup> 2.5 ... 6 mm <sup>2</sup>
Stranded acc. to UL/CSA	1 or 2 x	AWG 16-12	AWG 16-8
Stripping length		9 mm	10 mm
Tightening torque		0.8 ... 1.2 Nm / 10 ... 12 lb.in	2.0 Nm / 18 lb.in
Recommended screw driver		Pozidriv 2	Pozidriv 2

Type	MO165	
Connecting capacity		
 Rigid stranded	1 or 2 x	1 ... 50 mm <sup>2</sup>
 Flexible with ferrule	1 or 2 x	1 ... 35 mm <sup>2</sup>
 Flexible with insulated ferrule	1 or 2 x	1 ... 35 mm <sup>2</sup>
 Flexible	1 or 2 x	1 ... 35 mm <sup>2</sup>
Stranded acc. to UL/CSA	1 or 2 x	AWG 16-0
Stripping length		16 mm
Tightening torque		4.0 Nm / 35 lb.in
Recommended screw driver		Pozidriv 2





# Circuit breakers for transformer protection

Low voltage transformers are used to supply power to control and auxiliary circuits in distribution and automation boards and to provide galvanic isolation. These transformers may be damaged by an electrical failure (short-circuit or overload on the primary side), therefore a proper protection should be provided.

**Troubleshooting made easy**  
MS132-T feature a magnetic trip indicator. This way, every tripping event will be distinguished, making troubleshooting a lot easier and faster

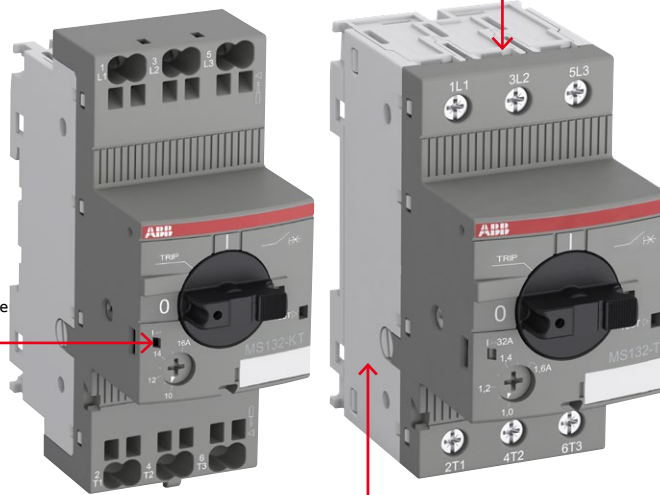

## Complete portfolio

Manual motor starter accessories are suitable throughout the complete range. Moreover ABB offers special accessories for fast single-phase setup.



## Transformer protection

MS132-T is an inrush compensated circuit breaker for control transformer protection. With the right selection, it provides overcurrent protection on the primary side of the transformer. This avoids expensive protection on the secondary side.

Circuit breakers for transformers protection are specially designed for fuseless protection of control transformers on the primary side against overloads and short-circuits.

### Application example

Protection of transformers for power supply of control and auxiliary circuits, both in distribution and automation boards (checking, signaling, interlock, etc).



# MS132-T circuit breakers for transformer protection

0.10 to 25 A – with thermal and electromagnetic protection



2CDC24009V0017

MS132-10T



2CDC241008P0014

MS132-25T

Circuit breakers for transformer protection are electro-mechanical protection devices specially designed to protect control transformers on the primary side. They allow fuseless protection against overload and short-circuit, saving space and cost and ensuring a quick reaction under short-circuit condition by switching off the transformer within milliseconds. The short-circuit current setting is fixed to 20 times the operating current to handle the high inrush current generated by transformers. The device allows manual connection and disconnection of the transformer from the mains.

MS132-T is a 45 mm (width) compact and powerful range for transformer protection up to 12.5 kW (400 V) / 25 A. This type has also a clear and reliable indication of fault in a separate window in the event of short-circuit tripping. Further features are the built-in disconnect function, temperature compensation, trip-free mechanism and a rotary handle with a clear switch position indication. The handle is lockable to protect against unauthorized changes. Auxiliary contacts, signaling contacts, undervoltage releases, shunt trips, power in-feed blocks are available as accessory. These are suitable throughout the MS116/MS132/MS165-range. Moreover ABB offers special accessories for fast single phase setup.

Setting range	Short-circuit breaking capacity Ics at 400 V AC kA	Rated instantaneous short-circuit current setting Ii A	Type	Order code	Weight (1 pce)
A					kg
0.10 ... 0.16	100	3.2	MS132-0.16T	1SAM340000R1001	0.215
0.16 ... 0.25	100	5	MS132-0.25T	1SAM340000R1002	0.215
0.25 ... 0.40	100	8	MS132-0.4T	1SAM340000R1003	0.215
0.40 ... 0.63	100	12.6	MS132-0.63T	1SAM340000R1004	0.215
0.63 ... 1.00	100	20	MS132-1.0T	1SAM340000R1005	0.215
1.00 ... 1.60	100	32	MS132-1.6T	1SAM340000R1006	0.265
1.60 ... 2.50	100	50	MS132-2.5T	1SAM340000R1007	0.265
2.50 ... 4.00	100	80	MS132-4.0T	1SAM340000R1008	0.265
4.00 ... 6.30	100	126	MS132-6.3T	1SAM340000R1009	0.265
6.30 ... 10.0	100	200	MS132-10T	1SAM340000R1010	0.265
8.00 ... 12.0	100	240	MS132-12T	1SAM340000R1012	0.310
10.0 ... 16.0	100	320	MS132-16T	1SAM340000R1011	0.310
16.0 ... 20.0	100	400	MS132-20T	1SAM340000R1013	0.310
20.0 ... 25.0	50	500	MS132-25T	1SAM340000R1014	0.310

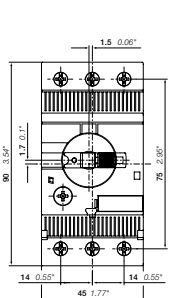

MS132T ≤ 10 A

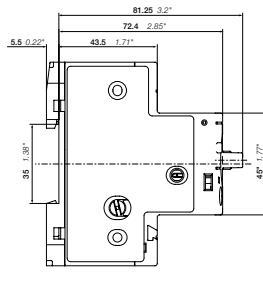

MS132T ≥ 12 A

Main dimensions mm, inches

2CDC131062C0201

# MS132-KT circuit breakers for transformer protection with Push-in Spring terminals

0.10 to 25 A – with thermal and electromagnetic protection



MS132-KT

Circuit breakers for transformer protection with Push-in Spring terminals are electro-mechanical protection devices specially designed to protect control transformers on the primary side. They allow fuseless protection against overload and short-circuit, saving space and cost and ensuring a quick reaction under short-circuit condition by switching off the transformer within milliseconds. The short-circuit current setting is fixed to 20 times the operating current to handle the high inrush current generated by transformers. The device allows manual connection and disconnection of the transformer from the mains.

MS132-KT is a 45 mm (width) compact and powerful range for transformer protection up to 12.5 kW (400 V) / 25 A. This type has also a clear and reliable indication of fault in a separate window in the event of short-circuit tripping. Further features are the built-in disconnect function, temperature compensation, trip-free mechanism and a rotary handle with a clear switch position indication. The handle is lockable to protect against unauthorized changes. Auxiliary contacts, signaling contacts, undervoltage releases and shunt trips are available as accessory. These are suitable throughout the MS116/MS132/MS165-range.

Setting range	Short-circuit breaking capacity Ics at 400 V AC kA	Rated instantaneous short-circuit current setting Ii A	Type	Order code	Weight (1 pce) kg
0.10 ... 0.16	100	3.2	MS132-0.16KT	1SAM340010R1001	0.256
0.16 ... 0.25	100	5	MS132-0.25KT	1SAM340010R1002	0.256
0.25 ... 0.40	100	8	MS132-0.4KT	1SAM340010R1003	0.256
0.40 ... 0.63	100	12.6	MS132-0.63KT	1SAM340010R1004	0.256
0.63 ... 1.00	100	20	MS132-1.0KT	1SAM340010R1005	0.256
1.00 ... 1.60	100	32	MS132-1.6KT	1SAM340010R1006	0.298
1.60 ... 2.50	100	50	MS132-2.5KT	1SAM340010R1007	0.280
2.50 ... 4.00	100	80	MS132-4.0KT	1SAM340010R1008	0.286
4.00 ... 6.30	100	126	MS132-6.3KT	1SAM340010R1009	0.289
6.30 ... 10.0	100	200	MS132-10KT	1SAM340010R1010	0.296
10.0 ... 16.0	100	320	MS132-16KT	1SAM340010R1011	0.316
16.0 ... 20.0	100	400	MS132-20KT	1SAM340010R1013	0.317
20.0 ... 25.0	50	500	MS132-25KT	1SAM340010R1014	0.316

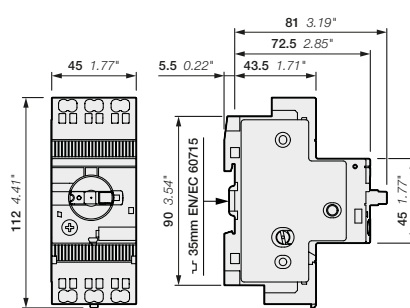

MS132-KT > 10 A

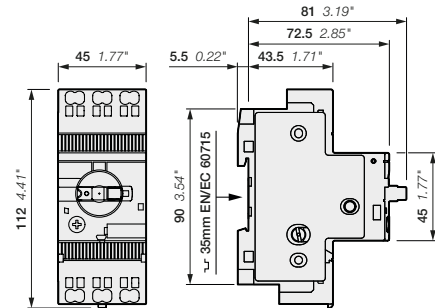

MS132-KT < 10 A

Main dimensions mm, inches

2CDC131062C0201

# MS132-T, MS132-KT

## Technical data

### Main circuit – Utilization characteristics according to IEC/EN

Type	MS132-T / -KT
Standards	IEC/EN 60947-2, IEC/EN 60947-4-1, IEC/EN 60947-1
Rated operational voltage Ue	690 V AC
Rated frequency	50/60 Hz
Operational frequency	0 ... 400 Hz
Trip class	10
Number of poles	3
Duty time	100%
Mechanical durability	100000 cycles
Electrical durability	50000 cycles
Rated impulse withstand voltage Uimp	6 kV
Rated insulation voltage Ui	690 V
Rated operational current Ie	See ordering details
Rated instantaneous short-circuit current setting Ii	See ordering details
Rated service short-circuit breaking capacity Ics	See table "Short-circuit breaking capacity and back-up fuses"
Rated ultimate short-circuit breaking capacity Icu	See table "Short-circuit breaking capacity and back-up fuses"

### Short-circuit breaking capacity and back-up fuses

Ics Rated service short-circuit breaking capacity

Icu Rated ultimate short-circuit breaking capacity

Icc Prospective short-circuit current at installation location

Note: Maximum rated current of the back-up fuses if Icc > Ics

Type	230 V AC			400 V AC			440 V AC			500 V AC			690 V AC		
	Ics kA	Icu kA	gG, aM A	Ics kA	Icu kA	gG, aM A	Ics kA	Icu kA	gG, aM A	Ics kA	Icu kA	gG, aM A	Ics kA	Icu kA	gG, aM A
MS132-0.16T / -KT	100	100	-(1)	100	100	-(1)	100	100	-(1)	100	100	-(1)	100	100	-(1)
MS132-0.25T / -KT	100	100	-(1)	100	100	-(1)	100	100	-(1)	100	100	-(1)	100	100	-(1)
MS132-0.4T / -KT	100	100	-(1)	100	100	-(1)	100	100	-(1)	100	100	-(1)	100	100	-(1)
MS132-0.63T / -KT	100	100	-(1)	100	100	-(1)	100	100	-(1)	100	100	-(1)	100	100	-(1)
MS132-1.0T / -KT	100	100	-(1)	100	100	-(1)	100	100	-(1)	100	100	-(1)	100	100	-(1)
MS132-1.6T / -KT	100	100	-(1)	100	100	-(1)	100	100	-(1)	100	100	-(1)	100	100	-(1)
MS132-2.5T / -KT	100	100	-(1)	100	100	-(1)	100	100	-(1)	100	100	-(1)	100	100	-(1)
MS132-4.0T / -KT	100	100	-(1)	100	100	-(1)	30	30	35 (2)	20	20	35 (2)	3	3	35 (2)
MS132-6.3T / -KT	100	100	-(1)	100	100	-(1)	30	30	63 (2)	20	20	63 (2)	3	3	50 (2)
MS132-10T / -KT	100	100	-(1)	100	100	-(1)	30	30	100 (2)	20	20	100 (2)	3	3	50 (2)
MS132-12T	100	100	-(1)	100	100	-(1)	30	30	100 (2)	20	20	100 (2)	3	3	63 (2)
MS132-16T / -KT	100	100	-(1)	100	100	-(1)	30	30	125 (2)	20	20	125 (2)	3	3	63 (2)
MS132-20T / -KT	100	100	-(1)	100	100	-(1)	30	30	125 (2)	20	20	125 (2)	3	3	80 (2)
MS132-25T / -KT	50	50	125 (2)	50	50	125 (2)	30	30	125 (2)	10	10	125 (2)	3	3	100 (2)

(1) No back-up fuse required, because short-circuit proof up to 100 kA

(2) Rated back-up fuse for short-circuits up to 100 kA



## MS132-T, MS132-KT

### Technical data

#### Main circuit – Utilization characteristics according to UL

Type	MS132-T / -KT	
Standards	UL 60947-1, UL 60947-4-1	
Rated operational voltage U <sub>e</sub> acc. to UL/CSA	600 V AC	
Trip class	10	
Motor ratings (1)	Full Load Amps (FLA)	see table UL current ratings

(1) See product data sheets for UL/CSA single phase motor and general use (AC-1) ratings.

#### UL/CSA ratings overview

Type	MS132-T / -KT	
Manual Motor Controller	not applicable	
Manual Motor Controller, Suitable as Motor Disconnect	not applicable	
Manual Motor Controller, Suitable for use in Group Installations	not applicable	
Manual Motor Controller, Suitable for Tap Conductor Protection in Group Installations	x	
Manual self-protected Combination Motor Controller (Type E)	not applicable	
Combination Motor Controller (Type F)	not applicable	

#### UL current ratings, single-phase – MS132-T / -KT

Type	120 V AC	220 ... 240 V AC
	FLA	FLA
MS132-0.16T / -KT	0.16	0.16
MS132-0.25T / -KT	0.25	0.25
MS132-0.4T / -KT	0.4	0.4
MS132-0.63T / -KT	0.63	0.63
MS132-1.0T / -KT	1	1
MS132-1.6T / -KT	1.6	1.6
MS132-2.5T / -KT	2.5	2.5
MS132-4.0T / -KT	4	4
MS132-6.3T / -KT	6.3	6.3
MS132-10T / -KT	9.8	10
MS132-12T	9.8	12
MS132-16T / -KT	16	12
MS132-20T / -KT	20	17
MS132-25T / -KT	24	17

#### UL 508 — Manual controller for tap conductor protection and for control transformers

Type	Max. short-circuit current rating when used with upstream protection device	
	480 V kA	600 V kA
MS132-0.16T / -KT	65	47
MS132-0.25T / -KT	65	47
MS132-0.4T / -KT	65	47
MS132-0.63T / -KT	65	47
MS132-1.0T / -KT	65	47
MS132-1.6T / -KT	65	47
MS132-2.5T / -KT	65	47
MS132-4.0T / -KT	65	47
MS132-6.3T / -KT	65	18
MS132-10T / -KT	65	18
MS132-12T	30	18
MS132-16T / -KT	30	18
MS132-20T / -KT	30	18
MS132-25T / -KT	30	18





# MS132-T, MS132-KT

## Technical data





### General technical data

Type		MS132-T / - KT
Pollution degree		3
Phase loss sensitivity		Yes
Disconnect function acc. to IEC/EN 60947-2		Yes
Ambient air temperature		
Operation	Open - compensated	-25 ... +60 °C
	Open	-25 ... +70 °C
	Enclosed (IB132)	0 ... +40 °C
Storage		-50 ... +80 °C
Ambient air temperature compensation		Acc. to IEC/EN60947-4-1
Maximum operating altitude permissible		2000 m
Resistance to shock acc. to IEC 60068-2-27		25g / 11 ms
Resistance to vibrations acc. to IEC 60068-2-6		5g / 3 ... 150 Hz
Mounting position		Position 1-6 (optional for single mounting)
Mounting		DIN-rail (EN 60715)
Group mounting		-
Recommended screw for mounting plate		-
Screw torque for mounting plate		-
Minimum distance to other units same type	Horizontal	0 mm
	Vertical	150 mm
Minimum distance to electrical conductive board	Horizontal, up to 400 V	0 mm
	Horizontal, up to 690 V	> 1.5 mm
	Vertical	75 mm
Degree of protection	Housing	IP20
	Main circuit terminals	IP10 (Push-in Spring terminals: IP20)

### Connecting characteristics - main circuit

Type		MS132-T ≤ 10 A	MS132-T ≥ 12 A
Connecting capacity			
 Rigid	1 or 2 x	1 ... 4 mm <sup>2</sup>	1 ... 2.5 mm <sup>2</sup> 2.5 ... 6 mm <sup>2</sup>
 Flexible with ferrule	1 or 2 x	0.75 ... 2.5 mm <sup>2</sup>	0.75 ... 6 mm <sup>2</sup>
 Flexible with insulated ferrule	1 or 2 x	0.75 ... 2.5 mm <sup>2</sup>	0.75 ... 6 mm <sup>2</sup>
 Flexible	1 or 2 x	0.75 ... 2.5 mm <sup>2</sup>	1 ... 2.5 mm <sup>2</sup> 2.5 ... 6 mm <sup>2</sup>
Stranded acc. to UL/CSA		1 or 2 x	AWG 16-12 AWG 16-8
Stripping length		9 mm	10 mm
Tightening torque		0.8 ... 1.2 Nm / 10 ... 12 lb.in	2.0 Nm / 18 lb.in
Recommended screwdriver		Pozidriv 2	Pozidriv 2

### Connecting characteristics - main circuit

Type		MS132-KT with Push-in Spring terminals
Connecting capacity		
 Rigid solid	1 or 2 x	1 ... 2.5 mm <sup>2</sup>
 Rigid stranded	1 or 2 x	1 ... 6 mm <sup>2</sup>
 Flexible with ferrule	1 or 2 x	0.5 ... 4 mm <sup>2</sup>
 Flexible with insulated ferrule	1 x	0.5 ... 4 mm <sup>2</sup>
	1/2 x	0.75 ... 4 mm <sup>2</sup>
 Flexible	1 or 2 x	0.75 ... 4 mm <sup>2</sup>
Stranded acc. to UL/CSA		1/2 x
		AWG 18 ... AWG 10
Wire stripping length		12 mm
Tightening torque		0.8 ... 1.2 Nm / 10 ... 12 lb.in
Screwdriver		Flat Ø 3 mm x 0.5 mm

# Accessories

MS116, MS132, MS165, MO132, MO165, MS132-T

## Manual motor starters with accessories (MS116, MO132, MO165)

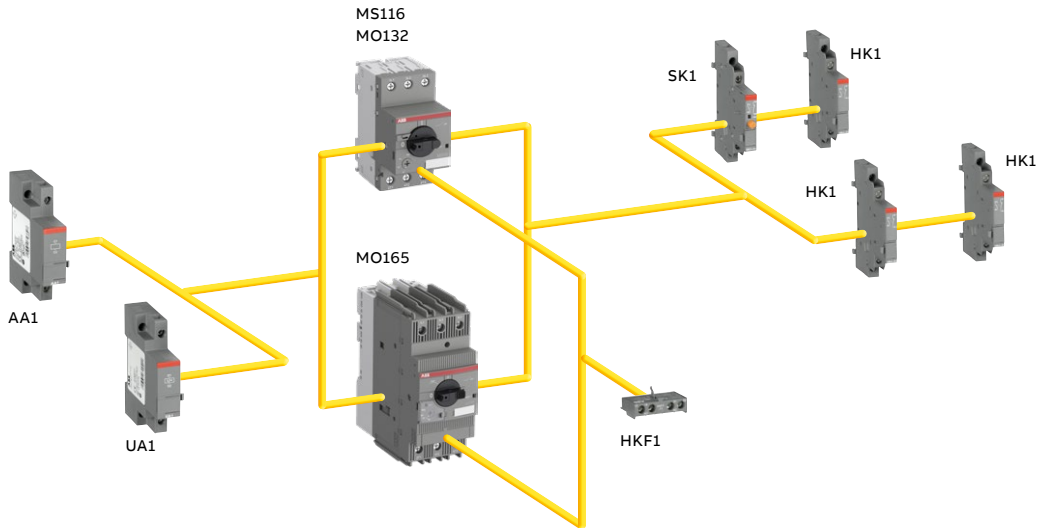

## Manual motor starters (MS132, MS165) and circuit breakers for transformer protection (MS132-T) with accessories

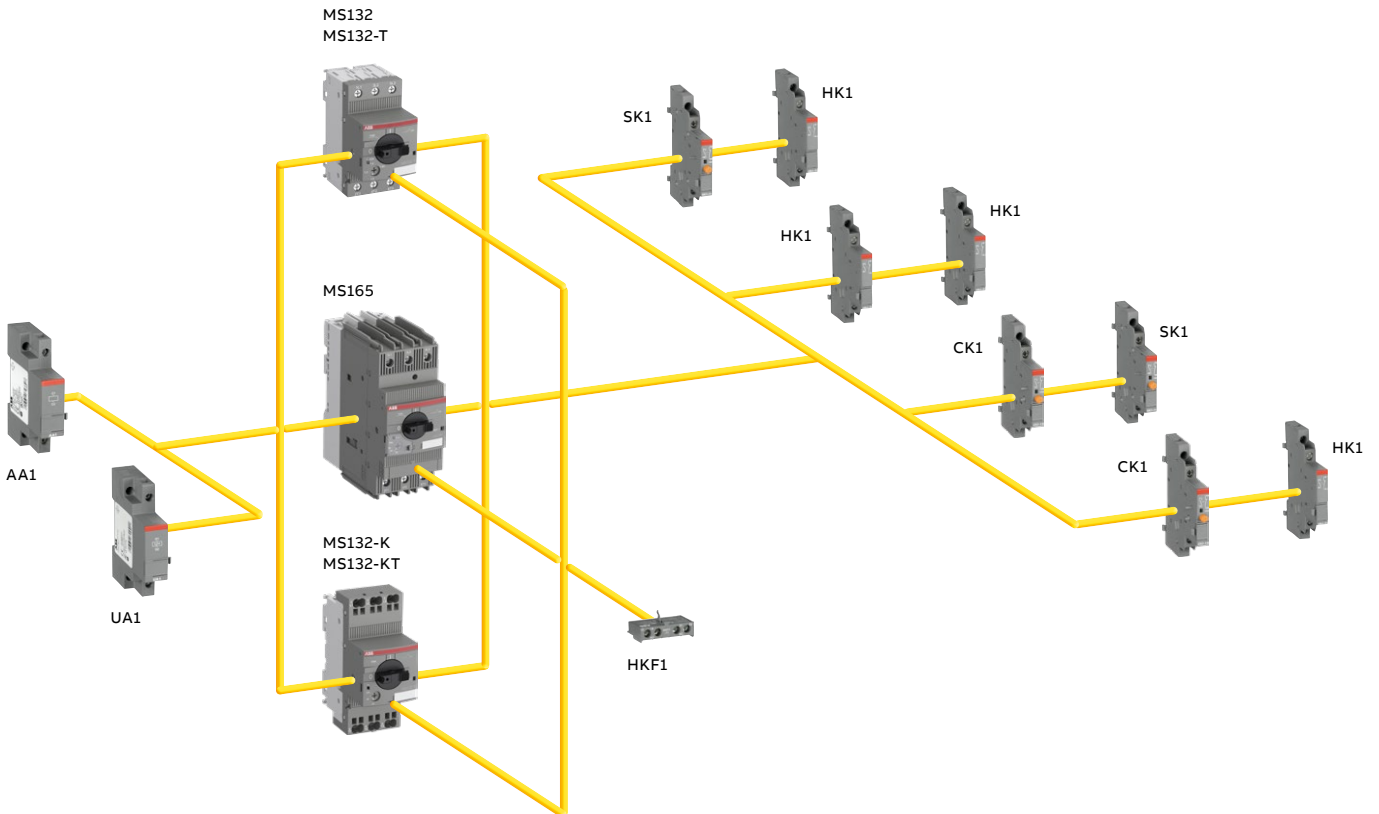

Note: The combination of MS132-K + UA1 + CK1 is not possible

## Accessories

MS116, MS132, MS165, MO132, MO165, MS132-T, MS132-K, MS132-KT



1SBCL01208F0014

HKF1-11



1SBCL01209F0014

HK1-11



1SBCL01210F0014

SK1-11



1SBCL01266F0014

CK1-11

Manual motor starters and MS132-T can be equipped with auxiliary contacts for lateral/front mounting, signaling contacts for lateral mounting, undervoltage releases and shunt trips. Two different signaling contacts are available. The accessories can be fitted wiring free and without tools. A variety of combinations is possible as required for the application. The auxiliary contacts change position with the main contacts. The signaling contact SK1 signals tripping regardless if it was caused by short-circuit or overload. The signaling contact CK1 signals tripping in case it was caused by short-circuit. Undervoltage releases are used for remote tripping of the manual motor starters, specially for emergency stop circuits. Shunt trips release the manual motor starters used for remote tripping. These main accessories are suitable throughout the MS116/MS132/MS165-range.

Suitable for	Auxiliary contacts N.O.	Auxiliary contacts N.C.	Description	Type	Order code	Pkg qty	Weight (1 pce) kg
--------------	-------------------------	-------------------------	-------------	------	------------	---------	-------------------

### Auxiliary contacts – mountable on the front

MS116, MS132, MS165, MO132,	1	1		HKF1-11	1SAM201901R1001	10	0.015
MO165, MS132-T,	1	0		HKF1-10	1SAM201901R1003	10	0.013
MS132-K, MS132-KT	0	1		HKF1-01	1SAM201901R1004	10	0.013
	2	0		HKF1-20	1SAM201901R1002	10	0.015

### Auxiliary contacts – mountable on the right

MS116, MS132,	1	1	max. 2 pieces	HK1-11	1SAM201902R1001	2	0.035
MS165, MO132,	2	0	max. 2 pieces	HK1-20	1SAM201902R1002	2	0.035
MO165, MS132-T, MS132-K, MS132-KT	0	2	max. 2 pieces	HK1-02	1SAM201902R1003	2	0.035
MS116, MS132, MO132, MS132-T, MS132-K, MS132-KT	2	0	max. 2 pieces with leading contacts	HK1-20L	1SAM201902R1004	2	0.035

### Signaling contacts – mountable on the right

MS116, MS132,	1	1	for tripped alarm	SK1-11	1SAM201903R1001	2	0.035
MS165, MO132,	2	0	for tripped alarm	SK1-20	1SAM201903R1002	2	0.035
MO165, MS132-T, MS132-K, MS132-KT	0	2	for tripped alarm	SK1-02	1SAM201903R1003	2	0.035
MS132, MS165,	1	1	for short-circuit alarm	CK1-11	1SAM301901R1001	2	0.035
MS132-T, MS132-K,	2	0	for short-circuit alarm	CK1-20	1SAM301901R1002	2	0.035
MS132-KT	0	2	for short-circuit alarm	CK1-02	1SAM301901R1003	2	0.035

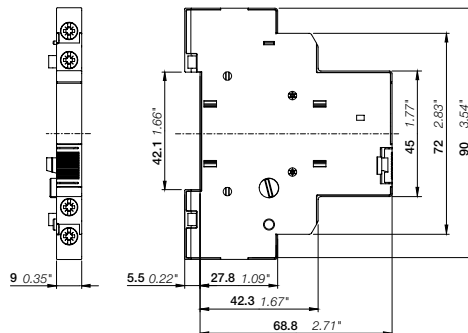

HK1

Main dimensions mm, inches

## Accessories

MS116, MS132, MS165, MO132, MO165, MS132-T



AA1-24



UA1-24

Suitable for	Rated control supply voltage		Type	Order code	Pkg qty	Weight (1 pce) kg
	50 Hz V AC	60 Hz V AC				

### Shunt trips – mountable on the left

MS116, MS132, MS165, MO132, MO165, MS132-T	20 ... 24	20 ... 24	AA1-24	1SAM201910R1001	1	0.100
	110	110	AA1-110	1SAM201910R1002	1	0.100
	200 ... 240	200 ... 240	AA1-230	1SAM201910R1003	1	0.100
	350 ... 415	350 ... 415	AA1-400	1SAM201910R1004	1	0.100

### Undervoltage releases – mountable on the left

MS116, MS132, MS165, MO132, MO165, MS132-T	20	24	UA1-20	1SAM201904R1010	1	0.100
	24	-	UA1-24	1SAM201904R1001	1	0.100
	48	-	UA1-48	1SAM201904R1002	1	0.100
	60	-	UA1-60	1SAM201904R1003	1	0.100
	110	120	UA1-110	1SAM201904R1004	1	0.100
	-	208	UA1-208	1SAM201904R1008	1	0.100
	230	240	UA1-230	1SAM201904R1005	1	0.100
	400	-	UA1-400	1SAM201904R1006	1	0.100
	415	480	UA1-415	1SAM201904R1007	1	0.100
	-	575	UA1-575	1SAM201904R1009	1	0.100

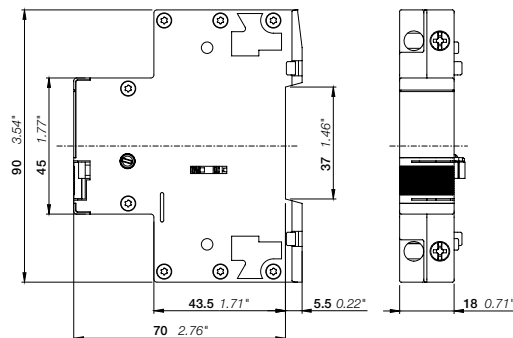

AA1, UA1

Main dimensions mm, inches



## Accessories

### With Push-in Spring terminals

Manual motor starters can be equipped with auxiliary contacts for lateral and front mounting as well as signaling contacts for lateral mounting. The accessories are equipped with Push-in Spring terminals that enable tool-free wiring. A variety of combinations is possible as required for the application. The auxiliary contacts change position with the main contacts. The signaling contact SK1 signals tripping regardless if it was caused by short-circuit or overload. These main accessories are suitable throughout the MS116/MS132/MS165-range.

Suitable for	Auxiliary contacts N.O.	Auxiliary contacts N.C.	Description	Type	Order code	Pkg qty	Weight (1 pce) kg
--------------	-------------------------	-------------------------	-------------	------	------------	---------	----------------------

#### Auxiliary contacts - mountable on the front

MS116, MS132, MS165 MO132, MO165, MS132-T, MS132-K, MS132-KT	1	1		HKF1-11K	1SAM201901R1201	10	0.016
	2	0		HKF1-20K	1SAM201901R1202	10	0.016

#### Auxiliary contacts - mountable on the right

MS116, MS132, MS165 MO132, MO165, MS132-T, MS132-K, MS132-KT	1	1	max. 2 pieces	HK1-11K	1SAM201902R1201	2	0.035
	2	0	max. 2 pieces	HK1-20K	1SAM201902R1202	2	0.035
	0	2	max. 2 pieces	HK1-02K	1SAM201902R1203	2	0.035
	2	0	with leading contacts	HK1-20LK	1SAM201902R1204	2	0.035

#### Signaling contacts - mountable on the right

MS116, MS132, MS165 MO132, MO165, MS132-T, MS132-K, MS132-KT	1	1	for tripped alarm	SK1-11K	1SAM201903R1201	2	0.035
	2	0	for tripped alarm	SK1-20K	1SAM201903R1202	2	0.035
	0	2	for tripped alarm	SK1-02K	1SAM201903R1203	2	0.035



HKF1-11K



HK1-11K



SK1-11K

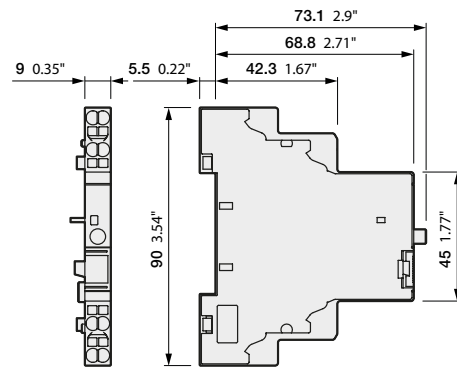

SK1-K

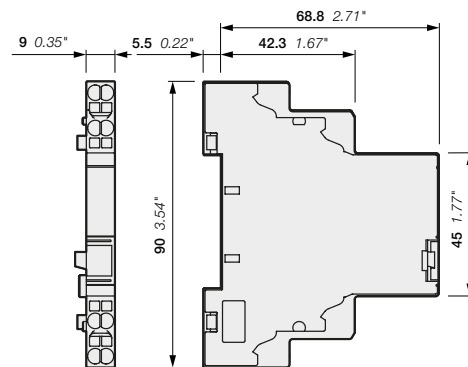

HK1-K

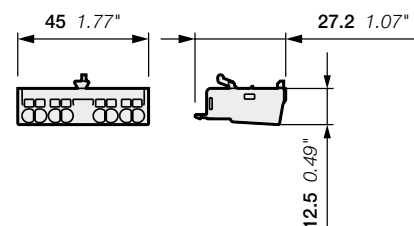

HKF1-K

Main dimensions mm, inches

2CDC131050C0201

## Accessories

MS116, MS132, MS165, MO132, MO165, MS132-T





### General technical data

Type	HK1, SK1	CK1	HKF1
Standards	IEC/EN 60947-1, IEC/EN 60947-5-1		
Rated operational voltage Ue	690 V AC / 600 V DC		250 V AC / 250 V DC
Conventional free-air thermal current Ith	6 A		5 A
Rated frequency	50/60 Hz		
Rated impulse withstand voltage Uimp	6 kV		
Rated insulation voltage Ui	690 V AC		250 V AC
Pollution degree	3		
Ambient air temperature	Operation	-25 ... +60 °C	
	Storage	-50 ... +80 °C	
Resistance to shock acc. to IEC 60068-2-27	25g / 11 ms		
Resistance to vibrations acc. to IEC 60068-2-6	5g / 3 ... 150 Hz		
Ie / Rated operational current AC-15 acc. to IEC/EN 60947-5-1 for utilization category	24 V, 120 V	6 A	3 A
	240 V	4 A	1.5 A
	400 V	3 A	-
	440 V, 690 V	1 A	-
Ie / Rated operational current DC-13 acc. to IEC/EN 60947-5-1 for utilization category	24 V	2 A	1 A
	125 V	0.55 A	0.27 A
	250 V	0.27 A	0.11 A
	440 V, 600 V	0.15 A	-
Minimum switching capacity	17 V / 5 mA		
Short-circuit protective device	N.C., 95-96	10 A Type gG	
	N.O., 97-98	10 A Type gG	
Duty time	100 %		
Mounting	Right side of MMS / MS132-T		Front of MMS / MS132-T
Mounting positions	1-6		
Mechanical durability	100000 cycles	10000 cycles	-
Electrical durability	100000 cycles	10000 cycles	-

### Contact utilization characteristics according to UL/CSA

Type	HK1, SK1, CK1	HKF1
Standards	UL 60947-1, UL 60947-5-1 (UL 508), CSA C22.2 No.60947-5-1 (CSA C22.2 No.14)	
Rated operational voltage Ue acc. to UL/CSA	600 V AC / 600 V DC	
Pilot duty	B600, Q600	B300, R300
AC thermal rated current	5 A	5 A
AC maximum volt-ampere making	3600 VA	3600 VA
AC maximum volt-ampere breaking	360 VA	360 VA
DC thermal rated current	2.5 A	1 A
DC maximum volt-ampere making-breaking	69 VA	28 VA

### Connecting characteristics - Auxiliary circuit

Type	HK1, SK1, CK1	HKF1
Connecting capacity		
 Rigid	1 or 2 x 1 ... 1.5 mm <sup>2</sup>	1 ... 2.5 mm <sup>2</sup>
 Flexible with ferrule	1 or 2 x 0.5 ... 2.5 mm <sup>2</sup> (with Push-in Spring terminals)	
 Flexible with insulated ferrule	1 or 2 x 0.75 ... 1.5 mm <sup>2</sup>	
 Flexible	1 or 2 x 0.5 ... 2.5 mm <sup>2</sup> (with Push-in Spring terminals)	
Stranded acc. to UL/CSA	1 or 2 x 0.75 ... 1.5 mm <sup>2</sup>	
	1 or 2 x 0.5 ... 1.5 mm <sup>2</sup> (with Push-in Spring terminals)	
	1 or 2 x AWG 16-14	
Stripping length	AWG 20 - 14 (with Push-in Spring terminals)	
	8 mm	
Tightening torque	10 mm (with Push-in Spring terminals)	
Recommended screw driver	0.8 ... 1.2 Nm / 7 lb.in	
	Pozidriv 2	
	Flat Ø 3 mm x 0.5 mm (with Push-in Spring terminals)	

## Accessories





MS116, MS132, MS165, MO132, MO165, MS132-T

### General technical data

Type		UA1	AA1
Standards		IEC/EN 60947-1, IEC/EN 60947-5-1, UL 60947-1, UL 60947-5-1 (UL 508), CSA C22.2 No.60947-4-1 (CSA C22.2 No.14)	
Rated control supply voltage		see ordering details	AA1-24: 20-24 V 50/60 Hz; 20-70 V 50/60 Hz ON-Period = 5 s, 20-70 V DC ON-Period = 5 s AA1-100: 110 V 50/60 Hz; 110-200 V 50/60 Hz ON-Period = 5 s, 110-200 V DC ON-Period = 5 s AA1-230: 200-240 V 50/60 Hz, 200-350 V 50/60 Hz ON-Period = 5 s, 200-350 V DC ON-Period = 5 s AA1-400: 350-415 V 50/60 Hz, 350-500 V 50/60 Hz ON-Period = 5 s, 350-500 V DC ON-Period = 5 s
Rated frequency		see ordering details	50/60 Hz, DC
Operating voltage	Tripping	0.35 ... 0.7 x Us	0.7 ... 1.1 x Us
	Coil operating voltage	0.85 ... 1.1 x Us	-
Power consumption	Pull-in	AC	on request
		DC	on request
	Holding	AC	on request
		DC	on request
Rated impulse withstand voltage Uimp		6 kV	6 kV
Rated insulation voltage Ui		690 V	690 V
Pollution degree		3	3
Ambient air temperature	Operation	-25 ... +60 °C	-25 ... +60 °C
	Storage	-50 ... +80 °C	-50 ... +80 °C
Resistance to shock acc. to IEC 60068-2-27		15g / 11 ms	15g / 11 ms
Resistance to vibrations acc. to IEC 60068-2-6		5g / 3 ... 150 Hz	5g / 3 ... 150 Hz
Mounting		left side of MMS / MS132-T	left side of MMS / MS132-T
Mounting positions		-	-

ON-Period: max. 5s actuation time

### Connecting characteristics - Auxiliary circuit

Type		UA1	AA1
Connecting capacity	 Rigid	1 or 2 x	1 ... 4 mm <sup>2</sup>
	 Flexible with ferrule	1 or 2 x	0.75 ... 2.5 mm <sup>2</sup>
	 Flexible with insulated ferrule	1 x	0.75 ... 2.5 mm <sup>2</sup>
		2 x	0.75 ... 1.5 mm <sup>2</sup>
	 Flexible	1 or 2 x	0.75 ... 2.5 mm <sup>2</sup>
Stranded acc. to UL/CSA	1 or 2 x	AWG 16-12	
Stripping length		10 mm	
Tightening torque		0.8 ... 1.2 Nm / 7 lb.in	
Recommended screwdriver		Pozidriv 2	

# Accessories

MS116, MS132, MS165, MO132, MO165

## Manual motor starters with three-phase busbar systems (MS116, MS132, MO132)

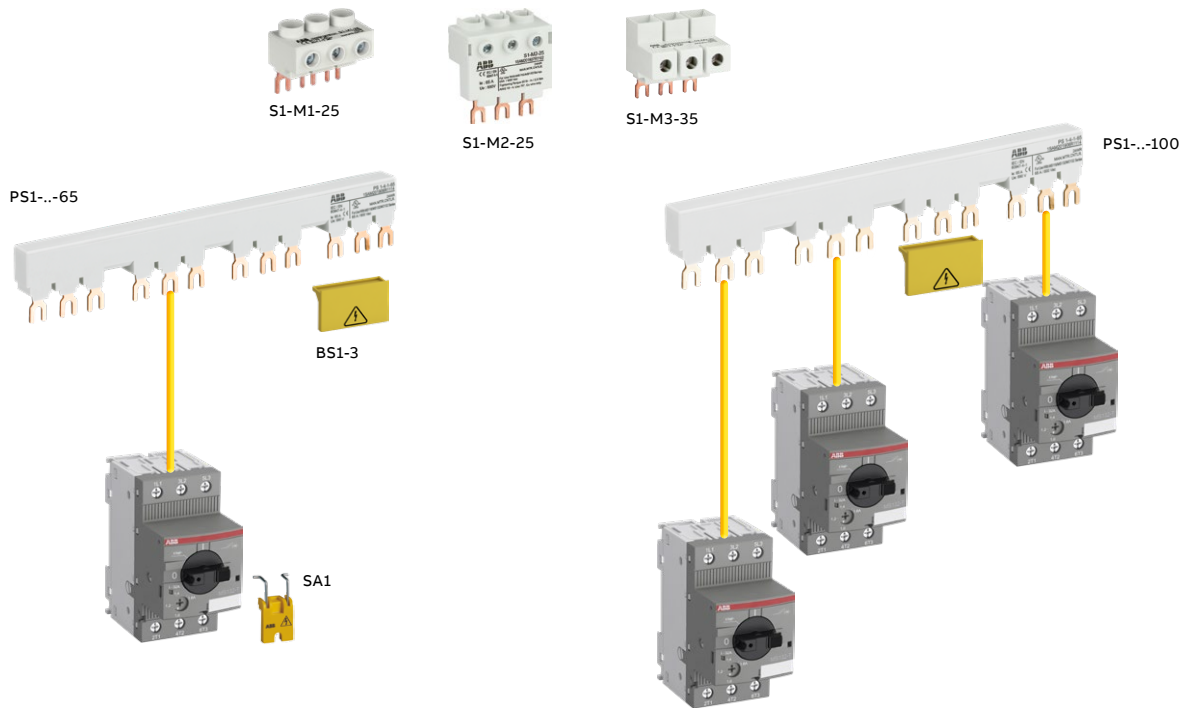

Three-phase busbar up to 65 A

Three-phase busbar up to 100 A

Note: busbars and feeder blocks are only suitable for screw versions.

## Manual motor starters with three-phase busbar systems (MS165, MO165)

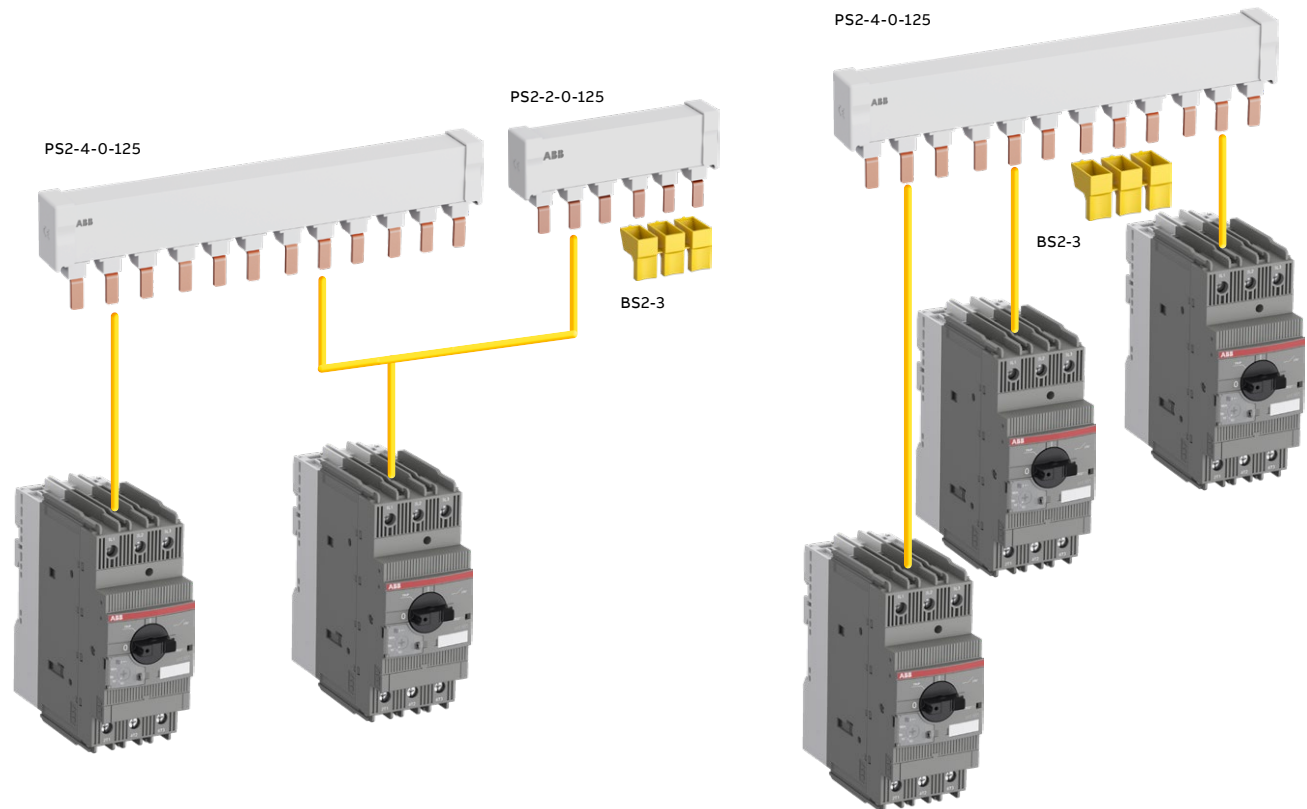

Three-phase busbar up to 125 A

Three-phase busbar up to 125 A

## Accessories

MS116, MS132, MO132, MS132-T

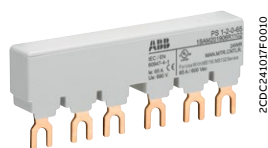

PS1-2-0-65

2CDC24101F0000

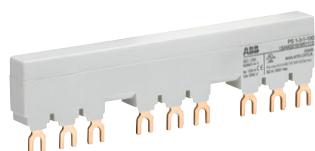

PS1-3-1-100

2CDC241014F0010



S1-M1-25

1SBC10126F0014



S1-M2-25

1SBC10126F0014



SA2



2CDC241023F0013



SA1

5K010891



PB1-1-32

2CDC241004F0014



S1-PB1-25

2CDC241005F0014

Three-phase busbars ensure a quick and safe connection and are therefore a cost effective solution. A variety of different three-phase busbars up to 100 A are in the assortment. Between 2 and 4 manual motor starters with none, one or two lateral auxiliary contacts can be connected. Different three-phase feeder terminals are available according to the application.

Phase connecting links and phase power infeed blocks are also available for single-phase applications.

Suitable for	Rated operational current	Number of manual motor starters	Number of lateral auxiliary contacts	Type	Order code	Pkg qty	Weight (1 pce)
	A						kg

### Three-phase busbars

MS116, MS132, MO132	65	2	0	PS1-2-0-65	1SAM201906R1102	10	0.034
	65	3	0	PS1-3-0-65	1SAM201906R1103	10	0.055
	65	4	0	PS1-4-0-65	1SAM201906R1104	10	0.077
	65	5	0	PS1-5-0-65	1SAM201906R1105	10	0.098
	65	2	1	PS1-2-1-65	1SAM201906R1112	10	0.036
	65	3	1	PS1-3-1-65	1SAM201906R1113	10	0.060
	65	4	1	PS1-4-1-65	1SAM201906R1114	10	0.087
	65	5	1	PS1-5-1-65	1SAM201906R1115	10	0.108
	65	2	2	PS1-2-2-65	1SAM201906R1122	10	0.040
	65	3	2	PS1-3-2-65	1SAM201906R1123	10	0.067
MS116, MS132, MO132	65	4	2	PS1-4-2-65	1SAM201906R1124	10	0.095
	65	5	2	PS1-5-2-65	1SAM201906R1125	10	0.122
	100	3	0	PS1-3-0-100	1SAM201916R1103	10	0.084
	100	4	0	PS1-4-0-100	1SAM201916R1104	10	0.117
	100	5	0	PS1-5-0-100	1SAM201916R1105	10	0.154
	100	3	1	PS1-3-1-100	1SAM201916R1113	10	0.094
	100	4	1	PS1-4-1-100	1SAM201916R1114	10	0.134
	100	5	1	PS1-5-1-100	1SAM201916R1115	10	0.172
	100	3	2	PS1-3-2-100	1SAM201916R1123	10	0.105

Note: busbars are only suitable for screw versions

Suitable for	Rated operational current	Rated cross section	Mounting form	Type	Order code	Pkg qty	Weight (1 pce)
	A	mm <sup>2</sup>					kg

### Three-phase feeder terminals

MS116, MS132, MO132	65	25	Flat	S1-M1-25	1SAM201907R1101	10	0.038
	65	25	High	S1-M2-25	1SAM201907R1102	10	0.051
	65	25	UL/CSA Type E/F and IEC	S1-M3-25	1SAM201907R1103	10	0.042
	100	35	UL/CSA Type E/F and IEC	S1-M3-35	1SAM201913R1103	10	0.060

Suitable for	Description	Type	Order code	Pkg qty	Weight (1 pce)
MS116, MS132, MO132	Protection cover for busbars	BS1-3	1SAM201908R1001	50	0.003
MS116, MS132, MO132, MS132-T	Screw fixing kit	FS116	1SAM201909R1001	1	0.020
MS116	Padlock + two keys	SA2	GJF1101903R0002	10	0.020
	Lock handle	SA1	GJF1101903R0001	10	0.003
	Lock handle box SA1/SA2	SA3	GJF1101903R0003	10	0.050

### Accessories for single-phase connection (IEC only)

MS116, MS132, MO132, MS132-T	Phase connecting link	PB1-1-32	1SAM201914R1001	1	0.009
	Phase power infeed block	S1-PB1-25	1SAM201914R1002	1	0.013

# Accessories

## MS165, MO165

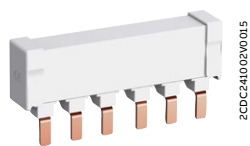

PS2-2-0-125

2CDC41020V0015



PS2-3-0-125

2CDC41030V0015



KA165

2CDC41010V0014

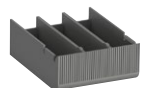

BS2-3

2CDC41001V0015



SA2

2CDC41023F0013

Three-phase busbars ensure a quick and safe connection and are therefore a cost effective solution. A variety of different three-phase busbars up to 125 A are in the assortment. Between 2 and 4 manual motor starters with none, one or two lateral auxiliary contacts can be connected.

Suitable for	Rated operational current	Number of Manual motor starters	Number of lateral auxiliary contacts	Type	Order code	Pkg qty	Weight (1 pce)
	A						kg

### Three-phase busbars

Suitable for	Rated operational current	Number of Manual motor starters	Number of lateral auxiliary contacts	Type	Order code	Pkg qty	Weight (1 pce)
MS165, MO165	125	2	0	PS2-2-0-125	1SAM401920R1002	10	0.100
	125	3	0	PS2-3-0-125	1SAM401920R1003	10	0.162
	125	4	0	PS2-4-0-125	1SAM401920R1004	10	0.226
	125	2	2	PS2-2-2-125	1SAM401920R1022	10	0.117
	125	3	2	PS2-3-2-125	1SAM401920R1023	10	0.197
	125	4	2	PS2-4-2-125	1SAM401920R1024	10	0.277

Other busbar types on request.

Suitable for	Description	Type	Order code	Pkg qty	Weight (1 pce)
MS165, MO165	Terminal shroud	KA165	1SAM401922R1001	10	0.025
	Protection cover for busbars	BS2-3	1SAM401921R1001	10	0.005
	Padlock + two keys	SA2	GJF1101903R0002	10	0.020







## Accessories

MS116, MS132, MS165, MO132, MO165

### General technical data

Type	PS1-xxx-65	PS1-xxx-100	PS2-xxx-125	S1-Mx-25	S1-Mx-35
Standards	IEC/EN 60947-4-1, IEC/EN 60947-1, UL 60947-1, UL 60947-4-1 (UL 508), CSA C22.2 No.60947-4-1 (CSA C22.2 No.14)				
Rated operational voltage U <sub>e</sub>	690 V				
Rated operational voltage U <sub>e</sub> acc. to UL/CSA	600 V AC				
Rated operational current I <sub>e</sub>	65 A	100 A	125 A	65 A	100 A
Rated operational current I <sub>e</sub> acc. to UL/CSA	65 A	92 A	125 A	65 A	92 A
Rated frequency	50/60 Hz				
Rated impulse withstand voltage U <sub>imp</sub>	6 kV				
Rated insulation voltage U <sub>i</sub>	690 V AC				
Pollution degree	3				
Cross-section	10 mm <sup>2</sup>	16 mm <sup>2</sup>	25 mm <sup>2</sup>	25 mm <sup>2</sup>	35 mm <sup>2</sup>
Ambient air temperature	Operation	-25 ... +70 °C			
	Storage	-50 ... +80 °C			
Resistance to shock acc. to IEC 60068-2-27	25g / 11 ms				
Resistance to vibrations acc. to IEC 60068-2-6	5g / 3 ... 150 Hz				

### Electrical connection - Main circuit

Type	S1-Mx-25	S1-Mx-35
Connecting capacity		
 Rigid	1 x 6 ... 25 mm <sup>2</sup>	10 ... 35 mm <sup>2</sup>
 Flexible with ferrule	1 x 6 ... 16 mm <sup>2</sup>	10 ... 35 mm <sup>2</sup>
 Flexible with insulated ferrule	1 x 6 ... 16 mm <sup>2</sup>	10 ... 35 mm <sup>2</sup>
 Flexible	1 x 6 ... 16 mm <sup>2</sup>	10 ... 35 mm <sup>2</sup>
Stranded acc. to UL/CSA	1 x AWG 10-4	AWG 8-2
Stripping length	10 mm	12 mm
Tightening torque	2.5 Nm / 22 lb.in	4.5 Nm / 40 lb.in
Recommended screwdriver	Pozidriv 2	Hexagon SW4

## Accessories

### MS116, MS132, MO132



2CDC241004F0010

IB132-Y



2CDC241003F0010

IB132-G



2CDC241002F0010

DMS132-Y



2CDC241001F0010

DMS132-G

IB132 are IP65 (NEMA Type 12) enclosures for single manual motor starter installation. Additional mounting of auxiliary and signaling contacts, shunt trips and undervoltage release is possible. The handle is lockable in OFF position. For detailed specification see installation instruction.

DMS132 are IP65 (NEMA Type 12) door mounting kits for manual motor starter installation in any enclosure. Additional mounting of auxiliary, signaling, shunt trips and undervoltage release is possible. The handle is lockable in OFF position. For detailed specification see installation instruction.

Suitable for	Description	Color	Type	Order code	Pkg qty	Weight (1 pce) kg
--------------	-------------	-------	------	------------	---------	-------------------

#### IP65 enclosures (NEMA Type 12)

MS116, MS132, MO132	Padlockable max. 3 padlocks with bail diameter 4 ... 6.5 mm	Yellow/red	IB132-Y	1SAM201911R1011	1	0.370
		Grey/black	IB132-G	1SAM201911R1010	1	0.370

#### IP65 door mounting kits (NEMA Type 12)

MS116, MS132, MO132	Padlockable max. 3 padlocks with bail diameter 4 ... 6.5 mm	Yellow/red	DMS132-Y	1SAM201912R1011	1	0.170
		Grey/black	DMS132-G	1SAM201912R1010	1	0.170

Indication I-O-T and ON-OFF-T.

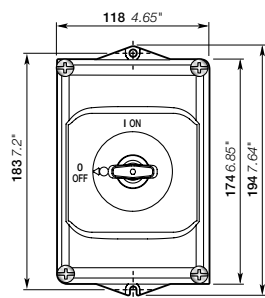

IB132

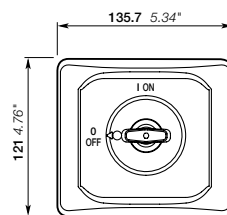
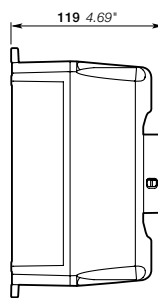

DMS132

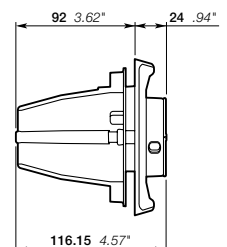

Main dimensions mm, inches

## Accessories

MS116, MS132, MS165, MO132, MO165



MSHD-LB

2CDC241003R0011



MSHD-LY

2CDC241002S0011



MSMN

2CDC241004F0011



MSH-AR

2CDC241001F0012

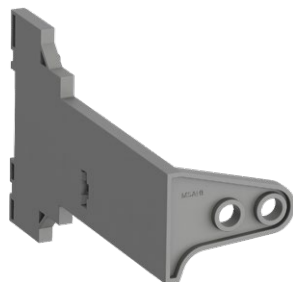

MSAH1

2CDC241017V0013

With this solution of door coupling rotary mechanisms it is possible to operate manual motor starters in the back of a switch cabinet from outside. The door coupling mechanism prevents opening of the door of a switch cabinet with the manual motor starter in ON position.

The complete mechanism includes handle, shaft, driver, shaft alignment ring and shaft supporter.

Most accessories fit for 6 mm shafts with a maximum length of 180 mm. The degree of protection for handles MSHD is IP64 (NEMA Type 1, 3R, 12).

Suitable for	Description	Shaft length mm	Color	Type	Order code	Pkg qty pce	Weight (1 pce) kg
--------------	-------------	-----------------	-------	------	------------	-------------	-------------------

### Shafts

MS116,	For MSHD handles. Shaft diameter	85		OXS6X85	1SCA101647R1001	1	0.020
MS132,	6 mm. Shaft extension for door	105		OXS6X105	1SCA108043R1001	1	0.020
MO132,	coupling driver.	130		OXS6X130	1SCA101655R1001	1	0.030
MS165,		180		OXS6X180	1SCA101659R1001	1	0.040
MO165							

### IP64 handles (NEMA Type 1, 3R, 12)

MS116,	Padlockable max. 3 padlocks		Black	MSHD-LB (1)	1SAM201920R1001	1	0.065
MS132,	with bail diameter 5 ... 8 mm, door		Yellow	MSHD-LY (1)	1SAM201920R1002	1	0.065
MO132,	interlock in ON position		Black	MSHD-LTB (2)	1SAM201920R1011	1	0.065
MS165,	defeatable, for use with 6 mm		Yellow	MSHD-LTY (2)	1SAM201920R1012	1	0.065
MO165	OXS6...types up to 180 mm or driver shafts MSOX.						

### Driver

MS116,	Coupling driver for use			MSMN (3)	1SAM101923R0002	1	0.002
MS132,	with 6 mm OXS6... types			MSMNO (4)	1SAM101923R0012	1	0.002
MO132,	up to 180 mm.						
MS165,							
MO165							

### Shaft alignment ring

MS116,	The MSH-AR supports the long shafts for alignment to the handle inlet. It makes closing panel doors			MSH-AR	1SAM201920R1000	1	0.010
MS132,	more easy. Use for OXS6X > 105 mm.						
MO132,							
MS165,							
MO165							

### Shaft supporter

MS116,	With the MSAH1 it is possible to support the shaft in the extension of handle (MSHD). It is mandatory for the usage of shafts >130 mm.			MSAH1	1SAM201909R1021	1	0.035
MS132,							
MO132							

(1) Indication I-O and ON-OFF (recommended for MS116)

(2) Indication I-O and ON-OFF + Trip indication

(3) Coded - Positioning of ON indication dependent on mounting orientation of the MMS

(4) Uncoded - Positioning of ON indication independent of mounting orientation of the MMS.

## Accessories

MS116, MS132, MS165, MO132, MO165

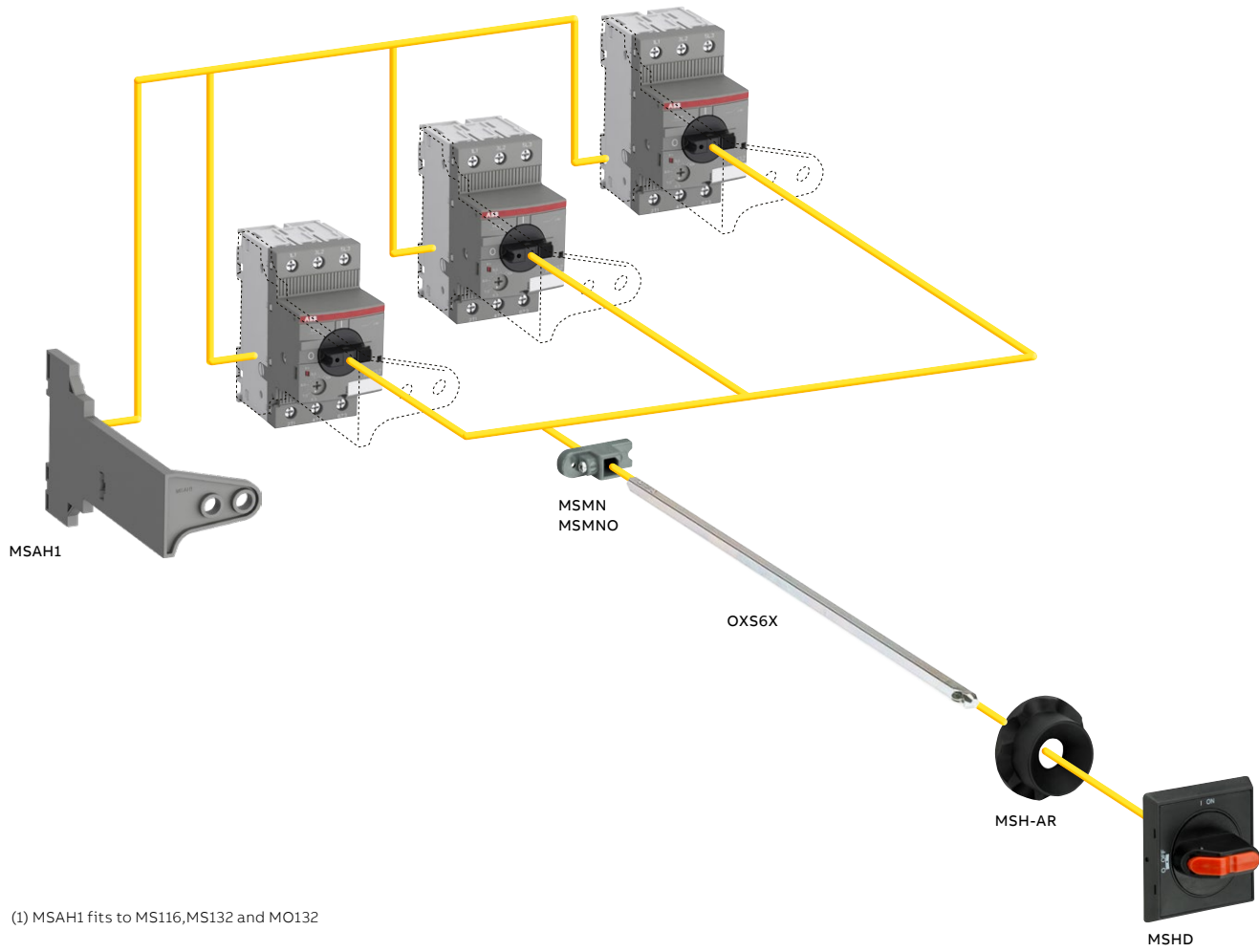

(1) MSAH1 fits to MS116,MS132 and MO132

—  
**Notes**

A large rectangular area filled with a grid of small, light gray dotted lines, intended for handwritten notes.



**For direct product details information, use product type or order code, ex:**

[www.abb.com/productdetails/AF09-30-10-13](http://www.abb.com/productdetails/AF09-30-10-13)  
or  
[www.abb.com/productdetails/1SBL137001R1310](http://www.abb.com/productdetails/1SBL137001R1310)



---

# AF, EK contactors and NF contactor relays

<b>3/3</b>	<b>Overview</b>
<b>3/11</b>	<b>AF 3-pole contactors</b>
<b>3/81</b>	<b>AF..K 3-pole contactors with Push-in Spring terminals</b>
<b>3/107</b>	<b>AFS 3-pole contactors for safety applications</b>
<b>3/131</b>	<b>AF and EK 4-pole contactors</b>
<b>3/169</b>	<b>GAF Contactors for DC switching</b>
<b>3/191</b>	<b>UA..RA Contactors for capacitor switching</b>
<b>3/207</b>	<b>NF 4-pole and 8-pole contactor relays</b>
<b>3/227</b>	<b>Accessories for AF09 ... AF2850 3-pole contactors, AF09 ... AF370 4-pole contactors and NF contactor relays</b>
<b>3/271</b>	<b>Accessories for UA, UA..RA contactors and GA75, GAE75, GAF contactors</b>
<b>3/297</b>	<b>Accessories for EK550, EK1000 4-pole contactors</b>
<b>3/309</b>	<b>Terminal marking and positioning</b>
<b>3/321</b>	<b>Dimensions</b>
<b>3/385</b>	<b>Other contactor application data</b>
<b>3/404</b>	<b>Voltage code table</b>
<b>3/409</b>	<b>Questionnaire for product specifications</b>



# AF contactors for motor starting and power switching up to 2850 A



The latest technology of electronically controlled coil is our standard. It offers multiple benefits over conventional alternatives, and together with ABB's wide product offering, it is an optimal configuration, every time.



## Optimized logistics

### Cut your costs

With its contactor and motor protection range, ABB has managed to reduce the number of contactor coils to just four.

Total number of product variants has been reduced by up to 90%. This simplifies the customers' logistics while cutting storage and administration costs.



## Continuous operation

### Secure uptime

Prevent stoppages caused by voltage fluctuations. The AF contactor ensures distinct operation in unstable networks and signifies a major advance in motor control and power switching. Voltage sags, dips and surges pose no threat. The AF contactor secures your uptime.



## Speed up your projects

### Simplify design

Use the same part number in Europe, Asia and North America as one contactor coil now handles 100 V – 250 V AC / DC, 50 / 60 Hz.

By reducing contactor coil energy consumption by up to 80%, panels can be built smaller and transformers more compact.

# AF technology

## Main Benefits

03



### Conventional AC coil

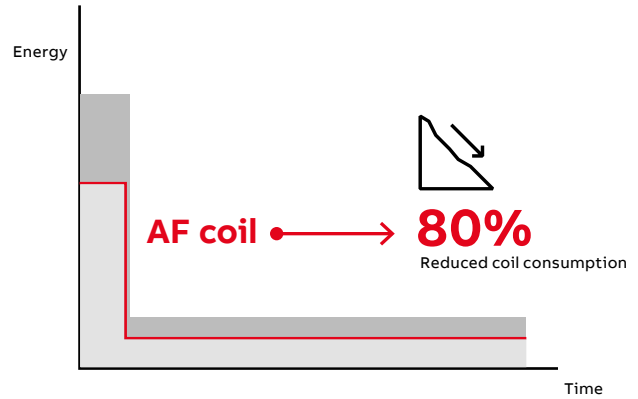

### Reliable in all networks

The electronic system within the AF contactor continuously monitor the current and voltage apply to the coil. The contactor is safely operated in an always optimized condition and hum free.

### Reduced coil consumption

AF coil and energy consumption is reduced up to 80%. This allows a reduction of the temperature rise, the size of control transformers and size of cabinets.

### AF coil

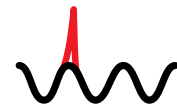
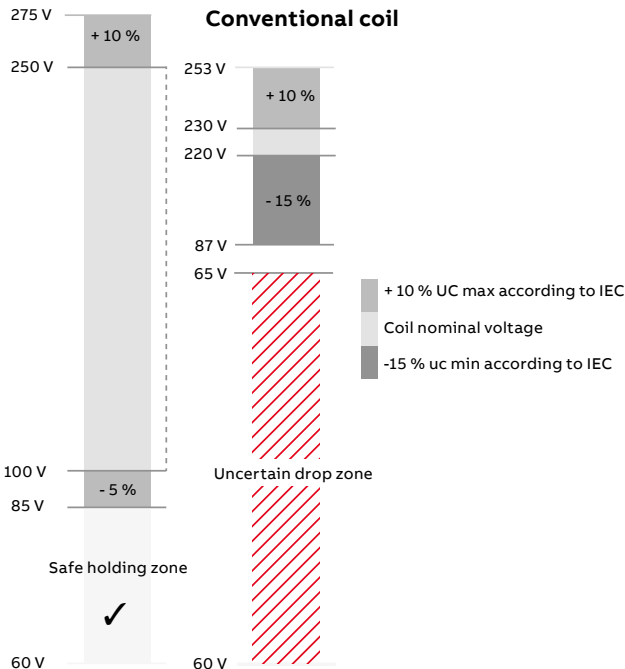

### Wide control voltage range

With conventional contactor technology, different contactors are needed for different network voltages. Thanks to the wide operating range of the AF contactor, it can operate just as well in Europe as in Asia or North America. The core coil of the AF contactor range covers 100-250 V AC / DC, 50 / 60 Hz.

### Built-in surge suppression

With conventional contactor technology, it is recommended to use an external surge suppressor, an accessory that could cost as much as half of the contactor. With the AF technology, the surges are handled by the contactor and never reach the control circuit. One less product and one less complication to worry about.

# Select AF contactor dedicated to your control circuit application



### Direct coil control

Contactor coils are operated directly with an auxiliary contact or PLC-output or indirectly through an interface relay. For direct coil control, the switching capacity of coil operating device (auxiliary contact, solid state PLC-output, ...) must be verified versus the coil consumption at closing and at holding.

## AF09...AF2850 - 4 to 400kW - AC / DC operated

	AF09...AF370	Coil code
+10%	24...60 V AC / DC	11
	48...130 V AC / DC	12
	100...250 V AC / DC	13
	250 V...500 V AC / DC	14
-15%	AF400...AF1250	
	24...60 V DC	68
	48...130 V AC / DC	69
	100...250 V AC / DC	70
	250 V...500 V AC / DC	71
	AF1350...AF2850	
	100...250 V AC / DC	70

- AC / DC operation
- Wide control voltage range
- With built-in surge protection

## AF09Z...AF38Z designed for PLC - 4 to 18.5 kW - 24 V DC operated

Voltage range	Coil code
24 V DC	30

- Allow direct control by 24 V DC  $\geq$  250 mA PLC-output
- Pull-in consumption 6 W 250 mA
- Holding consumption 1.7 W
- NO contact opening time 29 ms and closing time 53 ms
- With built-in surge protection

## AF09Z...AF38Z for specific applications - 4 to 18.5 kW - AC / DC operated

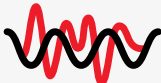

Voltage range	Coil code
12...60 V DC	20
24...60 V AC / DC	21
48...130 V AC / DC	22
100 V...250 V AC / DC	23

- Coil 20 covers 12 ... 20 V DC applications
- Coil allow direct control by 24 V DC  $\geq$  500 mA PLC-output
- Coil 21, 22 and 23 can withstand short voltage sags and dips with reference to SEMI F47 conditions of use
- With built-in surge protection

# Select your AF coil interface for PLC

## For contactors up to 2850 A AC-1 / General use

Coil interfaces are offered to operate all contactor size up to AF2850 with very low PLC output signals. They allow a galvanic isolation between the PLC circuit and the contactor coil circuit.

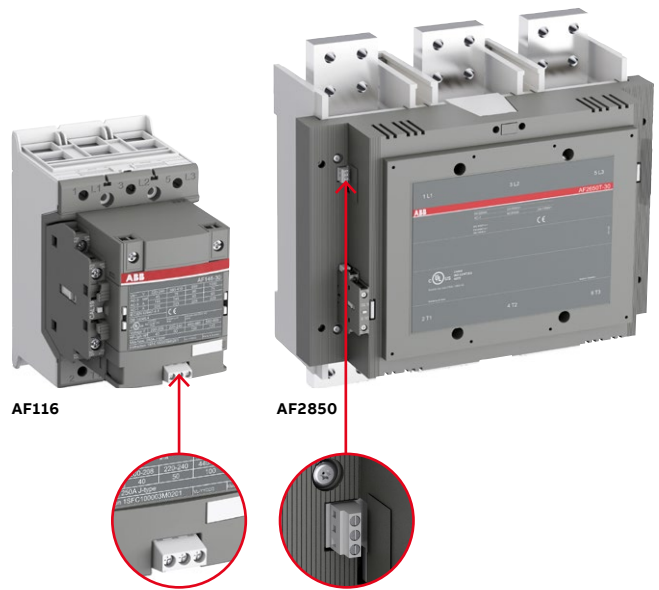
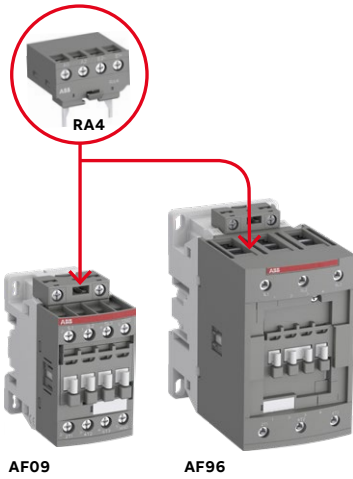

### Interface relay

For control with 24 V DC  $\geq$  20 mA PLC output. RA4 interface relay can be used for rated control circuit voltages  $U_c$  24 ... 250 V 50/60Hz and 24 V DC with the standard AF contactors up to 45kW - 400 V / 60hp - 480 V and with NF contactor relays.

### Built-in PLC interface

For control with 24 V DC  $\geq$  10 mA PLC output. The built-in PLC interface operates the 100 ... 250 V AC / DC or 250 ... 500 V AC / DC AF contactor coil. Available for AF contactors from 55 kW - 400 V / 75 hp up to 560 kW - 400 V / 900 hp 480 V and up to 2850 A AC-1 / General use. Dedicated coil code from AF116 up to AF370 and standard feature from AF400 up to AF2850.

### Control circuit with interface relay

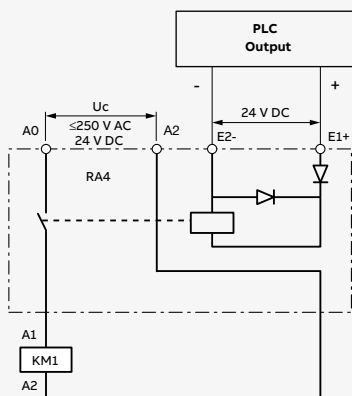

### Control inputs with PLC plug

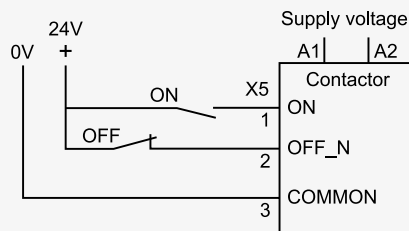



# Contactors and motor protection

## Advanced but simple

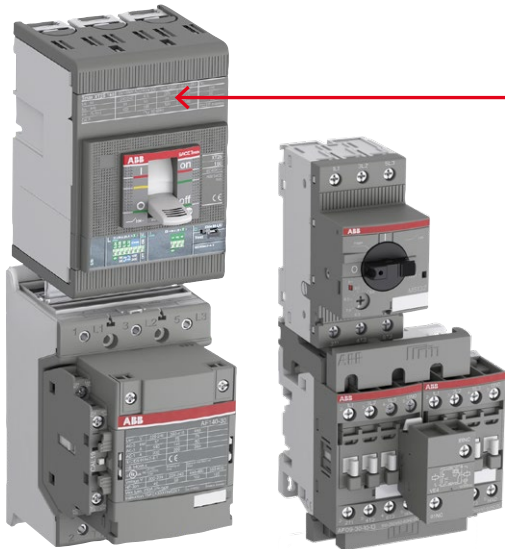

**Easy, fast and secure starters assembly**  
 The AF contactor range is perfect for motor starting applications and for solutions where space is limited. You can create any motor starting type and save assembly time with a complete range of accessories and connection sets.

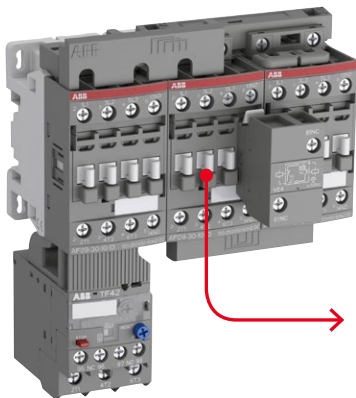

**Protect from overload in all conditions**  
 Select thermal overload relays (trip class 10) or electronic overload relays (trip class 10E, 20E, 30E in the same product) to protect your motors against overload and phase failure.

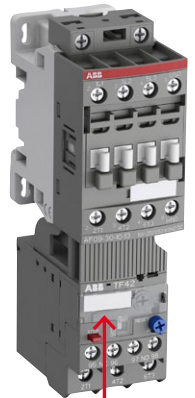

**Compact size**  
 The AF contactor is compact in size and has had its width reduced by up to 30% thanks to an 80% coil consumption reduction.



**Save space**  
 Interlocking reversing pairs require no spacing between contactors, meaning you can fit more functionality into cabinets or other enclosures.

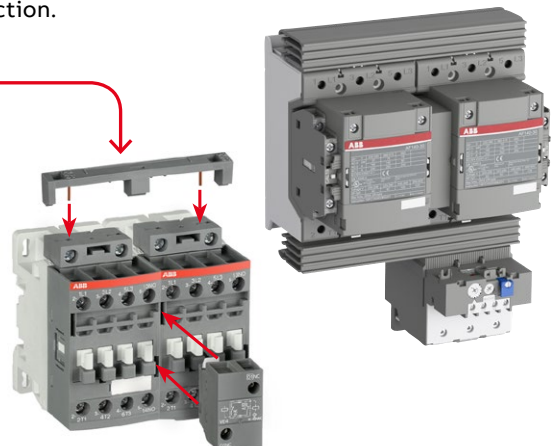

# Contactors and motor protection

## Flexible and safe

### Easy to use accessories

#### Up to 96 A

**Great flexibility for coil terminal access**  
Contactors offer free choice of coil terminal access from top, bottom, both top and bottom or front.

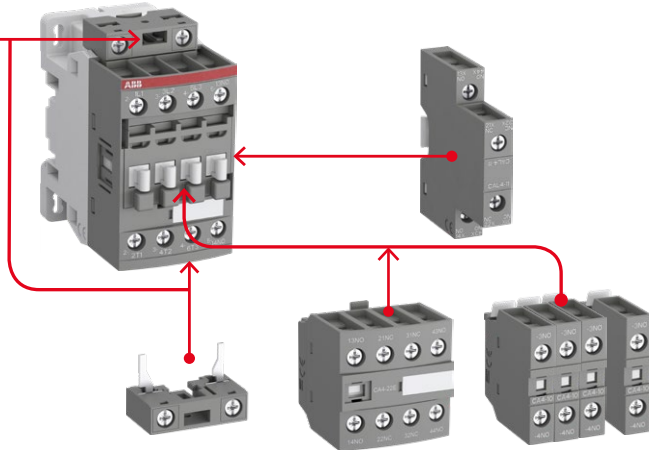

**Easy to use accessories**  
1-pole, 2-pole and 4-pole auxiliary contact blocks, front or side mounted, are available for a great flexibility.

#### Up to 2850 A

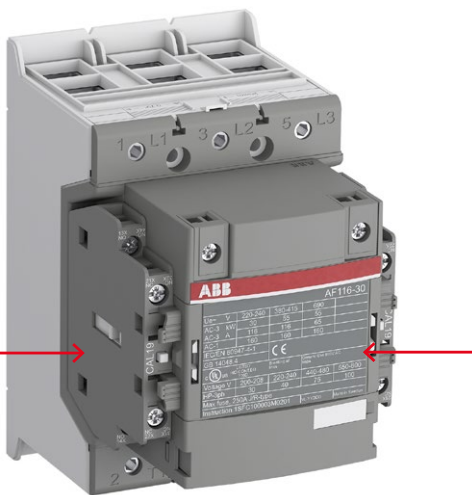

**2 side mounted auxiliary contact blocks**  
AF116 ... AF2850 contactors can take up to 2 side mounted auxiliary contact blocks without adding to its width. Coil connection terminals, mechanical and electrical interlocks and electronic timers are easily connected through the snap-to-connect function.

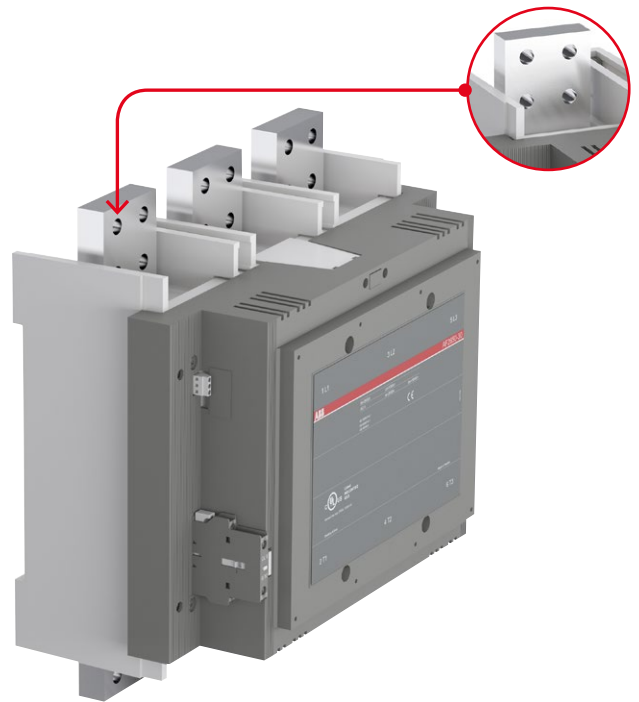

**Simple connection and maintenance**  
The main terminals of AF116 ... AF2850 contactors are at the contactors' back to facilitate your bus bars connections. It also allows easy contact inspection and maintenance from AF400 and above.

—  
**Notes**

A large rectangular area filled with a grid of small, light gray dotted lines, intended for handwritten notes.





# AF 3-pole contactors

## 3/12 Overview

### Ordering details

#### 4 to 200 kW

3/14	AF09 ... AF38	AC / DC operated
3/15	AF09Z ... AF38Z	24 V DC operated designed for PLC
3/16	AF09Z ... AF38Z	AC / DC operated for specific applications
3/17	AF40 ... AF96	AC / DC operated
3/18	AF09 ... AF96	Contactors and main accessories
3/19	AF116 ... AF146	AC / DC operated
3/20	AF116 ... AF146	AC / DC operated with built-in PLC interface
3/21	AF190 ... AF370	AC / DC operated
3/22	AF190 ... AF370	AC / DC operated with built-in PLC interface
3/23	AF116 ... AF370	Contactors and main accessories

#### 4 to 560 kW (up to 2850 A AC-1) - with 1 N.O. + 1 N.C.

3/24	AF26 ... AF38	AC / DC operated
3/25	AF26Z ... AF38Z	AC / DC operated for specific applications
3/26	AF26 ... AF38	Contactors and main accessories
3/27	AF40 ... AF96	AC / DC operated
3/28	AF40 ... AF96	Contactors and main accessories
3/29	AF116 ... AF146	AC / DC operated
3/30	AF116 ... AF146	AC / DC operated with built-in PLC interface
3/31	AF190 ... AF370	AC / DC operated
3/32	AF190 ... AF370	AC / DC operated with built-in PLC interface
3/33	AF116 ... AF370	Contactors and main accessories
3/34	AF400 ... AF750	AC / DC operated
3/35	AF1250 ... AF2850	AC / DC operated
3/36	AF1350T ... AF2850T	AC / DC operated
3/37	AF400 ... AF2850	Main accessories

#### 4 to 560 kW (up to 2850 A AC-1) - with 2 N.O. + 2 N.C.

3/38	AF09 ... AF38	AC / DC operated
3/39	AF09Z ... AF38Z	AC / DC operated for specific applications
3/40	AF40 ... AF96	AC / DC operated
3/41	AF09 ... AF96	Contactors and main accessories
3/42	AF116 ... AF146	AC / DC operated
3/43	AF116 ... AF146	AC / DC operated with built-in PLC interface
3/44	AF190 ... AF370	AC / DC operated
3/45	AF190 ... AF370	AC / DC operated with built-in PLC interface
3/46	AF116 ... AF370	Contactors and main accessories
3/47	AF400 ... AF750	AC / DC operated
3/48	AF1250 ... AF2850	AC / DC operated
3/49	AF400 ... AF2850	Contactors and main accessories

## 3/50 Technical data

## 3/74 Electrical durability



For direct product details information, use product type or order code, ex:

or [www.abb.com/productdetails/AF09-30-10-13](http://www.abb.com/productdetails/AF09-30-10-13)  
[www.abb.com/productdetails/1SBL137001R1310](http://www.abb.com/productdetails/1SBL137001R1310)

# 3-pole contactors, for motor control and power switching

03



AC / DC Control supply			Type	AF09	AF12	AF16	AF26	AF30	AF38	AF40	AF52	AF65	AF80	AF96	
IEC	AC-3	Rated operational power	220 - 230 - 240 V	kW	2.2	3	4	6.5	9	11	11	15	18.5	22	25
			380 - 400 V	kW	4	5.5	7.5	11	15	18.5	18.5	22	30	37	45
		θ ≤ 60 °C for AF09 ... AF370 θ ≤ 55 °C for AF400 ... AF2650	415 V	kW	4	5.5	9	11	15	18.5	22	30	37	45	55
			440 V	kW	4	5.5	9	15	18.5	22	22	30	37	45	55
			500 V	kW	5.5	7.5	9	15	18.5	22	22	30	37	45	55
		690 V	kW	5.5	7.5	9	15	18.5	22	22	30	37	45	55	
		1000 V	kW	—	—	—	—	—	—	—	—	—	—	35	40
Rated operational current	380 - 400 V	A	9	12	18	26	32	38	40	53	65	80	96		
AC-1	Rated operational current	θ ≤ 40 °C, 690 V	A	25	28	30	45	50	50	70	100	105	125	130	

UL / CSA	1-phase motor rating	120 V	hp	0.75	1	1.5	2	2	2	3	3	5	7.5	7.5	
		240 V	hp	1.5	2	3	3	5	5	7.5	10	15	15	20	
	3-phase motor rating	200 - 208 V	hp	2	3	5	7.5	10	10	10	15	20	25	30	30
		220 - 240 V	hp	2	3	5	7.5	10	10	15	20	25	30	30	
		440 - 480 V	hp	5	7.5	10	15	20	25	30	40	50	60	60	
	550 - 600 V	hp	7.5	10	15	20	25	30	40	50	60	75	75		
General use rating	600 V	A	25	28	30	45	50	50	60	80	90	105	115		
NEMA	NEMA Size			00	0	—	1	—	—	2	—	—	3	—	

### Main accessories

Auxiliary contact blocks	Front mounting	CA4-10 (1 x N.O.) CA4-01 (1 x N.C.)
	Side mounting	CAL4-11 (1 x N.O. + 1 x N.C.)
Timers	Electronic	TEF4-ON TEF4-OFF
	Mechanical	VM4
Interlocking units	Mechanical / Electrical	VEM4
	For reversing contactors	BER16-4
Connection sets		BER38-4
Surge suppressors		Built-in surge protection
		BER65-4
		BER96-4

### Overload relays

	Thermal relays	Class 10 (Class 10A for TF140, TA200DU)	TF42 (0.10...38 A)	TF65 (22...67 A)	TF96 (40...96 A)
	Electronic relays	Class 10E, 20E, 30E	EF19 (0.10...18.9 A)	EF19 (0.10...18.9 A) EF45 (9...45 A)	EF65 (20...70 A)

### Manual motor starters

	Thermal / magnetic protection Class 10	MS116 (0.10...32 A) lcs up to 50 kA for class 10 A	MS165 (10...80 A) lcs up to 100 kA (1)
	Magnetic only types	MS132 (0.10...32 A) lcs up to 100 kA	MO165 (16...80 A) lcs up to 100 kA (1)
Accessories	For contactor mounting	BEA16-4	BEA38-4
			BEA65-4 (2)

(1) MS165/MO165 are suitable for use with AF09 ... AF30 for North American applications.

(2) BEA65-4 suitable for MS165 and MO165 only.





AF116	AF140	AF146	AF190	AF205	AF265	AF305	AF370	AF400	AF460	AF580	AF750	AF1250	AF1350	AF1650	AF2050	AF2650	AF2850
30	37	45	55	55	75	90	110	110	132	160	220	—	257	315	—	—	—
55	75	75	90	110	132	160	200	200	250	315	400	—	475	560	—	—	—
55	75	75	90	110	132	160	200	220	250	355	425	—	500	630	—	—	—
75	90	90	110	132	160	160	200	220	250	355	450	—	560	710	—	—	—
75	90	90	110	132	160	200	250	250	315	400	520	—	560	710	—	—	—
55	75	90	132	160	200	250	315	315	355	500	600	—	800	1000	—	—	—
—	—	75	110	132	160	185	200	220	280	355	400	—	—	—	—	—	—
116	140	146	190	205	265	305	370	400	460	580	750	—	860	1060	—	—	—
160	200	225	275	350	400	500	600	600	700	800	1050	1260	1350	1650	2050	2650	2850

—	—	—	—	—	—	—	—	—	—	—	—	—	—	—	—	—	—
—	—	—	—	—	—	—	—	—	—	—	—	—	—	—	—	—	—
30	40	40	50	60	75	100	125	125	150	200	250	—	—	—	—	—	—
40	50	50	60	75	100	125	150	150	200	250	300	—	400	450	—	—	—
75	100	100	125	150	200	250	300	350	400	500	600	—	800	900	—	—	—
100	125	125	150	200	250	300	350	400	500	600	700	—	1000	1150	—	—	—
160	200	200	250	300	350	400	520	550	650	750	900	1210	1350	1650	2100	2700	2850
—	4	—	—	—	5	—	—	—	6	—	7	—	—	8	—	—	—

CAL19-11 (1 x N.O. + 1 x N.C.)				CAL18-11 (1 x N.O. + 1 x N.C.)										
VM19 (for same size contactors)				VM750H VM750V				VM1650H						
BER140-4			BER205-4			BER370-4			BEM460-30			BEM750-30		

TF140DU (66...142 A) $\theta \leq 55^\circ\text{C}$		TA200DU (66...200 A) $\theta \leq 55^\circ\text{C}$											
EF146 (54...150 A)		EF205 (63...210 A)		EF370 (115...380 A)		EF460 (150...500 A)		EF750 (250...800 A)		EF1250DU (350...1250 A)			

# AF09 ... AF38 3-pole contactors

4 to 18.5 kW

AC / DC operated



AF09-30-10



AF26-30-00

AF09 ... AF38 contactors are mainly used for controlling 3-phase motors and power circuits up to 690 V AC and 220 V DC. These contactors are of the block type design with 3 main poles.

- control circuit: AC or DC operated with electronic coil interface accepting a wide control voltage range (e.g. 100...250 V AC and DC), only 4 control voltage ranges covering 24...500 V 50/60 Hz and 20...500 V DC
  - can manage large control voltage variations
  - reduced panel energy consumption
  - very distinct closing and opening.
- built-in surge suppression
- add-on auxiliary contact blocks for front or side mounting and a wide range of accessories.

IEC Rated operational power 400 V AC-3 kW	UL/CSA 3-phase motor rating 480 V AC-1 A	General use rating 600 V AC hp	General use rating A	Rated control circuit voltage Uc min. ... Uc max.		Auxiliary contacts fitted	Type	Order code	Weight Pkg (1 pce) kg				
				V 50/60 Hz	V DC								
4	25	5	25	24...60	20...60 (1)	1 0	AF09-30-10-11	1SBL137001R1110	0.270				
							AF09-30-01-11	1SBL137001R1101	0.270				
				48...130	48...130	1 0	AF09-30-10-12	1SBL137001R1210	0.270				
							AF09-30-01-12	1SBL137001R1201	0.270				
				100...250	100...250	1 0	AF09-30-10-13	1SBL137001R1310	0.270				
							AF09-30-01-13	1SBL137001R1301	0.270				
				250...500	250...500	1 0	AF09-30-10-14	1SBL137001R1410	0.310				
							AF09-30-01-14	1SBL137001R1401	0.310				
				5.5	28	7.5	28	24...60	20...60 (1)	1 0	AF12-30-10-11	1SBL157001R1110	0.270
											AF12-30-01-11	1SBL157001R1101	0.270
48...130	48...130	1 0	AF12-30-10-12					1SBL157001R1210	0.270				
			AF12-30-01-12					1SBL157001R1201	0.270				
100...250	100...250	1 0	AF12-30-10-13					1SBL157001R1310	0.270				
			AF12-30-01-13					1SBL157001R1301	0.270				
250...500	250...500	1 0	AF12-30-10-14					1SBL157001R1410	0.310				
			AF12-30-01-14					1SBL157001R1401	0.310				
7.5	30	10	30					24...60	20...60 (1)	1 0	AF16-30-10-11	1SBL177001R1110	0.270
											AF16-30-01-11	1SBL177001R1101	0.270
				48...130	48...130	1 0	AF16-30-10-12	1SBL177001R1210	0.270				
							AF16-30-01-12	1SBL177001R1201	0.270				
				100...250	100...250	1 0	AF16-30-10-13	1SBL177001R1310	0.270				
							AF16-30-01-13	1SBL177001R1301	0.270				
				250...500	250...500	1 0	AF16-30-10-14	1SBL177001R1410	0.310				
							AF16-30-01-14	1SBL177001R1401	0.310				
				11	45	15	45	24...60	20...60 (1)	0 0	AF26-30-00-11	1SBL237001R1100	0.310
											AF26-30-00-12	1SBL237001R1200	0.310
48...130	48...130	0 0	AF26-30-00-13					1SBL237001R1300	0.310				
			AF26-30-00-14					1SBL237001R1400	0.350				
100...250	100...250	0 0	AF30-30-00-11					1SBL277001R1100	0.310				
			AF30-30-00-12					1SBL277001R1200	0.310				
250...500	250...500	0 0	AF30-30-00-13	1SBL277001R1300	0.310								
			AF30-30-00-14	1SBL277001R1400	0.350								
15	50	20	50	24...60	20...60 (1)	0 0	AF38-30-00-11	1SBL297001R1100	0.310				
							AF38-30-00-12	1SBL297001R1200	0.310				
				48...130	48...130	0 0	AF38-30-00-13	1SBL297001R1300	0.310				
							AF38-30-00-14	1SBL297001R1400	0.350				
				100...250	100...250	0 0	AF38-30-00-11	1SBL297001R1100	0.310				
							AF38-30-00-12	1SBL297001R1200	0.310				
250...500	250...500	0 0	AF38-30-00-13	1SBL297001R1300	0.310								
			AF38-30-00-14	1SBL297001R1400	0.350								

(1) AF...30...-11 not suitable for direct control by PLC-output.

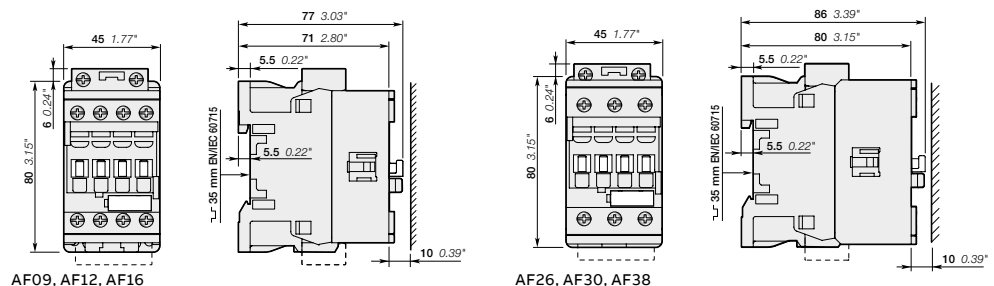

Main dimensions mm, inches

# AF09Z ... AF38Z 3-pole contactors

4 to 18.5 kW

24 V DC operated designed for PLC

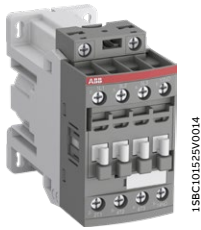

AF09Z-30-10



AF26Z-30-00

AF09Z ... AF38Z contactors are mainly used for controlling 3-phase motors and power circuits up to 690 V AC and 220 V DC. These contactors are of the block type design with 3 main poles.

- control circuit: 24 V DC operated with electronic coil interface allowing low holding consumption up to 1.7 W and reduced panel energy consumption
  - allow direct control by PLC-output  $\geq 250$  mA 24 V DC
  - very distinct closing and opening
- built-in surge suppression
- add-on auxiliary contact blocks for front or side mounting and a wide range of accessories.

IEC		UL/CSA		Rated control circuit voltage Uc	Auxiliary contacts fitted	Type	Order code	Weight Pkg (1 pce) kg
Rated operational power 400 V AC-3 kW	current $\theta \leq 40^\circ\text{C}$ AC-1 A	3-phase motor rating 480 V hp	General use rating 600 V AC A					
4	25	5	25	24	1 0	AF09Z-30-10-30	1SBL136001R3010	0.430
					0 1	AF09Z-30-01-30	1SBL136001R3001	0.430
5.5	28	7.5	28	24	1 0	AF12Z-30-10-30	1SBL156001R3010	0.430
					0 1	AF12Z-30-01-30	1SBL156001R3001	0.430
7.5	30	10	30	24	1 0	AF16Z-30-10-30	1SBL176001R3010	0.430
					0 1	AF16Z-30-01-30	1SBL176001R3001	0.430
11	45	15	45	24	0 0	AF26Z-30-00-30	1SBL236001R3000	0.480
15	50	20	50	24	0 0	AF30Z-30-00-30	1SBL276001R3000	0.480
18.5	50	25	50	24	0 0	AF38Z-30-00-30	1SBL296001R3000	0.480

Note: AF..Z contactors with DC control voltage 24 V DC need to respect the connection polarities indicated close to the coil terminals: A1+ for the positive pole and A2- for the negative pole.

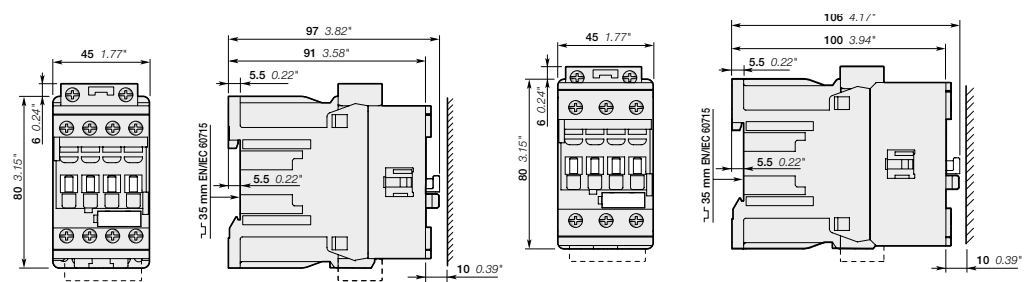

AF09Z, AF12Z, AF16Z  
Main dimensions mm, inches

AF26Z, AF30Z, AF38Z

1SBC10032850201 - Rev. A

# AF09Z ... AF38Z 3-pole contactors

4 to 18.5 kW

AC / DC operated for specific applications



AF09Z-30-10



AF26Z-30-00

AF09Z ... AF38Z contactors are mainly used for controlling 3-phase motors and power circuits up to 690 V AC and 220 V DC. These contactors are of the block type design with 3 main poles.

- control circuit: AC or DC operated with electronic coil interface accepting a wide control voltage range (e.g. 100...250 V AC and DC), only 4 control voltage ranges covering 24...250 V 50/60 Hz and 12...250 V DC
  - can manage large control voltage variations
  - allow direct control by PLC-output  $\geq 24$  V DC 500 mA
  - reduced panel energy consumption
  - very distinct closing and opening
  - can withstand short voltage dips and voltage sags (SEMI F47-0706 conditions of use on request).
- built-in surge suppression
- add-on auxiliary contact blocks for front or side mounting and a wide range of accessories.

IEC		UL/CSA		Rated control circuit voltage		Auxiliary contacts fitted	Type	Order code	Weight					
Rated operational power	current $\theta \leq 40^\circ\text{C}$	3-phase motor rating	General use rating	Uc min. ...	Uc max.					Pkg (1 pce)				
400 V AC-3 kW	AC-1 A	hp	600 V AC	V 50/60 Hz	V DC	kg								
4	25	5	25	-	12...20	1 0	AF09Z-30-10-20	1SBL136001R2010	0.310					
						0 1	AF09Z-30-01-20	1SBL136001R2001	0.310					
					24...60	20...60	1 0	AF09Z-30-10-21	1SBL136001R2110	0.310				
							0 1	AF09Z-30-01-21	1SBL136001R2101	0.310				
					48...130	48...130	1 0	AF09Z-30-10-22	1SBL136001R2210	0.310				
							0 1	AF09Z-30-01-22	1SBL136001R2201	0.310				
					100...250	100...250	1 0	AF09Z-30-10-23	1SBL136001R2310	0.310				
							0 1	AF09Z-30-01-23	1SBL136001R2301	0.310				
					5.5	28	7.5	28	-	12...20	1 0	AF12Z-30-10-20	1SBL156001R2010	0.310
											0 1	AF12Z-30-01-20	1SBL156001R2001	0.310
24...60	20...60	1 0	AF12Z-30-10-21	1SBL156001R2110						0.310				
		0 1	AF12Z-30-01-21	1SBL156001R2101						0.310				
48...130	48...130	1 0	AF12Z-30-10-22	1SBL156001R2210						0.310				
		0 1	AF12Z-30-01-22	1SBL156001R2201						0.310				
100...250	100...250	1 0	AF12Z-30-10-23	1SBL156001R2310						0.310				
		0 1	AF12Z-30-01-23	1SBL156001R2301						0.310				
7.5	30	10	30	-						12...20	1 0	AF16Z-30-10-20	1SBL176001R2010	0.310
											0 1	AF16Z-30-01-20	1SBL176001R2001	0.310
					24...60	20...60	1 0	AF16Z-30-10-21	1SBL176001R2110	0.310				
							0 1	AF16Z-30-01-21	1SBL176001R2101	0.310				
					48...130	48...130	1 0	AF16Z-30-10-22	1SBL176001R2210	0.310				
							0 1	AF16Z-30-01-22	1SBL176001R2201	0.310				
					100...250	100...250	1 0	AF16Z-30-10-23	1SBL176001R2310	0.310				
							0 1	AF16Z-30-01-23	1SBL176001R2301	0.310				
					11	45	15	45	-	12...20	0 0	AF26Z-30-00-20	1SBL236001R2000	0.350
											0 0	AF26Z-30-00-21	1SBL236001R2100	0.350
24...60	20...60	0 0	AF26Z-30-00-22	1SBL236001R2200						0.350				
		0 0	AF26Z-30-00-23	1SBL236001R2300						0.350				
15	50	20	50	-						12...20	0 0	AF30Z-30-00-20	1SBL276001R2000	0.350
					0 0	AF30Z-30-00-21	1SBL276001R2100	0.350						
					24...60	20...60	0 0	AF30Z-30-00-22	1SBL276001R2200	0.350				
0 0	AF30Z-30-00-23	1SBL276001R2300	0.350											
18.5	50	25	50	-	12...20	0 0	AF38Z-30-00-20	1SBL296001R2000	0.350					
						0 0	AF38Z-30-00-21	1SBL296001R2100	0.350					
					24...60	20...60	0 0	AF38Z-30-00-22	1SBL296001R2200	0.350				
							0 0	AF38Z-30-00-23	1SBL296001R2300	0.350				

Note: Only AF..Z contactors with DC control voltage 12...20 V DC need to respect the connection polarities indicated close to the coil terminals: A1+ for the positive pole and A2- for the negative pole.

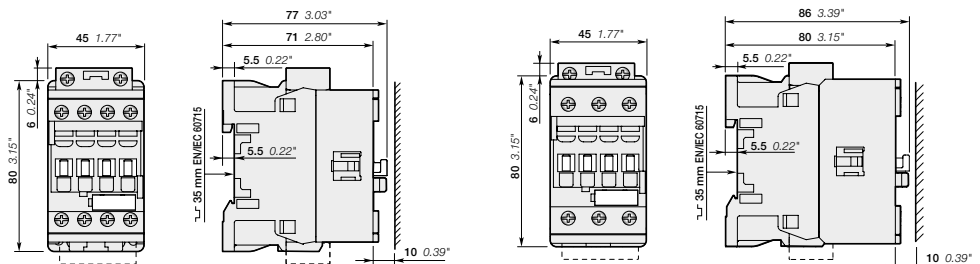

AF09Z, AF12Z, AF16Z

AF26Z, AF30Z, AF38Z

Main dimensions mm, inches

# AF40 ... AF96 3-pole contactors

18.5 to 45 kW

AC / DC operated



AF40-30-00

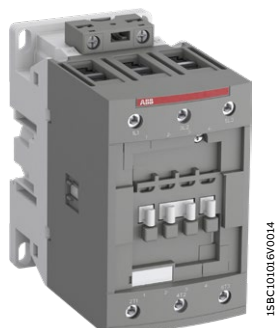

AF80-30-00

AF40 ... AF96 contactors are mainly used for controlling 3-phase motors and power circuits up to 690 V AC and 220 V DC. These contactors are of the block type design with 3 main poles.

- control circuit: AC or DC operated with electronic coil interface accepting a wide control voltage range (e.g. 100...250 V AC and DC), only 4 control voltage ranges covering 24...500 V 50/60 Hz and 20...500 V DC
  - can manage large control voltage variations
  - reduced panel energy consumption
  - very distinct closing and opening
  - can withstand short voltage dips and voltage sags (SEMI F47-0706 conditions of use on request).
- built-in surge suppression
- add-on auxiliary contact blocks for front or side mounting and a wide range of accessories.

IEC Rated operational power	UL / CSA 3-phase motor rating 480 V	General use rating 600 V AC	Rated control circuit voltage		Auxiliary contacts fitted	Type (1)	Order code	Weight	
			Uc min. ...	Uc max.					
400 V AC-3 kW	AC-1 A	hp	A	V 50/60 Hz	V DC			Pkg (1 pce)	
18.5	70	30	60	24...60	20...60 (1)	0 0	AF40-30-00-11	1SBL347001R1100	0.970
				48...130	48...130	0 0	AF40-30-00-12	1SBL347001R1200	0.970
				100...250	100...250	0 0	AF40-30-00-13	1SBL347001R1300	0.950
				250...500	250...500	0 0	AF40-30-00-14	1SBL347001R1400	0.950
22	100	40	80	24...60	20...60 (1)	0 0	AF52-30-00-11	1SBL367001R1100	0.970
				48...130	48...130	0 0	AF52-30-00-12	1SBL367001R1200	0.970
				100...250	100...250	0 0	AF52-30-00-13	1SBL367001R1300	0.950
				250...500	250...500	0 0	AF52-30-00-14	1SBL367001R1400	0.950
30	105	50	90	24...60	20...60 (1)	0 0	AF65-30-00-11	1SBL387001R1100	0.970
				48...130	48...130	0 0	AF65-30-00-12	1SBL387001R1200	0.970
				100...250	100...250	0 0	AF65-30-00-13	1SBL387001R1300	0.950
				250...500	250...500	0 0	AF65-30-00-14	1SBL387001R1400	0.950
37	125	60	105	24...60	20...60 (1)	0 0	AF80-30-00-11	1SBL397001R1100	1.220
				48...130	48...130	0 0	AF80-30-00-12	1SBL397001R1200	1.220
				100...250	100...250	0 0	AF80-30-00-13	1SBL397001R1300	1.170
				250...500	250...500	0 0	AF80-30-00-14	1SBL397001R1400	1.170
45	130	60	115	24...60	20...60 (1)	0 0	AF96-30-00-11	1SBL407001R1100	1.220
				48...130	48...130	0 0	AF96-30-00-12	1SBL407001R1200	1.220
				100...250	100...250	0 0	AF96-30-00-13	1SBL407001R1300	1.170
				250...500	250...500	0 0	AF96-30-00-14	1SBL407001R1400	1.170

(1) For control by PLC-output, use RA4 interface relay.

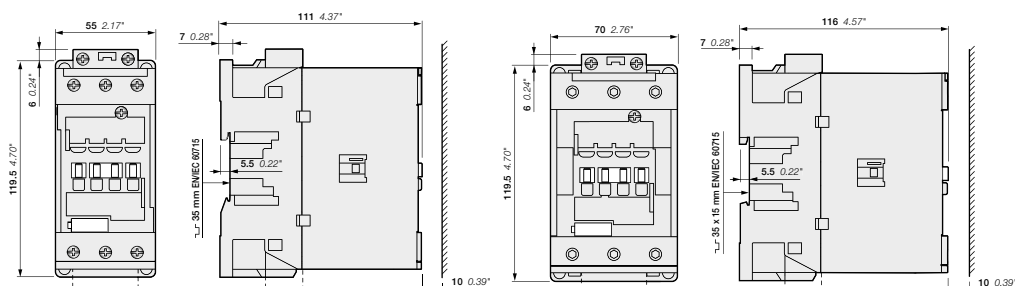

AF40, AF52, AF65

AF80, AF96

Main dimensions mm, inches

# AF09 ... AF96 3-pole contactors

## Contactors and main accessories

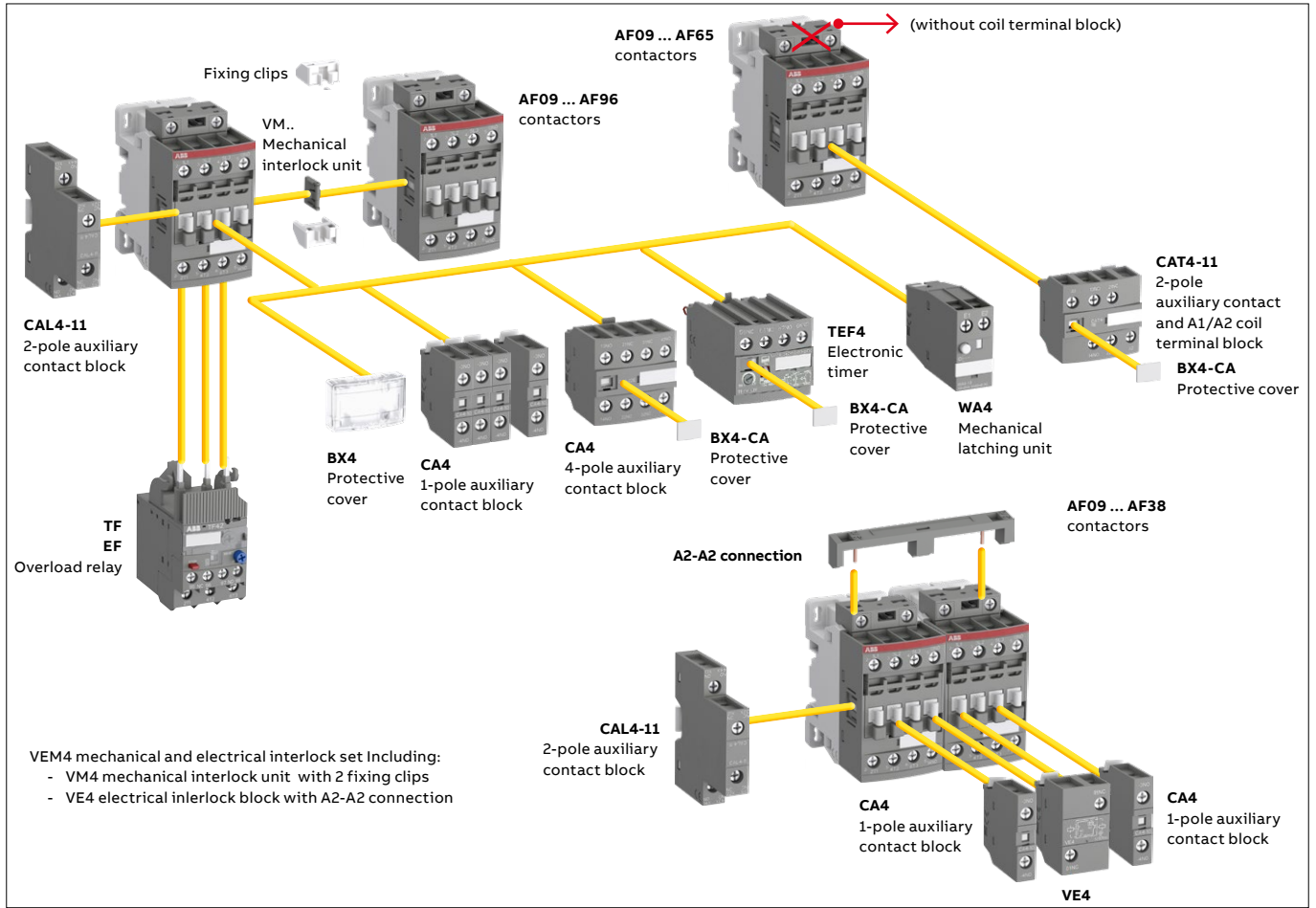

**Main accessory fitting details** - for ordering details, technical data and other accessories: see section accessories  
 Many configurations of accessories are possible depending on whether these are front-mounted or side-mounted.

Contactor types	Main poles	Built-in auxiliary contacts	Front-mounted accessories			Electronic timer	Mechanical latching unit	Electrical and mechanical interlock set (between 2 contactors)	Side-mounted accessories	
			Auxiliary contact blocks						Auxiliary contact blocks	
			1-pole CA4	2-pole CAT4-11	4-pole CA4	TEF4	WA4 (2)	VEM4	Left side	Right side
<b>AF09(Z) ... AF38(Z) (1)</b>										
AF09 ... AF16	3	0	0	1	▶	4 max.	or 1	or 1	or 1	-
AF09 ... AF16	3	0	1	0	▶	2 max.	or 1	-	or 1	or 1
AF26 ... AF38	3	0	0	0	▶	3 max.	-	-	+	or 1
<b>AF09Z ... AF38Z 24 V DC designed for PLC - coil 30 (1)</b>										
AF09Z ... AF16Z	3	0	0	1	▶	4 max.	-	or 1	or 1	- (3)
AF09Z ... AF16Z	3	0	1	0	▶	2 max.	-	-	or 1	- (3)
AF26Z ... AF38Z	3	0	0	0	▶	-	-	-	1	-
<b>AF40 ... AF96</b>										
AF40 ... AF65	3	0	0	0	▶	4 max.	or 1	or 1	or 1	or 1
AF80, AF96	3	0	0	0	▶	4 max.	-	or 1	or 1	or 1

(1) Including add-on and built-in contacts : 4 N.C. auxiliary contacts max on positions 1, 2, 3, 4 and 3 N.C. auxiliary contacts max. on positions 1 ±30°, 5.  
 (2) Use WA4 for AF09...AF65 and WA4-96 for AF80, AF96.  
 Accept 1-pole CA4 auxiliary contacts (1 block on each side of the mechanical latch) in respect to the total number of built-in or additional N.C. auxiliary contacts.  
 For WA4 accessory use with contactor coil 30, please consult your ABB local sales organization.  
 (3) VEM4 not suitable for AF..Z contactors with DC control voltages 12...20 V DC (coil 20) and 24 V DC (coil 30). Use VM4 side-mounted mechanical interlock unit.

### Overload relays fitting details (4)

Contactor types	Thermal overload relays	Electronic overload relays
AF09 ... AF38	TF42 (0.10...38 A)	EF19 (0.10...19 A)
AF26 ... AF38	TF42 (0.10...38 A)	EF45 (9...45 A)
AF40 ... AF65	TF65 (22...67 A)	EF65 (20...70 A)
AF80, AF96	TF96 (40...96 A)	EF96 (36...100 A)

The addition of an overload relay on the contactor does not prevent fitting of many other accessories as shown above.  
 (4) Direct mounting - No kit required.



# AF116 ... AF146 3-pole contactors

55 to 75 kW

AC / DC operated



AF146-30-00

1SFC101005V0001



AF146-30-00B

1SFC101006V0001

AF116 ... AF140 contactors are mainly used for controlling 3-phase motors and power circuits up to 690 V AC, AF146 up to 1000 V AC and AF116 ... AF146 up to 260 V DC. These contactors are of the block type design with 3 main poles.

- control circuit: AC or DC operated with electronic coil interface accepting a wide control voltage range (e.g. 100...250 V AC and DC), only 4 coils to cover control voltages between 24...500 V 50/60 Hz and 20...500 V DC
  - can manage large control voltage variations
  - reduced panel energy consumption
  - very distinct closing and opening
  - can withstand short voltage dips and voltage sags (SEMI F47 conditions of use on request).
- built-in surge suppression
- add-on auxiliary contact blocks for side mounting and a wide range of accessories.

IEC Rated operational power	UL / CSA		Rated control circuit voltage Uc min. ... Uc max.	Auxiliary contacts fitted	Type (1)	Order code	Weight  Pkg (1 pce)  kg
	3-phase motor rating 480 V	General use rating 600 V AC					
400 V AC-3 kW	AC-1 A	hp	A	V 50/60 Hz	V DC		

**For connection with built-in cable clamps**

55	160	75	160	24...60	20...60	0 0	AF116-30-00-11	1SFL427001R1100	1.750
				48...130	48...130	0 0	AF116-30-00-12	1SFL427001R1200	1.750
				100...250	100...250	0 0	AF116-30-00-13	1SFL427001R1300	1.750
				250...500	250...500	0 0	AF116-30-00-14	1SFL427001R1400	1.750
75	200	100	200	24...60	20...60	0 0	AF140-30-00-11	1SFL447001R1100	1.750
				48...130	48...130	0 0	AF140-30-00-12	1SFL447001R1200	1.750
				100...250	100...250	0 0	AF140-30-00-13	1SFL447001R1300	1.750
				250...500	250...500	0 0	AF140-30-00-14	1SFL447001R1400	1.750
75	225	100	200	24...60	20...60	0 0	AF146-30-00-11	1SFL467001R1100	1.750
				48...130	48...130	0 0	AF146-30-00-12	1SFL467001R1200	1.750
				100...250	100...250	0 0	AF146-30-00-13	1SFL467001R1300	1.750
				250...500	250...500	0 0	AF146-30-00-14	1SFL467001R1400	1.750

**With bar connections**

55	160	75	160	24...60	20...60	0 0	AF116-30-00B-11	1SFL427002R1100	1.500
				48...130	48...130	0 0	AF116-30-00B-12	1SFL427002R1200	1.500
				100...250	100...250	0 0	AF116-30-00B-13	1SFL427002R1300	1.500
				250...500	250...500	0 0	AF116-30-00B-14	1SFL427002R1400	1.500
75	200	100	200	24...60	20...60	0 0	AF140-30-00B-11	1SFL447002R1100	1.500
				48...130	48...130	0 0	AF140-30-00B-12	1SFL447002R1200	1.500
				100...250	100...250	0 0	AF140-30-00B-13	1SFL447002R1300	1.500
				250...500	250...500	0 0	AF140-30-00B-14	1SFL447002R1400	1.500
75	225	100	200	24...60	20...60	0 0	AF146-30-00B-11	1SFL467002R1100	1.500
				48...130	48...130	0 0	AF146-30-00B-12	1SFL467002R1200	1.500
				100...250	100...250	0 0	AF146-30-00B-13	1SFL467002R1300	1.500
				250...500	250...500	0 0	AF146-30-00B-14	1SFL467002R1400	1.500

(1) For other auxiliary contacts arrangements, please contact your ABB local sales organization.

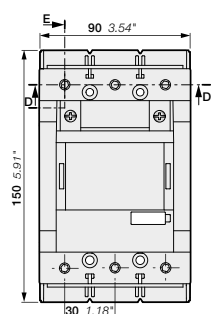

AF116, AF140, AF146-30-00

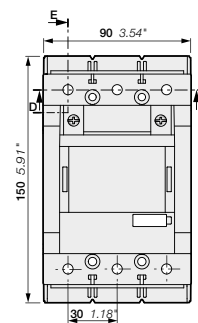
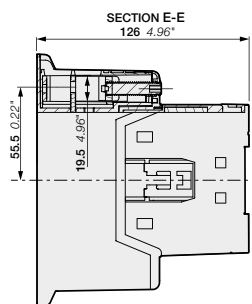

AF116, AF140, AF146-30-00B

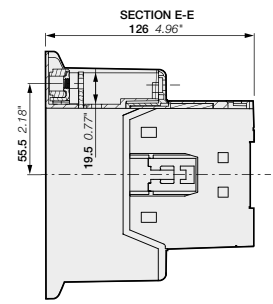

Main dimensions mm, inches

1SFC101088C201-Rev. D

# AF116 ... AF146 3-pole contactors with built-in PLC interface

55 to 75 kW

AC / DC operated for faster opening utilization



AF146-30-00

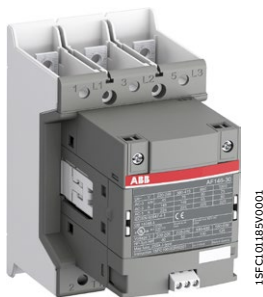

AF146-30-00B

AF116 ... AF146 contactors are mainly used for controlling 3-phase motors and power circuits up to 690 V AC, AF146 up to 1000 V AC and AF116 ... AF146 up to 260 V DC. These contactors are of the block type design with 3 main poles.

- control circuit: AC or DC operated with electronic coil interface accepting a wide control voltage range (e.g. 100...500 V AC and DC), only 2 coils to cover control voltages between 100...500 V 50/60 Hz and 100...250 V DC
  - can manage large control voltage variations
  - reduced panel energy consumption
  - very distinct closing and opening
  - can withstand short voltage dips and voltage sags (SEMI F47 conditions of use on request)
  - opening time below 20 ms.
- built-in surge suppression
- add-on auxiliary contact blocks for side mounting and a wide range of accessories.

IEC	UL / CSA		Rated control circuit voltage Uc min. ... Uc max.	Auxiliary contacts fitted	Type (1)	Order code	Weight
Rated operational power	3-phase motor rating	General use rating					
400 V AC-3 kW	AC-1 A	480 V hp	600 V AC	V 50/60 Hz V DC			kg

**For connection with built-in cable clamps**

55	160	75	160	100...250	100...250	0 0	AF116-30-00-33	1SFL427001R3300	1.750
				250...500	250...500	0 0	AF116-30-00-34	1SFL427001R3400	1.750
75	200	100	200	100...250	100...250	0 0	AF140-30-00-33	1SFL447001R3300	1.750
				250...500	250...500	0 0	AF140-30-00-34	1SFL447001R3400	1.750
75	225	100	200	100...250	100...250	0 0	AF146-30-00-33	1SFL467001R3300	1.750
				250...500	250...500	0 0	AF146-30-00-34	1SFL467001R3400	1.750

**With bar connections**

55	160	75	160	100...250	100...250	0 0	AF116-30-00B-33	1SFL427002R3300	1.500
				250...500	250...500	0 0	AF116-30-00B-34	1SFL427002R3400	1.500
75	200	100	200	100...250	100...250	0 0	AF140-30-00B-33	1SFL447002R3300	1.500
				250...500	250...500	0 0	AF140-30-00B-34	1SFL447002R3400	1.500
75	225	100	200	100...250	100...250	0 0	AF146-30-00B-33	1SFL467002R3300	1.500
				250...500	250...500	0 0	AF146-30-00B-34	1SFL467002R3400	1.500

(1) For other auxiliary contacts arrangements, please contact your ABB local sales organization.

AF116 ... AF146 are equipped with low voltage inputs for control, for example by a PLC.

**Control inputs**

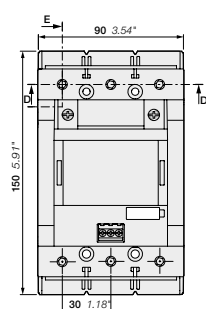
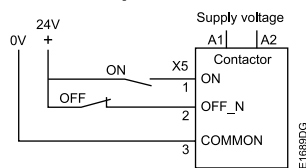

AF116, AF140, AF146-30-00

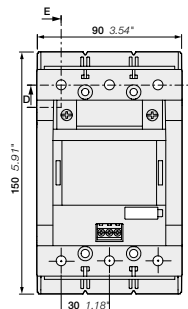
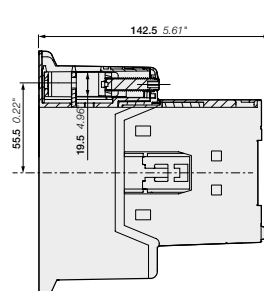

AF116, AF140, AF146-30-00B

Main dimensions mm, inches

# AF190 ... AF370 3-pole contactors

90 to 200 kW

AC / DC operated



AF205-30-00



AF370-30-00

AF190 ... AF370 contactors are mainly used for controlling 3-phase motors and power circuits up to 1000 V AC and 340 V DC. These contactors are of the block type design with 3 main poles.

- control circuit: AC or DC operated with electronic coil interface accepting a wide control voltage range (e.g. 100...250 V AC and DC), only 4 coils to cover control voltages between 24...500 V 50/60 Hz and 20...500 V DC
  - can manage large control voltage variations
  - reduced panel energy consumption
  - very distinct closing and opening
  - can withstand short voltage dips and voltage sags (SEMI F47 conditions of use on request).
- built-in surge suppression
- add-on auxiliary contact blocks for side mounting and a wide range of accessories.

IEC Rated power 400 V AC-3 kW	operational current $\theta \leq 40^\circ\text{C}$ AC-1 A	UL / CSA 3-phase motor rating 480 V hp	General use rating 600 V AC A	Rated control circuit voltage Uc min. ... Uc max.		Auxiliary contacts fitted 	Type (1)	Order code	Weight Pkg (1 pce) kg
				V 50/60 Hz	V DC				
90	275	125	250	24...60	20...60	0 0	AF190-30-00-11	1SFL487002R1100	3.000
				48...130	48...130	0 0	AF190-30-00-12	1SFL487002R1200	3.000
				100...250	100...250	0 0	AF190-30-00-13	1SFL487002R1300	3.000
				250...500	250...500	0 0	AF190-30-00-14	1SFL487002R1400	3.000
110	350	150	300	24...60	20...60	0 0	AF205-30-00-11	1SFL527002R1100	3.000
				48...130	48...130	0 0	AF205-30-00-12	1SFL527002R1200	3.000
				100...250	100...250	0 0	AF205-30-00-13	1SFL527002R1300	3.000
				250...500	250...500	0 0	AF205-30-00-14	1SFL527002R1400	3.000
132	400	200	350	24...60	20...60	0 0	AF265-30-00-11	1SFL547002R1100	4.605
				48...130	48...130	0 0	AF265-30-00-12	1SFL547002R1200	4.605
				100...250	100...250	0 0	AF265-30-00-13	1SFL547002R1300	4.605
				250...500	250...500	0 0	AF265-30-00-14	1SFL547002R1400	4.605
160	500	250	400	24...60	20...60	0 0	AF305-30-00-11	1SFL587002R1100	4.605
				48...130	48...130	0 0	AF305-30-00-12	1SFL587002R1200	4.605
				100...250	100...250	0 0	AF305-30-00-13	1SFL587002R1300	4.605
				250...500	250...500	0 0	AF305-30-00-14	1SFL587002R1400	4.605
200	600	300	520	24...60	20...60	0 0	AF370-30-00-11	1SFL607002R1100	4.605
				48...130	48...130	0 0	AF370-30-00-12	1SFL607002R1200	4.605
				100...250	100...250	0 0	AF370-30-00-13	1SFL607002R1300	4.605
				250...500	250...500	0 0	AF370-30-00-14	1SFL607002R1400	4.605

(1) For other auxiliary contacts arrangements, please contact your ABB local sales organization.

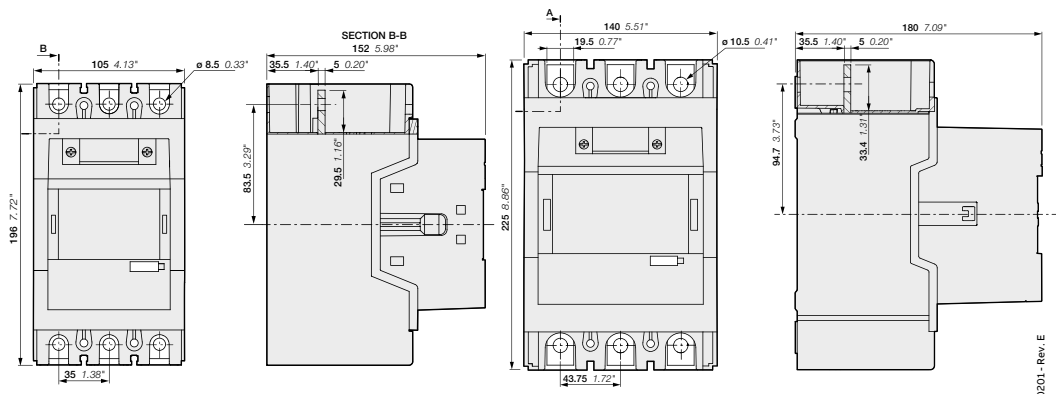

AF190, AF205

AF265, AF305, AF370

Main dimensions mm, inches

1SFC101089C0201-Rev. E

# AF190 ... AF370 3-pole contactors with built-in PLC interface

90 to 200 kW

AC / DC operated for faster utilization

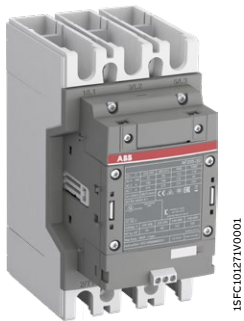

AF205-30-00

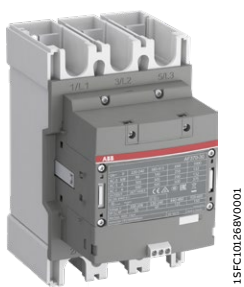

AF370-30-00

AF190 ... AF370 contactors are mainly used for controlling 3-phase motors and power circuits up to 1000 V AC and 340 V DC. These contactors are of the block type design with 3 main poles.

- control circuit: AC or DC operated with electronic coil interface accepting a wide control voltage range (e.g. 100...250 V AC and DC), only 2 coils to cover control voltages between 100...500 V 50/60 Hz and 100...500 V DC
  - can manage large control voltage variations
  - reduced panel energy consumption
  - very distinct closing and opening
  - can withstand short voltage dips and voltage sags (SEMI F47 conditions of use on request)
  - opening time below 20 ms.
- built-in surge suppression
- add-on auxiliary contact blocks for side mounting and a wide range of accessories.

IEC Rated operational power	UL / CSA 3-phase motor rating 480 V	General use rating 600 V AC	Rated control circuit voltage Uc min. ... Uc max.		Auxiliary contacts fitted	Type (1)	Order code	Weight  Pkg (1 pce)  kg	
			AC-1 A	AC-3 kW					V 50/60 Hz
90	275	125	250	100...250	100...250	0 0	AF190-30-00-33	15FL487002R3300	3.000
				250...500	250...500	0 0	AF190-30-00-34	15FL487002R3400	3.000
110	350	150	300	100...250	100...250	0 0	AF205-30-00-33	15FL527002R3300	3.000
				250...500	250...500	0 0	AF205-30-00-34	15FL527002R3400	3.000
132	400	200	350	100...250	100...250	0 0	AF265-30-00-33	15FL547002R3300	4.605
				250...500	250...500	0 0	AF265-30-00-34	15FL547002R3400	4.605
160	500	250	400	100...250	100...250	0 0	AF305-30-00-33	15FL587002R3300	4.605
				250...500	250...500	0 0	AF305-30-00-34	15FL587002R3400	4.605
200	600	300	520	100...250	100...250	0 0	AF370-30-00-33	15FL607002R3300	4.605
				250...500	250...500	0 0	AF370-30-00-34	15FL607002R3400	4.605

(1) For other auxiliary contacts arrangements, please contact your ABB local sales organization.

AF190 ... AF370 are equipped with low voltage inputs for control, for example by a PLC.

### Control inputs

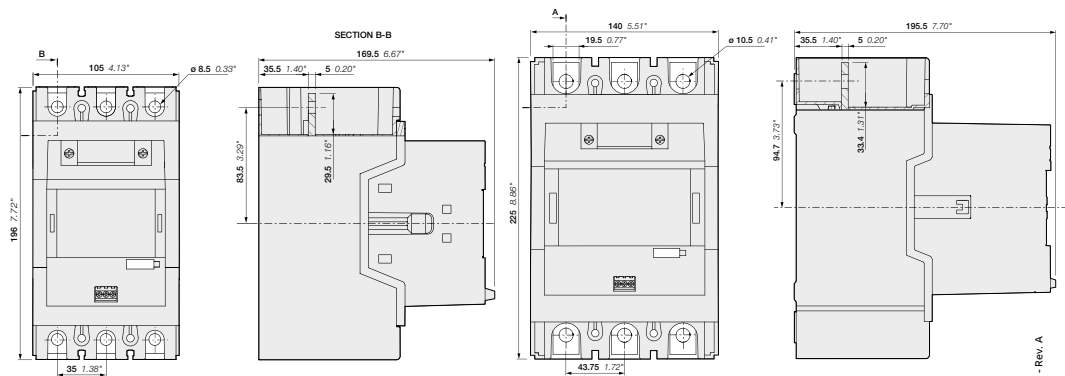
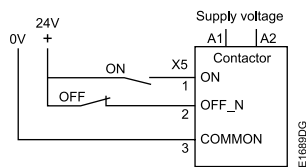

AF190, AF205

AF265, AF305, AF370

Main dimensions mm, inches

15FC10165FC020 - Rev. A

# AF116 ... AF370 3-pole contactors

## Contactors and main accessories

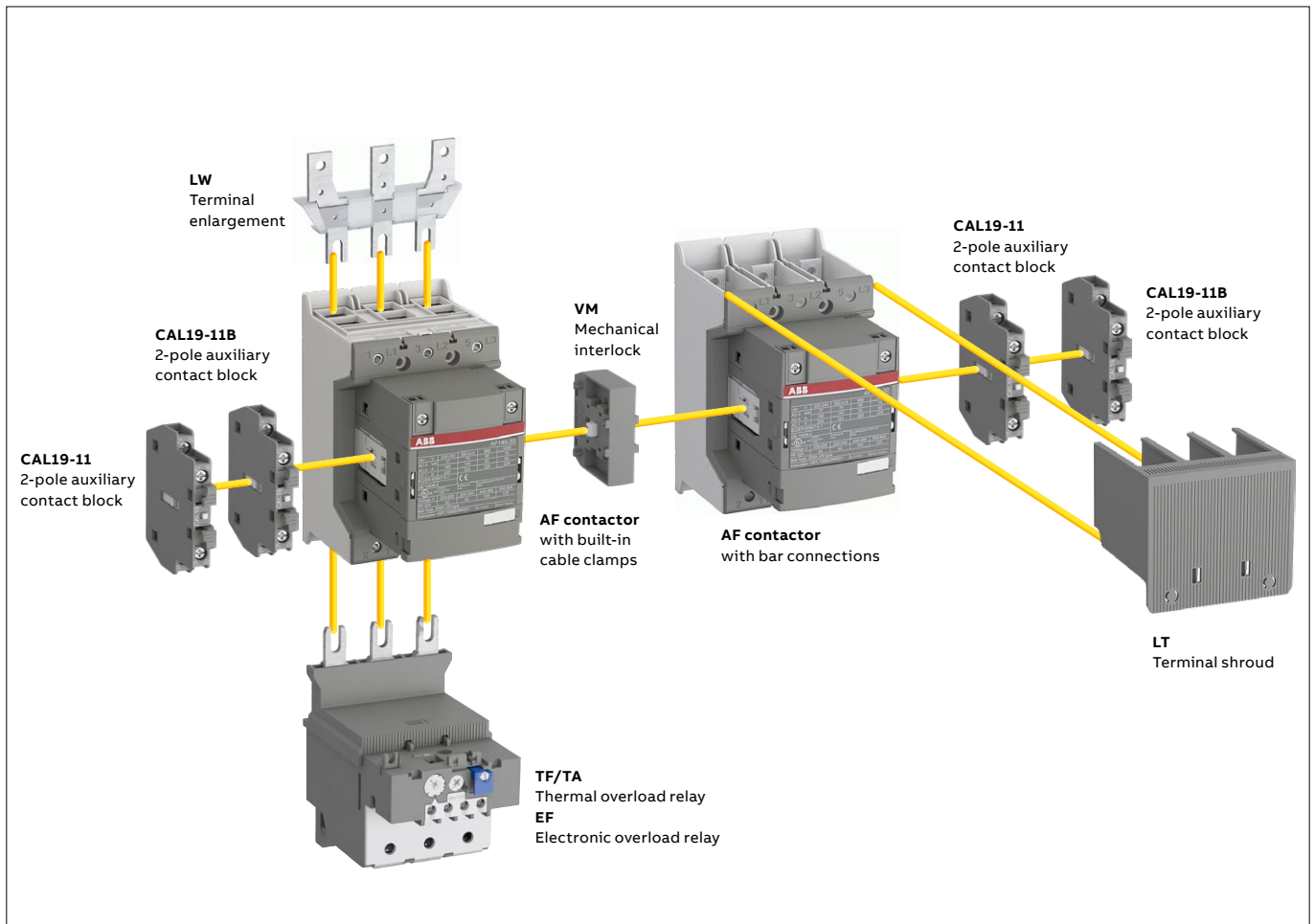

**Main accessory fitting details - for ordering details, technical data and other accessories: see section accessories**

Contactor types	Main poles	Available auxiliary contacts	Side-mounted accessories		Mechanical interlock units (between two contactors)
			Auxiliary contact blocks		
			<b>CAL19-11 (3)</b>	<b>CAL19-11B</b>	
AF116 ... AF370	3	0 0	▶ 2 x CAL19-11	+ 2 x CAL19-11B	-
AF116 ... AF370	3	0 0	▶ 2 x CAL19-11 (1)	+ 2 x CAL19-11B (1)	+ VM... (2)

- (1) Total number of auxiliary contact blocks for the two contactors.
- (2) Interlock type, according to the contactor ratings (see "Accessories").
- (3) The CEL19 auxiliary contact blocks can replace the CAL19-11 and CAL19-11B. Though, no auxiliary contact block can be mounted outside the CEL19.

**Overload relays fitting details (1)**

Contactor types	Thermal overload relays	Electronic overload relays
AF116 ... AF140	TF140DU (66...142 A)	EF146 (54...150 A)
AF146	-	EF146 (54...150 A)
AF190, AF205	TA200DU (66...200 A)	EF205 (63...210 A)
AF265 ... AF370	-	EF370 (115...380 A)

The addition of a thermal or electronic overload relay on the contactor does not prevent fitting of many other accessories as shown in "Main accessory fitting details" table.  
 (1) Direct mounting - No kit required.

# AF26 ... AF38 3-pole contactors

4 to 18.5 kW

AC / DC operated with 1 N.O. + 1 N.C. auxiliary contacts

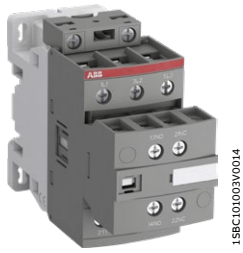

AF26-30-11

- AF26 ... AF38 contactors are mainly used for controlling 3-phase motors and power circuits up to 690 V AC and 220 V DC. These contactors are of the block type design with 3 main poles (1st stack):
  - 2nd stack with permanently fixed auxiliary contact block. The built-in auxiliary contact elements are mechanically linked (side-marked symbol) and the N.C. auxiliary contacts are mirror contacts
  - control circuit: AC or DC operated with electronic coil interface accepting a wide control voltage range (e.g. 100...250 V AC and DC), only 4 control voltage ranges covering 24...500 V 50/60 Hz and 20...500 V DC
    - can manage large control voltage variations
    - reduced panel energy consumption
    - very distinct closing and opening
  - built-in surge suppression
  - add-on auxiliary contact blocks for side mounting and a wide range of accessories.

IEC	UL/CSA		Rated control circuit voltage Uc min. ... Uc max.	Auxiliary contacts fitted	Type	Order code	Weight	
	Rated operational power 400 V AC-3 kW	current θ ≤ 40 °C AC-1 A						3-phase motor rating 480 V hp
11		45	15	45	1 1	AF26-30-11-11	1SBL237001R1111	0.350
							1SBL237001R1211	0.350
							1SBL237001R1311	0.350
							1SBL237001R1411	0.390
15	50	20	20	50	1 1	AF30-30-11-11	1SBL277001R1111	0.350
							1SBL277001R1211	0.350
							1SBL277001R1311	0.350
							1SBL277001R1411	0.390
18.5	50	25	25	50	1 1	AF38-30-11-11	1SBL297001R1111	0.350
							1SBL297001R1211	0.350
							1SBL297001R1311	0.350
							1SBL297001R1411	0.390

(1) AF...-30...-11 not suitable for direct control by PLC-output.

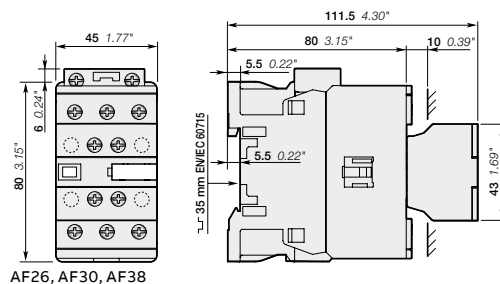

Main dimensions mm, inches



## AF26Z ... AF38Z 3-pole contactors

4 to 18.5 kW

AC / DC operated for specific applications with 1 N.O. + 1 N.C. contacts

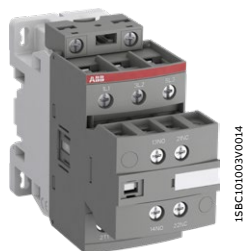

AF26Z-30-11

- AF26Z ... AF38Z contactors are mainly used for controlling 3-phase motors and power circuits up to 690 V AC and 220 V DC. These contactors are of the block type design with 3 main poles (1st stack):
- 2nd stack with permanently fixed auxiliary contact block. The built-in auxiliary contact elements are mechanically linked (side-marked symbol) and the N.C. auxiliary contacts are mirror contacts
  - control circuit: AC or DC operated with electronic coil interface accepting a wide control voltage range (e.g. 100...250 V AC and DC), only 4 control voltage ranges covering 24...250 V 50/60 Hz and 12...250 V DC
    - can manage large control voltage variations, allow direct control by PLC-output  $\geq 24$  V DC 500 mA, reduced panel energy consumption, very distinct closing and opening,
    - can withstand short voltage dips and voltage sags (SEMI F47-0706 conditions of use on request).
  - built-in surge suppression
  - add-on auxiliary contact blocks for side mounting and a wide range of accessories.

IEC	UL/CSA		Rated control circuit voltage Uc min. ... Uc max.	Auxiliary contacts fitted	Type	Order code	Weight		
	Rated operational power 400 V AC-3 kW	3-phase motor current $\theta \leq 40$ °C AC-1 A						General use rating 480 V 600 V AC hp A	Pkg (1 pce)
11	45	15	45	-	12...20	1 1	AF26Z-30-11-20	1SBL236001R2011	0.390
					24...60	20...60	1 1	AF26Z-30-11-21	1SBL236001R2111
				48...130	48...130	1 1	AF26Z-30-11-22	1SBL236001R2211	0.390
				100...250	100...250	1 1	AF26Z-30-11-23	1SBL236001R2311	0.390
15	50	20	50	-	12...20	1 1	AF30Z-30-11-20	1SBL276001R2011	0.390
					24...60	20...60	1 1	AF30Z-30-11-21	1SBL276001R2111
				48...130	48...130	1 1	AF30Z-30-11-22	1SBL276001R2211	0.390
				100...250	100...250	1 1	AF30Z-30-11-23	1SBL276001R2311	0.390
18.5	50	25	50	-	12...20	1 1	AF38Z-30-11-20	1SBL296001R2011	0.390
					24...60	20...60	1 1	AF38Z-30-11-21	1SBL296001R2111
				48...130	48...130	1 1	AF38Z-30-11-22	1SBL296001R2211	0.390
				100...250	100...250	1 1	AF38Z-30-11-23	1SBL296001R2311	0.390

Note: Only AF..Z contactors with DC control voltage 12...20 V DC need to respect the connection polarities indicated close to the coil terminals: A1+ for the positive pole and A2- for the negative pole

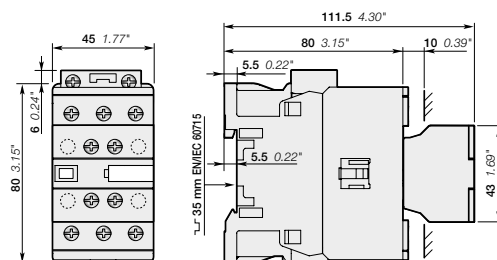

AF26Z, AF30Z, AF38Z

Main dimensions mm, inches

# AF26 ... AF38 3-pole contactors with 1 N.O. + 1 N.C. auxiliary contacts

Contactors and main accessories

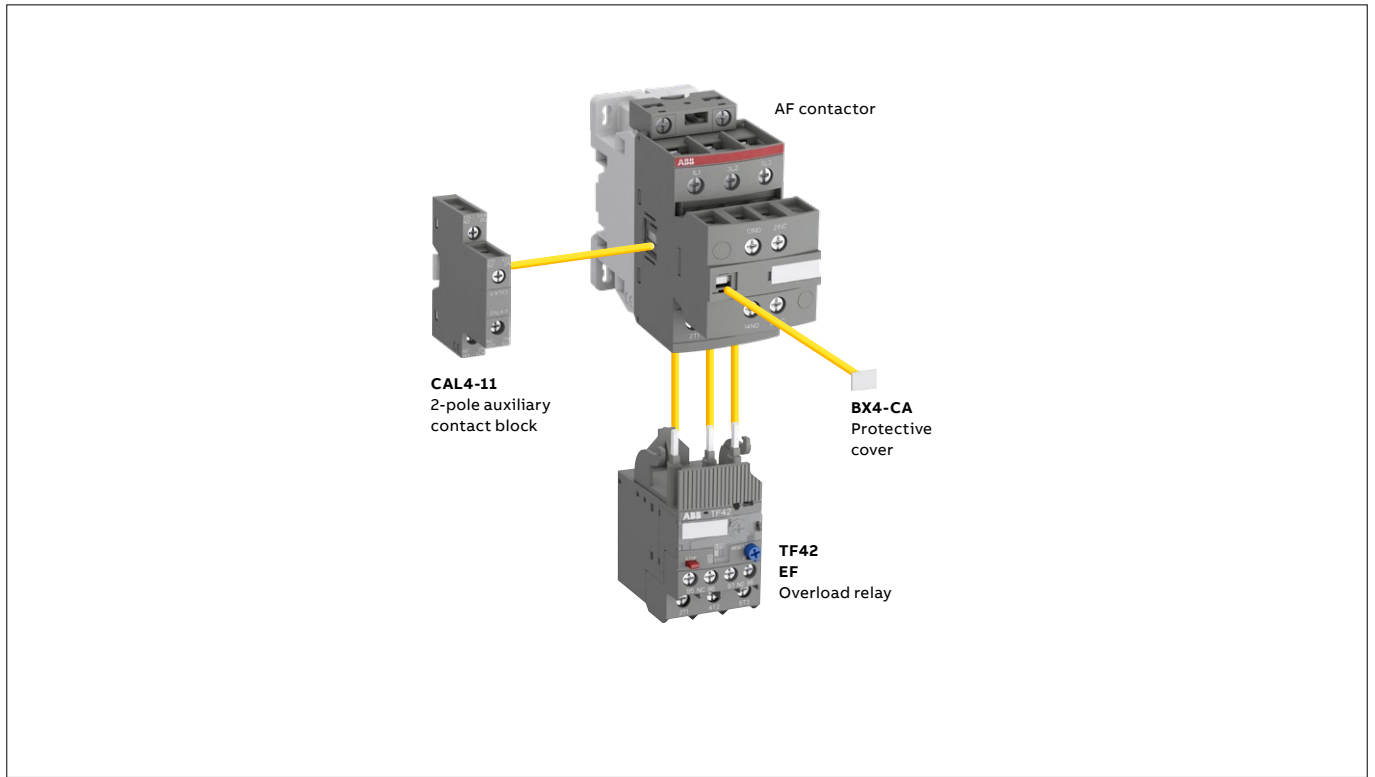

**Main accessory fitting details** - for ordering details, technical data and other accessories: see section accessories

Contactor types	Main poles	Built-in auxiliary contacts	Side-mounted accessories		Auxiliary contact blocks	
			Mechanical interlock unit (between 2 contactors)		2-pole CAL4-11	
			VM4		Left side	Right side
AF26 ... AF38	3 0	1 1	1	-	+ 1	or 1
					+ 1	+ 1

### Overload relays fitting details (1)

Contactor types	Thermal overload relays	Electronic overload relays
AF26 ... AF38	TF42 (0.10...38 A)	EF19 (0.10...19 A) EF45 (9...45 A)

The addition of an overload relay on the contactor does not prevent fitting of many other accessories as shown above.

(1) Direct mounting - No kit required.

# AF40 ... AF96 3-pole contactors

18.5 to 30 kW

AC / DC operated with 1 N.O. + 1 N.C. auxiliary contacts



AF40-30-11



AF80-30-11

AF40 ... AF96 contactors are mainly used for controlling 3-phase motors and power circuits up to 690 V AC and 220 V DC. These contactors are of the block type design with 3 main poles (1st stack):

- with 1 N.O. + 1 N.C. side mounted auxiliary contact block
- control circuit: AC or DC operated with electronic coil interface accepting a wide control voltage range (e.g. 100...250 V AC and DC), only 4 control voltage ranges covering 24...500 V 50/60 Hz and 20...500 V DC
  - can manage large control voltage variations
  - reduced panel energy consumption
  - very distinct closing and opening
  - can withstand short voltage dips and voltage sags (SEMI F47-0706 conditions of use on request).
- built-in surge suppression
- add-on auxiliary contact blocks for side mounting and a wide range of accessories.

IEC		UL / CSA		Rated control circuit voltage		Auxiliary contacts fitted	Type	Order code	Weight	
Rated operational power	current $\theta \leq 40^\circ\text{C}$	3-phase motor rating 480 V	General use rating 600 V AC	Uc min. ... Uc max.						
400 V AC-3 kW	AC-1 A	hp	A	V 50/60 Hz	V DC				Pkg (1 pce)	
185	70	30	60	24...60	20...60	(1)	1 1	AF40-30-11-11	1SBL347001R1111	1.010
				48...130	48...130		1 1	AF40-30-11-12	1SBL347001R1211	1.010
				100...250	100...250		1 1	AF40-30-11-13	1SBL347001R1311	0.990
				250...500	250...500		1 1	AF40-30-11-14	1SBL347001R1411	0.990
22	100	40	80	24...60	20...60	(1)	1 1	AF52-30-11-11	1SBL367001R1111	1.010
				48...130	48...130		1 1	AF52-30-11-12	1SBL367001R1211	1.010
				100...250	100...250		1 1	AF52-30-11-13	1SBL367001R1311	0.990
				250...500	250...500		1 1	AF52-30-11-14	1SBL367001R1411	0.990
30	105	50	90	24...60	20...60	(1)	1 1	AF65-30-11-11	1SBL387001R1111	1.010
				48...130	48...130		1 1	AF65-30-11-12	1SBL387001R1211	1.010
				100...250	100...250		1 1	AF65-30-11-13	1SBL387001R1311	0.990
				250...500	250...500		1 1	AF65-30-11-14	1SBL387001R1411	0.990
37	125	60	105	24...60	20...60	(1)	1 1	AF80-30-11-11	1SBL397001R1111	1.260
				48...130	48...130		1 1	AF80-30-11-12	1SBL397001R1211	1.260
				100...250	100...250		1 1	AF80-30-11-13	1SBL397001R1311	1.210
				250...500	250...500		1 1	AF80-30-11-14	1SBL397001R1411	1.210
45	130	60	115	24...60	20...60	(1)	1 1	AF96-30-11-11	1SBL407001R1111	1.260
				48...130	48...130		1 1	AF96-30-11-12	1SBL407001R1211	1.260
				100...250	100...250		1 1	AF96-30-11-13	1SBL407001R1311	1.210
				250...500	250...500		1 1	AF96-30-11-14	1SBL407001R1411	1.210

(1) For control by PLC-output, use RA4 interface relay.

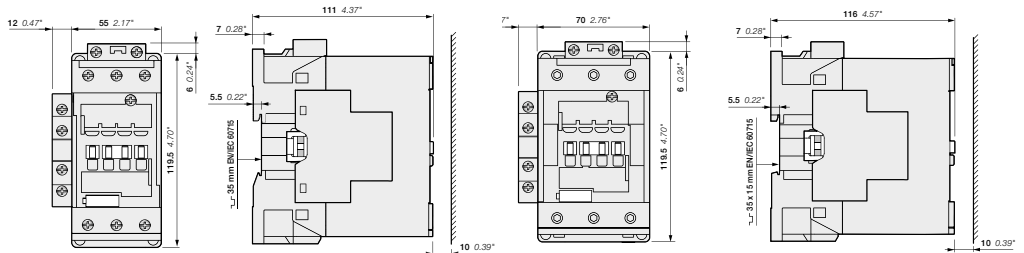

AF40, AF52, AF65-30-11...

AF80, AF96-30-11...

Main dimensions mm, inches

# AF40 ... AF96 3-pole contactors with 1 N.O. + 1 N.C. auxiliary contacts

## Contactors and main accessories

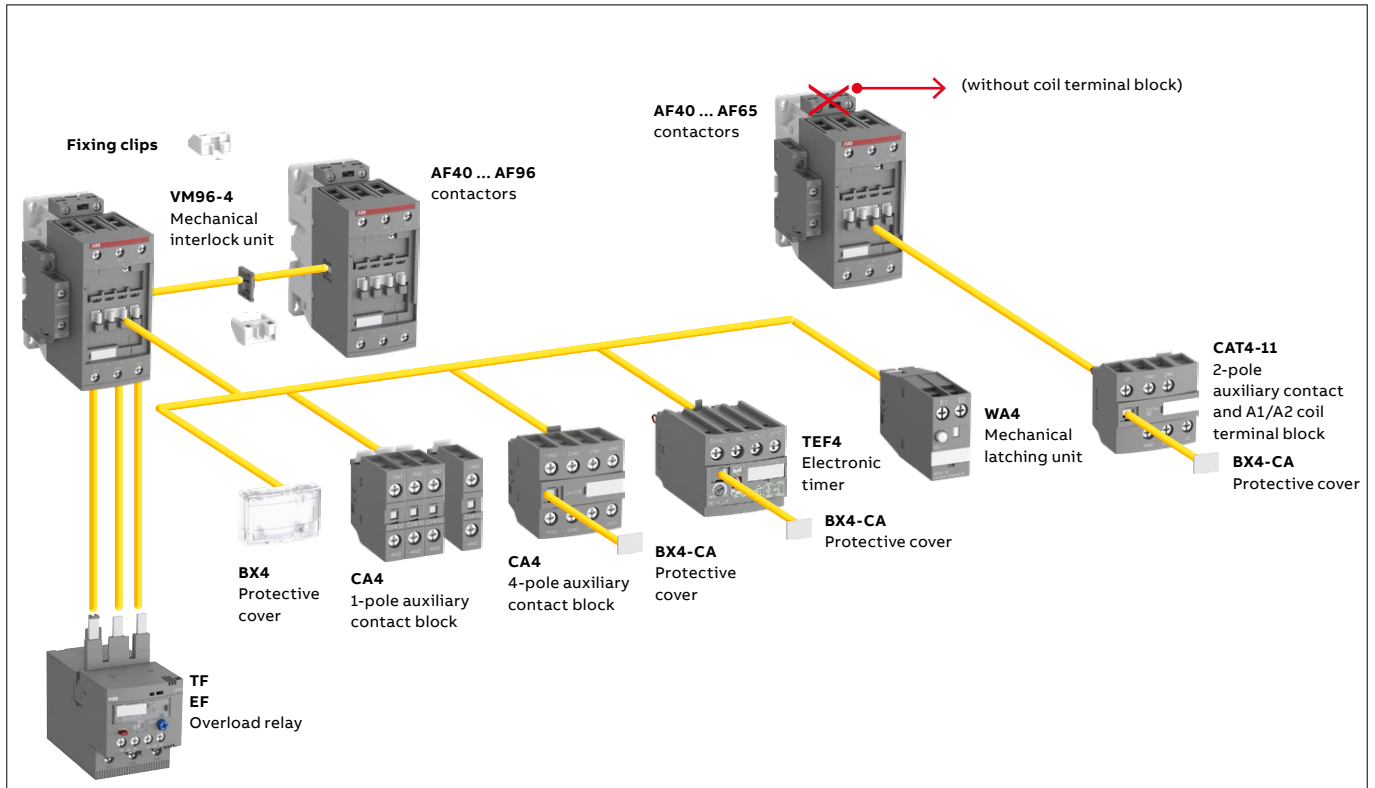

### Main accessory fitting details - for ordering details, technical data and other accessories: see section accessories

Many configurations of accessories are possible depending on whether these are front-mounted or side-mounted.

Contactor types	Main poles	Built-in auxiliary contacts	Front-mounted accessories			Electronic timer	Mechanical latching unit (1)	Side-mounted accessories	Auxiliary contact blocks	
			Auxiliary contact blocks						Mechanical interlock set (between 2 contactors)	Left side
AF40 ... AF65	3 0	1 1	1-pole CA4	2-pole CAT4-11	4-pole CA4	TEF4	WA4	VM96-4	2-pole CAL4-11	
			4 max.	or 1	or 1				Left side	Right side
AF80, AF96	3 0	1 1	4 max.	-	or 1	or 1	or 1	+ 1	-	1
			4 max.	-	or 1				or 1	-

(1) Use WA4 for AF09...AF65 and WA4-96 for AF80, AF96.  
Accept 1-pole CA4 auxiliary contacts on each side of the mechanical latch.

### Overload relays fitting details (2)

Contactor types	Thermal overload relays	Electronic overload relays
AF40 ... AF65	TF65 (22...67 A)	EF65 (20...70 A)
AF80, AF96	TF96 (40...96 A)	EF96 (36...100 A)

The addition of an overload relay on the contactor does not prevent fitting of many other accessories as shown above.  
(2) Direct mounting - No kit required.

# AF116 ... AF146 3-pole contactors

55 to 75 kW

AC / DC operated with 1 N.O. + 1 N.C. auxiliary contacts

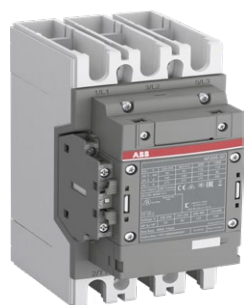

AF146-30-11

1SFC101266V0001

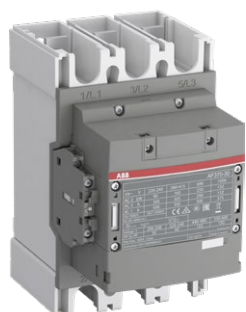

AF146-30-11B

1SFC101263V0001

AF116 ... AF140 contactors are mainly used for controlling 3-phase motors and power circuits up to 690 V AC, AF146 up to 1000 V AC and AF116 ... AF146 up to 260 V DC. These contactors are of the block type design with 3 main poles.

- control circuit: AC or DC operated with electronic coil interface accepting a wide control voltage range (e.g. 100...250 V AC and DC), only 4 coils to cover control voltages between 24...500 V 50/60 Hz and 20...500 V DC
  - can manage large control voltage variations
  - reduced panel energy consumption
  - very distinct closing and opening
  - can withstand short voltage dips and voltage sags (SEMI F47 conditions of use on request).
- built-in surge suppression
- add-on auxiliary contact blocks for side mounting and a wide range of accessories.

IEC	UL / CSA		Rated control circuit voltage	Auxiliary contacts fitted	Type (1)	Order code	Weight
Rated operational power	3-phase motor current $\theta \leq 40^\circ\text{C}$	General use rating	Uc min. ... Uc max.				Pkg (1 pce)
400 V AC-3 kW	AC-1 A	480 V hp	V 50/60 Hz V DC				kg

**For connection with built-in cable clamps**

Rated power (kW)	3-phase motor current (A)	General use rating (hp)	Rated control circuit voltage (V)	Uc min. (V)	Uc max. (V)	Auxiliary contacts	Type	Order code	Weight (kg)
55	160	75	160	24...60	20...60	1 1	AF116-30-11-11	1SFL427001R1111	1.750
				48...130	48...130	1 1	AF116-30-11-12	1SFL427001R1211	1.750
				100...250	100...250	1 1	AF116-30-11-13	1SFL427001R1311	1.750
				250...500	250...500	1 1	AF116-30-11-14	1SFL427001R1411	1.750
75	200	100	200	24...60	20...60	1 1	AF140-30-11-11	1SFL447001R1111	1.750
				48...130	48...130	1 1	AF140-30-11-12	1SFL447001R1211	1.750
				100...250	100...250	1 1	AF140-30-11-13	1SFL447001R1311	1.750
				250...500	250...500	1 1	AF140-30-11-14	1SFL447001R1411	1.750
75	225	100	200	24...60	20...60	1 1	AF146-30-11-11	1SFL467001R1111	1.750
				48...130	48...130	1 1	AF146-30-11-12	1SFL467001R1211	1.750
				100...250	100...250	1 1	AF146-30-11-13	1SFL467001R1311	1.750
				250...500	250...500	1 1	AF146-30-11-14	1SFL467001R1411	1.750

**With bar connections**

Rated power (kW)	3-phase motor current (A)	General use rating (hp)	Rated control circuit voltage (V)	Uc min. (V)	Uc max. (V)	Auxiliary contacts	Type	Order code	Weight (kg)
55	160	75	160	24...60	20...60	1 1	AF116-30-11B-11	1SFL427002R1111	1.500
				48...130	48...130	1 1	AF116-30-11B-12	1SFL427002R1211	1.500
				100...250	100...250	1 1	AF116-30-11B-13	1SFL427002R1311	1.500
				250...500	250...500	1 1	AF116-30-11B-14	1SFL427002R1411	1.500
75	200	100	200	24...60	20...60	1 1	AF140-30-11B-11	1SFL447002R1111	1.500
				48...130	48...130	1 1	AF140-30-11B-12	1SFL447002R1211	1.500
				100...250	100...250	1 1	AF140-30-11B-13	1SFL447002R1311	1.500
				250...500	250...500	1 1	AF140-30-11B-14	1SFL447002R1411	1.500
75	225	100	200	24...60	20...60	1 1	AF146-30-11B-11	1SFL467002R1111	1.500
				48...130	48...130	1 1	AF146-30-11B-12	1SFL467002R1211	1.500
				100...250	100...250	1 1	AF146-30-11B-13	1SFL467002R1311	1.500
				250...500	250...500	1 1	AF146-30-11B-14	1SFL467002R1411	1.500

(1) For other auxiliary contacts arrangements, please contact your ABB local sales organization.

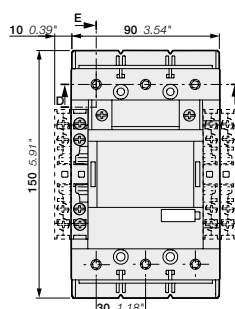

AF116, AF140, AF146-30-11

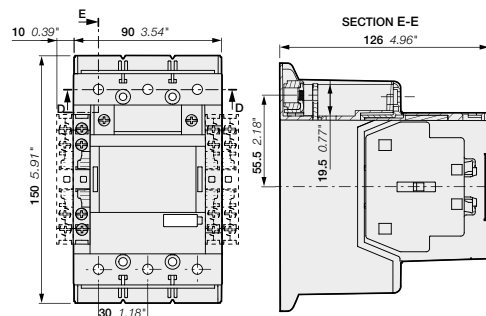

AF116, AF140, AF146-30-11B

Main dimensions mm, inches

1SFC101090CC201 - Rev.D

# AF116 ... AF146 3-pole contactors with built-in PLC interface

55 to 75 kW

AC / DC operated with 1 N.O. + 1 N.C. auxiliary contacts for faster opening utilization



AF146-30-11

1SFC101258V0001



AF146-30-11B

1SFC101258V0001

AF116 ... AF140 contactors are mainly used for controlling 3-phase motors and power circuits up to 690 V AC, AF146 up to 1000 V AC and AF116 ... AF146 up to 260 V DC. These contactors are of the block type design with 3 main poles.

- control circuit: AC or DC operated with electronic coil interface accepting a wide control voltage range (e.g. 100...250 V AC and DC), only 2 coils to cover control voltages between 100...500 V 50/60 Hz and 100...500 V DC
  - can manage large control voltage variations
  - reduced panel energy consumption
  - very distinct closing and opening
  - can withstand short voltage dips and voltage sags (SEMI F47 conditions of use on request)
  - opening time below 20 ms.
- built-in surge suppression
- add-on auxiliary contact blocks for side mounting and a wide range of accessories.

IEC	UL / CSA		Rated control circuit voltage		Auxiliary contacts fitted	Type (1)	Order code	Weight
Rated operational power	3-phase current $\theta \leq 40^\circ\text{C}$	General use motor rating	Uc min. ... Uc max.					Pkg (1 pce)
400 V AC-3 kW	AC-1 A	480 V hp	V 50/60 Hz	V DC				kg

**For connection with built-in cable clamps**

55	160	75	160	100...250	100...250	1 1	AF116-30-11-33	1SFL427001R3311	1.750
				250...500	250...500	1 1	AF116-30-11-34	1SFL427001R3411	1.750
75	200	100	200	100...250	100...250	1 1	AF140-30-11-33	1SFL447001R3311	1.750
				250...500	250...500	1 1	AF140-30-11-34	1SFL447001R3411	1.750
75	225	100	200	100...250	100...250	1 1	AF146-30-11-33	1SFL467001R3311	1.750
				250...500	250...500	1 1	AF146-30-11-34	1SFL467001R3411	1.750

**With bar connections**

55	160	75	160	100...250	100...250	1 1	AF116-30-11B-33	1SFL427002R3311	1.500
				250...500	250...500	1 1	AF116-30-11B-34	1SFL427002R3411	1.500
75	200	100	200	100...250	100...250	1 1	AF140-30-11B-33	1SFL447002R3311	1.500
				250...500	250...500	1 1	AF140-30-11B-34	1SFL447002R3411	1.500
75	225	100	200	100...250	100...250	1 1	AF146-30-11B-33	1SFL467002R3311	1.500
				250...500	250...500	1 1	AF146-30-11B-34	1SFL467002R3411	1.500

(1) For other auxiliary contacts arrangements, please contact your ABB local sales organization.

AF116 ... AF146 are equipped with low voltage inputs for control, for example by a PLC.

**Control inputs**

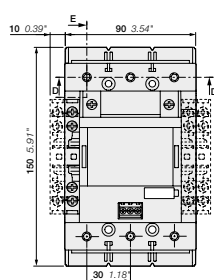
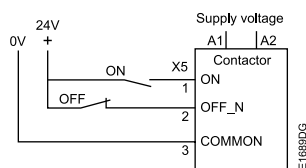

AF116, AF140, AF146-30-11

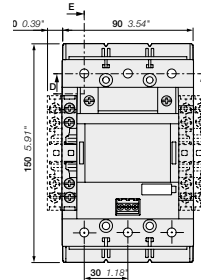
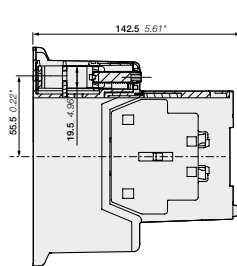

AF116, AF140, AF146-30-11B

Main dimensions mm, inches

1SFC10166FC0201 - Rev. A



# AF190 ... AF370 3-pole contactors

90 to 200 kW

AC / DC operated with 1 N.O. + 1 N.C. auxiliary contacts



AF205-30-11

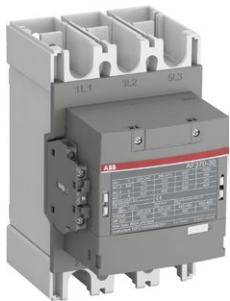

AF370-30-11

AF190 ... AF370 contactors are mainly used for controlling 3-phase motors and power circuits up to 1000 V AC and up to 340 V DC. These contactors are of the block type design with 3 main poles.

- control circuit: AC or DC operated with electronic coil interface accepting a wide control voltage range (e.g. 100...250 V AC and DC), only 4 coils to cover control voltages between 24...500 V 50/60 Hz and 20...500 V DC
  - can manage large control voltage variations
  - reduced panel energy consumption
  - very distinct closing and opening
  - can withstand short voltage dips and voltage sags (SEMI F47 conditions of use on request).
- built-in surge suppression
- add-on auxiliary contact blocks for side mounting and a wide range of accessories.

IEC Rated operational power	UL / CSA 3-phase motor rating 480 V	General use rating 600 V AC	Rated control circuit voltage Uc min. ... Uc max.		Auxiliary contacts fitted	Type (1)	Order code	Weight  Pkg (1 pce)  kg										
			V 50/60 Hz	V DC														
400 V AC-3 kW	AC-1 A	hp	A	V 50/60 Hz	V DC			kg										
									90	275	125	250	24...60	20...60	1 1	AF190-30-11-11	1SFL487002R1111	3.000
													48...130	48...130	1 1	AF190-30-11-12	1SFL487002R1211	3.000
													100...250	100...250	1 1	AF190-30-11-13	1SFL487002R1311	3.000
				250...500	250...500	1 1	AF190-30-11-14	1SFL487002R1411	3.000									
110	350	150	300	24...60	20...60	1 1	AF205-30-11-11	1SFL527002R1111	3.000									
										48...130	48...130	1 1	AF205-30-11-12	1SFL527002R1211	3.000			
										100...250	100...250	1 1	AF205-30-11-13	1SFL527002R1311	3.000			
										250...500	250...500	1 1	AF205-30-11-14	1SFL527002R1411	3.000			
132	400	200	350	24...60	20...60	1 1	AF265-30-11-11	1SFL547002R1111	4.640									
										48...130	48...130	1 1	AF265-30-11-12	1SFL547002R1211	4.640			
										100...250	100...250	1 1	AF265-30-11-13	1SFL547002R1311	4.640			
										250...500	250...500	1 1	AF265-30-11-14	1SFL547002R1411	4.640			
160	500	250	400	24...60	20...60	1 1	AF305-30-11-11	1SFL587002R1111	4.640									
										48...130	48...130	1 1	AF305-30-11-12	1SFL587002R1211	4.640			
										100...250	100...250	1 1	AF305-30-11-13	1SFL587002R1311	4.640			
										250...500	250...500	1 1	AF305-30-11-14	1SFL587002R1411	4.640			
200	600	300	520	24...60	20...60	1 1	AF370-30-11-11	1SFL607002R1111	4.640									
										48...130	48...130	1 1	AF370-30-11-12	1SFL607002R1211	4.640			
										100...250	100...250	1 1	AF370-30-11-13	1SFL607002R1311	4.640			
										250...500	250...500	1 1	AF370-30-11-14	1SFL607002R1411	4.640			

(1) For other auxiliary contacts arrangements, please contact your ABB local sales organization.

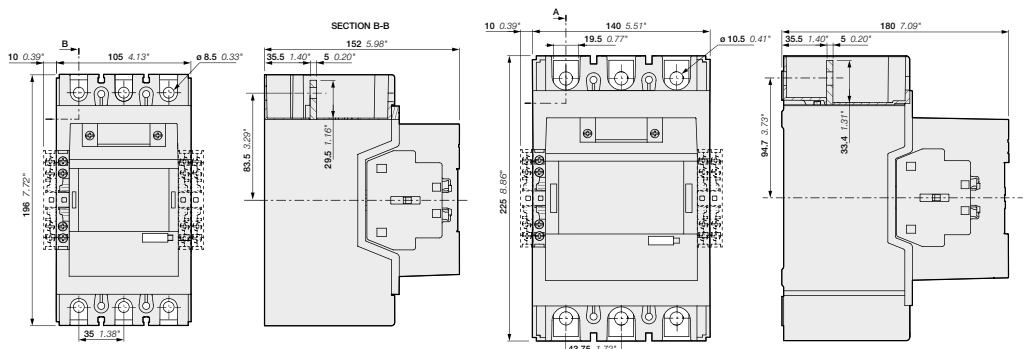

AF190, AF205

AF265, AF305, AF370

Main dimensions mm, inches

1SFLC10109FC0201-Rev. E

# AF190 ... AF370 3-pole contactors with built-in PLC interface

90 to 200 kW

AC / DC operated with 1 N.O. + 1 N.C. auxiliary contacts for faster opening utilization

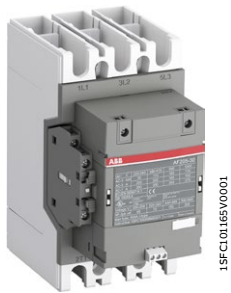

AF205-30-11

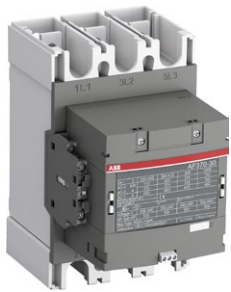

AF370-30-11

AF190 ... AF370 contactors are mainly used for controlling 3-phase motors and power circuits up to 1000 V AC and up to 340 V DC. These contactors are of the block type design with 3 main poles.

- control circuit: AC or DC operated with electronic coil interface accepting a wide control voltage range (e.g. 100...250 V AC and DC), only 2 coils to cover control voltages between 100...500 V 50/60 Hz and 100...500 V DC
  - can manage large control voltage variations
  - reduced panel energy consumption
  - very distinct closing and opening
  - can withstand short voltage dips and voltage sags (SEMI F47 conditions of use on request)
  - opening time below 20 ms.
- built-in surge suppression
- add-on auxiliary contact blocks for side mounting and a wide range of accessories.

IEC	UL / CSA		Rated control circuit voltage Uc min. ... Uc max.	Auxiliary contacts fitted	Type (1)	Order code	Weight		
	Rated operational power	3-phase motor rating						General use rating	Pkg (1 pce)
400 V AC-3 kW	current $\theta \leq 40^\circ\text{C}$	480 V	600 V AC				kg		
90	275	125	250	V 50/60 Hz	V DC				
				100...250	100...250	1 1	AF190-30-11-33	1SFL487002R3311	3.000
				250...500	250...500	1 1	AF190-30-11-34	1SFL487002R3411	3.000
110	350	150	300	100...250	100...250	1 1	AF205-30-11-33	1SFL527002R3311	3.000
				250...500	250...500	1 1	AF205-30-11-34	1SFL527002R3411	3.000
132	400	200	350	100...250	100...250	1 1	AF265-30-11-33	1SFL547002R3311	4.640
				250...500	250...500	1 1	AF265-30-11-34	1SFL547002R3411	4.640
160	500	250	400	100...250	100...250	1 1	AF305-30-11-33	1SFL587002R3311	4.640
				250...500	250...500	1 1	AF305-30-11-34	1SFL587002R3411	4.640
200	600	300	520	100...250	100...250	1 1	AF370-30-11-33	1SFL607002R3311	4.640
				250...500	250...500	1 1	AF370-30-11-34	1SFL607002R3411	4.640

(1) For other auxiliary contacts arrangements, please contact your ABB local sales organization.

AF190 ... AF370 are equipped with low voltage inputs for control, for example by a PLC.

### Control inputs

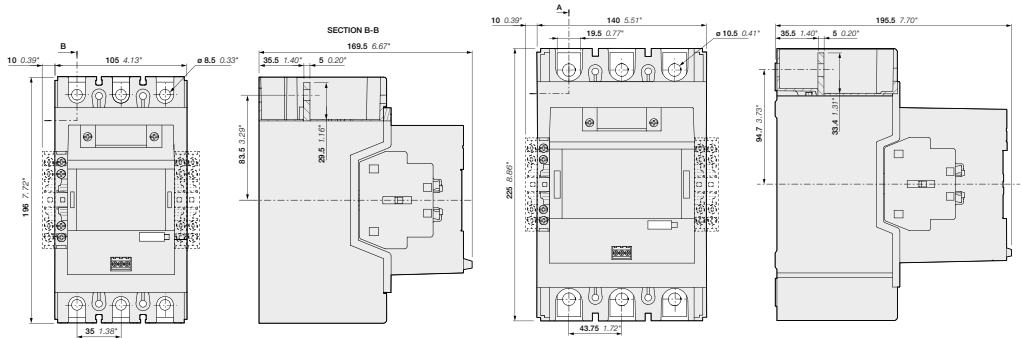
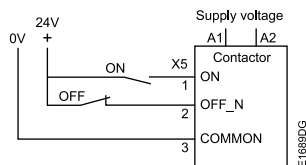

AF190, AF205

AF265, AF305, AF370

Main dimensions mm, inches

1SFC1016TC0201 - Rev. A

# AF116 ... AF370 3-pole contactors with 1 N.O. + 1 N.C. auxiliary contacts

## Contactors and main accessories

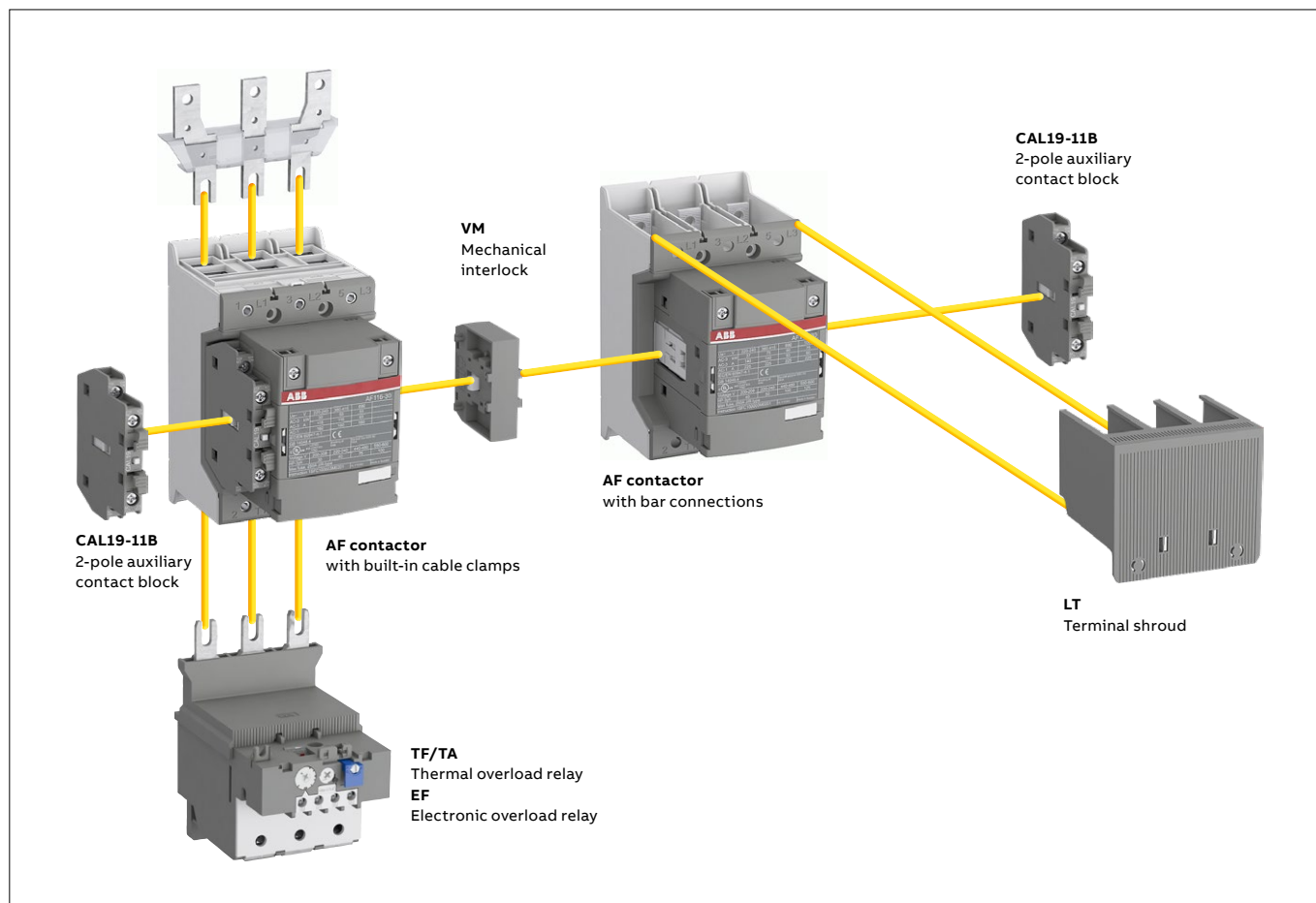

### Main accessory fitting details - for ordering details, technical data and other accessories: see section accessories

Contactor types	Main poles	Available auxiliary contacts	Side-mounted accessories Auxiliary contact blocks	Mechanical interlock units (between two contactors)
			<b>CAL19-11 (3)</b>	
AF116 ... AF370	3 0	1 1	1 x CAL19-11	-
AF116 ... AF370	3 0	1 1	-	+ VM... (2)

- (1) Total number of auxiliary contact blocks for the two contactors.
- (2) Interlock type, according to the contactor ratings (see "Accessories").
- (3) The CEL19 auxiliary contact blocks can replace the CAL19-11 and CAL19-11B. Though, no auxiliary contact block can be mounted outside the CEL19.

### Overload relays fitting details (1)

Contactor types	Thermal overload relays	Electronic overload relays
AF116 ... AF140	TF140DU (66...142 A)	EF146 (54...150 A)
AF146	-	EF146 (54...150 A)
AF190, AF205	TA200DU (66...200 A)	EF205 (63...210 A)
AF265 ... AF370	-	EF370 (115...380 A)

The addition of a thermal or electronic overload relay on the contactor does not prevent fitting of many other accessories as shown in "Main accessory fitting details" table.  
 (1) Direct mounting - No kit required.

# AF400 ... AF750 3-pole contactors

200 to 400 kW

AC / DC operated with 1 N.O. + 1 N.C. auxiliary contacts



AF460-30-11

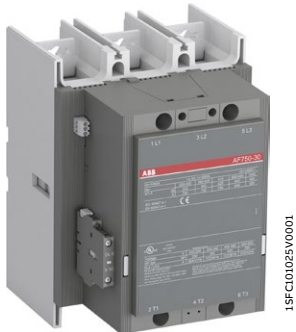

AF750-30-11

AF400 ... AF750 contactors are mainly used for controlling 3-phase motors and power circuits up to 1000 V AC or 600 V DC (2). These contactors are of the block type design with 3 main poles.

- control circuit: AC or DC operated with electronic coil interface accepting a wide control voltage range (e.g. 100...250 V AC and DC), only 4 coils to cover control voltages between 48...500 V 50/60 Hz and 24...500 V DC
  - can manage large control voltage variations
  - reduced panel energy consumption
  - very distinct closing and opening
  - can withstand short voltage dips and voltages sags (SEMI F47 conditions of use on request).
- built-in surge suppression
- add-on auxiliary contact blocks for side mounting and a wide range of accessories.

IEC Rated operational power 400 V AC-3 kW	UL/CSA 3-phase motor rating 480 V hp	General use rating 600 V AC A	Rated control circuit voltage Uc min. ... Uc max.		Auxiliary contacts fitted	Type	Order code	Weight  Pkg (1 pce)  kg
			V 50/60 Hz	V DC				
200	350	550	-	24...60	1 1	AF400-30-11	1SFL577001R6811 (1)	12.000
			48...130	48...130	1 1	AF400-30-11	1SFL577001R6911	12.000
			100...250	100...250	1 1	AF400-30-11	1SFL577001R7011	12.000
			250...500	250...500	1 1	AF400-30-11	1SFL577001R7111	12.000
250	400	650	-	24...60	1 1	AF460-30-11	1SFL597001R6811 (1)	12.000
			48...130	48...130	1 1	AF460-30-11	1SFL597001R6911	12.000
			100...250	100...250	1 1	AF460-30-11	1SFL597001R7011	12.000
			250...500	250...500	1 1	AF460-30-11	1SFL597001R7111	12.000
315	500	750	-	24...60	1 1	AF580-30-11	1SFL617001R6811 (1)	15.000
			48...130	48...130	1 1	AF580-30-11	1SFL617001R6911	15.000
			100...250	100...250	1 1	AF580-30-11	1SFL617001R7011	15.000
			250...500	250...500	1 1	AF580-30-11	1SFL617001R7111	15.000
400	600	900	-	24...60	1 1	AF750-30-11	1SFL637001R6811 (1)	15.000
			48...130	48...130	1 1	AF750-30-11	1SFL637001R6911	15.000
			100...250	100...250	1 1	AF750-30-11	1SFL637001R7011	15.000
			250...500	250...500	1 1	AF750-30-11	1SFL637001R7111	15.000

(1) The connection polarities indicated close to the coil terminals must be respected: A1 for the positive pole and A2 for the negative pole.  
 (2) Up to 850 V DC for AF580, AF750.

AF400 ... AF750 are equipped with low voltage inputs for control, for example by a PLC.

### Control inputs

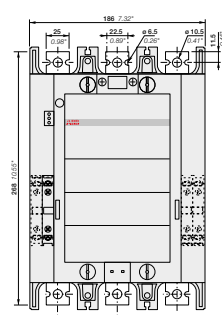
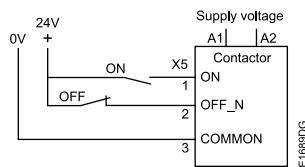

AF400, AF460

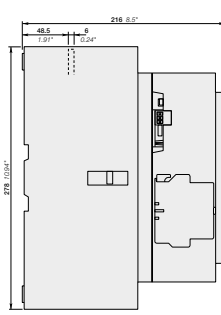

AF580, AF750

Main dimensions mm, inches

# AF1250 ... AF2850 3-pole contactors

475 to 560 kW and 1260 to 2850 A AC-1

AC / DC operated with 1 N.O. + 1 N.C. auxiliary contacts



AF1250-30-11

1SFC101027V0001



AF2650-30-11

1SFC101031V0001

AF1250 ... AF2050 contactors are mainly used for controlling power circuits up to 1000 V AC or 850 V DC, AF2650 and AF2850 for controlling power up to 1000 V AC. These contactors are of the block type design with 3 main poles.

– control circuit: AC or DC operated with electronic coil interface accepting a wide control voltage range

(e.g. 100...250 V AC and DC)

- only 4 coils for AF1250 to cover control voltages between 48...500 V 50/60 Hz and 24...500 V DC
- only 1 coil for AF1350 ... AF2850 to cover control voltages between 100...250 V 50/60 Hz and 100...250 V DC
- can manage large control voltage variations
- reduced panel energy consumption
- very distinct closing and opening
- can withstand short voltage dips and voltages sags (SEMI F47 conditions of use on request).
- built-in surge suppression
- add-on auxiliary contact blocks for side mounting and a wide range of accessories.

IEC	UL/CSA		Rated control circuit voltage U <sub>c</sub>		Auxiliary contacts fitted	Type	Order code	Weight
Rated operational power	3-phase motor rating	General use rating	(1)					Pkg (1 pce)
400 V AC-3 kW	690 V AC-1 A	480 V hp	600 V AC (2) A	V 50/60 Hz				V DC
-	1260	-	1210	-	1 1	AF1250-30-11	1SFL647001R6811 (1)	16.000
				48...130	1 1	AF1250-30-11	1SFL647001R6911	16.000
				100...250	1 1	AF1250-30-11	1SFL647001R7011	16.000
				250...500	1 1	AF1250-30-11	1SFL647001R7111	16.000
475	1350	800	1350	100...250	1 1	AF1350-30-11	1SFL657001R7011	34.000
560	1650	900	1650	100...250	1 1	AF1650-30-11	1SFL677001R7011	35.000
-	2050	-	2100	100...250	1 1	AF2050-30-11	1SFL707001R7011	35.000
-	2650	-	2700	100...250	1 1	AF2650-30-11	1SFL667001R7011	45.000
-	2850	-	2850	100...250	1 1	AF2850-30-11	1SFL687001R7011	45.000

(1) The connection polarities indicated close to the coil terminals must be respected: A1 for the positive pole and A2 for the negative pole. (2) AF2650: Maximum operational voltage = 1000 V according to UL / CSA.

AF1250 ... AF2850 are equipped with low voltage inputs for control, for example by a PLC

### Control inputs

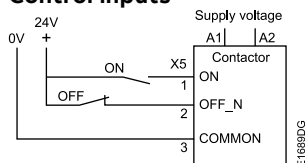

	AF1350, AF1650, AF2050	AF2650, AF2850
<b>A</b>	392 mm / 15.43"	422 mm / 16.61"
<b>B</b>	47 mm / 1.85"	53 mm / 2.09"
<b>C</b>	10 mm / 0.39"	25 mm / 0.98"

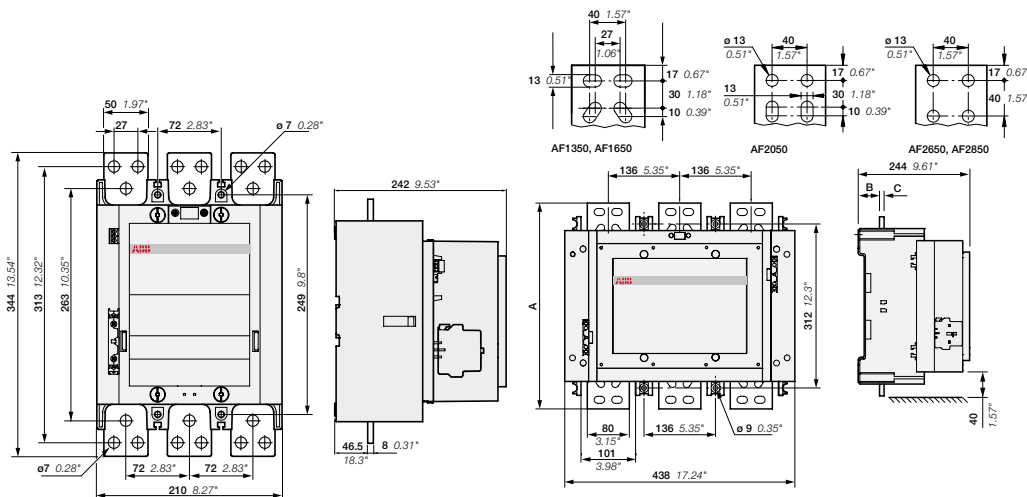

AF1250

AF1350, AF1650, AF2050, AF2650, AF2850

Main dimensions mm, inches

# AF1350T ... AF2850T 3-pole contactors with built-in LVRT

475 to 560 kW and 1350 to 2850 A AC-1

AC operated with 1 N.O. + 1 N.C. auxiliary contacts



AF2650-30T-11

1SFC1016V0001

AF1350T .. AF2850T contactors are designed to meet the Low Voltage Ride Through requirements for grid connections withstand voltage drop-outs up to 1 sec without opening. These contactors are often used in grid connected applications where the demand of non interrupted power is required. When controlled through built-in PLC connection the contactor is operated directly without delay function.

- Control circuit: AC or DC operated with electronic coil interface
  - can withstand voltage drop-outs according to Low Voltage Ride Through requirements
  - equipped with low voltage inputs for direct control by a PLC
  - distinct closing and opening
  - add-on auxiliary contact blocks for side mounting and a wide range of accessories.

IEC	UL/CSA		Rated control circuit voltage Uc	Auxiliary contacts fitted	Type	Order code	Weight
Rated operational power	current θ ≤ 40 °C	3-phase motor rating	General use rating				Pkg (1 pce)
400 V AC-3	690 V AC-1	480 V	600 V AC	V 50/60 Hz			kg
475	1350	800	1350	220 ... 240	1 1	AF1350T-30-11 (1) 1SFL657001R9101	34.000
560	1650	900	1650	220 ... 240	1 1	AF1650T-30-11 (1) 1SFL677001R9101	35.000
-	2050	-	2100	220 ... 240	1 1	AF2050T-30-11 (1) 1SFL707001R9101	35.000
-	2650	-	2700	220 ... 240	1 1	AF2650T-30-11 (1) 1SFL667001R9101	45.000
-	2850	-	2850	220 ... 240	1 1	AF2850T-30-11 (1) 1SFL687001R9101	45.000

(1) Types -00 and -22 on request.

Control inputs

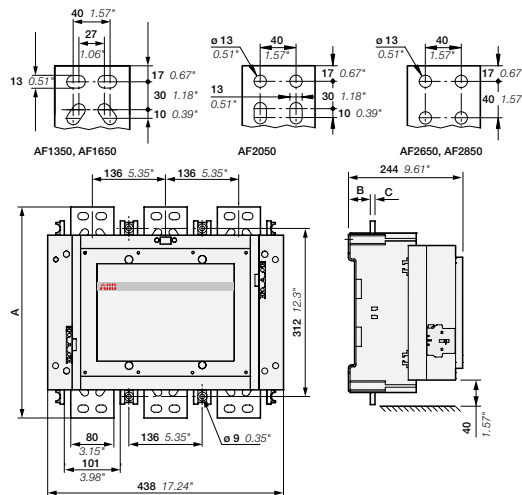
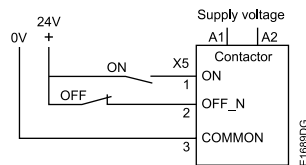

AF1350T-30-11, AF1650T-30-11, AF2050T-30-11, AF2650T-30-11, AF2850T-30-10-11

Main dimensions mm, inches

	AF1350, AF1650, AF2050	AF2650, AF2850
A	392 mm / 15.43"	422 mm / 16.61"
B	47 mm / 1.85"	53 mm / 2.09"
C	10 mm / 0.39"	25 mm / 0.98"

1SFC1016V0001 - Rev. A



# AF400 ... AF2850 3-pole contactors with 1 N.O. + 1 N.C. auxiliary contacts

## Contactors and main accessories

### Main accessories (other accessories available)

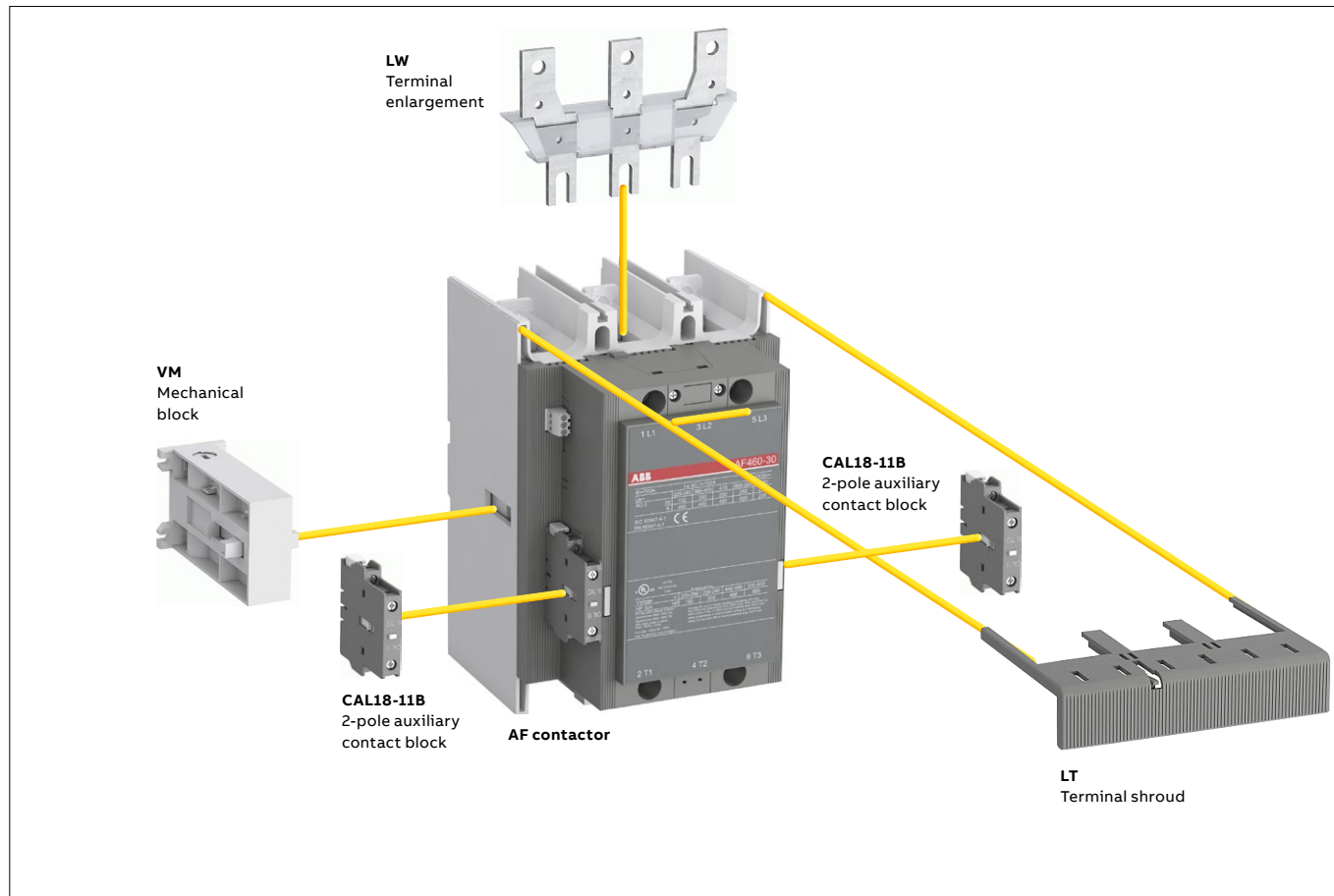

### Main accessory fitting details - for ordering details, technical data and other accessories: see section accessories

Contactor types	Main poles	Available auxiliary contacts	Side-mounted accessories Auxiliary contact blocks	Mechanical interlock units (between two contactors)
			CAL18-11      CAL18-11B (3)	
<b>Contactors + auxiliary contact blocks</b>				
AF400...AF2850	3 0	1 1	1 x CAL18-11      + 2 x CAL18-11B	-
<b>Contactors with mechanical interlocking + auxiliary contact blocks</b>				
AF400...AF2850	3 0	1 1	2 x CAL18-11 (1)      + 4 x CAL18-11B (1)	+ VM...H (2)

(1) Total number of auxiliary contact blocks for the two contactors.      (2) Interlock type, according to the contactor ratings (see "Accessories").  
 (3) The CEL18... auxiliary contact blocks can replace the CAL18-11 and CAL18-11B. Though, no auxiliary contact block can be mounted outside the CEL18-..

### Overload relays fitting details

Contactor types	Thermal overload relays	Electronic overload relays
AF400, AF460	-	EF460 (150...500 A) (1)
AF580, AF750	-	EF750 (250...800 A) (1)
AF1350, AF1650	-	EF1250DU (375...1250 A) (1)

The addition of a thermal or electronic overload relay on the contactor does not prevent fitting of many other accessories as shown in "Main accessory fitting details" table.  
 (1) Mounting kit required (see "Motor protection").

# AF09 ... AF38 3-pole contactors

4 to 18.5 kW

AC / DC operated with 2 N.O. + 2 N.C. auxiliary contacts



AF09-30-22



AF26-30-22

- AF09 ... AF38 contactors are mainly used for controlling 3-phase motors and power circuits up to 690 V AC and 220 V DC. These contactors are of the block type design with 3 main poles (1st stack):
  - 2nd stack with permanently fixed auxiliary contact block. The built-in auxiliary contact elements are mechanically linked (side-marked symbol) and the N.C. auxiliary contacts are mirror contacts
  - control circuit: AC or DC operated with electronic coil interface accepting a wide control voltage range (e.g. 100...250 V AC and DC), only 4 control voltage ranges covering 24...500 V 50/60 Hz and 20...500 V DC
    - can manage large control voltage variations
    - reduced panel energy consumption
    - very distinct closing and opening.
  - built-in surge suppression
  - add-on auxiliary contact blocks for side mounting and a wide range of accessories.

IEC Rated operational power	UL/CSA 3-phase motor rating 480 V	General use rating 600 V AC	Rated control circuit voltage Uc min. ... Uc max.		Auxiliary contacts fitted	Type	Order code	Weight  Pkg (1 pce)  kg										
			V 50/60 Hz	V DC														
400 V AC-3 kW	AC-1 A	hp	A	(1)														
									4	25	5	25	24...60	20...60	2 2	AF09-30-22-11	1SBL137001R1122	0.320
													48...130	48...130	2 2	AF09-30-22-12	1SBL137001R1222	0.320
													100...250	100...250	2 2	AF09-30-22-13	1SBL137001R1322	0.320
								250...500	250...500	2 2	AF09-30-22-14	1SBL137001R1422	0.360					
5.5	28	7.5	28	(1)														
													24...60	20...60	2 2	AF12-30-22-11	1SBL157001R1122	0.320
													48...130	48...130	2 2	AF12-30-22-12	1SBL157001R1222	0.320
													100...250	100...250	2 2	AF12-30-22-13	1SBL157001R1322	0.320
								250...500	250...500	2 2	AF12-30-22-14	1SBL157001R1422	0.360					
7.5	30	10	30	(1)														
													24...60	20...60	2 2	AF16-30-22-11	1SBL177001R1122	0.320
													48...130	48...130	2 2	AF16-30-22-12	1SBL177001R1222	0.320
													100...250	100...250	2 2	AF16-30-22-13	1SBL177001R1322	0.320
								250...500	250...500	2 2	AF16-30-22-14	1SBL177001R1422	0.360					
11	45	15	45	(1)														
													24...60	20...60	2 2	AF26-30-22-11	1SBL237001R1122	0.360
													48...130	48...130	2 2	AF26-30-22-12	1SBL237001R1222	0.360
													100...250	100...250	2 2	AF26-30-22-13	1SBL237001R1322	0.360
								250...500	250...500	2 2	AF26-30-22-14	1SBL237001R1422	0.400					
15	50	20	50	(1)														
													24...60	20...60	2 2	AF30-30-22-11	1SBL277001R1122	0.360
													48...130	48...130	2 2	AF30-30-22-12	1SBL277001R1222	0.360
													100...250	100...250	2 2	AF30-30-22-13	1SBL277001R1322	0.360
								250...500	250...500	2 2	AF30-30-22-14	1SBL277001R1422	0.400					
18.5	50	25	50	(1)														
													24...60	20...60	2 2	AF38-30-22-11	1SBL297001R1122	0.360
													48...130	48...130	2 2	AF38-30-22-12	1SBL297001R1222	0.360
													100...250	100...250	2 2	AF38-30-22-13	1SBL297001R1322	0.360
								250...500	250...500	2 2	AF38-30-22-14	1SBL297001R1422	0.400					

(1) AF...-30-...-11 not suitable for direct control by PLC-output.

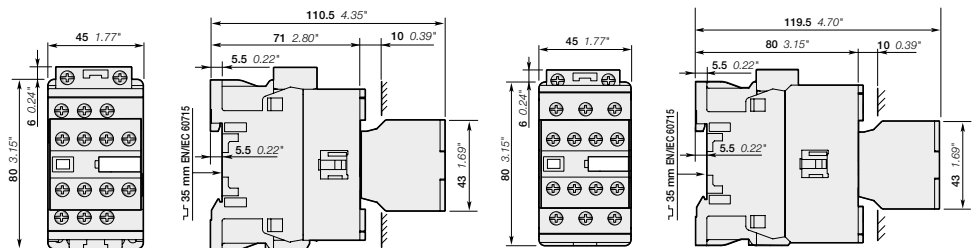

AF09, AF12, AF16

AF26, AF30, AF38

Main dimensions mm, inches

# AF09Z ... AF38Z 3-pole contactors

4 to 18.5 kW

AC / DC operated for specific applications with 2 N.O. + 2 N.C. auxiliary contacts

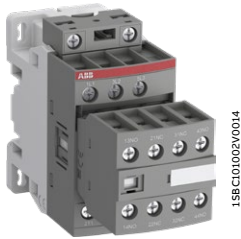

AF09Z-30-22



AF26Z-30-22

AF09Z ... AF38Z contactors are mainly used for controlling 3-phase motors and power circuits up to 690 V AC and 220 V DC. These contactors are of the block type design with 3 main poles (1st stack):

- 2nd stack with permanently fixed auxiliary contact block. The built-in auxiliary contact elements are mechanically linked (side-marked symbol) and the N.C. auxiliary contacts are mirror contacts
- control circuit: AC or DC operated with electronic coil interface accepting a wide control voltage range (e.g. 100...250 V AC and DC), only 4 control voltage ranges covering 24...250 V 50/60 Hz and 12...250 V DC
  - can manage large control voltage variations,
  - allow direct control by PLC-output  $\geq 24$  V DC 500 mA,
  - reduced panel energy consumption,
  - very distinct closing and opening,
  - can withstand short voltage dips and voltage sags (SEMI F47-0706 conditions of use on request).
- built-in surge suppression
- add-on auxiliary contact blocks for side mounting and a wide range of accessories.

IEC Rated operational power	UL/CSA 3-phase motor rating 480 V	General use rating 600 V AC	Rated control circuit voltage Uc min. ... Uc max.		Auxiliary contacts fitted	Type	Order code	Weight Pkg (1 pce) kg	
			V 50/60 Hz	V DC					
400 V AC-3 kW	AC-1 A	hp	A	-	12...20	2 2	AF09Z-30-22-20	1SBL136001R2022	0.360
				24...60	20...60	2 2	AF09Z-30-22-21	1SBL136001R2122	0.360
				48...130	48...130	2 2	AF09Z-30-22-22	1SBL136001R2222	0.360
				100...250	100...250	2 2	AF09Z-30-22-23	1SBL136001R2322	0.360
5.5	28	7.5	28	-	12...20	2 2	AF12Z-30-22-20	1SBL156001R2022	0.360
				24...60	20...60	2 2	AF12Z-30-22-21	1SBL156001R2122	0.360
				48...130	48...130	2 2	AF12Z-30-22-22	1SBL156001R2222	0.360
				100...250	100...250	2 2	AF12Z-30-22-23	1SBL156001R2322	0.360
7.5	30	10	30	-	12...20	2 2	AF16Z-30-22-20	1SBL176001R2022	0.360
				24...60	20...60	2 2	AF16Z-30-22-21	1SBL176001R2122	0.360
				48...130	48...130	2 2	AF16Z-30-22-22	1SBL176001R2222	0.360
				100...250	100...250	2 2	AF16Z-30-22-23	1SBL176001R2322	0.360
11	45	15	45	-	12...20	2 2	AF26Z-30-22-20	1SBL236001R2022	0.400
				24...60	20...60	2 2	AF26Z-30-22-21	1SBL236001R2122	0.400
				48...130	48...130	2 2	AF26Z-30-22-22	1SBL236001R2222	0.400
				100...250	100...250	2 2	AF26Z-30-22-23	1SBL236001R2322	0.400
15	50	20	50	-	12...20	2 2	AF30Z-30-22-20	1SBL276001R2022	0.400
				24...60	20...60	2 2	AF30Z-30-22-21	1SBL276001R2122	0.400
				48...130	48...130	2 2	AF30Z-30-22-22	1SBL276001R2222	0.400
				100...250	100...250	2 2	AF30Z-30-22-23	1SBL276001R2322	0.400
18.5	50	25	50	-	12...20	2 2	AF38Z-30-22-20	1SBL296001R2022	0.400
				24...60	20...60	2 2	AF38Z-30-22-21	1SBL296001R2122	0.400
				48...130	48...130	2 2	AF38Z-30-22-22	1SBL296001R2222	0.400
				100...250	100...250	2 2	AF38Z-30-22-23	1SBL296001R2322	0.400

Note: Only AF..Z contactors with DC control voltage 12...20 V DC need to respect the connection polarities indicated close to the coil terminals: A1+ for the positive pole and A2- for the negative pole

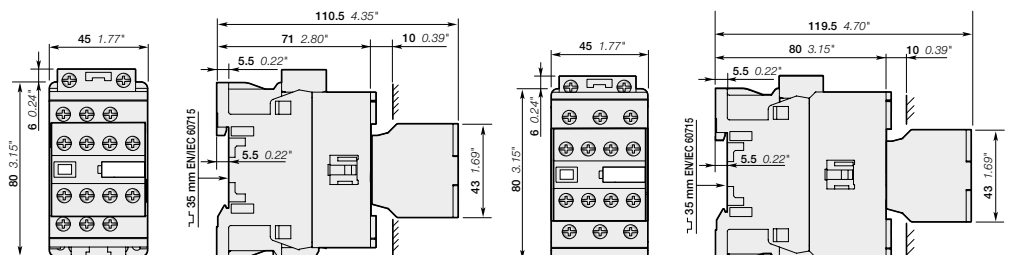

AF09Z, AF12Z, AF16Z  
Main dimensions mm, inches

AF26Z, AF30Z, AF38Z

1SBC10137450201-Rev. B

# AF40 ... AF96 3-pole contactors

18.5 to 30 kW

AC / DC operated with 2 N.O. + 2 N.C. auxiliary contacts



AF40-30-22



AF80-30-22

AF40 ... AF96 contactors are mainly used for controlling 3-phase motors and power circuits up to 690 V AC and 220 V DC. These contactors are of the block type design with 3 main poles (1st stack):

- 2nd stack with permanently fixed auxiliary contact block. The built-in auxiliary contact elements are mechanically linked (side-marked symbol) and the N.C. auxiliary contacts are mirror contacts
- control circuit: AC or DC operated with electronic coil interface accepting a wide control voltage range (e.g. 100...250 V AC and DC), only 4 control voltage ranges covering 24...500 V 50/60 Hz and 20...500 V DC
  - can manage large control voltage variations
  - reduced panel energy consumption
  - very distinct closing and opening
  - can withstand short voltage dips and voltage sags (SEMI F47-0706 conditions of use on request).
- built-in surge suppression
- add-on auxiliary contact blocks for side mounting and a wide range of accessories.

IEC	UL / CSA		Rated control circuit voltage		Auxiliary contacts fitted	Type	Order code	Weight	
	Rated operational power	3-phase motor rating	General use rating	Uc min. ... Uc max.					Pkg (1 pce)
400 V AC-3 kW	current $\theta \leq 40^\circ\text{C}$	480 V	600 V AC	V 50/60 Hz	V DC			kg	
18.5	70	30	60	24...60	20...60 (1)	2 2	AF40-30-22-11	1SBL347001R1122	1.020
				48...130	48...130	2 2	AF40-30-22-12	1SBL347001R1222	1.020
				100...250	100...250	2 2	AF40-30-22-13	1SBL347001R1322	1.000
				250...500	250...500	2 2	AF40-30-22-14	1SBL347001R1422	1.000
22	100	40	80	24...60	20...60 (1)	2 2	AF52-30-22-11	1SBL367001R1122	1.020
				48...130	48...130	2 2	AF52-30-22-12	1SBL367001R1222	1.020
				100...250	100...250	2 2	AF52-30-22-13	1SBL367001R1322	1.000
				250...500	250...500	2 2	AF52-30-22-14	1SBL367001R1422	1.000
30	105	50	90	24...60	20...60 (1)	2 2	AF65-30-22-11	1SBL387001R1122	1.020
				48...130	48...130	2 2	AF65-30-22-12	1SBL387001R1222	1.020
				100...250	100...250	2 2	AF65-30-22-13	1SBL387001R1322	1.000
				250...500	250...500	2 2	AF65-30-22-14	1SBL387001R1422	1.000
37	125	60	105	24...60	20...60 (1)	2 2	AF80-30-22-11	1SBL397001R1122	1.270
				48...130	48...130	2 2	AF80-30-22-12	1SBL397001R1222	1.270
				100...250	100...250	2 2	AF80-30-22-13	1SBL397001R1322	1.220
				250...500	250...500	2 2	AF80-30-22-14	1SBL397001R1422	1.220
45	130	60	115	24...60	20...60 (1)	2 2	AF96-30-22-11	1SBL407001R1122	1.270
				48...130	48...130	2 2	AF96-30-22-12	1SBL407001R1222	1.270
				100...250	100...250	2 2	AF96-30-22-13	1SBL407001R1322	1.220
				250...500	250...500	2 2	AF96-30-22-14	1SBL407001R1422	1.220

(1) For control by PLC-output, use RA4 interface relay.

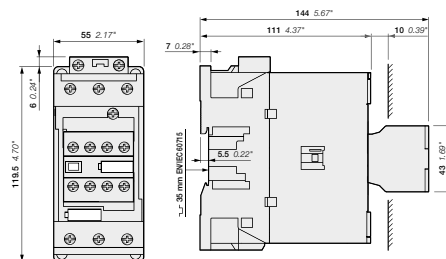

AF40, AF52, AF65-30-22-..

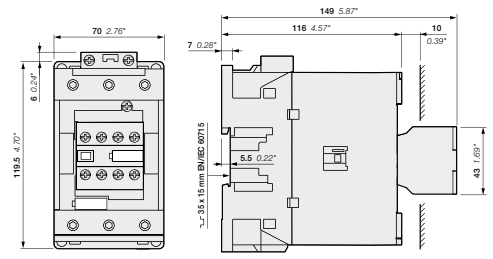

AF80, AF96-30-22-..

Main dimensions mm, inches

1SBC101742-50201 - Rev. A

# AF09 ... AF96 3-pole contactors with 2 N.O. + 2 N.C. auxiliary contacts

Contactors and main accessories

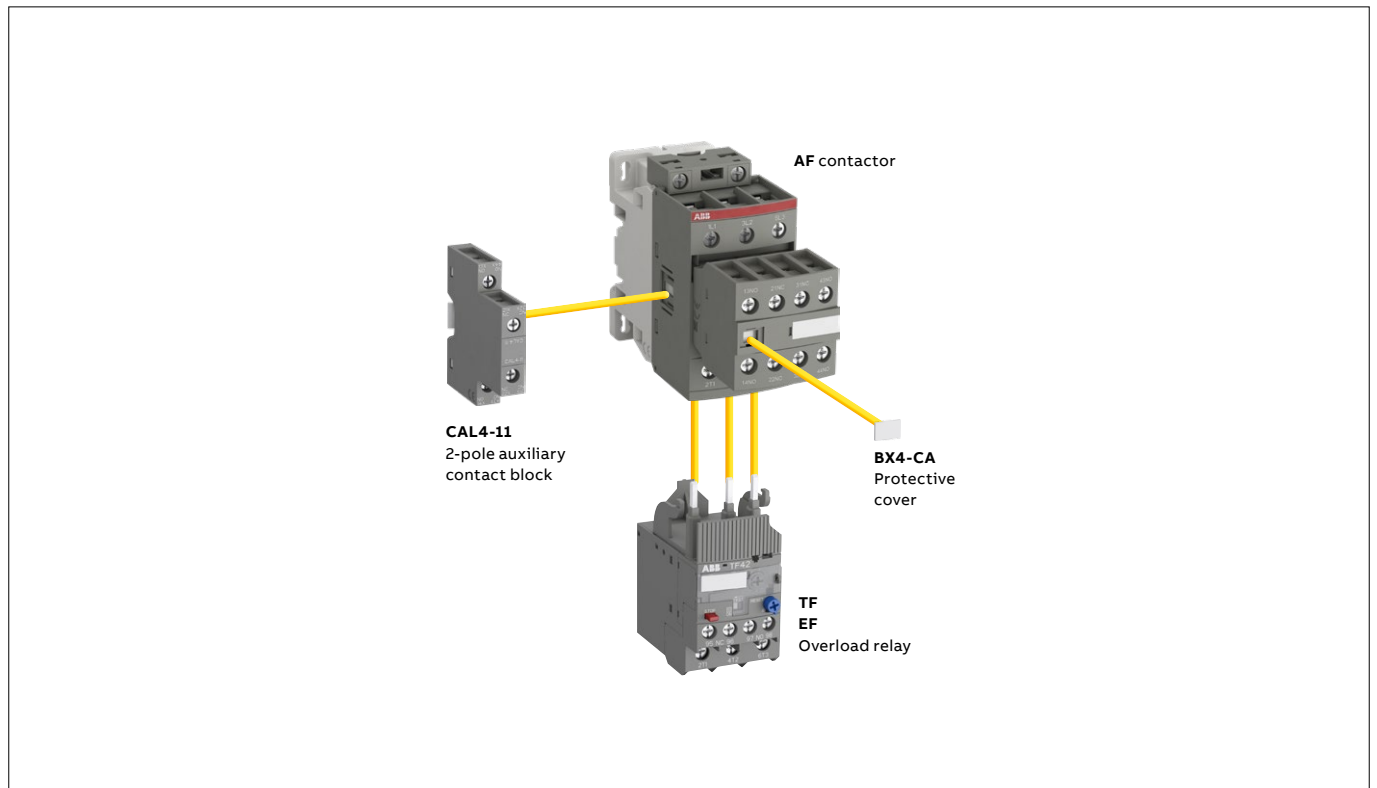

### Main accessory fitting details - for ordering details, technical data and other accessories: see section accessories

Contactor types	Main poles	Built-in auxiliary contacts	Side-mounted accessories Mechanical interlock unit (between 2 contactors)	Auxiliary contact blocks	
				2-pole CAL4-11 Left side	Right side
AF09 ... AF38	3 0	2 2	VM..	+ 1	or 1
AF40 ... AF96	3 0	2 2	1	+ 1	or 1
			-	+ 1	+ 1

### Overload relays fitting details (1)

Contactor types	Thermal overload relays	Electronic overload relays
AF09 ... AF38	TF42 (0.10...38 A)	EF19 (0.10...19 A)
AF26 ... AF38	TF42 (0.10...38 A)	EF45 (9...45 A)
AF40 ... AF65	TF65 (22...67 A)	EF65 (20...70 A)
AF80 , AF96	TF96 (40...96 A)	EF96 (36...100 A)

The addition of an overload relay on the contactor does not prevent fitting of many other accessories as shown above.

(1) Direct mounting - No kit required.

# AF116 ... AF146 3-pole contactors

55 to 75 kW

AC / DC operated with 2 N.O. + 2 N.C. auxiliary contacts

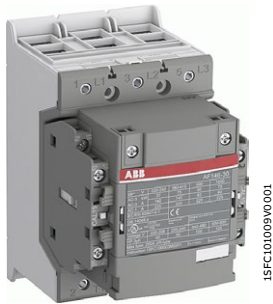

AF146-30-22

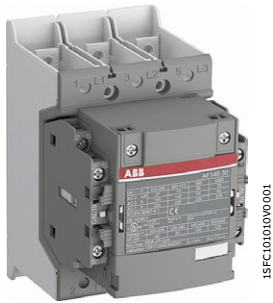

AF146-30-22B

AF116 ... AF140 contactors are mainly used for controlling 3-phase motors and power circuits up to 690 V AC, AF146 up to 1000 V AC and AF116 ... AF146 up to 260 V DC. These contactors are of the block type design with 3 main poles.

- control circuit: AC or DC operated with electronic coil interface accepting a wide control voltage range (e.g. 100...250 V AC and DC), only 4 coils to cover control voltages between 24...500 V 50/60 Hz and 20...500 V DC
  - can manage large control voltage variations
  - reduced panel energy consumption
  - very distinct closing and opening
  - can withstand short voltage dips and voltage sags (SEMI F47 conditions of use on request).
- built-in surge suppression
- add-on auxiliary contact blocks for side mounting and a wide range of accessories.

IEC	UL / CSA		Rated control circuit voltage Uc min. ... Uc max.	Auxiliary contacts fitted	Type (1)	Order code	Weight
	Rated operational power	3-phase motor rating					
400 V AC-3 kW	current $\theta \leq 40^\circ\text{C}$ AC-1 A	480 V hp	600 V AC A				kg

**For connection with built-in cable clamps**

Power (kW)	Current (A)	Motor Rating (hp)	General Rating (A)	Uc min (V)	Uc max (V)	Auxiliary	Type	Order Code	Weight (kg)
55	160	75	160	24...60	20...60	2 2	AF116-30-22-11	1SFL427001R122	1.750
				48...130	48...130	2 2	AF116-30-22-12	1SFL427001R1222	1.750
				100...250	100...250	2 2	AF116-30-22-13	1SFL427001R1322	1.750
				250...500	250...500	2 2	AF116-30-22-14	1SFL427001R1422	1.750
75	200	100	200	24...60	20...60	2 2	AF140-30-22-11	1SFL447001R1122	1.750
				48...130	48...130	2 2	AF140-30-22-12	1SFL447001R1222	1.750
				100...250	100...250	2 2	AF140-30-22-13	1SFL447001R1322	1.750
				250...500	250...500	2 2	AF140-30-22-13	1SFL447001R1422	1.750
75	225	100	200	24...60	20...60	2 2	AF146-30-22-11	1SFL467001R1122	1.750
				48...130	48...130	2 2	AF146-30-22-12	1SFL467001R1222	1.750
				100...250	100...250	2 2	AF146-30-22-13	1SFL467001R1322	1.750
				250...500	250...500	2 2	AF146-30-22-14	1SFL467001R1422	1.750

**With bar connections**

Power (kW)	Current (A)	Motor Rating (hp)	General Rating (A)	Uc min (V)	Uc max (V)	Auxiliary	Type	Order Code	Weight (kg)
55	160	75	160	24...60	20...60	2 2	AF116-30-22B-11	1SFL427002R1122	1.500
				48...130	48...130	2 2	AF116-30-22B-12	1SFL427002R1222	1.500
				100...250	100...250	2 2	AF116-30-22B-13	1SFL427002R1322	1.500
				250...500	250...500	2 2	AF116-30-22B-14	1SFL427002R1422	1.500
75	200	100	200	24...60	20...60	2 2	AF140-30-22B-11	1SFL447002R1122	1.500
				48...130	48...130	2 2	AF140-30-22B-12	1SFL447002R1222	1.500
				100...250	100...250	2 2	AF140-30-22B-13	1SFL447002R1322	1.500
				250...500	250...500	2 2	AF140-30-22B-14	1SFL447002R1422	1.500
75	225	100	200	24...60	20...60	2 2	AF146-30-22B-11	1SFL467002R1122	1.500
				48...130	48...130	2 2	AF146-30-22B-12	1SFL467002R1222	1.500
				100...250	100...250	2 2	AF146-30-22B-13	1SFL467002R1322	1.500
				250...500	250...500	2 2	AF146-30-22B-14	1SFL467002R1422	1.500

(1) For other auxiliary contacts arrangements, please contact your ABB local sales organization.

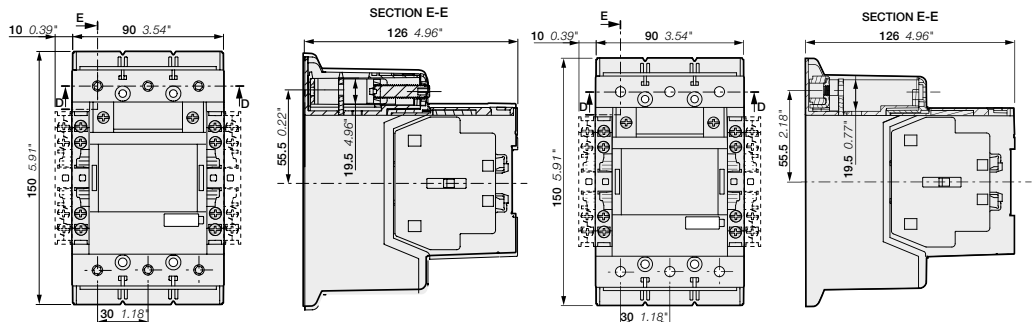

AF116, AF140, AF146-30-22

AF116, AF140, AF146-30-22B

Main dimensions mm, inches

1SFC101095C0201 - Rev. D



# AF116 ... AF146 3-pole contactors with built-in PLC interface

55 to 75 kW

AC / DC operated with 2 N.O. + 2 N.C. auxiliary contacts for faster opening utilization



AF146-30-22

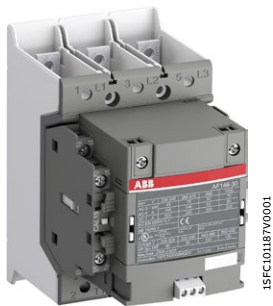

AF146-30-22B

AF116 ... AF146 contactors are mainly used for controlling 3-phase motors and power circuits up to 690 V AC, AF146 up to 1000 V AC and AF116 ... AF146 up to 260 V DC. These contactors are of the block type design with 3 main poles.

- control circuit: AC or DC operated with electronic coil interface accepting a wide control voltage range (e.g. 100...250 V AC and DC), only 2 coils to cover control voltages between 100...500 V 50/60 Hz and 100...500 V DC
  - can manage large control voltage variations
  - reduced panel energy consumption
  - very distinct closing and opening
  - can withstand short voltage dips and voltage sags (SEMI F47 conditions of use on request)
  - opening time below 20 ms.
- built-in surge suppression
- add-on auxiliary contact blocks for side mounting and a wide range of accessories.

IEC		UL / CSA		Rated control circuit voltage		Auxiliary contacts fitted	Type (1)	Order code	Weight
Rated operational power	current $\theta \leq 40^\circ\text{C}$	3-phase motor rating	General use rating	Uc min. ... Uc max.					
400 V	AC-3	480 V	600 V AC	V 50/60 Hz	V DC				Pkg (1 pce)
kW	A	hp	A				kg		

### For connection with built-in cable clamps

55	160	75	160	100...250	100...250	2	2	AF116-30-22-33	1SFL427001R3322	1.750
				250...500	250...500	2	2	AF116-30-22-34	1SFL427001R3422	1.750
75	200	100	200	100...250	100...250	2	2	AF140-30-22-33	1SFL447001R3322	1.750
				250...500	250...500	2	2	AF140-30-22-34	1SFL447001R3422	1.750
75	225	100	200	100...250	100...250	2	2	AF146-30-22-33	1SFL467001R3322	1.750
				250...500	250...500	2	2	AF146-30-22-34	1SFL467001R3422	1.750

### With bar connections

55	160	75	160	100...250	100...250	2	2	AF116-30-22B-33	1SFL427002R3322	1.500
				250...500	250...500	2	2	AF116-30-22B-34	1SFL427002R3422	1.500
75	200	100	200	100...250	100...250	2	2	AF140-30-22B-33	1SFL447002R3322	1.500
				250...500	250...500	2	2	AF140-30-22B-34	1SFL447002R3422	1.500
75	225	100	200	100...250	100...250	2	2	AF146-30-22B-33	1SFL467002R3322	1.500
				250...500	250...500	2	2	AF146-30-22B-34	1SFL467002R3422	1.500

For other auxiliary contacts arrangements, please contact your ABB local sales organization.

AF116 ... AF146 are equipped with low voltage inputs for control, for example by a PLC.

### Control inputs

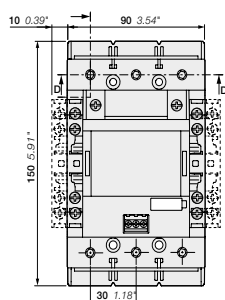
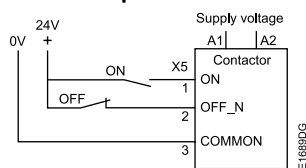

AF116, AF140, AF146-30-22

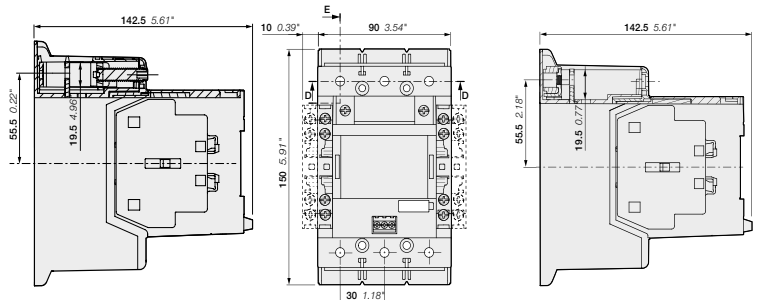

AF116, AF140, AF146-30-22B

Main dimensions mm, inches

# AF190 ... AF370 3-pole contactors

90 to 200 kW

AC / DC operated with 2 N.O. + 2 N.C. auxiliary contacts

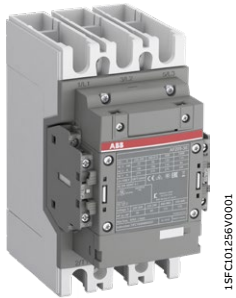

AF205-30-22

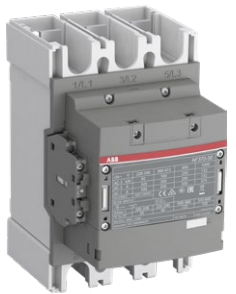

AF370-30-22

AF190 ... AF370 contactors are mainly used for controlling 3-phase motors and power circuits up to 1000 V AC and up to 340 V DC. These contactors are of the block type design with 3 main poles.

- control circuit: AC or DC operated with electronic coil interface accepting a wide control voltage range (e.g. 100...250 V AC and DC), only 4 coils to cover control voltages between 24...500 V 50/60 Hz and 20...500 V DC
  - can manage large control voltage variations
  - reduced panel energy consumption
  - very distinct closing and opening
  - can withstand short voltage dips and voltage sags (SEMI F47 conditions of use on request).
- built-in surge suppression
- add-on auxiliary contact blocks for side mounting and a wide range of accessories.

IEC Rated operational power 400 V AC-3 kW	UL / CSA 3-phase motor rating 480 V AC-1 A hp	General use rating 600 V AC A	Rated control circuit voltage Uc min. ... Uc max.		Auxiliary contacts fitted	Type (1)	Order code	Weight Pkg (1 pce) kg	
			V 50/60 Hz	V DC					
90	275	125	250	24...60	20...60	2 2	AF190-30-22-11	1SFL487002R1122	3.000
				48...130	48...130	2 2	AF190-30-22-12	1SFL487002R1222	3.000
				100...250	100...250	2 2	AF190-30-22-13	1SFL487002R1322	3.000
				250...500	250...500	2 2	AF190-30-22-14	1SFL487002R1422	3.000
110	350	150	300	24...60	20...60	2 2	AF205-30-22-11	1SFL527002R1122	3.000
				48...130	48...130	2 2	AF205-30-22-12	1SFL527002R1222	3.000
				100...250	100...250	2 2	AF205-30-22-13	1SFL527002R1322	3.000
				250...500	250...500	2 2	AF205-30-22-14	1SFL527002R1422	3.000
132	400	200	350	24...60	20...60	2 2	AF265-30-22-11	1SFL547002R1122	4.675
				48...130	48...130	2 2	AF265-30-22-12	1SFL547002R1222	4.675
				100...250	100...250	2 2	AF265-30-22-13	1SFL547002R1322	4.675
				250...500	250...500	2 2	AF265-30-22-14	1SFL547002R1422	4.675
160	500	250	400	24...60	20...60	2 2	AF305-30-22-11	1SFL587002R1122	4.675
				48...130	48...130	2 2	AF305-30-22-12	1SFL587002R1222	4.675
				100...250	100...250	2 2	AF305-30-22-13	1SFL587002R1322	4.675
				250...500	250...500	2 2	AF305-30-22-14	1SFL587002R1422	4.675
200	600	300	520	24...60	20...60	2 2	AF370-30-22-11	1SFL607002R1122	4.675
				48...130	48...130	2 2	AF370-30-22-12	1SFL607002R1222	4.675
				100...250	100...250	2 2	AF370-30-22-13	1SFL607002R1322	4.675
				250...500	250...500	2 2	AF370-30-22-14	1SFL607002R1422	4.675

(1) For other auxiliary contacts arrangements, please contact your ABB local sales organization.

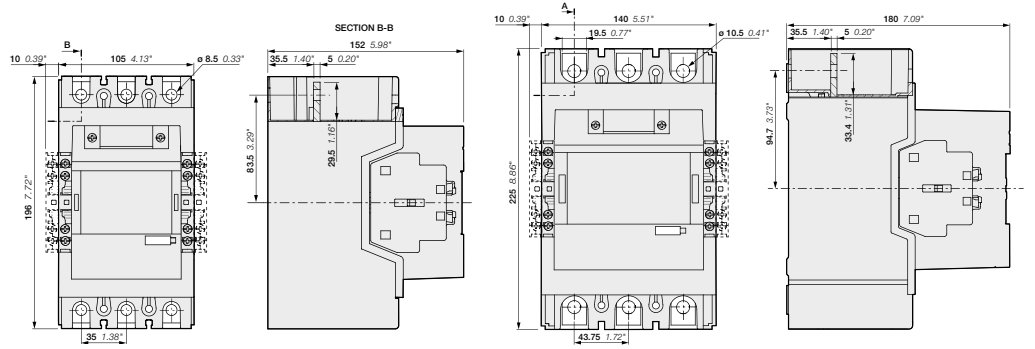

AF190, AF205

AF265, AF305, AF370

Main dimensions mm, inches

1SFC101093C0201 - Rev. E

# AF190 ... AF370 3-pole contactors with built-in PLC interface

90 to 200 kW

AC / DC operated with 2 N.O. + 2 N.C. auxiliary contacts for faster opening utilization

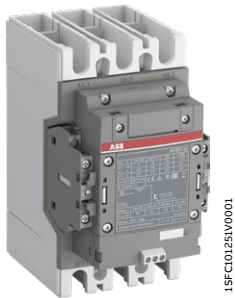

AF205-30-22

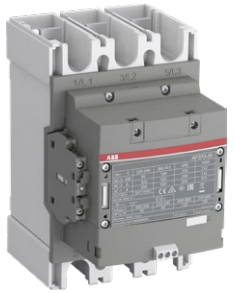

AF370-30-22

AF190 ... AF370 contactors are mainly used for controlling 3-phase motors and power circuits up to 1000 V AC and up to 340 V DC. These contactors are of the block type design with 3 main poles.

- control circuit: AC or DC operated with electronic coil interface accepting a wide control voltage range (e.g. 100...250 V AC and DC), only 2 coils to cover control voltages between 100...500 V 50/60 Hz and 100...500 V DC
  - can manage large control voltage variations
  - reduced panel energy consumption
  - very distinct closing and opening
  - can withstand short voltage dips and voltage sags (SEMI F47 conditions of use on request)
  - opening time below 20 ms.
- built-in surge suppression
- add-on auxiliary contact blocks for side mounting and a wide range of accessories.

IEC Rated operational power	UL / CSA 3-phase motor rating 480 V General use rating 600 V AC	Rated control circuit voltage Uc min. ... Uc max.	Auxiliary contacts fitted	Type (1)	Order code	Weight Pkg (1 pce) kg					
							Rated operational current $\theta \leq 40^\circ\text{C}$	3-phase motor rating 480 V hp	General use rating 600 V AC A	V 50/60 Hz	V DC
400 V AC-3 kW	AC-1 A	275	125	250	100...250	100...250	2	2	AF190-30-22-33	1SFL487002R3322	3.000
					250...500	250...500	2	2	AF190-30-22-34	1SFL487002R3422	3.000
110	350	150	300	100...250	100...250	2	2	AF205-30-22-33	1SFL527002R3322	3.000	
				250...500	250...500	2	2	AF205-30-22-34	1SFL527002R3422	3.000	
132	400	200	350	100...250	100...250	2	2	AF265-30-22-33	1SFL547002R3322	4.675	
				250...500	250...500	2	2	AF265-30-22-34	1SFL547002R3422	4.675	
160	500	250	400	100...250	100...250	2	2	AF305-30-22-33	1SFL587002R3322	4.675	
				250...500	250...500	2	2	AF305-30-22-34	1SFL587002R3422	4.675	
200	600	300	520	100...250	100...250	2	2	AF370-30-22-33	1SFL607002R3322	4.675	
				250...500	250...500	2	2	AF370-30-22-34	1SFL607002R3422	4.675	

(1) For other auxiliary contacts arrangements, please contact your ABB local sales organization.

AF190 ... AF370 are equipped with low voltage inputs for control, for example by a PLC.

### Control inputs

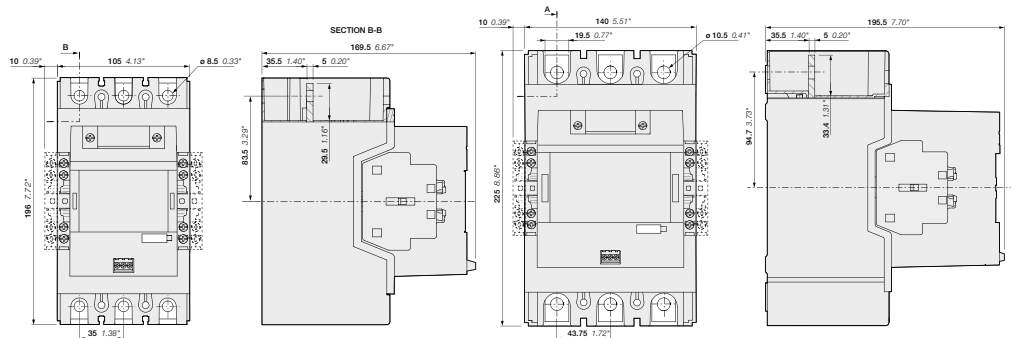
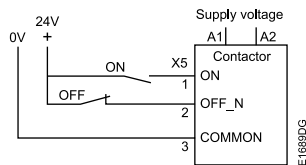

AF190, AF205

AF265, AF305, AF370

Main dimensions mm, inches

# AF116 ... AF370 3-pole contactors with 2 N.O. + 2 N.C. auxiliary contacts

## Main accessories

### Main accessories (other accessories available)

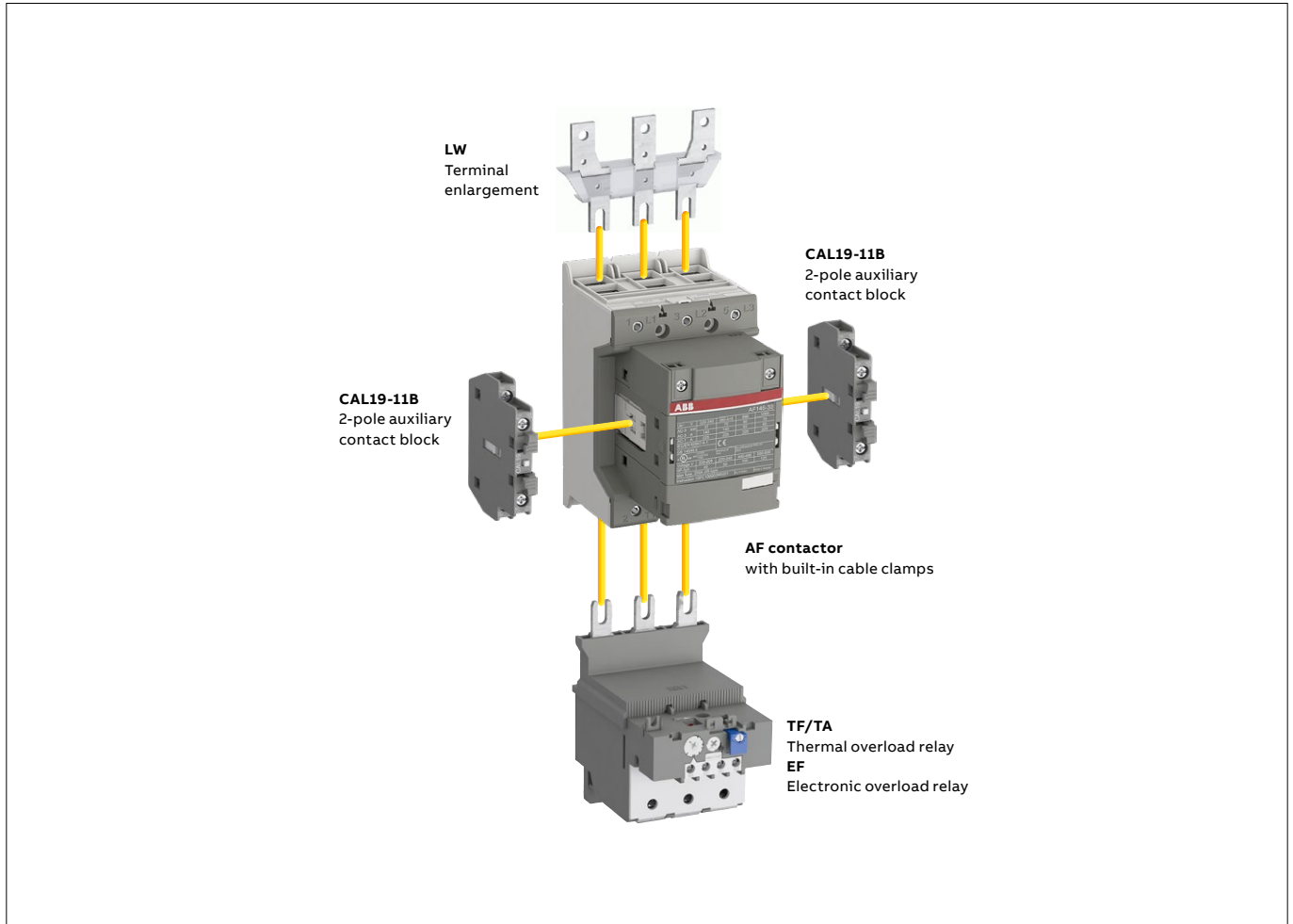

**Main accessory fitting details** - for ordering details, technical data and other accessories: see section accessories

Contactor types	Main poles	Available auxiliary contacts	Side-mounted accessories		Mechanical interlock units (between two contactors)
			Auxiliary contact blocks	Auxiliary contact blocks	
			CAL19-11 (2)	CAL19-11B (2)	
AF116 ... AF370	3 0	2 2	2 x CAL19-11 included	+ 2 x CAL19-11B	-

(2) The CEL19 auxiliary contact blocks can replace the CAL19-11 and CAL19-11B. Though, no auxiliary contact block can be mounted outside the CEL19.

### Overload relays fitting details (1)

Contactor types	Thermal overload relays	Electronic overload relays
AF116 ... AF140	TF140DU (66...142 A)	EF146 (54...150 A)
AF146	-	EF146 (54...150 A)
AF190, AF205	TA200DU (66...200 A)	EF205 (63...210 A)
AF265 ... AF370	-	EF370 (115...380 A)

The addition of a thermal or electronic overload relay on the contactor does not prevent fitting of many other accessories as shown in "Main accessory fitting details" table.

(1) Direct mounting - No kit required.

# AF400 ... AF750 3-pole contactors

200 to 400 kW

AC / DC operated with 2 N.O. + 2 N.C. auxiliary contacts



AF460-30-22

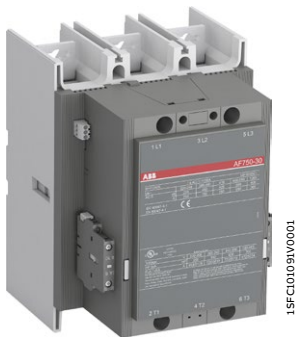

AF750-30-22

AF400 ... AF750 contactors are mainly used for controlling 3-phase motors and power circuits up to 690 V AC or 600 V DC (2). These contactors are of the block type design with 3 main poles.

- control circuit: AC or DC operated with electronic coil interface accepting a wide control voltage range (e.g. 100...250 V AC and DC), only 4 coils to cover control voltages between 48...500 V 50/60 Hz and 24...500 V DC
  - can manage large control voltage variations
  - reduced panel energy consumption
  - very distinct closing and opening
  - can withstand short voltage dips and voltages sags (SEMI F47 conditions of use on request).
- built-in surge suppression
- add-on auxiliary contact blocks for side mounting and a wide range of accessories.

IEC Rated operational power	UL/CSA 3-phase motor rating 480 V	General use rating 600 V AC	Rated control circuit voltage Uc		Auxiliary contacts fitted	Type	Order code	Weight  Pkg (1 pce)  kg	
			V 50/60 Hz	V DC					
400 V AC-3 kW	690 V AC-1 A	350	550	-	24...60	2 2	AF400-30-22	1SFL577001R6822 (1)	12.000
				48...130	48...130	2 2	AF400-30-22	1SFL577001R6922	12.000
				100...250	100...250	2 2	AF400-30-22	1SFL577001R7022	12.000
				250...500	250...500	2 2	AF400-30-22	1SFL577001R7122	12.000
250	700	400	650	-	24...60	2 2	AF460-30-22	1SFL597001R6822 (1)	12.000
				48...130	48...130	2 2	AF460-30-22	1SFL597001R6922	12.000
				100...250	100...250	2 2	AF460-30-22	1SFL597001R7022	12.000
				250...500	250...500	2 2	AF460-30-22	1SFL597001R7122	12.000
315	800	500	750	-	24...60	2 2	AF580-30-22	1SFL617001R6822 (1)	15.000
				48...130	48...130	2 2	AF580-30-22	1SFL617001R6922	15.000
				100...250	100...250	2 2	AF580-30-22	1SFL617001R7022	15.000
				250...500	250...500	2 2	AF580-30-22	1SFL617001R7122	15.000
400	1050	600	900	-	24...60	2 2	AF750-30-22	1SFL637001R6822 (1)	15.000
				48...130	48...130	2 2	AF750-30-22	1SFL637001R6922	15.000
				100...250	100...250	2 2	AF750-30-22	1SFL637001R7022	15.000
				250...500	250...500	2 2	AF750-30-22	1SFL637001R7122	15.000

(1) The connection polarities indicated close to the coil terminals must be respected: A1 for the positive pole and A2 for the negative pole.  
 (2) Up to 850 V DC for AF580, AF750.

AF400...AF750 are equipped with low voltage inputs for control, for example by a PLC.

### Control inputs

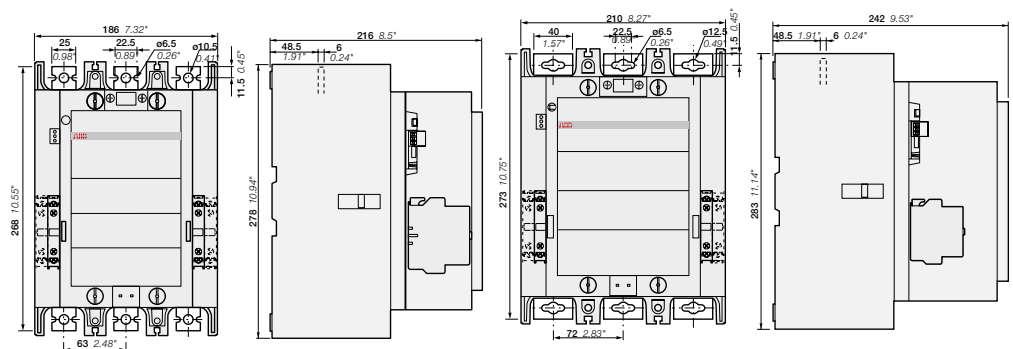
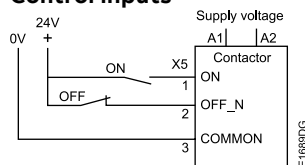

AF400, AF460

AF580, AF750

Main dimensions mm, inches

# AF1250 ... AF2850 3-pole contactors

475 to 560 kW and 1260 to 2850 A AC-1

AC / DC operated with 2 N.O. + 2 N.C. auxiliary contacts



AF1250-30-22



AF2650-30-22

AF1250 ... AF2050 contactors are mainly used for controlling power circuits up to 1000 V AC or 850 V DC, AF2650 and AF2850 for controlling power up to 1000 V AC. These contactors are of the block type design with 3 main poles.

- control circuit: AC or DC operated with electronic coil interface accepting a wide control voltage range (e.g. 100...250 V AC and DC)
- only 4 coils for AF1250 to cover control voltages between 48...500 V 50/60 Hz and 24...500 V DC
- only 1 coil for AF1350 ... AF2850 to cover control voltages between 100...250 V 50/60 Hz and 100...250 V DC
  - can manage large control voltage variations
  - reduced panel energy consumption
  - very distinct closing and opening
  - can withstand short voltage dips and voltages sags (SEMI F47 conditions of use on request).
- built-in surge suppression
- add-on auxiliary contact blocks for side mounting and a wide range of accessories.

IEC Rated operational power 400 V AC-3	UL/CSA 3-phase motor rating 480 V AC-1	General use rating 600 V AC (2)	Rated control circuit voltage Uc (1)		Auxiliary contacts fitted	Type	Order code	Weight  Pkg (1 pce)  kg				
			V 50/60 Hz	V DC								
kW	A	hp	A	V 50/60 Hz	V DC	Y Y	AF1250-30-22	1SFL647001R6822 (1)				
								1260	-	24...60	2 2	1SFL647001R6922
								-	48...130	48...130	2 2	1SFL647001R7022
								-	100...250	100...250	2 2	1SFL647001R7122
475	1350	800	1350	100...250	100...250	2 2	AF1350-30-22	1SFL657001R7022	34.000			
560	1650	900	1650	100...250	100...250	2 2	AF1650-30-22	1SFL677001R7022	35.000			
-	2050	-	2100	100...250	100...250	2 2	AF2050-30-22	1SFL707001R7022	35.000			
-	2650	-	2700	100...250	100...250	2 2	AF2650-30-22	1SFL667001R7022	45.000			
-	2850	-	2850	100...250	100...250	2 2	AF2850-30-22	1SFL687001R7022	45.000			

(1) The connection polarities indicated close to the coil terminals must be respected: A1 for the positive pole and A2 for the negative pole.  
 (2) AF2650 : Maximum operational voltage = 1000 V according to UL / CSA.

AF1250 ... AF2850 are equipped with low voltage inputs for control, for example by a PLC.

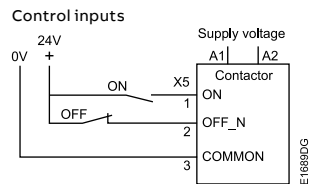

	AF1350, AF1650, AF2050	AF2650, AF2850
A	392 mm / 15.43"	422 mm / 16.61"
B	47 mm / 1.85"	53 mm / 2.11"
C	10 mm / 0.39"	25 mm / 0.98"

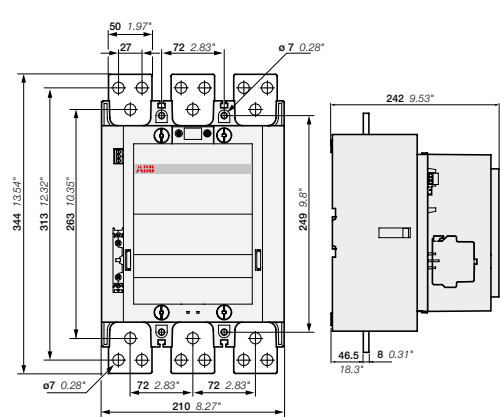

AF1250  
Main dimensions mm, inches

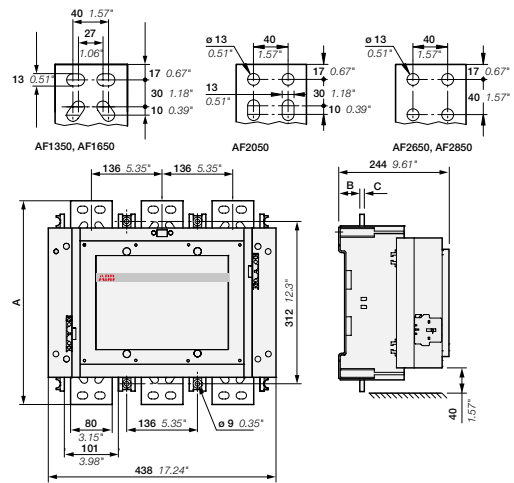

AF1350, AF1650, AF2050, AF2650, AF2850



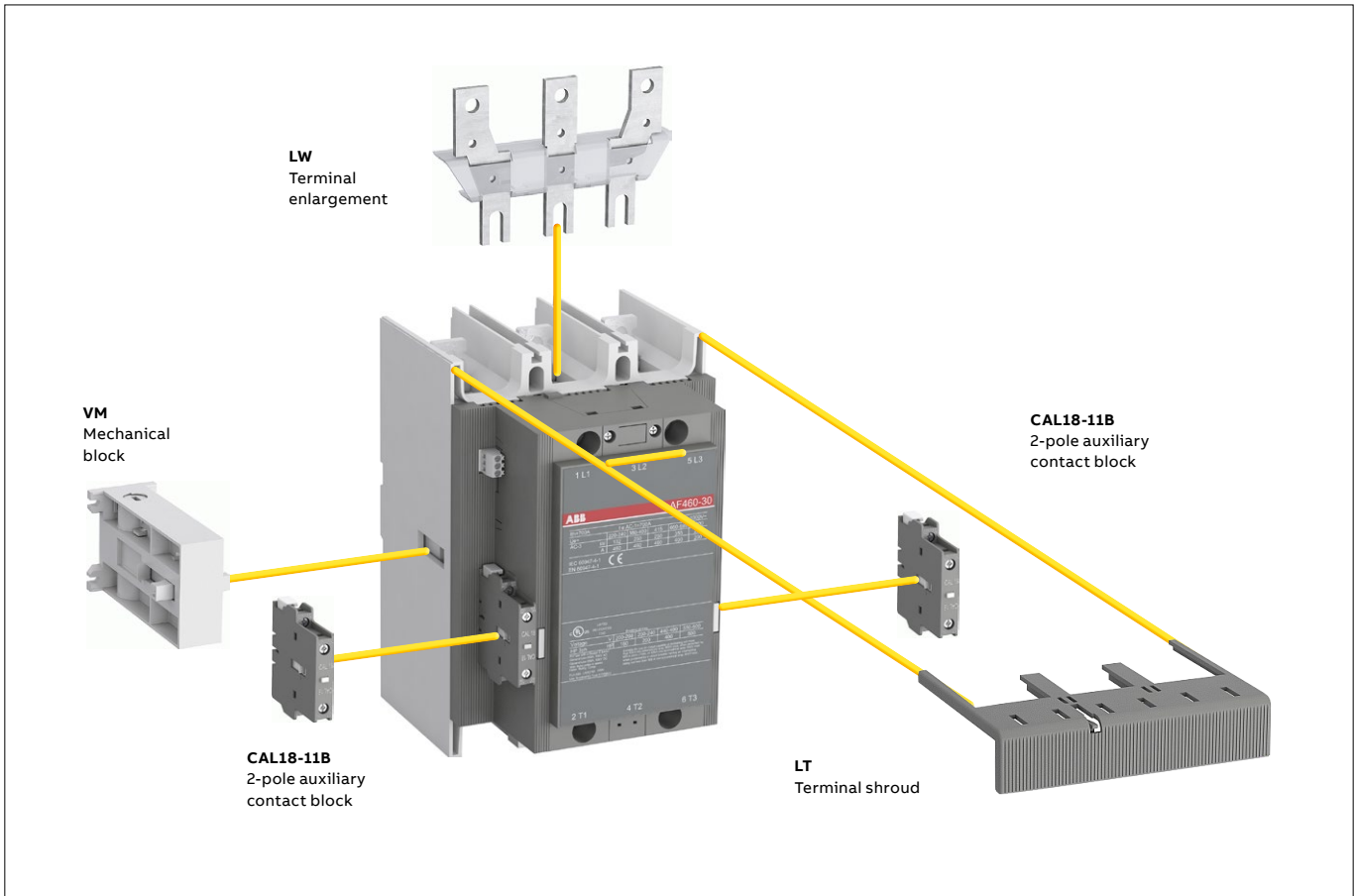

# AF400... AF2850 3-pole contactors with 2 N.O. + 2 N.C. auxiliary contacts

## Contactors and main accessories



**Main accessory fitting details** - for ordering details, technical data and other accessories: see section accessories

Contactor types	Main poles	Available auxiliary contacts	Side-mounted accessories Auxiliary contact blocks	Mechanical interlock units (between two contactors)
			CAL18-11                      CAL18-11B (2)	

**Contactors + auxiliary contact blocks**

AF145 ... AF2850	3	0	2	2	▶	2 x CAL18-11 included	2 x CAL18-11B	-
------------------	---	---	---	---	---	-----------------------	---------------	---

**Contactors with mechanical interlocking + auxiliary contact blocks**

AF400 ... AF2850	3	0	2	2	▶	2 x CAL18-11 included	4 x CAL18-11B	+ VM...H (1)
------------------	---	---	---	---	---	-----------------------	---------------	--------------

(1) Interlock type, according to the contactor ratings (see "Accessories").  
 (2) The CEL18... auxiliary contact blocks can replace the CAL18-11 and CAL18-11B. Though, no auxiliary contact block can be mounted outside the CEL18...

**Overload relays fitting details**

Contactor types	Thermal overload relays	Electronic overload relays
AF400, AF460	-	EF460 (150...500 A) (3)
AF580, AF750	-	EF750 (250...800 A) (3)
AF1350, AF1650	-	E1250DU (375...1250 A) (3)

The addition of a thermal or electronic overload relay on the contactor does not prevent fitting of many other accessories as shown in "Main accessory fitting details" table.  
 (3) Mounting kit required (see "Motor protection").

# AF09 ... AF38 3-pole contactors

## Technical data

### Main pole - Utilization characteristics according to IEC

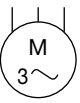
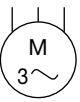
Contactors types	AC / DC operated	AF09	AF12	AF16	AF26	AF30	AF38
Standards		IEC 60947-1 / 60947-4-1 and EN 60947-1 / 60947-4-1					
Rated operational voltage $U_e$ max.		690 V					
Rated frequency (without derating)		50 / 60 Hz					
Conventional free-air thermal current $I_{th}$ acc. to IEC 60947-4-1, open contactors, $\theta \leq 40^\circ\text{C}$		35 A	35 A	35 A	50 A	50 A	50 A
With conductor cross-sectional area		6 mm <sup>2</sup>	6 mm <sup>2</sup>	6 mm <sup>2</sup>	10 mm <sup>2</sup>	10 mm <sup>2</sup>	10 mm <sup>2</sup>
AC-1 Utilization category							
For air temperature close to contactor							
$I_e$ / Rated operational current AC-1	$\theta \leq 40^\circ\text{C}$	25 A	28 A	30 A	45 A	50 A	50 A
$U_e$ max. $\leq 690\text{ V}$ , 50/60 Hz	$\theta \leq 60^\circ\text{C}$	25 A	28 A	30 A	40 A	42 A	42 A
	$\theta \leq 70^\circ\text{C}$	22 A	24 A	26 A	32 A	37 A	37 A
With conductor cross-sectional area		4 mm <sup>2</sup>	6 mm <sup>2</sup>	6 mm <sup>2</sup>	10 mm <sup>2</sup>	10 mm <sup>2</sup>	10 mm <sup>2</sup>
AC-3 Utilization category							
For air temperature close to contactor $\theta \leq 60^\circ\text{C}$							
$I_e$ / Max. rated operational current AC-3 (1)							
 3-phase motors	220-230-240 V	9 A	12 A	18 A	26 A	33 A	40 A
	380-400 V	9 A	12 A	18 A	26 A	32 A	38 A
	415 V	9 A	12 A	18 A	26 A	32 A	38 A
	440 V	9 A	12 A	18 A	26 A	32 A	38 A
	500 V	9.5 A	12.5 A	15 A	23 A	28 A	33 A
	690 V	7 A	9 A	10.5 A	17 A	21 A	24 A
	Rated operational power AC-3 (1)						
 1500 r.p.m. 50 Hz 1800 r.p.m. 60 Hz 3-phase motors	220-230-240 V	2.2 kW	3 kW	4 kW	6.5 kW	9 kW	11 kW
	380-400 V	4 kW	5.5 kW	7.5 kW	11 kW	15 kW	18.5 kW
	415 V	4 kW	5.5 kW	9 kW	11 kW	15 kW	18.5 kW
	440 V	4 kW	5.5 kW	9 kW	15 kW	18.5 kW	22 kW
	500 V	5.5 kW	7.5 kW	9 kW	15 kW	18.5 kW	22 kW
	690 V	5.5 kW	7.5 kW	9 kW	15 kW	18.5 kW	22 kW
	Rated making capacity AC-3		10 x $I_e$ AC-3 acc. to IEC 60947-4-1				
Rated breaking capacity AC-3		8 x $I_e$ AC-3 acc. to IEC 60947-4-1					
AC-8a Utilization category							
(without thermal overload relay - $U_e 400\text{ V}$ 50/60 Hz - $\theta \leq 40^\circ\text{C}$ )							
$I_e$ / Rated operational current AC-8a		12 A	16 A	22 A	30 A	40 A	50 A
Rated operational power AC-8a		5.5 kW	7.5 kW	11 kW	15 kW	20 kW	25 kW
Short-circuit protection device for contactors without thermal overload relay - Motor protection excluded (2)							
$U_e \leq 500\text{ V AC}$ - gG type fuse		25 A	32 A	32 A	50 A	63 A	63 A
Rated short-time withstand current $I_{cw}$ at $40^\circ\text{C}$ ambient temperature, in free air from a cold state	1 s	300 A	300 A	300 A	700 A	700 A	700 A
	10 s	150 A	150 A	150 A	350 A	350 A	350 A
	30 s	80 A	80 A	80 A	225 A	225 A	225 A
	1 min	60 A	60 A	60 A	150 A	150 A	150 A
	15 min	35 A	35 A	35 A	50 A	50 A	50 A
Maximum breaking capacity $\cos \phi = 0.45$							
	at 440 V	250 A	250 A	250 A	500 A	500 A	500 A
	at 690 V	106 A	106 A	106 A	200 A	200 A	200 A
Power dissipation per pole	$I_e$ / AC-1	0.8 W	1 W	1.2 W	1.8 W	2.4 W	2.4 W
	$I_e$ / AC-3	0.1 W	0.2 W	0.35 W	0.6 W	0.9 W	1.3 W
Max. electrical switching frequency							
	AC-1	600 cycles/h					
	AC-3	1200 cycles/h					
	AC-2, AC-4	300 cycles/h				150 cycles/h	



(1) For the corresponding kW/A or hp/A values of 1500 r.p.m. 50 Hz or 1800 r.p.m. 60 Hz, 3-phase motors, see "Motor rated operational powers and currents".

(2) For the protection of motor starters against short circuits, see "Coordination with short-circuit protection devices".

# AF40 ... AF96 3-pole contactors

## Technical data

### Main pole - Utilization characteristics according to IEC

Contactor types	AC / DC operated	AF40	AF52	AF65	AF80	AF96
Standards		IEC 60947-1 / 60947-4-1 and EN 60947-1 / 60947-4-1				
Rated operational voltage Ue max.		690 V				1000 V
Rated frequency (without derating)		50 / 60 Hz				
Conventional free-air thermal current Ith acc. to IEC 60947-4-1, open contactors, $\theta \leq 40^\circ\text{C}$		105 A	105 A	105 A	130 A	130 A
With conductor cross-sectional area		35 mm <sup>2</sup>	35 mm <sup>2</sup>	35 mm <sup>2</sup>	50 mm <sup>2</sup>	50 mm <sup>2</sup>
AC-1 Utilization category						
For air temperature close to contactor						
le / Rated operational current AC-1	$\theta \leq 40^\circ\text{C}$	70 A	100 A	105 A	125 A	130 A
Ue max. $\leq 690\text{ V}, 50/60\text{ Hz}$	$\theta \leq 60^\circ\text{C}$	60 A	80 A	90 A	100 A	105 A
	$\theta \leq 70^\circ\text{C}$	50 A	70 A	80 A	85 A	90 A
With conductor cross-sectional area		25 mm <sup>2</sup>	35 mm <sup>2</sup>	35 mm <sup>2</sup>	50 mm <sup>2</sup>	50 mm <sup>2</sup>
AC-3 Utilization category						
For air temperature close to contactor $\theta \leq 60^\circ\text{C}$						
le / Max. rated operational current AC-3 (1)						
	220-230-240 V	40 A	53 A	65 A	80 A	96 A
	380-400 V	40 A	53 A	65 A	80 A	96 A
	415 V	40 A	53 A	65 A	80 A	96 A
	440 V	40 A	53 A	65 A	80 A	96 A
	500 V	35 A	45 A	55 A	65 A	80 A
	690 V	25 A	35 A	39 A	49 A	57 A
	1000 V	-	-	-	25 A	30 A
		 3-phase motors				
Rated operational power AC-3 (1)						
	220-230-240 V	11 kW	15 kW	18.5 kW	22 kW	25 kW
	380-400 V	18.5 kW	22 kW	30 kW	37 kW	45 kW
	415 V	22 kW	30 kW	37 kW	45 kW	55 kW
	440 V	22 kW	30 kW	37 kW	45 kW	55 kW
	500 V	22 kW	30 kW	37 kW	45 kW	55 kW
	690 V	22 kW	30 kW	37 kW	45 kW	55 kW
	1000 V	-	-	-	35 kW	40 kW
		 1500 r.p.m. 50 Hz 1800 r.p.m. 60 Hz 3-phase motors				
Rated making capacity AC-3		10 x le AC-3 acc. to IEC 60947-4-1				
Rated breaking capacity AC-3		8 x le AC-3 acc. to IEC 60947-4-1				
AC-8a Utilization category						
(without thermal overload relay						
Ue 400 V 50/60 Hz - $\theta \leq 40^\circ\text{C}$ )						
le / Rated operational current AC-8a		53 A	70 A	85 A	105 A	120 A
Rated operational power AC-8a		25 kW	37 kW	45 kW	55 kW	65 kW
Short-circuit protection device for contactors						
without thermal overload relay - Motor protection excluded (2)						
Ue $\leq 500\text{ V AC}$ - gG type fuse		100 A	125 A	160 A	160 A	200 A
Rated short-time withstand current Icw	1 s	1000 A	1000 A	1000 A	1200 A	1200 A
at 40 °C ambient temperature,	10 s	600 A	600 A	600 A	780 A	780 A
in free air from a cold state	30 s	350 A	350 A	350 A	450 A	450 A
	1 min	250 A	250 A	250 A	300 A	300 A
	15 min	110 A	110 A	110 A	140 A	140 A
Maximum breaking capacity						
cos $\phi = 0.45$						
	at 440 V	950 A	950 A	950 A	1150 A	1150 A
	at 690 V	600 A	600 A	600 A	750 A	750 A
Power dissipation per pole	le / AC-1	3 W	6.3 W	7 W	7.6 W	8.2 W
	le / AC-3	1 W	1.7 W	2.7 W	3 W	4.5 W
Max. electrical switching frequency	AC-1	600 cycles/h				
	AC-3	1200 cycles/h				
	AC-2, AC-4	150 cycles/h				

(1) For the corresponding kW/A or hp/A values of 1500 r.p.m, 50 Hz or 1800 r.p.m, 60 Hz, 3-phase motors, see "Motor rated operational powers and currents".

(2) For the protection of motor starters against short circuits, see "Coordination with short-circuit protection devices".

# AF116 ... AF370 3-pole contactors

## Technical data

### Main pole - Utilization characteristics according to IEC

Contactor types	AC / DC operated	AF116	AF140	AF146	AF190	AF205	AF265	AF305	AF370
Standards		IEC 60947-1 / 60947-4-1 and EN 60947-1 / 60947-4-1							
Rated operational voltage Ue max.		690 V	690 V	1000 V	1000 V	1000 V	1000 V	1000 V	1000 V
Rated frequency (without derating)		50 / 60 Hz							
Conventional free-air thermal current Ith acc. to IEC 60947-4-1, open contactors, $\theta \leq 40^\circ\text{C}$		160 A	200 A	225 A	275 A	350 A	400 A	500 A	600 A
With conductor cross-sectional area		70 mm <sup>2</sup>	95 mm <sup>2</sup>	95 mm <sup>2</sup>	150 mm <sup>2</sup>	240 mm <sup>2</sup> (3)	240 mm <sup>2</sup>	300 mm <sup>2</sup> (4)	2 x 185 mm <sup>2</sup> (4)
AC-1 Utilization category									
For air temperature close to contactor									
le / Rated operational current AC-1	$\theta \leq 40^\circ\text{C}$	160 A	200 A	225 A	275 A	350 A	400 A	500 A	600 A
Ue max. $\leq 690\text{ V}$ , 50/60 Hz	$\theta \leq 60^\circ\text{C}$	145 A	175 A	200 A	250 A	300 A	350 A	400 A	500 A
	$\theta \leq 70^\circ\text{C}$	130 A	160 A	175 A	200 A	240 A	290 A	325 A	400 A
le / Rated operational current AC-1	$\theta \leq 40^\circ\text{C}$	–	–	225 A	250 A	275 A	350 A	375 A	400 A
Ue max. $\leq 1000\text{ V}$ , 50/60 Hz	$\theta \leq 60^\circ\text{C}$	–	–	200 A	225 A	250 A	300 A	325 A	350 A
	$\theta \leq 70^\circ\text{C}$	–	–	175 A	185 A	200 A	240 A	260 A	290 A
With conductor cross-sectional area		70 mm <sup>2</sup>	95 mm <sup>2</sup>	95 mm <sup>2</sup>	150 mm <sup>2</sup>	240 mm <sup>2</sup> (3)	240 mm <sup>2</sup>	300 mm <sup>2</sup> (4)	2 x 185 mm <sup>2</sup> (4)
AC-3 Utilization category									
For air temperature close to contactor $\theta \leq 60^\circ\text{C}$									
le / Max. rated operational current AC-3 (1)									
	220-230-240 V	116 A	140 A	146 A	190 A	205 A	265 A	305 A	370 A
	380-400 V	116 A	140 A	146 A	190 A	205 A	265 A	305 A	370 A
	415 V	116 A	140 A	146 A	190 A	205 A	265 A	305 A	370 A
	440 V	116 A	140 A	146 A	190 A	205 A	265 A	305 A	370 A
	500 V	110 A	130 A	130 A	156 A	186 A	250 A	290 A	350 A
	690 V	65 A	80 A	93 A	135 A	165 A	250 A	290 A	315 A
	1000 V	–	–	60 A	85 A	100 A	113 A	131 A	141 A
Rated operational power AC-3 (1)									
	220-230-240 V	30 kW	37 kW	45 kW	55 kW	55 kW	75 kW	90 kW	110 kW
	380-400 V	55 kW	75 kW	75 kW	90 kW	110 kW	132 kW	160 kW	200 kW
	415 V	55 kW	75 kW	75 kW	90 kW	110 kW	132 kW	160 kW	200 kW
	440 V	75 kW	90 kW	90 kW	110 kW	132 kW	160 kW	160 kW	200 kW
	500 V	75 kW	90 kW	90 kW	90 kW	110 kW	200 kW	200 kW	250 kW
	690 V	55 kW	75 kW	90 kW	132 kW	160 kW	200 kW	250 kW	315 kW
	1000 V	–	–	75 kW	110 kW	132 kW	160 kW	185 kW	200 kW
Rated making capacity AC-3		10 x Ie AC-3 acc. to IEC 60947-4-1							
Rated breaking capacity AC-3		8 x Ie AC-3 acc. to IEC 60947-4-1							
Short-circuit protection device for contactors without thermal overload relay - Motor protection excluded (2)									
Ue $\leq 500\text{ V}$ AC - gG type fuse		250 A	315 A	315 A	355 A	400 A	500 A	500 A	630 A
Rated short-time withstand current Icw at 40 °C ambient temperature, in free air from a cold state	1 s	1300 A	1460 A	1460 A	1900 A	2050 A	2650 A	3050 A	3700 A
	10 s	928 A	1168 A	1168 A	1520 A	1640 A	2120 A	2440 A	2960 A
	30 s	536 A	674 A	674 A	878 A	947 A	1224 A	1409 A	1709 A
	1 min	379 A	477 A	477 A	621 A	670 A	865 A	996 A	1208 A
	15 min	160 A	200 A	225 A	275 A	350 A	400 A	500 A	600 A
Maximum breaking capacity $\cos \phi = 0.45$ ( $\cos \phi = 0.35$ for Ie > 100 A)	at 440 V	2000 A	3000 A	3000 A	3300 A	3500 A	3800 A	4600 A	5000 A
	at 690 V	1000 A	1500 A	1500 A	2200 A	2500 A	3300 A	3800 A	4000 A
Power dissipation per pole	Ie / AC-1	12 W	18 W	23 W	15 W	25 W	32 W	50 W	72 W
	Ie / AC-3	6 W	9 W	10 W	7 W	8 W	14 W	19 W	27 W
Maximum electrical switching frequency	AC-1	300 cycles/h							
	AC-3	300 cycles/h							
	AC-2, AC-4	150 cycles/h							

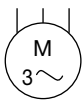

3-phase motors

1500 r.p.m. 50 Hz  
1800 r.p.m. 60 Hz  
3-phase motors

(1) For the corresponding kW/A or hp/A values of 1500 r.p.m, 50 Hz or 1800 r.p.m, 60 Hz, 3-phase motors, see "Motor rated operational powers and currents".

(2) For the protection of motor starters against short circuits, see "Coordination with short-circuit protection devices".

(3) For currents above 275A use terminal enlargements or terminal extensions.

(4) For currents above 450A use terminal enlargements or terminal extensions.

# AF400 ... AF750 3-pole contactors

## Technical data

### Main pole - Utilization characteristics according to IEC

Contactor types	AC / DC operated	AF400	AF460	AF580	AF750
Standards		IEC 60947-1 / 60947-4-1 and EN 60947-1 / 60947-4-1			
Rated operational voltage Ue max.		1000 V			
Rated frequency (without derating)		50/60 Hz			
Conventional free-air thermal current Ith acc. to IEC 60947-4-1, open contactors, $\theta \leq 40^\circ\text{C}$		600 A	700 A	800 A	1050 A
With conductor cross-sectional area (3)		2x185 mm <sup>2</sup>	2x240 mm <sup>2</sup>	2x240 mm <sup>2</sup>	800 mm <sup>2</sup> (4)
AC-1 Utilization category					
For air temperature close to contactor					
le / Rated operational current AC-1	$\theta \leq 40^\circ\text{C}$	600 A	700 A	800 A	1050 A
Ue max. $\leq 690\text{ V}$ , 50/60 Hz	$\theta \leq 55^\circ\text{C}$	500 A	600 A	700 A	875 A
	$\theta \leq 70^\circ\text{C}$	400 A	480 A	580 A	720 A
le / Rated operational current AC-1	$\theta \leq 40^\circ\text{C}$	600 A	700 A	800 A	1000 A
Ue max. $\leq 1000\text{ V}$ , 50/60 Hz	$\theta \leq 55^\circ\text{C}$	500 A	600 A	700 A	875 A
	$\theta \leq 70^\circ\text{C}$	400 A	480 A	580 A	720 A
With conductor cross-sectional area		2x185 mm <sup>2</sup>	2x240 mm <sup>2</sup>	2x240 mm <sup>2</sup>	800 mm <sup>2</sup> (4)
AC-3 Utilization category					
For air temperature close to contactor $\theta \leq 55^\circ\text{C}$					
le / Max. rated operational current AC-3 (1)					
	220-230-240 V	400 A	460 A	580 A	750 A
	380-400 V	400 A	460 A	580 A	750 A
	415 V	400 A	460 A	580 A	750 A
	440 V	400 A	460 A	580 A	750 A
	500 V	400 A	460 A	580 A	750 A
	690 V	350 A	400 A	500 A	650 A
	1000 V	155 A	200 A	250 A	300 A
Rated operational power AC-3 (1)					
	220-230-240 V	110 kW	132 kW	160 kW	220 kW
	380-400 V	200 kW	250 kW	315 kW	400 kW
	415 V	220 kW	250 kW	355 kW	425 kW
	440 V	220 kW	250 kW	355 kW	450 kW
	500 V	250 kW	315 kW	400 kW	520 kW
	690 V	315 kW	355 kW	500 kW	600 kW
	1000 V	220 kW	280 kW	355 kW	400 kW
Rated making capacity AC-3		10 x Ie AC-3 acc. to IEC 60947-4-1			
Rated breaking capacity AC-3		8 x Ie AC-3 acc. to IEC 60947-4-1			
Short-circuit protection device for contactors without thermal overload relay					
Motor protection excluded (2)					
Ue $\leq 500\text{ V AC}$ - gG type fuse		630 A	800 A	1000 A	1000 A
Rated short-time withstand current Icw at 40 °C ambient temperature, in free air from a cold state	1 s	4600 A	4600 A	7000 A	7000 A
	10 s	4400 A	4400 A	6400 A	6400 A
	30 s	3100 A	3100 A	4500 A	4500 A
	1 min	2500 A	2500 A	3500 A	3500 A
	15 min	840 A	840 A	1300 A	1300 A
Maximum breaking capacity					
cos $\phi = 0.45$	at 440 V	4000 A	5000 A	6000 A	7500 A
(cos $\phi = 0.35$ for Ie > 100 A)	at 690 V	3500 A	4500 A	5000 A	7000 A
Power dissipation per pole					
	Ie / AC-1	30 W	42 W	32 W	50 W
	Ie / AC-3	16 W	21 W	17 W	28 W
Max. electrical switching frequency					
	AC-1	300 cycles/h		300 cycles/h	
	AC-3	300 cycles/h		300 cycles/h	
	AC-2, AC-4	60 cycles/h		60 cycles/h	



3-phase motors



1500 r.p.m. 50 Hz  
1800 r.p.m. 60 Hz  
3-phase motors

(1) For the corresponding kW/A or hp/A values of 1500 r.p.m, 50 Hz or 1800 r.p.m, 60 Hz, 3-phase motors, see "Motor rated operational powers and currents".  
 (2) For the protection of motor starters against short circuits, see "Coordination with short-circuit protection devices".  
 (3) Conductors with preparation.  
 (4) Max. connection bar width 50 mm.  
 (5) Max. connection bar width 100 mm.

# AF1250 ... AF2850 3-pole contactors

## Technical data

### Main pole - Utilization characteristics according to IEC

Contactors types	AC / DC operated	AF1250	AF1350	AF1650	AF2050	AF2650	AF2850
Standards		IEC 60947-1 / 60947-4-1 and EN 60947-1 / 60947-4-1					
Rated operational voltage $U_e$ max.		1000 V					
Rated frequency (without derating)		50/60 Hz					
Conventional free-air thermal current $I_{th}$ acc. to IEC 60947-4-1, open contactors, $\theta \leq 40^\circ\text{C}$		1260 A	1350 A	1650 A	2050 A	2650 A	2850 A
With conductor cross-sectional area (3)		1000 mm <sup>2</sup> (4)	1000 mm <sup>2</sup> (5)	1500 mm <sup>2</sup> (5)	2000 mm <sup>2</sup> (5)	3000 mm <sup>2</sup> (5)	3000 mm <sup>2</sup> (5)
AC-1 Utilization category							
For air temperature close to contactor							
$I_e$ / Rated operational current AC-1	$\theta \leq 40^\circ\text{C}$	1260 A	1350 A	1650 A	2050 A	2650 A	2850 A
$U_e$ max. $\leq 690$ V, 50/60 Hz	$\theta \leq 55^\circ\text{C}$	1040 A	1150 A	1450 A	1750 A	2350 A	2600 A
	$\theta \leq 70^\circ\text{C}$	875 A	1000 A	1270 A	1500 A	2120 A	2300 A
$I_e$ / Rated operational current AC-1	$\theta \leq 40^\circ\text{C}$	1260 A	1350 A	1650 A	2050 A	2650 A	2850 A
$U_e$ max. $\leq 1000$ V, 50/60 Hz	$\theta \leq 55^\circ\text{C}$	1040 A	1150 A	1450 A	1750 A	2350 A	2600 A
	$\theta \leq 70^\circ\text{C}$	875 A	1000 A	1270 A	1500 A	2120 A	2300 A
With conductor cross-sectional area		1000 mm <sup>2</sup> (4)	1000 mm <sup>2</sup> (5)	1500 mm <sup>2</sup> (5)	2000 mm <sup>2</sup> (5)	3000 mm <sup>2</sup> (5)	3000 mm <sup>2</sup> (5)
AC-3 Utilization category							
For air temperature close to contactor $\theta \leq 55^\circ\text{C}$							
$I_e$ / Max. rated operational current AC-3 (1)							
	220-230-240 V	-	860 A	1060 A	1060 A	-	-
	380-400 V	-	860 A	1060 A	1060 A	-	-
	415 V	-	860 A	1060 A	1060 A	-	-
	440 V	-	860 A	1060 A	1060 A	-	-
	500 V	-	800 A	970 A	970 A	-	-
	690 V	-	800 A	970 A	970 A	-	-
	1000 V	-	375 A	400 A	425 A	-	-
Rated operational power AC-3 (1)							
	220-230-240 V	-	257 kW	315 kW	-	-	-
	380-400 V	-	475 kW	560 kW	-	-	-
	415 V	-	500 kW	630 kW	630 kW	-	-
	440 V	-	560 kW	710 kW	710 kW	-	-
	500 V	-	560 kW	710 kW	-	-	-
	690 V	-	800 kW	1000 kW	1000 kW	-	-
	1000 V	-	560 kW	600 kW	630 kW	-	-
Rated making capacity AC-3		10 x $I_e$ AC-3 acc. to IEC 60947-4-1					
Rated breaking capacity AC-3		8 x $I_e$ AC-3 acc. to IEC 60947-4-1					
Short-circuit protection device for contactors without thermal overload relay							
Motor protection excluded (2)							
$U_e \leq 500$ V AC - gG type fuse		Please consult us for coordination with circuit-breaker					
Rated short-time withstand current $I_{cw}$ at 40 °C ambient temperature, in free air from a cold state	1 s	8000 A	10000 A	12000 A	12000 A	12000 A	12000 A
	10 s	7200 A	8000 A	10000 A	10000 A	10000 A	10000 A
	30 s	5200 A	6000 A	7500 A	7500 A	7500 A	7500 A
	1 min	4000 A	4500 A	5500 A	5500 A	5500 A	5500 A
	15 min	1500 A	1600 A	2200 A	2200 A	2800 A	3000 A
Maximum breaking capacity $\cos \phi = 0.45$ ( $\cos \phi = 0.35$ for $I_e > 100$ A)	at 440 V	7500 A	10000 A	12000 A	8400 A	8400 A	8400 A
	at 690 V	7000 A	-	-	-	-	-
Power dissipation per pole	$I_e$ / AC-1	80 W	80 W	80 W	125 W	200 W	200 W
	$I_e$ / AC-3	-	50 W	50 W	-	-	-
Max. electrical switching frequency	AC-1	300 cycles/h	60 cycles/h		60 cycles/h	15 cycles/h	15 cycles/h
	AC-3	-	60 cycles/h		-	-	-
	AC-2, AC-4	-	60 cycles/h		-	-	-

(1) For the corresponding kW/A or hp/A values of 1500 r.p.m, 50 Hz or 1800 r.p.m, 60 Hz, 3-phase motors, see "Motor rated operational powers and currents".

(2) For the protection of motor starters against short circuits, see "Coordination with short-circuit protection devices".

(3) Conductors with preparation.

(4) Max. connection bar width 50 mm.

(5) Max. connection bar width 100 mm.



# AF09 ... AF38 3-pole contactors

## Technical data

### Main pole - Utilization characteristics according to UL / NEMA / CSA

Contactor types	AC / DC operated	AF09	AF12	AF16	AF26	AF30	AF38		
Standards		UL 508, CSA C22.2 N°60947-4-1							
Max. operational voltage		600 V							
NEMA size		00	0	-	1	-	-		
NEMA continuous amp rating	Thermal current	9 A	18 A		27 A				
NEMA maximum horse power ratings 1-phase, 60 Hz	115 V AC	1/3 hp	1 hp		2 hp				
	230 V AC	1 hp	2 hp		3 hp				
NEMA maximum horse power ratings 3-phase, 60 Hz	200 V AC	1-1/2 hp	3 hp		7-1/2 hp				
	230 V AC	1-1/2 hp	3 hp		7-1/2 hp				
	460 V AC	2 hp	5 hp		10 hp				
	575 V AC	2 hp	5 hp		10 hp				
UL / CSA general use rating	600 V AC	25 A	28 A	30 A	45 A	50 A	50 A		
	With conductor cross-sectional area	AWG 10	AWG 10	AWG 10	AWG 8	AWG 8	AWG 8		
	1 pole	80 V DC	25 A	28 A	30 A	45 A	50 A	50 A	
	2 poles in serie	160 V DC	25 A	28 A	30 A	45 A	50 A	50 A	
	3 poles in serie	240 V DC	25 A	28 A	30 A	45 A	50 A	50 A	
	With conductor cross-sectional area		AWG 10	AWG 10	AWG 10	AWG 8	AWG 8	AWG 8	
	UL / CSA maximum 1-phase motor rating								
Full load current	120 V AC	13.8 A	16 A	20 A	24 A	24 A	24 A		
	240 V AC	10 A	12 A	17 A	17 A	28 A	28 A		
Horse power rating	120 V AC	3/4 hp	1 hp	1-1/2 hp	2 hp	2 hp	2 hp		
	240 V AC	1-1/2 hp	2 hp	3 hp	3 hp	5 hp	5 hp		
UL / CSA maximum 3-phase motor rating	Full load current (1)	200-208 V AC	7.8 A	11 A	17.5 A	25.3 A	32.2 A	32.2 A	
		220-240 V AC	6.8 A	9.6 A	15.2 A	22 A	28 A	28 A	
		440-480 V AC	7.6 A	11 A	14 A	21 A	27 A	34 A (3)	
		550-600 V AC	9 A	11 A	17 A	22 A	27 A (2)	32 A (3)	
	Horse power rating (1)	200-208 V AC	2 hp	3 hp	5 hp	7-1/2 hp	10 hp	10 hp	
		220-240 V AC	2 hp	3 hp	5 hp	7-1/2 hp	10 hp	10 hp	
		440-480 V AC	5 hp	7-1/2 hp	10 hp	15 hp	20 hp	25 hp (3)	
		550-600 V AC	7-1/2 hp	10 hp	15 hp	20 hp	25 hp (2)	30 hp (3)	
	UL / CSA - DC motor starting - 3 poles in series	Full Load Amps (FLA)	125 V DC	9.5 A	13.2 A	17 A	25 A	25 A	25 A
			250 V DC	8.5 A	12.2 A	12.2 A	20 A	29 A	29 A
Horse power rating		125 V DC	1 hp	1-1/2 hp	2 hp	3 hp	3 hp	3 hp	
		250 V DC	2 hp	3 hp	3 hp	5 hp	7-1/2 hp	7-1/2 hp	
Short-circuit protection device for contactors without thermal overload relay - Motor protection excluded									
High fault current		100 kA							
Fuse rating		30 A	30 A	60 A	60 A	100 A	100 A		
Fuse type, 600 V		J							
Max. electrical switching frequency									
For general use		600 cycles/h							
For motor use		1200 cycles/h							

(1) For the corresponding kW/A or hp/A values of 1500 r.p.m, 50 Hz or 1800 r.p.m, 60 Hz, 3-phase motors, see "Motor rated operational powers and currents".

(2) For contactors produced since week 49-2011.

(3) For contactors produced since week 36-2014.

## AF40 ... AF96 3-pole contactors

### Technical data

#### Main pole - Utilization characteristics according to UL / NEMA / CSA

Contactor types	AC / DC operated	AF40	AF52	AF65	AF80	AF96
Standards		UL 60947-4-1, CSA C22.2 N°60947-4-1				
Maximum operational voltage		600 V				
NEMA size		2	-	-	3	-
NEMA continuous amp rating	Thermal current	45 A	-	-	90 A	-
NEMA maximum horse power ratings						
1-phase, 60 Hz	115 V AC	3 hp	-	-	-	-
	230 V AC	7.5 hp	-	-	-	-
NEMA maximum horse power ratings						
3-phase, 60 Hz	200 V AC	10 hp	-	-	25 hp	-
	230 V AC	15 hp	-	-	30 hp	-
	460 V AC	25 hp	-	-	50 hp	-
	575 V AC	25 hp	-	-	50 hp	-
UL / CSA general use rating						
	600 V AC	60 A	80 A	90 A	105 A	115 A
With conductor cross-sectional area		AWG 6	AWG 4	AWG 3	AWG 2	AWG 2
1 pole	80 V DC	60 A	80 A	90 A	105 A	115 A
2 poles in serie	160 V DC	60 A	80 A	90 A	105 A	115 A
3 poles in serie	240 V DC	60 A	80 A	90 A	105 A	115 A
With conductor cross-sectional area		AWG 6	AWG 4	AWG 3	AWG 2	AWG 2
UL / CSA maximum 1-phase motor rating						
Full load current	120 V AC	34 A	34 A	56 A	80 A	80 A
	240 V AC	40 A	50 A	68 A	68 A	88 A
Horse power rating	120 V AC	3 hp	3 hp	5 hp	7-1/2 hp	7-1/2 hp
	240 V AC	7-1/2 hp	10 hp	15 hp	15 hp	20 hp
UL / CSA maximum 3-phase motor rating						
Full load current (1)	200-208 V AC	32.2 A	48.3 A	62.1 A	78.2 A	92 A
	220-240 V AC	42 A	54 A	68 A	80 A	80 A
	440-480 V AC	40 A	52 A	65 A	77 A	77 A
	550-600 V AC	41 A	52 A	62 A	77 A	77 A
Horse power rating (1)	200-208 V AC	10 hp	15 hp	20 hp	25 hp	30 hp
	220-240 V AC	15 hp	20 hp	25 hp	30 hp	30 hp
	440-480 V AC	30 hp	40 hp	50 hp	60 hp	60 hp
	550-600 V AC	40 hp	50 hp	60 hp	75 hp	75 hp
UL / CSA - DC motor starting - 3 poles in series						
Full Load Amps (FLA)	125 V DC	40 A	58 A	76 A	76 A	110 A
	250 V DC	38 A	55 A	72 A	89 A	106 A
Horse power rating	125 V DC	5 hp	7-1/2 hp	10 hp	10 hp	15 hp
	250 V DC	10 hp	15 hp	20 hp	25 hp	30 hp
Short-circuit protection device for contactors without thermal overload relay - Motor protection excluded						
High fault current		100 kA				
Fuse rating		150 A	150 A	150 A	200 A	200 A
Fuse type, 600 V		J				
Maximum electrical switching frequency						
For general use		600 cycles/h				
For motor use		1200 cycles/h				

(1) For the corresponding kW/A or hp/A values of 1500 r.p.m, 50 Hz or 1800 r.p.m, 60 Hz, 3-phase motors, see "Motor rated operational powers and currents".

# AF116 ... AF370 3-pole contactors

## Technical data

### Main pole - Utilization characteristics according to UL / NEMA / CSA

Contactor types	AC / DC operated	AF116	AF140	AF146	AF190	AF205	AF265	AF305	AF370
Standards		UL 60947-1 / 60947-4-1A and CSA 60947-1 / 60947-4-1A							
Maximum operational voltage		600V							
NEMA size		-	4	-	-	-	5	-	-
NEMA continuous amp rating	Thermal current	-	135 A	-	-	-	270 A	-	-
NEMA maximum horse power ratings									
1-phase, 60 Hz	115 V AC	-	-	-	-	-	-	-	-
	230 V AC	-	-	-	-	-	-	-	-
NEMA maximum horse power ratings									
3-phase, 60 Hz	200 V AC	-	40 hp	-	-	-	75 hp	-	-
	230 V AC	-	50hp	-	-	-	100 hp	-	-
	460 V AC	-	100 hp	-	-	-	200 hp	-	-
	575 V AC	-	100 hp	-	-	-	200 hp	-	-
UL / CSA general use rating									
600 V AC		160 A	200 A	200 A	250 A	300 A	350 A	400 A	520 A
With conductor cross-sectional area		AWG 2/0	AWG 3/0	AWG 3/0	MCM 250	MCM 350 (2)	MCM 500	2//AWG 3/0	2//MCM 300
UL / CSA maximum 1-phase motor rating									
Full load current	120 V AC	-	-	-	-	-	-	-	-
	240 V AC	-	-	-	-	-	-	-	-
Horse power rating	120 V AC	-	-	-	-	-	-	-	-
	240 V AC	-	-	-	-	-	-	-	-
UL / CSA maximum 3-phase motor rating									
Full load current (1)	200-208 V AC	92 A	120 A	120 A	150 A	177 A	221 A	285 A	359 A
	220-240 V AC	104 A	130 A	130 A	154 A	192 A	248 A	312 A	360 A
	440-480 V AC	96 A	124 A	124 A	156 A	180 A	240 A	302 A	361 A
	550-600 V AC	99 A	125 A	125 A	144 A	192 A	242 A	289 A	336 A
Horse power rating (1)	200-208 V AC	30 hp	40 hp	40 hp	50 hp	60 hp	75 hp	100 hp	125 hp
	220-240 V AC	40 hp	50 hp	50 hp	60 hp	75 hp	100 hp	125 hp	150 hp
	440-480 V AC	75 hp	100 hp	100 hp	125 hp	150 hp	200 hp	250 hp	300 hp
	550-600 V AC	100 hp	125 hp	125 hp	150 hp	200 hp	250 hp	300 hp	350 hp
Short-circuit protection device for contactors									
without thermal overload relay - Motor protection excluded									
High fault current		100 kA							
Fuse rating		225 A	250 A	250 A	450 A	400 A	500 A	600 A	800 A
Fuse type, 600 V		J							
Maximum electrical switching frequency									
For general use		300 cycles/h							
For motor use		300 cycles/h							

(1) For the corresponding kW/A or hp/A values of 1500 r.p.m, 50 Hz or 1800 r.p.m, 60 Hz, 3-phase motors, see "Motor rated operational powers and currents".

(2) For conductor cross-sectional area above MCM 300 use terminal enlargements LW205.

## AF400 ... AF750 3-pole contactors

### Technical data

#### Main pole - Utilization characteristics according to UL / NEMA / CSA

Contactor types	AC / DC operated	AF400	AF460	AF580	AF750
Standards		UL 60947-1 / 60947-4-1 and CSA C 22.2 N°60947-1 / 60947-4-1			
Maximum operational voltage		1000 V			
NEMA size		-	6	-	7
NEMA maximum horse power ratings					
1-phase, 60 Hz	115 V AC	-			
	230 V AC	-			
NEMA maximum horse power ratings					
3-phase, 60 Hz	200 V AC	-	150 hp	-	-
	230 V AC	-	200 hp	-	300 hp
	460 V AC	-	400 hp	-	600 hp
	575 V AC	-	400 hp	-	600 hp
UL / CSA general use rating					
1000 V AC		550 A	650 A	750 A	900 A
3 poles in serie	600 V DC	550 A	650 A	750 A	900 A
UL / CSA maximum 1-phase motor rating					
Full load current	120 V AC	-	-	-	-
	240 V AC	-	-	-	-
Horse power rating	120 V AC	-	-	-	-
	240 V AC	-	-	-	-
UL / CSA maximum 3-phase motor rating					
Full load current (1)	200-208 V AC	358.8 A	414 A	552 A	692.3 A
	220-240 V AC	360 A	480 A	604 A	722 A
	440-480 V AC	414 A	477 A	590 A	722 A
	550-600 V AC	382 A	472 A	578 A	672 A
Horse power rating (1)	200-208 V AC	125 hp	150 hp	200 hp	250 hp
	220-240 V AC	150 hp	200 hp	250 hp	300 hp
	440-480 V AC	350 hp	400 hp	500 hp	600 hp
	550-600 V AC	400 hp	500 hp	600 hp	700 hp
Short-circuit protection device for contactors					
without thermal overload relay - Motor protection excluded					
Fuse rating		1000 A		1200 A	
Fuse type, 600 V		L			
Maximum electrical switching frequency					
For general use		300 cycles/h			
For motor use		300 cycles/h			

(1) For the corresponding kW/A or hp/A values of 1500 r.p.m, 50 Hz or 1800 r.p.m, 60 Hz, 3-phase motors, see "Motor rated operational powers and currents".

## AF1250 ... AF2850 3-pole contactors

### Technical data

#### Main pole - Utilization characteristics according to UL / NEMA / CSA

Contactor types	AC / DC operated	AF1250	AF1350	AF1650	AF2050	AF2650	AF2850
Standards		UL 60947-1 / 60947-4-1 and CSA C 22.2 N°60947-1 / 60947-4-1					
Maximum operational voltage		1000 V					
NEMA size		-	-	8	-	-	-
NEMA maximum horse power ratings							
1-phase, 60 Hz	115 V AC	-	-	-	-	-	-
	230 V AC	-	-	-	-	-	-
NEMA maximum horse power ratings							
3-phase, 60 Hz	200 V AC	-	-	-	-	-	-
	230 V AC	300 hp	-	450 hp	-	-	-
	460 V AC	600 hp	-	900 hp	-	-	-
	575 V AC	600 hp	-	900 hp	-	-	-
UL / CSA general use rating							
1000 V AC		1210 A	1350 A	1650 A	2100 A	2700 A	2850 A
3 poles in serie	600 V DC	1210 A	-	-	-	-	-
UL / CSA maximum 1-phase motor rating							
Full load current	120 V AC	-	-	-	-	-	-
	240 V AC	-	-	-	-	-	-
Horse power rating	120 V AC	-	-	-	-	-	-
	240 V AC	-	-	-	-	-	-
UL / CSA maximum 3-phase motor rating							
Full load current (1)	200-208 V AC	-	954 A	1030 A	-	-	-
	220-240 V AC	-	954 A	1030 A	-	-	-
	440-480 V AC	-	954 A	1030 A	-	-	-
	550-600 V AC	-	944 A	1050 A	-	-	-
Horse power rating (1)	200-208 V AC	-	-	-	-	-	-
	220-240 V AC	-	400 hp	450 hp	-	-	-
	440-480 V AC	-	800 hp	900 hp	-	-	-
	550-600 V AC	-	1000 hp	1150 hp	-	-	-
Short-circuit protection device for contactors							
without thermal overload relay - Motor protection excluded							
Fuse rating		1200 A	Please consult us for coordination				
Fuse type, 600 V		L	with circuit-breaker				
Maximum electrical switching frequency							
For general use		300 cycles/h	60 cycles/h			15 cycles/h	15 cycles/h
For motor use		300 cycles/h	60 cycles/h			-	-

(1) For the corresponding kW/A or hp/A values of 1500 r.p.m, 50 Hz or 1800 r.p.m, 60 Hz, 3-phase motors, see "Motor rated operational powers and currents".

# AF09 ... AF96 3-pole contactors

## Technical data

### Main pole utilization characteristics - 3 N.O. non-reversing contactors

Contactor types	AC / DC operated	AF09	AF12	AF16	AF26	AF30	AF38	AF40	AF52	AF65	AF80	AF96
HVAC application - UL / CSA												
Definite purpose heating rating - 3-phase												
Full Load Amps (FLA)		20 A	25 A	30 A	45 A	50 A	50 A	60 A	80 A	90 A	105 A	115 A
Locked Rotor Amps (LRA)	200-208 V AC	120 A	150 A	180 A	270 A	300 A	300 A	360 A	480 A	540 A	630 A	690 A
	220-240 V AC	120 A	150 A	180 A	270 A	300 A	300 A	360 A	480 A	540 A	630 A	690 A
	440-480 V AC	120 A	150 A	180 A	270 A	300 A	300 A	360 A	480 A	540 A	630 A	690 A
	550-600 V AC	80 A	100 A	120 A	180 A	200 A	200 A	240 A	320 A	360 A	420 A	460 A
Definite purpose air conditioning rating - 3-phase												
Full Load Amps (FLA)		20 A	25 A	30 A	45 A	50 A	50 A	60 A	80 A	90 A	105 A	115 A
Locked Rotor Amps (LRA)	200-208 V AC	120 A	150 A	180 A	270 A	300 A	300 A	360 A	480 A	540 A	630 A	690 A
	220-240 V AC	120 A	150 A	180 A	270 A	300 A	300 A	360 A	480 A	540 A	630 A	690 A
	440-480 V AC	120 A	150 A	180 A	270 A	300 A	300 A	360 A	480 A	540 A	630 A	690 A
	550-600 V AC	80 A	100 A	120 A	180 A	200 A	200 A	240 A	320 A	360 A	420 A	460 A
AC Resistance air heating												
Full Load Amps (FLA)	600 V AC	20 A	25 A	30 A	45 A	50 A	50 A	65 A	80 A	90 A	105 A	115 A
Elevator control, load switching, 500 000 electrical operating cycles acc. to CSA B44.1 / ASME 17.5 paragraph 19.2.1												
1-phase												
Horse power rating	110-120 V AC	1/4 hp	1/3 hp	(1)	1-1/2 hp	2 hp	2 hp	3 hp	3 hp	3 hp	5 hp	5 hp
	220-240 V AC	1/2 hp	3/4 hp	(1)	3 hp	3 hp	5 hp	5 hp	7-1/2 hp	10 hp	10 hp	10 hp
3-phase												
Horse power rating	200-208 V AC	1 hp	2 hp	(1)	5 hp	7-1/2 hp	7-1/2 hp	10 hp	10 hp	15 hp	15 hp	15 hp
	220-240 V AC	1 hp	2 hp	(1)	5 hp	7-1/2 hp	10 hp	10 hp	15 hp	20 hp	20 hp	20 hp
	440-480 V AC	3 hp	5 hp	(1)	15 hp	20 hp	20 hp	25 hp	30 hp	40 hp	40 hp	40 hp
	550-600 V AC	3 hp	5 hp	(1)	15 hp	20 hp	20 hp	30 hp	40 hp	40 hp	50 hp	50 hp
Elevator control, 500 000 mechanical operating cycles, 5 electrical operating cycles acc. to CSA B44.1 / ASME 17.5 paragraph 19.2.2												
1-phase												
Horse power rating	110-120 V AC	3/4 hp	1 hp	1-1/2 hp	2 hp	2 hp	3 hp	3 hp	3 hp	5 hp	7-1/2 hp	7-1/2 hp
	220-240 V AC	1-1/2 hp	2 hp	3 hp	3 hp	5 hp	7.5 hp	7-1/2 hp	7-1/2 hp	10 hp	15 hp	20 hp
3-phase												
Horse power rating	200-208 V AC	2 hp	3 hp	5 hp	7-1/2 hp	10 hp	10 hp	10 hp	15 hp	20 hp	25 hp	30 hp
	220-240 V AC	2 hp	3 hp	5 hp	7-1/2 hp	10 hp	10 hp	15 hp	20 hp	25 hp	30 hp	30 hp
	440-480 V AC	5 hp	7-1/2 hp	10 hp	15 hp	20 hp	25 hp	30 hp	40 hp	50 hp	60 hp	60 hp
	550-600 V AC	7-1/2 hp	10 hp	15 hp	20 hp	25 hp	30 hp	40 hp	50 hp	60 hp	75 hp	75 hp
Lighting application - UL / CSA												
Tungsten lamps												
1-phase per pole	347 V AC	20 A	25 A	30 A	45 A	50 A	50 A	65 A	80 A	90 A	105 A	115 A
3-phase break all lines	600 V AC	20 A	25 A	30 A	45 A	50 A	50 A	65 A	80 A	90 A	105 A	115 A
Electrical discharge lamps (ballast)												
1-phase per pole	347 V AC	20 A	25 A	30 A	45 A	50 A	50 A	65 A	80 A	90 A	105 A	115 A
3-phase break all lines	600 V AC	20 A	25 A	30 A	45 A	50 A	50 A	65 A	80 A	90 A	105 A	115 A

(1) 3-pole AF16 cannot be used. Select 4-pole non-reversing contactor AF16...40-..



# AF116 ... AF370 3-pole contactors

## Technical data

### Main pole utilization characteristics - 3 N.O. non-reversing contactors

Contactor types	AC / DC operated	AF116	AF140	AF146	AF190	AF205	AF265	AF305	AF370
HVAC application - UL / CSA									
Definite purpose heating rating - 3-phase									
Full Load Amps (FLA)		116 A	125 A	160 A	200 A	250 A	300 A	350 A	520 A
Locked Rotor Amps (LRA)	200-208 V AC	800 A	875 A	1050 A	1400 A	1500 A	2100 A	2450 A	3120 A
	220-240 V AC	800 A	875 A	1050 A	1400 A	1500 A	2100 A	2450 A	3120 A
	440-480 V AC	800 A	875 A	1050 A	1400 A	1500 A	2100 A	2450 A	3120 A
	550-600 V AC	800 A	875 A	1050 A	1400 A	1500 A	2100 A	2450 A	3120 A
Definite purpose air conditioning rating - 3-phase									
Full Load Amps (FLA)		116 A	125 A	160 A	200 A	250 A	300 A	350 A	520 A
Locked Rotor Amps (LRA)	200-208 V AC	800 A	875 A	1050 A	1400 A	1500 A	2100 A	2450 A	3120 A
	220-240 V AC	800 A	875 A	1050 A	1400 A	1500 A	2100 A	2450 A	3120 A
	440-480 V AC	800 A	875 A	1050 A	1400 A	1500 A	2100 A	2450 A	3120 A
	550-600 V AC	800 A	875 A	1050 A	1400 A	1500 A	2100 A	2450 A	3120 A
AC Resistance air heating									
Full Load Amps (FLA)	600 V AC	160 A	200 A	200 A	250 A	300 A	400 A	450 A	520 A
Elevator control, load switching, 500 000 electrical operating cycles									
acc. to CSA B44.1 / ASME 17.5 paragraph 19.2.1									
3-phase									
Horse power rating	200-208 V AC	15 hp	15 hp	15 hp	20 hp	30 hp	40 hp	40 hp	50 hp
	220-240 V AC	20 hp	20 hp	20 hp	25 hp	30 hp	40 hp	50 hp	60 hp
	440-480 V AC	40 hp	40 hp	40 hp	60 hp	75 hp	100 hp	100 hp	125 hp
	550-600 V AC	50 hp	50 hp	50 hp	75 hp	100 hp	125 hp	150 hp	150 hp
Elevator control, 500 000 mechanical operating cycles, 5 electrical operating cycles									
acc. to CSA B44.1 / ASME 17.5. paragraph 19.2.2									
3-phase									
Horse power rating	200-208 V AC	30 hp	40 hp	40 hp	50 hp	60 hp	75 hp	100 hp	125 hp
	220-240 V AC	40 hp	50 hp	50 hp	60 hp	75 hp	100 hp	125 hp	150 hp
	440-480 V AC	75 hp	100 hp	100 hp	125 hp	150 hp	200 hp	250 hp	300 hp
	550-600 V AC	100 hp	125 hp	125 hp	150 hp	200 hp	250 hp	300 hp	350 hp
Lighting application - UL / CSA									
Tungsten lamps									
1-phase per pole	347 V AC	-	-	-	-	-	-	-	-
3-phase break all lines	600 V AC	-	-	-	-	-	-	-	-
Electrical discharge lamps (ballast)									
1-phase per pole	347 V AC	160 A	200 A	200 A	250 A	300 A	400 A	450 A	520 A
3-phase break all lines	600 V AC	160 A	200 A	200 A	250 A	300 A	400 A	450 A	520 A

# AF09 ... AF38 3-pole contactors

## Technical data

### General technical data

Contactor types	AC / DC operated	AF09	AF12	AF16	AF26	AF30	AF38
Rated insulation voltage Ui		690 V					
acc. to IEC 60947-4-1		600 V					
acc. to UL / CSA		6 kV					
Rated impulse withstand voltage Uimp.		6 kV					
Electromagnetic compatibility		Devices complying with IEC 60947-1 / EN 60947-1 - Environment A and B (1)					
Ambient air temperature close to contactor							
Operation	Fitted with thermal overload relay	-25...+60 °C					
	Without thermal overload relay	-40...+70 °C					
Storage		-60...+80 °C					
Climatic withstand		Category B according to IEC 60947-1 Annex Q					
Maximum operating altitude (without derating)		3000 m					
Mechanical durability							
Number of operating cycles		10 millions operating cycles					
Max. switching frequency		3600 cycles/h					
Shock withstand							
acc. to IEC 60068-2-27 and EN 60068-2-27							
Mounting position 1							
	Shock direction	1/2 sinusoidal shock for 11 ms: no change in contact position, closed or open position					
	A	30 g					
	B1	25 g closed position / 5 g open position					
	B2	15 g					
	C1	25 g					
	C2	25 g					
Vibration withstand		5...300 Hz					
acc. to IEC 60068-2-6		4 g closed position / 2 g open position					

(1) Environment B: all AF09...AF38 produced since week 08.2013.  
 AF09...AF38-...-12 (48 ...130 V 50 / 60 Hz - DC) compliant to environment A only: for environment B, select AF09...AF38Z-...-22.

### Mounting characteristics and conditions for use

Contactor types	AC / DC operated	AF09	AF12	AF16	AF26	AF30	AF38
Mounting positions							
		Max. N.C. built-in and add-on N.C. auxiliary contacts: see accessory fitting details for a 3-pole contactor AF09 ... AF38					
Mounting distances		The contactors can be assembled side by side					
Fixing							
On rail according to IEC 60715, EN 60715		35 x 7.5 mm or 35 x 15 mm					
By screws (not supplied)		2 x M4 screws placed diagonally					

# AF09 ... AF38 3-pole contactors

## Technical data

### Magnet system characteristics for AF09 ... AF38 contactors - AC / DC operated

Contactor types	AC / DC operated	AF09	AF12	AF16	AF26	AF30	AF38
Coil operating limits acc. to IEC 60947-4-1	AC supply	At $\theta \leq 60^\circ\text{C}$ $0.85 \times U_c \text{ min...}1.1 \times U_c \text{ max.}$ At $\theta \leq 70^\circ\text{C}$ $0.85 \times U_c \text{ min...}U_c \text{ max.}$					
	DC supply	At $\theta \leq 60^\circ\text{C}$ $0.85 \times U_c \text{ min...}1.1 \times U_c \text{ max.}$ At $\theta \leq 70^\circ\text{C}$ $0.85 \times U_c \text{ min...}U_c \text{ max.}$					
AC control voltage 50/60 Hz		24...500 V AC					
Rated control circuit voltage $U_c$		50 VA					
Coil consumption	Average pull-in value	50 VA					
	Average holding value	2.2 VA / 2 W					
DC control voltage		20...500 V DC					
Rated control circuit voltage $U_c$		50 W					
Coil consumption	Average pull-in value	2 W					
	Average holding value	2 W					
PLC-output control		Not suitable for direct control by PLC output					
Drop-out voltage		$\leq 60\%$ of $U_c \text{ min.}$					
Voltage sag immunity acc. to SEMI F47-0706		-					
Dips withstand $-20^\circ\text{C} \leq \theta \leq +60^\circ\text{C}$		-					
Operating time							
Between coil energization and:	N.O. contact closing	40...95 ms					
	N.C. contact opening	38...90 ms					
Between coil de-energization and:	N.O. contact opening	11...95 ms					
	N.C. contact closing	13...98 ms					

### Magnet system characteristics for AF09Z ... AF38Z 24 DC operated - designed for PLC - coil 30

Contactor types	DC operated	AF09Z	AF12Z	AF16Z	AF26Z	AF30Z	AF38Z
Coil operating limits acc. to IEC 60947-4-1	DC supply	At $\theta \leq 60^\circ\text{C}$ $0.85 \times U_c$ At $\theta \leq 70^\circ\text{C}$ $U_c$					
DC control voltage		24 V DC					
Rated control circuit voltage $U_c$		6 W					
Coil consumption	Average pull-in value	1.7 W					
	Average holding value	1.7 W					
PLC-output control		$\geq 250 \text{ mA}$ 24 V DC for PLCs and safety PLCs using broken wire detection					
Drop-out voltage		$\leq 60\%$ of $U_c \text{ min.}$					
Operating time							
Between coil energization and:	N.O. contact closing	27...53 ms					
	N.C. contact opening	20...35 ms					
Between coil de-energization and:	N.O. contact opening	17...29 ms					
	N.C. contact closing	22...57 ms					

### Magnet system characteristics for AF09Z ... AF38Z for specific applications - coils 20, 21, 22, 23

Contactor types	AC / DC operated	AF09Z	AF12Z	AF16Z	AF26Z	AF30Z	AF38Z
Coil operating limits acc. to IEC 60947-4-1	AC supply	At $\theta \leq 60^\circ\text{C}$ $0.85 \times U_c \text{ min...}1.1 \times U_c \text{ max.}$ At $\theta \leq 70^\circ\text{C}$ $0.85 \times U_c \text{ min...}U_c \text{ max.}$					
	DC supply	At $\theta \leq 70^\circ\text{C}$ $0.85 \times U_c \text{ min...}1.1 \times U_c \text{ max.}$					
AC control voltage		24...250 V AC					
Rated control circuit voltage $U_c$		16 VA					
Coil consumption	Average pull-in value	1.7 VA / 1.5 W					
	Average holding value	1.7 VA / 1.5 W					
DC control voltage		12...250 V DC					
Rated control circuit voltage $U_c$		12...16 W					
Coil consumption	Average pull-in value	1.7 W					
	Average holding value	1.7 W					
PLC-output control		(AF..Z coil 21) $\geq 500 \text{ mA}$ 24 V DC for PLCs - not suitable for safety PLCs					
Drop-out voltage		$\leq 60\%$ of $U_c \text{ min.}$					
Voltage sag immunity acc. to SEMI F47-0706		(AF..Z coil 21, 22, 23) conditions of use on request					
Dips withstand $-20^\circ\text{C} \leq \theta \leq +60^\circ\text{C}$		(AF..Z coil 21, 22, 23) 22 ms average for $U_c \geq 24 \text{ V}$ 50/60 Hz or $U_c \geq 20 \text{ V}$ DC					
Operating time							
Between coil energization and:	N.O. contact closing	40...95 ms					
	N.C. contact opening	38...90 ms					
Between coil de-energization and:	N.O. contact opening	11...95 ms					
	N.C. contact closing	13...98 ms					

# AF40 ... AF96 3-pole contactors

## Technical data

### General technical data

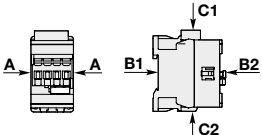
Contactor types	AC / DC operated	AF40	AF52	AF65	AF80	AF96
Rated insulation voltage $U_i$ acc. to IEC 60947-4-1 acc. to UL / CSA		690 V 600 V			1000 V	
Rated impulse withstand voltage $U_{imp}$ .		6 kV			8 kV	
Electromagnetic compatibility		Devices complying with IEC 60947-1 / EN 60947-1 - Environment A and B (1)				
Ambient air temperature close to contactor						
Operation	Fitted with thermal overload relay Without thermal overload relay	-40...+70 °C -40...+70 °C				
Storage		-60...+80 °C				
Climatic withstand		Category B according to IEC 60947-1 Annex Q				
Maximum operating altitude (without derating)		3000 m				
Mechanical durability						
Number of operating cycles		10 millions operating cycles				
Max. switching frequency		3600 cycles/h				
Shock withstand acc. to IEC 60068-2-27 and EN 60068-2-27						
Mounting position 1						
	Shock direction	1/2 sinusoidal shock for 11 ms: no change in contact position, closed or open position				
	A	25 g				
	B1	25 g closed position / 5 g open position				
	B2	15 g				
	C1	25 g				
C2	25 g					
Vibration withstand acc. to IEC 60068-2-6		5...300 Hz 3 g closed position / 3 g open position				

### Magnet system characteristics

Contactor types	AC / DC operated	AF40	AF52	AF65	AF80	AF96
Coil operating limits acc. to IEC 60947-4-1	AC supply DC supply	At $\theta \leq 70$ °C $0.85 \times U_c \text{ min} \dots 1.1 \times U_c \text{ max}$ At $\theta \leq 70$ °C $0.85 \times U_c \text{ min} \dots 1.1 \times U_c \text{ max}$				
AC control voltage 50/60 Hz						
Rated control circuit voltage $U_c$		24...500 V AC				
Coil consumption	Average pull-in value Average holding value	25 VA 4 VA / 2 W			40 VA	
DC control voltage						
Rated control circuit voltage $U_c$		20...500 V AC				
Coil consumption	Average pull-in value Average holding value	25 W 2 W			40 W	
PLC-output control		-				
Drop-out voltage		$\leq 60$ % of $U_c \text{ min}$ .				
Voltage sag immunity acc. to SEMI F47-0706		conditions of use on request				
Dips withstand -20 °C $\leq \theta \leq$ +60 °C		24 ms average				
Operating time						
Between coil energization and:	N.O. contact closing N.C. contact opening	42...100 ms 38...95 ms				
Between coil de-energization and:	N.O. contact opening N.C. contact closing	17...100 ms 19...105 ms				

### Mounting characteristics and conditions

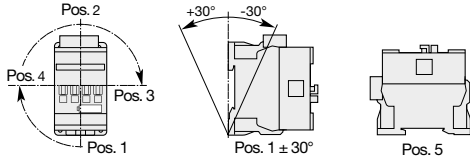
Contactor types	AC / DC operated	AF40	AF52	AF65	AF80	AF96
Mounting positions						
Mounting distances		Max. N.C. built-in and add-on N.C. auxiliary contacts: see accessory fitting details for a 3-pole contactor AF40 ... AF96				
Fixing		The contactors can be assembled side by side				
On rail according to IEC 60715, EN 60715		35 x 7.5 mm or 35 x 15 mm			35 x 15 mm	
By screws (not supplied)		2 x M4 or 2 x M6 screws placed diagonally				

# AF116 ... AF370 3-pole contactors

## Technical data

### General technical data

Contactor types	AC / DC operated	AF116	AF140	AF146	AF190	AF205	AF265	AF305	AF370
Rated insulation voltage Ui		1000 V							
acc. to IEC 60947-4-1		600 V							
acc. to UL / CSA		8 kV							
Rated impulse withstand voltage Uimp.		AF contactors comply with IEC 60947-1 / EN 60947-1 - Environment A							
Electromagnetic compatibility		AF contactors comply with IEC 60947-1 / EN 60947-1 - Environment A							
Ambient air temperature close to contactor		-25 to +55 °C							
Operation	Fitted with thermal overload relay	-40 to +70 °C							
	Without thermal overload relay	-40 to +70 °C							
Storage		-40 to +70 °C							
Climatic withstand		Category B according to IEC 60947-1 Annex Q							
Maximum operating altitude (without derating)		3000 m							
Mechanical durability		5 million operating cycles							
Number of operating cycles		300 cycles/h							
Maximum switching frequency		No change in contact position, closed or open position							
Shock withstand		No change in contact position, closed or open position							
acc. to IEC 60068-2-27 and EN 60068-2-27		Shock direction							
Mounting position 1		1/2 sinusoidal shock for 11 ms				1/2 sinusoidal shock for 30 ms			
		A 20 g				20 g			
		B1 15 g closed position / 3 g open position				15 g closed position / 3 g open position			
		B2 15 g closed position / 3 g open position				15 g closed position / 3 g open position			
		C1 20 g				20 g			
		C2 20 g				20 g			
Vibration withstand		0.7 g closed position / 0.7 g open position 13.2...100 Hz							
acc to IEC 60068-2-6									

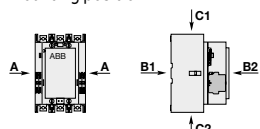

### Magnet system characteristics

Contactor types	AC / DC operated	AF116	AF140	AF146	AF190	AF205	AF265	AF305	AF370
Coil operating limits	AC supply	At $\theta \leq 70^\circ\text{C}$ $0.85 \times U_c \text{ min} \dots 1.1 \times U_c \text{ max}$							
acc. to IEC 60947-4-1	DC supply	At $\theta \leq 70^\circ\text{C}$ $0.80 \times U_c \text{ min} \dots 1.1 \times U_c \text{ max}$							
Rated control circuit voltage Uc		24...500 V AC, 20...500 V DC							
Coil consumption									
AC control voltage 50/60 Hz									
24...60 V AC	Average pull-in value	225 VA			165 VA		475 VA		
	Average holding value	5.5 VA			6 VA		8.5 VA		
48...130 V AC	Average pull-in value	170 VA			175 VA		340 VA		
	Average holding value	4 VA			4 VA		17 VA		
100...250 V AC	Average pull-in value	130 VA			220 VA		385 VA		
	Average holding value	6 VA			7 VA		17.5 VA		
250...500 V AC	Average pull-in value	205 VA			185 VA		420 VA		
	Average holding value	16 VA			16 VA		21 VA		
DC control voltage									
20...60 V DC	Average pull-in value	210 W			205 W		400 W		
	Average holding value	2.5 W			2.5 W		3.5 W		
48...130 V DC	Average pull-in value	130 W			130 W		360 W		
	Average holding value	2.5 W			2.5 W		2.5 W		
100...250 V DC	Average pull-in value	135 W			190 W		410 W		
	Average holding value	3 W			2.5 W		4.5 W		
250...500 V DC	Average pull-in value	205 W			190 W		600 W		
	Average holding value	4 W			4 W		4.7 W		
Drop-out voltage		55 % of Uc min							
Voltage sag immunity acc. to SEMI F47		Conditions of use on request							
Dips withstand		$\geq 20$ ms							
Operating time									
Coil supply between A1 - A2									
Between coil energization and:	N.O. contact closing	20...55 ms			25...60 ms		30...60 ms		
Between coil de-energization and*:	N.O. contact opening	40...70 ms			45...80 ms		45...80 ms		

(\* less than 20ms when using coil code -33 and -34

### Mounting characteristics and conditions for use

Contactor types	AC / DC operated	AF116	AF140	AF146	AF190	AF205	AF265	AF305	AF370
Mounting positions									
		Max. add-on N.O. or N.C. auxiliary contacts: see accessory fitting details for 3-pole contactor AF116 ... AF370							
Mounting distances		The contactors can be assembled side by side							
Fixing									
On rail acc. to IEC 60715, EN 60715		-							
By screws		4 x M4				4 x M5			

# AF400 ... AF750 3-pole contactors

## Technical data

### General technical data

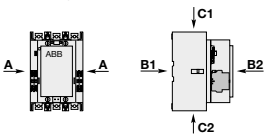
Contactor types	AC / DC operated	AF400	AF460	AF580	AF750
Rated insulation voltage Ui		1000 V			
acc. to IEC 60947-4-1		1000 V			
acc. to UL / CSA		600 V			
Rated impulse withstand voltage Uimp.		8 kV			
Electromagnetic compatibility		AF contactors complying with IEC 60947-1 / EN 60947-1 - Environment A			
Ambient air temperature close to contactor					
Operation	Fitted with electronic overload relay	-25 to +70 °C			
	Without electronic overload relay	-40 to +70 °C			
Storage		-40 to +70 °C			
Climatic withstand		Category B according to IEC 60947-1 Annex Q			
Maximum operating altitude (without derating)		3000 m			
Mechanical durability					
Number of operating cycles		3 millions operating cycles (contacts needs to be replaced every 0,75 millions operating cycles)			
Max. switching frequency		300 cycles/h			
Shock withstand					
acc. to IEC 60068-2-27 and EN 60068-2-27					
Mounting position 1					
		Shock direction	1/2 sinusoidal shock for 30 ms: no change in contact position, closed or open position		
		A	5 g		
		B1	5 g		
		B2	5 g		
		C1	5 g		
		C2	5 g		
Vibration withstand					
acc to IEC 60068-2-6		0.7 g closed position / 0.7 g open position 13.2...100 Hz			

### Magnet system characteristics

Contactor types	AC / DC operated	AF400	AF460	AF580	AF750
Coil operating limits	AC supply	At $\theta \leq 70^\circ\text{C}$ $0.85 \times U_c \text{ min} \dots 1.1 \times U_c \text{ max}$			
acc. to IEC 60947-4-1	DC supply	At $\theta \leq 70^\circ\text{C}$ $0.80 \times U_c \text{ min} \dots 1.1 \times U_c \text{ max}$			
Rated control circuit voltage Uc		48...500 V AC, 24...500 V DC			
Coil consumption					
AC control voltage 50/60 Hz					
48...130 V AC	Average pull-in value	1215 VA		1100 VA	
	Average holding value	12 VA		12 VA	
100...250 V AC	Average pull-in value	955 VA		880 VA	
	Average holding value	12 VA		12 VA	
250 ... 500 V AC	Average pull-in value	950 VA		985 VA	
	Average holding value	12 VA		12 VA	
DC control voltage					
24...60 V DC	Average pull-in value	900 W		785 W	
	Average holding value	5 W		5.5 W	
48...130 V DC	Average pull-in value	1150 W		1020 W	
	Average holding value	5 W		5 W	
100...250 V DC	Average pull-in value	895 W		880 W	
	Average holding value	5 W		5 W	
250 ... 500 V DC	Average pull-in value	885 W		910 W	
	Average holding value	7.5 W		7.5 W	
Drop-out voltage		55 % of Uc min.			
Voltage sag immunity acc. to SEMI F47		Conditions of use on request			
Dips withstand		$\geq 20$ ms			
Operating time					
Coil supply between A1 - A2					
Between coil energization and:	Main contact closing	50...120 ms			
Between coil de-energization and:	Main contact opening	33...70 ms			
Control input for PLC's					
Between coil energization and:	Main contact closing	40...60 ms		40...90 ms	
Between coil de-energization and:	Main contact opening	10...30 ms			

### Mounting characteristics and conditions for use

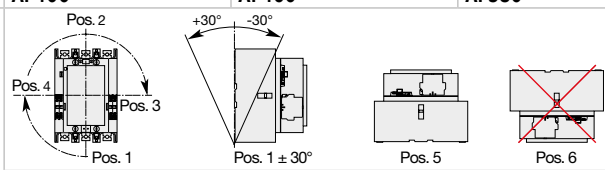
Contactor types	AC / DC operated	AF400	AF460	AF580	AF750
Mounting positions					
Mounting distances		Max. add-on N.O. or N.C. auxiliary contacts: see accessory fitting details for 3-pole contactor AF400 ... AF2650			
Fixing		The contactors can be assembled side by side			
On rail according to IEC 60715, EN 60715		-			
By screws		4 x M5		4 x M6	



# AF1250 ... AF2850 3-pole contactors

## Technical data

### General technical data

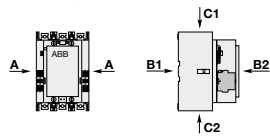
Contactor types	AC / DC operated	AF1250	AF1350	AF1650	AF2050	AF2650	AF2850
Rated insulation voltage Ui							
acc. to IEC 60947-4-1							
acc. to UL / CSA			1000 V				
Rated impulse withstand voltage Uimp.							
Electromagnetic compatibility							
Ambient air temperature close to contactor							
Operation	Fitted with electronic overload relay	-25 to +70 °C					
	Without electronic overload relay	-40 to +70 °C					
Storage		-40 to +70 °C					
Climatic withstand		Category B according to IEC 60947-1 Annex Q					
Maximum operating altitude (without derating)		3000 m					
Mechanical durability							
Number of operating cycles		0.5 million operating cycles				0.3 million operating cycles	
Max. switching frequency		300 cycles/h	60 cycles/h				
Shock withstand							
acc. to IEC 60068-2-27 and EN 60068-2-27							
Mounting position 1							
		Shock direction					
		A	5 g	-			
		B1	5 g	-			
		B2	5 g	-			
		C1	5 g	-			
		C2	5 g	-			
Vibration withstand							
acc to IEC 60068-2-6		0.7 g closed position / 0.7 g open position 13.2...100 Hz					

### Magnet system characteristics

Contactor types	AC / DC operated	AF1250	AF1350	AF1650	AF2050	AF2650	AF2850
Coil operating limits	AC supply						
acc. to IEC 60947-4-1	DC supply						
Rated control circuit voltage Uc			100...250 V AC or DC				
Coil consumption							
AC control voltage 50/60 Hz							
48...130 V AC	Average pull-in value	1100 VA	-				
	Average holding value	12 VA	-				
100...250 V AC	Average pull-in value	880 VA	2450 VA				
	Average holding value	12 VA	48 VA				
250 ... 500 V AC	Average pull-in value	985 VA	-				
	Average holding value	12 VA	-				
DC control voltage							
24...60 V DC	Average pull-in value	785 W	-				
	Average holding value	5.5 W	-				
48...130 V DC	Average pull-in value	1020 W	-				
	Average holding value	5 W	-				
100...250 V DC	Average pull-in value	880 W	2290 W				
	Average holding value	5 W	20.5 W				
250 ... 500 V DC	Average pull-in value	910 W	-				
	Average holding value	7.5 W	-				
Drop-out voltage		55 % of Uc min.					
Voltage sag immunity							
acc. to SEMI F47		Conditions of use on request					
Dips withstand		≥ 20 ms					
Operating time							
Coil supply between A1 - A2							
Between coil energization and:	Main contact closing	50...120 ms	50...80 ms				
Between coil de-energization and:	Main contact opening	33...70 ms	35...55 ms				
Control input for PLC's							
Between coil energization and:	Main contact closing	40...90 ms	40...65 ms				
Between coil de-energization and:	Main contact opening	10...30 ms	10...30 ms				

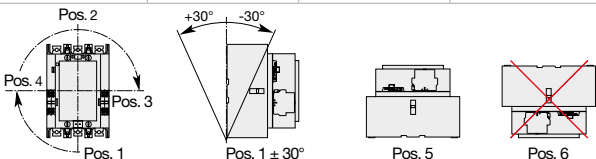

### Mounting characteristics and conditions for use

Contactor types	AC / DC operated	AF1250	AF1350	AF1650	AF2050	AF2650	AF2850
Mounting positions							
		Max. add-on N.O. or N.C. auxiliary contacts: see accessory fitting details for 3-pole contactor AF400 ... AF2650					
		The contactors can be assembled side by side					
Mounting distances							
Fixing							
On rail according to IEC 60715, EN 60715		-					
By screws		4 x M6	4 x M8				

## AF09 ... AF38 3-pole contactors

### Technical data











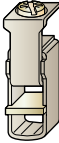
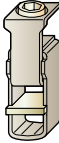



#### Connecting characteristics

Contactor types	AC / DC operated	AF09	AF12	AF16	AF26	AF30	AF38
Main terminals		 Screw terminals with cable clamp					
Connection capacity (min. ... max.)							
Main conductors (poles)							
 Rigid Solid ( $\leq 4 \text{ mm}^2$ )	}	1 x	1...6 mm <sup>2</sup>			2.5...10 mm <sup>2</sup>	
 Stranded ( $\geq 6 \text{ mm}^2$ )		2 x	1...6 mm <sup>2</sup>			2.5...10 mm <sup>2</sup>	
 Flexible with non insulated ferrule		1 x	0.75...6 mm <sup>2</sup>			1.5...10 mm <sup>2</sup>	
 Flexible with insulated ferrule		2 x	0.75...6 mm <sup>2</sup>			1.5...10 mm <sup>2</sup>	
 Flexible with insulated ferrule		1 x	0.75...4 mm <sup>2</sup>			1.5...10 mm <sup>2</sup>	
 Flexible with insulated ferrule		2 x	0.75...2.5 mm <sup>2</sup>			1.5...4 mm <sup>2</sup>	
 Bars or lugs		L <	9.6 mm			12.5 mm	
Connection capacity acc. to UL/CSA	1 or 2 x	AWG 16...10			AWG 14...8		
Stripping length		10 mm			14 mm		
Tightening torque		1.5 Nm / 13 lb.in			2.5 Nm / 22 lb.in		
Auxiliary conductors (built-in auxiliary terminals + coil terminals)							
 Rigid solid		1 x	1...2.5 mm <sup>2</sup>				
 Rigid solid		2 x	1...2.5 mm <sup>2</sup>				
 Flexible with non insulated ferrule		1 x	0.75...2.5 mm <sup>2</sup>				
 Flexible with non insulated ferrule		2 x	0.75...2.5 mm <sup>2</sup>				
 Flexible with insulated ferrule		1 x	0.75...2.5 mm <sup>2</sup>				
 Flexible with insulated ferrule		2 x	0.75...1.5 mm <sup>2</sup>				
 Lugs		L <	8 mm				
Connection capacity acc. to UL/CSA	1 or 2 x	AWG 18...14					
Stripping length		10 mm					
Tightening torque							
Coil terminals		1.2 Nm / 11 lb.in					
Built-in auxiliary terminals		1.2 Nm / 11 lb.in					
Degree of protection acc. to IEC 60947-1 / EN 60947-1 and IEC 60529 / EN 60529							
Main terminals		IP20					
Coil terminals		IP20					
Built-in auxiliary terminals		IP20					
Screw terminals		Delivered in open position, screws of unused terminals must be tightened					
Main terminals		M3.5			M4		
	Screwdriver type	Flat Ø 5.5 / Pozidriv 2			Flat Ø 6.5 / Pozidriv 2		
Coil terminals		M3.5					
	Screwdriver type	Flat Ø 5.5 / Pozidriv 2					
Built-in auxiliary terminals		M3.5					
	Screwdriver type	Flat Ø 5.5 / Pozidriv 2					

# AF40 ... AF96 3-pole contactors

## Technical data

### Connecting characteristics

Contactor types	AC / DC operated	AF40	AF52	AF65	AF80	AF96
Main terminals						
		Screw terminals with double connector 2 x (9.3 width x 7.9/10.3 depth)			Screw terminals with double connector 2 x (12.4 width x 9.3/11.1 depth)	
Connection capacity (min. ... max.)						
Main conductors (poles)						
 Rigid	Stranded ( $\geq 6 \text{ mm}^2$ )	1 x	6...35 mm <sup>2</sup>			6...70 mm <sup>2</sup>
		2 x	6...35 mm <sup>2</sup>			6...50 mm <sup>2</sup>
 Flexible with non insulated ferrule		1 x	4...35 mm <sup>2</sup>			6...50 mm <sup>2</sup>
		2 x	4...35 mm <sup>2</sup>			6...50 mm <sup>2</sup>
 Flexible with insulated ferrule		1 x	4...35 mm <sup>2</sup>			6...50 mm <sup>2</sup>
		2 x	4...35 mm <sup>2</sup>			6...50 mm <sup>2</sup>
 Bars or lugs		L <	9.2 mm			12.2 mm
Connection capacity acc. to UL/CSA	1 or 2 x	AWG 10...2			AWG 6...1	
Stripping length		16 mm			17 mm	
Tightening torque		4 Nm / 35 lb.in			6 Nm / 53 lb.in	
Auxiliary conductors (built-in auxiliary terminals + coil terminals)						
 Rigid solid		1 x	1...2.5 mm <sup>2</sup>			
		2 x	1...2.5 mm <sup>2</sup>			
 Flexible with non insulated ferrule		1 x	0.75...2.5 mm <sup>2</sup>			
		2 x	0.75...2.5 mm <sup>2</sup>			
 Flexible with insulated ferrule		1 x	0.75...2.5 mm <sup>2</sup>			
		2 x	0.75...1.5 mm <sup>2</sup>			
 Lugs		L <	8 mm			
Connection capacity acc. to UL/CSA	1 or 2 x	AWG 18...14				
Stripping length		10 mm				
Tightening torque						
Coil terminals		1.2 Nm / 11 lb.in				
Built-in auxiliary terminals		1.2 Nm / 11 lb.in				
Degree of protection acc. to IEC 60947-1 / EN 60947-1 and IEC 60529 / EN 60529						
Main terminals		IP10				
Coil terminals		IP20				
Built-in auxiliary terminals		IP20				
Screw terminals		Delivered in open position, screws of unused terminals must be tightened				
Main terminals			M6		M8	
	Screwdriver type	Flat Ø 6.5 / Pozidriv 2		Hexagon socket (s = 4 mm)		
Coil terminals		M3.5				
	Screwdriver type	Flat Ø 5.5 / Pozidriv 2				
Built-in auxiliary terminals		M3.5				
	Screwdriver type	Flat Ø 5.5 / Pozidriv 2				

# AF116 ... AF370 3-pole contactors

## Technical data

### Connecting characteristics

Contactor types	AC / DC operated	AF116	AF140	AF146	AF190	AF205	AF265	AF305	AF370
Main terminals									
Flat type									
Connection capacity (min. ... max.)									
Main conductors (poles)									
Cu cable - Stranded	1 x	10...95 mm <sup>2</sup>			6...150 mm <sup>2</sup>		16...300 mm <sup>2</sup>		
Clamp type		LD... included (1)			1SDA066917R1		1SDA055016R1		
Tightening torque		8 Nm			14 Nm		25 Nm		
Cu cable - Stranded	2 x	10...95 mm <sup>2</sup>			50...120 mm <sup>2</sup>		70...185 mm <sup>2</sup>		
Clamp type		LD... included (1)			1SFN074709R1000, LZ185-2C/120		1SCA022194R0890, OZXB4		
Tightening torque		8 Nm			16 Nm		22 Nm		
Al cable - Stranded	1 x	-			95...185 mm <sup>2</sup>		185...240 mm <sup>2</sup>		
Clamp type		-			1SDA054988R1		1SDA055020R1		
Tightening torque		-			31 Nm		43 Nm		
Cu cable - Flexible	1 x	10...70 mm <sup>2</sup>			6...120 mm <sup>2</sup>		16...240 mm <sup>2</sup>		
Clamp type		LD... included (1)			1SDA066917R1		1SDA055016R1		
Tightening torque		8 Nm			14 Nm		25 Nm		
Cu cable - Flexible	2 x	10...70 mm <sup>2</sup>			50...95 mm <sup>2</sup>		70...185 mm <sup>2</sup>		
Clamp type		LD... included (1)			1SFN074709R1000, LZ185-2C/120		1SCA022194R0890, OZXB4		
Tightening torque		8 Nm			16 Nm		22 Nm		
Lugs	L ≤	22 mm (.866 in)			24 mm (.945 in)		32 mm (1.260 in)		
	Ø >	6 mm (.236 in)			8 mm (.315 in)		10 mm (.394 in)		
Socket type		LL... included			LL... included		LL... included		
Tightening torque		9 Nm / 80 lb.in			18 Nm / 160 lb.in		28 Nm / 248 lb.in		
Connection capacity acc. to UL / CSA	1 x	AWG 6...3/0			6...300 MCM		4...400 MCM		
Clamp type		LD... included (1)			ATK185 (2)		ATK300 (2)		
Tightening torque		8 Nm / 71 lb.in			34 Nm / 301 lb.in		42 Nm / 372 lb.in		
Connection capacity acc. to UL / CSA	2 x	AWG 6...3/0			-		4...500 MCM		
Clamp type		LD... included (1)			-		ATK300/2 (2)		
Tightening torque		8 Nm / 71 lb.in			-		42 Nm / 372 lb.in		
Auxiliary conductors (coil terminals)									
Solid / stranded	1 x	1...4 mm <sup>2</sup>							
	2 x	1...4 mm <sup>2</sup>							
Flexible	1 x	0.75...2.5 mm <sup>2</sup>							
	2 x	0.75...2.5 mm <sup>2</sup>							
Flexible with non insulated ferrule	1 x	0.75...2.5 mm <sup>2</sup>							
	2 x	0.75...2.5 mm <sup>2</sup>							
Flexible with insulated ferrule	1 x	0.75...2.5 mm <sup>2</sup>							
	2 x	0.75...2.5 mm <sup>2</sup>							
Lugs	L <	8 mm							
	l >	3.5 mm							
Connection capacity acc. to UL / CSA	1 or 2 x	AWG 18...14							
Stripping length		9 mm							
Tightening torque		1.00 Nm / 9 lb.in							
Degree of protection acc. to IEC 60947-1 / EN 60947-1 and IEC 60529 / EN 60529									
Main terminals		IP00							
Coil terminals		IP20							
Screw terminals									
Main terminals		M6			M8		M10		
Screwdriver type		Screws and bolts							
Coil terminals (delivered in open position)		M3.5							
Screwdriver type		Flat Ø 5.5 mm / Pozidriv 2							











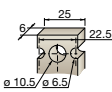
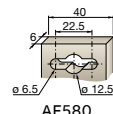













(1) LD... not included for AF116 ... AF146-30...B.

(2) Available in North America only.

# AF400 ... AF750 3-pole contactors

## Technical data

### Connecting characteristics











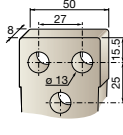
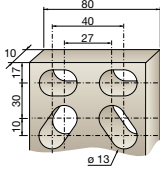
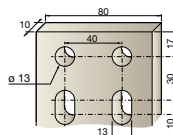
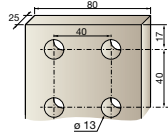







Contactor types	AC / DC operated	AF400	AF460	AF580	AF750
Main terminals Flat type					
Connection capacity (min. ... max.)					
Main conductors (poles)					
 Cu cable - Stranded	2 x	240 mm <sup>2</sup>		-	
 Clamp type		1SDA013922R1		-	
 Tightening torque		35 Nm		-	
 Cu cable - Stranded	3 x	-	185 mm <sup>2</sup>		
 Clamp type		-	1SDA013956R1		
 Tightening torque		35 Nm	45 Nm		
 Al cable - Stranded	2 x	240 mm <sup>2</sup>		-	
 Clamp type		1SDA013922R1		-	
 Tightening torque		35 Nm		-	
 Al cable - Stranded	3 x	-	185 mm <sup>2</sup>		
 Clamp type		-	1SDA013956R1		
 Tightening torque		35 Nm	45 Nm		
 Lugs	L ≤	47 mm	50 mm		
	Ø >	10 mm	12 mm		
 Tightening torque		35 Nm / 310 lb.in	45 Nm / 398 lb.in		
Connection capacity acc. to UL / CSA	2 x	250-500 MCM alt. 2/0 AWG-500 MCM	-		
 Clamp type		K6TH alt. ATK580	-		
 Tightening torque		275 lb.in	-		
Connection capacity acc. to UL / CSA	3 x	2/0 AWG-400 MCM	2/0 AWG-500 MCM		
 Clamp type		K6TJ	ATK750/3		
 Tightening torque		275 lb.in	375 lb.in		
Auxiliary conductors (coil terminals)					
 Solid / stranded	1 x	1...4 mm <sup>2</sup>			
	2 x	1...4 mm <sup>2</sup>			
 Flexible	1 x	0.75...2.5 mm <sup>2</sup>			
	2 x	0.75...2.5 mm <sup>2</sup>			
 Flexible with non insulated ferrule	1 x	0.75...2.5 mm <sup>2</sup>			
	2 x	0.75...2.5 mm <sup>2</sup>			
 Flexible with insulated ferrule	1 x	0.75...2.5 mm <sup>2</sup>			
	2 x	0.75...2.5 mm <sup>2</sup>			
 Lugs	L ≤	8 mm			
	l >	3.7 mm			
Connection capacity acc. to UL / CSA	1 or 2 x	AWG 18...14			
 Tightening torque	Recommended	1.00 Nm / 9 lb.in			
	Max.	1.20 Nm			
Degree of protection acc. to IEC 60947-1 / EN 60947-1 and IEC 60529 / EN 60529					
Main terminals		IP00			
Coil terminals		IP20			
Screw terminals					
Main terminals		M10	M12		
		Screws and bolts			
Coil terminals (delivered in open position)		M3.5			
Screwdriver type		Flat Ø 5.5 mm / Pozidriv 2			

03

# AF1250 ... AF2850 3-pole contactors

## Technical data

### Connecting characteristics

Contactor types	AC / DC operated	AF1250	AF1350	AF1650	AF2050	AF2650	AF2850
Main terminals Flat type							
Connection capacity (min. ... max.)							
Main conductors (poles)							
 Cu cable - Stranded	2 x	-					
 Clamp type		-					
 Tightening torque		-					
 Cu cable - Stranded	3 x	-					
 Clamp type		-					
 Tightening torque		-					
 Al cable - Stranded	2 x	-					
 Clamp type		-					
 Tightening torque		-					
	3 x	-					
 Clamp type		-					
 Tightening torque		-					
 Lugs	L ≤	50 mm	100 mm				
	Ø >	12 mm					
	Tightening torque	45 Nm / 398 lb.in					
Connection capacity acc. to UL / CSA	2 x	2// 3 x 0.25 in	4/0 AWG - 500 MCM		4//4 x 0.25 in		
	Clamp type	bars, use LW1250	K7TK ATK1350/4	K7TK	bars		
	Tightening torque		375 lb.in		-		
Connection capacity acc. to UL / CSA	3 x	2/0 AWG-500 MCM	1/0-750 MCM		-		
	Clamp type	ATK750/3	K8TL, K8TM, ATK1650/4	K8TL, K8TM, ATK1650/4, ATK1650/6	-		
	Tightening torque	375 lb.in	500 lb.in		-		
Auxiliary conductors (coil terminals)							
 Solid / stranded	1 x	1...4 mm <sup>2</sup>					
	2 x	1...4 mm <sup>2</sup>					
 Flexible	1 x	0.75...2.5 mm <sup>2</sup>					
	2 x	0.75...2.5 mm <sup>2</sup>					
 Flexible with non insulated ferrule	1 x	0.75...2.5 mm <sup>2</sup>					
	2 x	0.75...2.5 mm <sup>2</sup>					
 Flexible with insulated ferrule	1 x	0.75...2.5 mm <sup>2</sup>					
	2 x	0.75...2.5 mm <sup>2</sup>					
 Lugs	L ≤	8 mm					
	L >	3.7 mm					
Connection capacity acc. to UL / CSA	1 or 2 x	AWG 18...14					
Tightening torque	Recommended	1.00 Nm / 9 lb.in					
	Max.	1.20 Nm					
Degree of protection acc. to IEC 60947-1 / EN 60947-1 and IEC 60529 / EN 60529							
Main terminals		IP00					
Coil terminals		IP20					
Screw terminals							
Main terminals		M12					
		Screws and bolts					
Coil terminals (delivered in open position)		M3.5					
Screwdriver type		Flat Ø 5.5 mm / Pozidriv 2					



# AF09 ... AF96 3-pole contactors

## Technical data

### Built-in auxiliary contacts according to IEC

Contactor types	AC / DC operated	AF09	AF12	AF16	AF26	AF30	AF38	AF40	AF52	AF65	AF80	AF96
Rated operational voltage Ue max.		690 V										
Rated frequency (without derating)		50 / 60 Hz										
Conventional free air thermal current Ith - θ ≤ 40 °C		16 A										
Ie / Rated operational current AC-15 acc. to IEC 60947-5-1	24-127 V 50/60 Hz	6 A										
	220-240 V 50/60 Hz	4 A										
	400-440 V 50/60 Hz	3 A										
	500 V 50/60 Hz	2 A										
	690 V 50/60 Hz	2 A										
Making capacity AC-15		10 x Ie AC-15 acc. to IEC 60947-5-1										
Breaking capacity AC-15		10 x Ie AC-15 acc. to IEC 60947-5-1										
Ie / Rated operational current DC-13 acc. to IEC 60947-5-1	24 V DC	6 A / 144 W										
	48 V DC	2.8 A / 134 W										
	72 V DC	1 A / 72 W										
	110 V DC	0.55 A / 60 W										
	125 V DC	0.55 A / 69 W										
	220 V DC	0.27 A / 60 W										
	250 V DC	0.27 A / 68 W										
	400 V DC	0.15 A / 60 W										
	500 V DC	0.13 A / 65 W										
	600 V DC	0.1 A / 60 W										
Short-circuit protection device gG type fuse		10 A										
Rated short-time withstand current Icw	for 1.0 s	100 A										
	for 0.1 s	140 A										
Minimum switching capacity with failure rate acc. to IEC 60947-5-4		12 V / 3 mA										
		10-7										
Non-overlapping time between N.O. and N.C. contacts		≥ 2 ms										
Power dissipation per pole at 6 A		0.1 W										
Max. electrical switching frequency	AC-15	1200 cycles/h										
	DC-13	900 cycles/h										
Mechanically linked contacts acc. to annex L of IEC 60947-5-1		Built-in N.O. or N.C. auxiliary contacts and additional N.O. or N.C. auxiliary contacts (CA4, CAL4, CAT4 aux. contact blocks) are mechanically linked contacts.										
Mirror contacts acc. to annex F of IEC 60947-4-1		Built-in N.C. auxiliary contacts or additional N.C. auxiliary contacts (CA4, CAL4, CAT4 aux. contact blocks) are mirror contacts.										

### Built-in auxiliary contacts according to UL / CSA

Contactor types	AC / DC operated	AF09	AF12	AF16	AF26	AF30	AF38	AF40	AF52	AF65	AF80	AF96
Max. operational voltage		600 V AC, 600 V DC										
Pilot duty		A600, Q600										
AC thermal rated current		10 A										
AC maximum volt-ampere making		7200 VA										
AC maximum volt-ampere breaking		720 VA										
DC thermal rated current		2.5 A										
DC maximum volt-ampere making-breaking		69 VA										

## 3-pole contactors

### Electrical durability and utilization categories

#### General

Utilization categories determine the current making and breaking conditions relating to the characteristics of the loads to be controlled by the contactors. International standard IEC 60947-4-1 and European standard EN 60947-4-1 are the standards to be referred to.

If  $I_c$  is the current to be broken by the contactor and  $I_e$  the rated operational current normally drawn by the load, then:

- Categories AC-1 and AC-3:  $I_c = I_e$
- Category AC-2:  $I_c = 2.5 \times I_e$
- Category AC-4:  $I_c = 6 \times I_e$

Generally speaking  $I_c = m \times I_e$  where  $m$  is a multiple of the load operational current.

On next pages, the curves corresponding to categories AC-1, AC-3 and AC-4 represent the electrical durability variation of standard contactors in relation to the breaking current  $I_c$ .

Electrical durability is expressed in millions of operating cycles.

#### Curve utilization mode

##### Electrical durability forecast and contactor selection for categories AC-1, AC-2, AC-3 or AC-4

- Note the characteristics of the load to be controlled:
  - Operational voltage .....  $U_e$
  - Current normally drawn .....  $I_e$  ( $U_e / I_e / kW$  relation for motors, see "Motor rated operational powers and currents").
  - Utilization category ..... AC-1, AC-2, AC-3 or AC-4
  - Breaking current .....  $I_c = I_e$  for AC-1 and for AC-3 ;  $I_c = 2.5 \times I_e$  for AC-2 ;  $I_c = 6 \times I_e$  for AC-4
- Define the number of operating cycles  $N$  required.
- On the diagram corresponding to the operational category, select the contactor with the curve immediately above the intersection point ( $I_c ; N$ ).

##### Electrical durability forecast and contactor selection for mixed duty motor control: AC-3 ( $I_c = I_e$ ) type switching off while "motor running" and, occasionally, AC-4 ( $I_c = 6 \times I_e$ ) type switching off while "motor accelerating"

- Note the characteristics of the motor to be controlled:
  - Operational voltage .....  $U_e$
  - Current normally drawn while "motor running" .....  $I_e$  ( $U_e / I_e / kW$  relation for motors, see "Motor rated operational powers and currents")
  - Breaking current for AC-3 .....  $I_c = I_e$
  - Breaking current for AC-4 while "motor accelerating" .....  $I_c = 6 \times I_e$
  - Percentage of AC-4 operating cycles .....  $K$  (on the basis of the total number of operating cycles)
- Define the total number of operating cycles  $N$  required.
- Note the smallest contactor rating compatible for AC-3 ( $U_e / I_e$ ) on Main pole utilization characteristic table (see "Technical data").
- For the selected contactor make a note of the following in relation to the voltage using diagram AC-3 in next pages:
  - The number of operating cycles  $A$  for  $I_c = I_e$  (AC-3)
  - The number of operating cycles  $B$  for  $I_c = 6 \times I_e$  (AC-4)
- Calculate the estimated number of cycles  $N'$  ( $N'$  is always below  $A$ )

$$N' = \frac{A}{1 + 0.01 K (A/B - 1)}$$

- If  $N'$  is too low in relation to the target  $N$ , calculate the estimated number of cycles for a higher contactor rating.

#### Case of uninterrupted duty

For uninterrupted duty, some verifications of preventing maintenance are necessary to check the functionality of the concerned product (consult us).

The combined effect of environmental conditions and the proper temperature of the product may require some disposals. As a matter of fact, for this duty, the use duration prevails over the number of operating cycles.

# 3-pole contactors

## Electrical durability

### Electrical durability for AC-1 utilization category - $U_e \leq 690\text{ V}$

Switching non-inductive or slightly inductive loads. The breaking current  $I_c$  for AC-1 is equal to the rated operational current of the load.

Ambient temperature and maximum electrical switching frequency: see "Technical data".

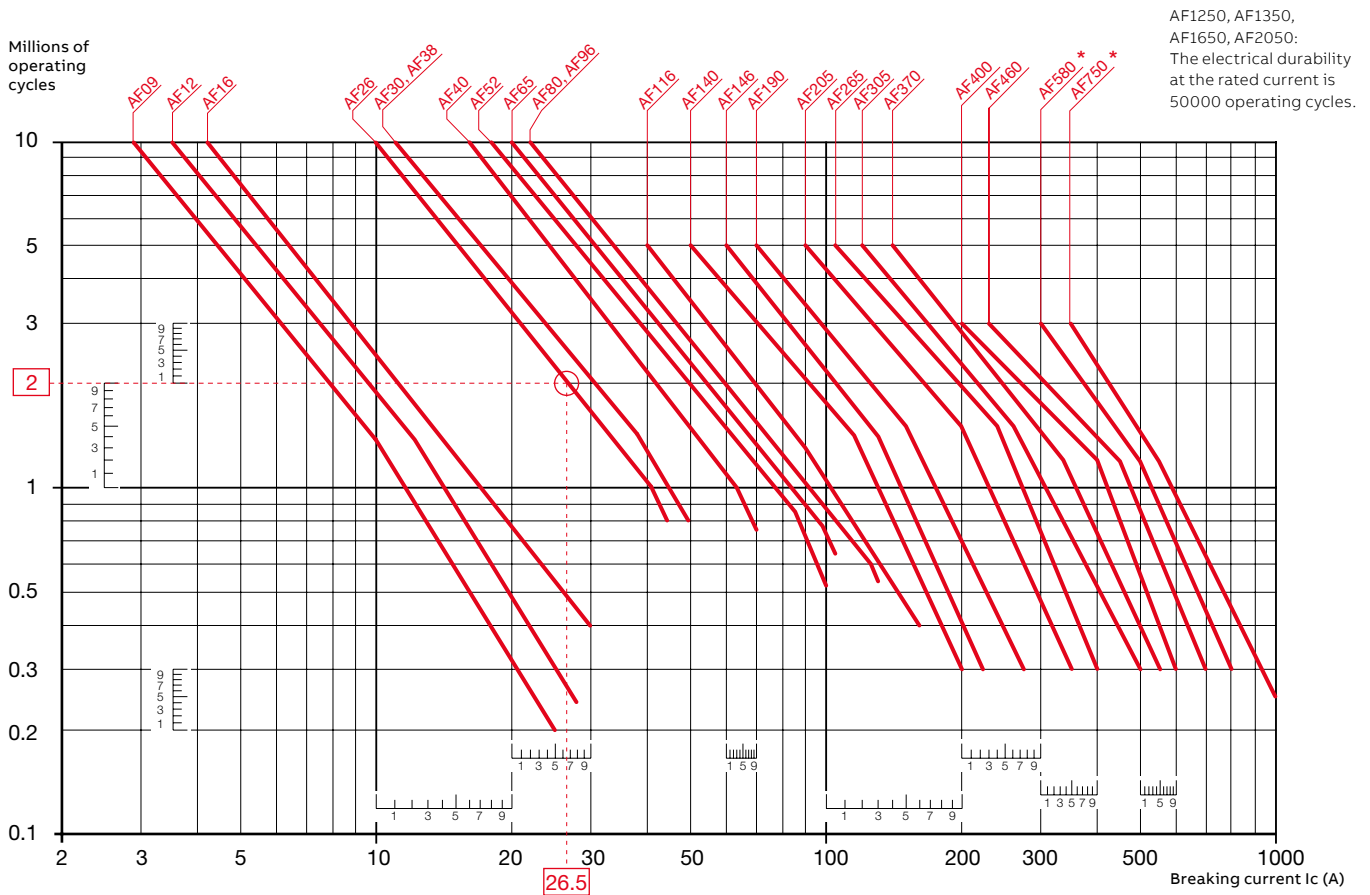

Note: \* For AF580 and AF750 contacts needs to be replaced after 750k operations.

**Example:**

$I_c / AC-1 = 26.5\text{ A}$  – Electrical durability required = 2 millions operating cycles.

Using the AC-1 curves above select the AF26 contactor at intersection "O" (26.5 A / 2 millions operating cycles).

# 3-pole contactors

## Electrical durability

### Electrical durability for AC-3 utilization category - $U_e \leq 440$ V.

Switching cage motors: starting and switching off running motors. The breaking current  $I_c$  for AC-3 is equal to the rated operational current  $I_e$  ( $I_e$  = motor full load current).

Ambient temperature and maximum electrical switching frequency: see "Technical data".

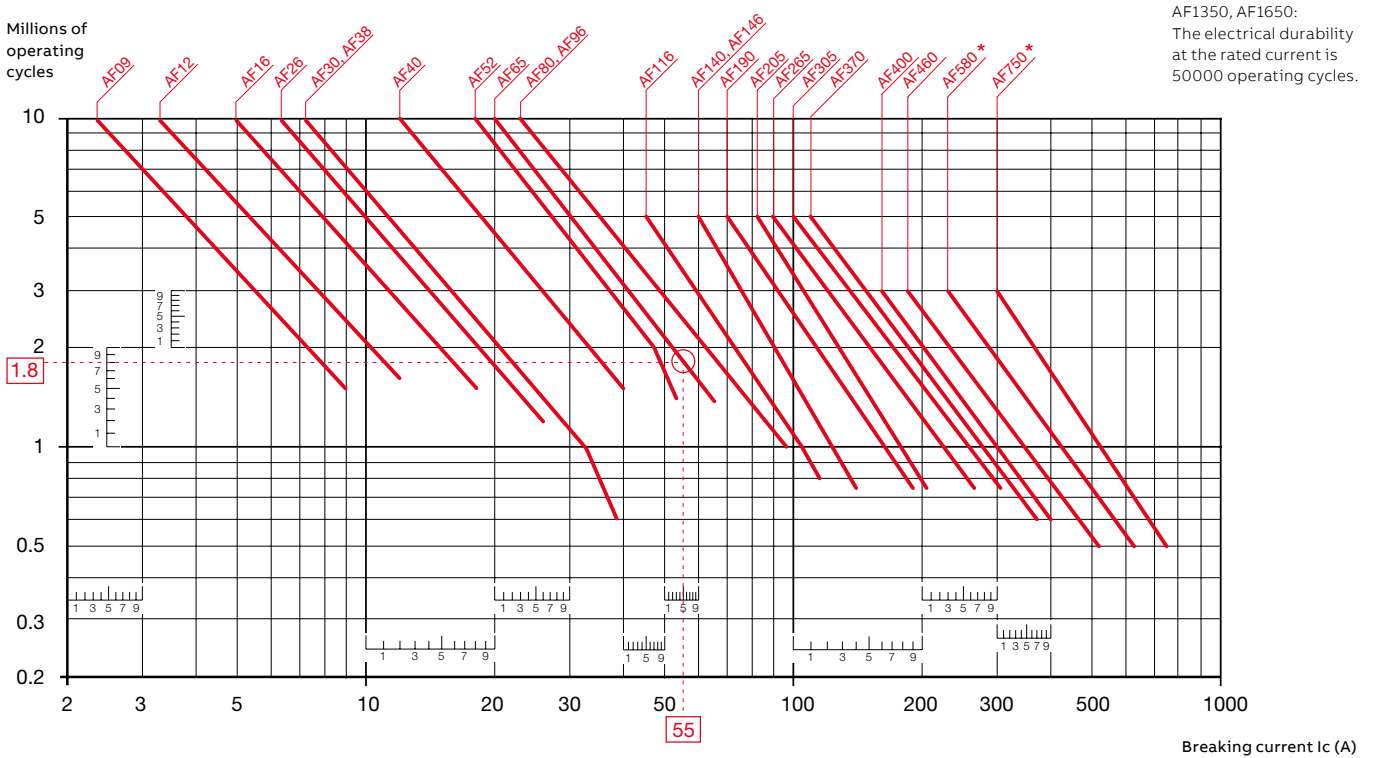

Note: \* For AF580 and AF750 contacts needs to be replaced after 750k operations.

### Example:

Motor power 30 kW for AC-3 -  $U_e = 400$  V and  $I_e = 55$  A utilization – Electrical durability required = 1.8 million operating cycles. For AC-3:  $I_c = I_e$ . Select the AF65 contactor at intersection "O" (55 A / 1.8 million operating cycles) on the curves (AC-3 -  $U_e \leq 440$  V).

# 3-pole contactors

## Electrical durability

### Electrical durability for AC-3 utilization category - 440 V < Ue ≤ 690 V.

Switching cage motors: starting and switching off running motors. The breaking current I<sub>c</sub> for AC-3 is equal to the rated operational current I<sub>e</sub> (I<sub>e</sub> = motor full load current).

Ambient temperature and maximum electrical switching frequency: see "Technical data".

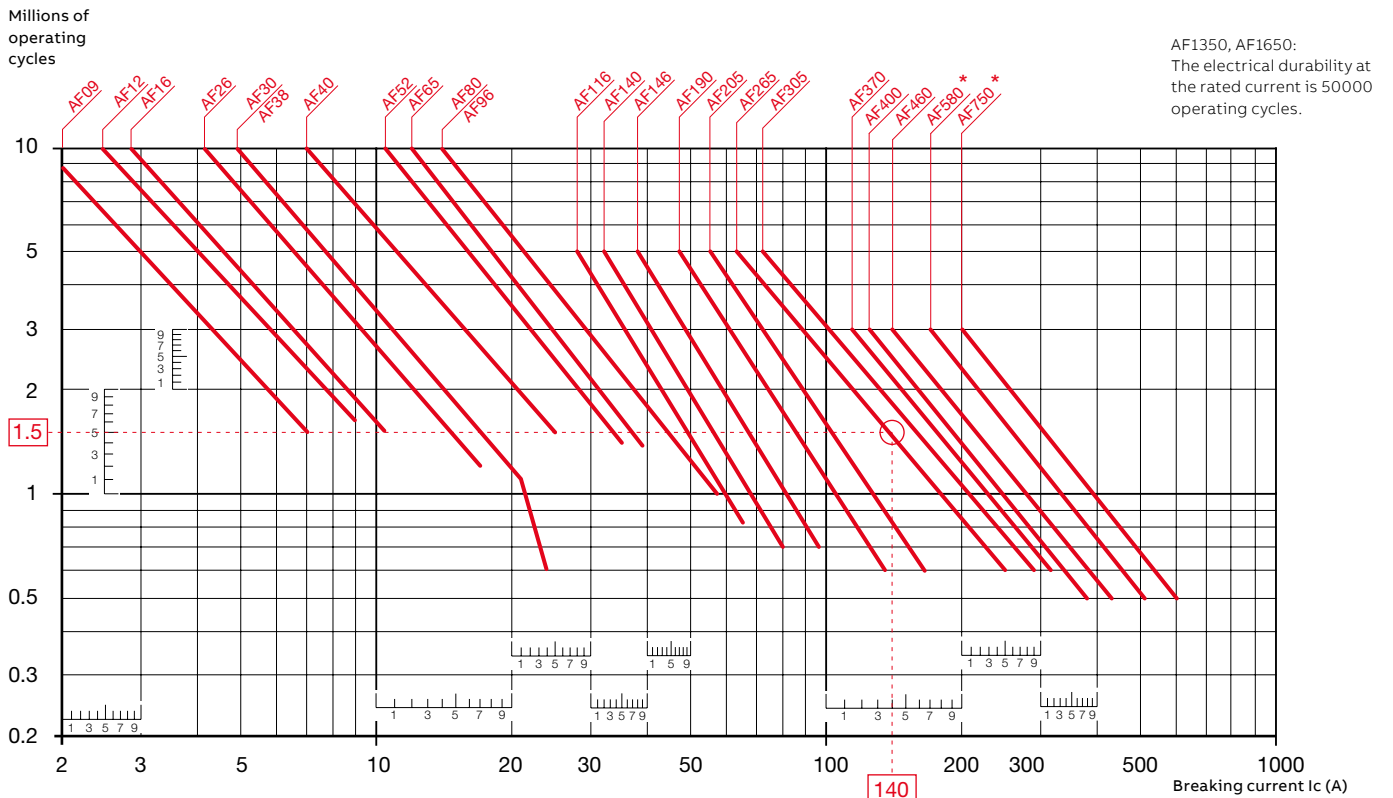

Note: \* For AF580 and AF750 contacts needs to be replaced after 750k operations.

#### Example:

Motor power 132 kW for AC-3 - U<sub>e</sub> = 660 V and I<sub>e</sub> = 140 A utilization – Electrical durability required = 1.5 million operating cycles. For AC-3: I<sub>c</sub> = I<sub>e</sub>. Select the AF265 contactor at intersection "O" (140 A / 1.5 million operating cycles) on the curves (AC-3 - 440 V < U<sub>e</sub> ≤ 690 V).

# 3-pole contactors

## Electrical durability

### Electrical durability for AC-2 or AC-4 utilization category - $U_e \leq 440\text{ V}$

Ambient temperature  $\leq 60\text{ }^\circ\text{C}$  for AF09 ... AF370,  $\leq 55\text{ }^\circ\text{C}$  for AF400 ... AF1650

Switching cage motors: starting, reverse operation and step-by-step operation. The breaking current  $I_c$  is equal to  $2.5 \times I_e$  for AC-2 and  $6 \times I_e$  for AC-4, keeping in mind that  $I_e$  is the motor rated operational current ( $I_e$  = motor full-load current).

Maximum electrical switching frequency: see "Technical data".

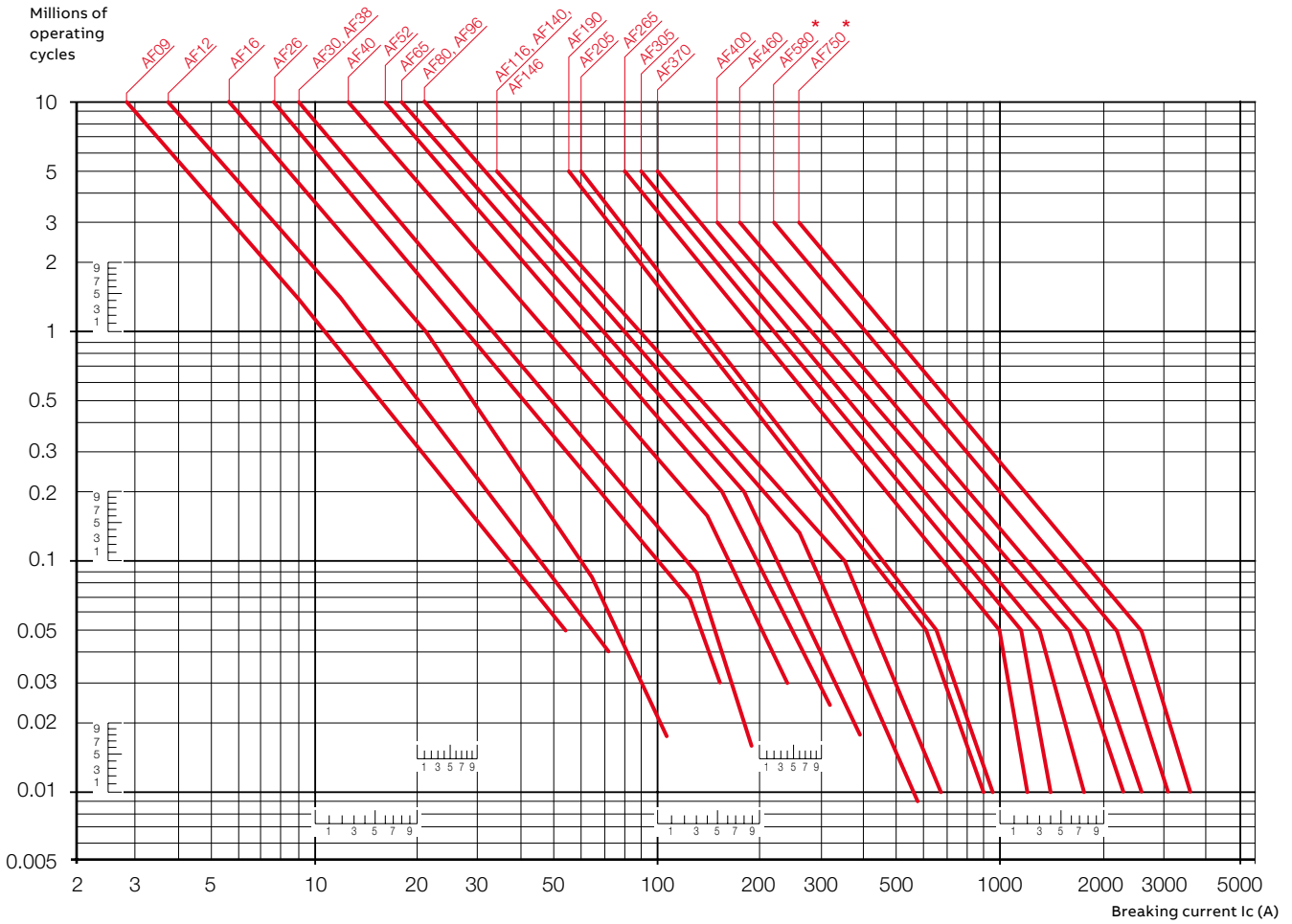

Note: \* For AF580 and AF750 contacts needs to be replaced after 750k operations.



### 3-pole contactors

#### Electrical durability

**Electrical durability for AC-2 or AC-4 utilization category -  $440\text{ V} < U_e \leq 690\text{ V}$**

**Ambient temperature  $\leq 60\text{ }^\circ\text{C}$  for AF09 ... AF370,  $\leq 55\text{ }^\circ\text{C}$  for AF400 ... AF750**

Switching cage motors: starting, reverse operation and step-by-step operation. The breaking current  $I_c$  is equal to  $2.5 \times I_e$  for AC-2 and  $6 \times I_e$  for AC-4, keeping in mind that  $I_e$  is the motor rated operational current ( $I_e$  = motor full load current). Maximum electrical switching frequency: see "Technical data".

Millions of operating cycles

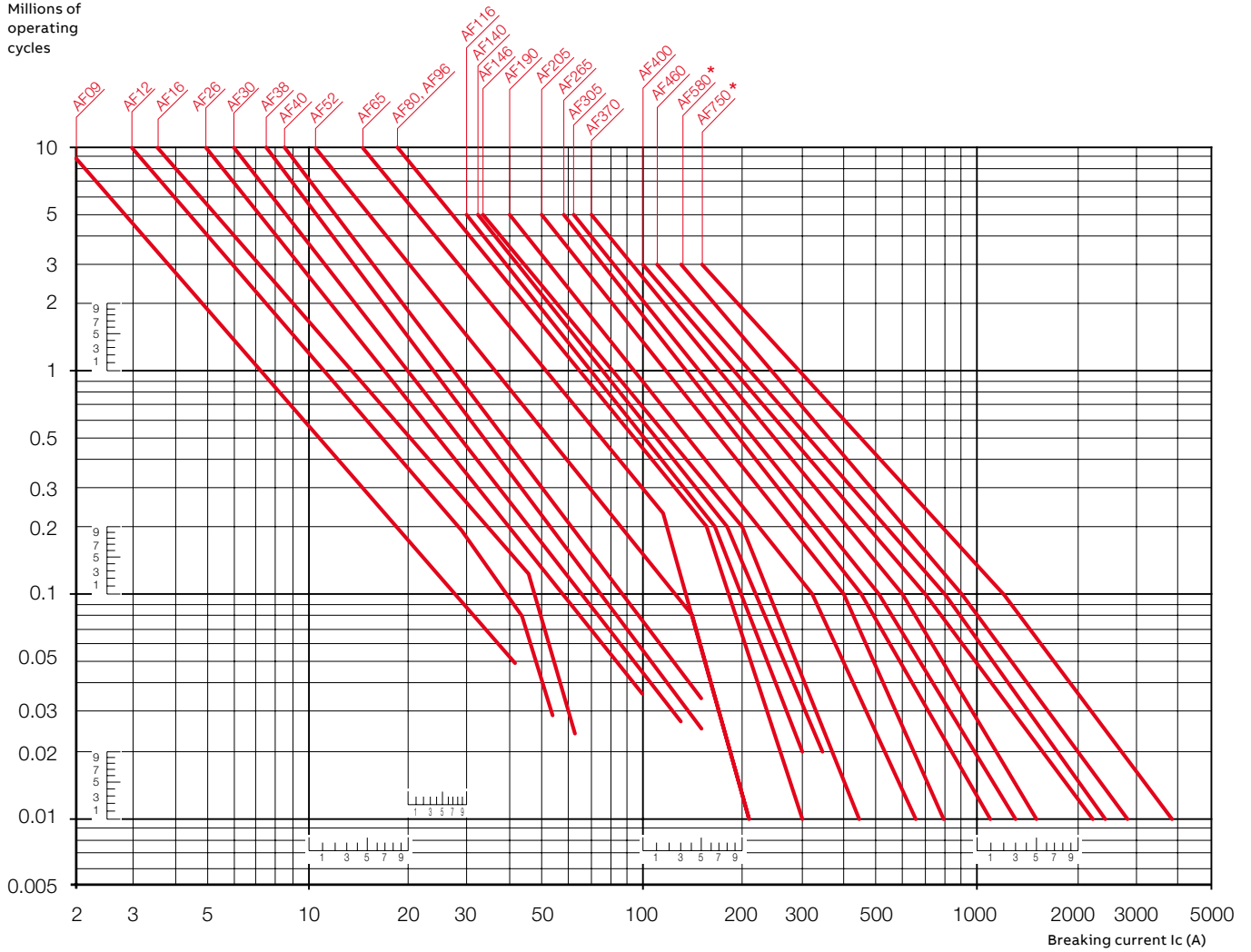

Note: \* For AF580 and AF750 contacts needs to be replaced after 750k operations.



---

# Push-in Spring motor starting solution

<b>3/83</b>	<b>Presentation</b>
<b>3/89</b>	<b>Overview</b>
	<b>Ordering details</b>
	<b>4 to 18.5 kW</b>
<b>3/90</b>	AF09..K ... AF38..K AC / DC operated
<b>3/91</b>	AF09Z..K ... AF38Z..K 24 V DC designed for PLC
<b>3/92</b>	AF09Z..K ... AF38Z..K AC / DC operated for specific applications
<b>3/93</b>	<b>Main accessories</b>
<b>3/94</b>	<b>Technical data</b>
<b>3/101</b>	<b>Electrical durability</b>
<b>3/404</b>	<b>Voltage code table</b>



For direct product details information, use product type or order code, ex:

- [www.abb.com/productdetails/AF09-30-10-13](http://www.abb.com/productdetails/AF09-30-10-13)
- or [www.abb.com/productdetails/1SBL137001R1310](http://www.abb.com/productdetails/1SBL137001R1310)





# Just push it

## Push-in Spring motor starting solution

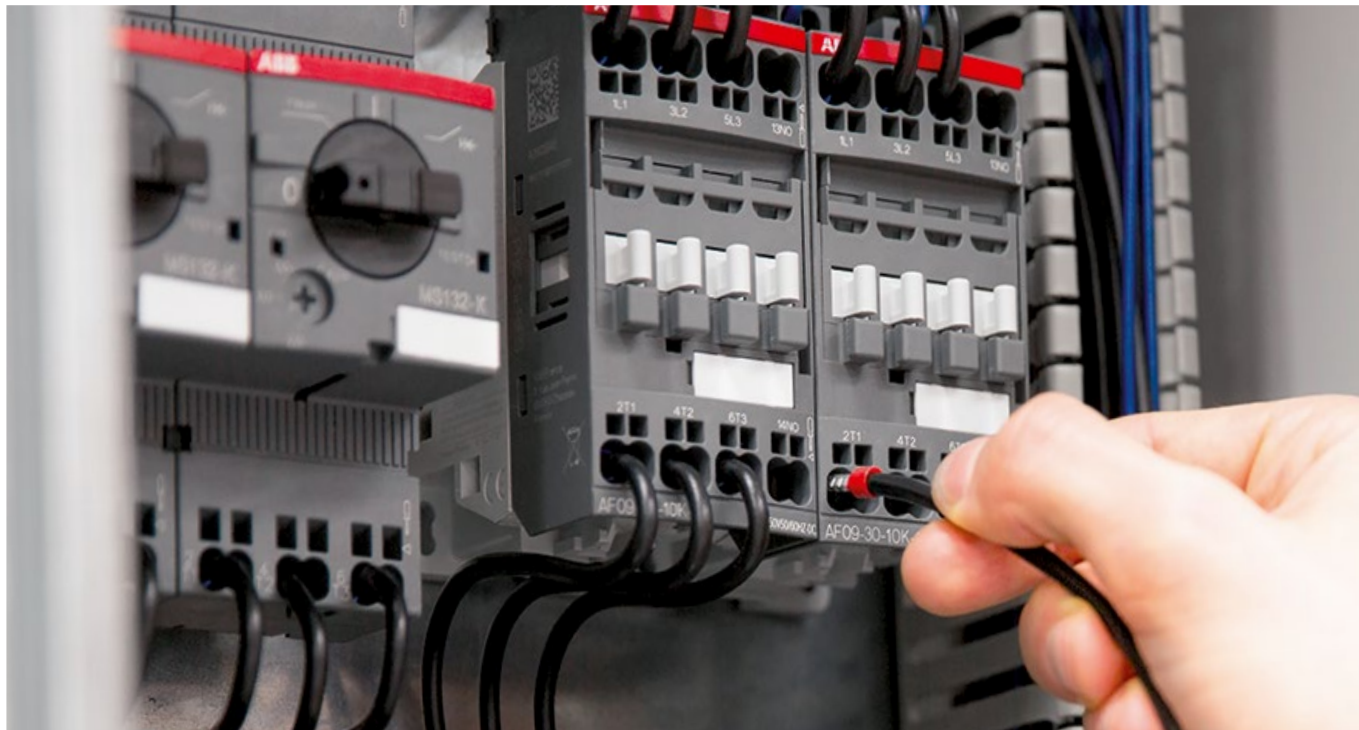

With the new Push-in Spring motor starting solution, one push is all you need for extremely fast wiring. No tool is required, so you can save up to 50% wiring time with Push-in Spring compared to conventional spring solutions. And the connections are just as reliable. So for speed, ease and reliability, just push it.



### Speed up your projects

#### Faster than ever installation

Imagine a motor starting solution that's twice as fast to install. With Push-in Spring, you no longer need to imagine – it's a reality. Push-in mode allows you to insert both ferruled and rigid cables without the need to use any tools, boosting your productivity like never before.



### Easy to install

#### Easier than ever wiring

Push-in Spring technology opens up new possibilities. With its unmatched ease of use, wiring becomes far more intuitive. This eliminates the need for special training and reduces the chance of wiring error. What possibilities will it open up for you?



### Continuous operation

#### Reliable as ever connections

The speed and ease of Push-in Spring comes with the added reassurance of connections that are as reliable as ever. This gives you complete peace of mind when using the Push-in Spring motor starting solution.

## Faster than ever installation



### 2-in-1 connection

For the very first time, ABB's 2-in-1 connection allows you to use ferruled and rigid cables (Push-in mode) or cables without ferrules (Spring mode) in the same terminal. In Push-in mode, cables can be inserted by just simply pushing them in by hand.

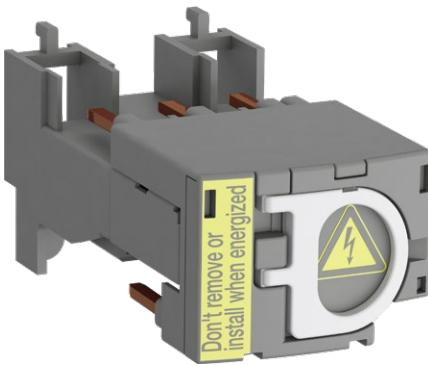

### Smart accessories

100% tool-free connecting kits significantly reduce installation time.

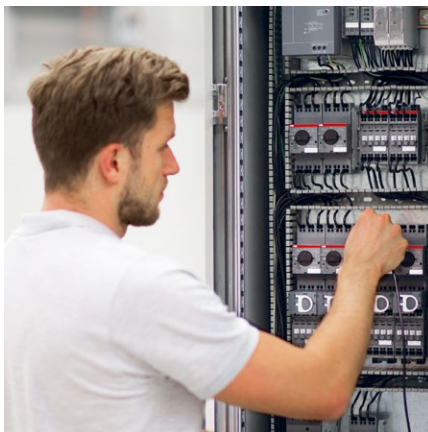

### Complete solution

High connection capacities are optimized for motor starting solutions up to 18.5 kW 400 V AC-3 and 50 A AC-1 (25 hp 480 V and 45 A general use). This includes short-circuit fuseless protection up to 100 kA. Push-in Spring accessories can be mounted on the standard screw range of manual motor starters and contactors.

## Easier than ever wiring



### Intuitive wiring

With Push-in Spring, all cables and connecting links use the same round shape entry, whilst the square terminals above are clearly marked with screwdriver symbols. The result? Wiring and de-wiring that's intuitive and easily repeatable without cabling error, with little to no training required.



### Just one screwdriver required

For de-wiring, only one screwdriver size is needed for the entire range. No twisting or turning is required either, so there's less chance of damage to the terminals and to your installation as a whole.

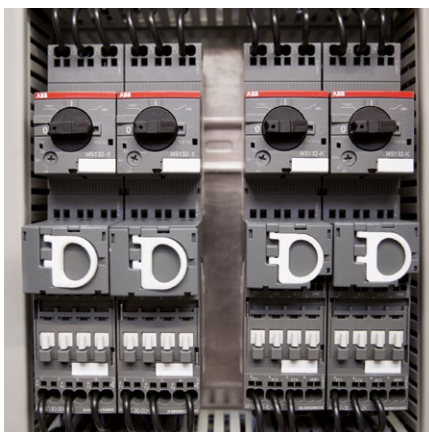

### Automated wiring

The Push-in Spring motor starting solution features 90° cable insertion for all terminals. Front access to terminals aids smooth, robust insertion of cables and makes automated robot wiring possible.



## Reliable as ever connections

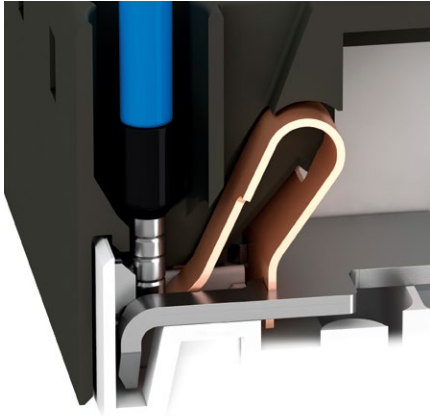

### Robust electrical contact

The special spring design guarantees excellent electrical contact. The design provides strict control of contact strength, independent from operator, giving you complete assurance.



### Vibration-proof

You can count on Push-in Spring connections, even in harsh environments. Push-in Spring technology has been shock and vibration tested according to IEC 60068-2-27 and IEC 60068-2-6 standards.



### No need to re-tighten

With self-tightening terminals, there's no need to re-tighten after transportation or during the life cycle of the product. High connection strength is guaranteed throughout the whole lifetime of the device.

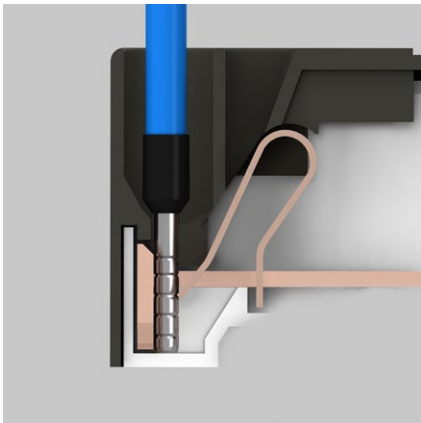

### Push-in mode

Connect rigid cables or ferruled cables simply by pushing them into the cable holes – no need to use any tools. Push-in mode saves up to 50% wiring time compared to conventional spring solutions and makes installation a breeze. Benefit from intuitive wiring, self-tightening terminals and less chance of wiring error.

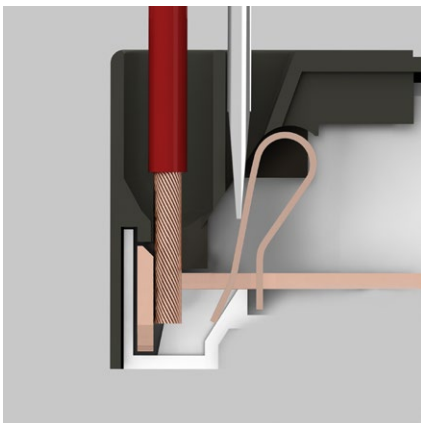

### Spring Mode

This mode is used for small cable cross-sections or for cables without ferrules. It is also used for de-wiring the solution. Before inserting the cable, simply push a screwdriver into the clearly marked holes to open the terminal. ABB's Spring mode is easier to use than conventional spring technology, with less chance of damage to terminals as no twisting or turning is required.

# Push-in Spring solution Complete range, complete efficiency

The Push-in Spring motor starting solution products provide you with a range of benefits.

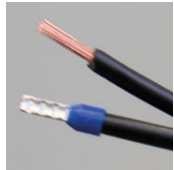

### 2-in-1

Benefit from both Push-in mode and Spring mode and use ferruled cables or cables without ferrules in the same terminal.



### Compatible with screw range

Mount accessories for control circuits on the screw range up to 30 kW AC-3 400 V on manual motor starters and up to 45 kW AC-3 400 V, 130 A AC-1 on contactors.



### Robust by design

Contact robustness by design, independent from operator.

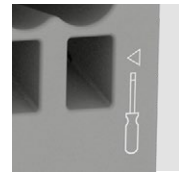
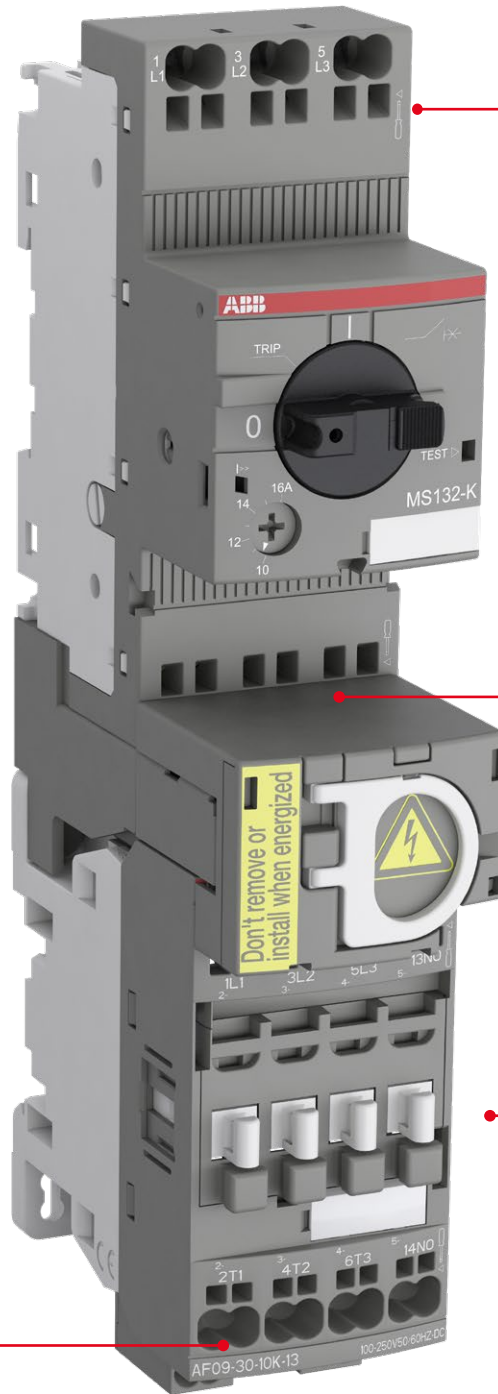

### Just one tool for everything

You only need a 3 mm screwdriver in Spring mode as well as for de-wiring the complete solution.

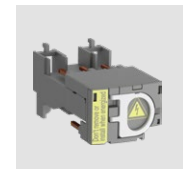

### Tool-less connecting links

100% tool-less mounting connecting links.



### Higher connecting capacity

The solution ranges up to 18.5 kW 400 V AC-3 and 50 A AC-1 (25 hp 480 V and 45 A 600 V general use).

# 3-pole contactors and motor protection



AC / DC Control supply			Type	AF09..K	AF12..K	AF16..K	AF26..K	AF30..K	AF38..K
IEC	AC-3 Rated operational power	$\theta \leq 60\text{ }^\circ\text{C}$ , 380 - 400 V	kW	4	5.5	7.5	11	15	18.5
	Rated operational current	380 - 400 V	A	9	12	18	26	32	38
	AC-1 Rated operational current	$\theta \leq 40\text{ }^\circ\text{C}$ , 690 V	A	25	28	30	45	50	50
UL/CSA	3-phase Motor Rating	440 - 480 V	hp	5	7.5	10	15	20	25
	General Use Rating	600 V	A	25	28	30	42	45	45
NEMA	NEMA size			00	0	-	1	-	-

## Main accessories for contactors

Auxiliary contact blocks		Front mounting	CA4-10K (1 N.O.) CA4-01K (1 N.C.)
		Side mounting	CAL4-11K
Interlocking units		Mechanical	VM4
		Mechanical / Electrical	VEM4K*
Surge protection			Built-in surge protection

\* For product availability, please consult your ABB local sales organization.

# AF09..K ... AF38..K 3-pole contactors - with Push-in Spring terminals

4 to 18.5 kW

AC / DC operated



AF09-30-10K



AF26-30-00K

AF09..K ... AF38..K contactors are mainly used for controlling 3-phase motors and power circuits up to 690 V AC and 220 V DC. These contactors are of the block type design with 3 main poles.

- control circuit: AC or DC operated with electronic coil interface accepting a wide control voltage range (e.g. 100...250 V AC and DC), only 4 control voltage ranges covering 24...500 V 50/60 Hz and 20...500 V DC
  - can manage large control voltage variations
  - reduced panel energy consumption
  - very distinct closing and opening
- built-in surge suppression
- add-on auxiliary contact blocks for front or side mounting and a wide range of accessories.

IEC		UL/CSA		Rated control circuit voltage		Auxiliary contacts fitted	Type (1)	Order code	Weight				
Rated operational power	operational current $\theta \leq 40^\circ\text{C}$	3-phase motor rating	General use rating	Uc min. ... Uc max.						Pkg (1 pce)			
400 V	AC-3	480 V	600 V AC	V 50/60 Hz	V DC			kg					
4	25	5	25	24 ... 60	20 ... 60	1 0	AF09-30-10K-11	1SBL137005R1110	0.285				
						0 1	AF09-30-01K-11	1SBL137005R1101	0.285				
						1 0	AF09-30-10K-12	1SBL137005R1210	0.285				
						0 1	AF09-30-01K-12	1SBL137005R1201	0.285				
						1 0	AF09-30-10K-13	1SBL137005R1310	0.285				
						0 1	AF09-30-01K-13	1SBL137005R1301	0.285				
				48 ... 130	48 ... 130	100 ... 250	100 ... 250	250 ... 500	250 ... 500	1 0	AF09-30-10K-14	1SBL137005R1410	0.325
										0 1	AF09-30-01K-14	1SBL137005R1401	0.325
										1 0	AF12-30-10K-11	1SBL157005R1110	0.285
										0 1	AF12-30-01K-11	1SBL157005R1101	0.285
										1 0	AF12-30-10K-12	1SBL157005R1210	0.285
										0 1	AF12-30-01K-12	1SBL157005R1201	0.285
5.5	28	7.5	28	24 ... 60	20 ... 60	1 0	AF12-30-10K-13	1SBL157005R1310	0.285				
						0 1	AF12-30-01K-13	1SBL157005R1301	0.285				
						1 0	AF12-30-10K-14	1SBL157005R1410	0.325				
						0 1	AF12-30-01K-14	1SBL157005R1401	0.325				
						1 0	AF16-30-10K-11	1SBL177005R1110	0.285				
						0 1	AF16-30-01K-11	1SBL177005R1101	0.285				
				48 ... 130	48 ... 130	100 ... 250	100 ... 250	250 ... 500	250 ... 500	1 0	AF16-30-10K-12	1SBL177005R1210	0.285
										0 1	AF16-30-01K-12	1SBL177005R1201	0.285
										1 0	AF16-30-10K-13	1SBL177005R1310	0.285
										0 1	AF16-30-01K-13	1SBL177005R1301	0.285
										1 0	AF16-30-10K-14	1SBL177005R1410	0.325
										0 1	AF16-30-01K-14	1SBL177005R1401	0.325
7.5	30	10	30	24 ... 60	20 ... 60	1 0	AF16-30-10K-11	1SBL177005R1110	0.285				
						0 1	AF16-30-01K-11	1SBL177005R1101	0.285				
						1 0	AF16-30-10K-12	1SBL177005R1210	0.285				
						0 1	AF16-30-01K-12	1SBL177005R1201	0.285				
						1 0	AF16-30-10K-13	1SBL177005R1310	0.285				
						0 1	AF16-30-01K-13	1SBL177005R1301	0.285				
				48 ... 130	48 ... 130	100 ... 250	100 ... 250	250 ... 500	250 ... 500	1 0	AF16-30-10K-14	1SBL177005R1410	0.325
										0 1	AF16-30-01K-14	1SBL177005R1401	0.325
										0 0	AF26-30-00K-11	1SBL237005R1100	0.325
										0 0	AF26-30-00K-12	1SBL237005R1200	0.325
										0 0	AF26-30-00K-13	1SBL237005R1300	0.325
										0 0	AF26-30-00K-14	1SBL237005R1400	0.365
15	50	20	45	24 ... 60	20 ... 60	0 0	AF30-30-00K-11	1SBL277005R1100	0.330				
						0 0	AF30-30-00K-12	1SBL277005R1200	0.330				
						0 0	AF30-30-00K-13	1SBL277005R1300	0.330				
						0 0	AF30-30-00K-14	1SBL277005R1400	0.370				
						0 0	AF38-30-00K-11	1SBL297005R1100	0.330				
						0 0	AF38-30-00K-12	1SBL297005R1200	0.330				
				48 ... 130	48 ... 130	100 ... 250	100 ... 250	250 ... 500	250 ... 500	0 0	AF38-30-00K-13	1SBL297005R1300	0.330
										0 0	AF38-30-00K-14	1SBL297005R1400	0.370
										0 0	AF38-30-00K-11	1SBL297005R1100	0.330
										0 0	AF38-30-00K-12	1SBL297005R1200	0.330
										0 0	AF38-30-00K-13	1SBL297005R1300	0.330
										0 0	AF38-30-00K-14	1SBL297005R1400	0.370

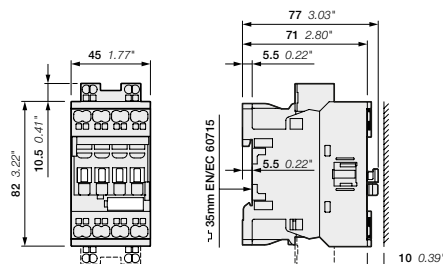

AF09..K, AF12..K, AF16..K

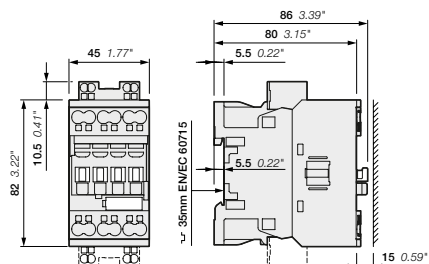

AF26..K, AF30..K, AF38..K

Main dimensions mm, inches

1SBC10042850201

# AF09Z..K ... AF38Z..K 3-pole contactors - with Push-in Spring terminals

4 to 18.5 kW

24 V DC operated - designed for PLC



AF09Z-30-10K

1SBC101997V0014



AF26Z-30-00K

1SBC101999V0014

AF09Z..K ... AF38Z..K contactors are mainly used for controlling 3-phase motors and power circuits up to 690 V AC and 220 V DC. These contactors are of the block type design with 3 main poles.

- control circuit: DC operated with electronic coil interface allowing low holding consumption up to 1.7 W and reduced panel energy consumption
  - allow direct control by PLC-output  $\geq 250$  mA 24 V DC
  - very distinct closing and opening
- built-in surge suppression
- add-on auxiliary contact blocks for front or side mounting and a wide range of accessories.

IEC	UL/CSA		Rated control circuit voltage Uc min. ... Uc max.	Auxiliary contacts fitted	Type	Order code	Weight	
	Rated operational power	3-phase motor rating						General use rating
400 V AC-3	current $\theta \leq 40$ °C	480 V	600 V AC				kg	
kW	A	hp	A	V DC				
4	25	5	25	24	1 0	AF09Z-30-10K-30	1SBL136005R3010	0.435
					0 1	AF09Z-30-01K-30	1SBL136005R3001	0.435
5.5	28	7.5	28	24	1 0	AF12Z-30-10K-30	1SBL156005R3010	0.435
					0 1	AF12Z-30-01K-30	1SBL156005R3001	0.435
7.5	30	10	30	24	1 0	AF16Z-30-10K-30	1SBL176005R3010	0.435
					0 1	AF16Z-30-01K-30	1SBL176005R3001	0.435
11	45	15	42	24	0 0	AF26Z-30-00K-30	1SBL236005R3000	0.440
15	50	20	45	24	0 0	AF30Z-30-00K-30	1SBL276005R3000	0.440
18.5	50	25	45	24	0 0	AF38Z-30-00K-30	1SBL296005R3000	0.440

Note: AF..Z contactors with 24V DC control voltage need to respect the connection polarities indicated close to the coil terminals: A1+ for the positive pole and A2- for the negative pole.

For product availability, please consult your ABB local sales organization.

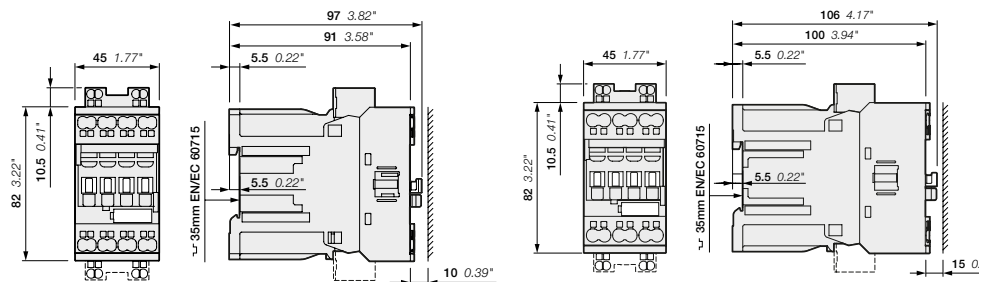

AF09Z..K, AF12Z..K, AF16Z..K

AF26Z..K, AF30Z..K, AF38Z..K

Main dimensions mm, inches

1SBC10049850201



# AF09Z..K ... AF38Z..K 3-pole contactors - with Push-in Spring terminals

4 to 18.5 kW

AC / DC operated - for specific applications



AF09Z-30-10K



AF26Z-30-00K

AF09Z..K ... AF38Z..K contactors are mainly used for controlling 3-phase motors and power circuits up to 690 V AC and 220 V DC. These contactors are of the block type design with 3 main poles.

- control circuit: AC or DC operated with electronic coil interface accepting a wide control voltage range (e.g. 100...250 V AC and DC), only 4 control voltage ranges covering 24...250 V 50/60 Hz and 12...250 V DC
  - can manage large control voltage variations
  - allow direct control by PLC-output  $\geq 24$  V DC 500 mA
  - reduced panel energy consumption
  - very distinct closing and opening
  - can withstand short voltage dips and voltage sags (SEMI F47-0706 conditions of use on request)
- built-in surge suppression
- add-on auxiliary contact blocks for front or side mounting and a wide range of accessories.

IEC		UL/CSA		Rated control circuit voltage		Auxiliary contacts fitted	Type	Order code	Weight
Rated operational power	current $\theta \leq 40^\circ\text{C}$	3-phase motor rating	General use rating	Uc min. ... Uc max.					
400 V	AC-3	480 V	600 V AC	V 50/60 Hz	V DC				kg
4	25	5	25	-	12 ... 20	1 0	AF09Z-30-10K-20	1SBL136005R2010	0.315
						0 1	AF09Z-30-01K-20	1SBL136005R2001	0.315
						1 0	AF09Z-30-10K-21	1SBL136005R2110	0.315
						0 1	AF09Z-30-01K-21	1SBL136005R2101	0.315
						1 0	AF09Z-30-10K-22	1SBL136005R2210	0.315
						0 1	AF09Z-30-01K-22	1SBL136005R2201	0.315
						1 0	AF09Z-30-10K-23	1SBL136005R2310	0.315
						0 1	AF09Z-30-01K-23	1SBL136005R2301	0.315
						1 0	AF12Z-30-10K-20	1SBL156005R2010	0.315
						0 1	AF12Z-30-01K-20	1SBL156005R2001	0.315
						1 0	AF12Z-30-10K-21	1SBL156005R2110	0.315
						0 1	AF12Z-30-01K-21	1SBL156005R2101	0.315
5.5	28	7.5	28	-	12 ... 20	1 0	AF12Z-30-10K-20	1SBL156005R2010	0.315
						0 1	AF12Z-30-01K-20	1SBL156005R2001	0.315
						1 0	AF12Z-30-10K-21	1SBL156005R2110	0.315
						0 1	AF12Z-30-01K-21	1SBL156005R2101	0.315
						1 0	AF12Z-30-10K-22	1SBL156005R2210	0.315
						0 1	AF12Z-30-01K-22	1SBL156005R2201	0.315
						1 0	AF12Z-30-10K-23	1SBL156005R2310	0.315
						0 1	AF12Z-30-01K-23	1SBL156005R2301	0.315
						1 0	AF16Z-30-10K-20	1SBL176005R2010	0.315
						0 1	AF16Z-30-01K-20	1SBL176005R2001	0.315
						1 0	AF16Z-30-10K-21	1SBL176005R2110	0.315
						0 1	AF16Z-30-01K-21	1SBL176005R2101	0.315
7.5	30	10	30	-	12 ... 20	1 0	AF16Z-30-10K-20	1SBL176005R2010	0.315
						0 1	AF16Z-30-01K-20	1SBL176005R2001	0.315
						1 0	AF16Z-30-10K-21	1SBL176005R2110	0.315
						0 1	AF16Z-30-01K-21	1SBL176005R2101	0.315
						1 0	AF16Z-30-10K-22	1SBL176005R2210	0.315
						0 1	AF16Z-30-01K-22	1SBL176005R2201	0.315
						1 0	AF16Z-30-10K-23	1SBL176005R2310	0.315
						0 1	AF16Z-30-01K-23	1SBL176005R2301	0.315
						0 0	AF26Z-30-00K-20	1SBL236005R2000	0.355
						0 0	AF26Z-30-00K-21	1SBL236005R2100	0.355
						0 0	AF26Z-30-00K-22	1SBL236005R2200	0.355
						0 0	AF26Z-30-00K-23	1SBL236005R2300	0.355
15	50	20	45	-	12 ... 20	0 0	AF30Z-30-00K-20	1SBL276005R2000	0.360
						0 0	AF30Z-30-00K-21	1SBL276005R2100	0.360
						0 0	AF30Z-30-00K-22	1SBL276005R2200	0.360
						0 0	AF30Z-30-00K-23	1SBL276005R2300	0.360
						0 0	AF38Z-30-00K-20	1SBL296005R2000	0.360
						0 0	AF38Z-30-00K-21	1SBL296005R2100	0.360
18.5	50	25	45	-	12 ... 20	0 0	AF38Z-30-00K-20	1SBL296005R2000	0.360
						0 0	AF38Z-30-00K-21	1SBL296005R2100	0.360
						0 0	AF38Z-30-00K-22	1SBL296005R2200	0.360
						0 0	AF38Z-30-00K-23	1SBL296005R2300	0.360
						0 0	AF38Z-30-00K-20	1SBL296005R2000	0.360
						0 0	AF38Z-30-00K-21	1SBL296005R2100	0.360

Note: Only AF..Z contactors with 12...20 V DC control voltage need to respect the connection polarities indicated close to the coil terminals: A1+ for the positive pole and A2- for the negative pole.

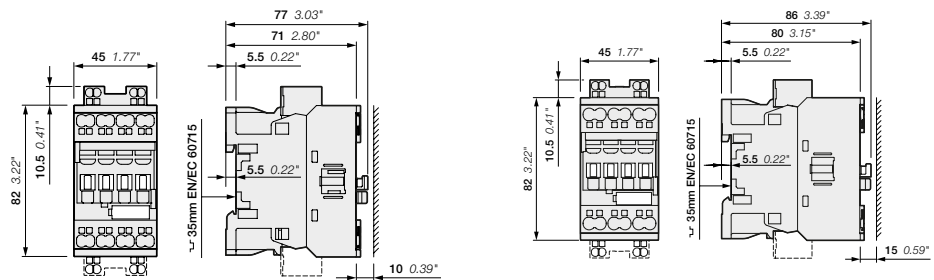

AF09Z..K, AF12Z..K, AF16Z..K

AF26Z..K, AF30Z..K, AF38Z..K

Main dimensions mm, inches

# AF09..K ... AF38..K 3-pole contactors - with Push-in Spring terminals

## Main accessories

### Contactor and main accessories (other accessories available)

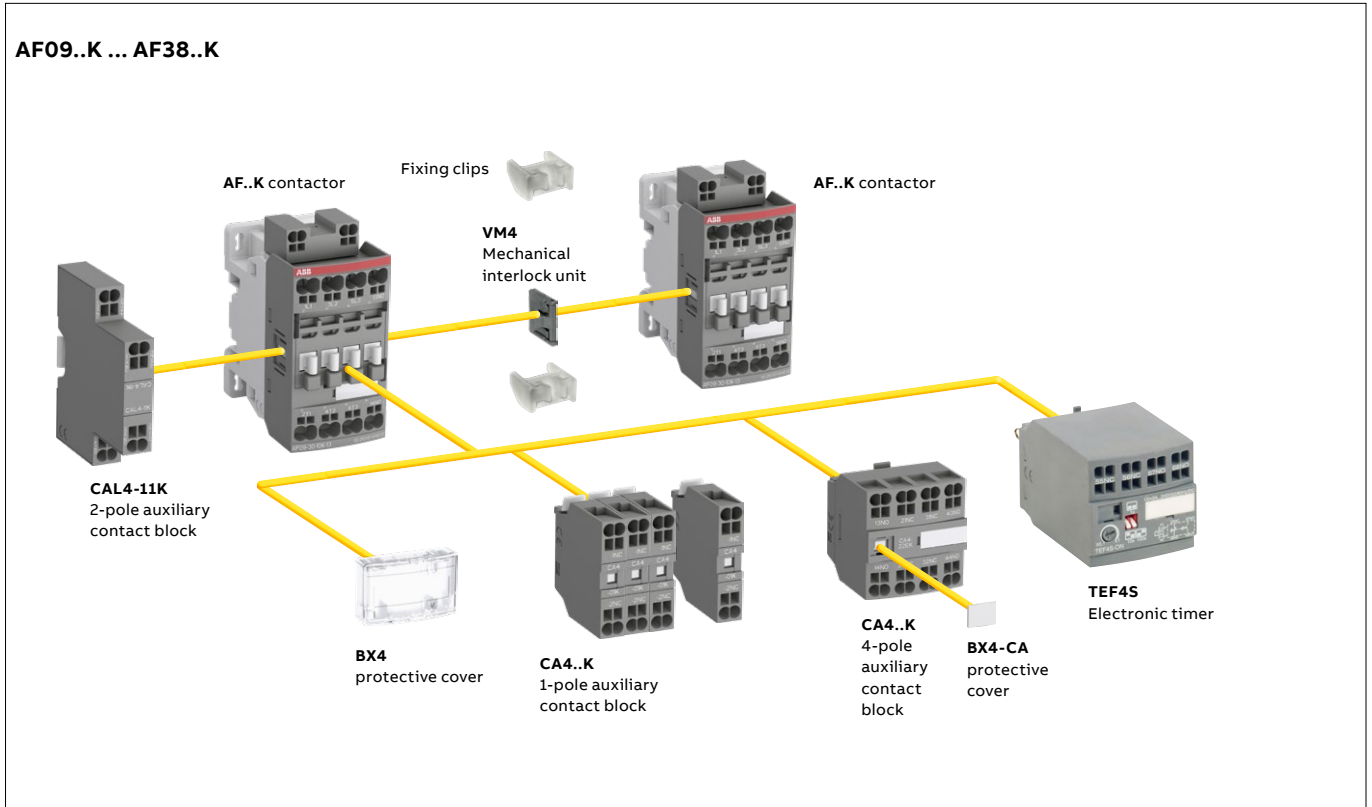

### Main accessory fitting details - for ordering details, technical data and other accessories: see section accessories

Many configurations of accessories are possible depending on whether these are front-mounted or side-mounted.

Contactor types	Main poles	Built-in auxiliary contacts	Front-mounted accessories			Side-mounted accessories		
			Auxiliary contact blocks		Electronic timer	Mechanical interlock unit (between 2 contactors)	Auxiliary contact blocks	
			1-pole CA4..K	4-pole CA4..K	TEF4S	VM4	Left side	Right side
<b>AF09(Z)..K ... AF38(Z)..K (1)</b>								
AF09..K ... AF16..K	3 0	0 1	4 max.	or 1	or 1	-	+	1
AF09..K ... AF16..K	3 0	1 0	2 max.	-	or 1	-	+	1
AF26..K ... AF38..K	3 0	0 0	4 max.	or 1	or 1	+1	+	1
<b>AF09Z..K ... AF38Z..K 24 V DC designed for PLC - coil 30 (1)</b>								
AF09Z..K ... AF16Z..K	3 0	0 1	4 max.	or 1	or 1	+1	or	1
AF09Z..K ... AF16Z..K	3 0	1 0	2 max.	-	or 1	+1	+	1
AF26Z..K ... AF38Z..K	3 0	0 0			1	-	+	1

(1) Including add-on and built-in contacts: 4 N.C. auxiliary contacts max. on positions 1, 2, 3, 4 and 3 N.C. auxiliary contacts max. on positions 1 ±30°, 5

# AF09..K ... AF38..K 3-pole contactors - with Push-in Spring terminals

## Technical data

### Main pole - Utilization characteristics according to IEC

Contactor types	AC / DC operated	AF09..K	AF12..K	AF16..K	AF26..K	AF30..K	AF38..K
Standards		IEC 60947-1 / 60947-4-1 and EN 60947-1 / 60947-4-1					
Rated operational voltage Ue max.		690 V					
Rated frequency (without derating)		50 / 60 Hz					
Conventional free-air thermal current Ith acc. to IEC 60947-4-1, open contactors, $\theta \leq 40^\circ\text{C}$		35 A	35 A	35 A	50 A	50 A	50 A
With conductor cross-sectional area		6 mm <sup>2</sup>	6 mm <sup>2</sup>	6 mm <sup>2</sup>	10 mm <sup>2</sup>	10 mm <sup>2</sup>	10 mm <sup>2</sup>
AC-1 Utilization category							
For air temperature close to contactor							
le / Rated operational current AC-1	$\theta \leq 40^\circ\text{C}$	25 A	28 A	30 A	45 A	50 A	50 A
Ue max. $\leq 690\text{ V}$ , 50/60 Hz	$\theta \leq 60^\circ\text{C}$	25 A	28 A	30 A	40 A	42 A	42 A
	$\theta \leq 70^\circ\text{C}$	22 A	24 A	26 A	32 A	37 A	37 A
With conductor cross-sectional area		4 mm <sup>2</sup>	6 mm <sup>2</sup>	6 mm <sup>2</sup>	10 mm <sup>2</sup>	10 mm <sup>2</sup>	10 mm <sup>2</sup>
AC-3 Utilization category							
For air temperature close to contactor $\theta \leq 60^\circ\text{C}$							
le / Max. rated operational current AC-3 (1)							
	220-230-240 V	9 A	12 A	18 A	26 A	33 A	40 A
	380-400 V	9 A	12 A	18 A	26 A	32 A	38 A
	415 V	9 A	12 A	18 A	26 A	32 A	38 A
	440 V	9 A	12 A	18 A	26 A	32 A	38 A
	500 V	9.5 A	12.5 A	15 A	23 A	28 A	33 A
	690 V	7 A	9 A	10.5 A	17 A	21 A	24 A
	1000 V	-					
Rated operational power AC-3 (1)							
	220-230-240 V	2.2 kW	3 kW	4 kW	6.5 kW	9 kW	11 kW
	380-400 V	4 kW	5.5 kW	7.5 kW	11 kW	15 kW	18.5 kW
	415 V	4 kW	5.5 kW	9 kW	11 kW	15 kW	18.5 kW
	440 V	4 kW	5.5 kW	9 kW	15 kW	18.5 kW	22 kW
	500 V	5.5 kW	7.5 kW	9 kW	15 kW	18.5 kW	22 kW
	690 V	5.5 kW	7.5 kW	9 kW	15 kW	18.5 kW	22 kW
	1000 V	-					
Rated making capacity AC-3		10 x Ie AC-3 acc. to IEC 60947-4-1					
Rated breaking capacity AC-3		8 x Ie AC-3 acc. to IEC 60947-4-1					
AC-8a Utilization category (without thermal overload relay Ue 400 V 50/60 Hz $\theta \leq 40^\circ\text{C}$ )							
le / Rated operational current AC-8a		12 A	16 A	22 A	30 A	40 A	50 A
Rated operational power AC-8a		5.5 kW	7.5 kW	11 kW	15 kW	20 kW	25 kW
Short-circuit protection device for contactors without thermal overload relay in free air Motor protection excluded (2)							
Ue $\leq 500\text{ V AC}$ - gG type fuse		25 A	32 A	32 A	50 A	63 A	63 A
Rated short-time withstand current Icw at 40 °C ambient temperature, in free air from a cold state	1 s	300 A	300 A	300 A	700 A	700 A	700 A
	10 s	150 A	150 A	150 A	350 A	350 A	350 A
	30 s	80 A	80 A	80 A	225 A	225 A	225 A
	1 min	60 A	60 A	60 A	150 A	150 A	150 A
	15 min	35 A	35 A	35 A	50 A	50 A	50 A
Maximum breaking capacity cos $\phi = 0.45$							
	at 440 V	250 A	250 A	250 A	500 A	500 A	500 A
	at 690 V	106 A	106 A	106 A	200 A	200 A	200 A
Power dissipation per pole	le / AC-1	1.14 W	1.43 W	1.64 W	2 W	2.44 W	2.44 W
	le / AC-3	0.15 W	0.26 W	0.6 W	0.66 W	1 W	1.41 W
Max. electrical switching frequency	AC-1	600 cycles/h					
	AC-3	1200 cycles/h					
	AC-2, AC-4	300 cycles/h				150 cycles/h	

(1) For the corresponding kW/A or hp/A values of 1500 r.p.m, 50 Hz or 1800 r.p.m, 60 Hz, 3-phase motors, see "Motor rated operational powers and currents".

(2) For the protection of motor starters against short circuits, see "Coordination with short-circuit protection devices".

# AF09..K ... AF38..K 3-pole contactors - with Push-in Spring terminals

## Technical data

### Main pole - Utilization characteristics according to UL / NEMA / CSA

Contactor types	AC / DC operated	AF09..K	AF12..K	AF16..K	AF26..K	AF30..K	AF38..K
Standards		UL 60947-4-1, CSA-C22.2 No. 60947-4-1					
Maximum operational voltage		600 V					
NEMA size		00	0	-	1	-	-
NEMA continuous amp rating	Thermal current	9 A	18 A		27 A		
NEMA maximum horse power ratings	115 V AC	1/3 hp	1 hp		2 hp		
1-phase, 60 Hz	230 V AC	1 hp	2 hp		3 hp		
NEMA maximum horse power ratings	200 V AC	1-1/2 hp	3 hp		7-1/2 hp		
3-phase, 60 Hz	230 V AC	1-1/2 hp	3 hp		7-1/2 hp		
	460 V AC	2 hp	5 hp		10 hp		
	575 V AC	2 hp	5 hp		10 hp		
UL / CSA general use rating							
600 V AC		25 A	28 A	30 A	42 A	45 A	45 A
With conductor cross-sectional area		AWG 10	AWG 10	AWG 10	AWG 8	AWG 8	AWG 8
1 pole	80 V DC	25 A	28 A	30 A	42 A	45 A	45 A
2 poles in serie	160 V DC	25 A	28 A	30 A	42 A	45 A	45 A
3 poles in serie	240 V DC	25 A	28 A	30 A	42 A	45 A	45 A
With conductor cross-sectional area		AWG 10	AWG 10	AWG 10	AWG 8	AWG 8	AWG 8
UL / CSA maximum 1-phase motor rating							
Full load current	120 V AC	13.8 A	16 A	20 A	24 A	24 A	24 A
	240 V AC	10 A	12 A	17 A	17 A	28 A	28 A
Horse power rating	120 V AC	3/4 hp	1 hp	1-1/2 hp	2 hp	2 hp	2 hp
	240 V AC	1-1/2 hp	2 hp	3 hp	3 hp	5 hp	5 hp
UL / CSA maximum 3-phase motor rating							
Full load current (1)	200-208 V AC	7.8 A	11 A	17.5 A	25.3 A	32.2 A	32.2 A
	220-240 V AC	6.8 A	9.6 A	15.2 A	22 A	28 A	28 A
	440-480 V AC	7.6 A	11 A	14 A	21 A	27 A	34 A
	550-600 V AC	9 A	11 A	17 A	22 A	27 A	32 A
Horse power rating (1)	200-208 V AC	2 hp	3 hp	5 hp	7-1/2 hp	10 hp	10 hp
	220-240 V AC	2 hp	3 hp	5 hp	7-1/2 hp	10 hp	10 hp
	440-480 V AC	5 hp	7-1/2 hp	10 hp	15 hp	20 hp	25 hp
	550-600 V AC	7-1/2 hp	10 hp	15 hp	20 hp	25 hp	30 hp
UL / CSA - DC motor starting - 3 poles in series							
Full Load Amps (FLA)	125 V DC	9.5 A	13.2 A	17 A	25 A	25 A	25 A
	250 V DC	8.5 A	12.2 A	12.2 A	20 A	29 A	29 A
Horse power rating	125 V DC	1 hp	1-1/2 hp	2 hp	3 hp	3 hp	3 hp
	250 V DC	2 hp	3 hp	3 hp	5 hp	7-1/2 hp	7-1/2 hp
Short-circuit protection device for contactors without thermal overload relay							
Motor protection excluded							
Fuse rating		30 A		60 A		100 A	
Fuse type, 600 V		RK5					
Maximum electrical switching frequency							
For general use		600 cycles/h					
For motor use		1200 cycles/h					

(1) For the corresponding kW/A or hp/A values of 1500 r.p.m, 50 Hz or 1800 r.p.m, 60 Hz, 3-phase motors, see "Motor rated operational powers and currents".

## AF09..K ... AF38..K 3-pole contactors - with Push-in Spring terminals

### Technical data

#### Main pole - Utilization characteristics - 3 N.O. non reversing contactors

Contactors types	AC / DC operated	AF09..K	AF12..K	AF16..K	AF26..K	AF30..K	AF38..K
AC Resistance air heating							
Full Load Amps (FLA)	600 V AC	20 A	25 A	30 A	42 A	45 A	45 A
Elevator control, load switching, 500,000 electrical operating cycles acc. to CSA B44.1 / ASME 17.5 paragraph 19.2.1							
1-phase							
Horse power rating	110-120 V AC	1/4 hp	1/3 hp	–	1-1/2 hp	2 hp	2 hp
	220-240 V AC	1/2 hp	3/4 hp	–	3 hp	3 hp	5 hp
3-phase							
Horse power rating	200-208 V AC	1 hp	2 hp	–	5 hp	7-1/2 hp	7-1/2 hp
	220-240 V AC	1 hp	2 hp	–	5 hp	7-1/2 hp	10 hp
	440-480 V AC	3 hp	5 hp	–	15 hp	20 hp	20 hp
	550-600 V AC	3 hp	5 hp	–	15 hp	20 hp	20 hp
Elevator control, 500,000 mechanical operating cycles, 5 electrical operating cycles acc. to CSA B44.1 / ASME 17.5 paragraph 19.2.2							
1-phase							
Horse power rating	110-120 V AC	3/4 hp	1 hp	1-1/2 hp	2 hp	2 hp	3 hp
	220-240 V AC	1-1/2 hp	2 hp	3 hp	3 hp	5 hp	7-1/2 hp
3-phase							
Horse power rating	200-208 V AC	2 hp	3 hp	5 hp	7-1/2 hp	10 hp	10 hp
	220-240 V AC	2 hp	3 hp	5 hp	7-1/2 hp	10 hp	10 hp
	440-480 V AC	5 hp	7-1/2 hp	10 hp	15 hp	20 hp	25 hp
	550-600 V AC	7-1/2 hp	10 hp	15 hp	20 hp	25 hp	30 hp
Lighting application - UL/CSA							
Tungsten lamps							
1-phase per pole	347 V AC	20 A	25 A	30 A	42 A	45 A	45 A
3-phase break all lines	600 V AC	20 A	25 A	30 A	42 A	45 A	45 A
Electrical discharge lamps (ballast)							
1-phase per pole	347 V AC	20 A	25 A	30 A	42 A	45 A	45 A
3-phase break all lines	600 V AC	20 A	25 A	30 A	42 A	45 A	45 A

# AF09..K ... AF38..K 3-pole contactors - with Push-in Spring terminals

## Technical data

### General technical data

Contactor types	AC / DC operated	AF09..K	AF12..K	AF16..K	AF26..K	AF30..K	AF38..K
Rated insulation voltage Ui		690 V					
acc. to IEC 60947-4-1		600 V					
acc. to UL / CSA		6 kV					
Rated impulse withstand voltage Uimp.		6 kV					
Electromagnetic compatibility		Devices complying with IEC 60947-1 / EN 60947-1 - Environment A and B (1)					
Ambient air temperature close to contactor		-40 ... +70 °C					
Operation Without thermal overload relay		-60 ... +80 °C					
Storage		Category B according to IEC 60947-1 Annex Q					
Climatic withstand		3000 m					
Maximum operating altitude (without derating)		10 million operating cycles					
Mechanical durability		3600 cycles/h					
Number of operating cycles		5 ... 300 Hz					
Maximum switching frequency		4 g Closed position / 2 g Open position					
Shock withstand		1/2 sinusoidal shock for 11 ms: no change in contact position, closed or open position					
acc. to IEC 60068-2-27 and EN 60068-2-27		A 30 g					
Mounting position 1	Shock direction	B1 25 g closed position / 5 g open position					
		B2 15 g					
		C1 25 g					
		C2 25 g					
Vibration withstand		5 ... 300 Hz					
acc. to IEC 60068-2-6		4 g Closed position / 2 g Open position					

(1) AF09 ... AF38-...-12 (48...130 V 50/60 Hz-DC) compliant to environment A only. For environment B: select AF09 ... AF38Z-...-22.

### Mounting characteristics and conditions for use

Contactor types	AC / DC operated	AF09..K	AF12..K	AF16..K	AF26..K	AF30..K	AF38..K
Mounting positions		<p>Max. N.C. built-in and add-on N.C. auxiliary contacts: see accessory fitting details for a 3-pole contactor AF09 ... AF38</p>					
Mounting distances		The contactors can be assembled side by side					
Fixing		35 x 7.5 mm or 35 x 15 mm					
On rail according to IEC 60715, EN 60715		2 x M4 screws placed diagonally					
By screws (not supplied)							



## AF09..K ... AF38..K 3-pole contactors - with Push-in Spring terminals

### Technical data

#### Magnet System Characteristics for AF09..K ... AF38..K contactors - AC / DC operated

Contactor types	AC / DC operated	AF09..K	AF12..K	AF16..K	AF26..K	AF30..K	AF38..K
Coil operating limits acc. to IEC 60947-4-1	AC supply	At $\theta \leq 60^\circ\text{C}$ $0.85 \times U_c \text{ min} \dots 1.1 \times U_c \text{ max}$ .					
	DC supply	At $\theta \leq 60^\circ\text{C}$ $0.85 \times U_c \text{ min} \dots U_c \text{ max}$ .					
AC control voltage 50/60 Hz		At $\theta \leq 70^\circ\text{C}$ $0.85 \times U_c \text{ min} \dots U_c \text{ max}$ .					
Rated control circuit voltage $U_c$		24 ... 500 V AC					
Coil consumption	Average pull-in value	50 VA					
	Average holding value	2.2 VA / 2 W					
DC control voltage		20 ... 500 V DC					
Rated control circuit voltage $U_c$		20 ... 500 V DC					
Coil consumption	Average pull-in value	50 W					
	Average holding value	2 W					
PLC-output control		Not suitable for direct control by PLC-output					
Drop-out voltage		$\leq 60\%$ $U_c \text{ min}$ .					
Operating time							
Between coil energization and:							
	N.O. contact closing	40 ... 95 ms					
	N.C. contact opening	38 ... 90 ms					
Between coil de-energization and:							
	N.O. contact opening	11 ... 95 ms					
	N.C. contact closing	13 ... 98 ms					

#### Magnet System Characteristics for AF09Z..K ... AF38Z..K contactors 24V DC operated - designed for PLC - coil 30

Contactor types	AC / DC operated	AF09Z..K	AF12Z..K	AF16Z..K	AF26Z..K	AF30Z..K	AF38Z..K
Coil operating limits acc. to IEC 60947-4-1	DC supply	At $\theta \leq 60^\circ\text{C}$ $0.85 \dots 1.1 \times U_c$					
		At $\theta \leq 70^\circ\text{C}$ $U_c$					
DC control voltage		24 V DC					
Coil consumption	Average pull-in value	6 W					
	Average holding value	1.7 W					
PLC-output control		$\geq 250 \text{ mA}$ 24 V DC for PLCs and safety PLCs using broken wire detection					
Drop-out voltage		$\leq 60\%$ of $U_c \text{ min}$ .					
Operating time							
Between coil energization and:							
	N.O. contact closing	27 ... 53 ms					
	N.C. contact opening	20 ... 35 ms					
Between coil de-energization and:							
	N.O. contact opening	17 ... 29 ms					
	N.C. contact closing	22 ... 57 ms					

















#### Magnet System Characteristics for AF09Z..K ... AF38Z..K contactors - for specific applications - coils 20, 21, 22, 23

Contactor types	AC / DC operated	AF09Z..K	AF12Z..K	AF16Z..K	AF26Z..K	AF30Z..K	AF38Z..K
Coil operating limits acc. to IEC 60947-4-1	AC supply	At $\theta \leq 60^\circ\text{C}$ $0.85 \times U_c \text{ min} \dots 1.1 \times U_c \text{ max}$					
	DC supply	At $\theta \leq 70^\circ\text{C}$ $0.85 \times U_c \text{ min} \dots 1.1 \times U_c \text{ max}$					
AC control voltage 50/60 Hz		24 ... 250 V AC					
Coil consumption	Average pull-in value	16 VA					
	Average holding value	1.7 VA / 1.5 W					
DC control voltage		12 ... 250 V DC					
Rated control circuit voltage $U_c$		12 ... 250 V DC					
Coil consumption	Average pull-in value	12 ... 16 W					
	Average holding value	1.7 W					
PLC-output control		(AF..Z coil 21) $\geq 500 \text{ mA}$ 24 V DC for PLCs					
Drop-out voltage		$\leq 60\%$ of $U_c \text{ min}$ .					
Voltage sag immunity acc. to SEMI F47-0706		(AF..Z coil 21, 22, 23) conditions of use on request					
Dips withstand $-20^\circ\text{C} \leq \theta \leq +60^\circ\text{C}$		(AF..Z coil 21, 22, 23) 20 ms average for $U_c \geq 24 \text{ V}$ 50/60 Hz or $U_c \geq 20 \text{ V}$ DC					
Operating time							
Between coil energization and:							
	N.O. contact closing	40 ... 95 ms					
	N.C. contact opening	38 ... 90 ms					
Between coil de-energization and:							
	N.O. contact opening	11 ... 95 ms					
	N.C. contact closing	13 ... 98 ms					

# AF09..K ... AF38..K 3-pole contactors - with Push-in Spring terminals

## Technical data

### Connecting characteristics

Contactor types	AC / DC operated	AF09..K	AF12..K	AF16..K	AF26..K	AF30..K	AF38..K
Main terminals		 Push-in Spring terminals					
Connection capacity (min. ... max.)							
Main conductors (poles)							
	Rigid	Solid ( $\leq 2.5 \text{ mm}^2$ )	1 x	1 ... 6 mm <sup>2</sup>		1 ... 10 mm <sup>2</sup>	
		Stranded ( $\geq 4 \text{ mm}^2$ )	2 x	1 ... 6 mm <sup>2</sup>		1 ... 10 mm <sup>2</sup>	
	Flexible		1 x	1 (push-in) / 0.5 (spring) ... 4 mm <sup>2</sup>		1 ... 6 mm <sup>2</sup>	
	with non insulated ferrule		2 x	1 (push-in) / 0.5 (spring) ... 4 mm <sup>2</sup>		1 ... 6 mm <sup>2</sup>	
	Flexible with insulated ferrule		1 x	1 (push-in) / 0.5 (spring) ... 4 mm <sup>2</sup>		1 ... 6 mm <sup>2</sup>	
			2 x	1 (push-in) / 0.5 (spring) ... 2.5 mm <sup>2</sup>		1 ... 6 mm <sup>2</sup>	
	Flexible without ferrule		1 x	(spring) 0.5 ... 4 mm <sup>2</sup>		(spring) 1 ... 6 mm <sup>2</sup>	
			2 x	(spring) 0.5 ... 4 mm <sup>2</sup>		(spring) 1 ... 6 mm <sup>2</sup>	
Connection capacity acc. to UL/CSA (Solid $\leq$ AWG 14)			1 or 2 x	AWG 18 ... 10		AWG 18 ... 8	
Stripping length				12 mm		14 mm	
Auxiliary conductors (built-in auxiliary terminals + coil terminals)							
	Rigid solid		1 x	1 ... 2.5 mm <sup>2</sup>			
			2 x	1 ... 2.5 mm <sup>2</sup>			
	Flexible with non insulated ferrule		1 x	1 (push-in) / 0.5 (spring) ... 2.5 mm <sup>2</sup>			
			2 x	1 (push-in) / 0.5 (spring) ... 2.5 mm <sup>2</sup>			
	Flexible with insulated ferrule		1 x	1 (push-in) / 0.5 (spring) ... 1.5 mm <sup>2</sup>			
			2 x	1 (push-in) / 0.5 (spring) ... 1.5 mm <sup>2</sup>			
	Flexible without ferrule		1 x	(spring) 0.5 ... 2.5 mm <sup>2</sup>			
			2 x	(spring) 0.5 ... 2.5 mm <sup>2</sup>			
Connection capacity acc. to UL/CSA			1 or 2 x	AWG 18 ... 14			
Stripping length				10 mm			
Degree of protection acc. to IEC 60947-1 / EN 60947-1 and IEC 60529 / EN 60529							
Main terminals				IP20			
Coil terminals				IP20			
Built-in auxiliary terminals				IP20			
Screwdriver type		All terminals		Flat $\varnothing$ 3 mm x 0.5 mm			

## AF09..K ... AF38..K 3-pole contactors - with Push-in Spring terminals

### Technical data

#### Built-in auxiliary contacts according to IEC

Contactors types	AC / DC operated	AF09..K	AF12..K	AF16..K	AF26..K	AF30..K	AF38..K
Rated operational voltage Ue max.		690 V					
Rated frequency (without derating)		50 / 60 Hz					
Conventional free air thermal current Ith - $\theta \leq 40^\circ\text{C}$		16 A					
le / Rated operational current AC-15							
acc. to IEC 60947-5-1	24-127 V 50/60 Hz	6 A					
	220-240 V 50/60 Hz	4 A					
	400-440 V 50/60 Hz	3 A					
	500 V 50/60 Hz	2 A					
	690 V 50/60 Hz	2 A					
Making capacity AC-15		10 x le AC-15 acc. to IEC 60947-5-1					
Breaking capacity AC-15		10 x le AC-15 acc. to IEC 60947-5-1					
le / Rated operational current DC-13							
acc. to IEC 60947-5-1	24 V DC	6 A / 144 W					
	48 V DC	2.8 A / 134 W					
	72 V DC	1 A / 72 W					
	110 V DC	0.55 A / 60 W					
	125 V DC	0.55 A / 69 W					
	220 V DC	0.27 A / 60 W					
	250 V DC	0.27 A / 68 W					
	400 V DC	0.15 A / 60 W					
	500 V DC	0.13 A / 65 W					
	600 V DC	0.1 A / 60 W					
Short-circuit protection device gG type fuse		10 A					
Rated short-time withstand current Icw	for 1.0 s	100 A					
	for 0.1 s	140 A					
Minimum switching capacity with failure rate acc. to IEC 60947-5-4		12 V / 3 mA					
Non-overlapping time between N.O. and N.C. contacts		$\geq 2$ ms					
Power dissipation per pole at 6 A		0.1 W					
Maximum electrical switching frequency	AC-15	1200 cycles/h					
	DC-13	900 cycles/h					
Mechanically linked contacts acc. to annex L of IEC 60947-5-1		Built-in N.O. or N.C. auxiliary contacts and additional N.O. or N.C. auxiliary contacts (CA4, CAL4 aux. contact blocks) are mechanically linked contacts.					
Mirror contacts acc. to annex F of IEC 60947-4-1		Built-in N.C. auxiliary contacts or additional N.C. auxiliary contacts (CA4, CAL4 aux. contact blocks) are mirror contacts.					

#### Built-in auxiliary contacts according to UL / CSA

Contactors types	AC / DC operated	AF09..K	AF12..K	AF16..K	AF26..K	AF30..K	AF38..K
Maximum operational voltage		600 V AC, 600 V DC					
Pilot duty		A600, Q600					
AC thermal rated current		10 A					
AC maximum volt-ampere making		7200 VA					
AC maximum volt-ampere breaking		720 VA					
DC thermal rated current		2.5 A					
DC maximum volt-ampere making-breaking		69 VA					

## AF09..K ... AF38..K 3-pole contactors with Push-in Spring terminals

### Electrical durability and utilization categories

#### General

Utilization categories determine the current making and breaking conditions relating to the characteristics of the loads to be controlled by the contactors. International standard IEC 60947-4-1 and European standard EN 60947-4-1 are the standards to be referred to.

If  $I_c$  is the current to be broken by the contactor and  $I_e$  the rated operational current normally drawn by the load, then:

- Categories AC-1 and AC-3  $I_c = I_e$
- Category AC-2  $I_c = 2.5 \times I_e$
- Category AC-4  $I_c = 6 \times I_e$

Generally speaking  $I_c = m \times I_e$  where  $m$  is a multiple of the load operational current.

On next pages, the curves corresponding to categories AC-1, AC-3 and AC-4 represent the electrical durability variation of standard contactors in relation to the breaking current  $I_c$ . Electrical durability is expressed in millions of operating cycles.

#### Curve utilization mode

Electrical durability forecast and contactor selection for categories AC-1, AC-2, AC-3 or AC-4

Characteristics	Load to be controlled
Operational voltage	$U_e$
Current normally drawn	$I_e$ ( $U_e / I_e / kW$ relation for motors, see "Motor rated operational powers and currents")
Utilization category	AC-1, AC-2, AC-3 or AC-4
Breaking current	$I_c = I_e$ for AC-1 and for AC-3; $I_c = 2.5 \times I_e$ for AC-2; $I_c = 6 \times I_e$ for AC-4

- Define the number of operating cycles  $N$  required.
- On the diagram corresponding to the operational category, select the contactor with the curve immediately above the intersection point ( $I_c ; N$ ).

#### Electrical durability forecast and contactor selection for mixed duty motor control: AC-3 ( $I_c = I_e$ ) type switching off while "motor running" and, occasionally, AC-4 ( $I_c = 6 \times I_e$ ) type switching off while "motor accelerating"

Characteristics	Load to be controlled
Operational voltage	$U_e$
Current normally drawn while "motor running"	$I_e$ ( $U_e / I_e / kW$ relation for motors, see "Motor rated operational powers and currents")
Utilization category	AC-1, AC-2, AC-3 or AC-4
Breaking current for AC-3	$I_c = I_e$
Breaking current for AC-4 while "motor accelerating"	$I_c = 6 \times I_e$
Percentage of AC-4 operating cycles	$K$ (on the basis of the total number of operating cycles)

- Define the total number of operating cycles  $N$  required.
- Note the smallest contactor rating compatible for AC-3 ( $U_e / I_e$ ) on Main pole utilization characteristic table (see "Technical data").
- For the selected contactor make a note of the following in relation to the voltage using diagram AC-3 in next pages:
  - The number of operating cycles  $A$  for  $I_c = I_e$  (AC-3)
  - The number of operating cycles  $B$  for  $I_c = 6 \times I_e$  (AC-4)
- Calculate the estimated number of cycles  $N'$  ( $N'$  is always below  $A$ )

$$N' = \frac{A}{1 + 0.01 K (A/B - 1)}$$

- If  $N'$  is too low in relation to the target  $N$ , calculate the estimated number of cycles for a higher contactor rating.

#### Case of uninterrupted duty

For uninterrupted duty, some verifications of preventing maintenance are necessary to check the functionality of the concerned product (consult us).

The combined effect of environmental conditions and the proper temperature of the product may require some disposals. As a matter of fact, for this duty, the use duration prevails over the number of operating cycles.

# AF09..K ... AF38..K 3-pole contactors - with Push-in Spring terminals

## Electrical durability

### Electrical Durability for AC-1 Utilization Category - $U_e \leq 690\text{ V}$ .

Switching non-inductive or slightly inductive loads. The breaking current  $I_c$  for AC-1 is equal to the rated operational current of the load.

Ambient temperature and maximum electrical switching frequency: see "Technical Data".

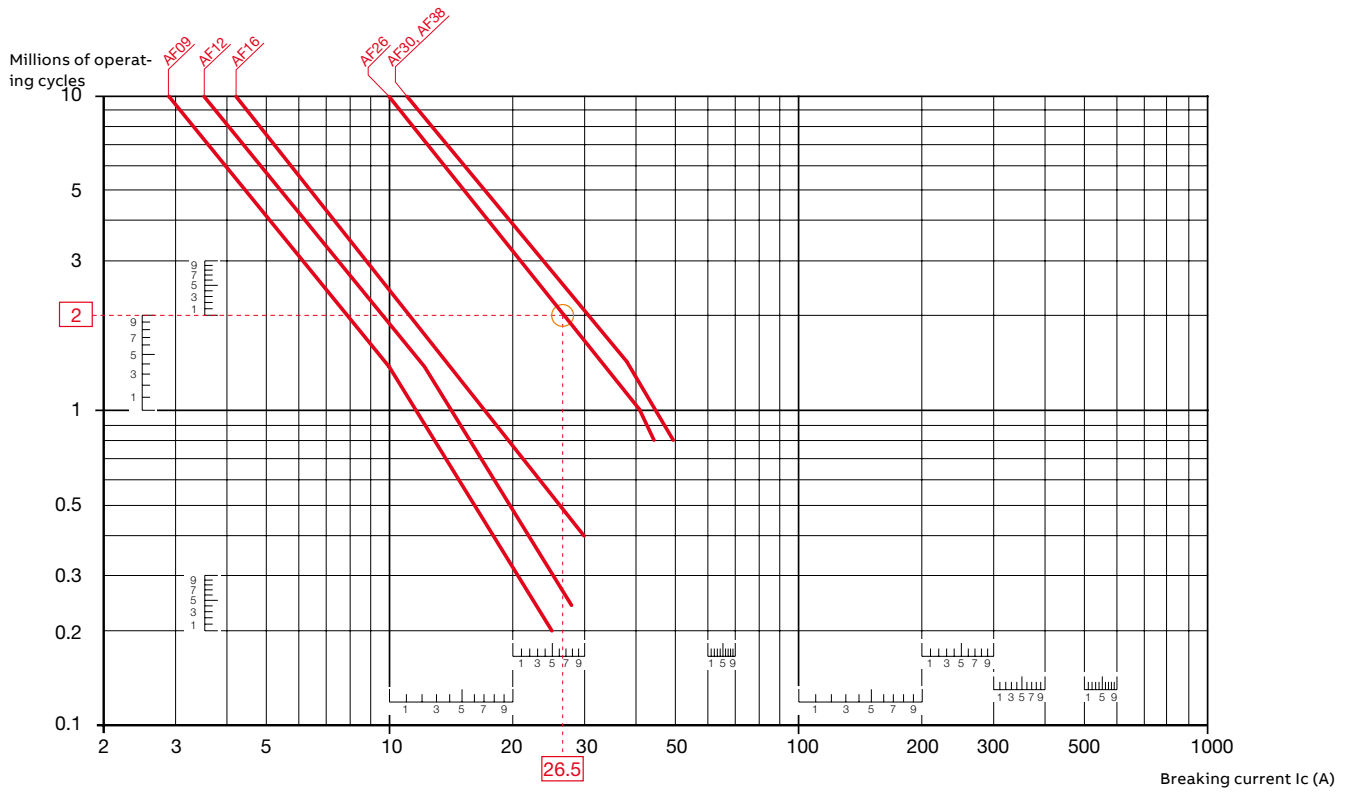

### Example:

$I_c / AC-1 = 26.5\text{ A}$  – Electrical durability required = 2 millions operating cycles.

Using the AC-1 curves above select the AF26 contactor at intersection "O" (26.5 A / 2 millions operating cycles).

# AF09..K ... AF38..K 3-pole contactors - with Push-in Spring terminals

## Electrical durability

### Electrical Durability for AC-3 Utilization Category

Switching cage motors: starting and switching off running motors. The breaking current  $I_c$  for AC-3 is equal to the rated operational current  $I_e$  ( $I_e$  = motor full load current). Ambient temperature and maximum electrical switching frequency: see "Technical Data".

### AC-3 - $U_e \leq 440$ V

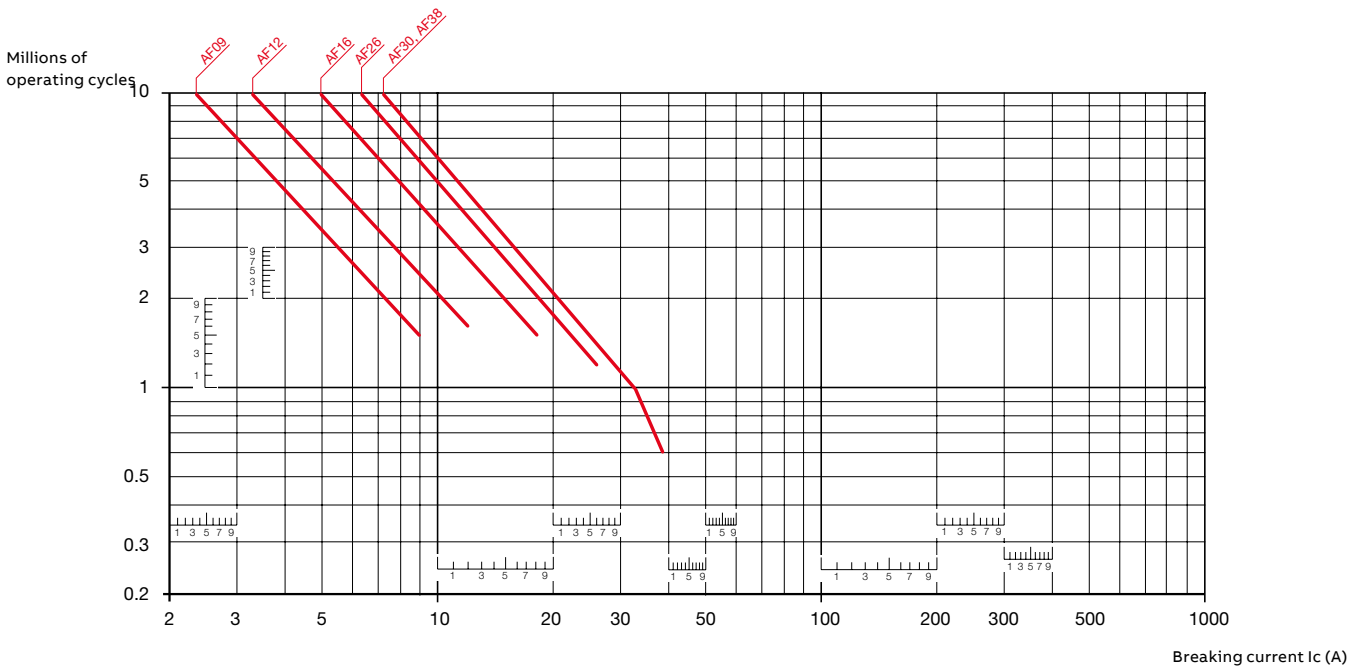

### AC-3 - $440$ V < $U_e \leq 690$ V

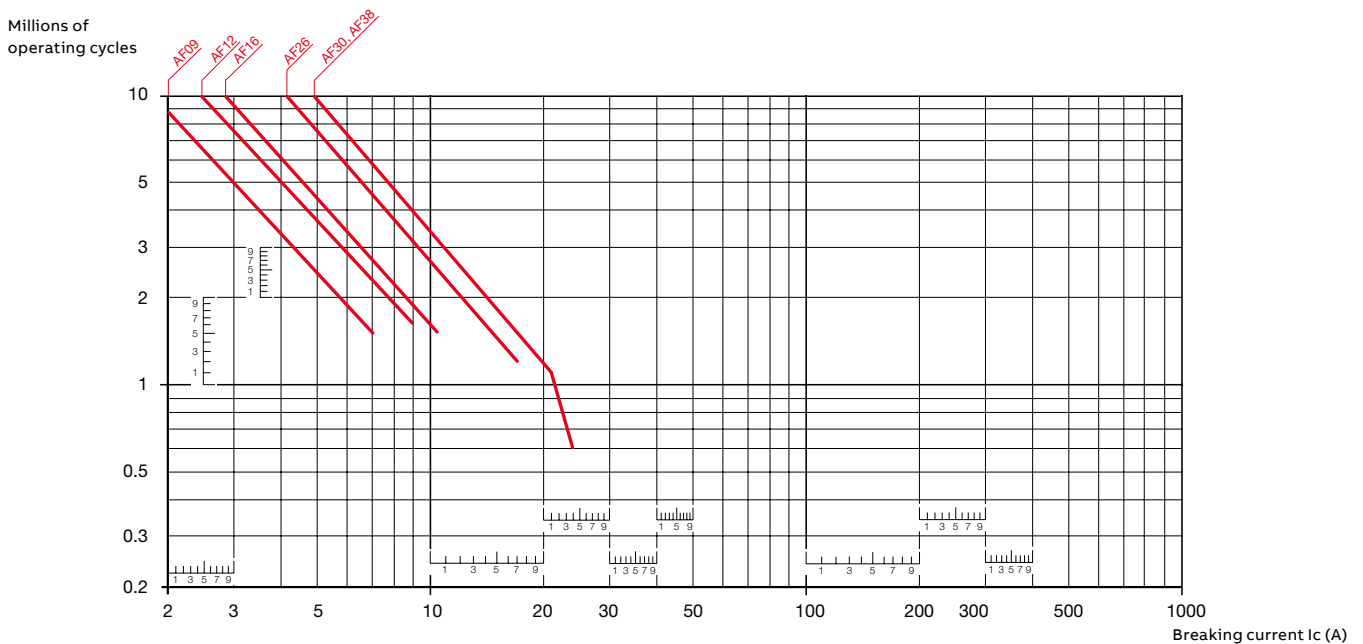



# AF09..K ... AF38..K 3-pole contactors - with Push-in Spring terminals

## Electrical durability

### Electrical Durability for AC-2 or AC-4 Utilization Category

Switching cage motors: starting reverse operation and step-by-step operation. The breaking current  $I_c$  is equal to  $2.5 \times I_e$  for AC-2 and  $6 \times I_e$  for AC-4, keeping in mind that  $I_e$  is the motor rated operational current  $I_e$  ( $I_e$  = motor full load current).

Ambient temperature  $\leq 60^\circ\text{C}$ . Maximum electrical switching frequency: see "Technical Data".

### AC-2 or AC-4 - $U_e \leq 440\text{ V}$

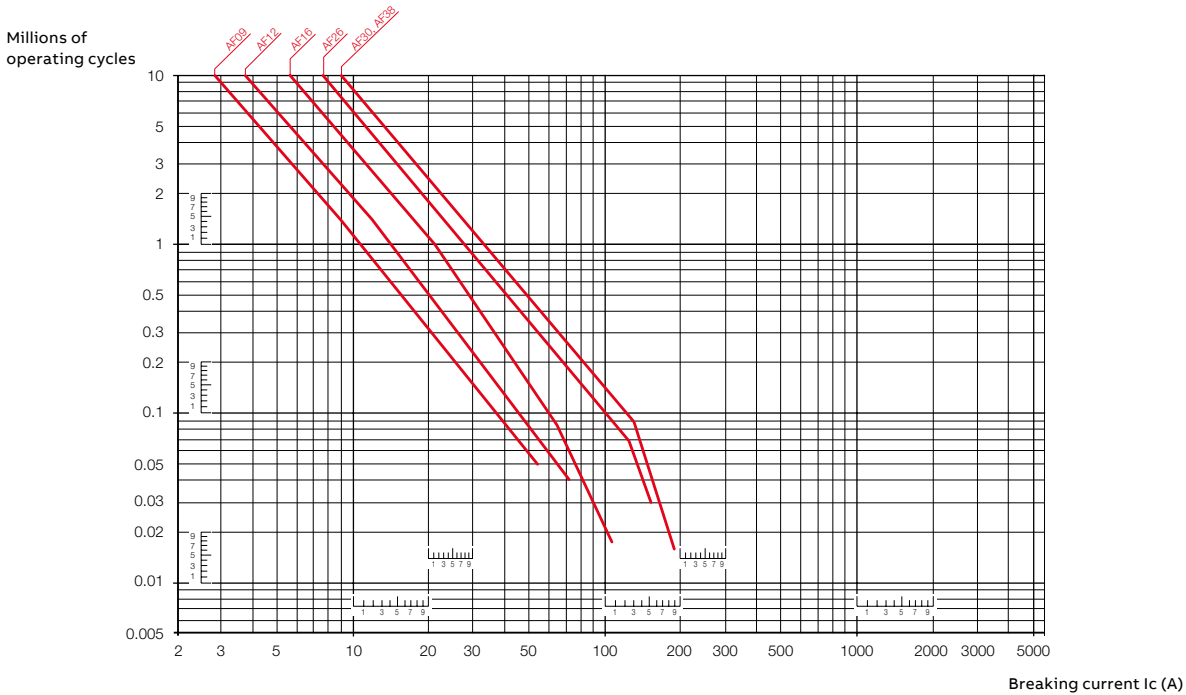

### AC-2 or AC-4 - $440\text{ V} < U_e \leq 690\text{ V}$

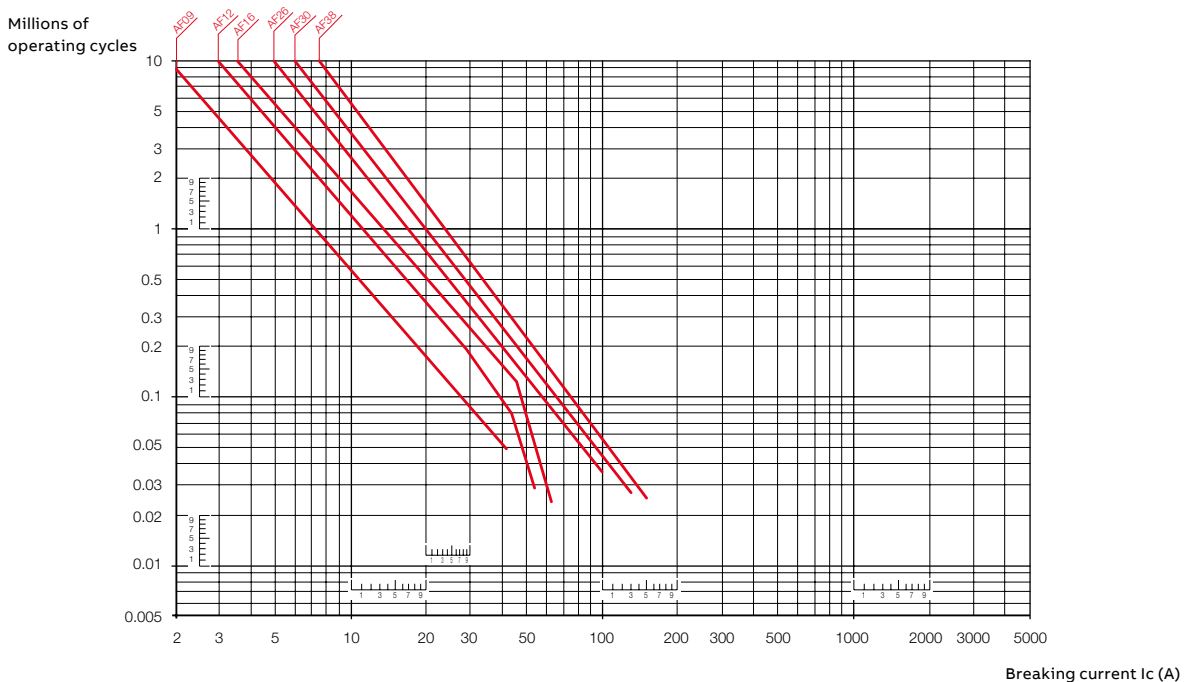

—

# Notes

A large rectangular area filled with a grid of small, light gray dotted lines, intended for handwritten notes.





---

# AFS contactors for safety applications

**3/109 Overview****Ordering details****4 to 18.5 kW****3/114** AFS09 ... AFS38 AC / DC operated with 2 N.O. + 2 N.C.**18.5 to 45 kW****3/115** AFS40 ... AFS96 AC / DC operated with 2 N.O. + 2 N.C.**3/116** AFS09 ... AFS96 Contactors and main accessories**3/117 Technical data****3/124 Electrical durability****3/404 Voltage code table**

For direct product details information, use product type or order code, ex:

- [www.abb.com/productdetails/AF09-30-10-13](http://www.abb.com/productdetails/AF09-30-10-13)
- or [www.abb.com/productdetails/1SBL137001R1310](http://www.abb.com/productdetails/1SBL137001R1310)





# AFS 3-pole contactors with front-mounted auxiliary contacts

## Dedicated for safety applications



ABB's complete range of safety components make protection systems easier to build. Designed for machine safety applications, AFS contactors come with fixed front or side mounted auxiliary contact blocks, making them ideal for monitoring and controlling circuits. Mechanically linked and mirror contacts help make your system safer.



### Safety and protection

#### Safety in all things

ABB's AFS contactors can be easily integrated in machine manufacturer's systems complying with main standards EN ISO 13849 and EN 62061 - guaranteeing the safe use of your machinery and equipment. The AFS contactor range is an integral part of ABB's comprehensive range of safety products.



### Continuous operation

#### Secure uptime

The AFS contactor secures system uptime. It allows direct control by safety PLCs or safety relays to ensure the safety performance customers require, for contactors up to 38 A. A low energy auxiliary contact guarantees PLC feedback.



### Speed up your projects

#### Simplify design

Perfect design makes integration easier. ABB's distinctive yellow auxiliary contact block makes identifying the right product quicker. By reducing the contactor coil's power consumption, panels can also be made smaller and transformers more compact. In addition, all the safety data for the contactors are readily available using safety design tools.



# AFS contactors with front-mounted auxiliary contact blocks

## Dedicated for safety applications

### Contactors status guaranteed

ABB's permanently fixed front-mounted auxiliary contact blocks guarantee the correct contactor status at all times. Mechanically linked and mirror contacts get clearly marked symbols on the front and provide the performance required in feedback circuits. This prevents any unexpected state changes of auxiliary contact if main contacts become welded or stuck and ensures an accurate depiction of the safety system status displayed at all times.

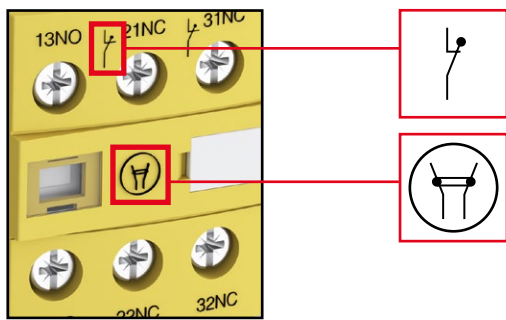

### Easy safety chain identification

The yellow housing of ABB's AFS contactors makes identifying the safety product in your panel quicker. During routine maintenance work, ABB's intuitive design saves valuable time.

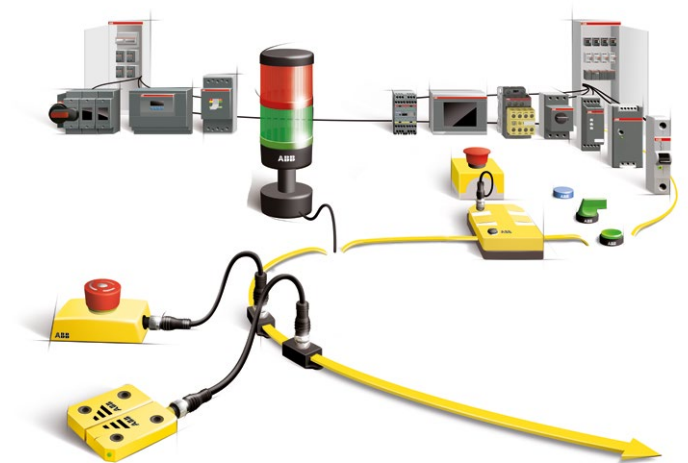

### Prevent unexpected operations

Front-mounted contact blocks are permanently fixed to protect devices against accidental misuse and operation. A factory-fitted transparent cover shields the contactor status indicator, providing additional protection.

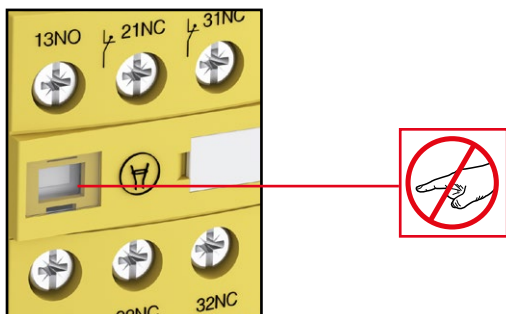

### Simplify calculation of your installation safety level

All safety values are available in safety design tool such as Sistema and FSDT, dedicated software for determining the Performance Level (PL) and Safety Integrity Level (SIL) of safety functions and generating technical documentations.

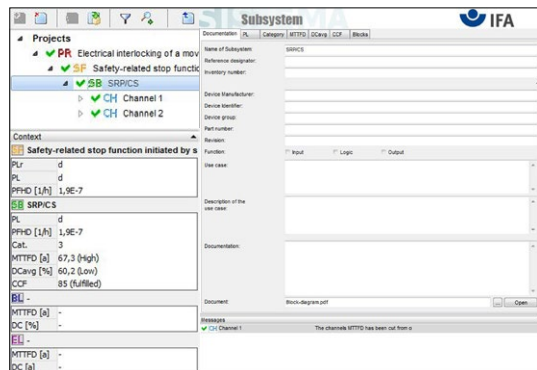

**Control by safety PLCs or safety relays**

ABB's AFS contactors can be controlled directly by safety PLCs or safety relays. The low energy auxiliary contacts feature a minimum switching capacity 12 V/3 mA. They guarantee system status feedback, making the system safe and reliable.

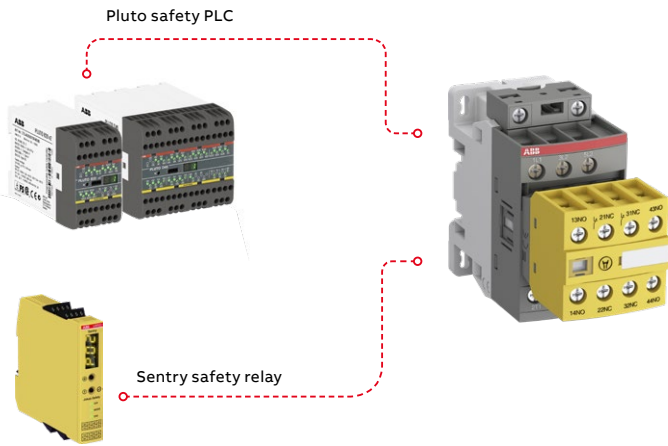

**Fast response for increased safety**

With fast opening times less than 30 ms for selected variants, AFS09 ... AFS38 respond quickly when a dangerous failure is detected. Safety is enhanced and the safety distances of installations can be significantly shorter.

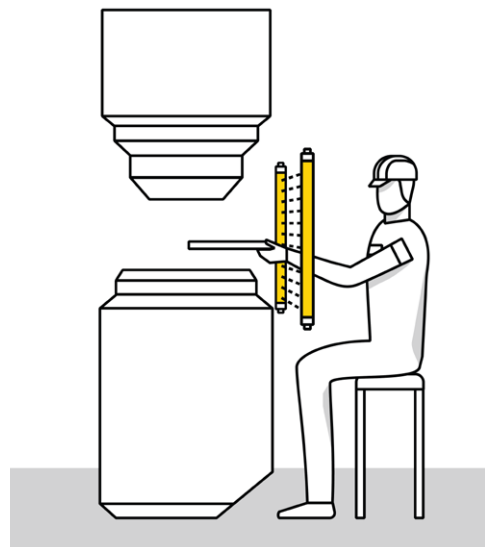

**Panel size reduction**

By reducing coil energy consumption by up to 60%, panels can be built smaller and transformers can be downsized. With reduced power dissipation in the cabinet, installations also need fewer fans. Using AFS contactors saves money and precious space.

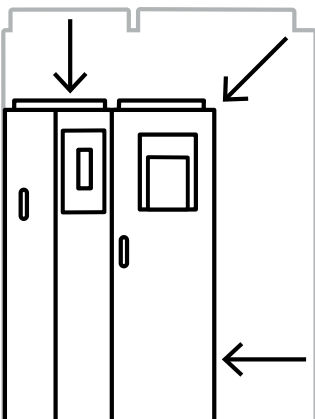

**Built-in surge suppression**

Unlike conventional contactors, ABB's AFS contactors have built-in surge suppression, preventing surges from ever reaching the control circuit. With no need for the usual external surge suppressor add-ons, ABB's solution means one less device to install and one less complication to manage.

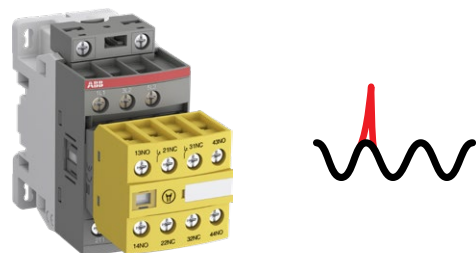

# AFS contactors for safety applications

03

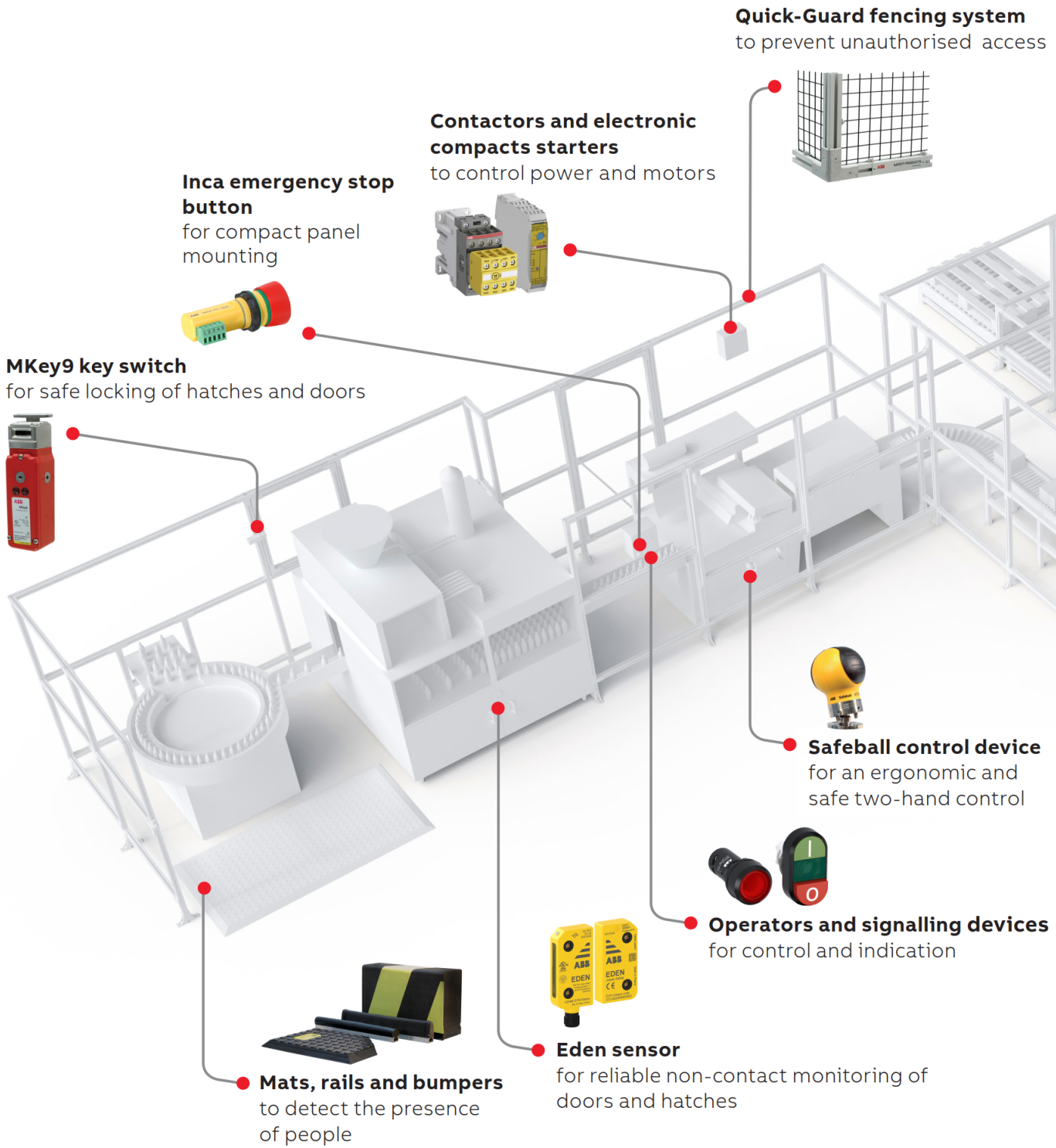

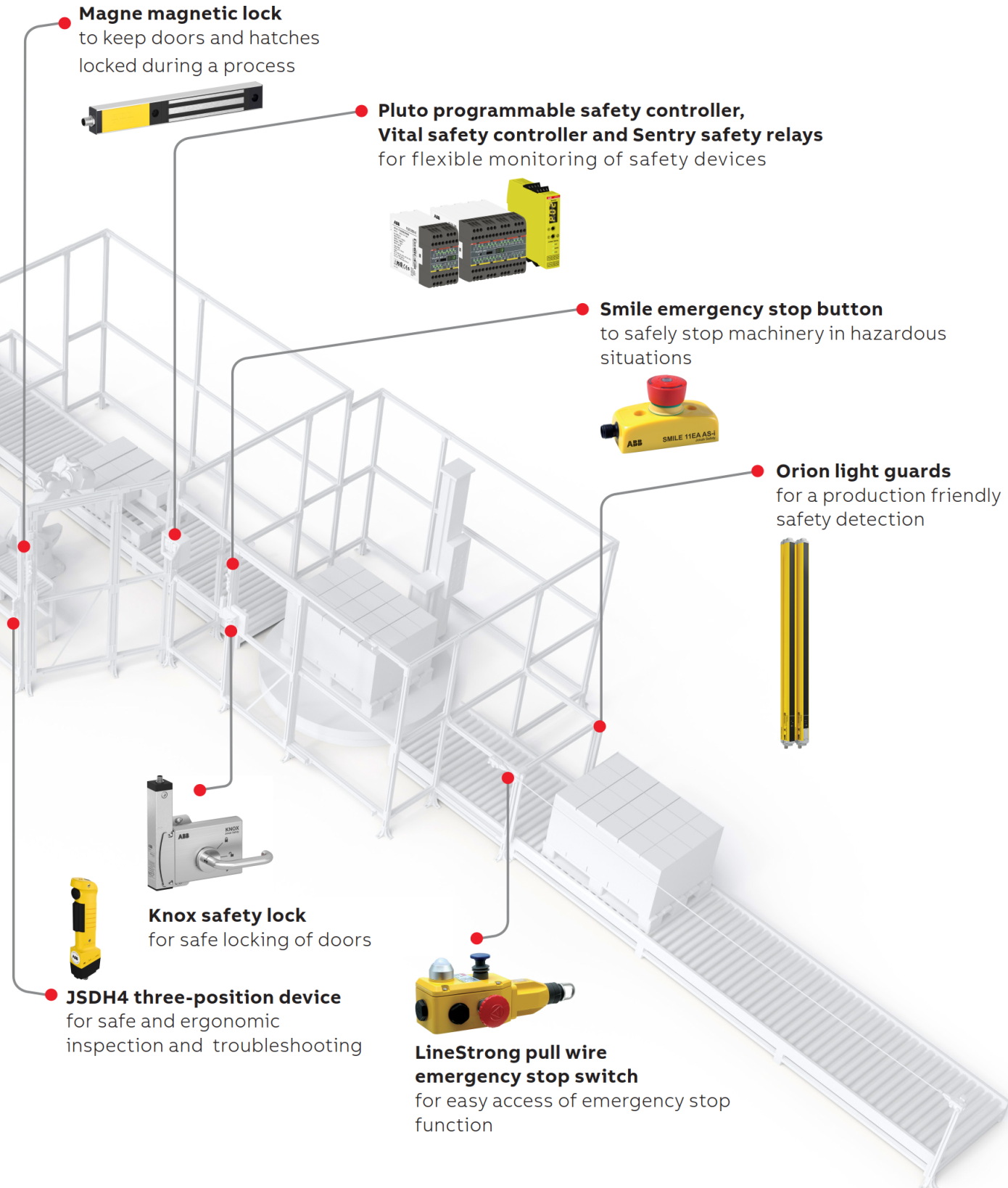

# AFS09 ... AFS38 3-pole contactors for safety applications

4 to 18.5 kW

AC / DC operated with 2 N.O. + 2 N.C. auxiliary contacts



AFS16-30-22



AFS38-30-22

AFS09 ... AFS38 contactors are designed for machine safety applications. They are delivered with fixed front-mounted auxiliary contact blocks making them ideal for monitoring and controlling circuits.

Mechanically linked and mirror contacts make your system safer.

- control circuit with electronic coil interface:
  - dedicated 24 V DC for direct control by PLC-output  $\geq 250$  mA, low holding consumption up to 1.7 W
  - 24...60 V AC, 20...60 V DC and 100...250 V AC / DC operated accepting a wide control voltage range
  - reduced panel energy consumption
- mirror and mechanically linked contacts, with front marked symbol acc. to IEC60947-5-1, always guaranteeing the right contactor status
- front-mounted auxiliary contact block:
  - permanently fixed
  - protective cover to prevent manual operation
  - yellow housing for easy identification
  - minimum switching capacity 12 V / 3 mA, with a failure rate  $10^{-7}$  acc. to IEC 60947-5-4
- built-in surge suppression

IEC		UL/CSA		Rated control circuit voltage		Auxiliary contacts fitted	Type (1)	Order code	Weight
Rated power	operational current $\theta \leq 40^\circ\text{C}$	3-phase motor rating 480 V	General use rating 600 V AC	Uc min. ... Uc max.					
400 V AC-3 kW	AC-1 A	hp	A	V 50/60 Hz	V DC				kg
4	25	5	25	-	24	2 2	AFS09Z-30-22-30	1SBL136082R3022	0.490
				24 ... 60	20 ... 60 (1)	2 2	AFS09-30-22-11	1SBL137082R1122	0.320
				100 ... 250	100 ... 250	2 2	AFS09-30-22-13	1SBL137082R1322	0.320
5.5	28	7-1/2	28	-	24	2 2	AFS12Z-30-22-30	1SBL156082R3022	0.490
				24 ... 60	20 ... 60 (1)	2 2	AFS12-30-22-11	1SBL157082R1122	0.320
				100 ... 250	100 ... 250	2 2	AFS12-30-22-13	1SBL157082R1322	0.320
7.5	30	10	30	-	24	2 2	AFS16Z-30-22-30	1SBL176082R3022	0.490
				24 ... 60	20 ... 60 (1)	2 2	AFS16-30-22-11	1SBL177082R1122	0.320
				100 ... 250	100 ... 250	2 2	AFS16-30-22-13	1SBL177082R1322	0.320
11	45	15	45	-	24	2 2	AFS26Z-30-22-30	1SBL236082R3022	0.540
				24 ... 60	20 ... 60 (1)	2 2	AFS26-30-22-11	1SBL237082R1122	0.360
				100 ... 250	100 ... 250	2 2	AFS26-30-22-13	1SBL237082R1322	0.360
15	50	20	50	-	24	2 2	AFS30Z-30-22-30	1SBL276082R3022	0.540
				24 ... 60	20 ... 60	2 2	AFS30-30-22-11	1SBL277082R1122	0.360
				100 ... 250	100 ... 250 (1)	2 2	AFS30-30-22-13	1SBL277082R1322	0.360
18.5	50	25	50	-	24	2 2	AFS38Z-30-22-30	1SBL296082R3022	0.540
				24 ... 60	20 ... 60 (1)	2 2	AFS38-30-22-11	1SBL297082R1122	0.360
				100 ... 250	100 ... 250	2 2	AFS38-30-22-13	1SBL297082R1322	0.360

(1) AFS...-30...-11 for control by transistor outputs of safety PLCs and safety relays use interface relay RA4 1SBN060100R1000.

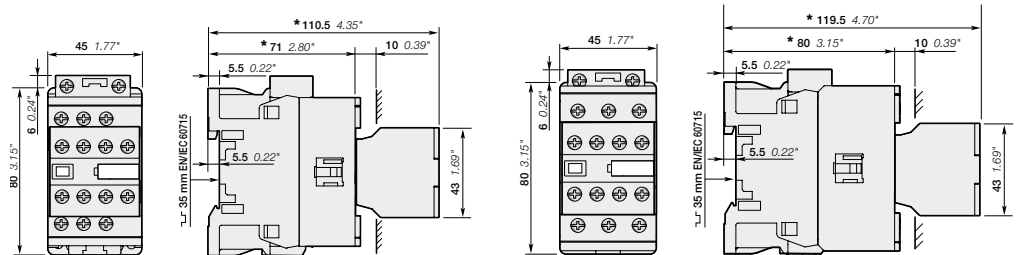

AFS09, AFS12, AFS16

\* For AFS09Z, AFS12Z, AFS16Z-30-22-30: depth + 20 mm (+ 0.79")

AFS26, AFS30, AFS38

\* For AFS26Z, AFS30Z, AFS38Z-30-22-30: depth + 20 mm (+ 0.79")

Main dimensions mm, inches



# AFS40 ... AFS96 3-pole contactors for safety applications

18.5 to 45 kW

AC / DC operated with 2 N.O. + 2 N.C. auxiliary contacts



AFS65-30-22



AFS96-30-22

AFS40 ... AFS96 contactors are designed for machine safety applications. They are delivered with fixed front-mounted auxiliary contact blocks making them ideal for monitoring and controlling circuits. Mechanically linked and mirror contacts make your system safer.

- control circuit with electronic coil interface:
  - 24...60 V AC, 20...60 V DC and 100...250 V AC / DC operated accepting a wide control voltage range
  - reduced panel energy consumption
- mirror and mechanically linked contacts, with front marked symbol acc. to IEC60947-5-1, always guaranteeing the right contactor status
- front-mounted auxiliary contact block:
  - permanently fixed
  - protective cover to prevent manual operation
  - yellow housing for easy identification
  - minimum switching capacity 12 V / 3 mA, with a failure rate  $10^{-7}$  acc. to IEC 60947-5-4
- built-in surge suppression

IEC Rated operational power	UL/CSA 3-phase motor rating 480 V	General use rating 600 V AC	Rated control circuit voltage Uc min. ... Uc max.		Auxiliary contacts fitted	Type (1)	Order code	Weight Pkg (1 pce) kg	
			V 50/60 Hz	V DC					
400 V AC-3 kW	AC-1 A	hp	A	V 50/60 Hz	V DC				
18.5	70	30	60	24 ... 60 100 ... 250	20 ... 60 (1) 100 ... 250	2 2	AFS40-30-22-11 AFS40-30-22-13	1SBL347082R1122 1SBL347082R1322	1.020 1.000
22	100	40	80	24 ... 60 100 ... 250	20 ... 60 (1) 100 ... 250	2 2	AFS52-30-22-11 AFS52-30-22-13	1SBL367082R1122 1SBL367082R1322	1.020 1.000
30	105	50	90	24 ... 60 100 ... 250	20 ... 60 (1) 100 ... 250	2 2	AFS65-30-22-11 AFS65-30-22-13	1SBL387082R1122 1SBL387082R1322	1.020 1.000
37	125	60	105	24 ... 60 100 ... 250	20 ... 60 (1) 100 ... 250	2 2	AFS80-30-22-11 AFS80-30-22-13	1SBL397082R1122 1SBL397082R1322	1.270 1.220
45	130	60	115	24 ... 60 100 ... 250	20 ... 60 (1) 100 ... 250	2 2	AFS96-30-22-11 AFS96-30-22-13	1SBL407082R1122 1SBL407082R1322	1.270 1.220

(1) AFS...30...-11 for control by transistor outputs of safety PLCs and safety relays use interface relay RA4 1SBN060100R1000.

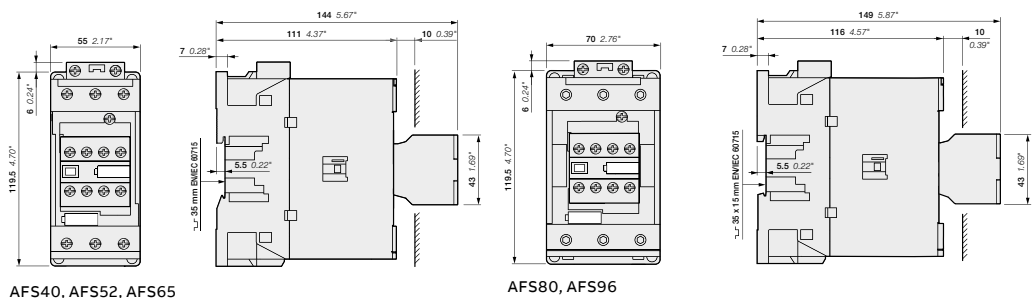

Main dimensions mm, inches



# AFS09 ... AFS96 3-pole contactors for safety applications

## Contactors and main accessories

03

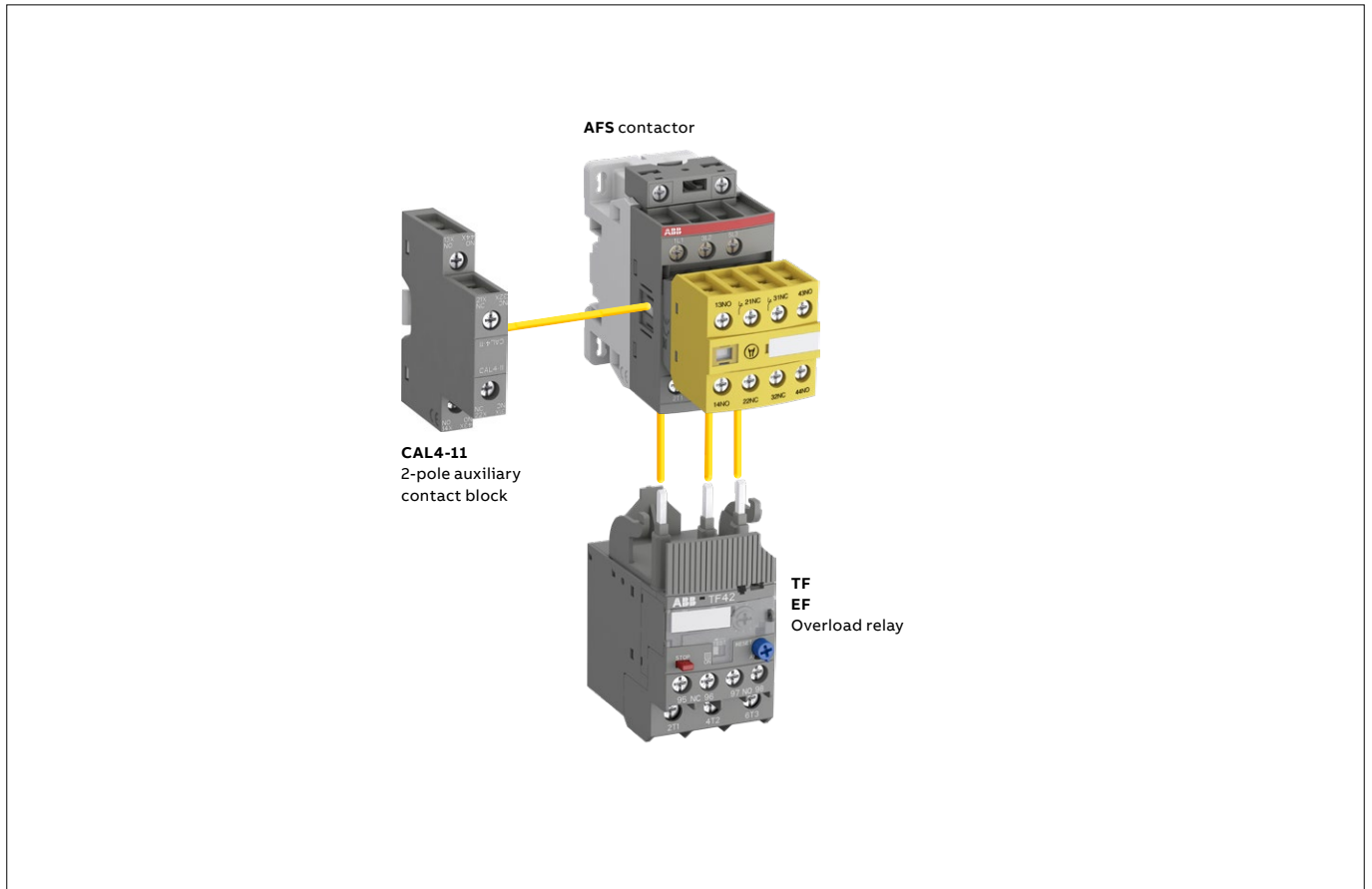

**Main accessory fitting details** - for ordering details, technical data and other accessories: see section accessories  
 Many configurations of accessories are possible depending on whether these are front-mounted or side-mounted.

Contactor types	Main poles	Built-in auxiliary contacts	Front-mounted accessories				Mechanical interlock unit (between 2 contactors)	Side-mounted accessories	
			Auxiliary contact blocks			Electronic timer		Auxiliary contact blocks	
			1-pole CA4	2-pole CAT4-11	4-pole CA4	TEF4	VM..	2-pole CAL4-11 Left side	Right side
AFS09 ... AFS38	3 0	2 2	-	-	-	-	1	+ 1	-
AFS09Z ... AFS38Z	3 0	2 2	-	-	-	-	1	-	-
AFS40 ... AFS96	3 0	2 2	-	-	-	-	-	+ 1	+ 1
			-	-	-	-	-	+ 1	or 1

### Overload relays fitting details (1)

Contactor types	Thermal overload relays	Electronic overload relays
AFS09 ... AFS38	TF42 (0.10...38 A)	EF19 (0.10...19 A)
AFS26 ... AFS38	TF42 (0.10...38 A)	EF45 (9...45 A)
AFS40 ... AFS65	TF65 (22...67 A)	EF65 (20...70 A)
AFS80, AFS96	TF96 (40...96 A)	EF96 (36...100 A)

The addition of an overload relay on the contactor does not prevent fitting of many other accessories as shown above.

(1) Direct mounting - No kit required.

# AFS09 ... AFS96 3-pole contactors for safety applications

## Technical data

### Main pole - Utilization characteristics according to IEC

Contactor types	AC / DC operated	AFS09	AFS12	AFS16	AFS26	AFS30	AFS38	AFS40	AFS52	AFS65	AFS80	AFS96	
Standards		IEC 60947-1 / 60947-4-1 and EN 60947-1 / 60947-4-1											
Rated operational voltage Ue max.		690 V										1000 V	
Rated frequency (without derating)		50 / 60 Hz											
Conventional free-air thermal current Ith													
acc. to IEC 60947-4-1, open contactors, $\theta \leq 40^\circ\text{C}$		35 A	35 A	35 A	50 A	50 A	50 A	105 A	105 A	105 A	130 A	130 A	
With conductor cross-sectional area		6 mm <sup>2</sup>	6 mm <sup>2</sup>	6 mm <sup>2</sup>	10 mm <sup>2</sup>	10 mm <sup>2</sup>	10 mm <sup>2</sup>	35 mm <sup>2</sup>	35 mm <sup>2</sup>	35 mm <sup>2</sup>	50 mm <sup>2</sup>	50 mm <sup>2</sup>	
AC-1 Utilization category													
For air temperature close to contactor													
le / Rated operational current AC-1	$\theta \leq 40^\circ\text{C}$	25 A	28 A	30 A	45 A	50 A	50 A	70 A	100 A	105 A	125 A	130 A	
Ue max. $\leq 690\text{ V}, 50/60\text{ Hz}$	$\theta \leq 60^\circ\text{C}$	25 A	28 A	30 A	40 A	42 A	42 A	60 A	80 A	90 A	100 A	105 A	
	$\theta \leq 70^\circ\text{C}$	22 A	24 A	26 A	32 A	37 A	37 A	50 A	70 A	80 A	85 A	90 A	
With conductor cross-sectional area		4 mm <sup>2</sup>	6 mm <sup>2</sup>	6 mm <sup>2</sup>	10 mm <sup>2</sup>	10 mm <sup>2</sup>	10 mm <sup>2</sup>	25 mm <sup>2</sup>	35 mm <sup>2</sup>	35 mm <sup>2</sup>	50 mm <sup>2</sup>	50 mm <sup>2</sup>	
AC-3 Utilization category													
For air temperature close to contactor $\theta \leq 60^\circ\text{C}$													
le / Max. rated operational current AC-3 (1)													
	220-230-240 V	9 A	12 A	18 A	26 A	33 A	40 A	40 A	53 A	65 A	80 A	96 A	
	380-400 V	9 A	12 A	18 A	26 A	32 A	38 A	40 A	53 A	65 A	80 A	96 A	
	415 V	9 A	12 A	18 A	26 A	32 A	38 A	40 A	53 A	65 A	80 A	96 A	
	440 V	9 A	12 A	18 A	26 A	32 A	38 A	40 A	53 A	65 A	80 A	96 A	
	500 V	9.5 A	12.5 A	15 A	23 A	28 A	33 A	35 A	45 A	55 A	65 A	80 A	
	690 V	7 A	9 A	10.5 A	17 A	21 A	24 A	25 A	35 A	39 A	49 A	57 A	
	1000 V										25 A	30 A	
Rated operational power AC-3 (1)													
	220-230-240 V	2.2 kW	3 kW	4 kW	6.5 kW	9 kW	11 kW	11 kW	15 kW	18.5 kW	22 kW	25 kW	
	380-400 V	4 kW	5.5 kW	7.5 kW	11 kW	15 kW	18.5 kW	18.5 kW	22 kW	30 kW	37 kW	45 kW	
	415 V	4 kW	5.5 kW	9 kW	11 kW	15 kW	18.5 kW	22 kW	30 kW	37 kW	45 kW	55 kW	
	440 V	4 kW	5.5 kW	9 kW	15 kW	18.5 kW	22 kW	22 kW	30 kW	37 kW	45 kW	55 kW	
	500 V	5.5 kW	7.5 kW	9 kW	15 kW	18.5 kW	22 kW	22 kW	30 kW	37 kW	45 kW	55 kW	
	690 V	5.5 kW	7.5 kW	9 kW	15 kW	18.5 kW	22 kW	22 kW	30 kW	37 kW	45 kW	55 kW	
	1000 V										35 kW	40 kW	
Rated making capacity AC-3		10 x Ie AC-3 acc. to IEC 60947-4-1											
Rated breaking capacity AC-3		8 x Ie AC-3 acc. to IEC 60947-4-1											
AC-8a Utilization category													
(without thermal overload relay													
Ue 400 V 50/60 Hz - $\theta \leq 40^\circ\text{C}$ )													
le / Rated operational current AC-8a		12 A	16 A	22 A	30 A	40 A	50 A	53 A	70 A	85 A	105 A	120 A	
Rated operational power AC-8a		5.5 kW	7.5 kW	11 kW	15 kW	20 kW	25 kW	25 kW	37 kW	45 kW	55 kW	65 kW	
Short-circuit protection device for contactors													
without thermal overload relay													
Motor protection excluded (2)													
Ue $\leq 500\text{ V AC}$ - gG type fuse		25 A	32 A	32 A	50 A	63 A	63 A	100 A	125 A	160 A	160 A	200 A	
Rated short-time withstand current Icw	1 s	300 A	300 A	300 A	700 A	700 A	700 A	1000 A	1000 A	1000 A	1200 A	1200 A	
at 40 °C ambient temperature,	10 s	150 A	150 A	150 A	350 A	350 A	350 A	600 A	600 A	600 A	780 A	780 A	
in free air from a cold state	30 s	80 A	80 A	80 A	225 A	225 A	225 A	350 A	350 A	350 A	450 A	450 A	
	1 min	60 A	60 A	60 A	150 A	150 A	150 A	250 A	250 A	250 A	300 A	300 A	
	15 min	35 A	35 A	35 A	50 A	50 A	50 A	110 A	110 A	110 A	140 A	140 A	
Maximum breaking capacity													
cos $\phi = 0.45$													
	at 440 V	250 A	250 A	250 A	500 A	500 A	500 A	950 A	950 A	950 A	1150 A	1150 A	
	at 690 V	106 A	106 A	106 A	200 A	200 A	200 A	600 A	600 A	600 A	750 A	750 A	
Power dissipation per pole	le / AC-1	0.8 W	1 W	1.2 W	1.8 W	2.4 W	2.4 W	3 W	6.3 W	7 W	7.6 W	8.2 W	
	le / AC-3	0.1 W	0.2 W	0.35 W	0.6 W	0.9 W	1.3 W	1 W	1.7 W	2.7 W	3 W	4.5 W	
Max. electrical switching frequency	AC-1	600 cycles/h											
	AC-3	1200 cycles/h											
	AC-2, AC-4	300 cycles/h				150 cycles/h							
B10d													
Calculated for 50% of the rated current value Ie at AC-3 / 400 V		1.3 million operating cycles											

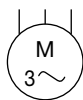

3-phase motors

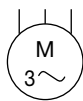

1500 r.p.m. 50 Hz  
1800 r.p.m. 60 Hz  
3-phase motors

(1) For the corresponding kW/A or hp/A values of 1500 r.p.m, 50 Hz or 1800 r.p.m, 60 Hz, 3-phase motors, see "Motor rated operational powers and currents".

(2) For the protection of motor starters against short circuits, see "Coordination with short-circuit protection devices".

# AFS09 ... AFS96 3-pole contactors for safety applications

## Technical data

### Main pole - Utilization characteristics according to UL / NEMA / CSA

Contactors types	AC / DC operated	AFS09	AFS12	AFS16	AFS26	AFS30	AFS38	AFS40	AFS52	AFS65	AFS80	AFS96
Standards		UL 60947-4-1, CSA-C22.2 No. 60947-4-1										
Maximum operational voltage		600 V										
NEMA size		00	0	-	1	-	-	2	-	-	3	-
NEMA continuous amp rating	Thermal current	9 A	18 A	-	27 A	-	-	45 A	-	-	90 A	-
NEMA maximum horse power ratings 1-phase, 60 Hz	115 V AC	1/3 hp	1 hp	-	2 hp	-	-	3 hp	-	-	-	-
	230 V AC	1 hp	2 hp	-	3 hp	-	-	7.5 hp	-	-	-	-
NEMA maximum horse power ratings 3-phase, 60 Hz	200 V AC	1-1/2 hp	3 hp	-	7-1/2 hp	-	-	10 hp	-	-	25 hp	-
	230 V AC	1-1/2 hp	3 hp	-	7-1/2 hp	-	-	15 hp	-	-	30 hp	-
	460 V AC	2 hp	5 hp	-	10 hp	-	-	25 hp	-	-	50 hp	-
	575 V AC	2 hp	5 hp	-	10 hp	-	-	25 hp	-	-	50 hp	-
UL / CSA general use rating												
600 V AC		25 A	28 A	30 A	45 A	50 A	50 A	60 A	80 A	90 A	105 A	115 A
With conductor cross-sectional area		AWG 10	AWG 10	AWG 10	AWG 8	AWG 8	AWG 8	AWG 6	AWG 4	AWG 3	AWG 2	AWG 2
1 pole	80 V DC	25 A	28 A	30 A	45 A	50 A	50 A	60 A	80 A	90 A	105 A	115 A
2 poles in serie	160 V DC	25 A	28 A	30 A	45 A	50 A	50 A	60 A	80 A	90 A	105 A	115 A
3 poles in serie	240 V DC	25 A	28 A	30 A	45 A	50 A	50 A	60 A	80 A	90 A	105 A	115 A
With conductor cross-sectional area		AWG 10	AWG 10	AWG 10	AWG 8	AWG 8	AWG 8	AWG 6	AWG 4	AWG 3	AWG 2	AWG 2
UL / CSA maximum 1-phase motor rating												
Full load current	120 V AC	13.8 A	16 A	20 A	24 A	24 A	24 A	34 A	34 A	56 A	80 A	80 A
	240 V AC	10 A	12 A	17 A	17 A	28 A	28 A	40 A	50 A	68 A	68 A	88 A
Horse power rating	120 V AC	3/4 hp	1 hp	1-1/2 hp	2 hp	2 hp	2 hp	3 hp	3 hp	5 hp	7-1/2 hp	7-1/2 hp
	240 V AC	1-1/2 hp	2 hp	3 hp	3 hp	5 hp	5 hp	7-1/2 hp	10 hp	15 hp	15 hp	20 hp
UL / CSA maximum 3-phase motor rating												
Full load current (1)	200-208 V AC	7.8 A	11 A	17.5 A	25.3 A	32.2 A	32.2 A	32.2 A	48.3 A	62.1 A	78.2 A	92 A
	220-240 V AC	6.8 A	9.6 A	15.2 A	22 A	28 A	28 A	42 A	54 A	68 A	80 A	80 A
	440-480 V AC	7.6 A	11 A	14 A	21 A	27 A	34 A	40 A	52 A	65 A	77 A	77 A
	550-600 V AC	9 A	11 A	17 A	22 A	27 A	32 A	41 A	52 A	62 A	77 A	77 A
Horse power rating (1)	200-208 V AC	2 hp	3 hp	5 hp	7-1/2 hp	10 hp	10 hp	10 hp	15 hp	20 hp	25 hp	30 hp
	220-240 V AC	2 hp	3 hp	5 hp	7-1/2 hp	10 hp	10 hp	15 hp	20 hp	25 hp	30 hp	30 hp
	440-480 V AC	5 hp	7-1/2 hp	10 hp	15 hp	20 hp	25 hp	30 hp	40 hp	50 hp	60 hp	60 hp
	550-600 V AC	7-1/2 hp	10 hp	15 hp	20 hp	25 hp	30 hp	40 hp	50 hp	60 hp	75 hp	75 hp
UL / CSA - DC motor starting - 3 poles in series												
Full Load Amps	125 V DC	9.5 A	13.2 A	17 A	25 A	25 A	25 A	40 A	58 A	76 A	76 A	110 A
	250 V DC	8.5 A	12.2 A	12.2 A	20 A	29 A	29 A	38 A	55 A	72 A	89 A	106 A
Horse power rating	125 V DC	1 hp	1-1/2 hp	2 hp	3 hp	3 hp	3 hp	5 hp	7-1/2 hp	10 hp	10 hp	15 hp
	250 V DC	2 hp	3 hp	3 hp	5 hp	7-1/2 hp	7-1/2 hp	10 hp	15 hp	20 hp	25 hp	30 hp
Short-circuit protection device for contactors without thermal overload relay - Motor protection excluded												
High fault current		100 kA										
Fuse rating		30 A		60 A			100 A		150 A		200 A	
Fuse type, 600 V		J										
Maximum electrical switching frequency												
For general use		600 cycles/h										
For motor use		1200 cycles/h										

(1) For the corresponding kW/A or hp/A values of 1500 r.p.m, 50 Hz or 1800 r.p.m, 60 Hz, 3-phase motors, see "Motor rated operational powers and currents".

# AFS09 ... AFS96 3-pole contactors for safety applications

## Technical data

### General technical data

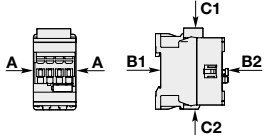
Contactors types	AC / DC operated	AFS09	AFS12	AFS16	AFS26	AFS30	AFS38
Rated insulation voltage Ui		690 V					
acc. to IEC 60947-4-1		600 V					
acc. to UL / CSA		6 kV					
Rated impulse withstand voltage Uimp.		6 kV					
Electromagnetic compatibility		Devices complying with IEC 60947-1 / EN 60947-1 - Environments A and B					
Ambient air temperature close to contactor							
Operation	Fitted with thermal overload relay	-40 ... +60 °C					
	Without thermal overload relay	-40 ... +70 °C					
Storage		-60 ... +80 °C					
Climatic withstand		Category B according to IEC 60947-1 Annex Q					
Maximum operating altitude (without derating)		3000 m					
Mechanical durability							
Number of operating cycles		10 million operating cycles					
Maximum switching frequency		3600 cycles/h					
Shock withstand							
acc. to IEC 60068-2-27 and EN 60068-2-27							
Mounting position 1	Shock direction	1/2 sinusoidal shock for 11 ms: no change in contact position, closed or open position					
	A	30 g					
	B1	25 g closed position / 5 g open position					
	B2	15 g					
	C1	25 g					
	C2	25 g					
Vibration withstand		5 ... 300 Hz					
acc. to IEC 60068-2-6		4 g Closed position / 2 g Open position					

### Mounting characteristics and conditions for use

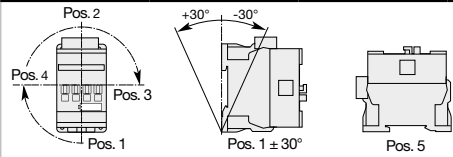
Contactors types	AC / DC operated	AFS09	AFS12	AFS16	AFS26	AFS30	AFS38
Mounting positions							
Mounting distances		The contactors can be assembled side by side					
Fixing							
On rail according to IEC 60715, EN 60715		35 x 7.5 mm or 35 x 15 mm					
By screws (not supplied)		2 x M4 screws placed diagonally					

## AFS09 ... AFS38 3-pole contactors for safety applications

### Technical data

#### Magnet system characteristics for AFS09 ... AFS38 contactors - AC / DC operated

Contactor types	AC / DC operated	AFS09	AFS12	AFS16	AFS26	AFS30	AFS38
Coil operating limits acc. to IEC 60947-4-1	AC supply	At $\theta \leq 60^\circ\text{C}$ $0.85 \times U_c \text{ min} \dots 1.1 \times U_c \text{ max}$ . At $\theta \leq 70^\circ\text{C}$ $0.85 \times U_c \text{ min} \dots U_c \text{ max}$ .					
	DC supply	at $\theta \leq 60^\circ\text{C}$ $0.85 \times U_c \text{ min} \dots 1.1 \times U_c \text{ max}$ at $\theta \leq 70^\circ\text{C}$ $0.85 \times U_c \text{ min} \dots U_c \text{ max}$					
AC control voltage 50/60 Hz							
Rated control circuit voltage $U_c$		24 ... 250 V AC					
Coil consumption	Average pull-in value	50 VA					
	Average holding value	2.2 VA / 2 W					
DC control voltage							
Rated control circuit voltage $U_c$		20 ... 250 V DC					
Coil consumption	Average pull-in value	50 W					
	Average holding value	2 W					
PLC-output control		AFS...30-22-11 not suitable for direct control by PLC-output.					
Drop-out voltage		$\leq 60\% U_c \text{ min}$ .					
Operating time							
Between coil energization and:	N.O. contact closing	40 ... 95 ms					
	N.C. contact opening	38 ... 90 ms					
Between coil de-energization and:	N.O. contact opening	11 ... 95 ms (1)					
	N.C. contact closing	13 ... 98 ms					

(1) AFS09 ... AFS38  $\leq 35$  ms for  $20^\circ\text{C} \leq \theta \leq 70^\circ\text{C}$

#### Magnet System Characteristics for AFS09Z ... AFS38Z contactors 24V DC operated - designed for PLC - coil 30

Contactor types	DC operated	AFS09Z	AFS12Z	AFS16Z	AFS26Z	AFS30Z	AFS38Z
Coil operating limits acc. to IEC 60947-4-1	DC supply	at $\theta \leq 60^\circ\text{C}$ $0.85 \dots 1.1 \times U_c$ at $\theta \leq 70^\circ\text{C}$ $U_c$					
DC control voltage							
Rated control circuit voltage $U_c$		24 V DC					
Coil consumption	Average pull-in value	6 W					
	Average holding value	1.7 W					
PLC-output control		$\geq 250$ mA 24 V DC for PLCs and safety PLCs using broken wire detection					
Drop-out voltage		$\leq 60\% U_c \text{ min}$ .					
Operating time							
Between coil energization and:	N.O. contact closing	27 ... 53 ms					
	N.C. contact opening	20 ... 35 ms					
Between coil de-energization and:	N.O. contact opening	17 ... 29 ms					
	N.C. contact closing	22 ... 57 ms					

# AFS40 ... AFS96 3-pole contactors for safety applications

## Technical data

### General technical data

Contactor types	AC / DC operated	AFS40	AFS52	AFS65	AFS80	AFS96
Rated insulation voltage Ui					1000 V	
acc. to IEC 60947-4-1		690 V				
acc. to UL / CSA		600 V				
Rated impulse withstand voltage Uimp.					6 kV	
Electromagnetic compatibility		Devices complying with IEC 60947-1 / EN 60947-1 - Environments A and B				
Ambient air temperature close to contactor						
Operation	Fitted with thermal overload relay	-40...+70 °C				
	Without thermal overload relay	-40...+70 °C				
Storage		-60...+80 °C				
Climatic withstand		Category B according to IEC 60947-1 Annex Q				
Maximum operating altitude (without derating)		3000 m				
Mechanical durability						
Number of operating cycles		10 million operating cycles				
Maximum switching frequency		3600 cycles/h				
Shock withstand						
acc. to IEC 60068-2-27 and EN 60068-2-27						
Mounting position 1	Shock direction	1/2 sinusoidal shock for 11 ms: no change in contact position, closed or open position				
	A	25 g				
	B1	25 g closed position / 5 g open position				
	B2	15 g				
	C1	25 g				
	C2	25 g				
Vibration withstand		5 ... 300 Hz				
acc. to IEC 60068-2-6		3 g Closed position / 3 g Open position				

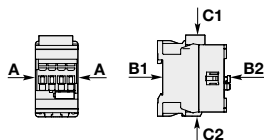

### Magnet system characteristics for AFS40 ... AFS96 contactors - AC / DC operated

Contactor types	AC / DC operated	AFS40	AFS52	AFS65	AFS80	AFS96
Coil operating limits	AC supply	At $\theta \leq 70\text{ °C}$ 0.85 x Uc min ... 1.1 x Uc max.				
acc. to IEC 60947-4-1	DC supply	at $\theta \leq 70\text{ °C}$ 0.85 x Uc min ... 1.1 x Uc max				
AC control voltage 50/60 Hz						
Rated control circuit voltage Uc		24 ... 250 V AC				
Coil consumption	Average pull-in value	25 VA			40 VA	
	Average holding value	4 VA / 2 W				
DC control voltage						
Rated control circuit voltage Uc		20 ... 250 V DC				
Coil consumption	Average pull-in value	25 W			40 W	
	Average holding value	2 W				
PLC-output control		AFS...30-22-11 not suitable for direct control by PLC-output.				
Drop-out voltage		$\leq 60\%$ Uc min.				
Operating time						
Between coil energization and:	N.O. contact closing	42 ... 100 ms				
	N.C. contact opening	38 ... 95 ms				
Between coil de-energization and:	N.O. contact opening	17 ... 100 ms				
	N.C. contact closing	19 ... 105 ms				

### Mounting characteristics and conditions for use

















Contactor types	AC / DC operated	AFS40	AFS52	AFS65	AFS80	AFS96
Mounting positions						
Mounting distances		The contactors can be assembled side by side				
Fixing						
On rail according to IEC 60715, EN 60715		35 x 7.5 mm or 35 x 15 mm			35 x 15 mm	
By screws (not supplied)		2 x M4 or 2 x M6 screws placed diagonally				



# AFS09 ... AFS96 3-pole contactors for safety applications

## Technical data

### Connecting characteristics

Contactor types	AC / DC operated	AFS09	AFS12	AFS16	AFS26	AFS30	AFS38	AFS40	AFS52	AFS65	AFS80	AFS96		
Main terminals		 Screw terminals with cable clamp						 Screw terminals with double connector 2 x (9.3 width x 7.9/10.3 depth)		 Screw terminals with double connector 2 x (12.4 width x 9.3/11.1 depth)				
Connection capacity (min. ... max.)														
Main conductors (poles)														
 Rigid	Solid ( $\leq 4 \text{ mm}^2$ )	1 x	1 ... 6 mm <sup>2</sup>			2.5 ... 10 mm <sup>2</sup>			6 ... 35 mm <sup>2</sup>		6 ... 70 mm <sup>2</sup>			
 Stranded ( $6 > 6 \text{ mm}^2$ )		2 x	1 ... 6 mm <sup>2</sup>			2.5 ... 10 mm <sup>2</sup>			6 ... 35 mm <sup>2</sup>		6 ... 50 mm <sup>2</sup>			
 Flexible with non insulated ferrule		1 x	0.75 ... 6 mm <sup>2</sup>			1.5 ... 10 mm <sup>2</sup>			4 ... 35 mm <sup>2</sup>		6 ... 50 mm <sup>2</sup>			
 Flexible with non insulated ferrule		2 x	0.75 ... 6 mm <sup>2</sup>			1.5 ... 10 mm <sup>2</sup>			4 ... 35 mm <sup>2</sup>		6 ... 50 mm <sup>2</sup>			
 Flexible with insulated ferrule		1 x	0.75 ... 4 mm <sup>2</sup>			1.5 ... 10 mm <sup>2</sup>			4 ... 35 mm <sup>2</sup>		6 ... 50 mm <sup>2</sup>			
 Flexible with insulated ferrule		2 x	0.75 ... 2.5 mm <sup>2</sup>			1.5 ... 4 mm <sup>2</sup>			4 ... 35 mm <sup>2</sup>		6 ... 50 mm <sup>2</sup>			
 Bars or lugs		L <	9.6 mm			12.5 mm			9.2 mm		12.2 mm			
Connection capacity acc. to UL/CSA		1 or 2 x	AWG 16 ... 10			AWG 14 ... 8			AWG 10 ... 2		AWG 6 ... 1			
Stripping length			10 mm			14 mm			16 mm		17 mm			
Tightening torque			1.5 Nm / 13 lb.in			2.5 Nm / 22 lb.in			4 Nm / 35 lb.in		6 Nm / 53 lb.in			
Auxiliary conductors (built-in auxiliary terminals + coil terminals)														
 Rigid solid		1 x	1 ... 2.5 mm <sup>2</sup>											
 Rigid solid		2 x	1 ... 2.5 mm <sup>2</sup>											
 Flexible with non insulated ferrule		1 x	0.75 ... 2.5 mm <sup>2</sup>											
 Flexible with non insulated ferrule		2 x	0.75 ... 2.5 mm <sup>2</sup>											
 Flexible with insulated ferrule		1 x	0.75 ... 2.5 mm <sup>2</sup>											
 Flexible with insulated ferrule		2 x	0.75 ... 1.5 mm <sup>2</sup>											
 Bars or lugs		L <	8 mm											
Connection capacity acc. to UL/CSA		1 or 2 x	AWG 18 ... 14											
Stripping length			10 mm											
Tightening torque														
Coil terminals			1.2 Nm / 11 lb.in											
Built-in auxiliary terminals			1.2 Nm / 11 lb.in											
Degree of protection acc. to IEC 60947-1 / EN 60947-1 and IEC 60529 / EN 60529			IP20					IP10						
Main terminals			IP20					IP10						
Coil terminals			IP20											
Built-in auxiliary terminals			IP20											
Screw terminals			Delivered in open position, screws of unused terminals must be tightened											
Main terminals			M3.5			M4			M6			M8		
		Screwdriver type	Flat $\varnothing$ 5.5 / Pozidriv 2			Flat $\varnothing$ 6.5 / Pozidriv 2						hexagon socket (s = 4 mm)		
Coil terminals			M3.5											
		Screwdriver type	Flat $\varnothing$ 5.5 / Pozidriv 2											
Built-in auxiliary terminals			M3.5											
		Screwdriver type	Flat $\varnothing$ 5.5 / Pozidriv 2											

# AFS09 ... AFS96 3-pole contactors for safety applications

## Technical data

### Built-in auxiliary contacts according to IEC

Contactor types	AC / DC operated	AFS09	AFS12	AFS16	AFS26	AFS30	AFS38	AFS40	AFS52	AFS65	AFS80	AFS96
Rated operational voltage Ue max.		690 V										
Rated frequency (without derating)		50 / 60 Hz										
Conventional free air thermal current Ith - θ ≤ 40 °C		16 A										
le / Rated operational current AC-15												
acc. to IEC 60947-5-1	24-127 V 50/60 Hz	6 A										
	220-240 V 50/60 Hz	4 A										
	400-440 V 50/60 Hz	3 A										
	500 V 50/60 Hz	2 A										
	690 V 50/60 Hz	2 A										
Making capacity AC-15		10 x le AC-15 acc. to IEC 60947-5-1										
Breaking capacity AC-15		10 x le AC-15 acc. to IEC 60947-5-1										
le / Rated operational current DC-13												
acc. to IEC 60947-5-1	24 V DC	6 A / 144 W										
	48 V DC	2.8 A / 134 W										
	72 V DC	1 A / 72 W										
	110 V DC	0.55 A / 60 W										
	125 V DC	0.55 A / 69 W										
	220 V DC	0.27 A / 60 W										
	250 V DC	0.27 A / 68 W										
	400 V DC	0.15 A / 60 W										
	500 V DC	0.13 A / 65 W										
	600 V DC	0.1 A / 60 W										
Short-circuit protection device gG type fuse		10 A										
Rated short-time withstand current Icw	for 1.0 s	100 A										
	for 0.1 s	140 A										
Minimum switching capacity with failure rate acc. to IEC 60947-5-4		12 V / 3 mA										
		10 <sup>-7</sup>										
Non-overlapping time between N.O. and N.C. contacts		≥ 2 ms										
Power dissipation per pole at 6 A		0.1 w										
Maximum electrical switching frequency	AC-15	1200 cycles/h										
	DC-13	900 cycles/h										
Mechanically linked contacts acc. to annex L of IEC 60947-5-1		Built-in N.O. or N.C. auxiliary contacts and additional N.O. or N.C. auxiliary contacts (CAL4 aux. contact blocks) are mechanically linked contacts.										
Mirror contacts acc. to annex F of IEC 60947-4-1		Built-in N.C. auxiliary contacts or additional N.C. auxiliary contacts (CAL4 aux. contact blocks) are mirror contacts.										

### Built-in auxiliary contacts according to UL / CSA

Contactor types	AC / DC operated	AFS09	AFS12	AFS16	AFS26	AFS30	AFS38	AFS40	AFS52	AFS65	AFS80	AFS96
Maximum operational voltage		600 V AC, 600 V DC										
Pilot duty		A600, Q600										
AC thermal rated current		10 A										
AC maximum volt-ampere making		7200 VA										
AC maximum volt-ampere breaking		720 VA										
DC thermal rated current		2.5 A										
DC maximum volt-ampere making-breaking		69 VA										

### 3-pole contactors for safety applications

#### Electrical durability

#### Electrical durability for AC-1 utilization category - $U_e \leq 690\text{ V}$

Switching non-inductive or slightly inductive loads. The breaking current  $I_c$  for AC-1 is equal to the rated operational current of the load.

Ambient temperature and maximum electrical switching frequency: see "Technical data".

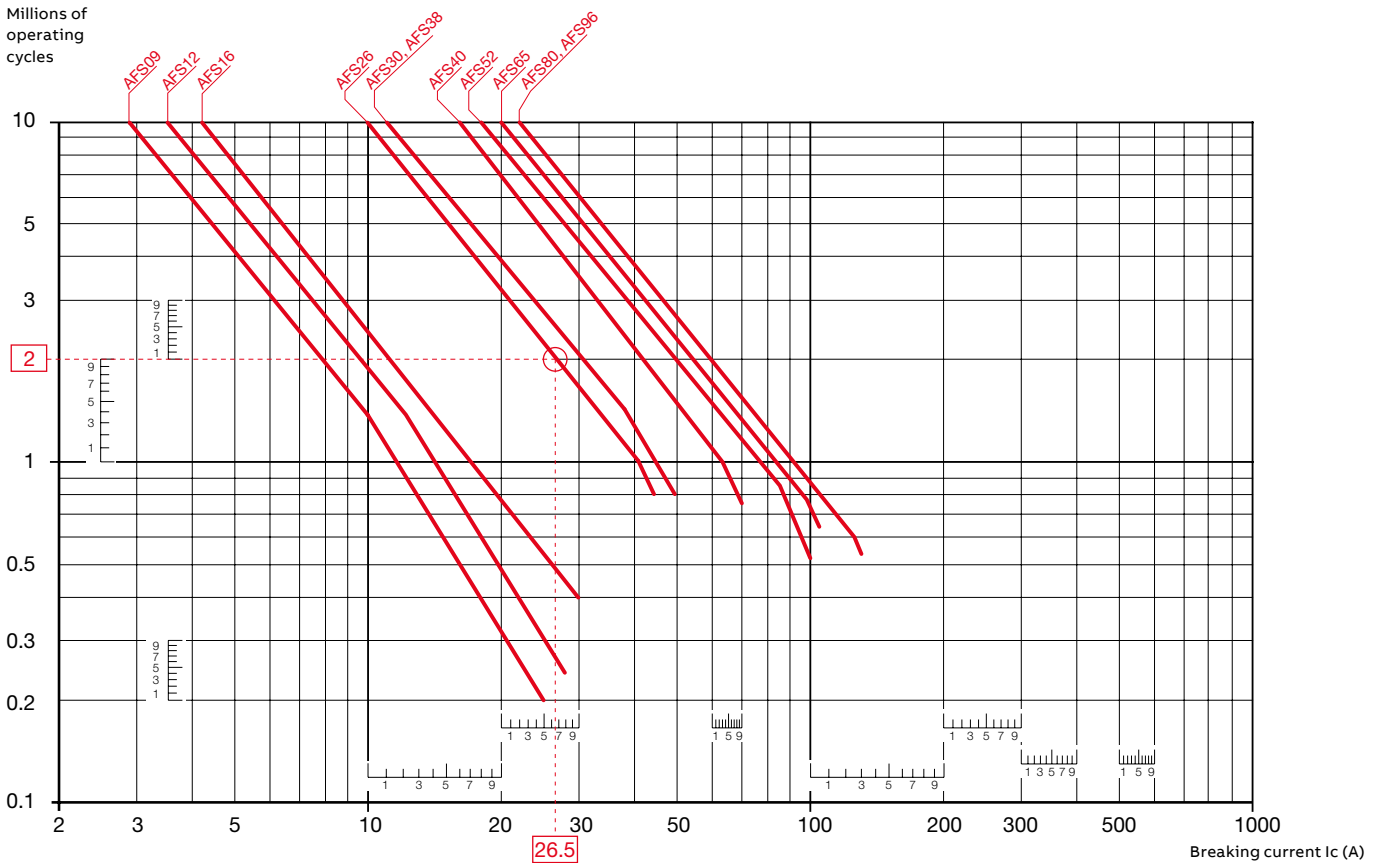

#### Example:

$I_c / AC-1 = 26.5\text{ A}$  – Electrical durability required = 2 millions operating cycles.

Using the AC-1 curves above select the AFS26 contactor at intersection "O" (26.5 A / 2 millions operating cycles).

### 3-pole contactors for safety applications

#### Electrical durability

**Electrical durability for AC-3 utilization category -  $U_e \leq 440$  V.**

Switching cage motors: starting and switching off running motors. The breaking current  $I_c$  for AC-3 is equal to the rated operational current  $I_e$  ( $I_e$  = motor full load current).

Ambient temperature and maximum electrical switching frequency: see "Technical data".

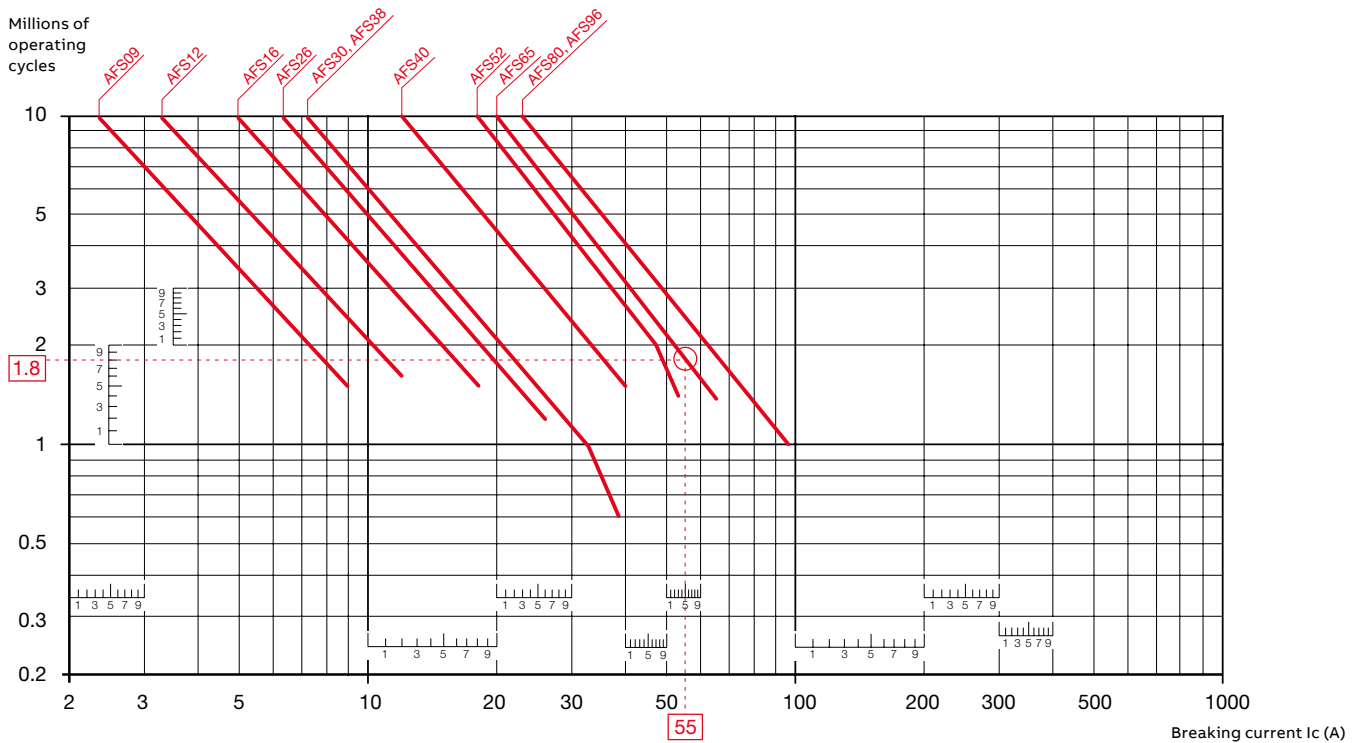

**Example:**

Motor power 30 kW for AC-3 -  $U_e = 400$  V and  $I_e = 55$  A utilization – Electrical durability required = 1.8 million operating cycles. For AC-3:  $I_c = I_e$ . Select the AFS65 contactor at intersection "O" (55 A / 1.8 million operating cycles) on the curves (AC-3 -  $U_e \leq 440$  V).

# 3-pole contactors for safety applications

## Electrical durability

### Electrical durability for AC-3 utilization category - 440 V < Ue ≤ 690 V.

Switching cage motors: starting and switching off running motors. The breaking current Ic for AC-3 is equal to the rated operational current Ie (Ie = motor full load current).

Ambient temperature and maximum electrical switching frequency: see "Technical data".

Millions of operating cycles

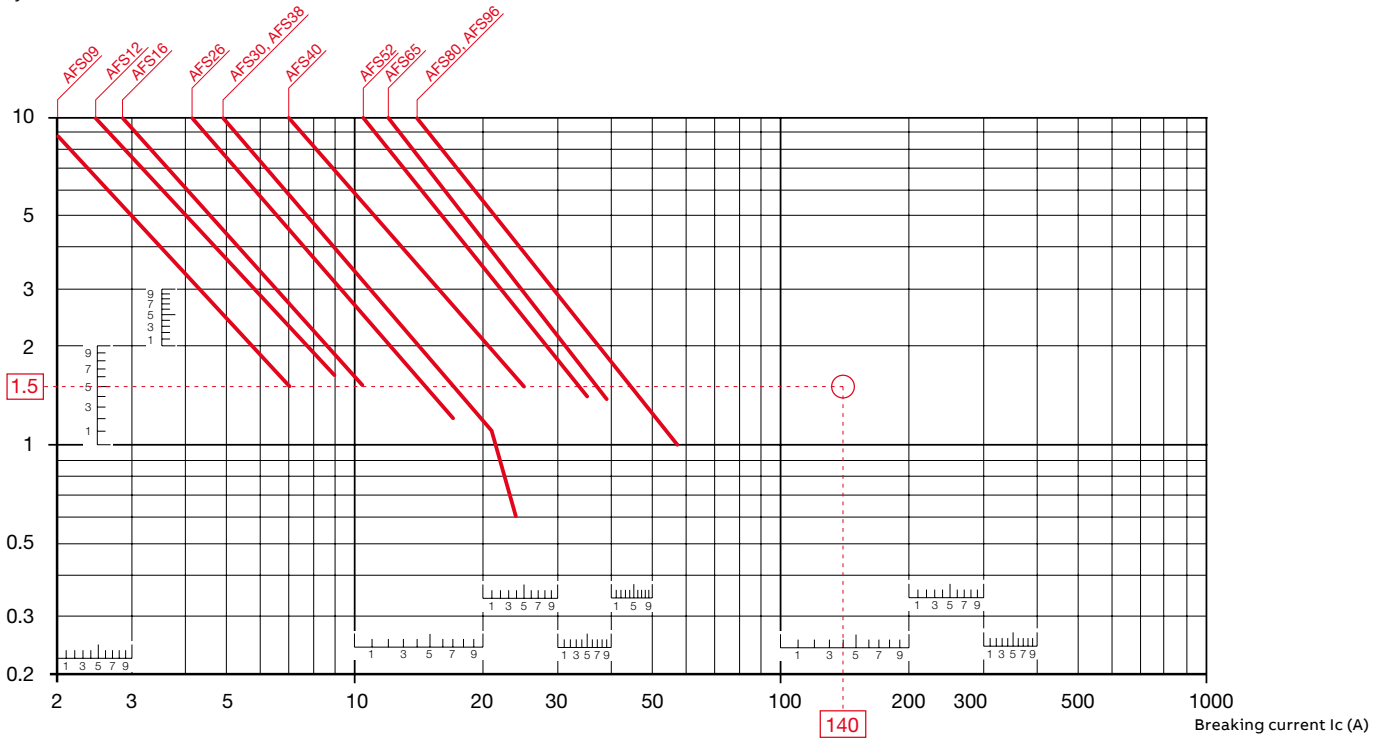

# 3-pole contactors for safety applications

## Electrical durability

**Electrical durability for AC-2 or AC-4 utilization category -  $U_e \leq 440\text{ V}$**

**Ambient temperature  $\leq 60\text{ }^\circ\text{C}$  for AFS09 ... AFS96**

Switching cage motors: starting, reverse operation and step-by-step operation. The breaking current  $I_c$  is equal to  $2.5 \times I_e$  for AC-2 and  $6 \times I_e$  for AC-4, keeping in mind that  $I_e$  is the motor rated operational current ( $I_e$  = motor full-load current). Maximum electrical switching frequency: see "Technical data".

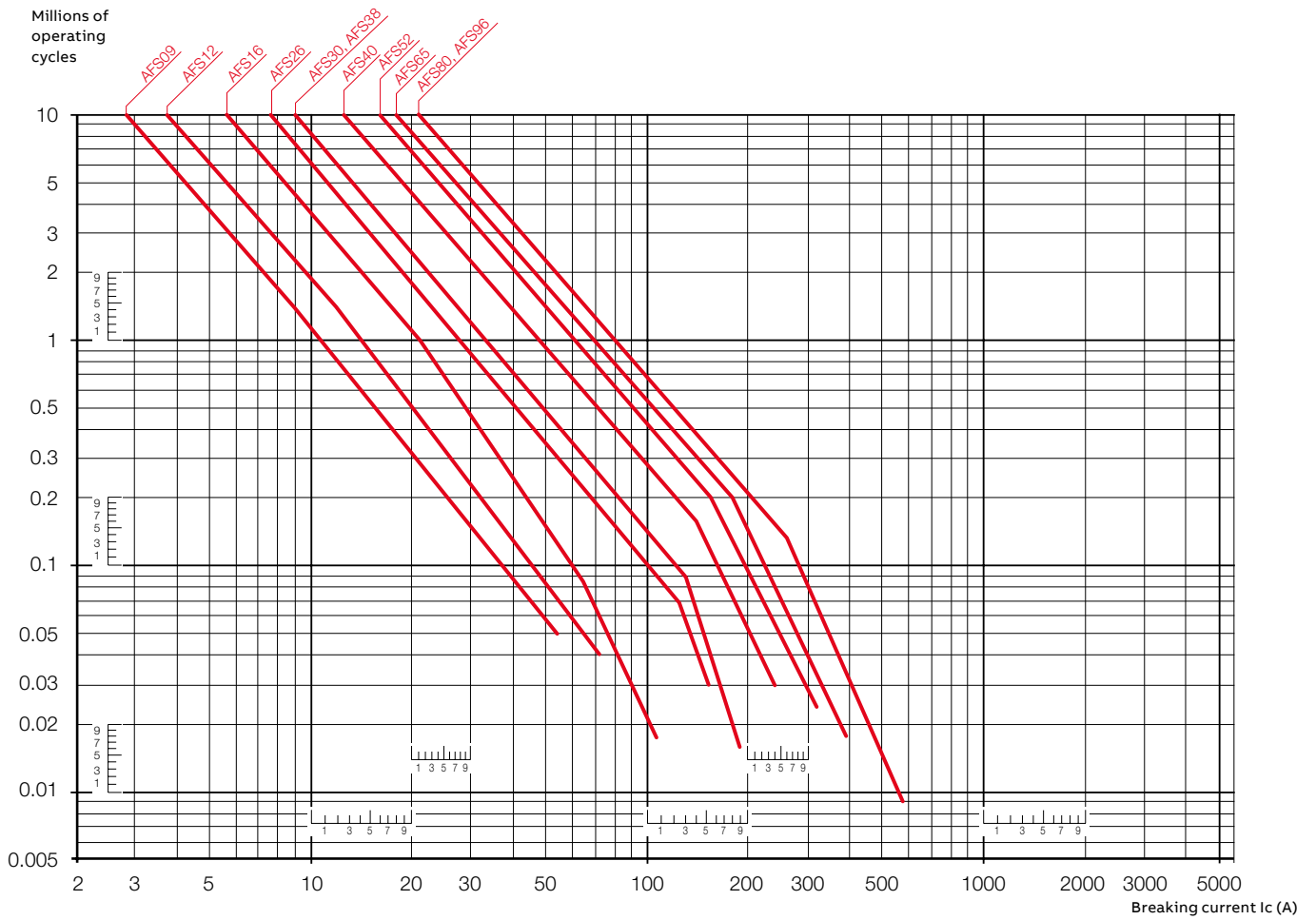

03



# 3-pole contactors for safety applications

## Electrical durability

**Electrical durability for AC-2 or AC-4 utilization category - 440 V < Ue ≤ 690 V**

**Ambient temperature ≤ 60 °C for AFS09 ... AFS96**

Switching cage motors: starting, reverse operation and step-by-step operation. The breaking current  $I_c$  is equal to  $2.5 \times I_e$  for AC-2 and  $6 \times I_e$  for AC-4, keeping in mind that  $I_e$  is the motor rated operational current ( $I_e$  = motor full load current).

Maximum electrical switching frequency: see "Technical data".

Millions of operating cycles

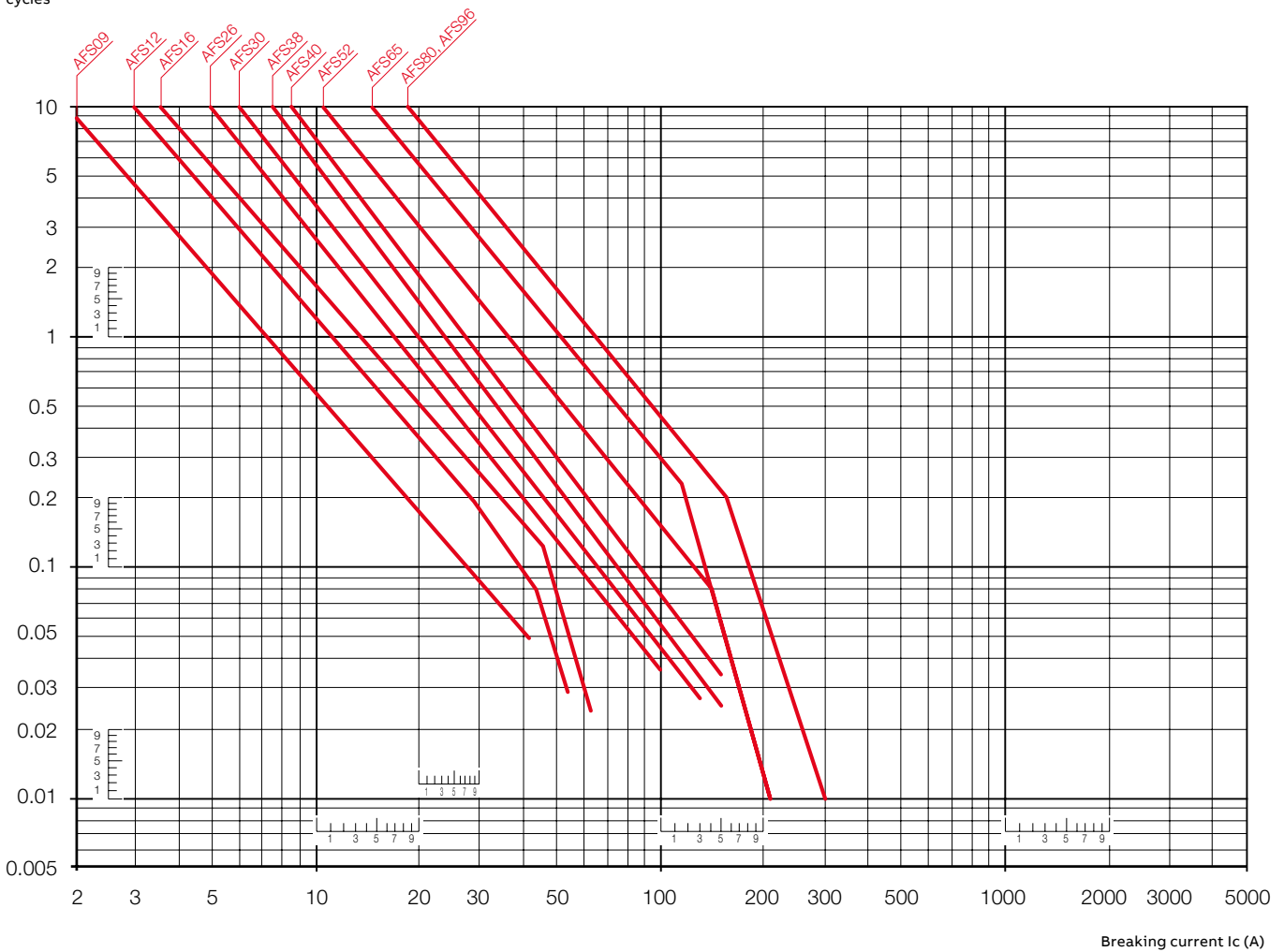

—  
**Notes**

A large rectangular area filled with a grid of small, light gray dotted lines, intended for handwritten notes.



# AF and EK 4-pole contactors

## 3/132 Overview

### Ordering details

#### 25 to 125 A AC-1

3/134	AF09 ... AF38	AC / DC operated
3/135	AF09Z ... AF16Z	24 V DC operated designed for PLC
3/136	AF09Z ... AF38Z	AC / DC operated for specific applications
3/137	AF40 ... AF80	AC / DC operated
3/138	Contactors and main accessories	

#### 160 to 525 A AC-1

3/139	AF116 ... AF140	AC / DC operated
3/140	AF190 ... AF370	AC / DC operated
3/141	Contactors and main accessories	
3/142	AF116 ... AF140	AC / DC operated - with 1 N.O. + 1 N.C.
3/143	AF190 ... AF370	AC / DC operated - with 1 N.O. + 1 N.C.
3/144	Contactors and main accessories	
3/145	AF116 ... AF140	AC / DC operated - with 2 N.O. + 2 N.C.
3/146	AF190 ... AF370	AC / DC operated - with 2 N.O. + 2 N.C.
3/147	Contactors and main accessories	

#### 800 to 1000 A AC-1

3/148	EK550, EK1000	AC operated - with 1 N.O. + 1 N.C.
3/149	EK550, EK1000	DC operated - with 2 N.O. + 1 N.C.
3/150	EK550, EK1000	AC operated - with 2 N.O. + 2 N.C.
3/151	Main accessories	

## 3/153 Technical data

## 3/165 Electrical durability

## 3/404 Voltage code table



For direct product details information, use product type or order code, ex:

- [www.abb.com/productdetails/AF09-30-10-13](http://www.abb.com/productdetails/AF09-30-10-13)
- or [www.abb.com/productdetails/1SBL137001R1310](http://www.abb.com/productdetails/1SBL137001R1310)

## 4-pole contactors



IEC	AC-1 Rated operational current	$\theta \leq 40\text{ }^\circ\text{C}$ , 690 V	A	25	30	45	55	70	100	125
UL/CSA	General use rating	600 V	A	25	30	45	55	60	80	105
AC / DC Control supply			Type	<b>AF09</b>	<b>AF16</b>	<b>AF26</b>	<b>AF38</b>	<b>AF40</b>	<b>AF52</b>	<b>AF80</b>
AC Control supply			Type	<b>AF09</b>	<b>AF16</b>	<b>AF26</b>	<b>AF38</b>	<b>AF40</b>	<b>AF52</b>	<b>AF80</b>
DC Control supply			Type	<b>AF09</b>	<b>AF16</b>	<b>AF26</b>	<b>AF38</b>	<b>AF40</b>	<b>AF52</b>	<b>AF80</b>
IEC	AC-1 Rated operational current 690 V	$\theta \leq 40\text{ }^\circ\text{C}$	A	25	30	45	55	70	100	125
		$\theta \leq 60\text{ }^\circ\text{C}$ (1)	A	25	30	40	45	60	80	105
		$\theta \leq 70\text{ }^\circ\text{C}$	A	22	26	32	37	50	70	90
	With conductor cross sectional area		mm <sup>2</sup>	4	6	10	16	35	35	50
	Rated operational voltage Ue max.		V	690	690	690	690	690	690	690

(1)  $\theta \leq 55\text{ }^\circ\text{C}$  for EK550, EK1000 contactors

### Main accessories

Auxiliary contact blocks	Front mounting
	Side mounting
Timers	Electronic
Interlocking units	Mechanical
	Mechanical / Electrical
Surge suppressors	Varistor + RC (AC / DC)

<b>CA4-10</b> (1 x N.O.), <b>CA4-01</b> (1 x N.C.)	
<b>CAL4-11</b> (1 x N.O. + 1 x N.C.)	
<b>TEF4-ON</b> <b>TEF4-OFF</b>	
<b>VM4</b>	<b>VM96-4</b>
<b>VEM4</b>	
Built-in surge protection	





160	200	275	350	400	500	525	800	1000
160	175	230	250	300	350	420	540	—
<b>AF116</b>	<b>AF140</b>	<b>AF190</b>	<b>AF205</b>	<b>AF265</b>	<b>AF305</b>	<b>AF370</b>	—	—
<b>AF116</b>	<b>AF140</b>	<b>AF190</b>	<b>AF205</b>	<b>AF265</b>	<b>AF305</b>	<b>AF370</b>	<b>EK550</b>	<b>EK1000</b>
<b>AF116</b>	<b>AF140</b>	<b>AF190</b>	<b>AF205</b>	<b>AF265</b>	<b>AF305</b>	<b>AF370</b>	<b>EK550</b>	<b>EK1000</b>
160	200	275	350	400	500	525	800	1000
145	175	250	300	350	400	425	650	800
130	160	200	240	290	325	350	575	720
70	95	150	240	240	300	2 x 185	2 x 240	2 x 300
690	690	1000	1000	1000	1000	1000	1000	1000

<b>CAL19-11 (1 x N.O. + 1 x N.C.)</b>	<b>CAL16-11 (1 x N.O. + 1 x N.C.)</b>
<b>VM19 (for same size contactors)</b>	<b>VH800</b>
	<b>RC-EH800</b>

03



# AF09 ... AF38 4-pole contactors

25 to 55 A AC-1  
AC / DC operated



AF09-40-00



AF26-40-00

AF09 ... AF38 4-pole contactors are mainly used for controlling non-inductive or slightly inductive loads (i.e. resistance furnaces...) and generally for controlling power circuits up to 690 V AC and 440 V DC. These contactors are of the block type design with 4 main poles.

- control circuit: AC or DC operated with electronic coil interface accepting a wide control voltage range (e.g. 100...250 V AC and DC), only 4 control voltage ranges covering 24...500 V 50/60 Hz and 20...500 V DC
  - can manage large control voltage variations
  - reduced panel energy consumption
  - very distinct closing and opening.
- built-in surge suppression
- add-on auxiliary contact blocks for front or side mounting and a wide range of accessories.

IEC	UL/CSA	Rated control circuit voltage Uc min. ... Uc max.		Auxiliary contacts fitted	Type	Order code	Weight
Rated operational current $\theta \leq 40^\circ\text{C}$ AC-1	General use rating 600 V AC						Pkg (1 pce) kg
A	A	V 50/60 Hz	V DC				
<b>4 N.O. main poles</b>							
25	25	24...60	20...60 (1)	0 0	AF09-40-00-11	1SBL137201R1100	0.270
		48...130	48...130	0 0	AF09-40-00-12	1SBL137201R1200	0.270
		100...250	100...250	0 0	AF09-40-00-13	1SBL137201R1300	0.270
		250...500	250...500	0 0	AF09-40-00-14	1SBL137201R1400	0.310
30	30	24...60	20...60 (1)	0 0	AF16-40-00-11	1SBL177201R1100	0.270
		48...130	48...130	0 0	AF16-40-00-12	1SBL177201R1200	0.270
		100...250	100...250	0 0	AF16-40-00-13	1SBL177201R1300	0.270
		250...500	250...500	0 0	AF16-40-00-14	1SBL177201R1400	0.310
45	45	24...60	20...60 (1)	0 0	AF26-40-00-11	1SBL237201R1100	0.360
		48...130	48...130	0 0	AF26-40-00-12	1SBL237201R1200	0.360
		100...250	100...250	0 0	AF26-40-00-13	1SBL237201R1300	0.360
		250...500	250...500	0 0	AF26-40-00-14	1SBL237201R1400	0.400
55	55	24...60	20...60 (1)	0 0	AF38-40-00-11	1SBL297201R1100	0.360
		48...130	48...130	0 0	AF38-40-00-12	1SBL297201R1200	0.360
		100...250	100...250	0 0	AF38-40-00-13	1SBL297201R1300	0.360
		250...500	250...500	0 0	AF38-40-00-14	1SBL297201R1400	0.400
<b>2 N.O. + 2 N.C. main poles</b>							
25	25	24...60	20...60 (1)	0 0	AF09-22-00-11	1SBL137501R1100	0.270
		48...130	48...130	0 0	AF09-22-00-12	1SBL137501R1200	0.270
		100...250	100...250	0 0	AF09-22-00-13	1SBL137501R1300	0.270
		250...500	250...500	0 0	AF09-22-00-14	1SBL137501R1400	0.310
30	30	24...60	20...60 (1)	0 0	AF16-22-00-11	1SBL177501R1100	0.270
		48...130	48...130	0 0	AF16-22-00-12	1SBL177501R1200	0.270
		100...250	100...250	0 0	AF16-22-00-13	1SBL177501R1300	0.270
		250...500	250...500	0 0	AF16-22-00-14	1SBL177501R1400	0.310
45	45	24...60	20...60 (1)	0 0	AF26-22-00-11	1SBL237501R1100	0.360
		48...130	48...130	0 0	AF26-22-00-12	1SBL237501R1200	0.360
		100...250	100...250	0 0	AF26-22-00-13	1SBL237501R1300	0.360
		250...500	250...500	0 0	AF26-22-00-14	1SBL237501R1400	0.400
55	55	24...60	20...60 (1)	0 0	AF38-22-00-11	1SBL297501R1100	0.360
		48...130	48...130	0 0	AF38-22-00-12	1SBL297501R1200	0.360
		100...250	100...250	0 0	AF38-22-00-13	1SBL297501R1300	0.360
		250...500	250...500	0 0	AF38-22-00-14	1SBL297501R1400	0.400

(1) AF...-40-...-11 and AF...-22-...-11 not suitable for direct control by PLC-output.

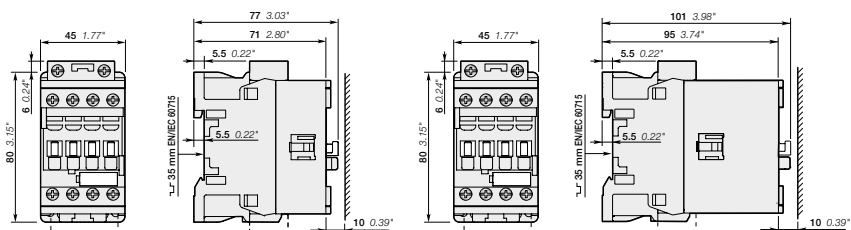

AF09, AF16

AF26, AF38

Main dimensions mm, inches

# AF09Z ... AF16Z 4-pole contactors

25 to 30 A AC-1

24 V DC operated designed for PLC

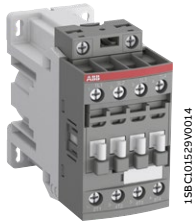

AF09Z-40-00

AF09Z ... AF16Z 4-pole contactors are mainly used for controlling non-inductive or slightly inductive loads (i.e. resistance furnaces...) and generally for controlling power circuits up to 690 V AC and 440 V DC. These contactors are of the block type design with 4 main poles.

- control circuit: 24 V DC operated with electronic coil interface allowing low holding consumption up to 1.7 W and reduced panel energy consumption
  - allow direct control by PLC-output  $\geq 250$  mA 24 V DC
  - very distinct closing and opening
- built-in surge suppression
- add-on auxiliary contact blocks for front or side mounting and a wide range of accessories.

IEC	UL/CSA	Rated control circuit voltage Uc	Auxiliary contacts fitted	Type	Order code	Weight
Rated operational current $\theta \leq 40^\circ\text{C}$ AC-1 A	General use rating 600 V AC A	V DC				Pkg (1 pce) kg

### 4 N.O. main poles

Rated current (A)	UL/CSA rating (A)	Rated control circuit voltage (V)	Auxiliary contacts	Type	Order code	Weight (kg)
25	25	24	0 0	AF09Z-40-00-30	1SBL136201R3000	0.430
30	30	24	0 0	AF16Z-40-00-30	1SBL176201R3000	0.430

### 2 N.O. + 2 N.C. main poles

Rated current (A)	UL/CSA rating (A)	Rated control circuit voltage (V)	Auxiliary contacts	Type	Order code	Weight (kg)
25	25	24	0 0	AF09Z-22-00-30	1SBL136501R3000	0.430
30	30	24	0 0	AF16Z-22-00-30	1SBL176501R3000	0.430

Note: AF..Z contactors with 24 V DC control voltage need to respect the connection polarities indicated close to the coil terminals: A1+ for the positive pole and A2- for the negative pole.

### Main dimensions mm, inches

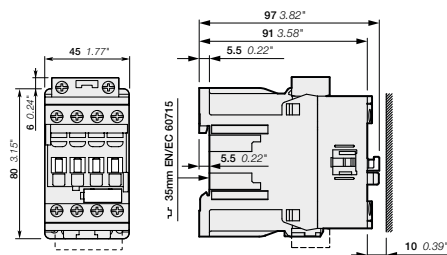

AF09Z, AF16Z

# AF09Z ... AF38Z 4-pole contactors

25 to 55 A AC-1

AC / DC operated for specific applications



AF09Z-40-00



AF26Z-40-00

AF09Z ... AF38Z 4-pole contactors are mainly used for controlling non-inductive or slightly inductive loads (i.e. resistance furnaces...) and generally for controlling power circuits up to 690 V AC and 440 V DC. These contactors are of the block type design with 4 main poles.

- control circuit: AC or DC operated with electronic coil interface accepting a wide control voltage range (e.g. 100...250 V AC and DC), only 4 control voltage ranges covering 24...250 V 50/60 Hz and 12...250 V DC
  - can manage large control voltage variations
  - allow direct control by PLC-output  $\geq 24$  V DC 500 mA
  - reduced panel energy consumption
  - very distinct closing and opening
  - can withstand short voltage dips and voltage sags (SEMI F47-0706 conditions of use on request).
- built-in surge suppression
- add-on auxiliary contact blocks for front or side mounting and a wide range of accessories.

IEC	UL/CSA	Rated control circuit voltage Uc min. ... Uc max.		Auxiliary contacts fitted	Type	Order code	Weight
Rated operational current $\theta \leq 40^\circ\text{C}$ AC-1	General use rating 600 V AC						Pkg (1 pce)
A	A	V 50/60 Hz	V DC				kg

### 4 N.O. main poles

Rated operational current (A)	UL/CSA rating (A)	Uc min. (V)	Uc max. (V)	Control voltage (V)	Type	Order code	Weight (kg)
25	25	-	12...20	0 0	AF09Z-40-00-20	1SBL136201R2000	0.310
		24...60	20...60	0 0	AF09Z-40-00-21	1SBL136201R2100	0.310
		48...130	48...130	0 0	AF09Z-40-00-22	1SBL136201R2200	0.310
		100...250	100...250	0 0	AF09Z-40-00-23	1SBL136201R2300	0.310
30	30	-	12...20	0 0	AF16Z-40-00-20	1SBL176201R2000	0.310
		24...60	20...60	0 0	AF16Z-40-00-21	1SBL176201R2100	0.310
		48...130	48...130	0 0	AF16Z-40-00-22	1SBL176201R2200	0.310
		100...250	100...250	0 0	AF16Z-40-00-23	1SBL176201R2300	0.310
45	45	-	12...20	0 0	AF26Z-40-00-20	1SBL236201R2000	0.400
		24...60	20...60	0 0	AF26Z-40-00-21	1SBL236201R2100	0.400
		48...130	48...130	0 0	AF26Z-40-00-22	1SBL236201R2200	0.400
		100...250	100...250	0 0	AF26Z-40-00-23	1SBL236201R2300	0.400
55	55	-	12...20	0 0	AF38Z-40-00-20	1SBL296201R2000	0.400
		24...60	20...60	0 0	AF38Z-40-00-21	1SBL296201R2100	0.400
		48...130	48...130	0 0	AF38Z-40-00-22	1SBL296201R2200	0.400
		100...250	100...250	0 0	AF38Z-40-00-23	1SBL296201R2300	0.400

### 2 N.O. + 2 N.C. main poles

Rated operational current (A)	UL/CSA rating (A)	Uc min. (V)	Uc max. (V)	Control voltage (V)	Type	Order code	Weight (kg)
25	25	-	12...20	0 0	AF09Z-22-00-20	1SBL136501R2000	0.310
		24...60	20...60	0 0	AF09Z-22-00-21	1SBL136501R2100	0.310
		48...130	48...130	0 0	AF09Z-22-00-22	1SBL136501R2200	0.310
		100...250	100...250	0 0	AF09Z-22-00-23	1SBL136501R2300	0.310
30	30	-	12...20	0 0	AF16Z-22-00-20	1SBL176501R2000	0.310
		24...60	20...60	0 0	AF16Z-22-00-21	1SBL176501R2100	0.310
		48...130	48...130	0 0	AF16Z-22-00-22	1SBL176501R2200	0.310
		100...250	100...250	0 0	AF16Z-22-00-23	1SBL176501R2300	0.310
45	45	-	12...20	0 0	AF26Z-22-00-20	1SBL236501R2000	0.400
		24...60	20...60	0 0	AF26Z-22-00-21	1SBL236501R2100	0.400
		48...130	48...130	0 0	AF26Z-22-00-22	1SBL236501R2200	0.400
		100...250	100...250	0 0	AF26Z-22-00-23	1SBL236501R2300	0.400
55	55	-	12...20	0 0	AF38Z-22-00-20	1SBL296501R2000	0.400
		24...60	20...60	0 0	AF38Z-22-00-21	1SBL296501R2100	0.400
		48...130	48...130	0 0	AF38Z-22-00-22	1SBL296501R2200	0.400
		100...250	100...250	0 0	AF38Z-22-00-23	1SBL296501R2300	0.400

Note: Only AF..Z contactors with DC control voltage 12...20 V DC need to respect the connection polarities indicated close to the coil terminals: A1+ for the positive pole and A2- for the negative pole.

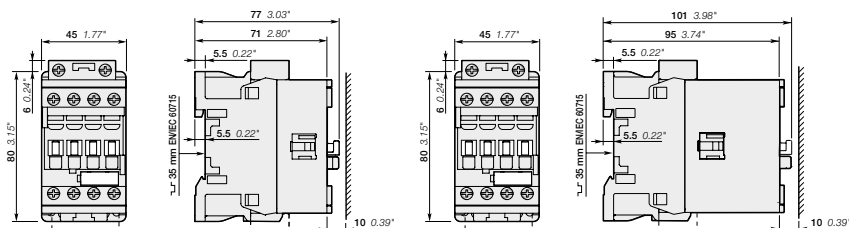

AF09Z, AF16Z

AF26Z, AF38Z

Main dimensions mm, inches

# AF40 ... AF80 4-pole contactors

70 to 125 A AC-1  
AC / DC operated



AF40-40-00

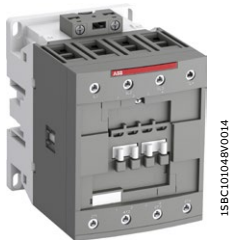

AF80-40-00

AF40 ... AF80 4-pole contactors are mainly used for controlling non-inductive or slightly inductive loads (i.e. resistance furnaces...) and generally for controlling power circuits up to 690 V AC and 440 V DC. These contactors are of the block type design with 4 main poles.

- control circuit: AC or DC operated with electronic coil interface accepting a wide control voltage range (e.g. 100...250 V AC and DC), only 4 control voltages ranges covering 24...500 V 50/60 Hz and 20...500 V DC
  - can manage large control voltage variations
  - reduced panel energy consumption
  - very distinct closing and opening
  - can withstand short voltage dips and voltage sags (SEMI F47-0706 conditions of use on request).
- built-in surge suppression
- add-on auxiliary contact blocks for front or side mounting and a wide range of accessories.

IEC	UL/CSA	Rated control circuit voltage Uc min. ... Uc max.		Auxiliary contacts fitted	Type	Order code	Weight
Rated operational current $\theta \leq 40^\circ\text{C}$ AC-1	General use rating 600 V AC	A	V 50/60 Hz	V DC			Pkg (1 pce) kg

### 4 N.O. main poles

Rated current	UL/CSA rating	Uc min.	Uc max.	Auxiliary contacts	Type	Order code	Weight
70	60	24...60	20...60	0 0	AF40-40-00-11	1SBL347201R1100	1.210
		48...130	48...130	0 0	AF40-40-00-12	1SBL347201R1200	1.210
		100...250	100...250	0 0	AF40-40-00-13	1SBL347201R1300	1.160
		250...500	250...500	0 0	AF40-40-00-14	1SBL347201R1400	1.160
100	80	24...60	20...60	0 0	AF52-40-00-11	1SBL367201R1100	1.210
		48...130	48...130	0 0	AF52-40-00-12	1SBL367201R1200	1.210
		100...250	100...250	0 0	AF52-40-00-13	1SBL367201R1300	1.160
		250...500	250...500	0 0	AF52-40-00-14	1SBL367201R1400	1.160
125	105	24...60	20...60	0 0	AF80-40-00-11	1SBL397201R1100	1.490
		48...130	48...130	0 0	AF80-40-00-12	1SBL397201R1200	1.490
		100...250	100...250	0 0	AF80-40-00-13	1SBL397201R1300	1.440
		250...500	250...500	0 0	AF80-40-00-14	1SBL397201R1400	1.440

### 2 N.O. + 2 N.C. main poles

Rated current	UL/CSA rating	Uc min.	Uc max.	Auxiliary contacts	Type	Order code	Weight
70	60	24...60	20...60	0 0	AF40-22-00-11	1SBL347501R1100	1.210
		48...130	48...130	0 0	AF40-22-00-12	1SBL347501R1200	1.210
		100...250	100...250	0 0	AF40-22-00-13	1SBL347501R1300	1.160
		250...500	250...500	0 0	AF40-22-00-14	1SBL347501R1400	1.160
125	105	24...60	20...60	0 0	AF80-22-00-11	1SBL397501R1100	1.490
		48...130	48...130	0 0	AF80-22-00-12	1SBL397501R1200	1.490
		100...250	100...250	0 0	AF80-22-00-13	1SBL397501R1300	1.440
		250...500	250...500	0 0	AF80-22-00-14	1SBL397501R1400	1.440

For control by PLC-output, use RA4 interface relay.

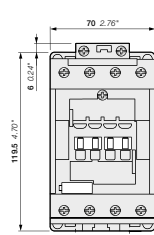

AF40, AF52

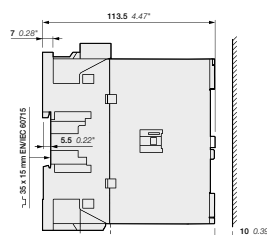

AF80

Main dimensions mm, inches

# AF09 ... AF80 4-pole contactors

## Contactors and main accessories

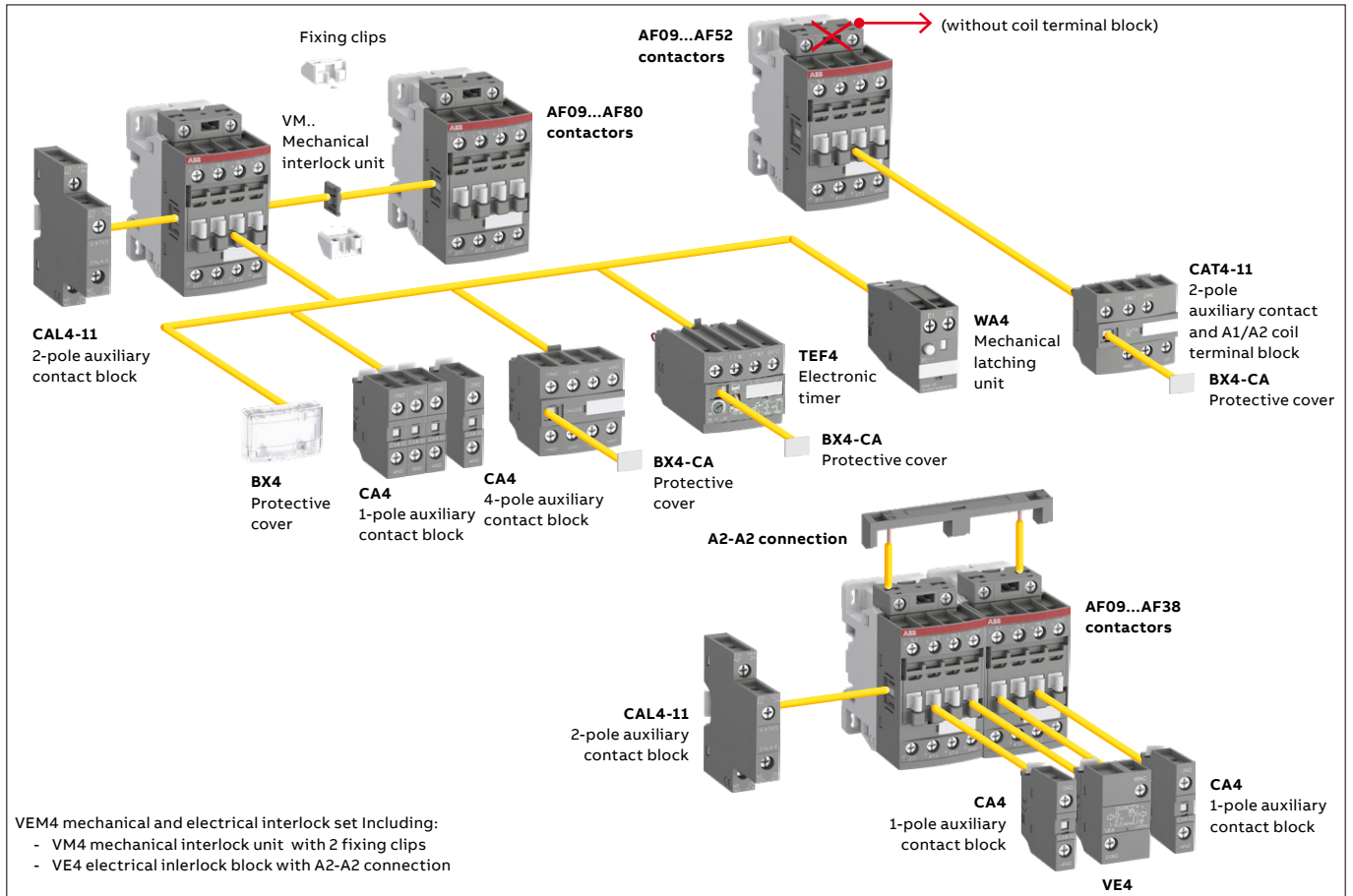

**Main accessory fitting details** - for ordering details, technical data and other accessories: see section accessories  
 Many configurations of accessories are possible depending on whether these are front-mounted or side-mounted.

Contactor types	Main poles	Built-in auxiliary contacts	Front-mounted accessories			Electronic timer	Mechanical latching unit	Electrical and mechanical interlock set (between 2 contactors)	Side-mounted accessories	
			Auxiliary contact blocks						Auxiliary contact blocks	
			1-pole CA4	2-pole CAT4-11	4-pole CA4	TEF4	WA4 (4)	VEM4	Left side	Right side
<b>AF09(Z) ... AF38(Z)</b>										
AF09 ... AF16	4 0	0 0(1)	4 max.	or 1	or 1	or 1	or 1	-	+ 1	-
AF26 ... AF38	4 0	0 0(2)	2 max.	or 1	-	or 1	or 1	-	+ 1	+ 1
			3 max.	-	-	-	-	+ 1 (5)	+ 1	or 1
AF09 ... AF38	2 2	0 0(2)	4 max.	or 1	or 1	or 1	or 1	-	+ 1	-
			2 max.	or 1	-	or 1	or 1	-	+ 1	+ 1
<b>AF09Z ... AF16Z 24 V DC designed for PLC - coil 30</b>										
AF09Z ... AF16Z	4 0	0 0(1)	4 max.	-	or 1	or 1	-	-(5)	or 1	+ 1
			2 max.	-	-	or 1	-	-(5)	+ 1	or 1
			-	-	-	1	-	-	+ 1	+ 1
AF09Z ... AF16Z	2 2	0 0(2)	4 max.	-	or 1	or 1	-	-	or 1	+ 1
			2 max.	-	-	or 1	-	-	+ 1	or 1
			-	-	-	1	-	-	+ 1	+ 1
<b>AF40 ... AF80</b>										
AF40 ... AF52	4 0	0 0	4 max.	or 1	or 1	or 1	or 1	-	+ 1	+ 1
AF80	4 0	0 0	4 max.	-	or 1	or 1	or 1	-	+ 1	+ 1
AF40	2 2	0 0(3)	4 max.	or 1	or 1	or 1	or 1	-	+ 1	-
			4 max.	-	or 1	or 1	or 1	-	+ 1	+ 1
AF80	2 2	0 0(3)	4 max.	-	or 1	or 1	or 1	-	+ 1	+ 1

(1) Including add-on contacts: 4 N.C. auxiliary contacts max. on positions 1, 2, 3, 4 and 3 N.C. auxiliary contacts max. on positions 1 ±30°, 5.  
 (2) Including add-on contacts: 3 N.C. auxiliary contacts max. on positions 1, 2, 3, 4 and 2 N.C. auxiliary contacts max. on positions 1 ±30°, 5.  
 (3) Including add-on contacts: 2 N.C. auxiliary contacts max. on positions 1, 1 ±30°, 2, 3, 4, 5.  
 (4) Use WA4 for AF09...AF65 and WA4-96 for AF80.

Accept 1-pole CA4 auxiliary contacts (1 block on each side of the mechanical latch) in respect to the total number of built-in or additional N.C. auxiliary contacts.  
 For WA4 accessory use with contactors coil 30, please consult your ABB local sales organization.  
 (5) VEM4 not suitable for AF..Z contactors with DC control voltages 12...20 V DC (coil 20) and 24 V DC (coil 30). Use VM4 side-mounted mechanical interlock unit.

# AF116 ... AF140 4-pole contactors

160 to 200 A AC-1  
AC / DC operated

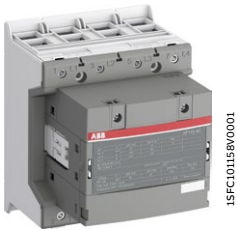

AF140-40-00

1SFCL01158V0001

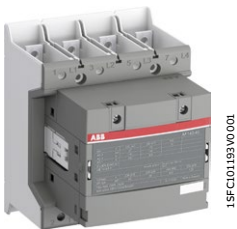

AF140-40-00B

1SFCL01193V0001

AF116 ... AF140 4-pole contactors are mainly used for controlling non-inductive or slightly inductive loads (i.e. resistance furnaces...) and generally for controlling power circuits up to 690 V AC and 350 V DC. These contactors are of the block type design with 4 main poles.

- control circuit: AC or DC operated with electronic coil interface accepting a wide control voltage range (e.g. 100...250 V AC and DC), only 4 coils to cover control voltages between 24...500 V 50/60 Hz and 20...500 V DC
  - can manage large control voltage variations
  - reduced panel energy consumption
  - very distinct closing and opening
  - can withstand short voltage dips and voltage sags (SEMI F47 conditions of use on request).
- built-in surge suppression
- add-on auxiliary contact blocks for side mounting and a wide range of accessories.

IEC	UL / CSA	Rated control circuit voltage Uc min. ... Uc max.		Auxiliary contacts fitted	Type (1)	Order code	Weight
Rated operational current $\theta \leq 40^\circ\text{C}$ AC-1	General use rating 600 V AC						Pkg (1 pce) kg
A	A	V 50/60 Hz	V DC				

### 4 N.O. main poles

#### For connection with built-in cable clamps

Rated current	UL / CSA	Uc min.	Uc max.	Uc min.	Uc max.	Type	Order code	Weight
160	160	24...60	20...60	0 0	0 0	AF116-40-00-11	1SFL427101R1100	2.250
		48...130	48...130	0 0	0 0	AF116-40-00-12	1SFL427101R1200	2.250
		100...250	100...250	0 0	0 0	AF116-40-00-13	1SFL427101R1300	2.250
		250...500	250...500	0 0	0 0	AF116-40-00-14	1SFL427101R1400	2.250
200	175	24...60	20...60	0 0	0 0	AF140-40-00-11	1SFL447101R1100	2.250
		48...130	48...130	0 0	0 0	AF140-40-00-12	1SFL447101R1200	2.250
		100...250	100...250	0 0	0 0	AF140-40-00-13	1SFL447101R1300	2.250
		250...500	250...500	0 0	0 0	AF140-40-00-14	1SFL447101R1400	2.250

#### With bar connections

Rated current	UL / CSA	Uc min.	Uc max.	Uc min.	Uc max.	Type	Order code	Weight
160	160	24...60	20...60	0 0	0 0	AF116-40-00B-11	1SFL427102R1100	2.150
		48...130	48...130	0 0	0 0	AF116-40-00B-12	1SFL427102R1200	2.150
		100...250	100...250	0 0	0 0	AF116-40-00B-13	1SFL427102R1300	2.150
		250...500	250...500	0 0	0 0	AF116-40-00B-14	1SFL427102R1400	2.150
200	175	24...60	20...60	0 0	0 0	AF140-40-00B-11	1SFL447102R1100	2.150
		48...130	48...130	0 0	0 0	AF140-40-00B-12	1SFL447102R1200	2.150
		100...250	100...250	0 0	0 0	AF140-40-00B-13	1SFL447102R1300	2.150
		250...500	250...500	0 0	0 0	AF140-40-00B-14	1SFL447102R1400	2.150

(1) For other auxiliary contacts arrangements, please contact your ABB local organization.

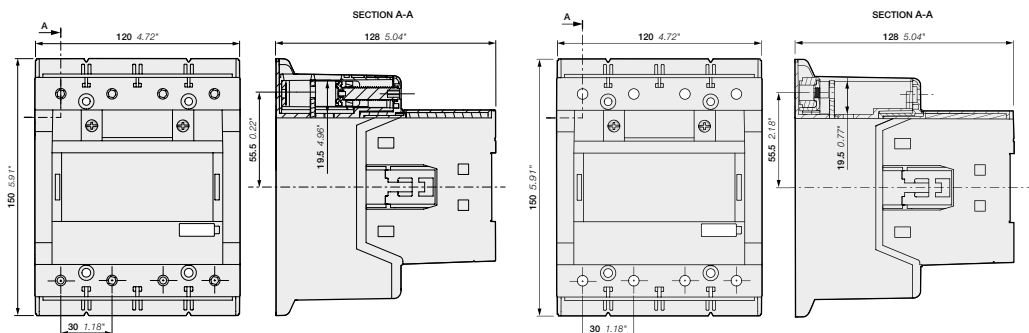

AF116, AF140-40-00

AF116, AF140-40-00B

Main dimensions mm, inches

1SFCL0197C0201 - Rev. B



# AF190 ... AF370 4-pole contactors

275 to 525 A AC-1  
AC / DC operated

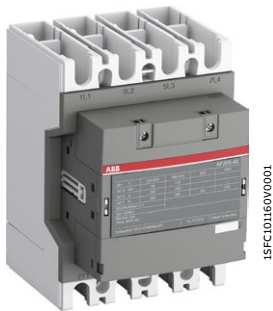

AF205-40-00

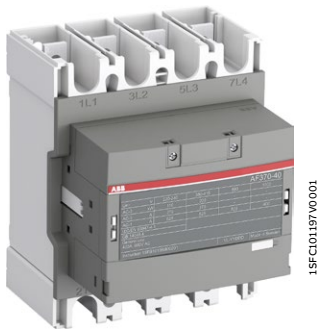

AF370-40-00

AF190 ... AF370 4-pole contactors are mainly used for controlling non-inductive or slightly inductive loads (i.e. resistance furnaces...) and generally for controlling power circuits up to 1000 V AC and 440 V DC. These contactors are of the block type design with 4 main poles.

- control circuit: AC or DC operated with electronic coil interface accepting a wide control voltage range (e.g. 100...250 V AC and DC), only 4 coils to cover control voltages between 24...500 V 50/60 Hz and 20...500 V DC
  - can manage large control voltage variations
  - reduced panel energy consumption
  - very distinct closing and opening
  - can withstand short voltage dips and voltage sags (SEMI F47 conditions of use on request).
- built-in surge suppression
- add-on auxiliary contact blocks for side mounting and a wide range of accessories.

IEC	UL / CSA	Rated control circuit voltage Uc min. ... Uc max.		Auxiliary contacts fitted	Type (1)	Order code	Weight
Rated operational current $\theta \leq 40^\circ\text{C}$ AC-1	General use rating 600 V AC						Pkg (1 pce) kg
A	A	V 50/60 Hz	V DC				

### 4 N.O. main poles

Rated current (A)	UL/CSA (A)	Uc min. (V)	Uc max. (V)	Control voltage (V)	Type (1)	Order code	Weight (kg)
275	230	24...60	20...60	0 0	AF190-40-00-11	1SFL487102R1100	3.900
		48...130	48...130	0 0	AF190-40-00-12	1SFL487102R1200	3.900
		100...250	100...250	0 0	AF190-40-00-13	1SFL487102R1300	3.900
		250...500	250...500	0 0	AF190-40-00-14	1SFL487102R1400	3.900
350	250	24...60	20...60	0 0	AF205-40-00-11	1SFL527102R1100	3.900
		48...130	48...130	0 0	AF205-40-00-12	1SFL527102R1200	3.900
		100...250	100...250	0 0	AF205-40-00-13	1SFL527102R1300	3.900
		250...500	250...500	0 0	AF205-40-00-14	1SFL527102R1400	3.900
400	300	24...60	20...60	0 0	AF265-40-00-11	1SFL547102R1100	6.360
		48...130	48...130	0 0	AF265-40-00-12	1SFL547102R1200	6.360
		100...250	100...250	0 0	AF265-40-00-13	1SFL547102R1300	6.360
		250...500	250...500	0 0	AF265-40-00-14	1SFL547102R1400	6.360
500	350	24...60	20...60	0 0	AF305-40-00-11	1SFL587102R1100	6.360
		48...130	48...130	0 0	AF305-40-00-12	1SFL587102R1200	6.360
		100...250	100...250	0 0	AF305-40-00-13	1SFL587102R1300	6.360
		250...500	250...500	0 0	AF305-40-00-14	1SFL587102R1400	6.360
525	420	24...60	20...60	0 0	AF370-40-00-11	1SFL607102R1100	6.360
		48...130	48...130	0 0	AF370-40-00-12	1SFL607102R1200	6.360
		100...250	100...250	0 0	AF370-40-00-13	1SFL607102R1300	6.360
		250...500	250...500	0 0	AF370-40-00-14	1SFL607102R1400	6.360

(1) For other auxiliary contacts arrangements, please contact your ABB local organization.

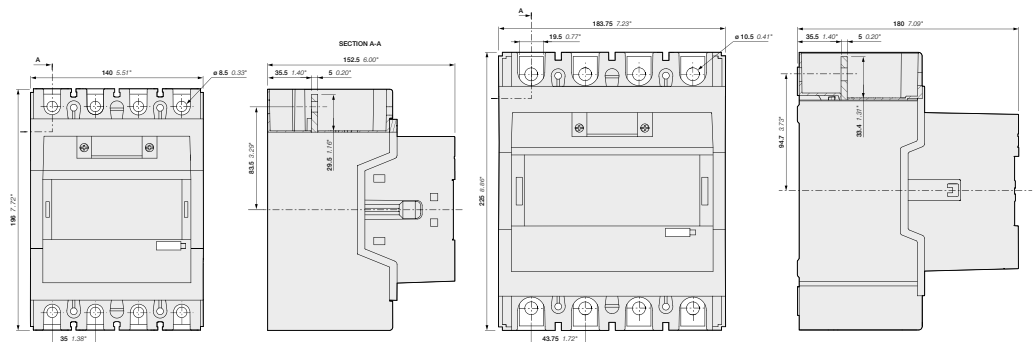

AF190, AF205

AF265, AF305, AF370

Main dimensions mm, inches

1SFC10198C0201 - Rev. B

# AF116 ... AF370 4-pole contactors

## Contactors and main accessories

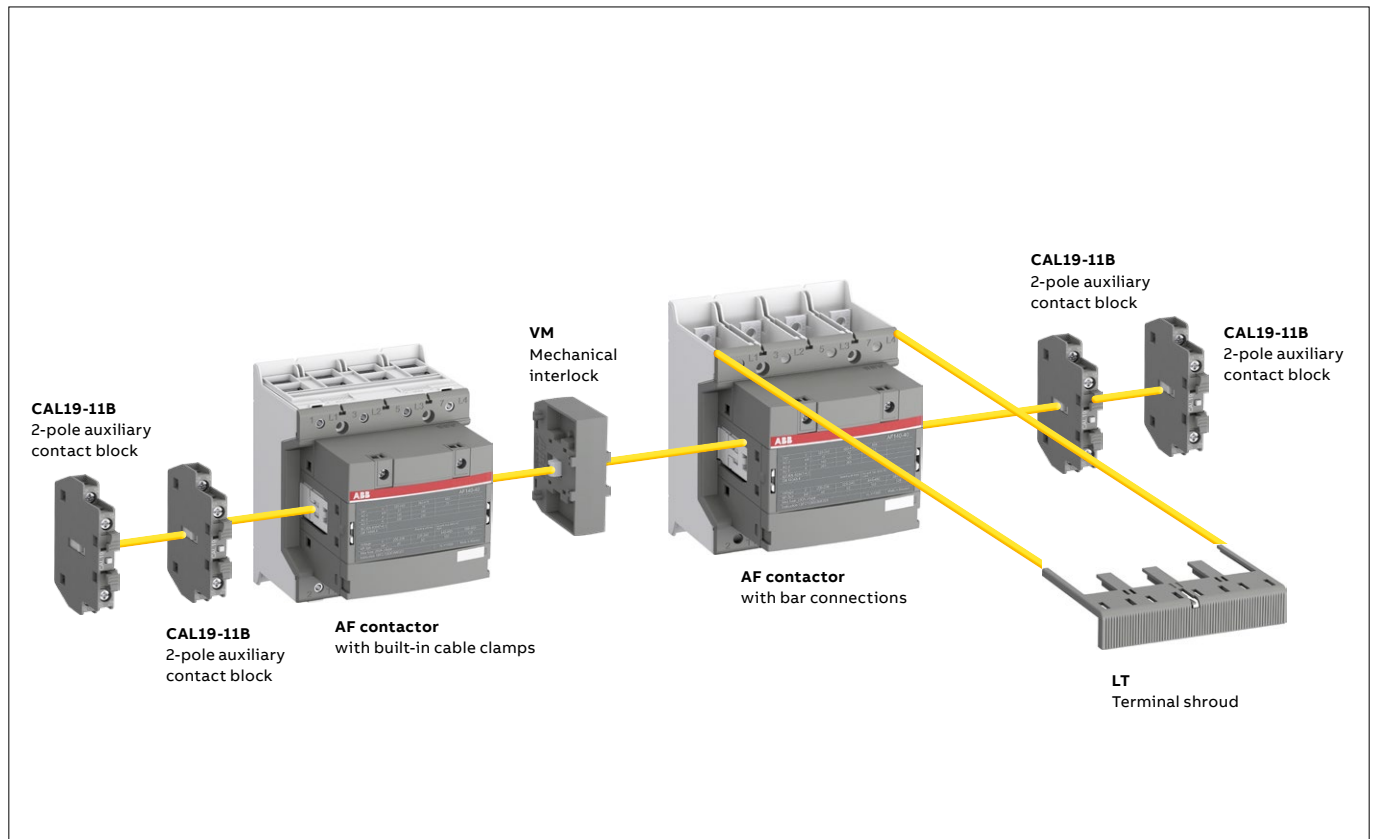

### Main accessory fitting details - for ordering details, technical data and other accessories: see section accessories

Contactor types	Main poles	Available auxiliary contacts	Side-mounted accessories		
			Auxiliary contact blocks		Mechanical interlock units (between two contactors)
			<b>CAL19-11 (3)</b>	<b>CAL19-11B (3)</b>	
AF116 ... AF370	4 0	0 0	2 x CAL19-11	+ 2 x CAL19-11B	-
AF116 ... AF370	4 0	0 0	2 x CAL19-11 (1)	+ 2 x CAL19-11B (1)	+ VM... (2)

(1) Total number of auxiliary contact blocks for the two contactors.

(2) Interlock type, according to the contactor ratings (see "Accessories").

(3) The CEL19 auxiliary contact blocks can replace the CAL19-11 and CAL19-11B. Though, no auxiliary contact block can be mounted outside the CEL19.

# AF116 ... AF140 4-pole contactors

160 to 200 A AC-1

AC / DC operated with 1 N.O. + 1 N.C. auxiliary contacts

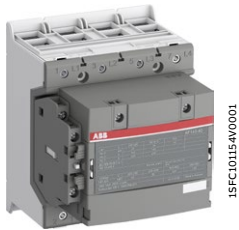

AF140-40-11

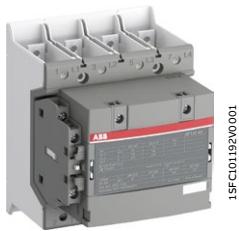

AF140-40-11B

AF116 ... AF140 4-pole contactors are mainly used for controlling non-inductive or slightly inductive loads (i.e. resistance furnaces...) and generally for controlling power circuits up to 690 V AC and 350 V DC. These contactors are of the block type design with 4 main poles.

- control circuit: AC or DC operated with electronic coil interface accepting a wide control voltage range (e.g. 100...250 V AC and DC), only 4 coils to cover control voltages between 24...500 V 50/60 Hz and 20...500 V DC
  - can manage large control voltage variations
  - reduced panel energy consumption
  - very distinct closing and opening
  - can withstand short voltage dips and voltage sags (SEMI F47 conditions of use on request).
- built-in surge suppression
- add-on auxiliary contact blocks for side mounting and a wide range of accessories.

IEC	UL / CSA	Rated control circuit voltage		Auxiliary contacts fitted	Type (1)	Order code	Weight
Rated operational current $\theta \leq 40^\circ\text{C}$ AC-1	General use rating  600 V AC	Uc min. ... Uc max.					Pkg (1 pce)  kg
A	A	V 50/60 Hz	V DC				

**4 N.O. main poles**

**For connection with built-in cable clamps**

Rated current	UL / CSA	Uc min.	Uc max.	N.O.	N.C.	Type	Order code	Weight
160	160	24...60	20...60	1	1	AF116-40-11-11	1SFL427101R1111	2.270
		48...130	48...130	1	1	AF116-40-11-12	1SFL427101R1211	2.270
		100...250	100...250	1	1	AF116-40-11-13	1SFL427101R1311	2.270
		250...500	250...500	1	1	AF116-40-11-14	1SFL427101R1411	2.270
200	175	24...60	20...60	1	1	AF140-40-11-11	1SFL447101R1111	2.270
		48...130	48...130	1	1	AF140-40-11-12	1SFL447101R1211	2.270
		100...250	100...250	1	1	AF140-40-11-13	1SFL447101R1311	2.270
		250...500	250...500	1	1	AF140-40-11-14	1SFL447101R1411	2.270

**With bar connections**

Rated current	UL / CSA	Uc min.	Uc max.	N.O.	N.C.	Type	Order code	Weight
160	160	24...60	20...60	1	1	AF116-40-11B-11	1SFL427102R1111	2.170
		48...130	48...130	1	1	AF116-40-11B-12	1SFL427102R1211	2.170
		100...250	100...250	1	1	AF116-40-11B-13	1SFL427102R1311	2.170
		250...500	250...500	1	1	AF116-40-11B-14	1SFL427102R1411	2.170
200	175	24...60	20...60	1	1	AF140-40-11B-11	1SFL447102R1111	2.170
		48...130	48...130	1	1	AF140-40-11B-12	1SFL447102R1211	2.170
		100...250	100...250	1	1	AF140-40-11B-13	1SFL447102R1311	2.170
		250...500	250...500	1	1	AF140-40-11B-14	1SFL447102R1411	2.170

(1) For other auxiliary contacts arrangements, please contact your ABB local organization.

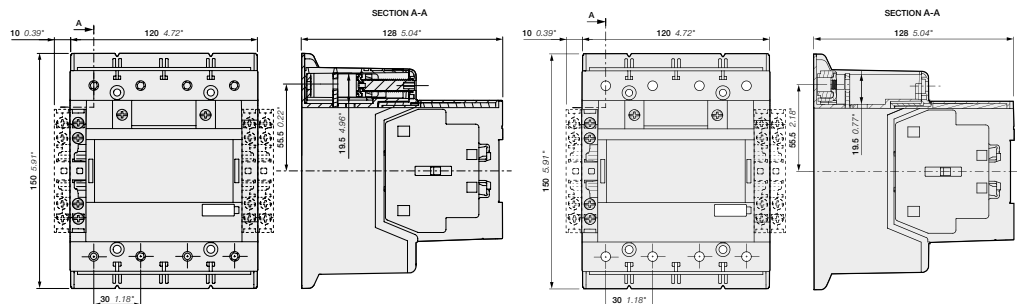

AF116, AF140-40-11

AF116, AF140-40-11B

Main dimensions mm, inches

1SFC10199C0201 - Rev. B

# AF190 ... AF370 4-pole contactors

275 to 525 A AC-1

AC / DC operated with 1 N.O. + 1 N.C. auxiliary contacts

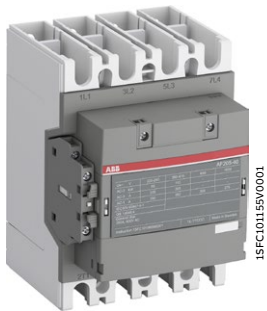

AF205-40-11

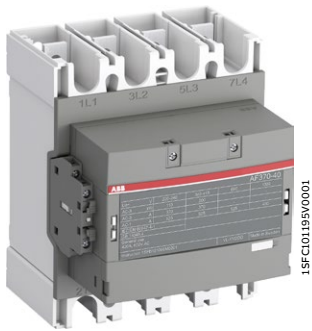

AF370-40-11

AF190 ... AF370 4-pole contactors are mainly used for controlling non-inductive or slightly inductive loads (i.e. resistance furnaces...) and generally for controlling power circuits up to 1000 V AC and 440 V DC. These contactors are of the block type design with 4 main poles.

- control circuit: AC or DC operated with electronic coil interface accepting a wide control voltage range (e.g. 100...250 V AC and DC), only 4 coils to cover control voltages between 24...500 V 50/60 Hz and 20...500 V DC
  - can manage large control voltage variations
  - reduced panel energy consumption
  - very distinct closing and opening
  - can withstand short voltage dips and voltage sags (SEMI F47 conditions of use on request).
- built-in surge suppression
- add-on auxiliary contact blocks for side mounting and a wide range of accessories.

IEC	UL / CSA	Rated control circuit voltage Uc min. ... Uc max.		Auxiliary contacts fitted	Type (1)	Order code	Weight
Rated operational current $\theta \leq 40^\circ\text{C}$ AC-1	General use rating 600 V AC						Pkg (1 pce) kg
A	A	V 50/60 Hz	V DC				

### 4 N.O. main poles

Rated operational current	UL / CSA	Uc min.	Uc max.	Uc min.	Uc max.	Type (1)	Order code	Weight
275	230	24...60	20...60	1	1	AF190-40-11-11	1SFL487102R1111	3.920
		48...130	48...130	1	1	AF190-40-11-12	1SFL487102R1211	3.920
		100...250	100...250	1	1	AF190-40-11-13	1SFL487102R1311	3.920
		250...500	250...500	1	1	AF190-40-11-14	1SFL487102R1411	3.920
350	250	24...60	20...60	1	1	AF205-40-11-11	1SFL527102R1111	3.920
		48...130	48...130	1	1	AF205-40-11-12	1SFL527102R1211	3.920
		100...250	100...250	1	1	AF205-40-11-13	1SFL527102R1311	3.920
		250...500	250...500	1	1	AF205-40-11-14	1SFL527102R1411	3.920
400	300	24...60	20...60	1	1	AF265-40-11-11	1SFL547102R1111	6.380
		48...130	48...130	1	1	AF265-40-11-12	1SFL547102R1211	6.380
		100...250	100...250	1	1	AF265-40-11-13	1SFL547102R1311	6.380
		250...500	250...500	1	1	AF265-40-11-14	1SFL547102R1411	6.380
500	350	24...60	20...60	1	1	AF305-40-11-11	1SFL587102R1111	6.380
		48...130	48...130	1	1	AF305-40-11-12	1SFL587102R1211	6.380
		100...250	100...250	1	1	AF305-40-11-13	1SFL587102R1311	6.380
		250...500	250...500	1	1	AF305-40-11-14	1SFL587102R1411	6.380
525	420	24...60	20...60	1	1	AF370-40-11-11	1SFL607102R1111	6.380
		48...130	48...130	1	1	AF370-40-11-12	1SFL607102R1211	6.380
		100...250	100...250	1	1	AF370-40-11-13	1SFL607102R1311	6.380
		250...500	250...500	1	1	AF370-40-11-14	1SFL607102R1411	6.380

(1) For other auxiliary contacts arrangements, please contact your ABB local organization.

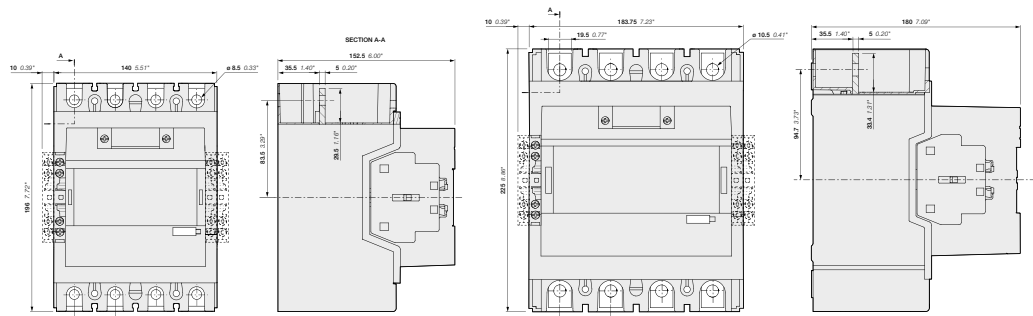

AF190, AF205

AF265, AF305, AF370

Main dimensions mm, inches

1SFC101200CC201 - Rev. A

03

# AF116 ... AF370 4-pole contactors with 1 N.O. + 1 N.C. auxiliary contacts

## Contactors and main accessories

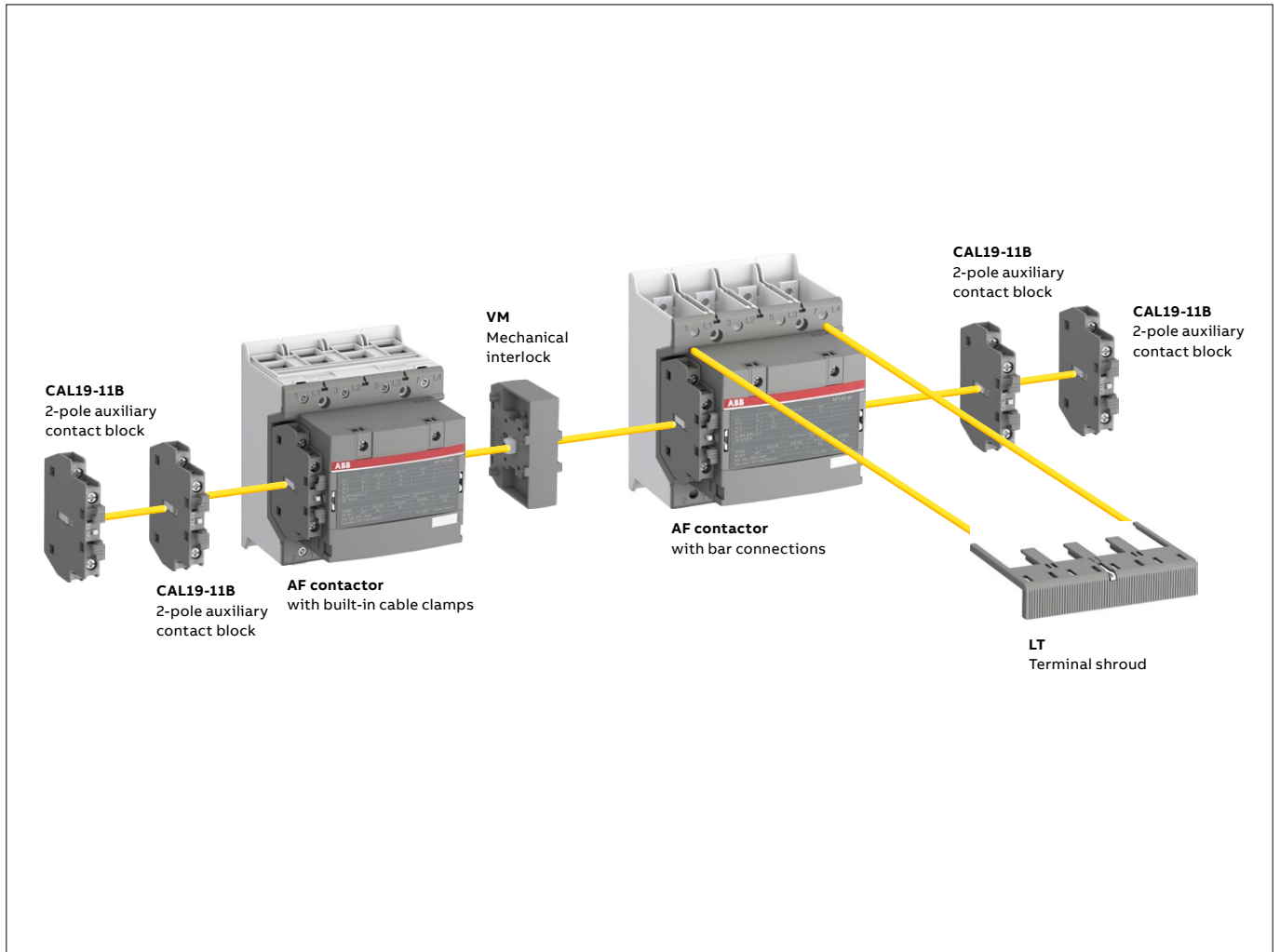

**Main accessory fitting details** - for ordering details, technical data and other accessories: see section accessories

Contactor types	Main poles	Available auxiliary contacts	Side-mounted accessories		
			Auxiliary contact blocks		Mechanical interlock units (between two contactors)
			<b>CAL19-11</b>	<b>CAL19-11B</b>	
AF116 ... AF370	4 0	1 1	1 x CAL19-11	+ 2 x CAL19-11B	-
AF116 ... AF370	4 0	1 1	-	+ 2 x CAL19-11B (1)	+ VM... (2)

(1) Total number of auxiliary contact blocks for the two contactors.  
 (2) Interlock type, according to the contactor ratings (see "Accessories").

# AF116 ... AF140 4-pole contactors

160 to 200 A AC-1

AC / DC operated with 2 N.O. + 2 N.C. auxiliary contacts



AF140-40-22



AF140-40-22B

AF116 ... AF140 4-pole contactors are mainly used for controlling non-inductive or slightly inductive loads (i.e. resistance furnaces...) and generally for controlling power circuits up to 690 V AC and 350 V DC. These contactors are of the block type design with 4 main poles.

- control circuit: AC or DC operated with electronic coil interface accepting a wide control voltage range (e.g. 100...250 V AC and DC), only 4 coils to cover control voltages between 24...500 V 50/60 Hz and 20...500 V DC
  - can manage large control voltage variations
  - reduced panel energy consumption
  - very distinct closing and opening
  - can withstand short voltage dips and voltage sags (SEMI F47 conditions of use on request).
- built-in surge suppression
- add-on auxiliary contact blocks for side mounting and a wide range of accessories.

IEC	UL / CSA	Rated control circuit voltage Uc min. ... Uc max.	Auxiliary contacts fitted	Type (1)	Order code	Weight
Rated operational current $\theta \leq 40^\circ\text{C}$ AC-1	General use rating 600 V AC					Pkg (1 pce) kg
A	A	V 50/60 Hz   V DC				

### 4 N.O. main poles

#### For connection with built-in cable clamps

Rated current	UL / CSA	Uc min.	Uc max.	NO	NC	Type	Order code	Weight
160	160	24...60	20...60	2	2	AF116-40-22-11	1SFL427101R1122	2.290
		48...130	48...130	2	2	AF116-40-22-12	1SFL427101R1222	2.290
		100...250	100...250	2	2	AF116-40-22-13	1SFL427101R1322	2.290
		250...500	250...500	2	2	AF116-40-22-14	1SFL427101R1422	2.290
200	175	24...60	20...60	2	2	AF140-40-22-11	1SFL447101R1122	2.290
		48...130	48...130	2	2	AF140-40-22-12	1SFL447101R1222	2.290
		100...250	100...250	2	2	AF140-40-22-13	1SFL447101R1322	2.290
		250...500	250...500	2	2	AF140-40-22-14	1SFL447101R1422	2.290

#### With bar connections

Rated current	UL / CSA	Uc min.	Uc max.	NO	NC	Type	Order code	Weight
160	160	24...60	20...60	2	2	AF116-40-22B-11	1SFL427102R1122	2.190
		48...130	48...130	2	2	AF116-40-22B-12	1SFL427102R1222	2.190
		100...250	100...250	2	2	AF116-40-22B-13	1SFL427102R1322	2.190
		250...500	250...500	2	2	AF116-40-22B-14	1SFL427102R1422	2.190
200	175	24...60	20...60	2	2	AF140-40-22B-11	1SFL447102R1122	2.190
		48...130	48...130	2	2	AF140-40-22B-12	1SFL447102R1222	2.190
		100...250	100...250	2	2	AF140-40-22B-13	1SFL447102R1322	2.190
		250...500	250...500	2	2	AF140-40-22B-14	1SFL447102R1422	2.190

(1) For other auxiliary contacts arrangements, please contact your ABB local organization.

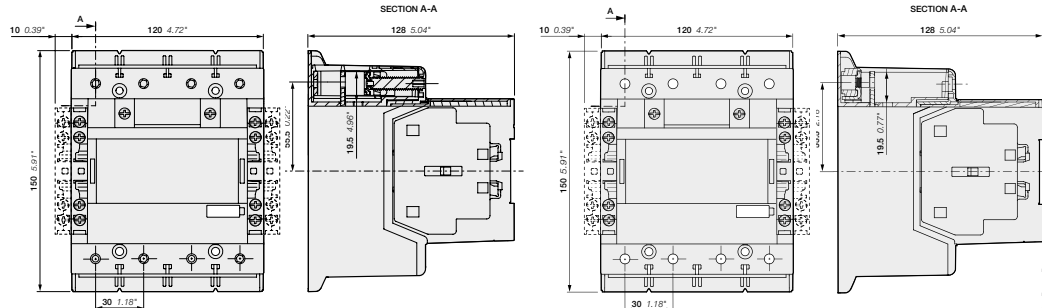

AF116, AF140-40-11

AF116, AF140-40-11B

Main dimensions mm, inches

1SFC101201C0201 - Rev. B



# AF190 ... AF370 4-pole contactors

275 to 525 A AC-1

AC / DC operated with 2 N.O. + 2 N.C. auxiliary contacts

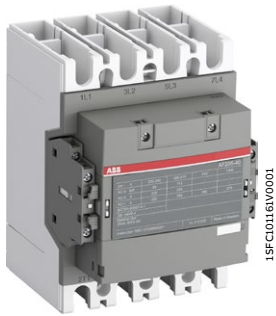

AF205-40-22

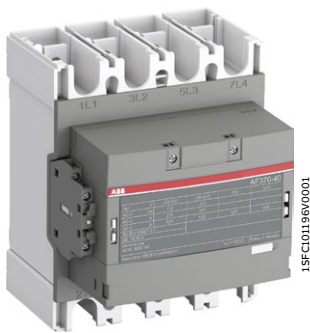

AF370-40-22

AF190 ... AF370 4-pole contactors are mainly used for controlling non-inductive or slightly inductive loads (i.e. resistance furnaces...) and generally for controlling power circuits up to 1000 V AC and 440 V DC. These contactors are of the block type design with 4 main poles.

- control circuit: AC or DC operated with electronic coil interface accepting a wide control voltage range (e.g. 100...250 V AC and DC), only 4 coils to cover control voltages between 24...500 V 50/60 Hz and 20...500 V DC
  - can manage large control voltage variations
  - reduced panel energy consumption
  - very distinct closing and opening
  - can withstand short voltage dips and voltage sags (SEMI F47 conditions of use on request).
- built-in surge suppression
- add-on auxiliary contact blocks for side mounting and a wide range of accessories.

IEC	UL / CSA	Rated control circuit voltage Uc min. ... Uc max.		Auxiliary contacts fitted	Type (1)	Order code	Weight
Rated operational current $\theta \leq 40^\circ\text{C}$ AC-1	General use rating 600 V AC						Pkg (1 pce) kg
A	A	V 50/60 Hz	V DC				

### 4 N.O. main poles

Rated current (A)	UL/CSA rating (A)	Uc min (V)	Uc max (V)	Coils	Type	Order code	Weight (kg)
275	230	24...60	20...60	2 2	AF190-40-22-11	1SFL487102R1122	3.940
		48...130	48...130	2 2	AF190-40-22-12	1SFL487102R1222	3.940
		100...250	100...250	2 2	AF190-40-22-13	1SFL487102R1322	3.940
		250...500	250...500	2 2	AF190-40-22-14	1SFL487102R1422	3.940
350	250	24...60	20...60	2 2	AF205-40-22-11	1SFL527102R1122	3.940
		48...130	48...130	2 2	AF205-40-22-12	1SFL527102R1222	3.940
		100...250	100...250	2 2	AF205-40-22-13	1SFL527102R1322	3.940
		250...500	250...500	2 2	AF205-40-22-14	1SFL527102R1422	3.940
400	300	24...60	20...60	2 2	AF265-40-22-11	1SFL547102R1122	6.400
		48...130	48...130	2 2	AF265-40-22-12	1SFL547102R1222	6.400
		100...250	100...250	2 2	AF265-40-22-13	1SFL547102R1322	6.400
		250...500	250...500	2 2	AF265-40-22-14	1SFL547102R1422	6.400
500	350	24...60	20...60	2 2	AF305-40-22-11	1SFL587102R1122	6.400
		48...130	48...130	2 2	AF305-40-22-12	1SFL587102R1222	6.400
		100...250	100...250	2 2	AF305-40-22-13	1SFL587102R1322	6.400
		250...500	250...500	2 2	AF305-40-22-14	1SFL587102R1422	6.400
525	420	24...60	20...60	2 2	AF370-40-22-11	1SFL607102R1122	6.400
		48...130	48...130	2 2	AF370-40-22-12	1SFL607102R1222	6.400
		100...250	100...250	2 2	AF370-40-22-13	1SFL607102R1322	6.400
		250...500	250...500	2 2	AF370-40-22-14	1SFL607102R1422	6.400

(1) For other auxiliary contacts arrangements, please contact your ABB local organization.

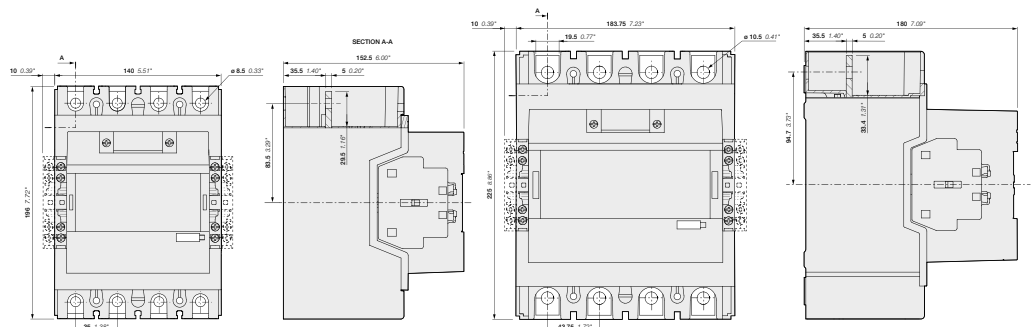

AF190, AF205

AF265, AF305, AF370

Main dimensions mm, inches

1SFLC01202C0201 - Rev. B

# AF116 ... AF370 4-pole contactors with 2 N.O. + 2 N.C. auxiliary contacts

Contactors and main accessories

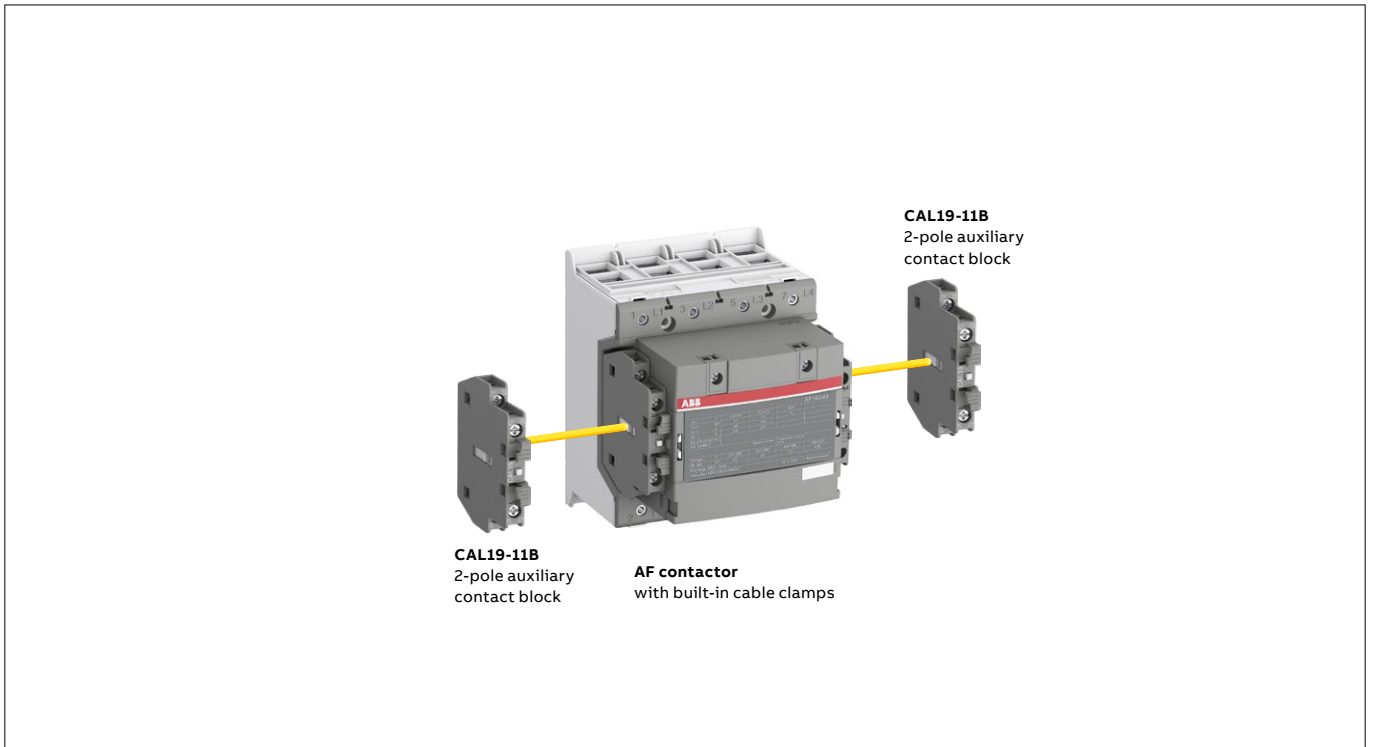

### Main accessory fitting details - for ordering details, technical data and other accessories: see section accessories

Contactor types	Main poles	Available auxiliary contacts	Side-mounted accessories		
			Auxiliary contact blocks		Mechanical interlock units (between two contactors)
			<b>CAL19-11 (1)</b>	<b>CAL19-11B (1)</b>	
AF116 ... AF370	4 0	2 2	2 x CAL19-11 included	+ 2 x CAL19-11B	-

(1) The CEL19 auxiliary contact blocks can replace the CAL19-11 and CAL19-11B. Though, no auxiliary contact block can be mounted outside the CEL19.

# EK550, EK1000 4-pole contactors

800 to 1000 A AC-1

AC operated with 1 N.O. + 1 N.C. auxiliary contacts

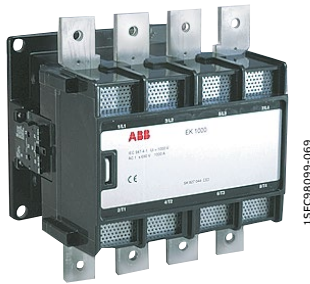

EK1000-40-11

1SFC099-069

EK550 4-pole contactors are mainly used for controlling non-inductive or slightly inductive loads (i.e. resistance furnaces...) and generally for controlling power circuits up to 1000 V AC and 600 V DC, EK1000 up to 1000 V AC.

These contactors are of the block type design with:

- 4 main poles
- control circuit: AC operated
- add-on auxiliary contact blocks for side mounting and a wide range of accessories.

IEC Rated operational current $\theta \leq 40^\circ\text{C}$ AC-1	UL/CSA General use rating 600 V AC	Rated control circuit voltage Uc (1)		Auxiliary contacts fitted 	Type	Order code	Weight  Pkg (1 pce)  kg
		V 50 Hz	V 60 Hz				
800	540	48	-	1 1	EK550-40-11	SK827041-AD	17.200
		110	110...120	1 1	EK550-40-11	SK827041-EF	17.200
		110...115	115...127	1 1	EK550-40-11	SK827041-EG	17.200
		220	220...240	1 1	EK550-40-11	SK827041-EL	17.200
		220...230	230...255	1 1	EK550-40-11	SK827041-EM	17.200
1000	-	48	-	1 1	EK1000-40-11	SK827044-AD	17.500
		110	110...120	1 1	EK1000-40-11	SK827044-EF	17.500
		110...115	115...127	1 1	EK1000-40-11	SK827044-EG	17.500
		220	220...240	1 1	EK1000-40-11	SK827044-EL	17.500
		220...230	230...255	1 1	EK1000-40-11	SK827044-EM	17.500
		400...415	-	1 1	EK1000-40-11	SK827044-AR	17.500

(1) Other control voltages see voltage code table.

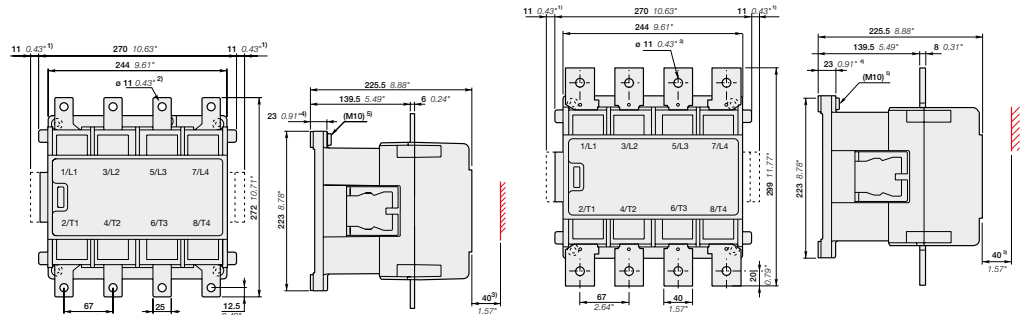

- EK550**
- 1) Dimension for extra auxiliary contact block.
  - 2) Screw, nut and washer by-packed.
  - 3) Min. distance to uninsulated wall.
  - 4) Damping elements are included.
  - 5) Earthing screw.

**EK1000**

Main dimensions mm, inches

# EK550, EK1000 4-pole contactors

800 to 1000 A AC-1

DC operated with 2 N.O. + 1 N.C. auxiliary contacts



EK1000-40-21

EK550 4-pole contactors are mainly used for controlling non-inductive or slightly inductive loads (i.e. resistance furnaces...) and generally for controlling power circuits up to 1000 V AC and 600 V DC, EK1000 up to 1000 V AC.

These contactors are of the block type design with:

- 4 main poles
- control circuit: DC operated
- add-on auxiliary contact blocks for side mounting and a wide range of accessories.

IEC	UL / CSA	Rated control circuit voltage Uc	Auxiliary contacts fitted	Type	Order code	Weight
Rated operational current $\theta \leq 40^\circ\text{C}$ AC-1	General use rating 600 V AC					Pkg (1 pce) kg
A	A	V DC				
800	540	24	2 1	EK550-40-21	SK827041-DB	17.200
		48	2 1	EK550-40-21	SK827041-DD	17.200
		75	2 1	EK550-40-21	SK827041-DG	17.200
		110	2 1	EK550-40-21	SK827041-DE	17.200
		125	2 1	EK550-40-21	SK827041-DU	17.200
		220	2 1	EK550-40-21	SK827041-DF	17.200
1000	-	24	2 1	EK1000-40-21	SK827044-DB	17.500
		36	2 1	EK1000-40-21	SK827044-DC	17.500
		48	2 1	EK1000-40-21	SK827044-DD	17.500
		60	2 1	EK1000-40-21	SK827044-DT	17.500
		75	2 1	EK1000-40-21	SK827044-DG	17.500
		110	2 1	EK1000-40-21	SK827044-DE	17.500
		125	2 1	EK1000-40-21	SK827044-DU	17.500
		220	2 1	EK1000-40-21	SK827044-DF	17.500

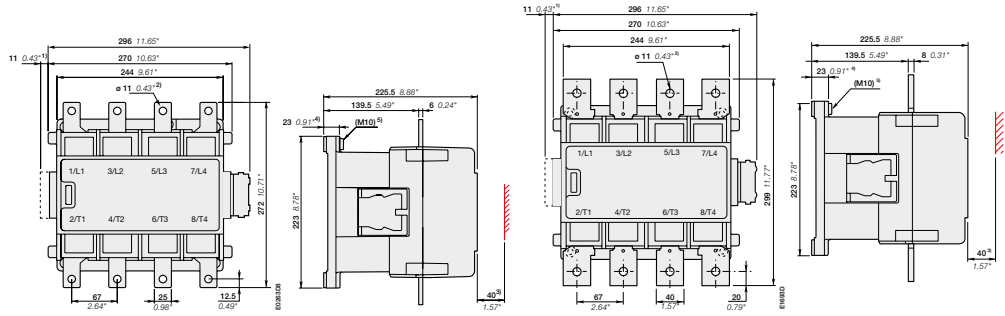

- EK550**
- 1) Dimension for extra auxiliary contact block.
  - 2) Screw, nut and washer by-packed.
  - 3) Min. distance to uninsulated wall.
  - 4) Damping elements are included.
  - 5) Earthing screw.

EK1000

# EK550, EK1000 4-pole Contactors

800 to 1000 A AC-1

AC operated with 2 N.O. + 2 N.C. auxiliary contacts



EK1000-40-22

EK550 4-pole contactors are mainly used for controlling non-inductive or slightly inductive loads (i.e. resistance furnaces...) and for controlling power circuits up to 1000 V AC and 600 V DC, EK1000 up to 1000 V AC.

These contactors are of the block type design with:

- 4 main poles
- control circuit: AC operated
- add-on auxiliary contact blocks for side mounting and a wide range of accessories

IEC Rated operational current $\theta \leq 40^\circ\text{C}$ AC-1	UL/CSA General use rating 600 V AC	Rated control circuit voltage $U_c$ (1)		Auxiliary contacts fitted 	Type	Order code	Weight  Pkg (1 pce)  kg
		V 50 Hz	V 60 Hz				
800	540	48	-	2 2	EK550-40-22	SK827043-AD	17.200
		110	110...120	2 2	EK550-40-22	SK827043-EF	17.200
		110...115	115...127	2 2	EK550-40-22	SK827043-EG	17.200
		220	220...240	2 2	EK550-40-22	SK827043-EL	17.200
		220...230	230...255	2 2	EK550-40-22	SK827043-EM	17.200
		400...415	-	2 2	EK550-40-22	SK827043-AR	17.200
1000	-	48	-	2 2	EK1000-40-22	SK827045-AD	17.500
		110	110...120	2 2	EK1000-40-22	SK827045-EF	17.500
		110...115	115...127	2 2	EK1000-40-22	SK827045-EG	17.500
		220	220...240	2 2	EK1000-40-22	SK827045-EL	17.500
		220...230	230...255	2 2	EK1000-40-22	SK827045-EM	17.500
		380	380...415	2 2	EK1000-40-22	SK827045-EP	17.500
		380...400	400...440	2 2	EK1000-40-22	SK827045-ER	17.500
		400...415	-	2 2	EK1000-40-22	SK827045-AR	17.500

(1) Other control voltages see voltage code table.

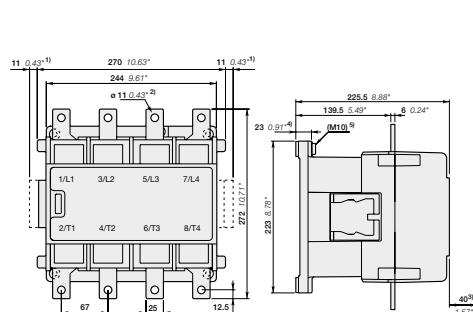

EK550

- 1) Dimension for extra auxiliary contact block
- 2) Screw, nut and washer by-packed
- 3) Min. distance to uninsulated wall
- 4) Damping elements are included
- 5) Earthing screw

Main dimensions mm, inches

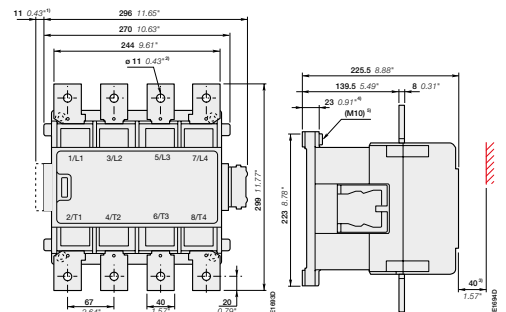

EK1000

# EK550, EK1000 4-pole contactors with 1 N.O. + 1 N.C. and 2 N.O. + 1 N.C. auxiliary contacts

Main accessory fitting details - for ordering details, technical data and other accessories: see section accessories

Mounting positions of the auxiliary contact	Auxiliary contact types and connecting diagrams
	<p>(1) Contact 35-36 used for some types of EK... contactors</p>

## EK 4-pole contactors

Contactor types	Main poles	Available auxiliary contacts	Add-on auxiliary contact blocks	Mounting and positioning
			2-pole CAL16-11 ...	Factory mounted auxiliary contacts Add-on CAL16-11 auxiliary contacts

### AC operated, 50 Hz, 60 Hz or 50/60 Hz

EK550, EK1000	4	0	1	1		+ 1 x CAL16-11B + 1 x CAL16-11C + 1 x CAL16-11D	
---------------	---	---	---	---	--	---	--

### DC operated

EK550, EK1000	4	0	2	1		+ 1 x CAL16-11C	
---------------	---	---	---	---	--	-----------------	--

## EK 4-pole reversing contactors with VH800 mechanical and electrical interlock units

"Left hand" contactors	Interlocking	"Right hand" contactors	Add-on auxiliary contact blocks	Mounting and positioning
			2-pole CAL16-11 ...	Factory mounted auxiliary contacts Add-on CAL16-11 auxiliary contacts

### AC operated, 50 Hz, 60 Hz or 50/60 Hz

EK550, EK1000	VH800	EK550, EK1000	+	1 x CAL16-11C 1 x CAL16-11D	
---------------	-------	---------------	---	--------------------------------	--

### DC operated

EK550, EK1000	VH800	EK550, EK1000	-		
---------------	-------	---------------	---	--	--



# EK550, EK1000 4-pole contactors with 1 N.O. + 1 N.C. auxiliary contacts and 2 N.O. + 1 N.C. auxiliary contacts

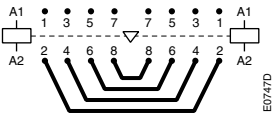

BSS550 ... BSS1000



RC-EH

For contactors	Auxiliary contacts	Type	Order code	Pkg qty	Weight (1 pce)
					kg

### Side-mounted auxiliary contact blocks

EK	Qty	Type	Order code	Pkg qty	Weight (1 pce)
	1	CAL16-11B	SK829002-B	1	0.050
	1	CAL16-11C	SK829002-C	1	0.050
	1	CAL16-11D	SK829002-D	1	0.050
	1	CCL16-11E (2)	SK829002-E	1	0.050

### Mechanical interlock unit for two horizontal mounted contactors

EK550, EK1000	Type	Order code	Pkg qty	Weight (1 pce)
	VH800	SK829070-F	1	6.000

### Connecting sets

EK550	Order code	Pkg qty	Weight (1 pce)
BSS550	SK829090-E	1	3.300
EK1000	Order code	Pkg qty	Weight (1 pce)
BSS1000	SK829090-H	1	5.500

### Surge suppressors



For contactors	Rated control circuit voltage U <sub>c</sub>		Type	Order code	Pkg qty	Weight (1 pce)
	V	AC DC				
EK550, EK1000	48...110	● -	RC-EH800/110	SK829007-C	1	0.015
EK550, EK1000	24...125	- ●	RC-EH800/110	SK829007-C	1	0.015
EK550, EK1000	220...600	● -	RC-EH800/600	SK829007-D	1	0.015

See "Main accessory fitting details" table.  
 (2) Mounting of CCL16-11E blocks does not allow an additional second block to be added on top of it.  
 All DC operated EK contactors are equipped with one CCL16-11E on the right side.

# AF09 ... AF80 4-pole contactors

## Technical data

### Main pole - Utilization characteristics according to IEC

AC / DC operated	AF09	AF16	AF26	AF38	AF40	AF52	AF80		
Standards	IEC 60947-1 / 60947-4-1 and EN 60947-1 / 60947-4-1								
Rated operational voltage Ue max.	690 V								
Rated frequency (without derating)	50 / 60 Hz								
Conventional free-air thermal current Ith acc. to IEC 60947-4-1, open contactors, $\theta \leq 40^\circ\text{C}$	35 A	35 A	55 A	55 A	105 A	105 A	125 A		
With conductor cross-sectional area	6 mm <sup>2</sup>	6 mm <sup>2</sup>	16 mm <sup>2</sup>	16 mm <sup>2</sup>	35 mm <sup>2</sup>	35 mm <sup>2</sup>	50 mm <sup>2</sup>		
AC-1 Utilization category									
For air temperature close to contactor									
le / Rated operational current AC-1	$\theta \leq 40^\circ\text{C}$	25 A	30 A	45 A	55 A	70 A	100 A	125 A	
Ue max. $\leq 690\text{ V}, 50/60\text{ Hz}$	$\theta \leq 60^\circ\text{C}$	25 A	30 A	40 A	45 A	60 A	80 A	105 A	
	$\theta \leq 70^\circ\text{C}$	22 A	26 A	32 A	37 A	50 A	70 A	90 A	
With conductor cross-sectional area		4 mm <sup>2</sup>	6 mm <sup>2</sup>	10 mm <sup>2</sup>	16 mm <sup>2</sup>	35 mm <sup>2</sup>	35 mm <sup>2</sup>	50 mm <sup>2</sup>	
AC-3 Utilization category									
For air temperature close to contactor $\theta \leq 60^\circ\text{C}$									
le / Max. rated operational current AC-3 (1)									
 3-phase motors	220-230-240 V	9 A	18 A	23.2 A	23.2 A	40 A	53 A	80 A	
	380-400 V	9 A	18 A	22 A	22 A	40 A	53 A	80 A	
	415 V	9 A	18 A	21.2 A	21.2 A	40 A	53 A	80 A	
	440 V	9 A	18 A	20 A	20 A	40 A	53 A	80 A	
	500 V	9.5 A	15 A	17.6 A	17.6 A	35 A	45 A	65 A	
	690 V	7 A	10.5 A	10.5 A	10.5 A	25 A	35 A	49 A	
	Rated operational power AC-3 (1)								
 1500 r.p.m. 50 Hz 1800 r.p.m. 60 Hz 3-phase motors	220-230-240 V	2.2 kW	4 kW	5.5 kW	5.5 kW	11 kW	15 kW	22 kW	
	380-400 V	4 kW	7.5 kW	11 kW (3)	11 kW (3)	18.5 kW	22 kW	37 kW	
	415 V	4 kW	9 kW	11 kW	11 kW	22 kW	30 kW	45 kW	
	440 V	4 kW	9 kW	11 kW	11 kW	22 kW	30 kW	45 kW	
	500 V	5.5 kW	9 kW	11 kW	11 kW	22 kW	30 kW	45 kW	
	690 V	5.5 kW	9 kW	9 kW	9 kW	22 kW	30 kW	45 kW	
	Rated making capacity AC-3	10 x Ie AC-3 acc. to IEC 60947-4-1							
Rated breaking capacity AC-3	8 x Ie AC-3 acc. to IEC 60947-4-1								
Short-circuit protection device for contactors									
Without thermal overload relay - Motor protection excluded									
Ue $\leq 500\text{ V AC}$ - gG type fuse	25 A	32 A	50 A	63 A	80 A	110 A	160 A		
Rated short-time withstand current Icw	1 s	300 A	300 A	450 A	450 A	1000 A	1000 A	1200 A	
At 40 °C ambient temperature, in free air from a cold state	10 s	150 A	150 A	300 A	300 A	600 A	600 A	780 A	
	30 s	80 A	80 A	225 A	225 A	350 A	350 A	450 A	
	1 min	60 A	60 A	150 A	150 A	250 A	250 A	300 A	
	15 min	35 A	35 A	55 A	55 A	110 A	110 A	140 A	
	Maximum breaking capacity	N.O. main pole	at 440 V	250 A	250 A	-	-	950 A	950 A
cos $\phi = 0.45$		at 690 V	106 A	106 A	-	-	600 A	600 A	750 A
	N.C. Main pole	at 440 V	-	-	-	-	600 A	-	900 A
		at 690 V	-	-	-	-	300 A	-	750 A
Power dissipation per pole	le / AC-1	0.8 W	1.2 W	1.6 W	2.3 W	3 W	6.3 W	8 W	
	le / AC-3	0.1 W	0.35 W	0.42 W	0.42 W	1 W	1.7 W	3.2 W	
Max. electrical switching frequency	AC-1	600 cycles/h							

(1) For the corresponding kW/A values of 1500 r.p.m, 50 Hz or 1800 r.p.m, 60 Hz, 3-phase motors, see "Motor Rated Operational Powers and Currents"

(2) For the protection of motor starters against short circuits, see "Coordination with Short-circuit Protection Devices".

(3) 400 V 3-phase motors only.

03

15BC1019850201 - Rev. B

# AF116 ... EK1000 4-pole contactors

## Technical data

### Main pole - Utilization characteristics according to IEC

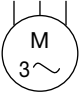
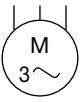
Contactor types	AC / DC operated	AF116	AF140	AF190	AF205	AF265	AF305	AF370	EK550	EK1000
Standards		IEC 60947-1 / 60947-4-1 and EN 60947-1 / 60947-4-1								
Rated operational voltage U <sub>e</sub> max.		690 V		1000 V						
Rated frequency (without derating)		50 / 60 Hz								
Conventional free-air thermal current I <sub>th</sub>										
acc. to IEC 60947-4-1, open contactors, $\theta \leq 40^\circ\text{C}$		160 A	200 A	275 A	350 A	400 A	500 A	525 A	800 A	1000 A
With conductor cross-sectional area		70 mm <sup>2</sup>	95 mm <sup>2</sup>	150 mm <sup>2</sup>	240 mm <sup>2</sup> (3)	240 mm <sup>2</sup>	300 mm <sup>2</sup> (4)	2x 185 mm <sup>2</sup> (4)	2x 240 mm <sup>2</sup>	2x 300 mm <sup>2</sup>
AC-1 Utilization category										
For air temperature close to contactor										
I <sub>e</sub> / Rated operational current AC-1	$\theta \leq 40^\circ\text{C}$	160 A	200 A	275 A	350 A	400 A	500 A	525 A	800 A	1000 A
U <sub>e</sub> max. $\leq 690\text{ V}, 50/60\text{ Hz}$	$\theta \leq 60^\circ\text{C}$	145 A	175 A	250 A	300 A	350 A	400 A	425 A	650 A	800 A
	$\theta \leq 70^\circ\text{C}$	130 A	160 A	200 A	240 A	290 A	325 A	350 A	575 A	720 A
U <sub>e</sub> max. $\leq 1000\text{ V}, 50/60\text{ Hz}$	$\theta \leq 40^\circ\text{C}$	-	-	250 A	275 A	350 A	375 A	400 A	800 A	1000 A
	$\theta \leq 60^\circ\text{C}$ (2)	-	-	225 A	250 A	300 A	325 A	350 A	650 A	800 A
	$\theta \leq 70^\circ\text{C}$	-	-	185 A	200 A	240 A	260 A	290 A	575 A	720 A
With conductor cross-sectional area		70 mm <sup>2</sup>	95 mm <sup>2</sup>	150 mm <sup>2</sup>	240 mm <sup>2</sup> (3)	240 mm <sup>2</sup>	300 mm <sup>2</sup> (4)	2x 185 mm <sup>2</sup> (4)	2x 240 mm <sup>2</sup>	2x 300 mm <sup>2</sup>
AC-3 Utilization category										
For air temperature close to contactor $\theta \leq 60^\circ\text{C}$ (2)										
I <sub>e</sub> / Max. rated operational current AC-3 (1)										
 3-phase motors	220-230-240 V	116 A	140 A	190 A	205 A	265 A	305 A	370 A	550 A	-
	380-400 V	116 A	140 A	190 A	205 A	265 A	305 A	370 A	550 A	-
	415 V	116 A	140 A	190 A	205 A	265 A	305 A	370 A	550 A	-
	440 V	116 A	140 A	190 A	205 A	265 A	305 A	370 A	550 A	-
	500 V	-	-	-	-	-	-	-	550 A	-
	690 V	-	-	-	-	-	-	-	550 A	-
	1000 V	-	-	-	-	-	-	-	175 A	-
 1500 r.p.m. 50 Hz 1800 r.p.m. 60 Hz 3-phase motors	220-230-240 V	30 kW	37 kW	55 kW	55 kW	75 kW	90 kW	110 kW	160 kW	-
	380-400 V	55 kW	75 kW	90 kW	110 kW	132 kW	160 kW	200 kW	280 kW	-
	415 V	55 kW	75 kW	90 kW	110 kW	132 kW	160 kW	200 kW	315 kW	-
	440 V	75 kW	90 kW	110 kW	132 kW	160 kW	160 kW	200 kW	315 kW	-
	500 V	-	-	-	-	-	-	-	400 kW	-
	690 V	-	-	-	-	-	-	-	500 kW	-
	1000 V	-	-	-	-	-	-	-	250 kW	-
Rated making capacity AC-3		10 x I <sub>e</sub> AC-3 acc. to IEC 60947-4-1								
Rated breaking capacity AC-3		8 x I <sub>e</sub> AC-3 acc. to IEC 60947-4-1								
Short-circuit protection device for contactors										
Without thermal overload relay - Motor protection excluded										
U <sub>e</sub> $\leq 500\text{ V AC}$ - gG type fuse		200 A	250 A	355 A	400 A	630 A	630 A	630 A	800 A	1000 A
Rated short-time withstand current I <sub>cw</sub>	1 s	1300 A	1460 A	1900 A	2050 A	2650 A	3050 A	3700 A	5500 A	6800 A
At 40 °C ambient temperature, in free air from a cold state	10 s	928 A	1168 A	1520 A	1640 A	2120 A	2440 A	2960 A	5300 A	6400 A
	30 s	536 A	674 A	878 A	947 A	1224 A	1409 A	1709 A	3700 A	4400 A
	1 min	379 A	477 A	621 A	670 A	865 A	996 A	1208 A	3000 A	3400 A
	15 min	160 A	200 A	275 A	350 A	400 A	500 A	525 A	1000 A	1200 A
Maximum breaking capacity	at 440 V	2000 A	3000 A	3300 A	3500 A	3800 A	4600 A	5000 A	5400 A	-
cos $\phi = 0.45$	at 690 V	-	-	-	-	-	-	-	5400 A	-
Power dissipation per pole	I <sub>e</sub> / AC-1	12 W	18 W	15 W	25 W	32 W	50 W	72 W	60 W	80 W
	I <sub>e</sub> / AC-3	-	-	-	-	-	-	-	25 W	-
Max. electrical switching frequency	AC-1	300 cycles/h								
	AC-3	300 cycles/h								
	AC-2, AC4	-								120 cycles/h

(1) For the corresponding kW/A or hp/A values of 1500 r.p.m. 50 Hz or 1800 r.p.m. 60 Hz, 3-phase motors, see "Motor rated operational powers and currents".

(2)  $\theta \leq 55^\circ\text{C}$  for EK550, EK1000

(3) For currents above 275 A use terminal enlargements or terminal extensions.

(4) For currents above 450 A use terminal enlargements or terminal extensions.

# AF09 ... AF80 4-pole contactors

## Technical data

### Main pole - Utilization characteristics according to UL/NEMA/CSA

Contactor types	AC / DC operated	AF09	AF16	AF26	AF38	AF40	AF52	AF80
Standards		UL 508, CSA C22.2 N°14				UL 60947-4-1, CSA-C22.2 No. 60947-4-1		
Max. operational voltage		600 V						
UL / CSA general use rating								
	600 V AC	25 A	30 A	45 A	55 A	60 A	80 A	105 A
With conductor cross-sectional area		AWG 10	AWG 10	AWG 8	AWG 6	AWG 6	AWG 4	AWG 2
1 pole	80 V DC	25 A (1)	30 A (1)	45 A	55 A	60 A	80 A	105 A
2 poles in serie	160 V DC	25 A (1)	30 A (1)	45 A	55 A	60 A	80 A	105 A
3 poles in serie	240 V DC	25 A	30 A	45 A	55 A	60 A	80 A	105 A
4 poles in serie	320 V DC	25 A	30 A	45 A	55 A	60 A	80 A	105 A
With conductor cross-sectional area		AWG 10	AWG 10	AWG 8	AWG 8	AWG 6	AWG 4	AWG 2
Max. electrical switching frequency								
For general use		600 cycles/h						

Note: 4-pole contactors fitted with 2 N.O. + 2 N.C. main poles, see "General technical data".

(1) 20 A for AF09...22-00 and AF16...22-00.

### Main pole utilization characteristics - 4 N.O. non-reversing contactors

Contactor types	AC / DC operated	AF09	AF16	AF26	AF38	AF40	AF52	AF80
Lighting application - UL / CSA - breaking all lines								
Electrical discharge lamps (ballast)								
1-phase per pole	347 V AC	20 A	30 A	45 A	50 A	-	-	-
3-phase break all lines	600 V AC	20 A	30 A	45 A	50 A	-	-	-
Elevator control, load switching, 500 000 electrical operating cycles acc. to CSA B44.1 / ASME 17.5 paragraph 19.2.1								
1-phase								
Horse power rating	110-120 V AC	-	1/2 hp	-	-	-	-	-
	220-240 V AC	-	1-1/2 hp	-	-	-	-	-
3-phase								
Horse power rating	200-208 V AC	-	3 hp	-	-	-	-	-
	220-240 V AC	-	3 hp	-	-	-	-	-
	440-480 V AC	-	7-1/2 hp	-	-	-	-	-
	550-600 V AC	-	10 hp	-	-	-	-	-

Note: 4-pole contactors fitted with 2 N.O. + 2 N.C. main poles, see "General technical data".

## AF116 ... EK1000 4-pole contactors

### Technical data

#### Main pole - Utilization characteristics according to UL/NEMA/CSA

Contactor types	AC / DC operated	AF116	AF140	AF190	AF205	AF265	AF305	AF370	EK550	EK1000
Standards		UL 60947-4-1							UL 508, CSA C22.2 N°14	
Max. operational voltage		600 V								
UL / CSA general use rating										
600 V AC		160 A	175 A	230 A	250 A	300 A	350 A	420 A	540 A	-
With conductor cross-sectional area		AWG 2/0	AWG 3/0	MCM 250	MCM 250	MCM 400	MCM 500	2//MCM 300	-	-
1 pole	90 V DC	200 A	200 A	-	-	-	-	-	-	-
	100 V DC	-	-	250 A	350 A	-	-	-	-	-
	110 V DC	-	-	-	-	400 A	500 A	520 A	-	-
2 poles in serie	175 V DC	200 A	200 A	-	-	-	-	-	-	-
	200 V DC	-	-	250 A	350 A	-	-	-	-	-
	225 V DC	-	-	-	-	400 A	500 A	520 A	-	-
3 poles in serie	260 V DC	200 A	200 A	-	-	-	-	-	-	-
	300 V DC	-	-	250 A	350 A	-	-	-	-	-
	340 V DC	-	-	-	-	400 A	500 A	520 A	-	-
4 poles in series	350 V DC	200 A	200 A	-	-	-	-	-	-	-
	400 V DC	-	-	250 A	350 A	-	-	-	-	-
	450 V DC	-	-	-	-	400 A	500 A	520 A	-	-
With conductor cross-sectional area		AWG 2/0	AWG 3/0	MCM 250	MCM 250	MCM 400	MCM 500	2//MCM 300	-	-
Max. electrical switching frequency										
For general use		300 cycles/h								

#### Main pole utilization characteristics - 4 N.O. non-reversing contactors

Contactor types	AC / DC operated	AF116	AF140	AF190	AF205	AF265	AF305	AF370	EK550	EK1000
Lighting application - UL/CSA - breaking all lines										
Electrical discharge lamps (ballast)										
1-phase per pole	347 V AC	160 A	200 A	250 A	300 A	400 A	450 A	520 A	-	-
3-phase break all lines	600 V AC	160 A	200 A	250 A	300 A	400 A	450 A	520 A	-	-

# AF09 ... AF80 4-pole contactors

## Technical data

### General technical data

Contactor types	AC / DC operated	AF09	AF16	AF26	AF38	AF40	AF52	AF80	
Rated insulation voltage Ui		690 V							1000 V
acc. to IEC 60947-4-1		600 V							
acc. to UL / CSA		6 kV							8 kV
Rated impulse withstand voltage Uimp.		Devices complying with IEC 60947-1 / EN 60947-1 - Environment A and B (1)							
Electromagnetic compatibility		Category B according to IEC 60947-1 Annex Q							
Ambient air temperature close to contactor		3000 m							
Operation		-40...+70 °C							
Storage		-60...+80 °C							
Climatic withstand		10 millions operating cycles							
Maximum operating altitude (without derating)		3600 cycles/h							
Mechanical durability		Shock withstand							
Number of operating cycles		acc. to IEC 60068-2-27 and EN 60068-2-27							
Max. switching frequency		Mounting position 1							
Shock direction		1/2 sinusoidal shock for 11 ms: no change in contact position, closed or open position							
4 N.O.		A	30 g		20 g				
Main poles		B1	25 g Closed position / 5 g Open position		20 g Closed position / 5 g Open position				
		B2	15 g		10 g				
		C1	25 g		20 g				
		C2	25 g		20 g				
2 N.O. + 2 N.C.		A	30 g		30 g Closed position / 25 g Open position		20 g		
Main poles		B1	25 g Closed position / 5 g Open position		25 g Closed position / 5 g Open position		20 g Closed position / 5 g Open position		
		B2	15 g		15 g Closed position / 10 g Open position		10 g		
		C1	25 g		25 g Closed position / 20 g Open position		20 g		
		C2	25 g		25 g Closed position / 20 g Open position		20 g		
Vibration withstand		5 ... 300 Hz				5 ... 300 Hz			
acc. to IEC 60068-2-6		4 g Closed position / 2 g Open position				3 g Closed position / 2 g Open position			

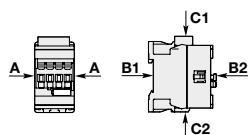

(1) Environment B: all AF09 ... AF38 contactors produced since week 08-2013. AF09 ... AF38-...-12 (48...130 V 50/60 Hz-DC) compliant to environment A only: for environment B select AF09Z ... AF38Z-...-22.

### Mounting characteristics and conditions for use

Contactor types	AF09	AF16	AF26	AF38	AF40	AF52	AF80
Mounting positions							
Mounting distances	Max. add-on N.C. auxiliary contacts: see accessory fitting details for a 4-pole contactor AF09 ... AF80						
Fixing	The contactors can be assembled side by side						
On rail according to IEC 60715, EN 60715	35 x 7.5 mm or 35 x 15 mm				35 x 15 mm		
By screws (not supplied)	2 x M4 screws placed diagonally				2 x M4 or 2 x M6 screws placed diagonally		

### Remark for 4-pole contactors fitted with 2 N.O. + 2 N.C. main poles

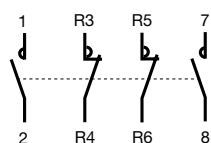

These contactors are suitable for controlling 2 separate circuits, i.e. 2 loads with 2 separate supplies, or 1 circuit comprising 2 separate loads with a single supply (see diagrams beside). When the contactor operates there is no mechanical overlapping between the N.O. poles and the N.C. poles: BREAK before MAKE.



These contactors are not suitable for a reversing starter or for controlling a single load from 2 separate supplies.

#### Block diagrams

- Single supply and 2 separate loads

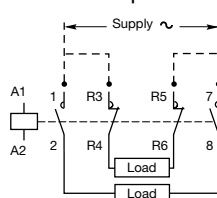

- 2 separate supplies and 2 separate loads

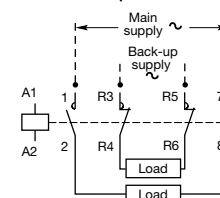



# AF116 ... EK1000 4-pole contactors

## Technical data

### General technical data

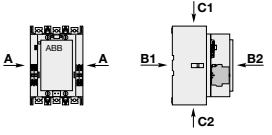
Contactor types	AC / DC operated	AF116	AF140	AF190	AF205	AF265	AF305	AF370
Rated insulation voltage Ui		1000 V						
acc. to IEC 60947-4-1		600 V						
acc. to UL / CSA		8 kV						
Rated impulse withstand voltage Uimp.		8 kV						
Electromagnetic compatibility		AF contactors comply with IEC 60947-1 / EN 60947-1 - Environment A						
Ambient air temperature close to contactor								
Operation		-40 to +70 °C						
Storage		-40 to +70 °C						
Climatic withstand		Category B according to IEC 60947-1 Annex Q						
Maximum operating altitude (without derating)		3000 m						
Mechanical durability								
Number of operating cycles		5 million operating cycles						
Maximum switching frequency		300 cycles/h						
Shock withstand								
acc. to IEC 60068-2-27 and EN 60068-2-27								
Mounting position 1		No change in contact position, closed or open position						
	Shock direction	1/2 sinusoidal shock for 11 ms				1/2 sinusoidal shock for 30 ms		
	A	20 g				20 g		
	B1	15 g closed position / 3 g open position				15 g closed position / 3 g open position		
	B2	15 g closed position / 3 g open position				15 g closed position / 3 g open position		
	C1	20 g				20 g		
	C2	20 g				20 g		
Vibration withstand								
acc to IEC 60068-2-6		0.7 g closed position / 0.7 g open position 13.2...100 Hz						

### General technical data

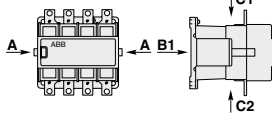
Contactor types	AC or DC operated	EK550	EK1000
Rated insulation voltage Ui		1000 V	
acc. to IEC 60947-4-1		600 V	
acc. to UL		8 kV	
Rated impulse withstand voltage Uimp.		8 kV	
Electromagnetic compatibility		EK contactors complying with IEC 60947-1 / EN 60947-1 - Environment A	
Ambient air temperature close to contactor			
Operation	Fitted with thermal overload relay	-25 to +55 °C	-
	Without thermal overload relay	-40 to +70 °C	-
Storage		-50 to +70 °C	-
Climatic withstand		Category B acc. to IEC 60068-2-30	
Maximum operating altitude (without derating)		≤ 3000 m	
Mechanical durability			
Number of operating cycles		5 millions operating cycles	3 millions operating cycles
Max. switching frequency		60 cycles/h	
Shock withstand			
acc. to IEC 60068-2-27 and EN 60068-2-27			
Mounting position 1			
Closed or open position		1/2 sinusoidal shock for 15 ms: no change in contact position, closed or open position	
	A	10 g	
	B1	10 g	
	B2	10 g	
	C1	10 g	
	C2	10 g	

# AF09 ... AF80 4-pole contactors

## Technical data

### Magnet system characteristics AF09 ... AF80 AC / DC operated

Contactor types	AC / DC operated	AF09	AF16	AF26	AF38	AF40	AF52	AF80
Coil operating limits acc. to IEC 60947-4-1	AC supply	At $\theta \leq 60^\circ\text{C}$ $0.85 \times U_c \text{ min} \dots 1.1 \times U_c \text{ max}$ . At $\theta \leq 70^\circ\text{C}$ $0.85 \times U_c \text{ min} \dots U_c \text{ max}$ .				at $\theta \leq 70^\circ\text{C}$ $0.85 \times U_c \text{ min} \dots 1.1 \times U_c \text{ max}$		
	DC supply	at $\theta \leq 60^\circ\text{C}$ $0.85 \times U_c \text{ min} \dots 1.1 \times U_c \text{ max}$ at $\theta \leq 70^\circ\text{C}$ $0.85 \times U_c \text{ min} \dots U_c \text{ max}$				at $\theta \leq 70^\circ\text{C}$ $0.85 \times U_c \text{ min} \dots 1.1 \times U_c \text{ max}$		
AC control voltage 50/60 Hz		24...500 V AC						
Rated control circuit voltage $U_c$		24...500 V AC						
Coil consumption	Average pull-in value	50 VA				40 VA		
	Average holding value	2.2 VA / 2 W				4 VA / 2 W		
DC control voltage		20...500 V DC				20...500 V DC		
Rated control circuit voltage $U_c$		20...500 V DC				20...500 V DC		
Coil consumption	Average pull-in value	50 W				40 W		
	Average holding value	2 W				2 W		
PLC-output control		AF...11 not suitable for direct control by PLC-output.				-		
Drop-out voltage		$\leq 60\%$ of $U_c \text{ min}$ .				$\leq 60\%$ of $U_c \text{ min}$ .		
Voltage sag immunity acc. to SEMI F47-0706		-				conditions of use on request		
Dips withstand $-20^\circ\text{C} \leq \theta \leq +60^\circ\text{C}$		-				24 ms average		
Operating time								
Between coil energization and:	N.O. contact closing	40...95 ms				48...120 ms		
	N.C. contact opening	38...90 ms				44...115 ms		
Between coil de-energization and:	N.O. contact opening	11...95 ms				16...110 ms		
	N.C. contact closing	13...98 ms				18...113 ms		

### Magnet System Characteristics AF09Z...AF38Z 24V DC operated designed for PLC - coil 30

Contactor types	DC operated	AF09Z	AF16Z
Coil operating limits acc. to IEC 60947-4-1	DC supply	at $\theta \leq 60^\circ\text{C}$ $0.85 \dots 1.1 \times U_c$ at $\theta \leq 70^\circ\text{C}$ $U_c$	
DC control voltage		24 V DC	
Rated control circuit voltage $U_c$		24 V DC	
Coil consumption	Average pull-in value	6 W	
	Average holding value	1.7 W	
PLC-output control		$\geq 250 \text{ mA}$ 24 V DC for PLCs and safety PLCs using broken wire detection	
Drop-out voltage		$\leq 60\%$ of $U_c \text{ min}$ .	
Voltage sag immunity acc. to SEMI F47-0706		-	
Dips withstand $-20^\circ\text{C} \leq \theta \leq +60^\circ\text{C}$		-	
Operating time			
Between coil energization and:	N.O. contact closing	27 ... 53 ms	
	N.C. contact opening	20 ... 35 ms	
Between coil de-energization and:	N.O. contact opening	17 ... 29 ms	
	N.C. contact closing	22 ... 57 ms	

### Magnet System Characteristics AF09Z...AF38Z AC / DC operated for specific applications - coils 20, 21, 22, 23

Contactor types	AC / DC operated	AF09Z	AF16Z	AF26Z	AF38Z
Coil operating limits acc. to IEC 60947-4-1	AC supply	At $\theta \leq 60^\circ\text{C}$ $0.85 \times U_c \text{ min} \dots 1.1 \times U_c \text{ max}$ . At $\theta \leq 70^\circ\text{C}$ $0.85 \times U_c \text{ min} \dots U_c \text{ max}$ .			
	DC supply	at $\theta \leq 70^\circ\text{C}$ $0.85 \times U_c \text{ min} \dots 1.1 \times U_c \text{ max}$			
AC control voltage 50/60 Hz		24...250 V AC			
Rated control circuit voltage $U_c$		24...250 V AC			
Coil consumption	Average pull-in value	16 VA			
	Average holding value	1.7 VA / 1.5 W			
DC control voltage		12...250 V DC			
Rated control circuit voltage $U_c$		12...250 V DC			
Coil consumption	Average pull-in value	12 ... 16 W			
	Average holding value	1.7 W			
PLC-output control		(AF..Z coil 21) $\geq 500 \text{ mA}$ 24 V DC for PLCs - Not suitable for safety PLCs			
Drop-out voltage		$\leq 60\%$ of $U_c \text{ min}$ .			
Voltage sag immunity acc. to SEMI F47-0706		(AF..Z coil 21, 22, 23) conditions of use on request			
Dips withstand $-20^\circ\text{C} \leq \theta \leq +60^\circ\text{C}$		(AF..Z coil 21, 22, 23) 22 ms average for $U_c \geq 24 \text{ V}$ 50/60 Hz or $U_c \geq 20 \text{ V DC}$			
Operating time					
Between coil energization and:	N.O. contact closing	40...95 ms			
	N.C. contact opening	38...90 ms			
Between coil de-energization and:	N.O. contact opening	11...95 ms			
	N.C. contact closing	13...98 ms			

## AF116 ... AF370 4-pole contactors

### Technical data

#### Magnet system characteristics

Contactor types	AC / DC operated	AF116	AF140	AF190	AF205	AF265	AF305	AF370
Coil operating limits	AC supply	At $\theta \leq 70^\circ\text{C}$ $0.85 \times U_c \text{ min} \dots 1.1 \times U_c \text{ max}$						
acc. to IEC 60947-4-1	DC supply	At $\theta \leq 70^\circ\text{C}$ $0.80 \times U_c \text{ min} \dots 1.1 \times U_c \text{ max}$						
Rated control circuit voltage $U_c$		24...500 V AC, 20...500 V DC						
Coil consumption								
AC control voltage 50/60 Hz								
24...60 V AC	Average pull-in value	225 VA		165 VA		475 VA		
	Average holding value	5.5 VA		6 VA		8.5 VA		
48...130 V AC	Average pull-in value	170 VA		175 VA		340 VA		
	Average holding value	4 VA		4 VA		17 VA		
100...250 V AC	Average pull-in value	130 VA		220 VA		385 VA		
	Average holding value	6 VA		7 VA		17.5 VA		
250...500 V AC	Average pull-in value	205 VA		185 VA		420 VA		
	Average holding value	16 VA		16 VA		21 VA		
DC control voltage								
20...60 V DC	Average pull-in value	210 W		205 W		400 W		
	Average holding value	2.5 W		2.5 W		3.5 W		
48...130 V DC	Average pull-in value	130 W		130 W		360 W		
	Average holding value	2.5 W		2.5 W		2.5 W		
100...250 V DC	Average pull-in value	135 W		190 W		410 W		
	Average holding value	3 W		2.5 W		4.5 W		
250...500 V DC	Average pull-in value	205 W		190 W		600 W		
	Average holding value	4 W		4 W		4.7 W		
Drop-out voltage		55 % of $U_c \text{ min}$						
Voltage sag immunity		Conditions of use on request						
acc. to SEMI F47								
Dips withstand		$\geq 20 \text{ ms}$						
Operating time								
Coil supply between A1 - A2								
Between coil energization and:	N.O. contact closing	20...55 ms		25...60 ms		30...60 ms		
Between coil de-energization and:	N.O. contact opening	40...70 ms		45...80 ms		45...80 ms		

#### Mounting characteristics and conditions for use

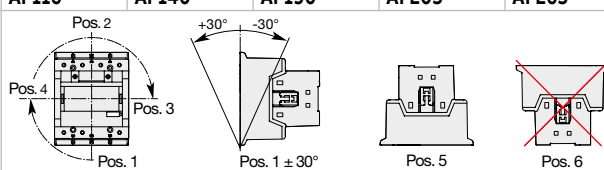
Contactor types	AC / DC operated	AF116	AF140	AF190	AF205	AF265	AF305	AF370
Mounting positions		 <p>Max. add-on N.O. or N.C. auxiliary contacts: see accessory fitting details for 4-pole contactor AF116 ... AF370</p>						
Mounting distances		The contactors can be assembled side by side						
Fixing								
On rail acc. to IEC 60715, EN 60715		-						
By screws		4 x M4			4 x M5			

# EK550 ... EK1000 4-pole contactors

## Technical data

### Magnet system characteristics

Contactor types		AC operated	EK550	EK1000
Coil operating limits		AC supply	At $\theta \leq 70^\circ\text{C}$ $0.85 \times U_c \text{ min} \dots 1.1 \times U_c \text{ max}$ .	
acc. to IEC 60947-4-1			Please also refer to "Mounting characteristics and conditions for use"	
AC control voltage				
Rated control circuit voltage		50 Hz	48...500 V	
		60 Hz	110...600 V	
Coil consumption		Average pull-in value	50 Hz	3500 VA
			60 Hz	4000 VA
		50/60 Hz (1)	3800 / 3400 VA	
		Average holding value	50 Hz	125 VA / 50 W
			60 Hz	140 VA / 60 W
		50/60 Hz (1)	140 VA / 60 W	
Drop-out voltage in % of $U_c \text{ min}$ .			approx. 45...65 %	
Operating time				
Between coil energization and:		N.O. contact closing	30...60 ms	
		N.C. contact opening	25...55 ms	
Between coil de-energization and:		N.O. contact opening	10...20 ms	
		N.C. contact closing	13...23 ms	

(1) "A" coil voltage: see "Coil voltage code table".

### Magnet system characteristics

Contactor types		DC operated	EK550	EK1000
Coil operating limits		DC supply	At $\theta \leq 70^\circ\text{C}$ $0.85 \times U_c \text{ min} \dots 1.1 \times U_c \text{ max}$ .	
acc. to IEC 60947-4-1			Please also refer to "Mounting characteristics and conditions for use"	
DC control voltage				
Rated control circuit voltage			24...220 V	
Coil consumption		Average pull-in value	1100 W	
		Average holding value	20 W	
Drop-out voltage			approx. 15...50 % of $U_c \text{ min}$ .	
Coil time constant				
Open		L/R	12 ms	
Closed		L/R	60 ms	
Operating time				
Between coil energization and:		N.O. contact closing	60...80 ms	
		N.C. contact opening	55...75 ms	
Between coil de-energization and:		N.O. contact opening	10...35 ms	
		N.C. contact closing	13...38 ms	

### Mounting characteristics and conditions for use











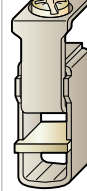
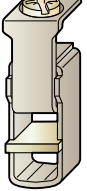
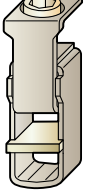



Contactor types		AC / DC operated	EK550	EK1000
Mounting positions				
Control voltage / Ambient temperature			Max. N.O. or N.C. built-in and add-on N.O. or N.C. auxiliary contacts: see accessory fitting details for 4-pole contactor EK550, EK1000	
Mounting positions		1, $1 \pm 30^\circ$ , 2, 3, 4, 5	at $\theta \leq 70^\circ\text{C}$	$0.85 \dots 1.1 \times U_c$
		6	at $\theta \leq 70^\circ\text{C}$	Unauthorized
Mounting distances			The contactors can be assembled side by side	
Fixing				
On rail according to IEC 60715, EN 60715			-	
By screws			4 x M6 (2)	

(2) Damping elements are supplied.

## AF09 ... AF80 4-pole contactors

### Technical data











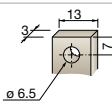
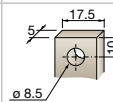
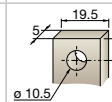

#### Connecting characteristics

Contactor types	AF09	AF16	AF26	AF38	AF40	AF52	AF80	
Main terminals	 Screw terminals with cable clamp		 Screw terminals with double connector 2 x (5.5 width x 6.8 depth)		 Screw terminals with double connector 2 x (9.3 width x 7.9/10.3 depth)		 Screw terminals with double connector 2 x (12.4 width x 9.3/11.1 depth)	
Connection capacity (min. ... max.)								
Main conductors (poles)								
 Rigid Solid ( $\leq 4 \text{ mm}^2$ )	} 1 x 1...6 mm <sup>2</sup>			1.5...16 mm <sup>2</sup>		6...35 mm <sup>2</sup>		
 Stranded ( $\geq 6 \text{ mm}^2$ )		2 x 1...6 mm <sup>2</sup>		1.5...16 mm <sup>2</sup>		6...35 mm <sup>2</sup>		
 Flexible with non insulated ferrule	1 x 0.75...6 mm <sup>2</sup>			1.5...16 mm <sup>2</sup>		4...35 mm <sup>2</sup>		
 Flexible with insulated ferrule	2 x 0.75...6 mm <sup>2</sup>			1.5...16 mm <sup>2</sup>		4...35 mm <sup>2</sup>		
 Flexible with insulated ferrule	1 x 0.75...4 mm <sup>2</sup>			1.5...16 mm <sup>2</sup>		4...35 mm <sup>2</sup>		
 Flexible with insulated ferrule	2 x 0.75...2.5 mm <sup>2</sup>			1.5...16 mm <sup>2</sup>		4...35 mm <sup>2</sup>		
 Bars or lugs	L < 9.6 mm			-		9.2 mm		
Connection capacity acc. to UL/CSA	1 or 2 x	AWG 16...10		AWG 16...6		AWG 10...2		
Stripping length	10 mm		12 mm		16 mm		17 mm	
Tightening torque	1.5 Nm / 13 lb.in		2.5 Nm / 22 lb.in		4 Nm / 35 lb.in		6 Nm / 53 lb.in	
Auxiliary conductors (coil terminals)								
 Rigid solid	1 x 1...2.5 mm <sup>2</sup>							
 Rigid solid	2 x 1...2.5 mm <sup>2</sup>							
 Flexible with non insulated ferrule	1 x 0.75...2.5 mm <sup>2</sup>							
 Flexible with non insulated ferrule	2 x 0.75...2.5 mm <sup>2</sup>							
 Flexible with insulated ferrule	1 x 0.75...2.5 mm <sup>2</sup>							
 Flexible with insulated ferrule	2 x 0.75...1.5 mm <sup>2</sup>							
 Lugs	L < 8 mm							
Connection capacity acc. to UL/CSA	1 or 2 x	AWG 18...14						
Stripping length	10 mm							
Tightening torque	1.2 Nm / 11 lb.in							
Degree of protection acc. to IEC 60947-1 / EN 60947-1 and IEC 60529 / EN 60529								
Main terminals	IP20				IP10			
Coil terminals	IP20							
Screw terminals	Delivered in open position, screws of unused terminals must be tightened							
Main terminals	M3.5		M4.5		M6		M8	
	Screwdriver type	Flat Ø 5.5 / Pozidriv 2			Flat Ø 6.5 / Pozidriv 2		hexagon socket (s = 4 mm)	
Coil terminals	M3.5							
	Screwdriver type	Flat Ø 5.5 / Pozidriv 2						

# AF116 ... AF370 4-pole contactors

## Technical data

### Connecting characteristics







Contactor types	AC / DC operated	AF116	AF140	AF190	AF205	AF265	AF305	AF370
Main terminals								
Flat type								
Connection capacity (min. ... max.)								
Main conductors (poles)								
	Cu cable - Stranded	1 x	10...95 mm <sup>2</sup>	6...150 mm <sup>2</sup>		16...300 mm <sup>2</sup>		
	Clamp type		LD... included (1)	1SDA066917R1		1SDA055016R1		
	Tightening torque		8 Nm	14 Nm		25 Nm		
	Cu cable - Stranded	2 x	10...95 mm <sup>2</sup>	50...120 mm <sup>2</sup>		70...185 mm <sup>2</sup>		
	Clamp type		LD... included (1)	1SFN074709R1000, LZ185-2C/120		1SCA022194R0890, OZXB4		
	Tightening torque		8 Nm	16 Nm		22 Nm		
	Al cable - Stranded	1 x	-	95...185 mm <sup>2</sup>		185...240 mm <sup>2</sup>		
	Clamp type		-	1SDA054988R1		1SDA055020R1		
	Tightening torque		-	31 Nm		43 Nm		
	Cu cable - Flexible	1 x	10...70 mm <sup>2</sup>	6...120 mm <sup>2</sup>		16...240 mm <sup>2</sup>		
	Clamp type		LD... included (1)	1SDA066917R1		1SDA055016R1		
	Tightening torque		8 Nm	14 Nm		25 Nm		
	Cu cable - Flexible	2 x	10...70 mm <sup>2</sup>	50...95 mm <sup>2</sup>		70...185 mm <sup>2</sup>		
	Clamp type		LD... included (1)	1SFN074709R1000, LZ185-2C/120		1SCA022194R0890, OZXB4		
	Tightening torque		8 Nm	16 Nm		22 Nm		
	Lugs	L ≤	22 mm (.866 in)	24 mm (.945 in)		32 mm (1.260 in)		
		Ø >	6 mm (.236 in)	8 mm (.315 in)		10 mm (.394 in)		
	Socket type		LL... included	LL... included		LL... included		
	Tightening torque		9 Nm / 80 lb.in	18 Nm / 160 lb.in		28 Nm / 248 lb.in		
Connection capacity acc. to UL / CSA		1 x	AWG 6...3/0	6...300 MCM		4...400 MCM		
	Clamp type		LD... included (1)	ATK185 (2)		ATK300 (2)		
	Tightening torque		8 Nm / 71 lb.in	34 Nm / 301 lb.in		42 Nm / 372 lb.in		
Connection capacity acc. to UL / CSA		2 x	AWG 6...3/0	-		4...500 MCM		
	Clamp type		LD... included (1)	-		ATK300/2 (2)		
	Tightening torque		8 Nm / 71 lb.in	-		42 Nm / 372 lb.in		
Auxiliary conductors (coil terminals)								
	Solid / stranded	1 x	1...4 mm <sup>2</sup>					
		2 x	1...4 mm <sup>2</sup>					
	Flexible	1 x	0.75...2.5 mm <sup>2</sup>					
		2 x	0.75...2.5 mm <sup>2</sup>					
	Flexible with non insulated ferrule	1 x	0.75...2.5 mm <sup>2</sup>					
		2 x	0.75...2.5 mm <sup>2</sup>					
	Flexible with insulated ferrule	1 x	0.75...2.5 mm <sup>2</sup>					
		2 x	0.75...2.5 mm <sup>2</sup>					
	Lugs	L <	8 mm					
		I >	3.5 mm					
Connection capacity acc. to UL / CSA		1 or 2 x	AWG 18...14					
Stripping length			9 mm					
Tightening torque			1.00 Nm / 9 lb.in					
Degree of protection acc. to IEC 60947-1 / EN 60947-1 and IEC 60529 / EN 60529								
Main terminals			IP00					
Coil terminals			IP20					
Screw terminals								
Main terminals			M6	M8		M10		
	Screwdriver type		Screws and bolts					
Coil terminals (delivered in open position)			M3.5					
	Screwdriver type		Flat Ø 5.5 mm / Pozidriv 2					

(1) LD... not included for AF116 ... AF146-30...B.  
 (2) Available in North America only.

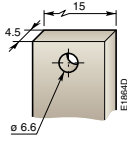
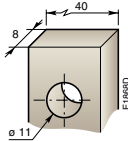
## EK550 ... EK1000 4-pole contactors

### Technical data

#### Connecting characteristics

Contactor types	AC or DC operated	EK550	EK1000
Main terminals Flat type			
Connection capacity (min. ... max.)			
Main conductors (poles)			
 Rigid with connector	Cu cable	1 x 70...300 mm <sup>2</sup>	-
	Al/Cu cable	1 x 70...300 mm <sup>2</sup>	95...300 mm <sup>2</sup>
	Al/Cu cable	2 x 35...185 mm <sup>2</sup>	95...300 mm <sup>2</sup>
 Bars or lugs		L ≤ 55 mm Ø > 10 mm	
Connection capacity acc. to UL/CSA	1 or 2 x	3 x 4 - 500 MCM	-
Tightening torque	Recommended	18 Nm / 160 lb.in	
	Max.	22 Nm	
Auxiliary conductors (coil terminals)			
 Rigid solid		1 x 0.5...2.5 mm <sup>2</sup>	
		2 x 0.5...2.5 mm <sup>2</sup>	
 Flexible with ferrule		1 x 0.5...2.5 mm <sup>2</sup>	
		2 x 0.5...2.5 mm <sup>2</sup>	
 Bars or lugs		L ≤ 8 mm l > 3.7 mm	
Connection capacity acc. to UL/CSA	1 or 2 x	18...14 AWG	
Tightening torque	Recommended	1.00 Nm / 9 lb.in	
	Max.	1.20 Nm	
Degree of protection acc. to IEC 60947-1 / EN 60947-1 and IEC 60529 / EN 60529			
Main terminals		IP00	
Coil terminals		IP20	
Screw terminals			
Main terminals		M10 Screws and bolts	
Coil terminals (delivered in open positions)		M3.5	
	Screwdriver type	Flat Ø 5.5 mm / Pozidriv 2	



## 4-pole contactors

### Electrical durability and utilization categories

#### General

Utilization categories determine the current making and breaking conditions relating to the characteristics of the loads to be controlled by the contactors. International standard IEC 60947-4-1 and European standard EN 60947-4-1 are the standards to be referred to.

If  $I_c$  is the current to be broken by the contactor and  $I_e$  the rated operational current normally drawn by the load, then:

- Categories AC-1:  $I_c = I_e$

Generally speaking  $I_c = m \times I_e$  where  $m$  is a multiple of the load operational current.

On next pages, the curves corresponding to categorie AC-1 represent the electrical durability variation of standard contactors in relation to the breaking current  $I_c$ .

#### Electrical durability curves:

- categories AC-1: the curves represent the electrical durability variation of standard contactors in relation to the breaking current  $I_c$ .

Electrical durability is expressed in millions of operating cycles.

#### Curve utilization mode

##### Electrical durability forecast and contactor selection for categories AC-1

- Note the characteristics of the load to be controlled:
  - Operational voltage.....  $U_e$
  - Current normally drawn.....  $I_e$  ( $U_e / I_e$  / kW relation for motors, see "Motor rated operational powers and currents").
  - Utilization category..... AC-1
  - Breaking current.....  $I_c = I_e$  for AC-1
- Define the number of operating cycles  $N$  required.
- On the diagram corresponding to the operational category, select the contactor with the curve immediately above the intersection point ( $I_c$  ;  $N$ ).

#### Case of uninterrupted duty

For uninterrupted duty, some verifications of preventing maintenance are necessary to check the functionality of the concerned product (consult us).

The combined effect of environmental conditions and the proper temperature of the product may require some disposals. As a matter of fact, for this duty, the use duration prevails over the number of operating cycles.

# 4-pole contactors

## Electrical durability

**Electrical durability for AC-1 utilization category -  $U_e \leq 690\text{ V}$**

**Switching non-inductive or slightly inductive loads. The breaking current  $I_c$  for AC-1 is equal to the rated operational current of the load.**

Ambient temperature and maximum electrical switching frequency: see "Technical data".

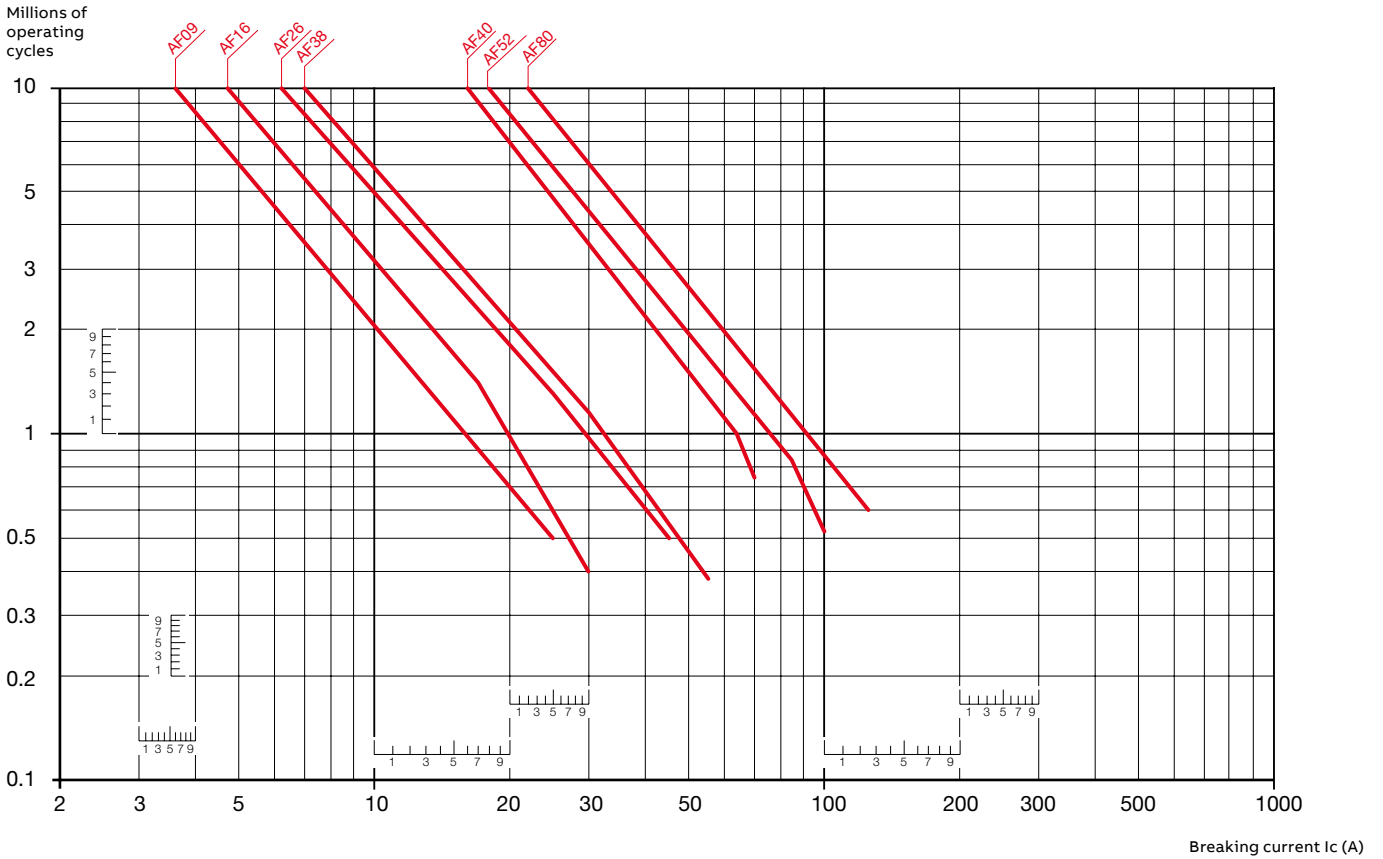

30

—  
**Notes**

A large rectangular area filled with a grid of small, light gray dotted lines, intended for handwritten notes.





# —

## Contactors for DC switching

<b>3/170</b>	<b>Overview</b>	
<b>3/172</b>	<b>Contactors for DC switching applications</b>	
<b>3/173</b>	<b>Connection diagrams</b>	
	<b>Selection table for DC switching</b>	
<b>3/174</b>	AF09 ... AF96 contactors	
<b>3/175</b>	AF116 ... AF2650 contactors	
<b>3/176</b>	EK550 ... EK1000 contactors	
	<b>Ordering details</b>	
	<b>100 A DC-1</b>	
<b>3/178</b>	GA75	AC operated
<b>3/179</b>	GAE75	DC operated
	<b>250 to 400 A DC-1</b>	
<b>3/180</b>	GAF185 ... GAF300	AC / DC operated with 1 N.O. + 1 N.C.
	<b>600 to 875 A DC-1</b>	
<b>3/181</b>	GAF460 ... GAF750	AC / DC operated with 1 N.O. + 1 N.C.
	<b>1040 to 1750 A DC-1</b>	
<b>3/182</b>	GAF1250 ... GAF2050	AC / DC operated with 1 N.O. + 1 N.C.
<b>3/183</b>	<b>Technical data</b>	
<b>3/404</b>	<b>Voltage code table</b>	



—

**For direct product details information, use product type or order code, ex:**

- [www.abb.com/productdetails/AF09-30-10-13](http://www.abb.com/productdetails/AF09-30-10-13)
- or [www.abb.com/productdetails/1SBL137001R1310](http://www.abb.com/productdetails/1SBL137001R1310)

03

# GAF contactors

## The compact efficient way to switch DC loads

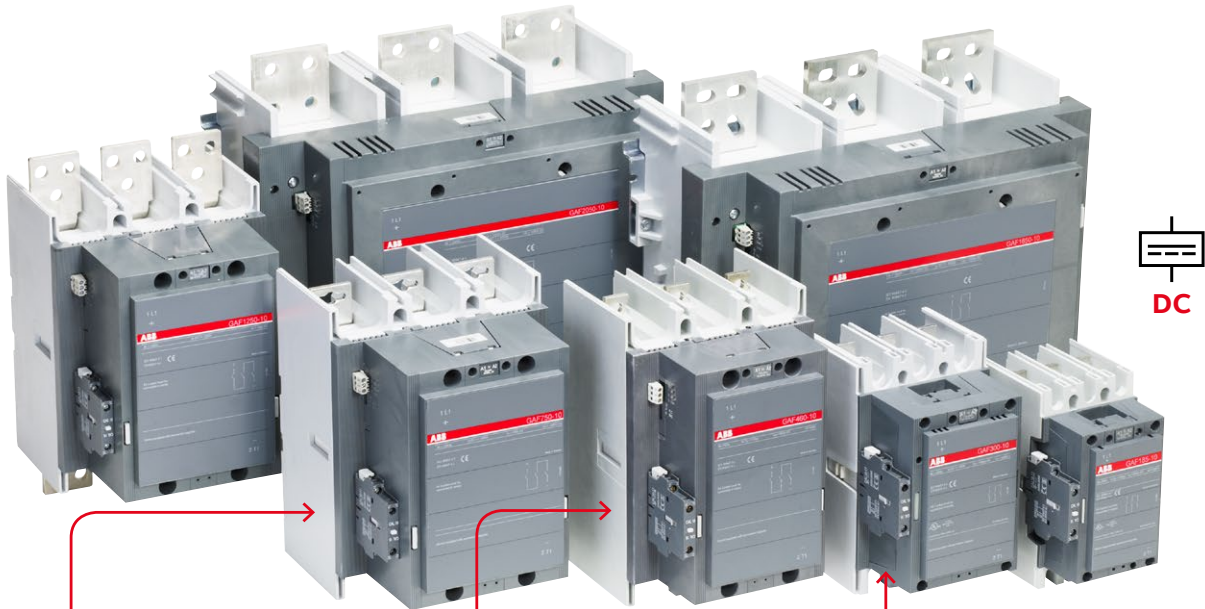

**Up to 2050 A  
1000 V DC-1**

The GAF range of DC contactors extends from 250 A up to 2050 A for DC-1 and UL DC general use at 1000 V.

**Proven technology**

The GAF range of contactor is based on the tested and well proven AFcontactor range. The GAF share all accessories with the AF range, reducing the number of parts needed.

**Easy selection**

The GAF contactors feature ABB's AF technology and all of its features. With only four coils the entire voltage range of 20 V DC and 24 V AC to 500 V AC / DC is covered. The built in surge suppression takes away the need of a separate surge suppressor. All to enable easier selection of contactors.

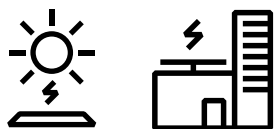

**PV plant applications for DC switching**

Contactors are typically selected for applications that need remote control and switching of the central inverter's DC side at least once per day. Application examples include: disconnection of the inverter from PV strings; or changing the string configuration to increase plant capacity.



# GAF contactors

The compact efficient way to switch DC loads

## Optimised for central inverters

ABB offers the widest range of compact contactors for DC load switching in low voltage power distribution applications. Due to their breaking performance for DC circuits, GAF contactors can switch DC loads of up to 2050 A 1000 V DC-1.

### PV solar plant

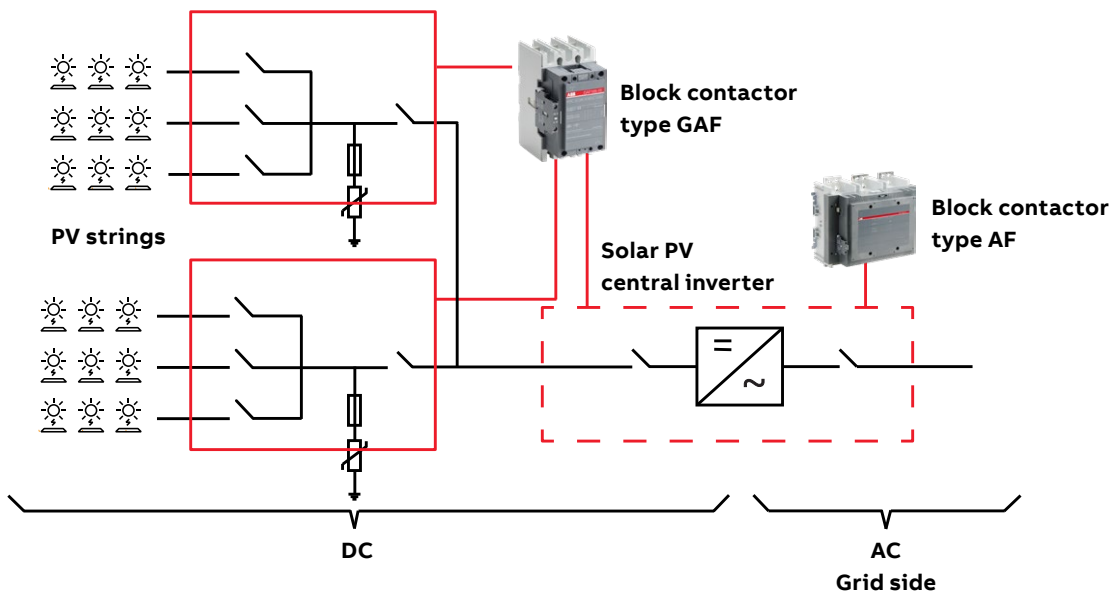



## — Contactors for DC switching applications

DC-1, DC-3, DC-5 applications according to IEC 60947-4-1

The circuit switching on DC is more difficult than on AC, as alternating current goes to zero according to the frequency of the supply source while DC current has a continuous value.

The main parameters to be considered for selecting a contactor are the current, the voltage and the L/R time constant of the controlled load.

### Time constant and utilization categories

In DC applications, the nature of load to switch (resistor, inductance or a combination) is characterized by the ratio of the inductance to the resistance ( $L$  (inductance of operated circuit) /  $R$  (resistance of operated circuit) =  $\text{mH}/\Omega = \text{ms}$ )

This ratio  $L/R$  is called the time constant of the circuit.

DC current utilization categories are defined according to IEC 60947-4-1:

- DC-1 non inductive or slightly inductive loads, resistance furnaces ( $L/R \leq 1 \text{ ms}$ )
- DC-3 shunt motors: starting, plugging, inching, dynamic breaking of DC motors ( $L/R \leq 2 \text{ ms}$ )
- DC-5 series motors: starting, plugging, inching, dynamic breaking of DC motors ( $L/R \leq 7.5 \text{ ms}$ ).

The higher the time constant value is, the more difficult it is to break the arc.

The addition of a resistor in parallel with an inductive winding helps in the elimination of the arcs, by reducing the time constant.

### Operational voltage

- The higher the operational voltage value is, the more difficult it is to break the arc.
- The use of main poles connected in series will allow to increase the value of switched voltage.

However, the maximum switched voltage must be within the max operational voltage of the contactor.

All the poles required for breaking must be connected in series between the load and the source polarity not linked to earth (or chassis) (see recommended connection diagrams).

### ABB offer a large choice of possibilities for DC switching applications (see selection tables):

- Standard 3-pole or 4-pole contactors with either 1-pole breaking or breaking with poles connected in series.
- Special contactors designed for DC breaking with permanent magnets fitted on the main poles for use with the 3 poles connected in series and considered as 1-pole devices:
  - GA75 and GAE75 contactors: the 3 poles are connected in series via two supplied and fitted insulated connections ( $25 \text{ mm}^2$ )
  - GAF145 ... GAF2050 contactors: the 3 poles must be connected in series by the user according to conductor cross-sectional area (refer to main pole technical data) or by using LP connection bars to be ordered separately.

### Selection tables

The enclosed selection tables will guide your choice through all contactor variants according to utilization category, for operational voltage up to 1000 V DC-1 and operational current up to 2050 A in ambient temperatures from  $-25 \text{ }^\circ\text{C}$  up to  $40 \text{ }^\circ\text{C}$ . For higher values of current or voltage or heavy DC switching applications see bar mounted R contactors.

# Connection diagrams

## Connection diagrams

### Recommended connection

In the example below, the 3 poles are connected in series without the load in between. This connection is recommended in systems according to the following configurations.

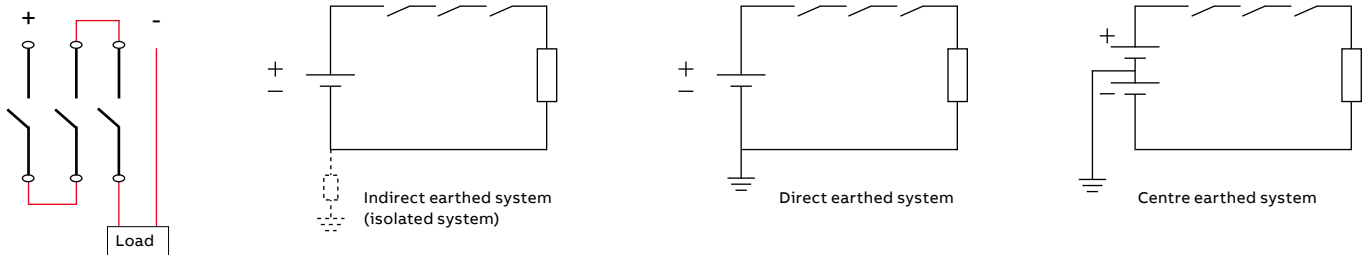

### Alternative connection (not possible for GA75, GAE75)

The load could be placed in between the contacts in a indirect earthed system. If not connected according to the configuration below, a fault to earth could result in one or two contacts breaking the full load which the contactor is not approved for.

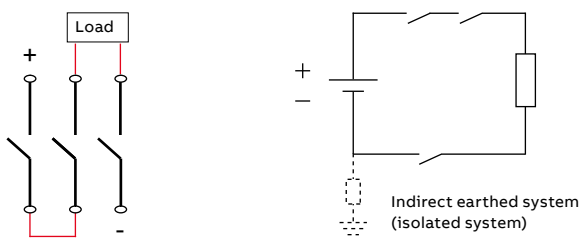

### Points to consider

The above relates to power circuit switching. The SCPD (Short Circuit Protection Device) must comply with applicable protection rules.

### Polarity:

For all GA, GAE, GAF types, connection polarities must be respected.  
(See instruction leaflet and see markings on the main terminals or the contactor front)

# AF09 ... AF96 contactors

## DC circuit switching

### General

The arc switching on DC is more difficult than on AC.

- For selecting a contactor it is essential to determine the current, the voltage and the L/R time constant of the controlled load
- For information, typical time constant values are quoted hereafter: non inductive loads such as resistance furnaces (L/R ≈ 1 ms), inductive loads such as shunt motors (L/R ≈ 2 ms) or series motors (L/R ≈ 7.5 ms)
- The addition of a resistor in parallel with an inductive winding helps in the elimination of the arcs
- All the poles required for breaking must be connected in series between the load and the source polarity not linked to earth (or chassis).



### Technical data

- The tables indicate for the standard contactors the I<sub>e</sub> max. operating currents depending on: the utilization category (i.e. L/R) DC-1, DC-3, DC-5 as defined in the IEC 60947-4-1 publication, the operating voltage U<sub>e</sub> and the pole coupling details.  
Ampere values quoted in these tables are valid for a -25...+70 °C temperature close to the contactors, as long as these values do not exceed the AC-1 Ampere values for the corresponding ambient temperature
- Max. switching frequency: 300 cycles/h.



### Selection table

Contactor types	AF09	AF12	AF16	AF26	AF30	AF38	AF40	AF52	AF65	AF80	AF96
	3 or 4-pole			3-pole	4-pole	3-pole	3-pole	4-pole	3-pole	3-pole	3-pole

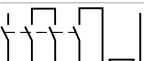

#### Utilization category DC-1, L/R ≤ 1 ms

	≤ 72 V	25 A	27 A	30 A	45 A	45 A	50 A	50 A	55 A	70 A	100 A	105 A	125 A	130 A
	110 V	10 A	15 A	20 A	-	-	-	-	-	-	-	-	-	-
	220 V	-	-	-	-	-	-	-	-	-	-	-	-	-
	≤ 72 V	25 A	27 A	30 A	45 A	45 A	50 A	50 A	55 A	70 A	100 A	105 A	125 A	130 A
	110 V	25 A	27 A	30 A	45 A	45 A	50 A	50 A	55 A	70 A	100 A	105 A	125 A	130 A
	220 V	10 A	15 A	20 A	-	-	-	-	-	-	-	-	-	-
	≤ 72 V	25 A	27 A	30 A	45 A	45 A	50 A	50 A	55 A	70 A	100 A	105 A	125 A	130 A
	110 V	25 A	27 A	30 A	45 A	45 A	50 A	50 A	55 A	70 A	100 A	105 A	125 A	130 A
	220 V	25 A	27 A	30 A	45 A	45 A	50 A	50 A	55 A	70 A	100 A	105 A	125 A	130 A
	≤ 72 V	25 A	-	30 A	-	45 A	-	-	55 A	-	-	-	-	-
	110 V	25 A	-	30 A	-	45 A	-	-	55 A	-	-	-	-	-
	220 V	25 A	-	30 A	-	45 A	-	-	55 A	-	-	-	-	-
	440 V	10 A	-	20 A	-	-	-	-	-	-	-	-	-	-

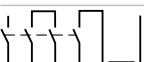
#### Utilization category DC-3, L/R ≤ 2 ms

	≤ 72 V	25 A	27 A	30 A	45 A	-	50 A	50 A	-	70 A	100 A	105 A	125 A	130 A
	110 V	6 A	7 A	8 A	-	-	-	-	-	-	-	-	-	-
	220 V	-	-	-	-	-	-	-	-	-	-	-	-	-
	≤ 72 V	25 A	27 A	30 A	45 A	-	50 A	50 A	-	70 A	100 A	105 A	125 A	130 A
	110 V	25 A	27 A	30 A	45 A	-	50 A	50 A	-	70 A	100 A	105 A	125 A	130 A
	220 V	6 A	7 A	8 A	-	-	-	-	-	-	-	-	-	-
	≤ 72 V	25 A	27 A	30 A	45 A	-	50 A	50 A	-	70 A	100 A	105 A	125 A	130 A
	110 V	25 A	27 A	30 A	45 A	-	50 A	50 A	-	70 A	100 A	105 A	125 A	130 A
	220 V	25 A	27 A	30 A	45 A	-	50 A	50 A	-	70 A	100 A	105 A	125 A	130 A
	≤ 72 V	25 A	-	30 A	-	-	-	-	-	-	-	-	-	-
	110 V	25 A	-	30 A	-	-	-	-	-	-	-	-	-	-
	220 V	25 A	-	30 A	-	-	-	-	-	-	-	-	-	-
	440 V	6 A	-	8 A	-	-	-	-	-	-	-	-	-	-

#### Utilization category DC-5, L/R ≤ 7.5 ms

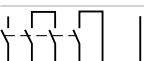
	≤ 72 V	9 A	12 A	16 A	20 A	-	25 A	25 A	-	70 A	100 A	105 A	125 A	130 A
	110 V	4 A	4 A	4 A	-	-	-	-	-	-	-	-	-	-
	220 V	-	-	-	-	-	-	-	-	-	-	-	-	-
	≤ 72 V	25 A	27 A	30 A	45 A	-	50 A	50 A	-	70 A	100 A	105 A	125 A	130 A
	110 V	10 A	15 A	20 A	45 A	-	50 A	50 A	-	70 A	100 A	105 A	125 A	130 A
	220 V	4 A	4 A	4 A	-	-	-	-	-	-	-	-	-	-
	≤ 72 V	25 A	27 A	30 A	45 A	-	50 A	50 A	-	70 A	100 A	105 A	125 A	130 A
	110 V	25 A	27 A	30 A	45 A	-	50 A	50 A	-	70 A	100 A	105 A	125 A	130 A
	220 V	9 A	12 A	16 A	20 A	-	25 A	25 A	-	70 A	100 A	105 A	125 A	130 A
	≤ 72 V	25 A	-	30 A	-	-	-	-	-	-	-	-	-	-
	110 V	25 A	-	30 A	-	-	-	-	-	-	-	-	-	-
	220 V	10 A	-	20 A	-	-	-	-	-	-	-	-	-	-
	440 V	4 A	-	4 A	-	-	-	-	-	-	-	-	-	-

For additional ratings ≥ 440 V, please consult us.

Note: For AFS09 ... AFS96 safety contactors, DC switching rating are the same as AF09 ... AF96 3-pole contactors.

# AF116 ... AF2650 contactors

## DC circuit switching

### Selection table

Contactor types	AF116	AF140	AF146	AF190	AF205	AF265	AF305	AF370	AF400	AF460	AF580	AF750	AF1250	AF1350	AF1650	AF2050	AF2650
	3 or 4-pole			3-pole		3 or 4-pole			3-pole								

### Utilization category DC-1, L/R ≤ 1 ms

	≤ 72 V	160	200	200	250	350	400	500	520	600 A	700 A	800 A	1050 A	1250 A	1350 A	1650 A	2050 A	2650 A
	90 V	160	200	200	250	350	400	500	520	-	-	-	-	-	-	-	-	-
	100 V	-	-	-	250	350	400	500	520	-	-	-	-	-	-	-	-	-
	110 V	-	-	-	-	-	400	500	520	600 A	700 A	800 A	1050 A	1250 A	1350 A	1650 A	2050 A	2650 A
	≤ 72 V	160	200	200	250	350	400	500	520	600 A	700 A	800 A	1050 A	1250 A	1350 A	1650 A	2050 A	2650 A
	110 V	160	200	200	250	350	400	500	520	600 A	700 A	800 A	1050 A	1250 A	1350 A	1650 A	2050 A	2650 A
	175 V	160	200	200	250	350	400	500	520	600 A	700 A	800 A	1050 A	-	-	-	-	-
	200 V	-	-	-	250	350	400	500	520	600 A	700 A	800 A	1050 A	-	-	-	-	-
	≤ 72 V	160	200	200	250	350	400	500	520	600 A	700 A	800 A	1050 A	1250 A	1350 A	1650 A	2050 A	2650 A
	110 V	160	200	200	250	350	400	500	520	600 A	700 A	800 A	1050 A	1250 A	1350 A	1650 A	2050 A	2650 A
	220 V	160	200	200	250	350	400	500	520	600 A	700 A	800 A	1050 A	1250 A	1350 A	1650 A	2050 A	2650 A
	260 V	160	200	200	250	350	400	500	520	600 A	700 A	800 A	1050 A	1250 A	1350 A	1650 A	2050 A	2650 A
	300 V	-	-	-	250	350	400	500	520	600 A	700 A	800 A	1050 A	1250 A	1350 A	1650 A	2050 A	2650 A
	340 V	-	-	-	-	-	400	500	520	600 A	700 A	800 A	1050 A	1250 A	1350 A	1650 A	2050 A	2650 A
	440 V	-	-	-	-	-	-	-	-	600 A	700 A	800 A	1050 A	1250 A	1350 A	1650 A	2050 A	2650 A
	600 V	-	-	-	-	-	-	-	-	600 A	700 A	800 A	1050 A	1250 A	1350 A	1650 A	2050 A	2650 A
	780 V	-	-	-	-	-	-	-	-	600 A	700 A	800 A	1050 A	1250 A	1350 A	1650 A	2050 A	2650 A
	850 V	-	-	-	-	-	-	-	-	-	-	800 A	1050 A	1250 A	1350 A	1650 A	2050 A	2650 A
	< 350 V	200	200	-	250	350	400	500	520	-	-	-	-	-	-	-	-	
	400 V	-	-	-	250	350	400	500	520	-	-	-	-	-	-	-	-	
	440 V	-	-	-	-	-	400	500	520	-	-	-	-	-	-	-	-	

(1) AF2650 at 780 V DC = 2650 A

### Utilization category DC-3, L/R ≤ 2 ms

	≤ 72 V	-	-	-	-	-	-	-	-	600 A	700 A	800 A	1050 A	-	-	-	-
	110 V	-	-	-	-	-	-	-	-	600 A	700 A	800 A	1050 A	-	-	-	-
	≤ 72 V	145 A	160 A	-	250 A	275 A	350 A	400 A	450 A	600 A	700 A	800 A	1050 A	-	-	-	-
	110 V	145 A	160 A	-	250 A	275 A	350 A	400 A	450 A	600 A	700 A	800 A	1050 A	-	-	-	-
	220 V	-	-	-	-	-	-	-	-	600 A	700 A	800 A	1050 A	-	-	-	-
	≤ 72 V	145 A	160 A	-	250 A	275 A	350 A	400 A	450 A	600 A	700 A	800 A	1050 A	-	-	-	-
	110 V	145 A	160 A	-	250 A	275 A	350 A	400 A	450 A	600 A	700 A	800 A	1050 A	-	-	-	-
	220 V	145 A	160 A	-	250 A	275 A	350 A	400 A	450 A	600 A	700 A	800 A	1050 A	-	-	-	-
	440 V	-	-	-	-	-	-	-	-	600 A	700 A	800 A	1050 A	-	-	-	-
	320 V	145 A	160 A	-	250 A	275 A	350 A	400 A	450 A	-	-	-	-	-	-	-	-

### Utilization category DC-5, L/R ≤ 7.5 ms

	≤ 72 V	-	-	-	-	-	-	-	-	600 A	700 A	800 A	1050 A	-	-	-	-
	110 V	-	-	-	-	-	-	-	-	600 A	700 A	800 A	1050 A	-	-	-	-
	≤ 72 V	145 A	160 A	-	250 A	275 A	350 A	400 A	450 A	600 A	700 A	800 A	1050 A	-	-	-	-
	110 V	145 A	160 A	-	250 A	275 A	350 A	400 A	450 A	600 A	700 A	800 A	1050 A	-	-	-	-
	220 V	-	-	-	-	-	-	-	-	600 A	700 A	800 A	1050 A	-	-	-	-
	≤ 72 V	145 A	160 A	-	250 A	275 A	350 A	400 A	450 A	600 A	700 A	800 A	1050 A	-	-	-	-
	110 V	145 A	160 A	-	250 A	275 A	350 A	400 A	450 A	600 A	700 A	800 A	1050 A	-	-	-	-
	220 V	145 A	160 A	-	250 A	275 A	350 A	400 A	450 A	600 A	700 A	800 A	1050 A	-	-	-	-
	440 V	-	-	-	-	-	-	-	-	600 A	700 A	800 A	1050 A	-	-	-	-
	320 V	145 A	160 A	-	250 A	275 A	350 A	400 A	450 A	-	-	-	-	-	-	-	-









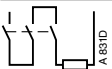
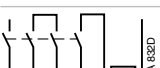

For additional ratings ≥ 440 V, please consult us.

# EK550, EK1000 contactors

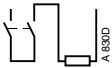
## DC circuit switching

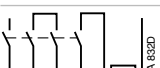
03

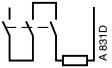
### Selection table

Contactor types	EK550		EK1000	
<b>Utilization category DC-1, L/R ≤ 1 ms</b>				
 A 829D	≤ 72 V	A	550	-
	110 V	A	550	-
 A 830D	≤ 72 V	A	800	-
	110 V	A	800	-
	220 V	A	800	-
 A 831D	≤ 72 V	A	800	-
	110 V	A	800	-
	220 V	A	800	-
	440 V	A	650	-
	600 V	A	650	-
 A 832D	≤ 72 V	A	800	-
	110 V	A	800	-
	220 V	A	800	-
	440 V	A	650	-
	600 V	A	650	-
<b>Utilization category DC-3, L/R ≤ 2 ms</b>				
 A 839D	≤ 72 V	A	550	-
	≤ 72 V	A	650	-
 A 830D	110 V	A	650	-
	220 V	A	650	-
	≤ 72 V	A	650	-
 A 831D	110 V	A	650	-
	220 V	A	650	-
	440 V	A	650	-
	600 V	A	650	-
	≤ 72 V	A	650	-
 A 832D	110 V	A	650	-
	220 V	A	650	-
	440 V	A	650	-
	600 V	A	650	-
	≤ 72 V	A	650	-
<b>Utilization category DC-5, L/R ≤ 7.5 ms</b>				
 A 830D	≤ 72 V	A	650	-
	110 V	A	650	-
	220 V	A	650	-
 A 831D	≤ 72 V	A	650	-
	110 V	A	650	-
	220 V	A	650	-
	440 V	A	650	-
	600 V	A	650	-
 A 832D	≤ 72 V	A	650	-
	110 V	A	650	-
	220 V	A	650	-
	440 V	A	650	-
	600 V	A	650	-

—  
**Notes**

A large rectangular area filled with a grid of small, light gray dotted lines, intended for handwritten notes.



# GA75 1-pole contactors

## 100 A DC-1

### AC operated



GA75-10-11

GA75 contactors are designed for controlling shunt or series motors and resistive or slightly inductive loads up to 1000 V DC.

These contactors are of the block type design with 3 main poles connected in series.

- main poles arc chutes fitted with permanent magnets specially designed for DC breaking. The connection polarities must be respected.
- control circuit: AC operated
- add-on auxiliary contact blocks for side mounting and a wide range of accessories.

IEC Rated operational current $\theta \leq 55^\circ\text{C}$ 440 V DC-1 A	UL / CSA General use rating  440 V DC  A	Rated control circuit voltage Uc (1)		Auxiliary contacts fitted  Y L	Type	Order code	Weight  Pkg (1 pce)  kg
		V 50 Hz	V 60 Hz				
100	100	24	24	0 0	GA75-10-00	1SBL411025R8100	1.220
				1 1	GA75-10-11	1SBL411025R8111	1.260
		48	48	0 0	GA75-10-00	1SBL411025R8300	1.220
				1 1	GA75-10-11	1SBL411025R8311	1.260
		110	110...120	0 0	GA75-10-00	1SBL411025R8400	1.220
				1 1	GA75-10-11	1SBL411025R8411	1.260
		220...230	230...240	0 0	GA75-10-00	1SBL411025R8000	1.220
				1 1	GA75-10-11	1SBL411025R8011	1.260
		230...240	240...260	0 0	GA75-10-00	1SBL411025R8800	1.220
				1 1	GA75-10-11	1SBL411025R8811	1.260
		380...400	400...415	0 0	GA75-10-00	1SBL411025R8500	1.220
				1 1	GA75-10-11	1SBL411025R8511	1.260
		400...415	415...440	0 0	GA75-10-00	1SBL411025R8600	1.220
				1 1	GA75-10-11	1SBL411025R8611	1.260

(1) Other control voltages see voltage codes table.

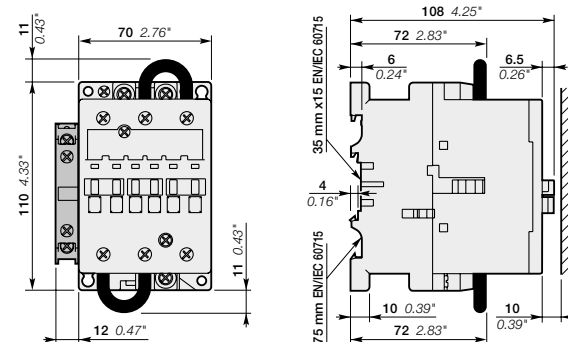

GA75-10-11

Main dimensions mm, inches

# GAE75 1-pole contactors

## 100 A DC-1

DC operated



GAE75-10-11

GAE75 contactors are designed for controlling shunt or series motors and resistive or slightly inductive loads up to 1000 V DC.

These contactors are of the block type design with 3 main poles connected in series.

- main poles arc chutes fitted with permanent magnets specially designed for DC breaking. The connection polarities must be respected.
- control circuit: DC operated with double winding coil (and factory mounted lagging contact for "holding" winding insertion)
- add-on auxiliary contact blocks for side mounting and a wide range of accessories

IEC	UL/CSA	Rated control circuit voltage U <sub>c</sub> (1)	Auxiliary contacts fitted	Type	Order code	Weight
Rated operational current θ ≤ 55 °C 440 V DC-1 A	General use rating  440 V DC  A	V DC				Pkg (1 pce)  kg
100	100	12	0 0	GAE75-10-00	1SBL419025R8000	1.260
			1 1	GAE75-10-11	1SBL419025R8011	1.300
		24	0 0	GAE75-10-00	1SBL419025R8100	1.260
			1 1	GAE75-10-11	1SBL419025R8111	1.300
		48	0 0	GAE75-10-00	1SBL419025R8300	1.260
			1 1	GAE75-10-11	1SBL419025R8311	1.300
		110	0 0	GAE75-10-00	1SBL419025R8600	1.260
			1 1	GAE75-10-11	1SBL419025R8611	1.300
		125	0 0	GAE75-10-00	1SBL419025R8700	1.260
			1 1	GAE75-10-11	1SBL419025R8711	1.300
		220	0 0	GAE75-10-00	1SBL419025R8800	1.260
			1 1	GAE75-10-11	1SBL419025R8811	1.300
		240	0 0	GAE75-10-00	1SBL419025R8900	1.260
			1 1	GAE75-10-11	1SBL419025R8911	1.300

(1) Other control voltages see voltage codes table.

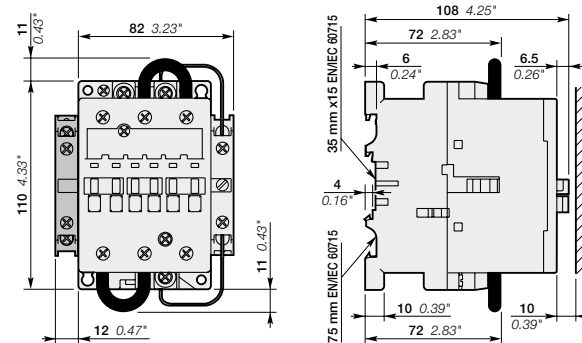

GAE75-10-11  
Main dimensions mm, inches

# GAF185 ... GAF300 3-pole contactors

## 250 to 400 A DC-1

AC / DC operated with 1 N.O. + 1 N.C. auxiliary contacts



GAF185-10-11



GAF300-10-11

GAF185 ... GAF300 contactors are designed for controlling resistive or slightly inductive loads up to 1000 V DC.

These contactors are of the block type design with 3 main poles for connection in series by the user according to conductor cross-sectional area or by using LP connection bars to be ordered separately.

- main poles arc chutes fitted with permanent magnets specially designed for DC breaking. The connection polarities must be respected.
- control circuit: AC or DC operated with electronic coil interface accepting a wide control voltage range (e.g. 100...250 V AC and DC), only 3 coils to cover control voltages between 48...250 V 50/60 Hz and 20...250 V DC
  - can manage large control voltage variations
  - reduced panel energy consumption
  - very distinct closing and opening
  - can withstand short voltage dips and voltage sags (SEMI F47 conditions of use on request).
- built-in surge suppression
- add-on auxiliary contact blocks for side mounting and a wide range of accessories.

IEC	UL / CSA		Rated control circuit voltage		Auxiliary contacts fitted	Type	Order code	Weight
	Rated operational current $\theta \leq 55^\circ\text{C}$ 1000 V DC-1 A	General use rating $\theta \leq 40^\circ\text{C}$ 1000 V DC A	V 50/60 Hz	V DC				
250	250		-	20...60	1 1	GAF185-10-11 (1)	1SFL497025R7211	3.600
			48...130	48...130	1 1	GAF185-10-11	1SFL497025R6911	3.600
			100...250	100...250	1 1	GAF185-10-11	1SFL497025R7011	3.600
400	400		-	20...60	1 1	GAF300-10-11 (1)	1SFL557025R7211	6.200
			48...130	48...130	1 1	GAF300-10-11	1SFL557025R6911	6.200
			100...250	100...250	1 1	GAF300-10-11	1SFL557025R7011	6.200

(1) The connection polarities indicated close to the coil terminals must be respected: A1 for the positive pole and A2 for the negative pole.

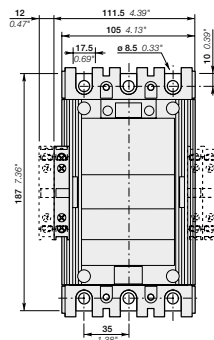

GAF185

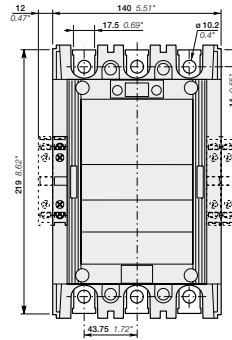
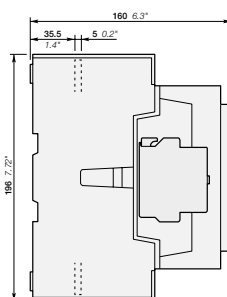

GAF300

Main dimensions mm, inches

# GAF460 ... GAF750 3-pole contactors

## 600 to 875 A DC-1

AC / DC operated with 1 N.O. + 1 N.C. auxiliary contacts



GAF460-10-11



GAF750-10-11

GAF460 ... GAF750 contactors are designed for controlling resistive or slightly inductive loads up to 1000 V DC.

These contactors are of the block type design with 3 main poles for connection in series by the user according to conductor cross-sectional area or by using LP connection bars to be ordered separately.

- main poles arc chutes fitted with permanent magnets specially designed for DC breaking. The connection polarities must be respected.
- control circuit: AC or DC operated with electronic coil interface accepting a wide control voltage range (e.g. 100...250 V AC and DC), only 4 coils to cover control voltages between 48...500 V 50/60 Hz and 24...500 V DC
  - can manage large control voltage variations
  - reduced panel energy consumption
  - very distinct closing and opening
  - can withstand short voltage dips and voltage sags (SEMI F47 conditions of use on request).
- built-in surge suppression
- add-on auxiliary contact blocks for side mounting and a wide range of accessories.

IEC Rated operational current $\theta \leq 55^\circ\text{C}$ 1000 V DC-1	UL / CSA General use rating $\theta \leq 40^\circ\text{C}$ 1000 V DC	Rated control circuit voltage Uc		Auxiliary contacts fitted  ⎓	Type	Order code	Weight  Pkg (1 pce)  kg
		V 50/60 Hz	V DC				
600	650	-	24...60	1 1	GAF460-10-11 (1)	1SFL597025R6811	12.000
		48...130	48...130	1 1	GAF460-10-11	1SFL597025R6911	12.000
		100...250	100...250	1 1	GAF460-10-11	1SFL597025R7011	12.000
		250...500	250...500	1 1	GAF460-10-11	1SFL597025R7111	12.000
875	900	-	24...60	1 1	GAF750-10-11 (1)	1SFL637025R6811	15.000
		48...130	48...130	1 1	GAF750-10-11	1SFL637025R6911	15.000
		100...250	100...250	1 1	GAF750-10-11	1SFL637025R7011	15.000
		250...500	250...500	1 1	GAF750-10-11	1SFL637025R7111	15.000

(1) The connection polarities indicated close to the coil terminals must be respected: A1 for the positive pole and A2 for the negative pole.

GAF460 ... GAF750 are equipped with low voltage inputs for control, for example by a PLC.

### Control inputs

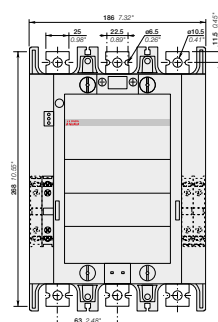
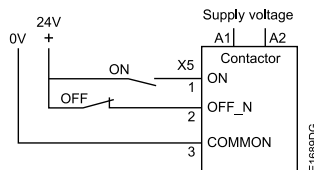

GAF460

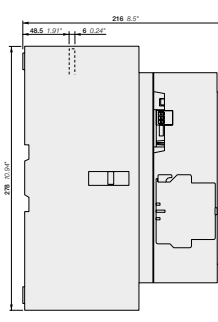

GAF750

Main dimensions mm, inches

# GAF1250 ... GAF2050 3-pole contactors

## 1040 to 1750 A DC-1

AC / DC operated with 1 N.O. + 1 N.C. auxiliary contacts



15FC101004F0201

GAF1250-10-11

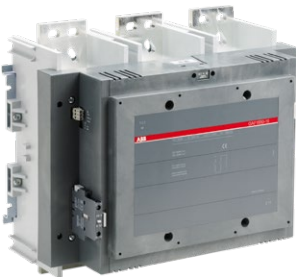

15FC101004F0201

GAF1650-10-11

GAF1250 ... GAF2050 contactors are designed for controlling resistive or slightly inductive loads up to 1000 V DC.

These contactors are of the block type design with 3 main poles for connection in series by the user according to conductor cross-sectional area or by using LP connection bars to be ordered separately.

- main poles arc chutes fitted with permanent magnets specially designed for DC breaking. The connection polarities must be respected.
- control circuit: AC or DC operated with electronic coil interface accepting a wide control voltage range (e.g. 100...250 V AC and DC), only 4 coils to cover control voltages between 48...500 V 50/60 Hz and 24...500 V DC
  - can manage large control voltage variations
  - reduced panel energy consumption
  - very distinct closing and opening
  - can withstand short voltage dips and voltage sags (SEMI F47 conditions of use on request).
- built-in surge suppression
- add-on auxiliary contact blocks for side mounting and a wide range of accessories.

IEC Rated operational current $\theta \leq 55^\circ\text{C}$ 1000 V DC-1	UL / CSA General use rating $\theta \leq 40^\circ\text{C}$ 1000 V A	Rated control circuit voltage Uc		Auxiliary contacts fitted	Type	Order code	Weight Pkg (1 pce) kg
		V 50/60 Hz	V DC				
1040	1210	-	24...60	1 1	GAF1250-10-11	1SFL647025R6811	16.000
		48...130	48...130	1 1	GAF1250-10-11	1SFL647025R6911	16.000
		100...250	100...250	1 1	GAF1250-10-11	1SFL647025R7011	16.000
		250...500	250...500	1 1	GAF1250-10-11	1SFL647025R7111	16.000
1450	1650	100...250	100...250	1 1	GAF1650-10-11	1SFL677025R7011	35.000
1750	2050	100...250	100...250	1 1	GAF2050-10-11	1SFL707025R7011	35.000

GAF1250 ... AF2050 are equipped with low voltage inputs for control, for example by a PLC

### Control inputs

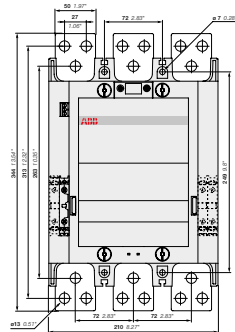
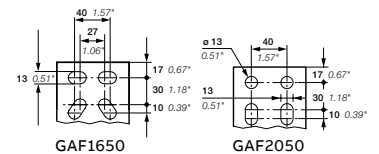
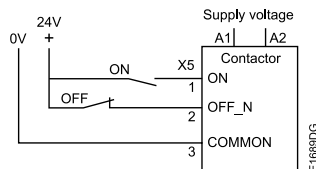

GAF1250

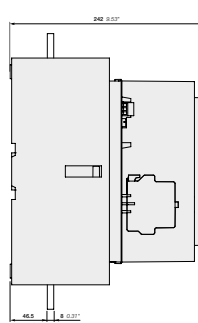

GAF1650, GAF2050

Main dimensions mm, inches

15FC101025FC0201 - Rev. B

# GA75 ... GAF2050 contactors

## Technical data

### Main pole - Utilization characteristics according to IEC

Contactor types	AC operated	GA75							
	DC operated	GAE75							
	AC / DC operated	GAF185	GAF300	GAF460	GAF750	GAF1250	GAF1650	GAF2050	
Standards	IEC 60947-1 / 60947-4-1 and EN 60947-1 / 60947-4-1								
Rated operational voltage Ue max.	1000 V DC								
DC-1 Utilization category, L/R ≤ 1 ms For air temperature close to contactor Ie / Rated operational current DC-1									
θ ≤ 40 °C	220 V	120 A	275 A	500 A	700 A	1050 A	1250 A	1650 A	2050 A
	440 V	100 A	275 A	500 A	700 A	1050 A	1250 A	1650 A	2050 A
	600 V	75 A	275 A	500 A	700 A	1050 A	1250 A	1650 A	2050 A
	1000 V	35 A	275 A	500 A	700 A	1050 A	1250 A	1650 A	2050 A
θ ≤ 55 °C	220 V	100 A	250 A	400 A	600 A	875 A	1040 A	1450 A	1750 A
	440 V	100 A	250 A	400 A	600 A	875 A	1040 A	1450 A	1750 A
	600 V	75 A	250 A	400 A	600 A	875 A	1040 A	1450 A	1750 A
	1000 V	35 A	250 A	400 A	600 A	875 A	1040 A	1450 A	1750 A
θ ≤ 70 °C	220 V	85 A	180 A	325 A	480 A	720 A	875 A	1270 A	1500 A
	440 V	85 A	180 A	325 A	480 A	720 A	875 A	1270 A	1500 A
	600 V	75 A	180 A	325 A	480 A	720 A	875 A	1270 A	1500 A
	1000 V	35 A	180 A	325 A	480 A	720 A	875 A	1270 A	1500 A
With conductor cross-sectional area (3)		(1)	150 mm <sup>2</sup>	300 mm <sup>2</sup>	2x 240 mm <sup>2</sup>	2x 50x8 mm <sup>2</sup>	2x 100x5 mm <sup>2</sup>	3x 100x5 mm <sup>2</sup>	4x 100x5 mm <sup>2</sup>
DC-3 Utilization category, L/R ≤ 2 ms Ie / Rated operational current DC-3									
θ ≤ 55 °C	220 V	100 A	-						
	440 V	85 A	-						
DC-5 Utilization category, L/R ≤ 7.5 ms Ie / Rated operational current DC-5									
θ ≤ 55 °C	220 V	85 A	-						
	440 V	35 A	-						
Maximum electrical switching frequency	300 cycles/h								

(1) Refer to IEC 60947-1, table 9.

(2) For currents up to 370 A, use 2 x LP300 kits. For higher currents, use 300 mm<sup>2</sup> conductors of minimum length 500 mm together with terminal extension/enlargement (LX300/LW300).

(3) To minimize terminal temperature for GAF185 ... GAF2050, length of connection should be at least 0.5 m per pole.

### Main pole - Utilization characteristics according to UL / CSA

Contactor types	AC operated	GA75							
	DC operated	GAE75							
	AC / DC operated	GAF185	GAF300	GAF460	GAF750	GAF1250	GAF1650	GAF2050	
Standards	UL 508, CSA C22.2 N°14				UL 60947-4-1, CSA C22.2 N°60947.4-1				
Maximum operational voltage	1000 V DC								
UL / CSA DC general use rating									
θ ≤ 40 °C	440 V	100 A	250 A	400 A	650 A	900 A	1210 A	1650 A	2050 A
	600 V	75 A	250 A	400 A	650 A	900 A	1210 A	1650 A	2050 A
	1000 V	35 A	250 A	400 A	650 A	900 A	1210 A	1650 A	2050 A
Maximum electrical switching frequency	300 cycles/h								

# GA75 and GAE75 contactors

## Technical data

### General technical data

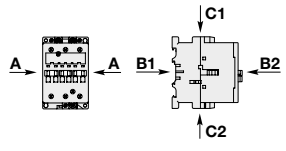
Contactor types	AC operated	<b>GA75</b>
	DC operated	<b>GAE75</b>
Rated insulation voltage Ui acc. to IEC 60947-4-1 acc. to UL		1000 V
		600 V
Rated impulse withstand voltage Uimp.		8 kV
Ambient air temperature close to contactor	Operation	-40...+70 °C
	Storage	-60...+80 °C
Climatic withstand		acc. to IEC 60068-2-30 and 60068-2-11 - UTE C 63-100 specification II
Maximum operating altitude (without derating)		3000 m
Mechanical durability	Number of operating cycles	10 millions operating cycles (5 millions for GAE75)
	Max. switching frequency	3600 cycles/h
Shock withstand acc. to IEC 60068-2-27 and EN 60068-2-27		
Mounting position 1 	Shock direction	1/2 sinusoidal shock for 11 ms: no change in contact position, closed or open position
	A	20 g
	B1	10 g closed position / 5 g open position
	B2	15 g
	C1	20 g
	C2	20 g



# GAF185 ... GAF2050 contactors

## Technical data

### General technical data

Contactor types	AC / DC operated	GAF185	GAF300	GAF460	GAF750	GAF1250	GAF1650	GAF2050
Rated insulation voltage Ui								
acc. to IEC 60947-4-1		1000 V						
acc. to UL		600 V						
Rated impulse withstand voltage Uimp.		8 kV						
Ambient air temperature close to contactor								
Operation		-40 to +70 °C						
Storage		-40 to +70 °C						
Climatic withstand		acc. to IEC 60068-2-30						
Maximum operating altitude (without derating)		3000 m						
Mechanical durability								
Number of operating cycles		5 millions operating cycles					0.5 millions operating cycles	
Max. switching frequency		300 cycles/h					60 cycles/h	
Shock withstand								
acc. to IEC 60068-2-27 and EN 60068-2-27								
Mounting position 1								
	Shock direction	1/2 sinusoidal shock for 30 ms: no change in contact position, closed or open position						
	A	5 g					-	
	B1	5 g					-	
	B2	5 g					-	
	C1	5 g					-	
	C2	5 g					-	

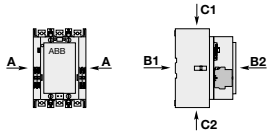

## GA75 and GAE75 contactors

### Technical data

#### Magnet system characteristics

Contactor types	AC operated	<b>GA75</b>	
Coil operating limits acc. to IEC 60947-4-1	AC supply	At $\theta \leq 55^\circ\text{C}$ 0.85...1.1 x $U_c$ Please also refer to "Mounting characteristics and conditions for use"	
AC control voltage			
Rated control circuit voltage $U_c$	at 50 Hz	24...690 V	
	at 60 Hz	24...690 V	
Coil consumption	Average pull-in value	50 Hz	180 VA
		60 Hz	210 VA
	Average holding value	50/60 Hz (1)	190 VA / 180 VA
		50 Hz	18 VA / 5.5 W
		60 Hz	18 VA / 5.5 W
	50/60 Hz (1)	18 VA / 5.5 W	
Drop-out voltage		Approx. 40...65 % of $U_c$	
Operating time			
Between coil energization and:	N.O. contact closing	8...27 ms	
	N.C. contact opening	7...22 ms	
Between coil de-energization and:	N.O. contact opening	4...11 ms	
	N.C. contact closing	7...14 ms	

(1) 50/60 Hz coils: see "Voltage code table".

#### Magnet system characteristics

Contactor types	DC operated	<b>GAE75</b>
Coil operating limits acc. to IEC 60947-4-1	AC supply	At $\theta \leq 55^\circ\text{C}$ 0.85...1.1 x $U_c$ Please also refer to "Mounting characteristics and conditions for use"
DC control voltage		
Rated control circuit voltage $U_c$		12...250 V DC
Coil consumption	Average pull-in value	200 W
	Average holding value	4 W
Drop-out voltage		Approx. 15...40 % of $U_c$
Coil time constant		
Open	L/R	3 ms
Closed	L/R	15 ms
Operating time		
Between coil energization and:	N.O. contact closing	13...30 ms
	N.C. contact opening	10...27 ms
Between coil de-energization and:	N.O. contact opening (1)	5...15 ms
	N.C. contact closing (1)	8...18 ms

(1) The use of surge suppressors increases the opening time with a factor of 1.1 to 1.5 for a RV5 surge suppressor and a factor of 1.5 to 3 for RT5 surge suppressor.

#### Mounting characteristics and conditions for use

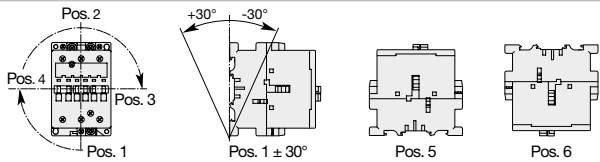
Contactor types	AC operated	<b>GA75</b>
	DC operated	<b>GAE75</b>
Mounting positions		
Control voltage / Ambient temperature		
Mounting positions	1, 1±30°, 2, 3, 4, 5	at $\theta \leq 55^\circ\text{C}$ 0.85...1.1 x $U_c$
		at $\theta \leq 70^\circ\text{C}$ $U_c$
	6	at $\theta \leq 55^\circ\text{C}$ 0.95...1.1 x $U_c$
		at $\theta \leq 70^\circ\text{C}$ Unauthorized
Mounting distances	The contactors can be assembled side by side	
Fixing		
On rail according to IEC 60715, EN 60715	35 x 15 mm or 75 x 25 mm	
By screws (not supplied)	2 x M6 screws placed diagonally	

# GAF185 ... GAF2050 contactors

## Technical data

### Magnet system characteristics

Contactor types	AC / DC operated	GAF185	GAF300	GAF460	GAF750	GAF1250	GAF1650	GAF2050
Coil operating limits acc. to IEC 60947-4-1	AC or DC supply	At $\theta \leq 70^\circ\text{C}$ $0.85 \times U_c \text{ min...} 1.1 \times U_c \text{ max}$ . Please also refer to "Mounting characteristics and conditions for use"						
AC control voltage 50/60 Hz		48...250 V AC			48...500 V AC		100...250 V AC	
Rated control circuit voltage $U_c$		430 VA	470 VA	890 VA	850 VA	1900 VA		
Coil consumption	Average pull-in value	12 VA / 3.5 W	10 VA / 2.5 W	12 VA / 4 W	12 VA / 4.5 W	48 VA / 17 W		
	Average holding value	2 W		4 W	4.5 W	16 W		
DC control voltage		20...250 V DC			24...500 V DC		100...250 V DC	
Rated control circuit voltage $U_c$		500 W	520 W	990 W	950 W	1700 W		
Coil consumption	Average pull-in value	2 W		4 W	4.5 W	16 W		
	Average holding value	2 W		4 W	4.5 W	16 W		
Drop-out voltage		55 % of $U_c \text{ min}$ .						
Dips withstand $-20^\circ\text{C} \leq \theta \leq +60^\circ\text{C}$		$\geq 20 \text{ ms}$						
Operating time								
Coil supply between A1 - A2								
Between coil energization and:	N.O. contact closing	30...115 ms			50...120 ms		50...80 ms	
	N.C. contact opening	30...115 ms			50...120 ms		50...80 ms	
Between coil de-energization and:	N.O. contact opening	25...80 ms			33...70 ms		35...55 ms	
	N.C. contact closing	25...80 ms			33...70 ms		35...55 ms	
Control input for PLC's								
Between coil energization and:	N.O. contact closing	-			40...60 ms	40...90 ms	40...65 ms	
	N.C. contact opening	-			40...60 ms	40...90 ms	40...65 ms	
Between coil de-energization and:	N.O. contact opening	-			10...30 ms		10...30 ms	
	N.C. contact closing	-			10...30 ms		10...30 ms	











### Mounting characteristics and conditions for use

Contactor types	AC / DC operated	GAF185	GAF300	GAF460	GAF750	GAF1250	GAF1650	GAF2050
Mounting positions								
Control voltage / Ambient temperature								
Mounting positions	1, $1 \pm 30^\circ$ , 2, 3, 4, 5 at $\theta \leq 70^\circ\text{C}$	0.85 x $U_c \text{ min...} 1.1 \times U_c \text{ max}$ .						
	6	Unauthorized						
Mounting distances		The contactors can be assembled side by side						
Fixing								
On rail according to IEC 60715, EN 60715		-						
By screws (not supplied)		4 x M5			4 x M6		4 x M8	

## GA75 and GAE75 contactors

### Technical data

#### Connecting characteristics

Contactor types	AC operated	GA75
	DC operated	GAE75
Main terminals		 <p>Screw terminals with single connector (13 x 10 mm)</p>
Connection capacity (min. ... max.)		
Main conductors (poles)		
 Rigid Solid ( $\leq 4 \text{ mm}^2$ )	1 x	6...50 mm <sup>2</sup>
 Stranded ( $\geq 6 \text{ mm}^2$ )	2 x	6...25 mm <sup>2</sup>
 Flexible with ferrule	1 x	6...35 mm <sup>2</sup>
 Flexible with ferrule	2 x	6...16 mm <sup>2</sup>
 Bars or lugs	L $\leq$	-
	L $>$	-
Connection capacity acc. to UL/CSA	1 or 2 x	AWG 8...1
Tightening torque	Recommended	4.00 Nm / 35 lb.in
	Max.	4.50 Nm
Auxiliary conductors (coil terminals)		
 Rigid solid	1 x	1...4 mm <sup>2</sup>
 Rigid solid	2 x	1...4 mm <sup>2</sup>
 Flexible with ferrule	1 x	1...2.5 mm <sup>2</sup>
 Flexible with ferrule	2 x	0.75...2.5 mm <sup>2</sup>
 Lugs	L $\leq$	8 mm
	L $>$	3.7 mm
Connection capacity acc. to UL / CSA	1 or 2 x	AWG 18...14
Tightening torque		
Coil terminals	Recommended	1.00 Nm / 9 lb.in
	Max.	1.20 Nm
Degree of protection acc. to IEC 60947-1 / EN 60947-1 and IEC 60529 / EN 60529		
Main terminals		IP10
Coil terminals		IP20
Screw terminals		Delivered in open position, screws of unused terminals must be tightened
Main terminals		M6
Screwdriver type		Flat $\varnothing$ 6.5 / Pozidriv 2
Coil terminals		M3.5
Screwdriver type		Flat $\varnothing$ 5.5 / Pozidriv 2

# GAF185 ... GAF2050 contactors

## Technical data

### Connecting characteristics

Contactor types	AC / DC operated	GAF185	GAF300	GAF460	GAF750	GAF1250	GAF1650	GAF2050
Main terminals								
Flat type								
Connection capacity (min. ... max.)								
Main conductors (poles)								
Rigid with connector	Single for Cu cable	6...185 mm <sup>2</sup>	16...240 mm <sup>2</sup>	240 mm <sup>2</sup>	300 mm <sup>2</sup>	-	-	-
	Single for Al/Cu cable	25...150 mm <sup>2</sup>	120...240 mm <sup>2</sup>	240 mm <sup>2</sup>	300 mm <sup>2</sup>	-	-	-
	Double for Al/Cu cable	-	2 x 95...120 mm <sup>2</sup>	2 x 240 mm <sup>2</sup>	3 x 185 mm <sup>2</sup>	-	-	-
Bars or lugs	L ≤ 24 mm	32 mm	47 mm	52 mm	100 mm	-	-	-
	∅ > 8 mm	10 mm	10 mm	12 mm	12 mm	-	-	-
Connection capacity acc. to UL/CSA	1 or 2 x	6 - 250 MCM	4 - 500 MCM	2//250 - 500 MCM	3// 2/0 - 500 MCM	1/0 - 750 MCM	-	-
Tightening torque	Recommended	18 Nm / 160 lb.in	28 Nm / 247 lb.in	35 Nm / 310 lb.in	45 Nm / 398 lb.in	45 Nm / 398 lb.in	45 Nm / 398 lb.in	45 Nm / 398 lb.in
	Max.	20 Nm	30 Nm	40 Nm	49 Nm	49 Nm	49 Nm	49 Nm
Auxiliary conductors (coil terminals)								
Rigid solid	1 x	1...4 mm <sup>2</sup>						
	2 x	1...4 mm <sup>2</sup>						
Flexible with ferrule	1 x	0.75...2.5 mm <sup>2</sup>						
	2 x	0.75...2.5 mm <sup>2</sup>						
Lugs	L ≤ 8 mm							
	l > 3.7 mm							
Connection capacity acc. to UL/CSA	1 or 2 x	AWG 18...14						
Tightening torque	Recommended	1.00 Nm / 9 lb.in						
	Max.	1.20 Nm						
Degree of protection acc. to IEC 60947-1 / EN 60947-1 and IEC 60529 / EN 60529								
Main terminals		IP00						
Coil terminals		IP20						
Screw terminals								
Main terminals		M8	M10	M10	M12			
Coil terminals (delivered in open position)		Screws and bolts						
		M3.5						
Screwdriver type		Flat ∅ 5.5 mm / Pozidriv 2						





# —

## Contactors for capacitor switching

### 3/192 **Overview**

#### **UA16..RA up to UA110..RA - Unlimited peak current $\hat{I}$**

- 3/194 Ordering details
- 3/197 Main accessories
- 3/198 Technical data

#### **UA16 up to UA110**

#### **Peak current $\hat{I} \leq 100$ times the rms current**

- 3/200 Ordering details
- 3/203 Main accessories
- 3/204 Technical data

### 3/404 **Voltage code table**



—  
For direct product details information, use product type or order code, ex:

- [www.abb.com/productdetails/AF09-30-10-13](http://www.abb.com/productdetails/AF09-30-10-13)
- or [www.abb.com/productdetails/1SBL137001R1310](http://www.abb.com/productdetails/1SBL137001R1310)



# Contactors for capacitor switching

AC-6b utilization category according to IEC 60947-4-1

## Capacitor transient conditions

In Low Voltage industrial installations, capacitors are mainly used for reactive energy correction (raising the power factor). When these capacitors are energized, overcurrents of high amplitude and high frequencies (3 to 15 kHz) occur during the transient period (1 to 2 ms).

The amplitude of these current peaks, also known as "inrush current peaks", depends on the following factors:

- The network inductances.
- The transformer power and short-circuit voltage.
- The type of power factor correction.

**There are 2 types of power factor correction: fixed or automatic.**

**Fixed power factor correction** consists of inserting, in parallel on the network, a capacitor bank whose total power is provided by the assembly of capacitors of identical or different ratings.

The bank is energized by a contactor that simultaneously supplies all the capacitors (a single step).

The inrush current peak, in the case of fixed correction, can reach 30 times the nominal current of the capacitor bank.



Single-step capacitor bank scheme  
Use the AF... contactor ranges.

**An automatic power factor correction** system, on the other hand, consists of several capacitor banks of identical or different ratings (several steps), energized separately according to the value of the power factor to be corrected.

An electronic device automatically determines the power of the steps to be energized and activates the relevant contactors.

The inrush current peak, in the case of automatic correction, depends on the power of the steps already on duty, and can reach 100 times the nominal current of the step to be energized.

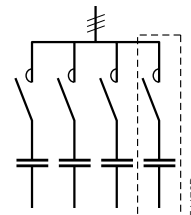

Multi-step capacitor bank scheme  
Use the UA... or UA..RA contactor ranges.

## Steady state condition data

The presence of harmonics and the network's voltage tolerance lead to a current, estimated to be 1.3 times the nominal current  $I_n$  of the capacitor, permanently circulating in the circuit.

Taking into account the manufacturing tolerances, the exact power of a capacitor can reach 1.15 times its nominal power.

Standard IEC 60831-1 Edition 2002 specifies that the capacitor must therefore have a maximum thermal current  $I_T$  of:

$$I_T = 1.3 \times 1.15 \times I_n = 1.5 \times I_n$$

## Consequences for the contactors

To avoid malfunctions (welding of main poles, abnormal temperature rise, etc.), contactors for capacitor bank switching must be sized to withstand:

- **A permanent current that can reach 1.5 times the nominal current of the capacitor bank.**
- **The short but high peak current on pole closing** (maximum permissible peak current  $\hat{I}$ ).

## Contactor selection tool for capacitor switching

In a given application, if the user does not know the value of the inrush current peak, this value can be approximately calculated using the formulas given on the pages "Calculation and dimensioning".

Alternatively by the **CAPCAL selection tool**, available on the ABB Website: [www.abb.com/lowvoltage](http://www.abb.com/lowvoltage)

right hand side menu

search: **"Online product selection tools"**

select: **"Contactors: AC-6b capacitor switching"**

This program allows the calculation of these peaks and gives the references of the ABB contactors according to the installation specifications. This calculation is valid for one or several capacitor banks.

## Contactors for capacitor switching

The ABB solutions

ABB offers 2 contactor versions according to the value of the inrush current peak and the power of the capacitor bank.

**UA..RA contactors for capacitor switching (UA16..RA to UA110..RA) with insertion of damping resistors**

The insertion of damping resistors protects the contactor and the capacitor from the highest inrush currents.

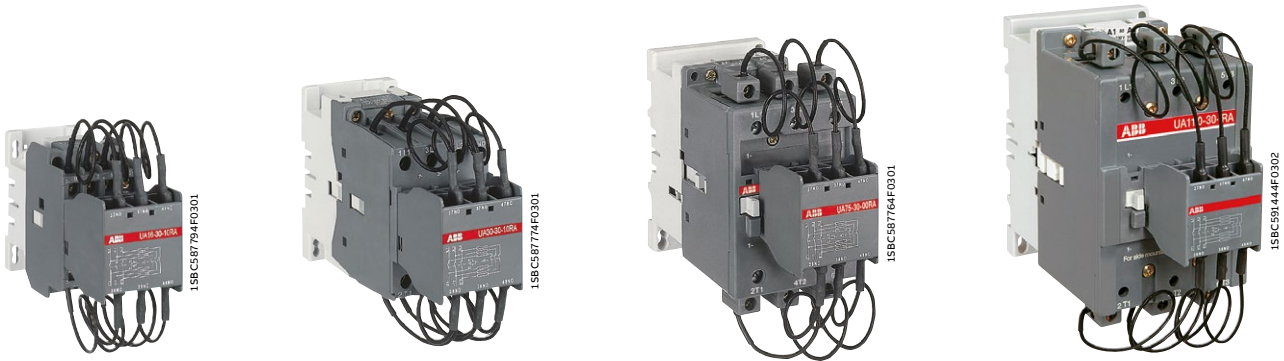

**UA contactors for capacitor switching (UA16 to UA110)**

Maximum permissible peak current  $\hat{I} \leq 100$  times the nominal rms current of the switched capacitor.

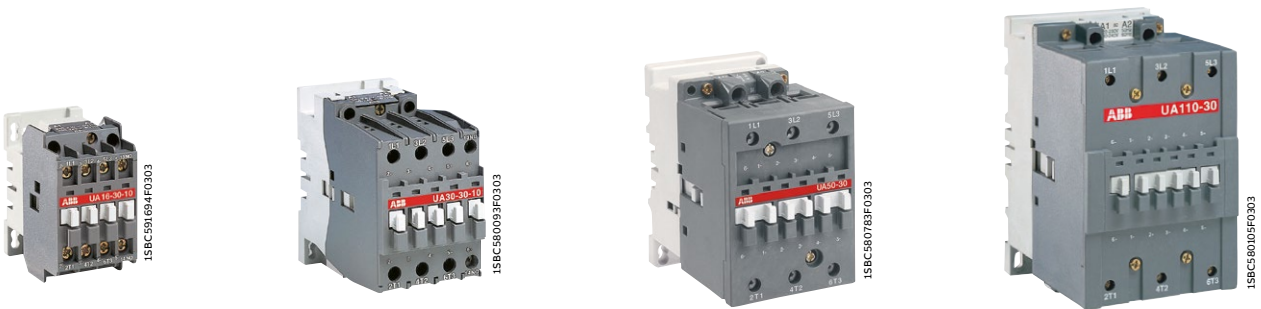

# UA16..RA ... UA30..RA 3-pole contactors for capacitor switching

12.5 to 30 kvar - Unlimited peak current  $\hat{I}$   
AC operated



UA16-30-10RA



UA30-30-10RA

UA..RA contactors for capacitor switching can be used for installations in which the peak current far exceeds 100 times nominal rms current. The contactors are delivered complete with their damping resistors and must be used without additional inductances.

The capacitors must be discharged (maximum residual voltage at terminals  $\leq 50$  V) before being re-energized when the contactors are making.

These contactors are of the block type design with:

- 3 main poles and 1 built-in auxiliary contact
- the UA..RA contactors are fitted with a special front-mounted block, which ensures the serial insertion of 3 damping resistors into the circuit to limit the current peak on energization of the capacitor bank
  - their connection also ensures capacitor precharging in order to limit the second current peak occurring upon making of the main poles
  - the insertion of resistors allows to damp the highest current peak of the capacitor when switching on, whatever its level.
- control circuit: AC operated
- add-on auxiliary contact blocks for side mounting and a wide range of accessories.

IEC	UL/CSA	Rated control circuit voltage U <sub>c</sub> (1)		Auxiliary contacts fitted	Type	Order code	Weight Pkg (1 pce) kg		
		V 50 Hz	V 60 Hz						
Rated operational power $\theta \leq 40^\circ\text{C}$ 400 V AC-6b	Rated operational power $\theta \leq 40^\circ\text{C}$ 480 V								
		kvar	kvar						
12.5	16	24	24	1 0	UA16-30-10RA	1SBL181024R8110	0.460		
		110	110...120	1 0	UA16-30-10RA	1SBL181024R8410	0.460		
		220...230	230...240	1 0	UA16-30-10RA	1SBL181024R8010	0.460		
		230...240	240...260	1 0	UA16-30-10RA	1SBL181024R8810	0.460		
		380...400	400...415	1 0	UA16-30-10RA	1SBL181024R8510	0.460		
		400...415	415...440	1 0	UA16-30-10RA	1SBL181024R8610	0.460		
		22	22	24	24	1 0	UA26-30-10RA	1SBL241024R8110	0.710
				110	110...120	1 0	UA26-30-10RA	1SBL241024R8410	0.710
				220...230	230...240	1 0	UA26-30-10RA	1SBL241024R8010	0.710
				230...240	240...260	1 0	UA26-30-10RA	1SBL241024R8810	0.710
				380...400	400...415	1 0	UA26-30-10RA	1SBL241024R8510	0.710
				400...415	415...440	1 0	UA26-30-10RA	1SBL241024R8610	0.710
30	28	24	24	1 0	UA30-30-10RA	1SBL281024R8110	0.810		
		110	110...120	1 0	UA30-30-10RA	1SBL281024R8410	0.810		
		220...230	230...240	1 0	UA30-30-10RA	1SBL281024R8010	0.810		
		230...240	240...260	1 0	UA30-30-10RA	1SBL281024R8810	0.810		
		380...400	400...415	1 0	UA30-30-10RA	1SBL281024R8510	0.810		
		400...415	415...440	1 0	UA30-30-10RA	1SBL281024R8610	0.810		

(1) Other control voltages see voltage code table.

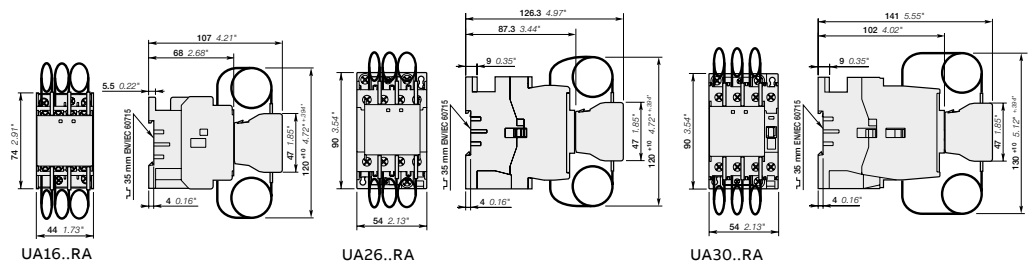

Main dimensions mm, inches

1SBC10150750201-Rev. A

# UA50..RA ... UA75..RA 3-pole contactors for capacitor switching

40 to 60 kvar - Unlimited peak current  $\hat{I}$   
AC operated



UA75-30-00 RA

UA..RA contactors for capacitor switching can be used for installations in which the peak current far exceeds 100 times nominal rms current. The contactors are delivered complete with their damping resistors and must be used without additional inductances.

The capacitors must be discharged (maximum residual voltage at terminals  $\leq 50$  V) before being re-energized when the contactors are making.

These contactors are of the block type design with:

- 3 main poles
- the UA..RA contactors are fitted with a special front-mounted block, which ensures the serial insertion of 3 damping resistors into the circuit to limit the current peak on energization of the capacitor bank
  - their connection also ensures capacitor precharging in order to limit the second current peak occurring upon making of the main poles
  - the insertion of resistors allows to damp the highest current peak of the capacitor when switching on, whatever its level.
- control circuit: AC operated
- add-on auxiliary contact blocks for side mounting and a wide range of accessories.

IEC	UL/CSA	Rated control circuit voltage U <sub>c</sub> (1)		Auxiliary contacts fitted	Type	Order code	Weight Pkg (1 pce) kg
		V 50 Hz	V 60 Hz				
40	50	24	24	0 0	UA50-30-00RA	1SBL351024R8100	1.350
		110	110...120	0 0	UA50-30-00RA	1SBL351024R8400	1.350
		220...230	230...240	0 0	UA50-30-00RA	1SBL351024R8000	1.350
		230...240	240...260	0 0	UA50-30-00RA	1SBL351024R8800	1.350
		380...400	400...415	0 0	UA50-30-00RA	1SBL351024R8500	1.350
		400...415	415...440	0 0	UA50-30-00RA	1SBL351024R8600	1.350
50	55	24	24	0 0	UA63-30-00RA	1SBL371024R8100	1.350
		110	110...120	0 0	UA63-30-00RA	1SBL371024R8400	1.350
		220...230	230...240	0 0	UA63-30-00RA	1SBL371024R8000	1.350
		230...240	240...260	0 0	UA63-30-00RA	1SBL371024R8800	1.350
		380...400	400...415	0 0	UA63-30-00RA	1SBL371024R8500	1.350
		400...415	415...440	0 0	UA63-30-00RA	1SBL371024R8600	1.350
60	64	24	24	0 0	UA75-30-00RA	1SBL411024R8100	1.350
		110	110...120	0 0	UA75-30-00RA	1SBL411024R8400	1.350
		220...230	230...240	0 0	UA75-30-00RA	1SBL411024R8000	1.350
		230...240	240...260	0 0	UA75-30-00RA	1SBL411024R8800	1.350
		380...400	400...415	0 0	UA75-30-00RA	1SBL411024R8500	1.350
		400...415	415...440	0 0	UA75-30-00RA	1SBL411024R8600	1.350

(1) Other control voltages see voltage code table.

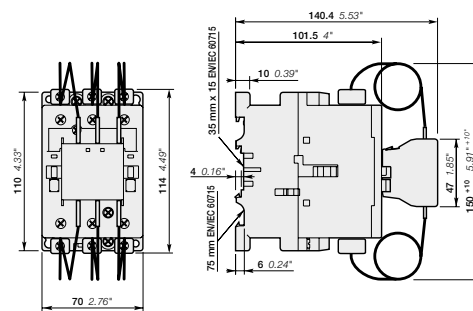

UA50..RA, UA63..RA, UA75..RA

Main dimensions mm, inches

# UA95..RA ... UA110..RA 3-pole contactors for capacitor switching

70 to 80 kvar - Unlimited peak current  $\hat{I}$   
AC operated



UA110-30-00 RA

UA..RA contactors for capacitor switching can be used for installations in which the peak current far exceeds 100 times nominal rms current. The contactors are delivered complete with their damping resistors and must be used without additional inductances.

The capacitors must be discharged (maximum residual voltage at terminals  $\leq 50$  V) before being re-energized when the contactors are making.

These contactors are of the block type design with:

- 3 main poles
- the UA..RA contactors are fitted with a special front-mounted block, which ensures the serial insertion of 3 damping resistors into the circuit to limit the current peak on energization of the capacitor bank
  - their connection also ensures capacitor precharging in order to limit the second current peak occurring upon making of the main poles
  - the insertion of resistors allows to damp the highest current peak of the capacitor when switching on, whatever its level.
- control circuit: AC operated
- add-on auxiliary contact blocks for side mounting and a wide range of accessories.

IEC	UL/CSA	Rated control circuit voltage $U_c$ (1)		Auxiliary contacts fitted	Type	Order code	Weight		
		V 50 Hz	V 60 Hz					Pkg (1 pce)	
Rated operational power $\theta \leq 40^\circ\text{C}$ 400 V AC-6b	Rated operational power $\theta \leq 40^\circ\text{C}$ 480 V	70	80	24	24	0 0	UA95-30-00RA	1SFL431024R8100	2.000
				110	110...120	0 0	UA95-30-00RA	1SFL431024R8400	2.000
				220...230	230...240	0 0	UA95-30-00RA	1SFL431024R8000	2.000
				230...240	240...260	0 0	UA95-30-00RA	1SFL431024R8800	2.000
				380...400	400...415	0 0	UA95-30-00RA	1SFL431024R8500	2.000
				400...415	415...440	0 0	UA95-30-00RA	1SFL431024R8600	2.000
70	80	80	95	24	24	0 0	UA110-30-00RA	1SFL451024R8100	2.000
				110	110...120	0 0	UA110-30-00RA	1SFL451024R8400	2.000
				220...230	230...240	0 0	UA110-30-00RA	1SFL451024R8000	2.000
				230...240	240...260	0 0	UA110-30-00RA	1SFL451024R8800	2.000
				380...400	400...415	0 0	UA110-30-00RA	1SFL451024R8500	2.000
				400...415	415...440	0 0	UA110-30-00RA	1SFL451024R8600	2.000

(1) Other control voltages see voltage code table.

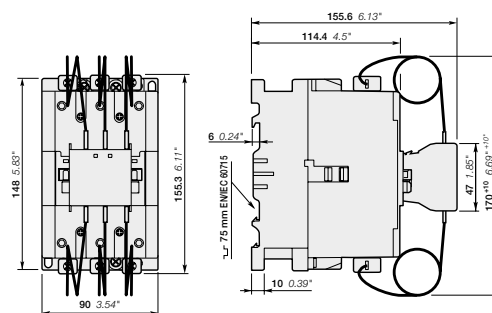



UA95..RA, UA100..RA

Main dimensions mm, inches

## UA..RA 3-pole contactors for capacitor switching

Unlimited peak current  $\hat{I}$

**Main accessory fitting details** - for ordering details, technical data and other accessories: see section accessories  
 Many configurations of accessories are possible depending on whether these are front-mounted or side-mounted.

Contactor types	Main poles	Available auxiliary contacts	Front-mounted accessories	Side-mounted accessories
			Auxiliary contact blocks	Auxiliary contact blocks
			1-pole CA5-..	2-pole CAL...
UA16-30-10RA	3 0	1 0	-	1 x CAL5-11
UA26-30-10RA	3 0	1 0	-	1 to 2 x CAL5-11
UA30-30-10RA	3 0	1 0	1 x CA5-..	+ 1 to 2 x CAL5-11
UA50-30-00RA	3 0	0 0	1 to 2 x CA5-..	+ 1 to 2 x CAL5-11
UA63-30-00RA	3 0	0 0		
UA75-30-00RA	3 0	0 0		
UA95-30-00RA	3 0	0 0	1 to 2 x CA5-..	+ 1 to 2 x CAL18-11
UA110-30-00RA	3 0	0 0		

# UA16..RA ... UA110..RA 3-pole contactors for capacitor switching

Unlimited peak current  $\hat{I}$

Technical data

## Main pole - Utilization characteristics according to IEC

Contactor types	AC operated	UA16..RA	UA26..RA	UA30..RA	UA50..RA	UA63..RA	UA75..RA	UA95..RA	UA110..RA
Standards		IEC 60947-1 / 60947-4-1 and EN 60947-1 / 60947-4-1							
Rated operational voltage $U_e$ max.		690 V							
Rated frequency (without derating)		50 / 60 Hz							
AC-6b Utilization category									
Rated operational power AC-6b (1)									
For air temperature close to contactor $\theta \leq 40^\circ\text{C}$	230-240 V	8 kvar	12.5 kvar	16 kvar	25 kvar	30 kvar	35 kvar	40 kvar	45 kvar
	400-415 V	12.5 kvar	22 kvar	30 kvar	40 kvar	50 kvar	60 kvar	70 kvar	80 kvar
	440 V	15 kvar	24 kvar	32 kvar	50 kvar	55 kvar	65 kvar	75 kvar	85 kvar
$\theta \leq 55^\circ\text{C}$	500-550 V	18 kvar	30 kvar	34 kvar	55 kvar	65 kvar	75 kvar	85 kvar	95 kvar
	690 V	22 kvar	35 kvar	45 kvar	72 kvar	80 kvar	100 kvar	120 kvar	130 kvar
	230-240 V	7.5 kvar	11.5 kvar	16 kvar	24 kvar	27 kvar	30 kvar	35 kvar	40 kvar
$\theta \leq 70^\circ\text{C}$	400-415 V	12.5 kvar	20 kvar	27.5 kvar	40 kvar	45 kvar	50 kvar	60 kvar	70 kvar
	440 V	13 kvar	20 kvar	30 kvar	43 kvar	48 kvar	53 kvar	65 kvar	75 kvar
	500-550 V	16 kvar	25 kvar	34 kvar	50 kvar	60 kvar	65 kvar	75 kvar	82 kvar
690 V	230-240 V	6 kvar	9 kvar	11 kvar	20 kvar	23 kvar	25 kvar	30 kvar	35 kvar
	400-415 V	10 kvar	15.5 kvar	19.5 kvar	35 kvar	39 kvar	41 kvar	53 kvar	60 kvar
	440 V	11 kvar	17 kvar	20.5 kvar	37 kvar	42.5 kvar	45 kvar	58 kvar	70 kvar
500-550 V	12.5 kvar	20 kvar	25 kvar	46 kvar	50 kvar	55 kvar	70 kvar	78 kvar	
	690 V	17 kvar	26 kvar	32 kvar	60 kvar	65 kvar	70 kvar	85 kvar	100 kvar
	Max. permissible peak current $\hat{I}$								
Unlimited									
Short-circuit protection device for contactors									
gG type fuse (2)									
		80 A	125 A	200 A				250 A	
Max. electrical switching frequency									
240 cycles/h									
Electrical durability AC-6b									
		500 V $\leq U_e \leq$ 690 V		250 000 operating cycles					
		500 V $\leq U_e \leq$ 690 V		100 000 operating cycles					

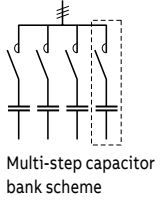

(1) For 220 V and 380 V, multiply by 0.9 the rated values at 230 V and 400 V respectively.  
 Example: 50 kvar / 400 V corresponding to 0.9 x 50 = 45 kvar/380 V.  
 (2) The fuse ratings given represent the maximum ratings ensuring type 1 coordination according to the definition of standard IEC 60947-4-1.

## Main pole - Utilization characteristics according to UL / CSA

Contactor types	AC operated	UA16..RA	UA26..RA	UA30..RA	UA50..RA	UA63..RA	UA75..RA	UA95..RA	UA110..RA
Power - 60 Hz									
For air temperature close to contactor $\theta \leq 40^\circ\text{C}$	240 V	8 kvar	11 kvar	14 kvar	25 kvar	27.5 kvar	32 kvar	40 kvar	45 kvar
	480 V	16 kvar	22 kvar	28 kvar	50 kvar	55 kvar	64 kvar	80 kvar	95 kvar
	600 V	20 kvar	27 kvar	35 kvar	62 kvar	70 kvar	80 kvar	100 kvar	120 kvar
Max. permissible peak Current $\hat{I}$									
Unlimited									

## Operating principle

The front-mounted block mechanism of the UA..RA contactors ensures:

- early making of the auxiliary "PA" poles with respect to the main "PP" poles
- automatic return to the open position of the auxiliary "PA" poles after the main poles are closed.

**When the coil is energized**, the early making auxiliary poles connect the capacitor to the network via the set of 3 resistors. The damping resistors attenuate the first current peak and the second inrush current when the main contacts begin to make. Once the main poles are in the closed position, the auxiliary poles automatically break.

**When the coil is de-energized**, the main poles break ensuring the breaking of the capacitor bank. The contactor can then begin a new cycle.

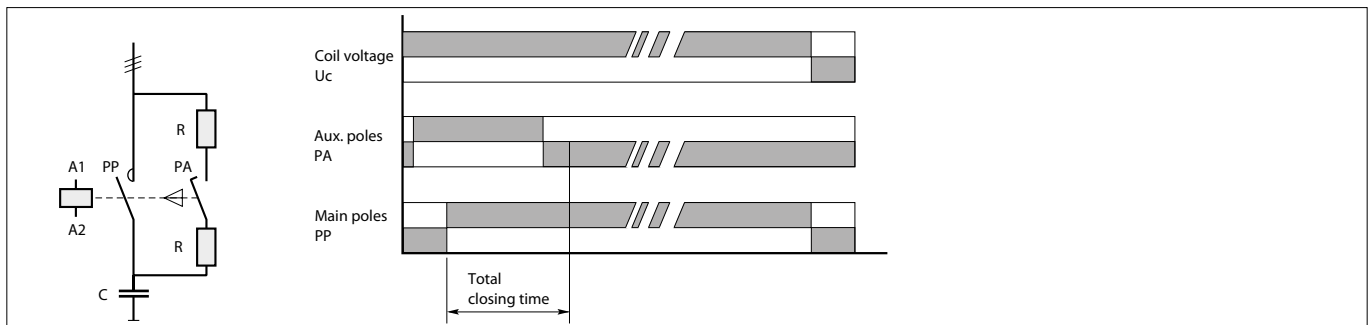

The insertion of resistors allows to damp the highest current peak of the capacitor when switching on, whatever its level.









# UA16..RA ... UA110..RA 3-pole contactors for capacitor switching

Unlimited peak current  $\hat{I}$

Technical data

## Connecting characteristics

Contactor types	AC operated	UA16..RA	UA26..RA	UA30..RA	UA50..RA UA63..RA UA75..RA	UA95..RA UA110..RA
Connection capacity (min. ... max.)						
Main conductors (poles)						
 Rigid	Solid ( $\leq 4 \text{ mm}^2$ )	1 x 1...4 mm <sup>2</sup>	1.5...6 mm <sup>2</sup>	2.5...16 mm <sup>2</sup>	6...50 mm <sup>2</sup>	10...95 mm <sup>2</sup>
 Stranded ( $\geq 6 \text{ mm}^2$ )		2 x -	-	2.5...16 + 2.5...6 mm <sup>2</sup>	6...25 + 6...16 mm <sup>2</sup>	6...35 mm <sup>2</sup>
 Flexible with ferrule		1 x 0.75...2.5 mm <sup>2</sup>	1.5...4 mm <sup>2</sup>	2.5...10 mm <sup>2</sup>	6...35 mm <sup>2</sup>	10...70 mm <sup>2</sup>
 Bars or lugs		2 x -	-	2.5...10 + 2.5...4 mm <sup>2</sup>	6...16 + 6...10 mm <sup>2</sup>	6...35 mm <sup>2</sup>
		L $\leq$ 7.7 mm	10 mm	-	-	-
		L $>$ 3.7 mm	4.2 mm	-	-	-
Connection capacity acc. to UL/CSA		1 or 2 x AWG 18...10	AWG 12...8	AWG 8...4	AWG 8...1	AWG 6...2/0
Tightening torque		Recommended	1 Nm / 9 lb.in	1.7 Nm / 15 lb.in	2.3 Nm / 20 lb.in	4 Nm / 35 lb.in
		Max.	1.2 Nm	2.2 Nm	2.6 Nm	4.5 Nm
Auxiliary conductors (built-in auxiliary terminals + coil terminals)						
 Rigid solid		1 x 1...4 mm <sup>2</sup>				0.75...2.5 mm <sup>2</sup>
 Flexible with ferrule		2 x 1...4 mm <sup>2</sup>				0.75...2.5 mm <sup>2</sup>
 Lugs	Coil terminals	1 x 0.75...2.5 mm <sup>2</sup>			1...2.5 mm <sup>2</sup>	0.75...2.5 mm <sup>2</sup>
		2 x 0.75...2.5 mm <sup>2</sup>				
		L $\leq$ 8 mm				
		L $>$ 3.7 mm				
	Built-in auxiliary terminals	L $\leq$ 7.7 mm	10 mm	8 mm	-	-
		L $>$ 3.7 mm	4.2 mm	3.7 mm	-	-
Connection capacity acc. to UL/CSA		1 or 2 x AWG 18...14				
Tightening torque						
Coil terminals		Recommended	1 Nm / 9 lb.in			
		Max.	1.2 Nm			
Built-in auxiliary terminals		Recommended	1 Nm / 9 lb.in			
		Max.	1.2 Nm			
Degree of protection acc. to IEC 60947-1 / EN 60947-1 and IEC 60529 / EN 60529						
Main terminals		IP20		IP10		
Coil terminals		IP20				
Built-in auxiliary terminals		IP20			-	-
Screw terminals						
Delivered in open position, screws of unused terminals must be tightened						
Main terminals		Screwdriver type	M 3.5 Flat $\varnothing$ 5.5 / Pozidriv 2	M 4	M 5 Flat $\varnothing$ 6.5 / Pozidriv 2	M 6 M 8 Hexagon socket (s = 4 mm)
Coil terminals		Screwdriver type	M 3.5 Flat $\varnothing$ 5.5 / Pozidriv 2			
Built-in auxiliary terminals		Screwdriver type	M 3.5 Flat $\varnothing$ 5.5 / Pozidriv 2	M 4	M 3.5	-
					-	-

Other technical characteristics are the same as those of standard A contactors.

# UA16 ... UA30 3-pole contactors for capacitor switching

12.5 to 27.5 kvar - Peak current  $\hat{I} \leq 100$  times the rms current  
AC operated



UA16-30-10



UA30-30-10

UA contactors can be used for the switching of capacitor banks whose inrush current peaks are less than or equal to 100 times nominal rms current.

The capacitors must be discharged (maximum residual voltage at terminals  $\leq 50$  V) before being re-energized when the contactors are making.

These contactors are of the block type design with:

- 3 main poles and 1 built-in auxiliary contact
- control circuit: AC operated
- add-on auxiliary contact blocks for front or side mounting and a wide range of accessories.

IEC		UL/CSA	Rated control circuit voltage		Auxiliary contacts fitted	Type	Order code	Weight
Rated operational power $\theta \leq 40^\circ\text{C}$ 400 V AC-6b kvar	Max peak current $\hat{I}$ kA	Rated operational power $\theta \leq 40^\circ\text{C}$ 480 V kvar	Uc (1)					Pkg (1 pce) kg
			V 50 Hz	V 60 Hz				
12.5	1.8	-	24	24	1 0	UA16-30-10	1SBL181022R8110	0.340
			48	48	1 0	UA16-30-10	1SBL181022R8310	0.340
			110	110...120	1 0	UA16-30-10	1SBL181022R8410	0.340
			220...230	230...240	1 0	UA16-30-10	1SBL181022R8010	0.340
			230...240	240...260	1 0	UA16-30-10	1SBL181022R8810	0.340
			380...400	400...415	1 0	UA16-30-10	1SBL181022R8510	0.340
20	3	25	48	48	1 0	UA26-30-10	1SBL241022R8310	0.600
			110	110...120	1 0	UA26-30-10	1SBL241022R8410	0.600
			220...230	230...240	1 0	UA26-30-10	1SBL241022R8010	0.600
			230...240	240...260	1 0	UA26-30-10	1SBL241022R8810	0.600
			380...400	400...415	1 0	UA26-30-10	1SBL241022R8510	0.600
			400...415	415...440	1 0	UA26-30-10	1SBL241022R8610	0.600
27.5	3.5	32	24	24	1 0	UA30-30-10	1SBL281022R8110	0.710
			48	48	1 0	UA30-30-10	1SBL281022R8310	0.710
			110	110...120	1 0	UA30-30-10	1SBL281022R8410	0.710
			220...230	230...240	1 0	UA30-30-10	1SBL281022R8010	0.710
			230...240	240...260	1 0	UA30-30-10	1SBL281022R8810	0.710
			380...400	400...415	1 0	UA30-30-10	1SBL281022R8510	0.710
400...415	415...440	1 0	UA30-30-10	1SBL281022R8610	0.710			

(1) Other control voltages see voltage code table.

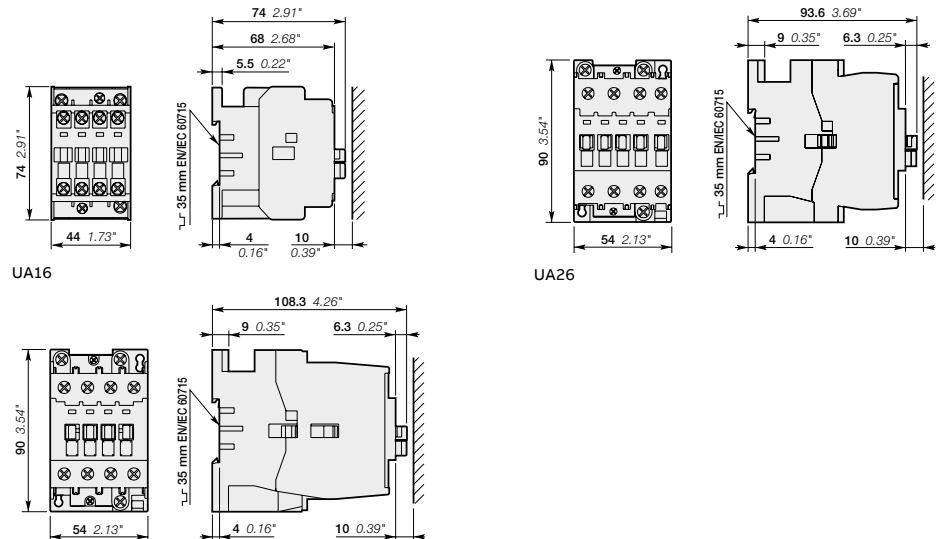

UA16

UA26

UA30

Main dimensions mm, inches

# UA50 ... UA75 3-pole contactors for capacitor switching

33 to 50 kvar - Peak current  $\hat{I} \leq 100$  times the rms current

AC operated



UA50-30-00

UA contactors can be used for the switching of capacitor banks whose inrush current peaks are less than or equal to 100 times nominal rms current.

The capacitors must be discharged (maximum residual voltage at terminals  $\leq 50$  V) before being re-energized when the contactors are making.

These contactors are of the block type design with:

- 3 main poles
- control circuit: AC operated
- add-on auxiliary contact blocks for front or side mounting and a wide range of accessories.

IEC	Rated operational power $\theta \leq 40^\circ\text{C}$ 400 V AC-6b kvar	Max peak current $\hat{I}$ kA	UL/CSA Rated operational power $\theta \leq 40^\circ\text{C}$ 480 V kvar	Rated control circuit voltage $U_c$ (1)		Auxiliary contacts fitted 	Type	Order code	Weight Pkg (1 pce) kg
				V 50 Hz	V 60 Hz				
33	5	40	-	24	24	0 0	UA50-30-00	1SBL351022R8100	1.160
				48	48	0 0	UA50-30-00	1SBL351022R8300	1.160
				110	110...120	0 0	UA50-30-00	1SBL351022R8400	1.160
				220...230	230...240	0 0	UA50-30-00	1SBL351022R8000	1.160
				230...240	240...260	0 0	UA50-30-00	1SBL351022R8800	1.160
				380...400	400...415	0 0	UA50-30-00	1SBL351022R8500	1.160
				400...415	415...440	0 0	UA50-30-00	1SBL351022R8600	1.160
45	6.5	-	-	24	24	0 0	UA63-30-00	1SBL371022R8100	1.160
				48	48	0 0	UA63-30-00	1SBL371022R8300	1.160
				110	110...120	0 0	UA63-30-00	1SBL371022R8400	1.160
				220...230	230...240	0 0	UA63-30-00	1SBL371022R8000	1.160
				230...240	240...260	0 0	UA63-30-00	1SBL371022R8800	1.160
				380...400	400...415	0 0	UA63-30-00	1SBL371022R8500	1.160
				400...415	415...440	0 0	UA63-30-00	1SBL371022R8600	1.160
50	7.5	55	-	24	24	0 0	UA75-30-00	1SBL411022R8100	1.160
				48	48	0 0	UA75-30-00	1SBL411022R8300	1.160
				110	110...120	0 0	UA75-30-00	1SBL411022R8400	1.160
				220...230	230...240	0 0	UA75-30-00	1SBL411022R8000	1.160
				230...240	240...260	0 0	UA75-30-00	1SBL411022R8800	1.160
				380...400	400...415	0 0	UA75-30-00	1SBL411022R8500	1.160
				400...415	415...440	0 0	UA75-30-00	1SBL411022R8600	1.160

(1) Other control voltages see voltage code table.

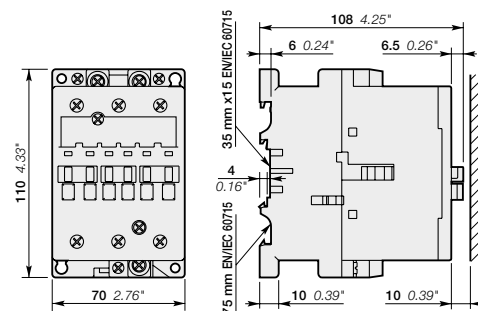

UA50, UA63, UA75

Main dimensions mm, inches

# UA95 ... UA110 3-pole contactors for capacitor switching

65 to 75 kvar - Peak current  $\hat{I} \leq 100$  times the rms current  
 AC operated



UA110-30-00

UA contactors can be used for the switching of capacitor banks whose inrush current peaks are less or equal to 100 times nominal rms current. The capacitors must be discharged (maximum residual voltage at terminals  $\leq 50$  V) before being re-energized when the contactors are making.

These contactors are of the block type design with:

- 3 main poles
- control circuit: AC operated
- add-on auxiliary contact blocks for front or side mounting and a wide range of accessories.

IEC		UL/CSA	Rated control circuit voltage $U_c$ (1)		Auxiliary contacts fitted	Type	Order code	Weight Pkg (1 pce)
Rated operational power $\theta \leq 40^\circ\text{C}$	Max peak current $\hat{I}$	Rated operational power $\theta \leq 40^\circ\text{C}$	V 50 Hz	V 60 Hz				
400 V AC-6b kvar	9.3	70	24	24	0 0	UA95-30-00	1SFL431022R8100	2.000
			48	48	0 0	UA95-30-00	1SFL431022R8300	2.000
			110	110...120	0 0	UA95-30-00	1SFL431022R8400	2.000
			220...230	230...240	0 0	UA95-30-00	1SFL431022R8000	2.000
			230...240	240...260	0 0	UA95-30-00	1SFL431022R8800	2.000
			380...400	400...415	0 0	UA95-30-00	1SFL431022R8500	2.000
			400...415	415...440	0 0	UA95-30-00	1SFL431022R8600	2.000
kA	10.5	80	24	24	0 0	UA110-30-00	1SFL451022R8100	2.000
			48	48	0 0	UA110-30-00	1SFL451022R8300	2.000
			110	110...120	0 0	UA110-30-00	1SFL451022R8400	2.000
			220...230	230...240	0 0	UA110-30-00	1SFL451022R8000	2.000
			230...240	240...260	0 0	UA110-30-00	1SFL451022R8800	2.000
			380...400	400...415	0 0	UA110-30-00	1SFL451022R8500	2.000
			400...415	415...440	0 0	UA110-30-00	1SFL451022R8600	2.000

(1) Other control voltages see voltage code table.

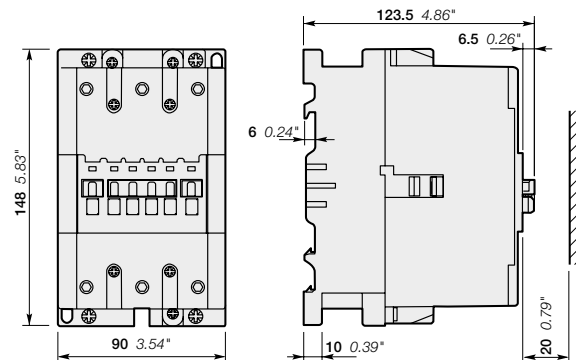

UA95, UA110



Main dimensions mm, inches

## UA... 3-pole contactors for capacitor switching

Peak current  $\hat{I} \leq 100$  times the rms current

### Main accessory fitting details

Many configurations of accessories are possible depending on whether these are front-mounted or side-mounted.

Contactor types	Main poles	Available auxiliary contacts	Front-mounted accessories			Side-mounted accessories
			Auxiliary contact blocks		Pneumatic timer	Auxiliary contact blocks
			1-pole CA5-..	4-pole CA5-..	TP.. A	2-pole CAL...
UA16-30-10	3 0	1 0	1 to 4 x CA5-..	or 1 x CA5-.. (4-pole)	or 1 x TP.. A	+ 1 to 2 x CAL5-11
UA26-30-10	3 0	1 0	1 to 4 x CA5-..	or 1 x CA5-.. (4-pole)	or 1 x TP.. A	+ 1 to 2 x CAL5-11
UA30-30-10	3 0	1 0	1 to 5 x CA5-..	or 1 x CA5-.. (4-pole) + 1 x 1-pole CA5-..	or 1 x TP.. A + 1 x CA5-.. (1-pole)	+ 1 to 2 x CAL5-11
UA50-30-00	3 0	0 0	1 to 6 x CA5-..	or 1 x CA5-.. (4-pole) + 2 x 1-pole CA5-..	or 1 x TP.. A + 2 x CA5-.. (1-pole)	+ 1 to 2 x CAL5-11
UA63-30-00	3 0	0 0				
UA75-30-00	3 0	0 0				
UA95-30-00	3 0	0 0	1 to 6 x CA5-..	or 1 x CA5-.. (4-pole)	-	+ 1 to 2 x CAL18-11
UA110-30-00	3 0	0 0		+ 2 x 1-pole CA5-..		

## UA16 ... UA110 3-pole contactors for capacitor switching

Peak current  $\hat{I} \leq 100$  times the rms current

Technical data

### Main pole - Utilization characteristics according to IEC

Contactor types	AC operated	UA16	UA26	UA30	UA50	UA63	UA75	UA95	UA110	
Standards		IEC 60947-1 / 60947-4-1 and EN 60947-1 / 60947-4-1								
Rated operational voltage U <sub>e</sub> max.		690 V								
Rated frequency (without derating)		50 / 60 Hz								
AC-6b Utilization category										
Rated operational power AC-6b (1)										
For air temperature close to contactor	$\theta \leq 40^\circ\text{C}$	230-240 V	7.5 kvar	12 kvar	16 kvar	20 kvar	25 kvar	30 kvar	35 kvar	40 kvar
		400-415 V	12.5 kvar	20 kvar	27.5 kvar	33 kvar	45 kvar	50 kvar	65 kvar	75 kvar
		440 V	13.7 kvar	22 kvar	30 kvar	36 kvar	50 kvar	55 kvar	65 kvar	75 kvar
		500-550 V	15.5 kvar	22 kvar	34 kvar	40 kvar	50 kvar	62 kvar	70 kvar	80 kvar
		690 V	21.5 kvar	30 kvar	45 kvar	55 kvar	70 kvar	75 kvar	80 kvar	90 kvar
		230-240 V	6.7 kvar	11 kvar	16 kvar	20 kvar	25 kvar	30 kvar	35 kvar	40 kvar
	$\theta \leq 55^\circ\text{C}$	400-415 V	11.7 kvar	18.5 kvar	27.5 kvar	33 kvar	43 kvar	50 kvar	65 kvar	70 kvar
		440 V	13 kvar	20 kvar	30 kvar	36 kvar	48 kvar	53 kvar	65 kvar	75 kvar
		500-550 V	14.7 kvar	22 kvar	34 kvar	40 kvar	50 kvar	62 kvar	70 kvar	80 kvar
		690 V	20 kvar	30 kvar	45 kvar	55 kvar	70 kvar	75 kvar	80 kvar	90 kvar
		230-240 V	6 kvar	8.5 kvar	11 kvar	19 kvar	21 kvar	22 kvar	30 kvar	35 kvar
		400-415 V	10 kvar	14.5 kvar	19 kvar	32 kvar	37 kvar	39 kvar	55 kvar	65 kvar
$\theta \leq 70^\circ\text{C}$	440 V	11 kvar	16 kvar	20 kvar	35 kvar	41 kvar	43 kvar	55 kvar	70 kvar	
	500-550 V	12.5 kvar	19.5 kvar	23.5 kvar	40 kvar	45 kvar	47.5 kvar	60 kvar	75 kvar	
	690 V	17 kvar	25 kvar	32 kvar	52 kvar	60 kvar	65 kvar	70 kvar	85 kvar	
	U <sub>e</sub> ≤ 500 V	1.8 kA	3 kA	3.5 kA	5 kA	6.5 kA	7.5 kA	9.3 kA	10.5 kA	
	U <sub>e</sub> > 500 V	1.6 kA	2.7 kA	3.1 kA	4.5 kA	5.8 kA	6.75 kA	8 kA	9 kA	
	Short-circuit protection device for contactors									
gG type fuse		sized 1.5...1.8 In of the capacitor								
Max. electrical switching frequency		240 cycles/h								
Electrical durability AC-6b	U <sub>e</sub> ≤ 690 V	100 000 operating cycles								

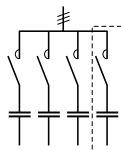

Multi-step capacitor bank scheme

(1) For 220 V and 380 V, multiply by 0.9 the rated values at 230 V and 400 V respectively.

Example: 50 kvar / 400 V corresponding to  $0.9 \times 50 = 45$  kvar/380 V.

If, in an application, the current peak is greater than the maximum peak current  $\hat{I}$  specified in the tables above, select a higher rating, refer to the UA..RA contactors, or add inductances. (see application guide "Contactors for capacitor switching").

### Main pole - Utilization characteristics according to UL / CSA

Contactor types	AC operated	UA16	UA26	UA30	UA50	UA63	UA75	UA95	UA110	
Power - 60 Hz										
For air temperature close to contactor	$\theta \leq 40^\circ\text{C}$	240 V	-	12.5 kvar	16 kvar	20 kvar	-	27.5 kvar	35 kvar	40 kvar
		480 V	-	25 kvar	32 kvar	40 kvar	-	55 kvar	70 kvar	80 kvar
		600 V	-	30 kvar	40 kvar	50 kvar	-	70 kvar	75 kvar	85 kvar











If, in an application, the current peak is greater than the maximum peak current  $\hat{I}$  specified in the tables above, select a higher rating, refer to the UA..RA contactors, or add inductances. (see application guide "Contactors for capacitor switching").

# UA16 ... UA110 3-pole contactors for capacitor switching

Peak current  $\hat{I} \leq 100$  times the rms current

Technical data

## Connecting characteristics

Contactor types	AC operated	UA16		UA26		UA30		UA50	UA95
								UA63 UA75	UA110
Connection capacity (min. ... max.)									
Main conductors (poles)									
	Rigid	Solid ( $\leq 4 \text{ mm}^2$ )	1 x	1...4 mm <sup>2</sup>	1.5...6 mm <sup>2</sup>	2.5...16 mm <sup>2</sup>	6...50 mm <sup>2</sup>	10...95 mm <sup>2</sup>	
		Stranded ( $\geq 6 \text{ mm}^2$ )	2 x	1...4 mm <sup>2</sup>	1.5...6 mm <sup>2</sup>	2.5...16 mm <sup>2</sup>	6...25 mm <sup>2</sup>	6...35 mm <sup>2</sup>	
	Flexible with ferrule		1 x	0.75...2.5 mm <sup>2</sup>	0.75...4 mm <sup>2</sup>	2.5...10 mm <sup>2</sup>	6...35 mm <sup>2</sup>	10...70 mm <sup>2</sup>	
				2 x	0.75...2.5 mm <sup>2</sup>	0.75...4 mm <sup>2</sup>	2.5...10 mm <sup>2</sup>	6...16 mm <sup>2</sup>	6...35 mm <sup>2</sup>
	Bars or lugs		L $\leq$	7.7 mm	10 mm	-	-	-	
				l >	3.7 mm	4.2 mm	-	-	-
Connection capacity acc. to UL/CSA			1 or 2 x	AWG 18...10	AWG 12...8	AWG 8...4	AWG 8...1	AWG 6...2/0	
Tightening torque		Recommended		1 Nm / 9 lb.in	1.7 Nm / 15 lb.in	2.3 Nm / 20 lb.in	4 Nm / 35 lb.in	8 Nm / 71 lb.in	
		Max.		1.2 Nm	2.2 Nm	2.6 Nm	4.5 Nm	9 Nm	
Auxiliary conductors									
(built-in auxiliary terminals + coil terminals)									
	Rigid solid		1 x	1...4 mm <sup>2</sup>				0.75...2.5 mm <sup>2</sup>	
				2 x	1...4 mm <sup>2</sup>				0.75...2.5 mm <sup>2</sup>
	Flexible with ferrule		1 x	0.75...2.5 mm <sup>2</sup>			1...2.5 mm <sup>2</sup>	0.75...2.5 mm <sup>2</sup>	
				2 x	0.75...2.5 mm <sup>2</sup>				
	Lugs	Coil terminals	L $\leq$	8 mm					
				l >	3.7 mm				
		Built-in auxiliary terminals	L $\leq$	7.7 mm	10 mm	8 mm	-	-	
				l >	3.7 mm	4.2 mm	3.7 mm	-	-
Connection capacity acc. to UL/CSA				AWG 18...14					
Tightening torque									
Coil terminals		Recommended		1 Nm / 9 lb.in					
		Max.		1.2 Nm					
Built-in auxiliary terminals		Recommended		1 Nm / 9 lb.in					
		Max.		1.2 Nm					
Degree of protection									
acc. to IEC 60947-1 / EN 60947-1 and IEC 60529 / EN 60529									
Main terminals				IP20			IP10		
Coil terminals				IP20					
Built-in auxiliary terminals				IP20			-		-
Screw terminals									
Main terminals		Screwdriver type	Delivered in open position, screws of unused terminals must be tightened						
			M3.5	M4	M5	M6	M8		
			Flat $\varnothing$ 5.5 / Pozidriv 2		Flat $\varnothing$ 6.5 / Pozidriv 2			Hexagon socket (s = 4 mm)	
Coil terminals			M3.5						
		Screwdriver type	Flat $\varnothing$ 5.5 / Pozidriv 2						
Built-in auxiliary terminals			M3.5	M4	M3.5	-	-		
		Screwdriver type	Flat $\varnothing$ 5.5 / Pozidriv 2						

Other technical characteristics are the same as those of standard A contactors.





---

# NF 4-pole and 8-pole contactor relays

## Ordering details 4-pole contactor relays

- 3/208 NF AC / DC operated
- 3/209 NFZ 24 V DC operated designed for PLC
- 3/210 NFZ AC / DC operated for specific applications
- 3/211 Contactor relays and main accessories

## Ordering details 8-pole contactor relays

- 3/212 NF AC / DC operated
- 3/213 NFZ 24 V DC operated designed for PLC
- 3/214 NFZ AC / DC operated for specific applications
- 3/215 Contactor relays and main accessories

## 3/216 Technical data

## Ordering details contactor relays with Push-in Spring terminals

- 3/219 NF..K AC / DC operated
- 3/220 NFZ..K 24 V DC operated designed for PLC
- 3/221 NFZ..K AC / DC operated for specific applications
- 3/222 Contactor relays and main accessories

## 3/223 Technical data

## 3/404 Voltage code table



For direct product details information, use product type or order code, ex:

- [www.abb.com/productdetails/AF09-30-10-13](http://www.abb.com/productdetails/AF09-30-10-13)
- or [www.abb.com/productdetails/1SBL137001R1310](http://www.abb.com/productdetails/1SBL137001R1310)

# NF 4-pole contactor relays

AC / DC operated



NF22E

NF contactor relays are used for switching auxiliary and control circuits.

These contactor relays are of the block type design with:

- 4 poles. Contactor relays have mechanically linked auxiliary contact elements (side-marked symbol)
- control circuit: AC or DC operated with electronic coil interface accepting a wide control voltage range (e.g. 100...250 V AC and DC)
  - can manage large control voltage variations
  - only 4 control voltage ranges covering 24...500 V 50/60 Hz and 20...500 V DC
  - reduced panel energy consumption
  - very distinct closing and opening.
- built-in surge suppression
- add-on auxiliary contact blocks for front or side mounting and a wide range of accessories.

Number of contacts	Rated control circuit voltage Uc min. ... Uc max.		Type	Order code	Weight Pkg (1 pce) kg	
	V 50/60 Hz	V DC				
	24...60	20...60	(1)	NF22E-11	1SBH137001R1122	0.270
	48...130	48...130		NF22E-12	1SBH137001R1222	0.270
	100...250	100...250		NF22E-13	1SBH137001R1322	0.270
	250...500	250...500		NF22E-14	1SBH137001R1422	0.310
	24...60	20...60	(1)	NF31E-11	1SBH137001R1131	0.270
	48...130	48...130		NF31E-12	1SBH137001R1231	0.270
	100...250	100...250		NF31E-13	1SBH137001R1331	0.270
	250...500	250...500		NF31E-14	1SBH137001R1431	0.310
	24...60	20...60	(1)	NF40E-11	1SBH137001R1140	0.270
	48...130	48...130		NF40E-12	1SBH137001R1240	0.270
	100...250	100...250		NF40E-13	1SBH137001R1340	0.270
	250...500	250...500		NF40E-14	1SBH137001R1440	0.310

(1) NF...-11 not suitable for direct control by PLC-output.

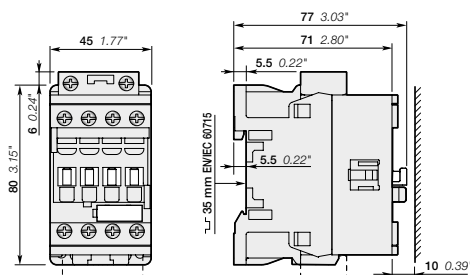

NF22E, NF31E, NF40E

Main dimensions mm, inches

# NFZ 4-pole contactor relays

24 V DC operated designed for PLC



NFZ22E-30

NFZ contactor relays are used for switching auxiliary and control circuits. These contactor relays are of the block type design with:

- 4 poles. Contactor relays have mechanically linked auxiliary contact elements (side-marked symbol)
- control circuit: 24 V DC operated with electronic coil interface allowing low holding consumption up to 1.7 W and reduced panel energy consumption
  - allow direct control by PLC-output  $\geq 250$  mA 24 V DC
  - very distinct closing and opening
- built-in surge suppression
- add-on auxiliary contact blocks for front or side mounting and a wide range of accessories.

Number of contacts	Rated control circuit voltage Uc	Type	Order code	Weight  Pkg (1 pce) kg
	V DC			

### 4-pole contactor relays

	24	NFZ22E-30	1SBH136001R3022	0.430
	24	NFZ31E-30	1SBH136001R3031	0.430
	24	NFZ40E-30	1SBH136001R3040	0.430

Note: NFZ contactor relays with DC control voltage 24 V DC need to respect the connection polarities indicated close to the coil terminals: A1+ for the positive pole and A2- for the negative pole.

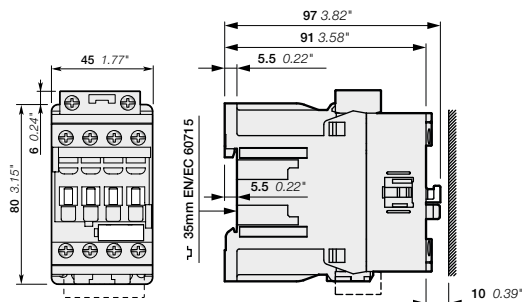

NFZ22E, NFZ31E, NFZ40E

Main dimensions mm, inches



# NFZ 4-pole contactor relays

AC / DC operated for specific applications



NFZ22E

NFZ contactor relays are used for switching auxiliary and control circuits.

These contactor relays are of the block type design with:

- 4 poles. Contactor relays have mechanically linked auxiliary contact elements (side-marked symbol)
- control circuit: AC or DC operated with electronic coil interface accepting a wide control voltage range (e.g. 100...250 V AC and DC)
  - can manage large control voltage variations
  - only 4 control voltage ranges covering 24...250 V 50/60 Hz and 12...250 V DC
  - allow direct control by PLC-output  $\geq 24$  V DC 500 mA
  - reduced panel energy consumption
  - very distinct closing and opening
  - can withstand short voltage dips and voltage sags (SEMI F47-0706 conditions of use on request).
- built-in surge suppression
- add-on auxiliary contact blocks for front or side mounting and a wide range of accessories.

Number of contacts	Rated control circuit voltage Uc min. ... Uc max.		Type	Order code	Weight Pkg (1 pce) kg
	V 50/60 Hz	V DC			
	-	12...20	NFZ22E-20	1SBH136001R2022	0.310
	24...60	20...60	NFZ22E-21	1SBH136001R2122	0.310
	48...130	48...130	NFZ22E-22	1SBH136001R2222	0.310
	100...250	100...250	NFZ22E-23	1SBH136001R2322	0.310
	-	12...20	NFZ31E-20	1SBH136001R2031	0.310
	24...60	20...60	NFZ31E-21	1SBH136001R2131	0.310
	48...130	48...130	NFZ31E-22	1SBH136001R2231	0.310
	100...250	100...250	NFZ31E-23	1SBH136001R2331	0.310
	-	12...20	NFZ40E-20	1SBH136001R2040	0.310
	24...60	20...60	NFZ40E-21	1SBH136001R2140	0.310
	48...130	48...130	NFZ40E-22	1SBH136001R2240	0.310
	100...250	100...250	NFZ40E-23	1SBH136001R2340	0.310

Note: Only NFZ contactor relays with DC control voltage 12...20 V DC need to respect the connection polarities indicated close to the coil terminals: A1+ for the positive pole and A2- for the negative pole.

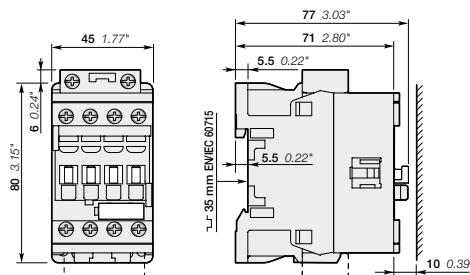

NFZ22E, NFZ31E, NFZ40E

Main dimensions mm, inches

# NF 4-pole contactor relays

## Contactor relays and main accessories

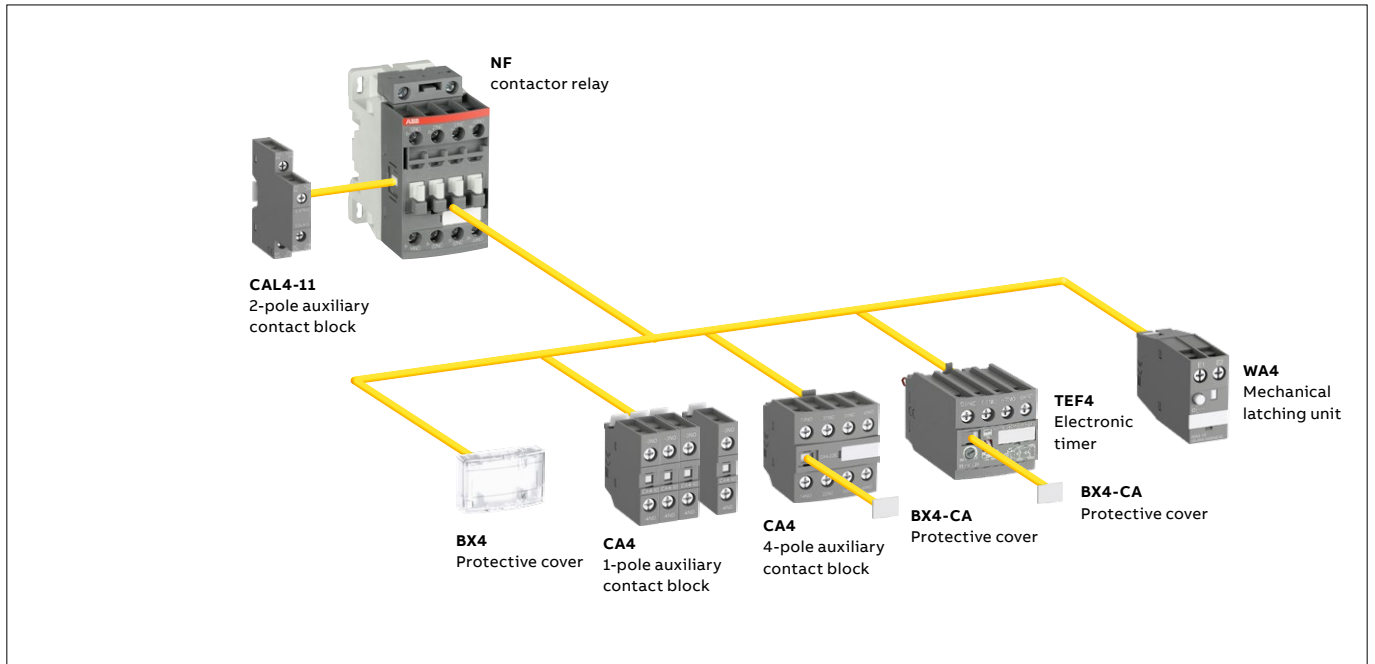

**Main accessory fitting details** - for ordering details, technical data and other accessories: see section accessories

Many configurations of accessories are possible depending on whether these are front-mounted or side-mounted.

Contactor relay types	Main poles	Front-mounted accessories				Side-mounted accessories	
		Auxiliary contact blocks		Electronic timer	Mechanical latching unit	Auxiliary contact blocks	
		1-pole CA4	4-pole CA4	TEF4	WA4 (3)	2-pole CAL4-11 Left side	Right side
<b>NF(Z)</b>							
NF	2 2 E (1) 3 1 E (1) 4 0 E (2)	4 max.	or 1	or 1	or 1	+ 1	-
		2 max.	-	or 1	or 1	+ 1	+ 1
<b>NFZ 24 V DC designed for PLC - coil 30</b>							
NFZ	2 2 E (1) 3 1 E (1) 4 0 E (2)	4 max.	or 1	or 1	-	or 1	+ 1
		2 max.	-	or 1	-	+ 1	-
		-	-	1	-	+ 1	+ 1

(1) Including add-on contacts: 3 N.C. auxiliary contacts max. on positions 1, 2, 3, 4 and 2 N.C. max. on positions 1 ±30°, 5.  
 (2) Including add-on contacts: 4 N.C. auxiliary contacts max. on positions 1, 2, 3, 4 and 3 N.C. max. on positions 1 ±30°, 5.  
 (3) Accept 1-pole CA4 auxiliary contacts (1 block on each side of the mechanical latch) in respect to the total number of additional N.C. auxiliary contacts.  
 For WA4, accessory use with contactor relays coil 30, please consult your ABB local sales organization.

# NF 8-pole contactor relays

AC / DC operated



NF44E

15BC101039V0014



NF33/11

15BC101043V0014



NF51/11

15BC101043V0014

NF contactor relays are used for switching auxiliary and control circuits.

These contactor relays are of the block type design with:

- 8 poles with a permanently fixed 4-pole auxiliary contact block. Contactor relays have mechanically linked auxiliary contact elements (side-marked symbol) except for NF33/11 and NF51/11 variants
- overlapping of lagging / leading contacts for NF33/11 and NF51/11 variants
- control circuit: AC or DC operated with electronic coil interface accepting a wide control voltage range (e.g. 100...250 V AC and DC)
  - can manage large control voltage variations
  - only 4 coils to cover control voltages between 24...500 V 50/60 Hz and 20...500 V DC
  - reduced panel energy consumption
  - very distinct closing and opening
- built-in surge suppression
- add-on auxiliary contact blocks for side mounting and a wide range of accessories.

Number of contacts	Rated control circuit voltage	Type	Order code	Weight Pkg (1 pce)
	V 50/60 Hz	V DC		kg

### 8-pole contactor relays

Control Voltage	Control Voltage	Type	Order code	Weight Pkg (1 pce)
24...60	20...60 (1)	NF44E-11	1SBH137001R1144	0.320
48...130	48...130	NF44E-12	1SBH137001R1244	0.320
100...250	100...250	NF44E-13	1SBH137001R1344	0.320
250...500	250...500	NF44E-14	1SBH137001R1444	0.360
24...60	20...60 (1)	NF53E-11	1SBH137001R1153	0.320
48...130	48...130	NF53E-12	1SBH137001R1253	0.320
100...250	100...250	NF53E-13	1SBH137001R1353	0.320
250...500	250...500	NF53E-14	1SBH137001R1453	0.360
24...60	20...60 (1)	NF62E-11	1SBH137001R1162	0.320
48...130	48...130	NF62E-12	1SBH137001R1262	0.320
100...250	100...250	NF62E-13	1SBH137001R1362	0.320
250...500	250...500	NF62E-14	1SBH137001R1462	0.360
24...60	20...60 (1)	NF71E-11	1SBH137001R1171	0.320
48...130	48...130	NF71E-12	1SBH137001R1271	0.320
100...250	100...250	NF71E-13	1SBH137001R1371	0.320
250...500	250...500	NF71E-14	1SBH137001R1471	0.360
24...60	20...60 (1)	NF80E-11	1SBH137001R1180	0.320
48...130	48...130	NF80E-12	1SBH137001R1280	0.320
100...250	100...250	NF80E-13	1SBH137001R1380	0.320
250...500	250...500	NF80E-14	1SBH137001R1480	0.360

### 8-pole contactor relays with overlapping of lagging / leading contacts

Control Voltage	Control Voltage	Type	Order code	Weight Pkg (1 pce)
24...60	20...60 (1)	NF33/11-11	1SBH137001R1139	0.320
48...130	48...130	NF33/11-12	1SBH137001R1239	0.320
100...250	100...250	NF33/11-13	1SBH137001R1339	0.320
250...500	250...500	NF33/11-14	1SBH137001R1439	0.320
24...60	20...60 (1)	NF51/11-11	1SBH137001R1159	0.320
48...130	48...130	NF51/11-12	1SBH137001R1259	0.320
100...250	100...250	NF51/11-13	1SBH137001R1359	0.320
250...500	250...500	NF51/11-14	1SBH137001R1459	0.320

(1) NF...11 not suitable for direct control by PLC.

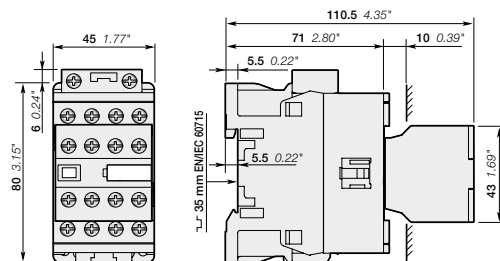

NF44E, NF53E, NF62E, NF71E, NF80E, NF33/11, NF51/11

Main dimensions mm, inches



# NFZ 8-pole contactor relays

24 V DC operated designed for PLC



NFZ44E

1SBH101539V0014

NFZ contactor relays are used for switching auxiliary and control circuits. These contactor relays are of the block type design with:

- 8 poles with a permanently fixed 4-pole auxiliary contact block. Contactor relays have mechanically linked auxiliary contact elements (side-marked symbol)
- control circuit: 24 V DC operated with electronic coil interface allowing low holding consumption up to 1.7 W and reduced panel energy consumption
  - allow direct control by PLC-output  $\geq 250$  mA 24 V DC
  - very distinct closing and opening
- built-in surge suppression.

Number of contacts	Rated control circuit voltage U <sub>c</sub>	Type	Order code	Weight Pkg (1 pce) kg
	V DC			

### 8-pole contactor relays

	24	NFZ44E-30	1SBH136001R3044	0.490
	24	NFZ53E-30	1SBH136001R3053	0.490
	24	NFZ62E-30	1SBH136001R3062	0.490
	24	NFZ71E-30	1SBH136001R3071	0.490
	24	NFZ80E-30	1SBH136001R3080	0.490

Note: NFZ contactor relays with DC control voltage 24 V DC need to respect the connection polarities indicated close to the coil terminals: A1+ for the positive pole and A2- for the negative pole.

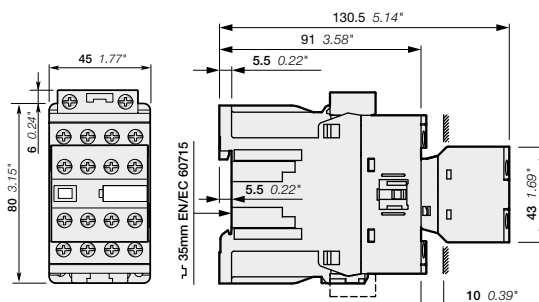

NFZ44E, NFZ53E, NFZ62E, NFZ71E, NFZ80E

Main dimensions mm, inches

03

1SBH1004315C0201

# NFZ 8-pole contactor relays

AC / DC operated for specific applications



NFZ44E

15BC101039V0014

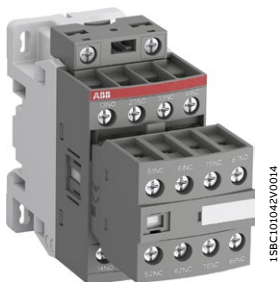

NFZ33/11

15BC101043V0014

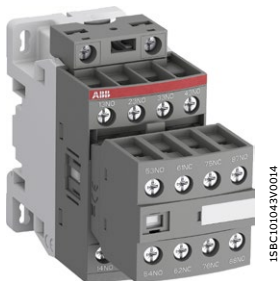

NFZ51/11

15BC101043V0014

NFZ contactor relays are used for switching auxiliary and control circuits.

These contactor relays are of the block type design with:

- 8 poles with a permanently fixed 4-pole auxiliary contact block. Contactor relays have mechanically linked auxiliary contact elements (side-marked symbol) except for NFZ33/11 and NFZ51/11 variants
- overlapping of lagging / leading contacts for NFZ33/11 and NFZ51/11 variants
- control circuit: AC or DC operated with electronic coil interface accepting a wide control voltage range (e.g. 100...250 V AC and DC)
  - can manage large control voltage variations
  - only 4 coils to cover control voltages between 24 ... 250 V 50/60 Hz and 12 ... 250 V DC
  - allow direct control by PLC-output  $\geq 24$  V DC 500 mA
  - reduced panel energy consumption
  - very distinct closing and opening
  - can withstand short voltage dips and voltage sags (SEMI F47-0706 conditions of use on request).
- built-in surge suppression
- add-on auxiliary contact blocks for side mounting and a wide range of accessories.

Number of contacts	Rated control circuit voltage	Type	Order code	Weight Pkg
1st stack	2nd stack			(1 pce)
		Uc min. ... Uc max.		kg
		V 50/60 Hz	V DC	

### 8-pole contactor relays

	-	12...20	NFZ44E-20	1SBH136001R2044	0.360
	24...60	20...60	NFZ44E-21	1SBH136001R2144	0.360
	48...130	48...130	NFZ44E-22	1SBH136001R2244	0.360
	100...250	100...250	NFZ44E-23	1SBH136001R2344	0.360
	-	12...20	NFZ53E-20	1SBH136001R2053	0.360
	24...60	20...60	NFZ53E-21	1SBH136001R2153	0.360
	48...130	48...130	NFZ53E-22	1SBH136001R2253	0.360
	100...250	100...250	NFZ53E-23	1SBH136001R2353	0.360
	-	12...20	NFZ62E-20	1SBH136001R2062	0.360
	24...60	20...60	NFZ62E-21	1SBH136001R2162	0.360
	48...130	48...130	NFZ62E-22	1SBH136001R2262	0.360
	100...250	100...250	NFZ62E-23	1SBH136001R2362	0.360
	-	12...20	NFZ71E-20	1SBH136001R2071	0.360
	24...60	20...60	NFZ71E-21	1SBH136001R2171	0.360
	48...130	48...130	NFZ71E-22	1SBH136001R2271	0.360
	100...250	100...250	NFZ71E-23	1SBH136001R2371	0.360
	-	12...20	NFZ80E-20	1SBH136001R2080	0.360
	24...60	20...60	NFZ80E-21	1SBH136001R2180	0.360
	48...130	48...130	NFZ80E-22	1SBH136001R2280	0.360
	100...250	100...250	NFZ80E-23	1SBH136001R2380	0.360

### 8-pole contactor relays with overlapping of lagging / leading contacts

	-	12...20	NFZ33/11-20	1SBH136001R2039	0.360
	24...60	20...60	NFZ33/11-21	1SBH136001R2139	0.360
	48...130	48...130	NFZ33/11-22	1SBH136001R2239	0.360
	100...250	100...250	NFZ33/11-23	1SBH136001R2339	0.360
	-	12...20	NFZ51/11-20	1SBH136001R2059	0.360
	24...60	20...60	NFZ51/11-21	1SBH136001R2159	0.360
	48...130	48...130	NFZ51/11-22	1SBH136001R2259	0.360
	100...250	100...250	NFZ51/11-23	1SBH136001R2359	0.360

Note: Only NFZ contactor relays with DC control voltage 12...20 V DC need to respect the connection polarities indicated close to the coil terminals: A1+ for the positive pole and A2- for the negative pole

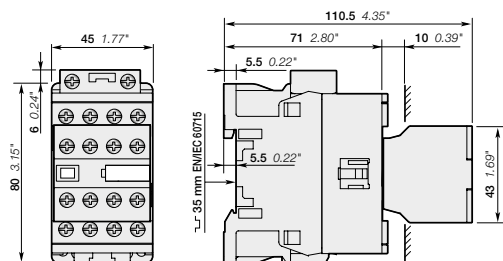

NFZ44E, NFZ53E, NFZ62E, NFZ71E, NFZ80E, NFZ33/11, NFZ51/11

Main dimensions mm, inches

15BC10156150201 - Rev. B

## NF 8-pole contactor relays

Contactor relays and main accessories

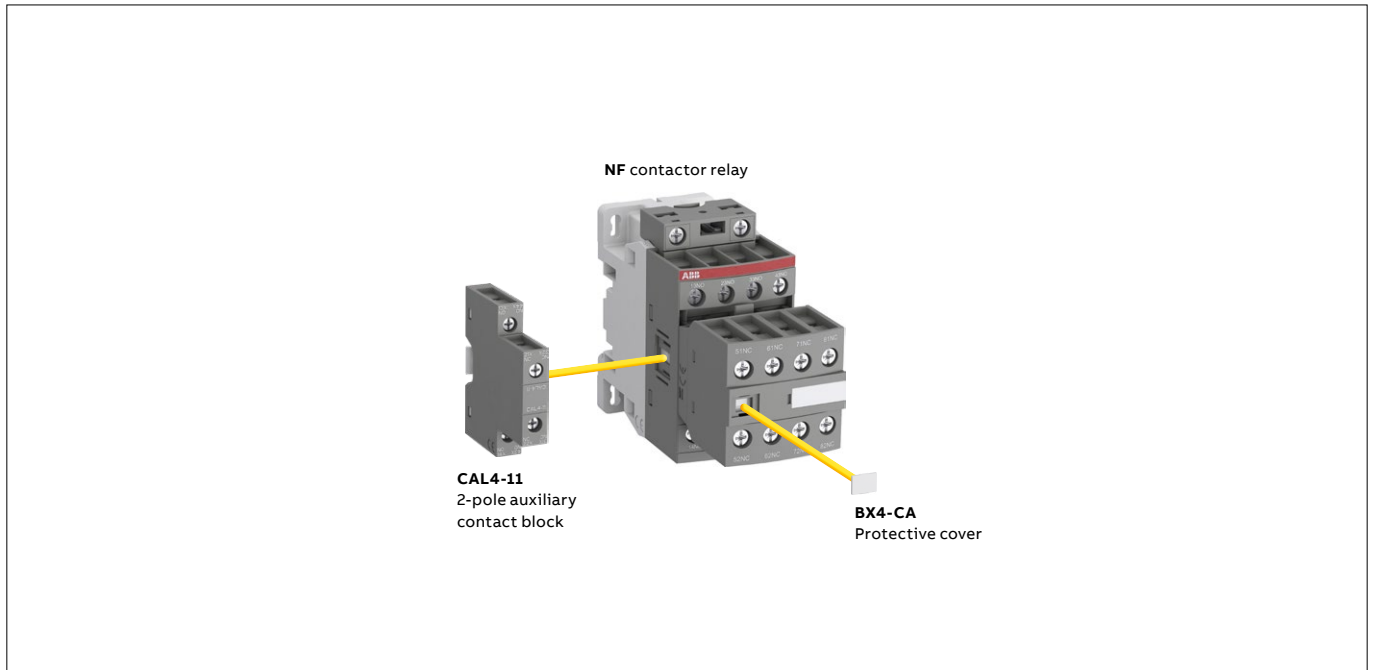

**Main accessory fitting details** - for ordering details, technical data and other accessories: see section accessories

Contactor relay types	Main poles	Side-mounted accessories																													
		Auxiliary contact blocks 2-pole CAL4-11 (1)																													
		Left side	Right side																												
NF	<table border="0"> <tr> <td>4</td><td>4</td><td>E</td><td></td></tr> <tr> <td>5</td><td>3</td><td>E</td><td></td></tr> <tr> <td>6</td><td>2</td><td>E</td><td></td></tr> <tr> <td>7</td><td>1</td><td>E</td><td></td></tr> <tr> <td>8</td><td>0</td><td>E</td><td></td></tr> <tr> <td>3</td><td>3</td><td>/</td><td>1 1</td></tr> <tr> <td>5</td><td>1</td><td>/</td><td>1 1</td></tr> </table>	4	4	E		5	3	E		6	2	E		7	1	E		8	0	E		3	3	/	1 1	5	1	/	1 1	1	-
4	4	E																													
5	3	E																													
6	2	E																													
7	1	E																													
8	0	E																													
3	3	/	1 1																												
5	1	/	1 1																												

(1) not allowed for 24 V DC operated contactor relay (coil 30).

## NF contactor relays

### Technical data

#### Contact utilization characteristics according to IEC

Contactor relay types	AC / DC operated	NF
Standards		IEC 60947-1 / 60947-5-1 and EN 60947-1 / 60947-5-1
Rated operational voltage U <sub>e</sub> max.		690 V
Rated frequency (without derating)		50 / 60 Hz
Conventional free-air thermal current I <sub>th</sub> θ ≤ 40 °C		16 A
I <sub>e</sub> / Rated operational current AC-15		
acc. to IEC 60947-5-1	24-127 V 50/60 Hz	6 A
	220-240 V 50/60 Hz	4 A
	400-440 V 50/60 Hz	3 A
	500 V 50/60 Hz	2 A
	690 V 50/60 Hz	2 A
Rated making capacity AC-15		10 x I <sub>e</sub> AC-15 acc. to IEC 60947-5-1
Rated breaking capacity AC-15		10 x I <sub>e</sub> AC-15 acc. to IEC 60947-5-1
I <sub>e</sub> / Rated operational current DC-13		
acc. to IEC 60947-5-1	24 V DC	6 A / 144 W
	48 V DC	2.8 A / 134 W
	72 V DC	1 A / 72 W
	110 V DC	0.55 A / 60 W
	125 V DC	0.55 A / 69 W
	220 V DC	0.27 A / 60 W
	250 V DC	0.27 A / 68 W
	400 V DC	0.15 A / 60 W
	500 V DC	0.13 A / 65 W
	600 V DC	0.1 A / 60 W
Short-circuit protection device gG type fuse		10 A
Rated short-time withstand current I <sub>cw</sub>	for 1.0 s	100 A
	for 0.1 s	140 A
Minimum switching capacity with failure rate acc. to IEC 60947-5-4		12 V / 3 mA
Non-overlapping time between N.O. and N.C. contacts		≥ 2 ms
Power dissipation per pole at 6 A		0.1 W
Max. electrical switching frequency	AC-15	1200 cycles/h
	DC-13	900 cycles/h
Mechanically linked contacts acc. to annex L of IEC 60947-5-1		Built-in N.O. or N.C. auxiliary contacts and additional N.O. or N.C. auxiliary contacts (CA4, CAL4 aux. contact blocks) are mechanically linked contacts.

#### Contact utilization characteristics according to UL / CSA

Contactor relay types	AC / DC operated	NF
Standards		UL 508, CSA C22.2 N°14
Max. operational voltage		600 V AC, 600 V DC
Pilot duty		A600, Q600
AC thermal rated current		10 A
AC maximum volt-ampere making		7200 VA
AC maximum volt-ampere breaking		720 VA
DC thermal rated current		2.5 A
DC maximum volt-ampere making-breaking		69 VA

# NF contactor relays

## Technical data

### Magnet System Characteristics - NF contactor relays AC / DC operated

Contact relay types	AC / DC operated	<b>NF</b>
Coil operating limits acc. to IEC 60947-5-1	AC supply	At $\theta \leq 60^\circ\text{C}$ $0.85 \times U_c \text{ min} \dots 1.1 \times U_c \text{ max}$ . At $\theta \leq 70^\circ\text{C}$ $0.85 \times U_c \text{ min} \dots U_c \text{ max}$ .
	DC supply	at $\theta \leq 60^\circ\text{C}$ $0.85 \times U_c \text{ min} \dots 1.1 \times U_c \text{ max}$
		at $\theta \leq 70^\circ\text{C}$ $0.85 \times U_c \text{ min} \dots U_c \text{ max}$
AC control voltage 50/60 Hz		
Rated control circuit voltage $U_c$		24...500 V AC
Coil consumption	Average pull-in value	50 VA
	Average holding value	2.2 VA / 2 W
DC control voltage		
Rated control circuit voltage $U_c$		20...500 V DC
Coil consumption	Average pull-in value	50 W
	Average holding value	2 W
PLC-output control		Not suitable for direct control by PLC-output
Drop-out voltage		$\leq 60\%$ of $U_c \text{ min}$ .
Voltage sag immunity acc. to SEMI F47-0706		-
Dips withstand $-20^\circ\text{C} \leq \theta \leq +60^\circ\text{C}$		-
Operating time		
Between coil energization and:	N.O. contact closing	40...95 ms
	N.C. contact opening	38...90 ms
Between coil de-energization and:	N.O. contact opening	11...95 ms
	N.C. contact closing	13...98 ms

### Magnet System Characteristics - NFZ contactor relays 24V DC operated - designed for PLC - coil 30

Contact relay types	DC operated	<b>NFZ</b>
Coil operating limits acc. to IEC 60947-5-1	DC supply	at $\theta \leq 60^\circ\text{C}$ $0.85 \dots 1.1 \times U_c$ at $\theta \leq 70^\circ\text{C}$ $U_c$
DC control voltage		
Rated control circuit voltage $U_c$		24 V DC
Coil consumption	Average pull-in value	6 W
	Average holding value	1.7 W
PLC-output control		$\geq 250 \text{ mA}$ 24 V DC for PLCs and safety PLCs using broken wire detection
Drop-out voltage		$\leq 60\%$ of $U_c \text{ min}$ .
Operating time		
Between coil energization and:	N.O. contact closing	27 ... 53 ms
	N.C. contact opening	20 ... 35 ms
Between coil de-energization and:	N.O. contact opening	17 ... 29 ms
	N.C. contact closing	22 ... 57 ms

### Magnet System Characteristics - NFZ... contactor relays - for specific applications - coils 20, 21, 22, 23

Contact relay types	AC / DC operated	<b>NFZ</b>
Coil operating limits acc. to IEC 60947-5-1	AC supply	at $\theta \leq 60^\circ\text{C}$ $0.85 \times U_c \text{ min} \dots 1.1 \times U_c \text{ max}$ at $\theta \leq 70^\circ\text{C}$ $0.85 \times U_c \text{ min} \dots U_c \text{ max}$
	DC supply	at $\theta \leq 60^\circ\text{C}$ $0.85 \times U_c \text{ min} \dots 1.1 \times U_c \text{ max}$
		at $\theta \leq 70^\circ\text{C}$ $0.85 \times U_c \text{ min} \dots 1.1 \times U_c \text{ max}$
AC control voltage 50/60 Hz		
Rated control circuit voltage $U_c$		24...250 V AC
Coil consumption	Average pull-in value	16 VA
	Average holding value	1.7 VA / 1.5 W
DC control voltage		
Rated control circuit voltage $U_c$		12...250 V DC
Coil consumption	Average pull-in value	12 ... 16 W
	Average holding value	1.7 W
PLC-output control		(NFZ coil 21) $\geq 500 \text{ mA}$ 24 V DC for PLCs - Not suitable for safety PLCs
Drop-out voltage		$\leq 60\%$ of $U_c \text{ min}$ .
Voltage sag immunity acc. to SEMI F47-0706		Conditions of use on request
Dips withstand $-20^\circ\text{C} \leq \theta \leq +60^\circ\text{C}$		(NFZ coil 21, 22, 23) 22 ms average for $U_c \geq 24 \text{ V}$ 50/60 Hz or $U_c \geq 20 \text{ V}$ DC
Operating time		
Between coil energization and:	N.O. contact closing	40...95 ms
	N.C. contact opening	38...90 ms
Between coil de-energization and:	N.O. contact opening	11...95 ms
	N.C. contact closing	13...98 ms

# NF contactor relays

## Technical data

### General technical data

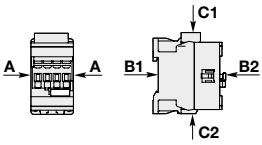
Contactor relay types	AC / DC operated	NF
Rated insulation voltage $U_i$ acc. to IEC 60947-5-1 acc. to UL / CSA		690 V 600 V
Rated impulse withstand voltage $U_{imp}$ .		6 kV
Electromagnetic compatibility		Devices complying with IEC 60947-1 / EN 60947-1 - Environment A and B (1)
Ambient air temperature close to contactor relay		
Operation in free air		-40...+70 °C
Storage		-60...+80 °C
Climatic withstand		Category B according to IEC 60947-1 Annex Q
Maximum operating altitude (without derating)		3000 m
Mechanical durability		
Number of operating cycles		20 millions operating cycles
Max. switching frequency		6000 cycles/h
Shock withstand acc. to IEC 60068-2-27 and EN 60068-2-27		
Mounting position 1		
	Shock direction	1/2 sinusoidal shock for 11 ms: no change in contact position, closed or open position
	A	30 g
	B1	25 g closed position / 5 g open position
	B2	15 g
	C1	25 g
	C2	25 g
Vibration withstand acc. to IEC 60068-2-6		5...300 Hz 4 g closed position / 2 g open position

(1) Environment B: all NF contactor relays produced since week 08-2013.

NF..E-12 (48...130 V 50/60 Hz-DC) compliant to environment A only: for environment B, select NFZ..E-22.

### Mounting characteristics

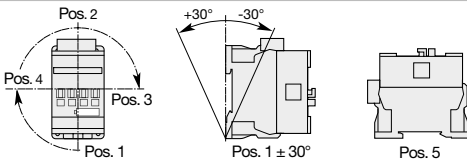
Contactor relay types	AC / DC operated	NF
Mounting positions		
Mounting distances		Max. add-on N.C. auxiliary contacts: see accessory fitting details for a NF contactor relay The contactor relays can be assembled side by side.
Fixing		
On rail according to IEC 60715, EN 60715		35 x 7.5 mm or 35 x 15 mm
By screws (not supplied)		2 x M4 screws placed diagonally

### Connecting characteristics

Contactor relay types	AC / DC operated	NF
Main terminals		 Screw terminals with cable clamp
Connection capacity (min. ... max.)		
Pole and coil terminals		
Rigid	1 x	1...2.5 mm <sup>2</sup>
	2 x	1...2.5 mm <sup>2</sup>
Flexible with non insulated ferrule	1 x	0.75...2.5 mm <sup>2</sup>
	2 x	0.75...2.5 mm <sup>2</sup>
Flexible with insulated ferrule	1 x	0.75...2.5 mm <sup>2</sup>
	2 x	0.75...1.5 mm <sup>2</sup>
Lugs	L <	8 mm
Connection capacity acc. to UL/CSA	1 or 2 x	AWG 18...14
Stripping length		10 mm
Tightening torque		
Pole terminals		1.2 Nm / 11 lb.in
Coil terminals		1.2 Nm / 11 lb.in
Degree of protection acc. to IEC 60947-1 / EN 60947-1 and IEC 60529 / EN 60529		IP20
All terminals		IP20
Screw terminals		Delivered in open position, screws of unused terminals must be tightened
All terminals		M3.5
Screwdriver type		Flat Ø 5.5 / Pozidriv 2

# NF..K contactor relays - with Push-in Spring terminals

AC / DC operated



NF22EK

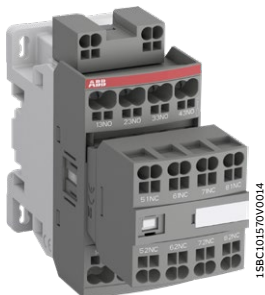

NF44EK

NF..K contactor relays are used for switching auxiliary and control circuits.

These contactor relays are of the block type design with:

- 4 poles and 8 poles with a permanently fixed 4-pole auxiliary contact block.
- Contactor relays have mechanically linked auxiliary contact elements (side-marked symbol)
- control circuit: AC or DC operated with electronic coil interface accepting a wide control voltage range (e.g. 100...250 V AC and DC)
  - can manage large control voltage variations
  - only 4 control voltage ranges covering 24...500 V 50/60 Hz and 20...500 V DC
  - reduced panel energy consumption
  - very distinct closing and opening
- built-in surge suppression
- add-on auxiliary contact blocks for front or side mounting and a wide range of accessories.

Number of contacts	Rated control circuit voltage Uc min. ... Uc max.	Type	Order code	Weight  Pkg (1 pce) kg
	V 50/60 Hz   V DC			

### 4-pole contactor relays

	24 ... 60	20 ... 60 (1)	NF22EK-11	1SBH137005R1122	0.285
	48 ... 130	48 ... 130	NF22EK-12	1SBH137005R1222	0.285
	100 ... 250	100 ... 250	NF22EK-13	1SBH137005R1322	0.285
	250 ... 500	250 ... 500	NF22EK-14	1SBH137005R1422	0.325
	24 ... 60	20 ... 60 (1)	NF31EK-11	1SBH137005R1131	0.285
	48 ... 130	48 ... 130	NF31EK-12	1SBH137005R1231	0.285
	100 ... 250	100 ... 250	NF31EK-13	1SBH137005R1331	0.285
	250 ... 500	250 ... 500	NF31EK-14	1SBH137005R1431	0.325
	24 ... 60	20 ... 60 (1)	NF40EK-11	1SBH137005R1140	0.285
	48 ... 130	48 ... 130	NF40EK-12	1SBH137005R1240	0.285
	100 ... 250	100 ... 250	NF40EK-13	1SBH137005R1340	0.285
	250 ... 500	250 ... 500	NF40EK-14	1SBH137005R1440	0.325

### 8-pole contactor relays

	24 ... 60	20 ... 60 (1)	NF44EK-11	1SBH137005R1144	0.330
	48 ... 130	48 ... 130	NF44EK-12	1SBH137005R1244	0.330
	100 ... 250	100 ... 250	NF44EK-13	1SBH137005R1344	0.330
	250 ... 500	250 ... 500	NF44EK-14	1SBH137005R1444	0.370
	24 ... 60	20 ... 60 (1)	NF53EK-11	1SBH137005R1153	0.330
	48 ... 130	48 ... 130	NF53EK-12	1SBH137005R1253	0.330
	100 ... 250	100 ... 250	NF53EK-13	1SBH137005R1353	0.330
	250 ... 500	250 ... 500	NF53EK-14	1SBH137005R1453	0.370
	24 ... 60	20 ... 60 (1)	NF62EK-11	1SBH137005R1162	0.330
	48 ... 130	48 ... 130	NF62EK-12	1SBH137005R1262	0.330
	100 ... 250	100 ... 250	NF62EK-13	1SBH137005R1362	0.330
	250 ... 500	250 ... 500	NF62EK-14	1SBH137005R1462	0.370
	24 ... 60	20 ... 60 (1)	NF71EK-11	1SBH137005R1171	0.330
	48 ... 130	48 ... 130	NF71EK-12	1SBH137005R1271	0.330
	100 ... 250	100 ... 250	NF71EK-13	1SBH137005R1371	0.330
	250 ... 500	250 ... 500	NF71EK-14	1SBH137005R1471	0.370
	24 ... 60	20 ... 60 (1)	NF80EK-11	1SBH137005R1180	0.330
	48 ... 130	48 ... 130	NF80EK-12	1SBH137005R1280	0.330
	100 ... 250	100 ... 250	NF80EK-13	1SBH137005R1380	0.330
	250 ... 500	250 ... 500	NF80EK-14	1SBH137005R1480	0.370

(1) NF..K-11 not suitable for direct control by PLC-output.

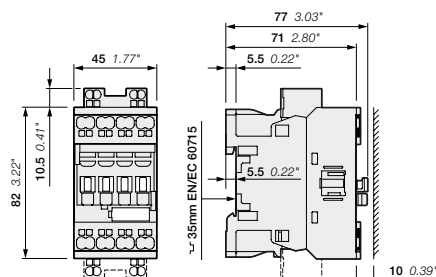

NF22EK, NF31EK, NF40EK

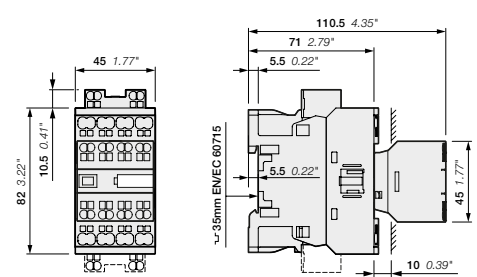

NF44EK, NF53EK, NF62EK, NF71EK, NF80EK

Main dimensions mm, inches



# NFZ..K contactor relays - with Push-in Spring terminals

24 V DC operated designed for PLC



NFZ22EK-30

1SBH136005R3022



NFZ44EK-30

1SBH136005R3044

NFZ contactor relays are used for switching auxiliary and control circuits.

These contactor relays are of the block type design with 4 poles or 8 poles (with a permanently fixed 4-pole auxiliary contact block).

- contactor relays have mechanically linked auxiliary contact elements (side-marked symbol)
- control circuit: 24 V DC operated with electronic coil interface allowing low holding consumption up to 1.7 W and reduced panel energy consumption
  - allow direct control by PLC-output  $\geq 250$  mA 24 V DC
  - very distinct closing and opening
- built-in surge suppression
- add-on auxiliary contact blocks for front or side mounting and a wide range of accessories.

Number of contacts	Rated control circuit voltage Uc min. ... Uc max.	Type	Order code	Weight Pkg (1 pce) kg
	VDC			

### 4-pole contactor relays

	24	NFZ22EK-30	1SBH136005R3022	0.435
	24	NFZ31EK-30	1SBH136005R3031	0.435
	24	NFZ40EK-30	1SBH136005R3040	0.435

### 8-pole contactor relays

	24	NFZ44EK-30	1SBH136005R3044	0.490
	24	NFZ53EK-30	1SBH136005R3053	0.490
	24	NFZ62EK-30	1SBH136005R3062	0.490
	24	NFZ71EK-30	1SBH136005R3071	0.490
	24	NFZ80EK-30	1SBH136005R3080	0.490

Note: NFZ contactor relays with 24 V DC control voltage need to respect the connection polarities indicated close to the coil terminals: A1+ for the positive pole and A2- for the negative pole.  
For product availability, please consult your ABB local sales organization.

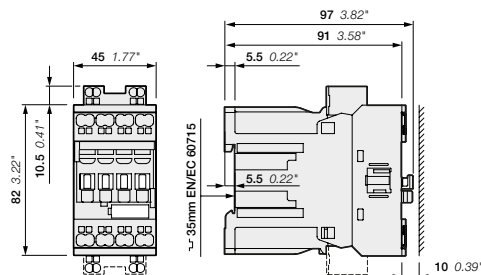

NFZ22EK, NFZ31EK, NFZ40EK

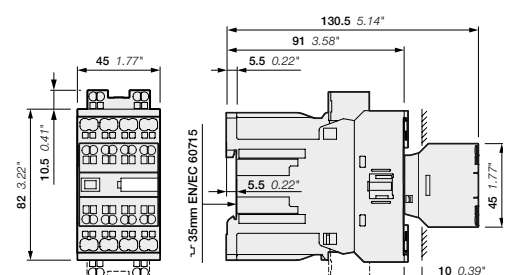

NFZ44EK, NFZ53EK, NFZ62EK, NFZ71EK, NFZ80EK

Main dimensions mm, inches

1SBH136005R3021

# NFZ..K contactor relays - with Push-in Spring terminals

AC / DC operated for specific applications



NFZ22EK



NFZ44EK

NFZ..K contactor relays are used for switching auxiliary and control circuits. These contactor relays are of the block type design with:

- 4 poles and 8 poles with a permanently fixed 4-pole auxiliary contact block.
- Contactor relays have mechanically linked auxiliary contact elements (side-marked symbol)
- control circuit: AC or DC operated with electronic coil interface accepting a wide control voltage range (e.g. 100...250 V AC and DC)
  - can manage large control voltage variations
  - only 4 control voltage ranges covering 24...250 V 50/60 Hz and 12...250 V DC
  - allow direct control by PLC-output  $\geq 24$  V DC 500 mA
  - reduced panel energy consumption
  - very distinct closing and opening
  - can withstand short voltage dips and voltage sags (SEMI F47-0706 conditions of use on request).
- built-in surge suppression
- add-on auxiliary contact blocks for front or side mounting and a wide range of accessories.

Number of contacts	Rated control circuit voltage Uc min. ... Uc max.	Type	Order code	Weight  Pkg (1 pce) kg
	V 50/60 Hz   V DC			

### 4-pole contactor relays

	-	12 ... 20	NFZ22EK-20	1SBH136005R2022	0.315
	24 ... 60	20 ... 60	NFZ22EK-21	1SBH136005R2122	0.315
	48 ... 130	48 ... 130	NFZ22EK-22	1SBH136005R2222	0.315
	100 ... 250	100 ... 250	NFZ22EK-23	1SBH136005R2322	0.315
	-	12 ... 20	NFZ31EK-20	1SBH136005R2031	0.315
	24 ... 60	20 ... 60	NFZ31EK-21	1SBH136005R2131	0.315
	48 ... 130	48 ... 130	NFZ31EK-22	1SBH136005R2231	0.315
	100 ... 250	100 ... 250	NFZ31EK-23	1SBH136005R2331	0.315
	-	12 ... 20	NFZ40EK-20	1SBH136005R2040	0.315
	24 ... 60	20 ... 60	NFZ40EK-21	1SBH136005R2140	0.315
	48 ... 130	48 ... 130	NFZ40EK-22	1SBH136005R2240	0.315
	100 ... 250	100 ... 250	NFZ40EK-23	1SBH136005R2340	0.315

### 8-pole contactor relays

	-	12 ... 20	NFZ44EK-20	1SBH136005R2044	0.360
	24 ... 60	20 ... 60	NFZ44EK-21	1SBH136005R2144	0.360
	48 ... 130	48 ... 130	NFZ44EK-22	1SBH136005R2244	0.360
	100 ... 250	100 ... 250	NFZ44EK-23	1SBH136005R2344	0.360
	-	12 ... 20	NFZ53EK-20	1SBH136005R2053	0.360
	24 ... 60	20 ... 60	NFZ53EK-21	1SBH136005R2153	0.360
	48 ... 130	48 ... 130	NFZ53EK-22	1SBH136005R2253	0.360
	100 ... 250	100 ... 250	NFZ53EK-23	1SBH136005R2353	0.360
	-	12 ... 20	NFZ62EK-20	1SBH136005R2062	0.360
	24 ... 60	20 ... 60	NFZ62EK-21	1SBH136005R2162	0.360
	48 ... 130	48 ... 130	NFZ62EK-22	1SBH136005R2262	0.360
	100 ... 250	100 ... 250	NFZ62EK-23	1SBH136005R2362	0.360
	-	12 ... 20	NFZ71EK-20	1SBH136005R2071	0.360
	24 ... 60	20 ... 60	NFZ71EK-21	1SBH136005R2171	0.360
	48 ... 130	48 ... 130	NFZ71EK-22	1SBH136005R2271	0.360
	100 ... 250	100 ... 250	NFZ71EK-23	1SBH136005R2371	0.360
	-	12 ... 20	NFZ80EK-20	1SBH136005R2080	0.360
	24 ... 60	20 ... 60	NFZ80EK-21	1SBH136005R2180	0.360
	48 ... 130	48 ... 130	NFZ80EK-22	1SBH136005R2280	0.360
	100 ... 250	100 ... 250	NFZ80EK-23	1SBH136005R2380	0.360

Note: NFZ contactor relays with 12...20 V DC control voltage need to respect the connection polarities indicated close to the coil terminals: A1+ for the positive pole and A2- for the negative pole.

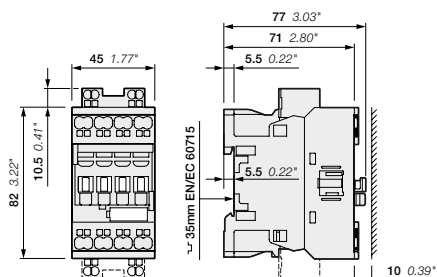

NFZ22EK, NFZ31EK, NFZ40EK

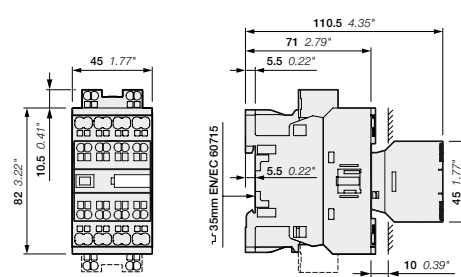

NFZ44EK, NFZ53EK, NFZ62EK, NFZ71EK, NFZ80EK

Main dimensions mm, inches

# NF..K contactor relays - with Push-in Spring terminals

## Contactor relays and main accessories

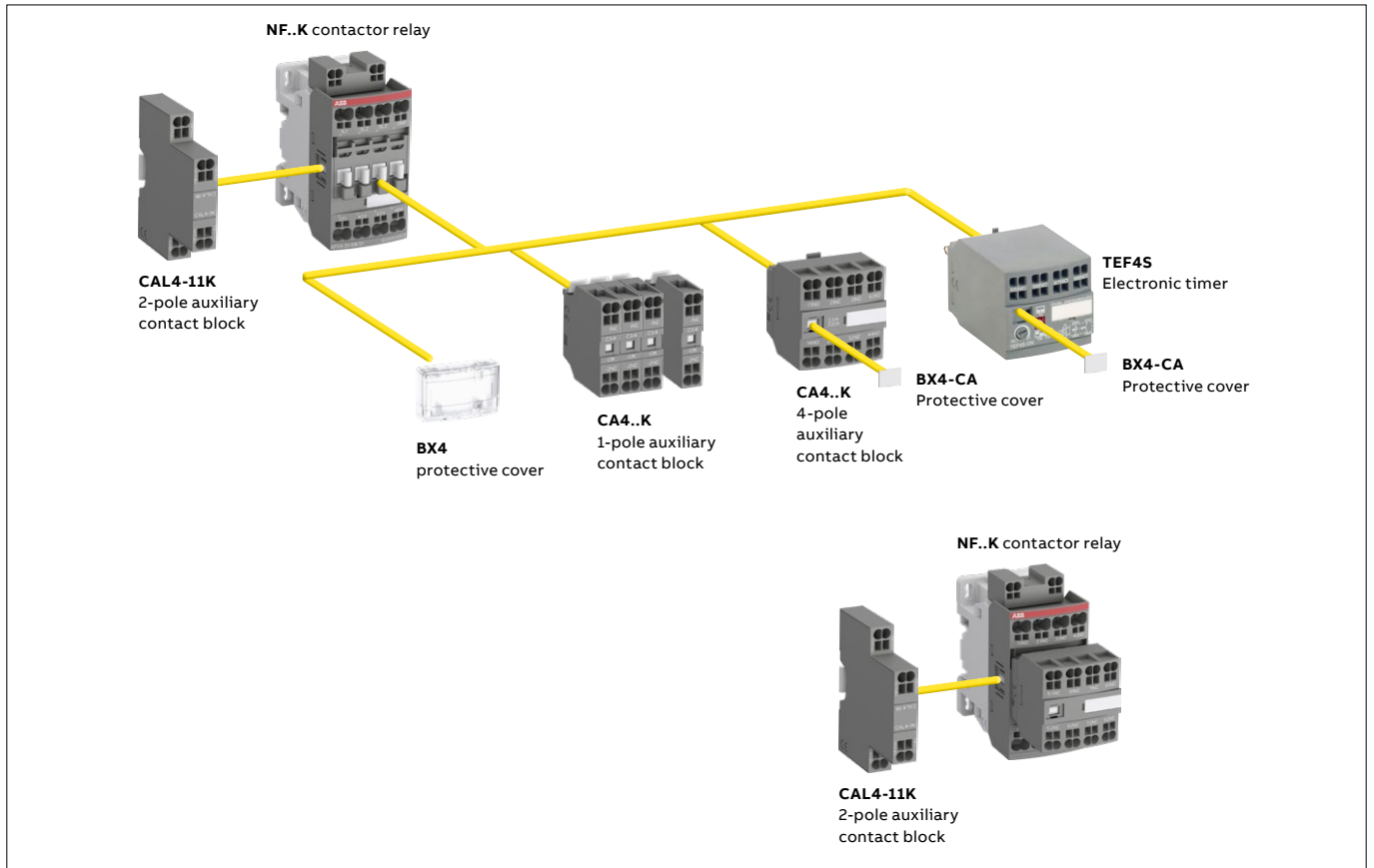

**Main accessory fitting details** - for ordering details, technical data and other accessories: see section accessories  
 Many configurations of accessories are possible depending on whether these are front-mounted or side-mounted.

Contactor relay types	Main poles 	Front-mounted accessories			Side-mounted accessories	
		Auxiliary contact blocks		Electronic timer	Auxiliary contact blocks 2-pole CAL4-11K	
		1-pole CA4..K	4-pole CA4..K	TEF4S	Left side	Right side
<b>NF(Z)</b>						
NF	2 2 EK (1)	4 max.	or 1	or 1	+ 1	-
	3 1 EK (1)	2 max.	-	or 1	+ 1	+ 1
	4 0 EK (2)					
NF	4 4 EK	-	-	-	+ 1	-
	5 3 EK					
	6 2 EK					
	7 1 EK					
	8 0 EK					
<b>NFZ 24 V DC designed for PLC - coil 30</b>						
NFZ	2 2 EK (1)	4 max.	or 1	or 1	or 1	+ 1
	3 1 EK (1)	2 max.	-	or 1	+ 1	
	4 0 EK (2)			1	+ 1	+ 1
NFZ	4 4 EK	-	-	-	-	-
	5 3 EK					
	6 2 EK					
	7 1 EK					
	8 0 EK					

(1) Including add-on contacts: 3 N.C. max. on positions 1, 2, 3, 4 and 2 N.C. max. on positions 1 ±30°, 5  
 (2) Including add-on contacts: 4 N.C. max. on positions 1, 2, 3, 4 and 3 N.C. max. on positions 1 ±30°, 5

## NF..K contactor relays - with Push-in Spring terminals

### Technical data

#### Contact utilization characteristics according to IEC

Contactor relay types	AC / DC operated	NF..K
Standards		IEC 60947-1 / 60947-5-1 and EN 60947-1 / 60947-5-1
Rated operational voltage Ue max.		690 V
Rated frequency (without derating)		50 / 60 Hz
Conventional free air thermal current Ith - $\theta \leq 40$ °C		16 A
le / Rated operational current AC-15		
acc. to IEC 60947-5-1	24-127 V 50/60 Hz	6 A
	220-240 V 50/60 Hz	4 A
	400-440 V 50/60 Hz	3 A
	500 V 50/60 Hz	2 A
	690 V 50/60 Hz	2 A
Making capacity AC-15		10 x le AC-15 acc. to IEC 60947-5-1
Breaking capacity AC-15		10 x le AC-15 acc. to IEC 60947-5-1
le / Rated operational current DC-13		
acc. to IEC 60947-5-1	24 V DC	6 A / 144 W
	48 V DC	2.8 A / 134 W
	72 V DC	1 A / 72 W
	110 V DC	0.55 A / 60 W
	125 V DC	0.55 A / 69 W
	220 V DC	0.27 A / 60 W
	250 V DC	0.27 A / 68 W
	400 V DC	0.15 A / 60 W
	500 V DC	0.13 A / 65 W
	600 V DC	0.1 A / 60 W
Short-circuit protection device gG type fuse		10 A
Rated short-time withstand current Icw	for 1.0 s	100 A
	for 0.1 s	140 A
Minimum switching capacity with failure rate acc. to IEC 60947-5-4		12 V / 3 mA
Non-overlapping time between N.O. and N.C. contacts		$\geq 2$ ms
Power dissipation per pole at 6 A		0.1 W
Maximum electrical switching frequency	AC-15	1200 cycles/h
	DC-13	900 cycles/h
Mechanically linked contacts acc. to annex L of IEC 60947-5-1		Built-in N.O. or N.C. auxiliary contacts and additional N.O. or N.C. auxiliary contacts (CA4, CAL4 aux. contact blocks) are mechanically linked contacts

#### Contact utilization characteristics according to UL / CSA

Contactor relay types	NF..K
Standards	UL 508, CSA C22.2 N°14
Maximum operational voltage	600 V AC, 600 V DC
Pilot duty	A600, Q600
AC thermal rated current	10 A
AC maximum volt-ampere making	7200 VA
AC maximum volt-ampere breaking	720 VA
DC thermal rated current	2.5 A
DC maximum volt-ampere making-breaking	69 VA

# NF..K contactor relays - with Push-in Spring terminals

## Technical data

### General technical data







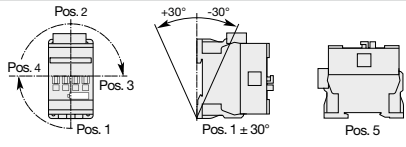

Contactor relay types	AC / DC operated	NF..K
Rated insulation voltage $U_i$		
acc. to IEC 60947-5-1		690 V
acc. to UL / CSA		600 V
Rated impulse withstand voltage $U_{imp}$ .		6 kV
Electromagnetic compatibility		Devices complying with IEC 60947-1 / EN 60947-1 - Environment A and B (1)
Ambient air temperature close to contactor relay		
Operation in free air		-40 ... +70 °C
Storage		-60 ... +80 °C
Climatic withstand		Category B according to IEC 60947-1 Annex Q
Maximum operating altitude (without derating)		3000 m
Mechanical durability		
Number of operating cycles		20 million operating cycles
Maximum switching frequency		6000 cycles/h
Shock withstand		
acc. to IEC 60068-2-27 and EN 60068-2-27		
Mounting position 1	Shock direction	1/2 sinusoidal shock for 11 ms: no change in contact position, closed or open position
	A	30 g
	B1	25 g closed position / 5 g open position
	B2	15 g
	C1	25 g
	C2	25 g
Vibration withstand		
acc. to IEC 60068-2-6		5 ... 300 Hz 4 g closed position / 2 g open position

(1) NF..-12 (48...130 V 50/60 Hz-DC) compliant to environment A only. For environment B: select NFZ..-22.

### Mounting characteristics

Contactor relay types	AC / DC operated	NF..K
Mounting positions		 <p>Max. add-on N.C. auxiliary contacts: see accessory fitting details for a NF contactor relay</p>
Mounting distances		The contactor relays can be assembled side by side
Fixing		
On rail according to IEC 60715, EN 60715		35 x 7.5 mm or 35 x 15 mm
By screws (not supplied)		2 x M4 screws placed diagonally

### Connecting characteristics

Contactor relay types	AC / DC operated	NF..K
Main terminals		 <p>Push-in Spring terminals</p>
Connection capacity (min. ... max.)		
Pole and coil terminals		
 Rigid	1 x	1 ... 2.5 mm <sup>2</sup>
 Rigid	2 x	1 ... 2.5 mm <sup>2</sup>
 Flexible with non insulated ferrule	1 x	1 (push-in) / 0.5 (spring) ... 2.5 mm <sup>2</sup>
 Flexible with non insulated ferrule	2 x	1 (push-in) / 0.5 (spring) ... 2.5 mm <sup>2</sup>
 Flexible with insulated ferrule	1 x	1 (push-in) / 0.5 (spring) ... 1.5 mm <sup>2</sup>
 Flexible with insulated ferrule	2 x	1 (push-in) / 0.5 (spring) ... 1.5 mm <sup>2</sup>
 Flexible without ferrule	1 x	(spring) 0.5 ... 2.5 mm <sup>2</sup>
 Flexible without ferrule	2 x	(spring) 0.5 ... 2.5 mm <sup>2</sup>
Connection capacity acc. to UL/CSA	1 or 2 x	AWG 18 ... 14
Stripping length		10 mm
Degree of protection		
acc. to IEC 60947-1 / EN 60947-1 and IEC 60529 / EN 60529		IP20
Screwdriver type	All terminals	Flat Ø 3 mm x 0.5 mm

## NF..K contactor relays - with Push-in Spring terminals

### Technical data

#### Magnet System Characteristics for NF..K contactor relays - AC / DC operated

Contactor relay types	AC / DC operated	NF..K
Coil operating limits acc. to IEC 60947-5-1	AC supply	at $\theta \leq 60^\circ\text{C}$ $0.85 \times U_c \text{ min} \dots 1.1 \times U_c \text{ max}$ at $\theta \leq 70^\circ\text{C}$ $0.85 \times U_c \text{ min} \dots U_c \text{ max}$
	DC supply	At $\theta \leq 60^\circ\text{C}$ $0.85 \times U_c \text{ min} \dots 1.1 \times U_c \text{ max}$ At $\theta \leq 70^\circ\text{C}$ $0.85 \times U_c \text{ min} \dots U_c \text{ max}$
AC control voltage 50/60 Hz		
Rated control circuit voltage $U_c$		24 ... 500 V AC
Coil consumption	Average pull-in value	50 VA
	Average holding value	2.2 VA / 2 W
DC control voltage		
Rated control circuit voltage $U_c$		20 ... 500 V DC
Coil consumption	Average pull-in value	50 W
	Average holding value	2 W
PLC-output control		Not suitable for direct control by PLC-output
Drop-out voltage		$\leq 60\%$ of $U_c \text{ min}$ .
Voltage sag immunity according to SEMI F47-0706		-
Dips withstand $-20^\circ\text{C} \leq \theta \leq +60^\circ\text{C}$		-
Operating time		
Between coil energization and:		
N.O. contact closing		40 ... 95 ms
N.C. contact opening		38 ... 90 ms
Between coil de-energization and:		
N.O. contact opening		11 ... 95 ms
N.C. contact closing		13 ... 98 ms

#### Magnet System Characteristics for NFZ..K contactor relays 24V DC operated - designed for PLC - coil 30

Contactor relay types	AC / DC operated	NFZ..K
Coil operating limits acc. to IEC 60947-5-1	DC supply	At $\theta \leq 60^\circ\text{C}$ $0.85 \dots 1.1 \times U_c$ At $\theta \leq 70^\circ\text{C}$ $U_c$
DC control voltage		
Rated control circuit voltage $U_c$		24 V DC
Coil consumption	Average pull-in value	6 W
	Average holding value	1.7 W
PLC-output control		$\geq 250 \text{ mA}$ 24 V DC for PLCs and safety PLCs using broken wire detection
Drop-out voltage		$\leq 60\%$ of $U_c \text{ min}$ .
Operating time		
Between coil energization and:		
N.O. contact closing		27 ... 53 ms
N.C. contact opening		20 ... 35 ms
Between coil de-energization and:		
N.O. contact opening		17 ... 29 ms
N.C. contact closing		22 ... 57 ms

#### Magnet System Characteristics for NFZ..K contactor relays - for specific applications - coils 20, 21, 22, 23

Contactor relay types	AC / DC operated	NFZ..K
Coil operating limits acc. to IEC 60947-5-1	AC supply	At $\theta \leq 60^\circ\text{C}$ $0.85 \times U_c \text{ min} \dots 1.1 \times U_c \text{ max}$ At $\theta \leq 70^\circ\text{C}$ $0.85 \times U_c \text{ min} \dots U_c \text{ max}$
	DC supply	At $\theta \leq 70^\circ\text{C}$ $0.85 \times U_c \text{ min} \dots 1.1 \times U_c \text{ max}$
AC control voltage 50/60 Hz		
Rated control circuit voltage $U_c$		24 ... 250 V AC
Coil consumption	Average pull-in value	16 VA
	Average holding value	1.7 VA / 1.5 W
DC control voltage		
Rated control circuit voltage $U_c$		12 ... 250 V DC
Coil consumption	Average pull-in value	12 ... 16 W
	Average holding value	1.7 W
PLC-output control		(AF..Z coil 21) $\geq 500 \text{ mA}$ 24 V DC for PLCs
Drop-out voltage		$\leq 60\%$ of $U_c \text{ min}$ .
Voltage sag immunity according to SEMI F47-0706		(NFZ coil 21, 22, 23) conditions of use on request
Dips withstand $-20^\circ\text{C} \leq \theta \leq +60^\circ\text{C}$		(NFZ coil 21, 22, 23) 20 ms average for $U_c \geq 24 \text{ V}$ 50/60 Hz or $U_c \geq 20 \text{ V}$ DC
Operating time		
Between coil energization and:		
N.O. contact closing		40 ... 95 ms
N.C. contact opening		38 ... 90 ms
Between coil de-energization and:		
N.O. contact opening		11 ... 95 ms
N.C. contact closing		13 ... 98 ms



— **For direct product details information, use product type or order code, ex:**

- [www.abb.com/productdetails/AF09-30-10-13](http://www.abb.com/productdetails/AF09-30-10-13)
- or [www.abb.com/productdetails/1SBL137001R1310](http://www.abb.com/productdetails/1SBL137001R1310)



---

# Accessories

## **Accessories for AF09 ... AF2850 3-pole contactors, AF09 ... AF370 4-pole contactors and NF contactor relays**

<b>3/230</b>	Auxiliary contact blocks
<b>3/245</b>	Electronic timers
<b>3/248</b>	Interlocks
<b>3/250</b>	Impulse contact blocks
<b>3/252</b>	Interface relays
<b>3/254</b>	Mechanical latching units
<b>3/256</b>	Other accessories
<b>3/258</b>	Additional terminal blocks
<b>3/259</b>	Terminal shrouds
<b>3/260</b>	Connections
<b>3/261</b>	Terminal connecting strips and shorting bars
<b>3/262</b>	Connection accessories for starting solutions
<b>3/263</b>	Connection sets for star-delta starter
<b>3/264</b>	Connection accessories for starting solutions with Push-in Spring terminals
<b>3/265</b>	Connection bars
<b>3/266</b>	Mounting plates
<b>3/267</b>	Adapter plates
<b>3/268</b>	Low Voltage Ride Through (LVRT) modules
<b>3/269</b>	Contactor coils, main contact sets and arc chutes

## **Accessories for UA, UA..RA, GA75, GAE75, GAF contactors**

<b>3/272</b>	Auxiliary contact blocks
<b>3/278</b>	Electronic timers
<b>3/282</b>	Mechanical and electrical interlock units
<b>3/284</b>	CA5, CE5, CAL, CEL18 and TEF5 fitting details
<b>3/285</b>	Function markers - Mounting piece
<b>3/286</b>	Surge suppressors for contactor coils
<b>3/288</b>	Interface relays
<b>3/290</b>	Mechanical latching units
<b>3/292</b>	Additional terminal blocks and others accessories
<b>3/293</b>	Terminals for control lead connections
<b>3/294</b>	Connection bar for contactors
<b>3/295</b>	Contactor coils and main contact sets

## **Accessories for EK550, EK1000 4-pole contactors**

<b>3/298</b>	Auxiliary contact blocks
<b>3/302</b>	Mechanical interlock units, terminal shrouds and connection sets
<b>3/303</b>	Surge suppressors for contactor coils
<b>3/305</b>	Main contact sets - Arc chutes
<b>3/306</b>	Contactor coils
<b>3/404</b>	<b>Voltage code table</b>



---

# Accessories for AF09 ... AF2850 3-pole contactors, AF09 ... AF370 4-pole contactors and NF contactor relays

- 3/230 Auxiliary contact blocks**
- 3/245 Electronic timers**
- 3/248 Interlocks**
- 3/250 Impulse contact blocks**
- 3/252 Interface relays**
- 3/254 Mechanical latching units**
- 3/256 Other accessories**
- 3/258 Additional terminal blocks**
- 3/259 Terminal shrouds**
- 3/260 Connections**
- 3/261 Terminal connecting strips and shorting bars**
- 3/262 Connection accessories for starting solutions**
- 3/263 Connection sets for star-delta starter**
- 3/264 Connection accessories for starting solutions with Push-in Spring terminals**
- 3/265 Connection bars**
- 3/266 Mounting plates**
- 3/267 Adapter plates**
- 3/268 Low Voltage Ride Through (LVRT) modules**
- 3/269 Contactor coils, main contact sets and arc chutes**



For direct product details information, use product type or order code, ex:

- [www.abb.com/productdetails/AF09-30-10-13](http://www.abb.com/productdetails/AF09-30-10-13)
- or [www.abb.com/productdetails/1SBL137001R1310](http://www.abb.com/productdetails/1SBL137001R1310)

# Auxiliary contact blocks for AF09 ... AF96 contactors and NF contactor relays



CA4-10

1SBC100001V0014



CAL4-11

1SBC100007V0014



CA4-22E

1SBC100006V0014



CAT4-11E

1SBC100002V0014

The auxiliary contact blocks are used for the operation of auxiliary circuits and control circuits for standard industrial environments.

Types of auxiliary contact blocks for front mounting:

- CA4 1 or 4-pole block, with instantaneous N.O., N.C. contacts
- CC4 1-pole block, with N.O. leading contact or N.C. lagging contact
- CAT4 2-pole block, with instantaneous N.O. + N.C. contacts and A1 / A2 coil terminal connection on front face.



Select the 4-pole auxiliary contact blocks CA4-..E, CA4-..M, CA4-..U or CA4-..N type, according to the contactor or contactor relay type for compliance with the standard requirements (see "Terminal marking and positioning").

Types of auxiliary contact blocks for side mounting:

- CAL4 2-pole block, with instantaneous N.O. + N.C. contacts.

For clipping onto the right- and/or left-hand side of the contactors.

The auxiliary contact blocks are equipped with screw type connecting terminals delivered open, protected against accidental direct contact and bear the corresponding function marking.

For contactors	Auxiliary contacts	Type	Order code	Pkg qty	Weight (1 pce)
	 				kg

### Front-mounted instantaneous auxiliary contact blocks

AF09 ... AF96	1 0	--	CA4-10	1SBN010110R1010	1	0.014
4-pole NF	1 0	--	CA4-10-T	1SBN010110T1010	10	0.014
	0 1	--	CA4-01	1SBN010110R1001	1	0.014
	0 1	--	CA4-01-T	1SBN010110T1001	10	0.014
	AF09 ... AF16..-30-10	2 2	--	CA4-22M	1SBN010140R1122	1
	3 1	--	CA4-31M	1SBN010140R1131	1	0.055
	1 3	--	CA4-13M	1SBN010140R1113	1	0.055
	0 4	--	CA4-04M	1SBN010140R1104	1	0.055
AF26 ... AF96..-30-00	2 2	--	CA4-22E	1SBN010140R1022	1	0.055
AF09 ... AF80..-40-00	3 1	--	CA4-31E	1SBN010140R1031	1	0.055
AF09 ... AF80..-22-00	4 0	--	CA4-40E	1SBN010140R1040	1	0.055
AF26 ... AF96..-30-00	0 4	--	CA4-04E	1SBN010140R1004	1	0.055
AF09 ... AF16..-40-00						
AF40 ... AF80..-40-00						
AF09 ... AF16..-30-01	2 2	--	CA4-22U	1SBN010140R1322	1	0.055
	3 1	--	CA4-31U	1SBN010140R1331	1	0.055
	4 0	--	CA4-40U	1SBN010140R1340	1	0.055
4-pole NF	2 2	--	CA4-22N	1SBN010140R1222	1	0.055
	3 1	--	CA4-31N	1SBN010140R1231	1	0.055
	4 0	--	CA4-40N	1SBN010140R1240	1	0.055
	1 3	--	CA4-13N	1SBN010140R1213	1	0.055
NF..40E	0 4	--	CA4-04N	1SBN010140R1204	1	0.055

### Front-mounted auxiliary contact blocks with N.O. leading contact and N.C. lagging contact

AF09 ... AF96	--	1 0	CC4-10	1SBN010111R1010	1	0.014
4-pole NF	--	0 1	CC4-01	1SBN010111R1001	1	0.014

Note: 1 max CC4-10 and 1 max CC4-01.

CC4-01 use: on each "Accessory fitting details" table, the allowed number of N.C. add-on and built-in contacts including CC4-01, is decreased by one.

### Side-mounted instantaneous auxiliary contact blocks

AF09 ... AF96	1 1	--	CAL4-11	1SBN010120R1011	1	0.040
NF	1 1	--	CAL4-11-T	1SBN010120T1011	10	0.040

### Front-mounted instantaneous auxiliary contact and A1/A2 coil terminal blocks

AF09 ... AF16..-30-10	1 1	--	CAT4-11M	1SBN010151R1111	1	0.040
AF26 ... AF65..-30-00	1 1	--	CAT4-11E	1SBN010151R1011	1	0.040
AF09 ... AF52..-40-00						
AF09 ... AF40..-22-00						
AF09 ... AF16..-30-01	1 1	--	CAT4-11U	1SBN010151R1311	1	0.040

For each contactor or contactor relay type, refer to "Accessory fitting details" table.

Note: CAT4 not suitable for AF..Z contactors with DC control voltage 12...20 V DC (coil 20) and 24 V DC (coil 30).

# Auxiliary contact blocks for AF09 ... AF96 contactors and NF contactor relays

## Technical data





### Contact utilization characteristics according to IEC

Types	<b>1-pole CA4, 1-pole CC4, 4-pole CA4, 2-pole CAT4, 2-pole CAL4</b>	
Standards	IEC 60947-5-1 and EN 60947-5-1	
Rated insulation voltage Ui acc. to IEC 60947-5-1	690 V	
Rated impulse withstand voltage Uimp.	6 kV	
Rated operational voltage Ue max.	24...690 V	
Conventional thermal current Ith - θ ≤ 40 °C	16 A	
Rated frequency (without derating)	50/60 Hz	
Ie / Rated operational current AC-15 acc. to IEC 60947-5-1	24-127 V 50/60 Hz	6 A
	220-240 V 50/60 Hz	4 A
	400-440 V 50/60 Hz	3 A
	500 V 50/60 Hz	2 A
	690 V 50/60 Hz	2 A
Making capacity acc. to IEC 60947-5-1	10 x Ie AC-15	
Breaking capacity acc. to IEC 60947-5-1	10 x Ie AC-15	
Ie / Rated operational current DC-13 acc. to IEC 60947-5-1	24 V DC	6 A / 144 W
	48 V DC	2.8 A / 134 W
	72 V DC	1 A / 72 W
	110 V DC	0.55 A / 60 W
	125 V DC	0.55 A / 69 W
	220 V DC	0.27 A / 60 W
	250 V DC	0.27 A / 68 W
	400 V DC	0.15 A / 60 W
	500 V DC	0.13 A / 65 W
	600 V DC	0.1 A / 60 W
Short-circuit protection device gG type fuse	10 A	
Rated short-time withstand current Icw θ = 40 °C	for 1.0 s	100 A
	for 0.1 s	140 A
Minimum switching capacity with failure rate acc. to IEC 60947-5-4	12 V / 3 mA	
Power dissipation per pole at 6 A	10 <sup>-7</sup>	
Mechanical durability	Number of operating cycles	10 millions operating cycles
	Max. switching frequency	3600 cycles/h
Max. electrical switching frequency	AC-15	1200 cycles/h
	DC-13	900 cycles/h
Mechanically linked contacts acc. to annex L of IEC 60947-5-1	Additional N.O. or N.C. auxiliary contacts (CA4, CAL4, CAT4) are mechanically linked contacts	
Mirror contacts acc. to annex F of IEC 60947-4-1	Additional N.C. auxiliary contacts (CA4, CAL4, CAT4) are mirror contacts	

### Contact utilization characteristics according to UL / CSA

Types	<b>1-pole CA4, 1-pole CC4, 4-pole CA4, 2-pole CAT4, 2-pole CAL4</b>	
Standards	UL 508, CSA C22.2 N°14	
Max. operational voltage	600 V AC, 600 V DC	
Pilot duty	A600, Q600	
AC thermal rated current	10 A	
AC maximum volt-ampere making	7200 VA	
AC maximum volt-ampere breaking	720 VA	
DC thermal rated current	2.5 A	
DC maximum volt-ampere making-breaking	69 VA	

### Connecting characteristics

Types	<b>1-pole CA4, 1-pole CC4, 4-pole CA4, 2-pole CAT4, 2-pole CAL4</b>	
Connection capacity (min. ... max.)		
 Rigid solid	1 x	1...2.5 mm <sup>2</sup>
	2 x	1...2.5 mm <sup>2</sup>
 Flexible with non insulated ferrule	1 x	0.75...2.5 mm <sup>2</sup>
	2 x	0.75...2.5 mm <sup>2</sup>
 Flexible with insulated ferrule	1 x	0.75...2.5 mm <sup>2</sup>
	2 x	0.75...1.5 mm <sup>2</sup>
 Lugs	L <	8 mm
Connection capacity acc. to UL/CSA	1 or 2 x	AWG 18...14
Stripping length	10 mm	
Tightening torque	1.2 Nm / 11 lb.in	
Degree of protection acc. to IEC 60947-1 / EN 60947-1 and IEC 60529 / EN 60529	IP20	
Screw terminals	Delivered in open position, screws of unused terminals must be tightened	
All terminals	M3.5	
Screwdriver type	Flat Ø 5.5 / Pozidriv 2	



## Auxiliary contact blocks with Push-in Spring terminals



CA4-10K

1SBCL00080V0004



CA4-22EK

1SBCL00081V0004



CAL4-11K

1SBCL00082V0004

The auxiliary contact blocks are used for the operation of auxiliary circuits and control circuits for standard industrial environments.

Types of auxiliary contact blocks for front mounting:

- CA4..K 1 or 4-pole block, with instantaneous N.O., N.C. contacts

Select the 4-pole auxiliary contact blocks CA4-..EK, CA4-..MK or CA4-..NK type, according to the contactor or contactor relay type for compliance with the standard requirements (see "Terminal marking and positioning").

Types of auxiliary contact blocks for side mounting:

- CAL4..K 2-pole block, with instantaneous N.O. + N.C. contacts.

For clipping onto the right- and/or left-hand side of the contactors.

The auxiliary contact blocks are equipped with push-in spring terminals protected against accidental direct contact and bear the corresponding function marking.

For contactors	Auxiliary contacts	Type	Order code	Pkg qty	Weight (1 pce)
					kg

### Front-mounted instantaneous auxiliary contact blocks

AF09 ... AF96	1 0	CA4-10K	1SBN010160R1010	1	0.012
NF	1 0	CA4-10K-T	1SBN010160T1010	10	0.012
	0 1	CA4-01K	1SBN010160R1001	1	0.012
	0 1	CA4-01K-T	1SBN010160T1001	10	0.012
AF09 ... AF16..-30-10	2 2	CA4-22MK	1SBN010146R1122	1	0.050
	3 1	CA4-31MK	1SBN010146R1131	1	0.050
	1 3	CA4-13MK	1SBN010146R1113	1	0.050
	0 4	CA4-04MK	1SBN010146R1104	1	0.050
AF26 ... AF96..-30-00	2 2	CA4-22EK	1SBN010146R1022	1	0.050
AF09 ... AF80..-40-00	3 1	CA4-31EK	1SBN010146R1031	1	0.050
AF09 ... AF80..-22-00	4 0	CA4-40EK	1SBN010146R1040	1	0.050
4-pole NF	1 3	CA4-13NK	1SBN010146R1213	1	0.050
	2 2	CA4-22NK	1SBN010146R1222	1	0.050
	3 1	CA4-31NK	1SBN010146R1231	1	0.050
	4 0	CA4-40NK	1SBN010146R1240	1	0.050
NF40E	0 4	CA4-04NK	1SBN010146R1204	1	0.050

### Side-mounted instantaneous auxiliary contact blocks

#### 3-pole

AF09 ... AF96	1 1	CAL4-11K	1SBN010134R1011	1	0.030
NF					

Note: for each contactor or contactor relay type, refer to "Accessory fitting details" table.

# Auxiliary contact blocks for AF09 ... AF96 contactors and NF contactor relays with Push-in Spring terminals

## Technical data





### Contact utilization characteristics according to IEC

Contactor relay types		1-pole CA4..K, 4-pole CA4..K, 2-pole CAL4..K
Standards		IEC 60947-1 / 60947-4-1 and EN 60947-1 / 60947-4-1
Rated insulation voltage $U_i$ acc. to IEC 60947-5-1		690 V
Rated impulse withstand voltage $U_{imp}$ .		6 kV
Rated operational voltage $U_e$ max.		690 V
Conventional thermal current $I_{th} - \theta \leq 40^\circ\text{C}$		16 A
Rated frequency (without derating)		50 / 60 Hz
le / Rated operational current AC-15 acc. to IEC 60947-5-1		
	24-127 V 50/60 Hz	6 A
	220-240 V 50/60 Hz	4 A
	400-440 V 50/60 Hz	3 A
	500 V 50/60 Hz	2 A
	690 V 50/60 Hz	2 A
Making capacity acc. to IEC 60947-5-1		10 x $I_e$ AC-15
Breaking capacity acc. to IEC 60947-5-1		10 x $I_e$ AC-15
le / Rated operational current DC-13 acc. to IEC 60947-5-1		
	24 V DC	6 A / 144 W
	48 V DC	2.8 A / 134 W
	72 V DC	1 A / 72 W
	110 V DC	0.55 A / 60 W
	125 V DC	0.55 A / 69 W
	220 V DC	0.27 A / 60 W
	250 V DC	0.27 A / 68 W
	400 V DC	0.15 A / 60 W
	500 V DC	0.13 A / 65 W
	600 V DC	0.1 A / 60 W
Short-circuit protection device gG type fuse		10 A
Rated short-time withstand current $I_{cw}$		
	for 1.0 s	100 A
	for 0.1 s	140 A
$\theta = 40^\circ\text{C}$		
Minimum switching capacity with failure rate acc. to IEC 60947-5-4		12 V / 3 mA
		$10^{-7}$
Power dissipation per pole at 6 A		0.1 W
Mechanical durability		
	Number of operating cycles	10 million operating cycles
	Max. switching frequency	3600 cycles/h
Max. electrical switching frequency		
	AC-15	1200 cycles/h
	DC-13	900 cycles/h
Mechanically linked contacts acc. to annex L of IEC 60947-5-1		Additional N.O. or N.C. auxiliary contacts (CA4, CAL4) are mechanically linked contacts.
Mirror contacts acc. to annex F of IEC 60947-4-1		Additional N.C. auxiliary contacts (CA4, CAL4) are mirror contacts.

### Contact utilization characteristics according to UL / CSA

Standards	UL 508, CSA C22 N°14
Max. operational voltage	600 V AC, 600 V DC
Pilot duty	A600, Q600
AC thermal rated current	10 A
AC maximum volt-ampere making	7200 VA
AC maximum volt-ampere breaking	720 VA
DC thermal rated current	2.5 A
DC maximum volt-ampere making-breaking	69 VA

### Connecting characteristics

Connection capacity (min. ... max.)		
 Rigid solid	1 x	1 ... 2.5 mm <sup>2</sup>
	2 x	1 ... 2.5 mm <sup>2</sup>
 Flexible with ferrule	1 x	1 (push-in) / 0.5 (spring) ... 2.5 mm <sup>2</sup>
	2 x	1 (push-in) / 0.5 (spring) ... 2.5 mm <sup>2</sup>
 Flexible with insulated ferrule	1 x	1 (push-in) / 0.5 (spring) ... 1.5 mm <sup>2</sup>
	2 x	1 (push-in) / 0.5 (spring) ... 1.5 mm <sup>2</sup>
 Flexible without ferrule	1 x	(spring) 0.5 ... 2.5 mm <sup>2</sup>
	2 x	(spring) 0.5 ... 2.5 mm <sup>2</sup>
Connection capacity acc. to UL/CSA	1 or 2 x	AWG 18 ... 14
Stripping length		10 mm
Degree of protection acc. to IEC 60947-1 / EN 60947-1 and IEC 60529 / EN 60529		IP20
Screwdriver type		Flat Ø 3 mm x 0.5 mm



## Auxiliary contact blocks for severe industrial environments

for AF09 ... AF96 contactors and NF contactor relays



The auxiliary contact blocks are used for the operation of auxiliary circuits and control circuits for severe industrial environments.

Types of auxiliary contact blocks for front mounting:

- CE5 1-pole block, instantaneous with N.O. contact or N.C. contact, available in 2 IP degrees
  - CE5 D with built-in microswitch IP40, degree of protection (IP20 on terminals)
  - CE5 W with built-in microswitch IP67, degree of protection (IP20 on terminals).

The auxiliary contact blocks are equipped with screw type connecting terminals delivered open, protected against accidental direct contact and bear the corresponding function marking.

For contactors	Auxiliary contacts		Type	Order code	Pkg qty	Weight (1 pce)
						kg
AF09 ... AF96	1 -	- -	CE5-10D0.1	1SBN010015R1010	1	0.020
NF	- 1	- -	CE5-01D0.1	1SBN010015R1001	1	0.020
	1 -	- -	CE5-10D2	1SBN010017R1010	1	0.020
	- 1	- -	CE5-01D2	1SBN010017R1001	1	0.020
	1 -	- -	CE5-10W0.1	1SBN010016R1010	1	0.020
	- 1	- -	CE5-01W0.1	1SBN010016R1001	1	0.020
	1 -	- -	CE5-10W2	1SBN010018R1010	1	0.020
	- 1	- -	CE5-01W2	1SBN010018R1001	1	0.020

(1) For each contactor type, refer to "Accessory fitting details" table.

Note: For use with 24 V DC operated AF..Z contactor and NFZ contactor relay (coil 30), please consult your ABB local sales organization.

1-pole CE5 on	A
AF09 ... AF16..-30-xx 1 stack	103.5 mm / 4.07"
AF09, AF16..-40/22-00	
NF..E 1-stack	
AF26 ... AF38..-30-00	112.5 mm / 4.43"
AF26, AF38..-40/22-00	127.5 mm / 5.02"
AF40 ... AF65-30-00	137 mm / 5.39"
AF40 ... AF65-40/22-00	140 mm / 5.51"
AF80 ... AF96-30-00	142 mm / 5.59"
AF80-40/22-00	142 mm / 5.59"

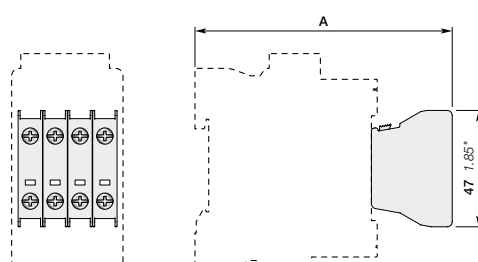

Main dimensions mm, inches

# Auxiliary contact blocks for severe industrial environments

## Technical data

	<b>Front mounted</b>	
<b>Types</b>	<b>1-pole CE5-..0.1</b>	<b>1-pole CE5-..2</b>



### Contact utilization characteristics according to IEC

Standards	IEC 60947-5-1 and EN 60947-5-1	
Rated insulation voltage Ui acc. to IEC 60947-5-1	250 V	
Rated operational voltage Ue max.	125 V	250 V
Conventional thermal current Ith - θ ≤ 40 °C	0.1 A	2 A
Rated frequency (without derating)	50 / 60 Hz	
Ie / Rated operational current acc. to IEC 60947-5-1	AC-14	AC-15
	24-127 V 50/60 Hz	0.1 A
	220-240 V 50/60 Hz	2 A
		2 A
Making capacity	6 x Ie AC-14 acc. to IEC 60947-5-1	
Breaking capacity	6 x Ie AC-14 acc. to IEC 60947-5-1	
Ie / Rated operational current DC-12 acc. to IEC 60947-5-1		10 x Ie AC-15 acc. to IEC 60947-5-1
	24 V DC	0.1 A
	48 V DC	0.1 A
	72 V DC	0.1 A
	110 V DC	0.1 A
	125 V DC	0.2 A
	220 V DC	0.2 A
		0.1 A
Short-circuit protection device FF type fuse (1)	0.1 A	10 A
Minimum switching capacity AF09 ... AF38 contactors with failure rate acc. to IEC 60947-5-4	3 V / 1 mA	17 V / 1 mA
	-	≤ 10 <sup>-7</sup>
Mechanical durability Number of operating cycles	5 millions for CE5-..D0.1	5 millions for CE5-..D2
	2.5 millions for CE5-..W0.1	2.5 millions for CE5-..W2
Max. switching frequency	3600 cycles/h	
Electrical durability Number of operating cycles	2.5 millions for CE5-..D0.1	1 million for CE5-..D2
	0.7 millions for CE5-..W0.1	0.3 millions for CE5-..W2
Max. electrical switching frequency	AC-14	1200 cycles/h
	AC-15	1200 cycles/h
	DC-12	900 cycles/h

### Contact utilization characteristics according to UL / CSA

Standards	UL 508, CSA C22.2 N°14	
Max. operational voltage	125 V AC / 110 V DC	250 V AC / 220 V DC
Pilot duty AC thermal rated current	0.1 A	2 A

### Connecting characteristics

Connection capacity (min. ... max.)		
 Rigid solid	1 x	1...4 mm <sup>2</sup>
	2 x	1...4 mm <sup>2</sup>
 Flexible with ferrule	1 x	0.75...2.5 mm <sup>2</sup>
	2 x	0.75...2.5 mm <sup>2</sup>
 Lugs	L ≤	7.7 mm
	l >	3.7 mm
Connecting capacity acc. to UL / CSA	1 or 2 x	AWG 18...14
Tightening torque	1 Nm	
Degree of protection	Terminals	IP20
acc. to IEC 60947-1 / EN 60947-1 and IEC 60529 / EN 60529	Microswitches	IP40 for CE5-..D0.1
		IP67 for CE5-..W0.1
Screw terminals	Delivered in open position, screws of unused terminals must be tightened	
All terminals	M3.5	
Screwdriver type	Flat Ø 5.5 / Pozidriv 2	

(1) HRC fuses for very fast action (6.3 x 32 mm size).

## Auxiliary contact blocks for severe industrial environments

For AF09 ... AF96 3-pole contactors and AF09 ... AF80 4-pole contactors

### For AF contactors

**Main accessory fitting details** - for ordering details, technical data and other accessories: see section accessories

Many configurations of accessories are possible depending on whether these are front-mounted or side-mounted.

Contactor types	Main poles	Built-in auxiliary contacts	Front-mounted accessories			Side-mounted accessories	
			Auxiliary contact blocks	Electrical and mechanical interlock set (Between 2 contactors)	Auxiliary contact blocks	Left side	Right side
			1-pole CE5	1-pole CA4	VEM4	2-pole CAL4-11	

### 3-pole contactors AF09 ... AF96

		Max. N.C. built-in and add-on N.C. auxiliary contacts (CA4, CAL4, VEM4): 2 max. with 1 CE5, none with 2 CE5 on positions 1, 2, 3, 4						
AF09 ... AF16	3 0 0 1	▶	1	+ 3 max.	-	+ 1	-	
AF09 ... AF16	3 0 1 0	▶	2	+ 2 max.	-	-	-	
AF26 ... AF38	3 0 0 0	▶	1	+ 3 max.	-	+ 1	-	
		▶	1	+ 1 max.	-	+ 1	+ 1	
		▶	1	+ 2 max.	+ 1	+ 1	-	
		Max. N.C. built-in or add-on N.C. auxiliary contacts (CA4, CAL4, VEM4): 1 max. with 1 CE5 on positions 1 ±30°, 5						
AF09 ... AF16	3 0 0 1	▶	1	+ 3 max.	-	-	-	
AF09 ... AF16	3 0 1 0	▶	1	+ 3 max.	-	+ 1	-	
AF26 ... AF38	3 0 0 0	▶	1	+ 2 max.	+ 1	-	-	
		Max. add-on N.C. auxiliary contacts (CA4, CAL4): 4 max. with 1 CE5, 2 max. with 2 CE5 on positions 1, 1 ±30°, 2, 3, 4, 5						
AF40 ... AF96	3 0 0 0	▶	2	+ 2 max.	-	+ 1	+ 1	
		▶	1	+ 3 max.	-	+ 1	+ 1	

### 4-pole contactors AF09 ... AF80

		Max. add-on N.C. auxiliary contacts (CA4, CAL4, VEM4): 2 max. with 1 CE5, none with 2 CE5 on positions 1, 2, 3, 4						
AF09, AF16	4 0 0 0	▶	2	+ 2 max.	-	-	-	
		▶	1	+ 3 max.	-	+ 1	-	
		▶	1	+ 1 max.	-	+ 1	+ 1	
		▶	1	+ 2 max.	+ 1	+ 1	-	
		Max. add-on N.C. auxiliary contacts (CA4, CAL4, VEM4): 1 max. with 1 CE5 on positions 1, 2, 3, 4						
AF26, AF38	4 0 0 0	▶	1	+ 3 max.	-	+ 1	-	
		▶	1	+ 2 max.	+ 1	-	-	
AF09, AF16	2 2 0 0	▶	1	+ 3 max.	-	+ 1	-	
AF26, AF38		▶						
		Max. add-on N.C. auxiliary contacts (CA4, CAL4, VEM4): 1 max. with 1 CE5 on positions 1 ±30°, 5						
AF09, AF16	4 0 0 0	▶	1	+ 3 max.	-	+ 1	-	
		▶	1	+ 2 max.	+ 1	-	-	
		No add-on N.C. auxiliary contacts on positions 1 ±30°, 5						
AF26, AF38	4 0 0 0	▶	1	+ 3 max.	-	-	-	
AF09, AF16	2 2 0 0	▶						
AF26, AF38	2 2 0 0	▶						
		Max. add-on N.C. auxiliary contacts (CA4, CAL4): 4 max. with 1 CE5, 2 max. with 2 CE5 on positions 1, 1 ±30°, 2, 3, 4, 5						
AF40 ... AF80	4 0 0 0	▶	2	+ 2 max.	-	+ 1	+ 1	
		▶	1	+ 3 max.	-	+ 1	+ 1	
		No add-on N.C. auxiliary contacts on positions 1, 1 ±30°, 2, 3, 4, 5						
AF40, AF80	2 2 0 0	▶	1	+ 3 max.	-	-	-	

## Auxiliary contact blocks for severe industrial environments

### For NF contactor relays

**Main accessory fitting details** - for ordering details, technical data and other accessories: see section accessories

Many configurations of accessories are possible depending on whether these are front-mounted or side-mounted.

Contactor relay types	Main poles 		Front-mounted accessories			Side-mounted accessories	
			Auxiliary contact blocks			Auxiliary contact blocks	
			1-pole CE5	1-pole CA4		Left side	Right side
Max. add-on N.C. auxiliary contacts (CA4, CAL4): 1 max. with 1 CE5 on positions 1, 2, 3, 4							
NF	2 2 3 1	E E	1	+ 3 max.	-	+ 1	-
Max. add-on N.C. auxiliary contacts (CA4, CAL4): 2 max. with 1 CE5, none with 2 CE5 on positions 1, 2, 3, 4							
NF	4 0	E	2	+ 2 max.	-	-	-
			1	+ 3 max.	-	+ 1	-
			1	+ 1 max.	-	+ 1	+ 1
Max. add-on N.C. auxiliary contacts (CA4): none with 1 CE5 on positions 1 ±30°, 5							
NF	2 2 3 1	E E	1	+ 3 max.	-	-	-
Max. add-on N.C. auxiliary contacts (CA4, CAL4): 1 max. with 1 CE5 on positions 1 ±30°, 5							
NF	4 0	E	1	+ 3 max.	-	+ 1	-

## Auxiliary contact blocks for AF116 ... AF2850 contactors



CAL19-11

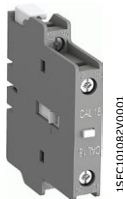

CAL18-11

The auxiliary contact blocks are used for the operation of auxiliary circuits and control circuits for standard industrial environments.

Types of auxiliary contact blocks for side mounting:

- CAL 2-pole block, with instantaneous N.O. + N.C. contacts.

For clipping onto the right- and/or left-hand side of the contactors.

The CAL ...-11B is a second block for mounting in addition to a first CAL ...-11 block, right- and/or left-hand of the AF116 ... AF2850 contactors.

The auxiliary contact blocks are equipped with screw type connecting terminals delivered open, protected against accidental direct contact and bear the corresponding function marking.

For contactors	Auxiliary contacts	Type	Order code	Pkg qty	Weight (1 pce)
					kg

### Side-mounted instantaneous auxiliary contact blocks

AF116 ... AF370	1 1	CAL19-11	1SFN010820R1011	1	0.040
	1 1	CAL19-11B	1SFN010820R3311	1	0.040
AF400 ... AF2850	1 1	CAL18-11	1SFN010720R1011	2	0.050
	1 1	CAL18-11B	1SFN010720R3311	2	0.050

For each contactor type, refer to "Accessory fitting details" table.

## Auxiliary contact blocks for AF116 ... AF2850 contactors

### Technical data

Types	CAL18	CAL19
-------	-------	-------

### Contact utilization characteristics according to IEC





Standards	IEC 60947-5-1 and EN 60947-5-1		
Rated insulation voltage $U_i$ acc. to IEC 60947-5-1	690 V		
Rated impulse withstand voltage $U_{imp}$ .	6 kV		
Rated operational voltage $U_e$ max.	24...690 V AC		
Conventional thermal current $I_{th} - \theta \leq 40^\circ\text{C}$	16 A		
Rated frequency (without derating)	50/60 Hz		
$I_e$ / Rated operational current AC-15 acc. to IEC 60947-5-1	24-127 V 50/60 Hz	6 A	
	220-240 V 50/60 Hz	4 A	
	380-440 V 50/60 Hz	3 A	
	500-690 V 50/60 Hz	2 A	
Making capacity acc. to IEC 60947-5-1	10 x $I_e$ AC-15		
Breaking capacity acc. to IEC 60947-5-1	10 x $I_e$ AC-15		
$I_e$ / Rated operational current DC-13 acc. to IEC 60947-5-1	24 V DC	6 A / 144 W	3 A / 72 W
	48 V DC	2.8 A / 134 W	1.5 A / 72 W
	72 V DC	1 A / 72 W	1 A / 72 W
	110 V DC	0.55 A / 60 W	0.55 A / 60 W
	125 V DC	0.55 A / 69 W	0.55 A / 69 W
	220 V DC	0.3 A / 66 W	0.3 A / 69 W
	250 V DC	0.3 A / 75 W	0.3 A / 75 W
Short-circuit protection device gG type fuse	10 A		
Rated short-time withstand current $I_{cw}$ $\theta = 40^\circ\text{C}$	for 1.0 s	100 A	
	for 0.1 s	140 A	
Minimum switching capacity with failure rate acc. to IEC 60947-5-4	24 V / 50 mA (0.5 million of operating cycles)		24 V / 50 mA
Power dissipation per pole at 6 A	$\leq 10^{-6}$		
Mechanical durability	0.15 W		
Number of operating cycles	3 millions (A/AF400 ... AF750)		5 millions operating cycles
	0.5 million (AF1250 ... AF2050)		
Max. switching frequency	3600 cycles/h		300 cycles/h
	Max. electrical switching frequency	AC-15	1200 cycles/h
DC-13		900 cycles/h	
Mirror contacts acc. to annex F of IEC 60947-4-1	N.C. auxiliary contacts are mirror contacts (1)		

(1) CAL19: for 3-pole contactors only.

### Contact utilization characteristics according to UL / CSA

Standards	UL 508, CSA C22.2 N°14
Max. operational voltage	600 V AC, 250 V DC
Pilot duty	A600, Q300
AC thermal rated current	10 A
AC maximum volt-ampere making	7200 V A
AC maximum volt-ampere breaking	720 V A
DC thermal rated current	2.5 A
DC maximum volt-ampere making-breaking	69 V A

### Connecting characteristics

Connection capacity (min. ... max.)	
 Solid / stranded	1 x 1...4 mm <sup>2</sup>
	2 x 1...4 mm <sup>2</sup>
 Flexible with non insulated ferrule	1 x 0.75...2.5 mm <sup>2</sup>
	2 x 0.75...2.5 mm <sup>2</sup>
 Flexible with insulated ferrule	1 x 0.75...2.5 mm <sup>2</sup>
	2 x 0.75...2.5 mm <sup>2</sup>
 Lugs	$L \leq$ 8 mm
	$l >$ 3.7 mm
Connection capacity acc. to UL/CSA	1 or 2 x AWG18...14
Stripping length	9 mm
Tightening torque	1 Nm
Degree of protection acc. to IEC 60947-1 / EN 60947-1 and IEC 60529 / EN 60529	IP20
Screw terminals	Delivered in open position, screws of unused terminals must be tightened
All terminals	M3.5
Screwdriver type	Flat Ø 5.5 / Pozidriv 2

## Auxiliary contact blocks for AF116 ... AF2850 contactors for severe industrial environments



The auxiliary contact blocks are used for the operation of auxiliary and control circuits for severe industrial environments.

Types of auxiliary contact blocks for side mounting:

- CEL 1-pole block, with built-in microswitch IP67 degree of protection (IP20 on terminals). Instantaneous N.O. or N.C. contact.

For clipping onto the right- and/or left-hand side of the contactors.

The auxiliary contact blocks are equipped with screw type connecting terminals delivered open, protected against accidental direct contact and bear the corresponding function marking.

For contactors	Auxiliary contacts	Type	Order code	Pkg qty	Weight (1 pce)
					kg

### Side-mounting instantaneous auxiliary contact blocks

AF116 ... AF370	1 0	CEL19-10	1SFN010832R1010	1	0.040
	0 1	CEL19-01	1SFN010832R1001	1	0.040
AF400 ... AF2850	1 0	CEL18-10	1SFN010716R1010	1	0.050
	0 1	CEL18-01	1SFN010716R1001	1	0.050

For each contactor type, refer to "Accessory fitting details" table.



# Auxiliary contact blocks for AF116 ... AF2850 contactors for severe industrial environments

## Technical data

Types	CEL18, CEL19
-------	--------------





### Contact utilization characteristics according to IEC

Standards	IEC 60947-5-1 and EN 60947-5-1		
Rated insulation voltage $U_i$ acc. to IEC 60947-5-1	250 V		
Rated operational voltage $U_e$ max.	125 V		
Conventional thermal current $I_{th} - \theta \leq 40^\circ C$	0.1 A		
$I_e$ / Rated operational current AC-14 acc. to IEC 60947-5-1	24-127 V 50/60 Hz	0.1 A	
Making capacity acc. to IEC 60947-5-1	6 x $I_e$ AC-14		
Breaking capacity acc. to IEC 60947-5-1	6 x $I_e$ AC-14		
$I_e$ / Rated operational current DC-12 acc. to IEC 60947-5-1	24 V DC	0.1 A	
	48 V DC	0.1 A	
	72 V DC	0.1 A	
	110 V DC	0.1 A	
	220 V DC	-	
Short-circuit protection device	0.1 A (FF type fuses) (1)		
Minimum switching capacity with failure rate acc. to IEC 60947-5-4	3 V / 1 mA		
Mechanical durability	Number of operating cycles	1 million (2)	
	Max. switching frequency	1200 cycles/h (2)	
Electrical durability	Number of operating cycles	0.7 millions (2)	
	Max. switching frequency	AC-14, AC15	1200 cycles/h (2)
		DC-12	900 cycles/h (2)
Mirror contacts acc. to annex F of IEC 60947-4-1	N.C. auxiliary contacts are mirror contacts		

### Contact utilization characteristics according to UL / CSA

Standards	UL 508, CSA C22.2 N°14
Max. operational voltage	125 V
Pilot duty	
AC thermal rated current	0.1 A

### Connecting characteristics

Connection capacity (min. ... max.)		
	Rigid solid	1 x 1...4 mm <sup>2</sup>
	Flexible with ferrule	2 x 1...4 mm <sup>2</sup>
		1 x 0.75...2.5 mm <sup>2</sup>
	Lugs	2 x 0.75...2.5 mm <sup>2</sup>
		L ≤ 7.7 mm
		L > 3.7 mm
Connection capacity acc. to UL/CSA	1 or 2 x	AWG 18...14
Tightening torque		1 Nm
Degree of protection	Terminals	IP20
acc. to IEC 60947-1 / EN 60947-1 and IEC 60529 / EN 60529	Microswitches	IP67
Screw terminals	Delivered in open position, screws of unused terminals must be tightened	
All terminals	M3.5	
Screwdriver type	Flat Ø 5.5 / Pozidriv 2	

(1) or HRC fuses for very fast action (6.3 x 32 mm size).  
 (2) For CEL19, please consult us.

# Auxiliary contact blocks for AF09 ... AF96 contactors and NF contactor relays

## Electrical durability

### Electrical durability for AC-15 utilization category

AC-15 utilization category according to IEC 60947-5-1 / EN 60947-5-1:

- making current:  $10 \times I_e$  with  $\cos \phi = 0.7$  and  $U_e$
- breaking current:  $I_e$  with  $\cos \phi = 0.4$  and  $U_e$ .

These curves represent the electrical durability of the built-in or add-on auxiliary contacts in relation to the breaking current. The curves have been drawn for resistive and inductive loads up to 690 V, 40...60 Hz.

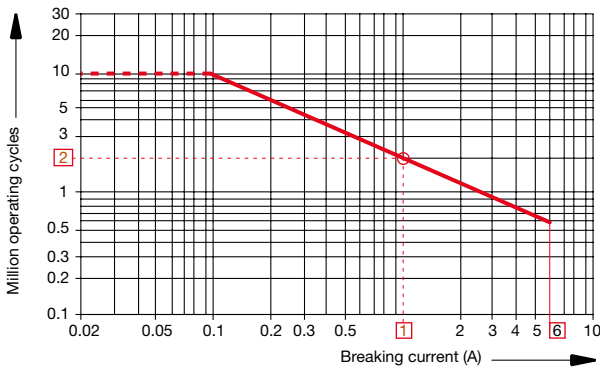

- AF09 ... AF96 contactor built-in auxiliary contacts
- 1-pole and 4-pole CA4, 2-pole CAT4, 1-pole CC4, 2-pole CAL4 add-on auxiliary contacts.

Example:

Breaking current = 1 A

On the opposite curve at intersection "O" 1 A the corresponding value for the electrical durability is approximately 2 millions operating cycles.

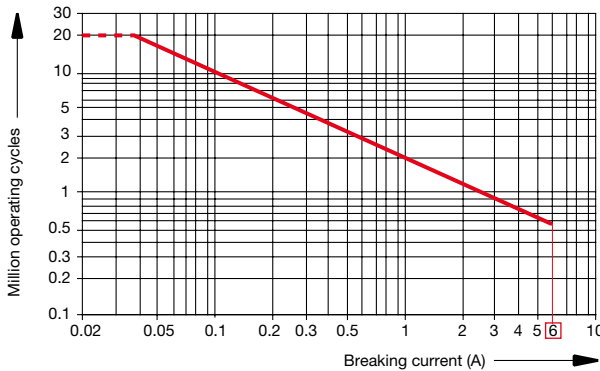

NF contactor relays.

(For add on auxiliary contacts see curve above).

### Electrical durability for DC-13 utilization category

DC-13 utilization category according to IEC 60947-5-1 / EN 60947-5-1: making and breaking current  $I_e$  and  $U_e$ .

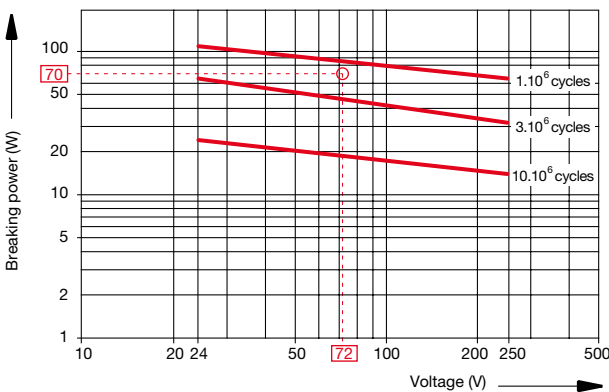

- AF09 ... AF96 contactor built-in auxiliary contacts 1-pole and 4-pole CA4, 2-pole CAT4, 1-pole CC4,
- 2-pole CAL4 add-on auxiliary contacts,
- NF contactor relays.

Example:

Control of DC electro-magnet:

$U_e$  voltage = 72 V DC and breaking power = 70 W.

On the opposite curve at intersection "O" 72 V / 70 W the corresponding value for the electrical durability is approximately 2 millions operating cycles.

## Auxiliary contact blocks for AF116 ... AF2850 contactors

### Electrical durability

#### Electrical durability for AC-15 utilization category

AC-15 utilization category according to IEC 60947-5-1 / EN 60947-5-1:

- making current:  $10 \times I_e$  with  $\cos \phi = 0.7$  and  $U_e$
- breaking current:  $I_e$  with  $\cos \phi = 0.4$  and  $U_e$ .

This curves represent the electrical durability of the add-on auxiliary contacts, in relation to the breaking current.

The curves have been drawn for resistive and inductive loads up to 690 V, 40...60 Hz.

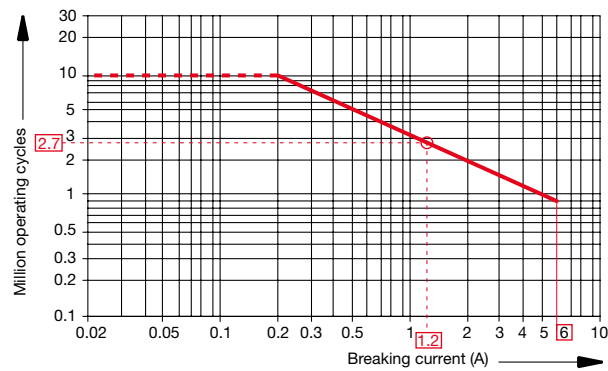

- AF116 ... AF2850 contactors auxiliary contacts
- 2-pole CAL18 and CAL19 add-on auxiliary contacts

Example:

Breaking current = 1.2 A

On the opposite curve at intersection "O" 1.2 A the corresponding value for the electrical durability is approximately 2.7 millions operating cycles.

# Add-on auxiliary contacts

## Terminal marking and positioning

### 1-pole auxiliary contacts

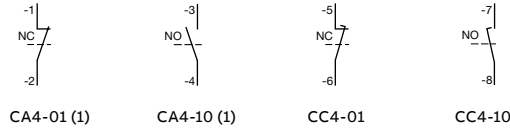

### 2-pole auxiliary contacts

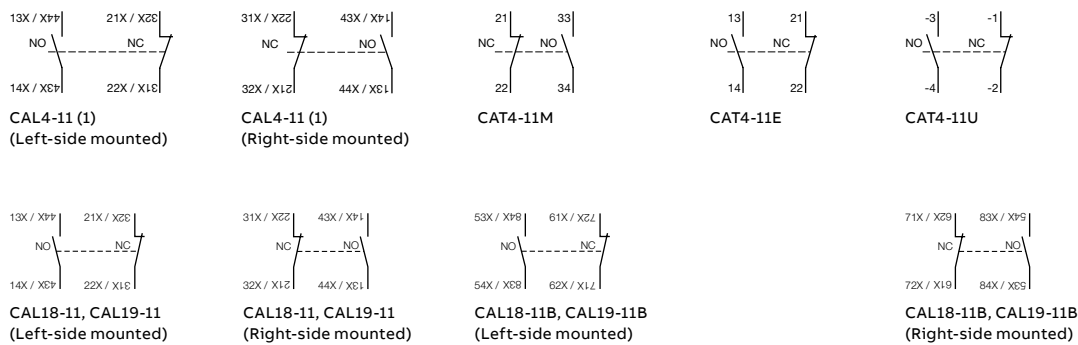

### 4-pole auxiliary contacts



(1) available with Push-in Spring terminals

# Electronic timers



TEF4-ON



TEF4-OFF



TEF4S-ON



TEF4S-OFF

TEF4 frontal electronic timers are used for realizing timing function and are available in ON-delay and OFF-delay versions.

Compact solution in cabinet compared to separate timers

TEF4 electronic timers are front-mounted and locked on AF contactors or NF contactor relays. A mechanical indicator allows to show the state of the contactor.

Safe and cost-reduced wiring

TEF4 electronic timers are supplied by a direct plug-in parallel connection to the coil terminals A1 - A2 of the contactor or contactor relay. A varistor is integrated on the timer to offer a built-in protection against surges in the contactor coil.

Available for a wide control voltage range 24...240 V AC/DC

TEF4-ON or TEF4-OFF allow time-delayed functions up to 100 s in 3 distinct time ranges, independently of the control system. The time delay ranges are selected by a switch and the time delay can be adjusted by means of a rotary switch. The timing function is activated by closing or opening the device on which the timer is mounted. The OFF-delay version operates without additional control supply.

For contactors, contactor relays	Time delay range selected by switch	Delay type	Rated control circuit voltage U <sub>c</sub>	Auxiliary contacts	Type	Order code	Weight Pkg (1 pce)
			V 50/60 Hz or DC				kg

**With screw terminals**

AF09 ... AF96	0.1...1 s	ON-delay	24...240	1 1	TEF4-ON	1SBN020112R1000	0.065
NF	1...10 s 10...100 s	OFF-delay	24...240	1 1	TEF4-OFF	1SBN020114R1000	0.065

**With spring terminals**

AF09 ... AF96	0.1...1 s	ON-delay	24...240	1 1	TEF4S-ON	1SBN020113R1000	0.065
NF	1...10 s 10...100 s	OFF-delay	24...240	1 1	TEF4S-OFF	1SBN020115R1000	0.065

# Electronic timers

## Technical data

03

### Contact utilization characteristics according to IEC

Types		TEF4-ON	TEF4-OFF
Standards		IEC 60947-5-1 and EN 60947-5-1	
Rated insulation voltage $U_i$ acc. to IEC 60947-5-1		400 V	
Rated impulse withstand voltage $U_{imp}$		4 kV	
Rated operational voltage $U_e$ max.		240 V	
Rated frequency (without derating)		50 / 60 Hz	
Conventional thermal current $I_{th} - \theta \leq 40^\circ C$		5 A	
I <sub>e</sub> / Rated operational current AC-15 acc. to IEC 60947-5-1		24-127 V 50/60 Hz 220-240 V 50/60 Hz	3 A 1.5 A
Making capacity acc. to IEC 60947-5-1		10 x I <sub>e</sub> AC-15	
Breaking capacity acc. to IEC 60947-5-1		10 x I <sub>e</sub> AC-15	
I <sub>e</sub> / Rated operational current DC-13 acc. to IEC 60947-5-1		24 V DC	1 A / 24 W
Short-circuit protection device gG type fuse		6 A	
Rated short-time withstand current I <sub>cw</sub> $\theta = 40^\circ C$		for 1.0 s for 0.1 s	8 A 8 A
Minimum switching capacity with failure rate acc. to IEC 60947-5-4		24 V DC	12 V / 3 mA 10-7
Power dissipation per pole at 3 A		0.1 W	
Function diagram		ON-delay	OFF-delay
		Bistable relay inside. Before use, once apply $U_c$ then switch it off in order to initialize position of the contacts.	
Control circuit voltage			
AC control voltage	Rated control circuit voltage $U_c$	24...240 V AC	
50/60 Hz	Average consumption	1.5 mA RMS	1 mA RMS
DC control voltage	Rated control circuit voltage $U_c$	24...240 V DC	
	Average consumption	1.5 mA	1 mA
Rated frequency limits		50 / 60 Hz	
Supply voltage range		0.85...1.1 x $U_c$ (at $\theta \leq 70^\circ C$ )	
Overvoltage protection		Varistor included	
Time delay range (t) selected by switch		0.1...1 s <input type="checkbox"/>	
		1...10 s <input type="checkbox"/>	
		10...100 s <input type="checkbox"/>	
On-load reiteration accuracy under constant conditions		$\leq 1\%$	
Minimum ON period		0.1 s	1 s
Recovery time		0.15 s	0.1 s
Ambient air temperature	Operation	-25 °C ... +70 °C	
	Storage	-40 °C ... +80 °C	
Climatic withstand		Category B according to IEC 60947-1 Annex Q	
Maximum operating altitude		2000 m	
Mounting positions		Mounting positions 1, 1 +/- 30°, 2, 3, 4, 5	
Shock withstand acc. to IEC 60068-2-27 and EN 60068-2-27 (Mounting position 1)		1/2 sinusoidal shock for 11 ms: no change in contact position Same as contactor or contactor relay	
Vibration withstand acc. to IEC 60068-2-6		5...300 Hz 3 g closed position / 2 g open position	
Mechanical durability			
		Number of operating cycles	5 millions operating cycles
		Max. switching frequency	3600 cycles/h
Max. electrical switching frequency		AC-15	1200 cycles/h
		DC-13	900 cycles/h





# Electronic timers

## Technical data

### Contact utilization characteristics according to UL / CSA

Types	TEF4-ON	TEF4-OFF
Standards	UL 508, CSA C22.2 N°14	
Rated insulation voltage Ui acc. to UL / CSA	300 V	
Max. operational voltage	240 V	
Pilot duty	B300, R300	
AC thermal rated current	5 A	
AC maximum volt-ampere making	3600 VA	
AC maximum volt-ampere breaking	360 VA	
DC thermal rated current	1 A	
DC maximum volt-ampere making-breaking	28 VA	

### Connecting characteristics

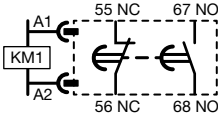
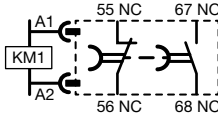
Connection capacity (min. ... max.)	
 Rigid solid	1 x 1...2.5 mm <sup>2</sup> 2 x 1...2.5 mm <sup>2</sup>
 Flexible with non insulated ferrule	1 x 0.75...2.5 mm <sup>2</sup> 2 x 0.75...2.5 mm <sup>2</sup>
 Flexible with insulated ferrule	1 x 0.75...2.5 mm <sup>2</sup> (0.75 ... 1.5 mm <sup>2</sup> with spring terminals) 2 x 0.75...1.5 mm <sup>2</sup> (0.75 ... 1.5 mm <sup>2</sup> with spring terminals)
 Lugs	L ≤ 8 mm (1) l > 3.7 mm (1)
Connection capacity acc. to UL / CSA	1 or 2 x AWG 18...14
Stripping length	10 mm
Tightening torque	1.2 N.m / 11 lb.in (1)
Degree of protection acc. to IEC 60947-1 / EN 60947-1 and IEC 60529 / EN 60529	IP20
Screw terminals	Delivered in open position, screws of unused terminals should be tightened
All terminals	M3.5
Screwdriver type	Flat Ø 5.5 / Pozidriv 2
Spring terminals	
Screwdriver type	Ø 3.5
Terminal Marking	 

(1) Not applicable for TEF4S-ON and TEF4S-OFF with spring terminal Spring terminals)

### Electrical durability for DC-13 utilization category

DC-13 utilization category according to IEC 60947-5-1 / EN 60947-5-1: making and breaking current Ie and Ue.

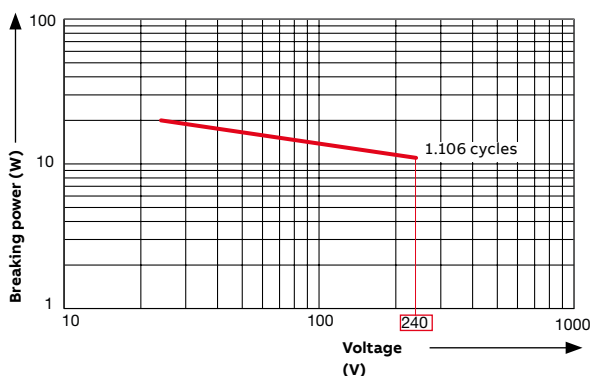



# Interlocks



VM4

1SBC100010V0014

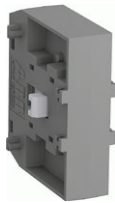

VM19

1SFC10035V0014

### Mechanical interlock units

The VM mechanical interlock units are designed for the interlocking of two AF contactors. When mounted between two contactors, the VM mechanical interlock unit prevents one of the contactors from closing as long as the other contactor is closed. The mechanical interlock units VM4 and VM96-4 include 2 fixing clips (BB4).

For contactors	Mounting	Type	Order code	Pkg qty	Weight (1 pce) kg
----------------	----------	------	------------	---------	-------------------

### Mechanical interlock units for two contactors mounted side by side

AF09 ... AF38..-30-..		VM4	1SBN030105T1000	10	0.005
AF09 ... AF38..-40-00					
AF40 ... AF96-30-..		VM96-4	1SBN033405T1000	10	0.006
AF40 ... AF80-40-00					
For same size contactors: AF116 ... AF146 AF190, AF205 AF265 ... AF370		VM19	1SFN030300R1000	1	0.054
AF116 ... AF146 and AF190, AF205		VM140/190	1SFN034403R1000	1	0.088
AF190, AF205 and AF265 ... AF370		VM205/265	1SFN035203R1000	1	0.090
AF265 ... AF370 and AF400 ... AF460		VM370/400	1SFN035403R1000	1	0.100
AF400 ... AF1250	PN.. mounting plate to be ordered separately	VM750H	1SFN035700R1000	1	0.200
AF1350 ... AF2650	Plate included	VM1650H	1SFN036503R1001	1	6.000

### Mechanical interlock units for two contactors mounted one above the other

AF400 ... AF1250	Additional plate (not supplied)	VM750V	1SFN035701R1000	1	0.200
------------------	---------------------------------	--------	-----------------	---	-------

### Mechanical and electrical interlock sets

VEM4 mechanical and electrical interlock set for the interlocking of two AF contactors. VEM4 set includes a mechanical interlock unit VM4 with 2 fixing clips (BB4) and a VE4 electrical interlock block with A2-A2 connection. Fixing the electrical interlock block to the contactor front face connects the 2 built-in N.C. interlocking contacts with the two coils. VE4 block must be used with A2-A2 connection to respect the electrical connection diagram.

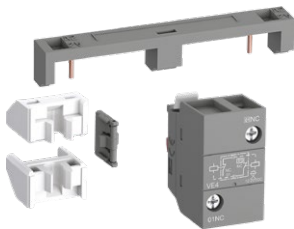

VEM4

1SFC100011V0014

For contactors	Auxiliary contacts	Type	Order code	Pkg qty	Weight (1 pce) kg

### Mechanical and electrical interlock set

For same size contactors: AF09 ... AF16..-30-.. AF26 ... AF38..-30-00 AF09, AF16..-40-00 AF26, AF38..-40-00	0 2	VEM4	1SBN030111R1000	1	0.035
---	-----	------	-----------------	---	-------

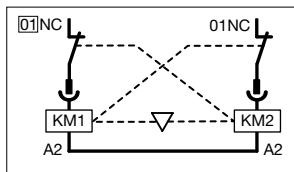

### Fixing clips

AF09 ... AF96	BB4	1SBN110120W1000	50	0.002
---------------	-----	-----------------	----	-------

Note: VEM4 not suitable for AF..Z contactors with DC control voltage 12...20 V DC (coil 20) and 24 V DC (coil 30).



BB4

1SBC100013V0014

## Interlocks

### Technical data

#### Mechanical interlock unit

Types		VM4, VM96	VM19 ... VM750	VM1650H
Mechanical durability	Number of operating cycles	5 millions operating cycles	1 million operating cycles	500 000 operating cycles
	Max. mechanical switching frequency	1800 cycles/h	300 cycles/h	

#### Mechanical and electrical interlock set





##### Contact utilization characteristics according to IEC

Types		VEM4
Standards		IEC 60947-5-1 and EN 60947-5-1
Rated insulation voltage $U_i$ acc. to IEC 60947-5-1		690 V
Rated impulse withstand voltage $U_{imp}$ .		6 kV
Rated control circuit voltage $U_c$		
	AC 50/60 Hz control voltage	24...500 V AC
	DC control voltage	20...500 V DC
Conventional thermal current $I_{th} - \theta \leq 40^\circ\text{C}$		16 A
Mechanical durability	Number of operating cycles	5 millions operating cycles
	Max. mechanical switching frequency	1800 cycles/h
Electrical durability	Max. electrical switching frequency	1200 cycles/h

##### Contact utilization characteristics according to UL / CSA

Types		VEM4
Standards		UL 508, CSA C22.2 N°14
Max. operational voltage		500 V AC, 500 V DC

##### Connecting characteristics

Types		VEM4
Connection capacity (min. ... max.)		
	Rigid solid	1 x 1...2.5 mm <sup>2</sup>
		2 x 1...2.5 mm <sup>2</sup>
	Flexible with ferrule	1 x 0.75...2.5 mm <sup>2</sup>
		2 x 0.75...2.5 mm <sup>2</sup>
	Flexible with insulated ferrule	1 x 0.75...2.5 mm <sup>2</sup>
		2 x 0.75...1.5 mm <sup>2</sup>
	Lugs	L < 8 mm
Connection capacity acc. to UL / CSA		1 or 2 x AWG 18...14
Stripping length		10 mm
Tightening torque		1.2 Nm / 11 lb.in
Degree of protection acc. to IEC 60947-1 / EN 60947-1 and IEC 60529 / EN 60529		IP20
Screw terminals		Delivered in open position, screws of unused terminals must be tightened
All terminals		M3.5
Screwdriver type		Flat Ø 5.5 / Pozidriv 2

## Impulse contact blocks

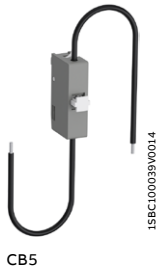

CB5

Impulse contact blocks are designed for use in enclosures, in association with an adjustable mechanical pushbutton. Two types are available:

- CB5-10: N.O. contact with a black actuator ("ON" function)
- CB5-01: N.C. contact with a light grey actuator ("OFF" function).

These blocks are equipped with 2 connecting leads 0.5 mm<sup>2</sup> with end, approximately 18 cm long.

Mounting: Clipped onto the front face of the contactors.

For contactors	Contacts	Type	Order code	Pkg qty	Weight (1 pce)
					kg
AF09 ... AF96	1 -	CB5-10	1SBN010013R1010	1	0.012
	- 1	CB5-01	1SBN010013R1001	1	0.012

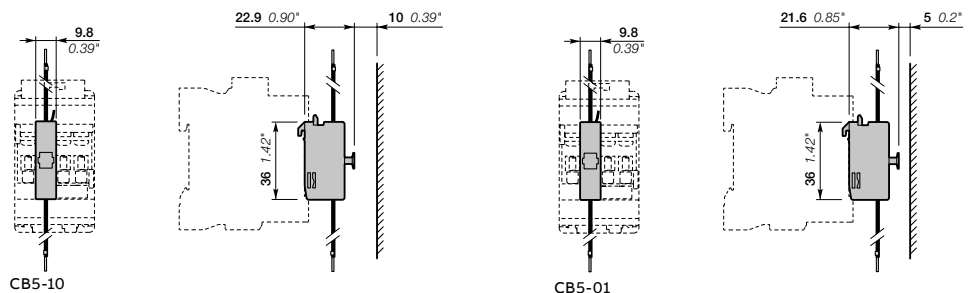

Main dimensions mm, inches

—  
**Notes**

A large rectangular area filled with a grid of small, light gray dotted lines, intended for handwritten notes.

# RA4 interface relays



RA4

RA4 interface relay is designed to receive 24 V DC signals delivered by PLC's or other sources with a low output power and to restore them with sufficient power to operate the coils of the relevant AF09 ... AF96 contactors or the NF contactor relays. RA4 interface relay is made up of a miniature electromechanical relay equipped with a N.O. contact and with a low consumption 24 V DC coil.

The interface relay coil is controlled by the PLC while the N.O. contact ensures switching of the power contactor.

Coil switching gives rise to overvoltages which have adverse effects on the electronic devices, insulators and, more generally, on component lifetime. The RA4 is protected from surge thanks to the built-in surge protection of AF09 ... AF96. Furthermore, the RA4 is protected against relay pole reversal by a diode inserted between the E1 and E2 input terminals.

### Connection

The "E1+" and "E2-" input terminals must be connected, according to their polarity, to the PLC-output.

The RA4 is equipped with two terminal pads for connection to the A1 and A2 terminals of the contactor coil.

This coil is supplied between the A0 and A2 terminals of the RA4.

### Mounting

Remove the coil terminal block from the contactor and clip the interface relay without any screwing operation.

For contactors (1)	Coil voltages (2)	Rated control circuit voltage U <sub>c</sub>	Type	Order code	Pkg qty	Weight (1 pce)
	V AC 50/60 Hz (4)	V DC				kg
AF09 ... AF96	24 ... 250	24	RA4	1SBN060100R1000	1	0.040
NF			RA4-T (3)	1SBN060100T1000	10	0.040

- (1) LDC4 additional terminal blocks and CAT4 auxiliary contact blocks not suitable with RA4.
- (2) Main use with contactor coils 41, 11, 12, 13.
- (3) On request. Please contact your ABB local sales organization.
- (4) 24 V DC on request.

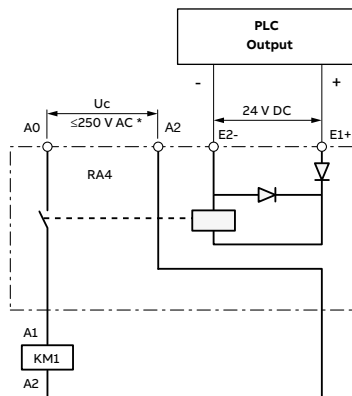

\* 24 V DC on request.

Wiring diagram

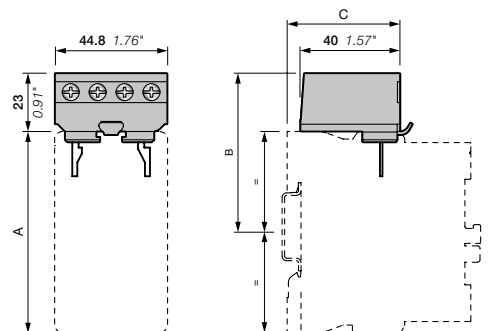

RA4 mounted on	AF09 ... AF38	AF40 ... AF96
A	80 mm / 3.15"	119.5 mm / 4.70"
B	63 mm / 2.48"	83 mm / 3.27"
C	45 mm / 1.77"	40 mm / 1.57"

Main dimensions mm, inches







# RA4 interface relays

## Technical data

### Utilization characteristics according to IEC

Type	RA4
Standards	IEC 60947 5-1
Rated insulation voltage $U_i$ acc. to IEC 60947 5-1	250 V AC 50/60 Hz
Ambient air temperature	
In free air operation	at $U_c = 24$ V DC (between E1 and E2) -25 ... +70 °C
Storage	from 0.85 to 1.1 x $U_c$ -25 ... +60 °C
Storage	-40 ... +70 °C
Climatic withstand	Category B according to IEC 60947-1 Annex Q
Maximum operating altitude	≤3000 m
Mounting positions	Mounting positions 1, 1 ±30°, 2, 3, 4, 5

### Connecting characteristics

Connection capacity (min. ... max.)		
	Rigid solid	1 x 1 ... 2.5 mm <sup>2</sup>
		2 x 1 ... 2.5 mm <sup>2</sup>
	Flexible with non insulated ferrule	1 x 0.75 ... 2.5 mm <sup>2</sup>
		2 x 0.75 ... 2.5 mm <sup>2</sup>
	Flexible with insulated ferrule	1 x 0.75 ... 2.5 mm <sup>2</sup>
		2 x 0.75 ... 1.5 mm <sup>2</sup>
	Lugs	L < 8 mm
Connection capacity acc. to UL/CSA	1 or 2 x	AWG 18 ... 14
Stripping length		10 mm
Tightening torque		1.2 Nm / 11 lb.in
Degree of protection		IP20 protection against direct contact in acc. with EN 50274
acc. to IEC 60947-1 / EN 60947-1 and IEC 60529 / EN 60529		RA4 wired and mounted on the associated contactor
Screw terminals		Delivered in open position
All terminals		M3.5
Screwdriver type		Flat Ø 5.5 / Pozidriv 2

### Working data

Surge suppression		Included inside AF built-in surge protection
For interface relay coil		
Protection against polarity reversal between terminals E1 and E2		Diode
Interface relay operating time		Closing and drop-out ≤10 ms
Total operating time		
interface relay + contactor (1)		
Between energization and:	N.O. contact closing	42 ... 95 ms (AF09 ... AF38, NF) 44 ... 105 ms (AF40 ... AF96)
	N.C. contact opening	40 ... 90 ms (AF09 ... AF38, NF) 40 ... 100 ms (AF40 ... AF96)
Between de-energization and:	N.O. contact opening	15 ... 57 ms (AF09 ... AF38, NF) 21 ... 107 ms (AF40 ... AF96)
	N.C. contact closing	17 ... 60 ms (AF09 ... AF38, NF) 23 ... 112 ms (AF40 ... AF96)

(1) For contactor coils 41, 11, 12, 13.

### Electrical input data

Control voltage (E1 and E2 terminals) $U_c$		
Rated value		24 V DC
Max. range at ambient temperature 20 °C		19 ... 30 V DC
Max. consumption for $U_c = 24$ V DC, $\theta = 20$ °C		0.3 W
"0" status (relay open)	for $U_c$	≤2.4 V DC
	for $I_c$	<1 mA
"1" status (relay closed)	for $U_c$	≥19 V DC
Max. short supply interruption immunity time		2 ms

### Electrical output data

Switching voltage (A0 and A2 terminals)	≤250 V AC
Electrical durability	
Switching frequency	600 cycles/h
Number of operating cycles	2 million operating cycles

# Mechanical latching unit



WA4

The WA4 mechanical latching unit for AF09 ... AF96 contactors and NF contactor relays ensures that the contactor or contactor relay remains switched on even if there is a lack or a failure of voltage. Standard contactors can be easily converted into compact latched contactors.

The WA4 block contains a mechanical latching device with electromagnetic impulse unlatching (AC or DC) or manual unlatching.

### Operation

After closing, the contactor continues to be held in the closed position by the latching mechanism should the supply voltage fail at the contactor coil terminals.

Contactor opening can be controlled:

- electrically by an impulse (AC or DC) on the WA4 block coil (the coil is not designed to be permanently energized)
- manually by pressing the pushbutton on the front face of the WA4 block.

### Mounting

The WA4 block is clipped onto the front face of the 1-stack contactor where it takes up two slots in central position (see fig. below).

The two other slots may accept CA4 single pole auxiliary contacts (1 block on each side of the mechanical latch).

Additional CAL4 can be fitted on the side of the contactor in respect to the total number of built-in or additional N.O. and N.C. auxiliary contacts as described in the accessory fitting details part of each contactor type.

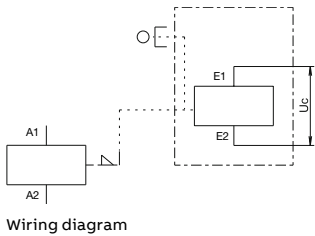

For contactors and contactor relays	Rated control circuit voltage Uc		Type	Order code	Pkg qty	Weight (1 pce) kg
	V AC 50/60 Hz	V DC				
AF09 ... AF65, NF 1-stack	24...60	24...60	WA4-11	1SBN040100R1011	1	0.080
	48...130	48...130	WA4-12	1SBN040100R1012	1	0.080
	100...250	100...250	WA4-13	1SBN040100R1013	1	0.080
	250...500	250...500	WA4-14	1SBN040100R1014	1	0.080
AF80, AF96	24...60	24...60	WA4-96-11	1SBN040200R1011	1	0.080
	48...130	48...130	WA4-96-12	1SBN040200R1012	1	0.080
	100...250	100...250	WA4-96-13	1SBN040200R1013	1	0.080
	250...500	250...500	WA4-96-14	1SBN040200R1014	1	0.080

### Mechanical latching unit for 24 V DC - 500 mA PLC control

AF09 ... AF38, NF 1-stack	-	24	WA4-10	1SBN040100R1010	1	0.080
---------------------------	---	----	--------	-----------------	---	-------

Note: For WA4 accessory use with contactor or contactor relay coil 30, please consult your ABB local sales organization.

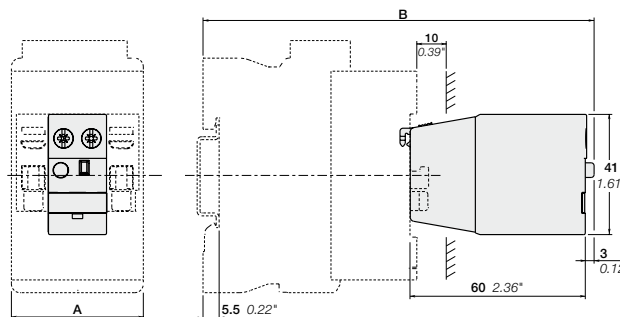

WA4 + AF09 ... AF96, NF 1-stack

Main dimensions mm, inches

For contactors and contactor relays	A mm in.	B mm in.
AF09 ... 16(Z)-30-...	45 1.77"	133.5 5.25"
AF09 ... 16(Z)-40/22-00 NF(Z)		
AF26 ... 38(Z)-30-00	45 1.77"	142.5 5.61"
AF26 ... 38(Z)-40/22-00	45 1.77"	157.5 1.77"
AF40 ... 65-30-00	55 2.16"	167 6.57"
AF40-40/22-00	70 2.75"	170 6.70"
AF52-40-00	70 2.75"	170 6.70"
AF80, 96-30-00	70 2.75"	172 6.77"
AF80-40/22-00	90 3.54"	172 6.77"

1SBC10020450201







# Mechanical latching unit

## Technical data

Types	WA4, WA4-96	WA4
Coil voltage code	11, 12, 13, 14	10
Standards	IEC 60947-4-1	
Rated insulation voltage $U_i$ acc. to IEC 60947-1	690 V AC	
Coil operating limits acc. to IEC 60947-4-1	AC supply	At $\theta \leq 70^\circ\text{C}$ $0.85 \times U_c \text{ min} \dots 1.1 \times U_c \text{ max}$
	DC supply	At $\theta \leq 70^\circ\text{C}$ $0.85 \times U_c \text{ min} \dots 1.1 \times U_c \text{ max}$
Control circuit voltage		
AC control voltage 50/60 Hz		
Rated control circuit voltage $U_c$	24 ... 500 V AC 50/60 Hz	-
Coil consumption	Average pull-in value	15 ... 100 VA
DC control voltage 50/60 Hz		
Rated control circuit voltage $U_c$	24 ... 500 V DC	24 V DC
Coil consumption	Average pull-in value	15 ... 100 W
Max. electrical impulse time		
On AC control supply (with load factor 1.6%)	4 s	-
On DC control supply (with load factor 1.6%)	4 s	-
Min. electrical impulse time		
For latching, energizing of the contactor coil	120 ms	
For unlatching, energizing of the mechanical latching unit coil	50 ms	
Operating time		
On contactor closing (latching) between coil energization and:		
N.O. contact closing	No difference with the operation of a contactor without mechanical latching unit	
N.C. contact opening	No difference with the operation of a contactor without mechanical latching unit	
On contactor opening (unlatching) between mechanical latching unit coil energization and:		
N.O. contact opening	8 ... 15 ms	
N.C. contact closing	10 ... 17 ms	
Ambient air temperature		
Operation	-25 ... +70 °C	
Storage	-60 ... +80 °C	
Climatic withstand	Category B according to IEC 60947-1 Annex Q	
Max. operating altitude	$\leq 3000$ m	
Mounting positions	Mounting positions 1, 1+/- 30°, 2, 3, 4, 5	
Mechanical durability	AF09 ... AF38, NF: 1 million operating cycles AF40 ... AF65: 0.5 million operating cycles AF80, AF96: 0.2 million operating cycles	
Max. switching frequency with on-load factor of 1.6%	cycles/h	600

### Connecting characteristics

Connection capacity (min. ... max.)		
	Rigid solid	1 x 1 ... 2.5 mm <sup>2</sup>
	Flexible with non insulated ferrule	2 x 1 ... 2.5 mm <sup>2</sup>
	Flexible with insulated ferrule	1 x 0.75 ... 2.5 mm <sup>2</sup>
	Flexible with insulated ferrule	2 x 0.75 ... 2.5 mm <sup>2</sup>
	Lugs	L < 8 mm
Connection capacity acc. to UL / CSA	1 or 2 x	AWG 18 ... 14
Stripping length		10 mm
Tightening torque		1.2 Nm / 11 lb.in
Degree of protection acc. to IEC 60947-1 / EN 60947-1 and IEC 60529 / EN 60529		IP20
Screw terminals		Delivered in open position
All terminals		M3.5
Screwdriver type		Flat $\varnothing 5.5$ / Pozidriv 2

## Other accessories

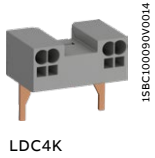

For contactors	Type	Order code	Pkg qty	Weight (1 pce) kg
----------------	------	------------	---------	-------------------

### Additional coil terminal blocks with screw terminal

Additional coil terminal blocks for a bottom access to the coil terminals of contactors or contactor relays.

AF09 ... AF96, NF	LDC4	1SBN070156T1000	10	0.010
-------------------	------	-----------------	----	-------

### Additional coil terminal blocks with Push-in Spring terminal

AF09 ... AF96, NF	LDC4K	1SBN070159T1000	10	0.010
-------------------	-------	-----------------	----	-------

### Protective covers

Sealable and transparent protective covers BX4 and non-removable BX4-CA to protect the devices against accidental contact.

AF09 ... AF96 1-stack contactors and NF contactor relays	BX4	1SBN110108T1000	10	0.006
4-pole CA4, 2-pole CAT4 auxiliary contact blocks and TEF4 electronic timer	BX4-CA	1SBN110109W1000	50	0.001

Note: BX4 produced since 13045 (day 045 - year 2013) are suitable for AF40 ... AF96.

### Function markers AF09 ... AF370

Box of 16 blank cards (16 markers by card) printable on HTP500 thermal transfer printer and AMS 500 marking table to identify your contactors, overload relays or manual motor starters. Marker dimensions: 7 x 20 mm (.276" x .787").

AF09 ... AF370 contactors, TF thermal overload relays, EF electronic overload relays and MS116, MS132 manual motor starters	BA4	1SNA235156R2700	16	0.011
AMS 500 support plate for 8 BA4	SPRC 1	1SNA360010R1500	1	0.220
HTP500 support plate	HTP500-BA4	1SNA235712R2400	1	0.290

### Function markers AF400 ... AF2850

Set of 50 function markers designed to be clipped onto the front face of devices. Details can be added to these markers using a ball point pen, indelible felt-tip pen or pentel white. Self-adhesive labels (not supplied) can also be added to them. Marker dimensions: 7 x 19 mm (.276" x .748").

AF400 ... AF2850 and accessories	BA5-50	1SBN110000R1000	1	0.017
----------------------------------	--------	-----------------	---	-------

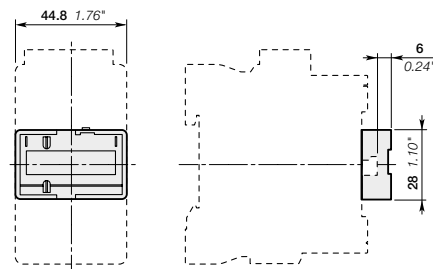

BX4

Main dimensions mm, inches

# Other accessories



BP38-4



BDT4  
For AF09 ... AF65, NF



BDT4  
For AF80 ... AF96

For contactors	Type	Order code	Pkg qty	Weight (1 pce) kg
----------------	------	------------	---------	-------------------

### Mounting pieces

#### Mounting piece for replacing installed contactors fixed by screws by AF contactors.

From contactor	To contactor				
A26 ... A40, AL26 ... AL40	AF09 ... AF38	BP38-4	1SBN112303T1000	10	0.003
A50 ... A75, AE50 ... AE75, AF50 ... AF75	AF40 ... AF65	BP65-4	1SBN113403T1000	10	0.004
A95, A110, AE95, AE110, AF95, AF110	AF80 ... AF96	BP96-4	1SBN113903T1000	10	0.005

### Test block

BDT4 test block is suitable for switching on contactor off-load. Marking on the block indicates the contactor type to fit with.

AF09...AF96 3-pole, NF	BDT4	1SBN110122T1000	10	0.007
------------------------	------	-----------------	----	-------

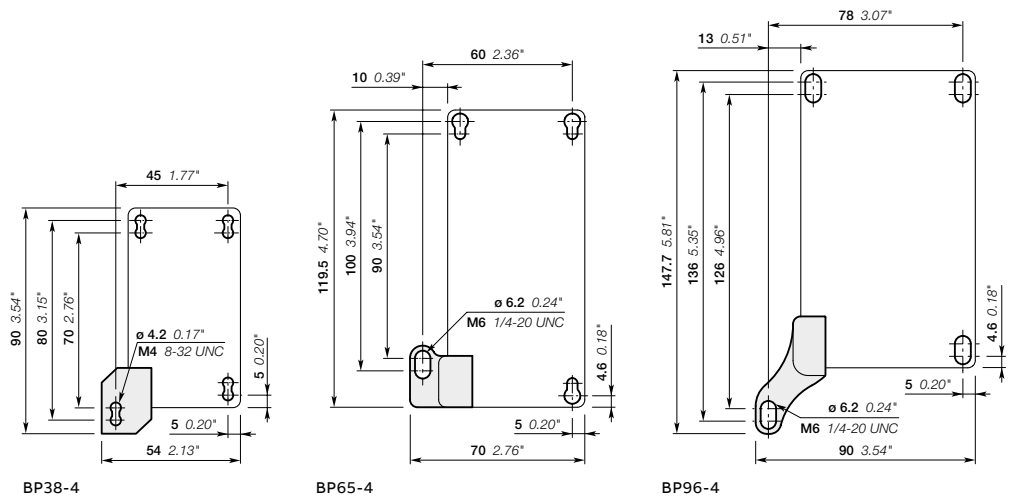

Main dimensions mm, inches

1SBC10175250201 - Rev. A

## Additional terminal blocks







LD38-4

The LD terminal block is designed to increase the connecting capacity of 3-pole AF26 ... AF38 contactors on which it is fitted and for preparation of the wiring before final connection to the contactor. LD38-4 blocks are 3-pole terminal blocks with tunnel terminals.

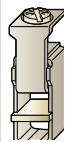
For contactors	Type	Order code	Pkg qty	Weight (1 pce)
AF26 ... AF38	LD38-4	1SBN072308R1000	2	kg 0.070

### Technical data

Types	LD38-4
Rated insulation voltage $U_i$ acc. to IEC 60947-4-1	690 V
acc. to UL / CSA	600 V
Main terminals	 Screw terminals with double connector 2 x (7 width x 5.8/9.2 depth)
Connection capacity (min. ... max.)	
 Rigid Solid ( $\leq 4 \text{ mm}^2$ )	} 1x 2.5...25 mm <sup>2</sup> 1x 2.5...25 mm <sup>2</sup> + 1x 2.5...16mm <sup>2</sup>
 Stranded ( $\geq 6 \text{ mm}^2$ )	
 Flexible with non insulated ferrule	1x 2.5...16 mm <sup>2</sup> 1x 2.5...16mm <sup>2</sup> + 1x 2.5...10mm <sup>2</sup>
 Flexible with insulated ferrule	1x 2.5...16mm <sup>2</sup> 1x 2.5...16mm <sup>2</sup> + 1x 2.5...10mm <sup>2</sup>
Connection capacity acc. to UL / CSA	1x AWG 8-4 2x AWG 8-6
Stripping length	14 mm
Tightening torque	2.5 Nm / 22 lb.in
Degree of protection acc. to IEC 60947-1 / EN 60947-1 and IEC 60529 / EN 60529	IP20
Screw terminals Main terminals	Delivered in closed position, screws of unused terminals must be tightened M5
	Screwdriver type Flat $\varnothing 6.5$ / Pozidriv 2

Note: The utilization of LD38-4 additional terminal blocks does not allow the use of BER and BEY connection sets.

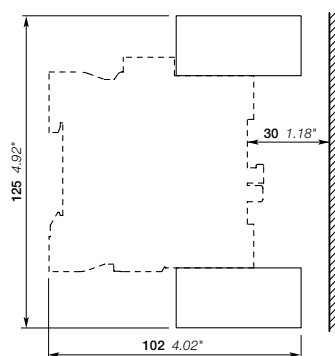

Main dimensions mm, inches

# Terminal shrouds



LT65-30

1SBC100073V0014

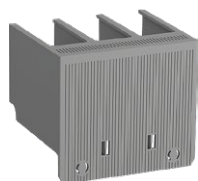

LT140-30L

1SFC101038V0001



LT370-30C

1SFC101041V0001



LT460-AC

1SFC101089V0001



LT80-40

1SBC100073V0014



LT205-40

1SFC101199V0001

Main terminal protection for AF40 ... AF1250 contactors.

The auxiliary contact blocks and coils are designed to provide an IP 20 degree of protection.

The main terminals, equipped with compression lugs or cable clamps, can be protected against accidental direct contact after wiring (EN 50274) by the addition of terminal shrouds (see table below).





For contactors	Type	Order code	Pkg qty	Weight (1 pce) kg
<b>3-pole contactors</b>				
AF40 ... AF65	LT65-30	1SBN123401R1000	1	0.015
AF80, AF96	LT96-30	1SBN123901R1000	1	0.020
AF116 ... AF146, with compression lugs	LT140-30L	1SBN124203R1000	2	0.070
AF190, AF205, with cable clamps	LT205-30C	1SBN124801R1000	2	0.050
AF190, AF205, with compression lugs	LT205-30L	1SBN124803R1000	2	0.220
AF190, AF205, with shorting bar or between contactor and TOL/EOL in DOL starters	LT205-30Y	1SBN124804R1000	1	0.050
AF265 ... AF370, with cable clamps	LT370-30C	1SBN125401R1000	2	0.035
AF265 ... AF370, with compression lugs	LT370-30L	1SBN125403R1000	2	0.280
AF265 ... AF370, with shorting bar or between contactor and TOL/EOL in DOL starters	LT370-30Y	1SBN125404R1000	1	0.075
AF265 ... AF370, for use with extending cable clamps, ATK300/2 and OZXB4	LT370-30D	1SBN125406R1000	1	0.15
AF400, AF460 with cable clamps	LT460-AC	1SBN125701R1000	2	0.100
AF400, AF460 with compression lugs	LT460-AL	1SBN125703R1000	2	0.800
AF580, AF750 with cable clamps	LT750-AC	1SBN126101R1000	2	0.120
AF580, AF1250 with compression lugs	LT750-AL	1SBN126103R1000	2	0.825

### 4-pole contactors

AF40, AF52	LT52-40	1SBN123402R1000	1	0.020
AF80	LT80-40	1SBN123902R1000	1	0.025
AF116 ... AF140, with compression lugs	LT140-40L	1SBN124203R2000	2	0.090
AF190 ... AF205, with cable clamps	LT205-40C	1SBN124801R2000	2	0.035
AF190 ... AF205, with compression lugs	LT205-40L	1SBN124803R2000	2	0.140
AF265 ... AF370, with cable clamps	LT370-40C	1SBN125401R2000	2	0.040
AF265 ... AF370, with compression lugs	LT370-40L	1SBN125403R2000	2	0.165

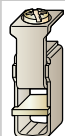
Note: With LT65-30, LT96-30, LT52-40, LT80-40, use rigid cables or flexible cables with insulated ferrules including a stripping length ≥ 18 mm.

### Connecting characteristics with LT ... terminal shrouds

Contactor types	AC / DC operated	AF40 ... 65 + LT65 ...	AF80 ... 96 + LT ...
			
		Screw terminals with double connector 2 x (9.3 width x 7.9/10.3 depth)	Screw terminals with double connector 2 x (12.4 width x 9.3/11.1 depth)
Connection capacity (min. ... max.)			
Main contactor (poles)			
	Rigid solid	1 x 6...16 mm <sup>2</sup> or 25 ...35 mm <sup>2</sup>	6...16 mm <sup>2</sup> or 25 ...70 mm <sup>2</sup>
	Flexible with insulated ferrule	2 x 6...16 mm <sup>2</sup> or 25 ...35 mm <sup>2</sup>	6...16 mm <sup>2</sup> or 35 ... 50 mm <sup>2</sup>
	Bars or Lugs	1 x 4...16 mm <sup>2</sup> or 25 ...35 mm <sup>2</sup>	6...16 mm <sup>2</sup> or 25 ...50 mm <sup>2</sup>
	Bars or Lugs	2 x 4...16 mm <sup>2</sup> or 25 ...35 mm <sup>2</sup>	6...16 mm <sup>2</sup> or 35 ...50 mm <sup>2</sup>
		L < 9.2 mm	12.2 mm
Connection capacity acc. to UL / CSA		1 x AWG 10...6 or AWG 4..2	AWG 6 or AWG 4..1
		2 x AWG 10...6 or AWG 4..2	AWG 6 or AWG 2..1
Stripping length		18 mm	18 mm
Tightening torque			
	Recommended	4 Nm / 35 lb.in	6 Nm / 53 lb.in
Degree of protection acc. to IEC 60947-1 / EN 60947-1 and IEC 60529 / EN 60529		IP20	
Main terminals equipped with LT		IP20	
Screw terminals			
	Main terminals	M6	M8
	Screwdriver type	Flat Ø 6.5 / Pozidriv 2	hexagon socket (s = 4 mm)

## Connections



LW140

1SFC101050V0001



LW205-40

LW205-40



LX140

1SFC101049V0001



LX205-40

1SFC101073V0001



LX370-40



LX460

1SFC101046V0001

### Terminal enlargements

Enlargement pieces designed to increase the width of the contactor terminal pads in order to allow larger connections to be mounted.

For contactors	Dimensions		Type	Order code	Pkg qty	Weight (1 pce) kg
	hole Ø mm	bar mm				

#### 3-pole contactors

AF116 ... AF146	6.5	13 x 3	LW140	1SFN074207R1000	1	0.115
AF190, AF205	10.5	17.5 x 5	LW205	1SFN074807R1000	1	0.260
AF265 ... AF370	10.5	25 x 5	LW370	1SFN075407R1000	1	0.340
AF400, AF460	10.5	25 x 5	LW460	1SFN075707R1000	1	0.730
AF580, AF750	13	40 x 6	LW750	1SFN076107R1000	1	1.230
AF1250	13	50 x 10	LW1250	1SFN076407R1000	1	2.000

#### 4-pole contactors

AF190 ... AF205	10.5	20 x 5	LW205-40	1SFN074807R2000	1	0.306
AF265 ... AF370	10.5	25 x 5	LW370-40	1SFN075407R2000	1	0.540

### Terminal extension

Extension pieces designed to extend the main terminals of contactors for combined mounting of contactors and connection sets.

For 3-pole contactors	Dimensions		Type	Order code	Pkg qty	Weight (1 pce) kg
	hole Ø mm	bar mm				
AF116 ... AF146	6.5	13 x 3	LX140	1SFN074210R1000	1	0.072
AF190, AF205	8.5	17.5 x 5	LX205	1SFN074810R1000	1	0.180
AF265 ... AF370	10.5	20 x 5	LX370	1SFN075410R1000	1	0.234
AF400, AF460	10.5	25 x 5	LX460	1SFN075710R1000	1	0.500
AF580, AF750	13	40 x 6	LX750	1SFN076110R1000	1	0.850

### Connection sockets

Connection socket can be used to replace built-in cable clamps in AF116 ... AF146.

For contactor	Type	Order code	Pkg qty	Weight (1 pce) kg
---------------	------	------------	---------	----------------------

#### 3-pole contactors

AF116 ... AF146	LL146-30	1SFN074211R1000	6	0.102
AF190 ... AF205	LL205-30	1SFN074811R1000	1	0.166
AF265 ... AF370	LL370-30	1SFN075411R1000	1	0.173
AF400 ... AF460	LE460	1SFN075716R1000	6	0.600
AF580 ... AF750	LE750	1SFN076116R1000	6	0.750

#### 4-pole contactors

AF116 ... AF140	LL146-40	1SFN074211R2000	8	0.132
AF190 ... AF205	LL205-40	1SFN074811R2000	2	0.216
AF265 ... AF370	LL370-40	1SFN075411R2000	2	0.224

### Connection module

Connection module can be fixed on AF116 ... AF146 delivered with bar terminals.

For contactor	Type	Order code	Pkg qty	Weight (1 pce) kg
---------------	------	------------	---------	----------------------

#### 3-pole contactors

AF116 ... AF146	LD146-30	1SFN074208R1000	2	0.165
-----------------	----------	-----------------	---	-------

#### 4-pole contactors

AF116 ... AF140	LD146-40	1SFN074208R2000	2	0.225
-----------------	----------	-----------------	---	-------

# Terminal connecting strips and shorting bars



Parallel and series connection of 3-pole contactors:

- To obtain a star point (3 parallel-connected poles)
- To connect poles in parallel and thus increase the AC load passing through the flow path made up of the parallel-connected poles: LP, LY, LH, LF, LG.  
The relevant cable cross-sectional area may limit the maximum permissible current. Consult information in table below
- To connect poles in series and thus increase the DC voltage controlled by the poles: LP, LY (only LY16-4 and LY38-4 secable strips).

Types	for connection of "n" poles	with terminal	insulated
LP	n = 2	no	no (1)
LY	n = 2 (secable LY16-4, LY38-4 connecting strips)	no	yes
	n = 3	no	yes (1)
LH	n = 2	yes	no
LF	n = 3	yes	yes
LG	n = 4	yes	yes

(1) LP460 ... LP750, LY185 ... LY750 not insulated. Use terminal shrouds.



For contactors	max. nominal continuous current with "n" poles				Cable cross-sectional area mm <sup>2</sup>	Type	Order code	Pkg qty	Weight (1 pce) kg
	2 poles	3 poles	4 poles	in series 2 poles					
AF09	30	33	-	25	6	LY16-4	1SBN071303T1000	10	0.006
AF12	32	36	-	27					
AF16	34	40	-	30					
AF26	50	60	-	45	10	LY38-4	1SBN072303T1000	10	0.012
AF116 ... AF146	-	240	-	-	-	LY140	1SFN074203R1000	1	0.055
AF190, AF205	-	400	-	-	-	LY185	1SFN074703R1000	1	0.200
AF265 ... AF370	-	670	-	-	-	LY300	1SFN075103R1000	1	0.300
AF400, AF460	-	1000	-	-	-	LY460	1SFN075703R1000	1	0.450
AF580, AF750	-	1650	-	-	-	LY750	1SFN076103R1000	1	0.800
AF190, AF205	300	-	-	-	-	LP185	1SFN074712R1000	2	0.300
AF265 ... AF370	475	-	-	-	-	LP300	1SFN075112R1000	2	0.400
AF400, AF460	725	-	-	-	-	LP460	1SFN075712R1000	2	0.550
AF580, AF750	1200	-	-	-	-	LP750	1SFN076112R1000	2	0.950
AF09	45	-	-	-	10	LH38-4	1SBN072304R1000	2	0.012
AF12	50	-	-	-	10				
AF16	54	-	-	-	16				
AF26	81	-	-	-	25				
AF30, AF38	90	-	-	-	25				
AF09	-	62	-	-	16	LF16-4	1SBN071305R1000	2	0.020
AF12	-	70	-	-	25				
AF16	-	75	-	-	25				
AF26	-	112	-	-	35	LF38-4	1SBN072305R1000	2	0.040
AF30, AF38	-	125	-	-	50				
AF09	-	-	70	-	25	LG16-4	1SBN071306R1000	2	0.025
AF12	-	-	78	-	25				
AF16	-	-	84	-	25				

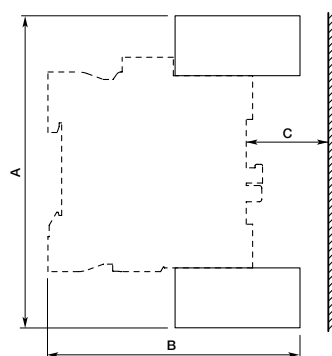

Main dimensions

Type	For contactors	Dimensions					
		A		B		C	
		mm	inch	mm	inch	mm	inch
LH38-4	AF09 ... AF16	111.20	4.38"	83	3.27"	22	0.87"
	AF26 ... AF38	114	4.49"	86	3.39"	16	0.63"
LF16-4	AF09 ... AF16	121	4.76"	87	3.43"	23	0.91"
LF38-4	AF26 ... AF38	135.20	5.32"	103	4.06"	31	1.22"
LG16-4	AF09 ... AF16	124.20	4.89"	87	3.43"	23	0.91"



# Connection accessories for starting solutions

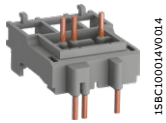

BEA16-4

1SBC100014V0014



BPR65-4

1SBC100078V0014

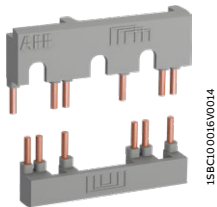

BER16-4

1SBC100016V0014

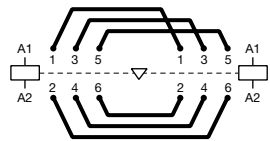

BER, BEM  
Reversing connections



BEP140-30

1SFC10052V0001

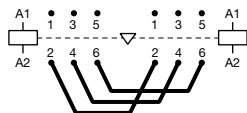

BEP, BES  
3-pole phase to phase connections

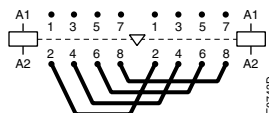

BEP  
4-pole changeover connections

## Connecting links with manual motor starters

The BEA insulated 3-pole connecting links are used to connect AF09 ... AF65 contactors with the MS116 or MS132 or MS165 manual motor starters. The BEA insulated 3-pole connecting links ensure the electrical and mechanical connection between the contactor and the associated manual motor starter. BPR65-4 35 mm rail hooks used with BEA65-4 connecting link, allow direct mounting on 2 rails 35 mm of MS165 manual motor starters with AF40 ... AF65 contactors.

For 3-pole contactors	Manual motor starter	Type	Order code	Pkg qty	Weight (1 pce) kg
AF09 ... AF16	MS116-0.16 ... MS116-25, MS132-0.16... MS132-25	BEA16-4	1SBN081306T1000	10	0.025
AF26 ... AF38	MS116-0.16 ... MS116-16, MS132-0.16 ... MS132-10	BEA26-4	1SBN082306T1000	10	0.025
	MS116-20 ... MS116-32, MS132-12 ... MS132-32	BEA38-4	1SBN082306T2000	10	0.030
AF40 ... AF65	MS165-16 ... MS165-65	BEA65-4	1SBN083406R1000	1	0.090
	MS165-16 ... MS165-65 (1)	BPR65-4 (2)	1SBN113405R1000	1	0.014

Note : BEA not suitable for AF..Z contactors with DC control voltage 24 V DC (coil 30).

(1) Applicable for MS165 manufactured after week 31, 2016 (date code > 16214).

(2) Use one BPR65-4 for each contactor AF40 ... AF65.

## Connection sets for reversing contactors

The BER and BEM connection sets are used to connect the main poles of two 3-pole contactors mounted side by side. The BER connection sets are made up of 1 upstream and 1 downstream connections. The BEM connection sets are made up of 3 upstream and 3 downstream connections. BER and BEM connection sets are insulated and made of solid copper bars.

For 3-pole contactors	Type	Order code	Pkg qty	Weight (1 pce) kg
AF09 ... AF16	BER16-4	1SBN081311R1000	1	0.045
AF26 ... AF38	BER38-4	1SBN082311R1000	1	0.100
AF40 ... AF65	BER65-4	1SBN083411R1000	1	0.175
AF80, AF96	BER96-4	1SBN083911R1000	1	0.250
AF116 ... AF146	BER140-4	1SFN084211R1000	1	0.615
AF190, AF205	BER205-4	1SFN084811R1000	1	1.237
AF265 ... AF370	BER370-4	1SFN085411R1000	1	2.140
AF400, AF460	BEM460-30	1SFN085701R1000	1	4.400
AF580, AF750	BEM750-30	1SFN086101R1000	1	7.300

## Phase to phase connections

The BEP and BES connection sets are used to connect phase to phase the main poles of two contactors mounted side by side. 4-pole contactors will then operate as source reversing contactors. The BEP connection sets are made up of 1 upstream or downstream connections. The BES connection sets are made up of 3 upstream or downstream connections. BEP and BES connection sets are insulated and made of solid copper bars.

For contactors	Type	Order code	Pkg qty	Weight (1 pce) kg
<b>3-pole contactors</b>				
AF116 ... AF146	BEP140-30	1SFN084214R1000	1	0.320
AF190, AF205	BEP205-30	1SFN084814R1000	1	0.534
AF265 ... AF370	BEP370-30	1SFN085414R1000	1	0.926
AF400, AF460	BES460	1SFN085704R1000	1	2.200
AF580, AF750	BES750	1SFN086104R1000	1	3.700
<b>4-pole contactors</b>				
AF116 ... AF140	BEP140-40	1SFN084214R2000	1	0.420
AF190 ... AF205	BEP205-40	1SFN084814R2000	1	0.710
AF265 ... AF370	BEP370-40	1SFN085414R2000	1	1.230

## Connection sets for star-delta starter

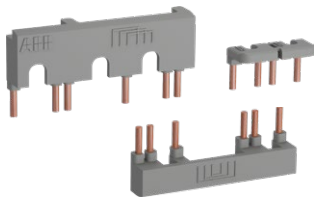

BEY16-4

1SBCC00018V0014

The BEY and BED connection sets are used to connect the main poles of the Line, Delta and Star contactors of a star-delta starter.

The connection sets are made up of:

- Line contactor / delta contactor:
  - BEY: upstream phase-to-phase connection
  - BED: upstream connection in parallel
- Delta contactor / star contactor: downstream connection in parallel
- Star contactor: star point upstream
- Insulated, solid copper bar.

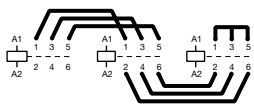

AF09 ... AF370  
Line-delta-star connection

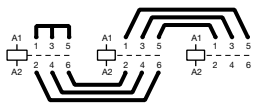

AF400 ... AF750  
Star-delta-line connection

For 3-pole line, delta & star contactors	Interlock unit between delta & star contactors	Type	Order code	Pkg qty	Weight (1 pce) kg
AF09 ... AF16	With or without VM4 or VEM4	BEY16-4	1SBN081313R2000	1	0.050
AF26 ... AF38	With or without VM4 or VEM4	BEY38-4	1SBN082713R2000	1	0.110
AF40 ... AF65	With or without VM96-4	BEY65-4	1SBN083413R2000	1	0.200
AF80, AF96	With or without VM96-4	BEY96-4	1SBN083913R2000	1	0.250
AF116 ... AF146	With or without VM19	BEY140-4	1SFN084413R1000	1	1.040
AF190 ... AF205 (line and delta) AF116 ... AF146 (star)	With or without VM140/190	BEY190-4	1SFN084813R1000	1	1.154
AF190, AF205	With or without VM19	BEY205-4	1SFN085213R1000	1	1.205
AF265 ... AF370 (line and delta) AF190 ... AF205 (star)	With or without VM205/265	BEY265-4	1SFN085413R1000	1	2.020
AF265 ... AF370	With or without VM19	BEY370-4	1SFN085813R1000	1	2.110
AF400 ... AF460	With or without VM750H	BED460	1SFN085703R1000	1	4.700
AF580 ... AF750 (line and delta) AF400 ... AF460 (star)	With or without VM750H	BED580	1SFN085903R1000	1	6.300
AF580 ... AF750	With or without VM750H	BED750	1SFN086103R1000	1	7.700

# Connection accessories for starting solutions- with Push-in Spring terminals

E0

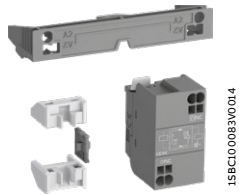

1SBC100083004

VEM4K

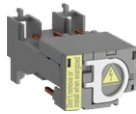
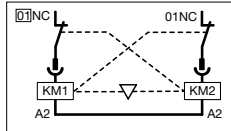

1SBC100084V0014

BEA16-4K

For contactors	Auxiliary contacts	Type	Order code	Pkg qty	Weight (1 pce)
					kg

**Mechanical and electrical interlock set (1)**

AF09..K ... AF16..K	0 2	VEM4K	1SBN030113R1000	1	0.034
AF26..K ... AF38..K					

Note: - VEM4K includes a VM4 mechanical interlock unit with 2 fixing clips (BB4), a VE4K electrical interlock block with A2 - A2 connection.  
 - VE4K block must be used with A2-A2 connection to respect the electrical connection diagram.  
 - VEM4K not suitable for AF..Z contactors with DC control voltage 12 ... 20 V DC (coil 20 and 24 V DC (coil 30)).  
 For product availability, please consult your ABB local sales organization.

**Connecting links with manual motor starters (1)**

AF09..K ... AF16..K	with MS132-0.16K... MS132-25K	BEA16-4K	1SBN081321T1000	10	0.051
AF26..K ... AF38..K	with MS132-0.16K... MS132-32K	BEA38-4K	1SBN082321T2000	10	0.053

(1)For product availability, please consult your ABB local sales organization.  
 Note: BEA not suitable for AF..Z contactors with DC control voltage 24 V DC (coil 30).

1SBC100455S0201

# Connection bars



BEA140/XT2

1SFC10106R0001



BEA205/T4

1SFC10106R0001



BEA370/T5

1SFC10106R0001

Connection between contactors/starters and moulded case circuit breakers. These connection sets are solid copper bars.

For 3-pole contactors	MCCB	Type	Order code	Pkg qty	Weight (1 pce) kg
-----------------------	------	------	------------	---------	-------------------

**Vertical assembly**

AF116 ... AF146	XT2	BEA140/XT2	1SFN084206R1000	1	0.058
AF116 ... AF146	XT3	BEA140/XT3	1SFN084206R1002	1	0.070
AF116 ... AF146	XT4	BEA140/XT4	1SFN084206R1001	1	0.068
AF190, AF205	XT4	BEA205/XT4	1SFN084806R1000	1	0.200
AF190, AF205	T4	BEA205/T4	1SFN084806R1001	1	0.190
AF265 ... AF370	T5	BEA370/T5	1SFN085406R1000	1	0.350
AF400 ... AF750	T6	BEA750/T6	1SFN086106R1000	1	0.410
AF400 ... AF750	T5	BEA750/T5	1SFN086106R1001	1	0.410

**Vertical assembly with control wire terminals**

(also suitable when using busbar kits for starter combinations)

AF400 ... AF750	T5	BEA750D/T5	1SFN086106R1003	1	0.720
AF400 ... AF750	T6	BEA750D/T6	1SFN086106R1002	1	0.720

**Horizontal assembly**

(also suitable when using busbar kits for starter combinations)

AF400, AF460	T4	BEA460H/T4	1SFN085907R1000	1	2.450
--------------	----	------------	-----------------	---	-------

**Connection bars between contactors and switch fuse**

Connection between contactors/starters and moulded case circuit breakers. These connection sets are solid copper bars.

For 3-pole contactors	Switch fuse	Type	Order code	Pkg qty	Weight (1 pce) kg
-----------------------	-------------	------	------------	---------	-------------------

**Vertical assembly**

AF400, AF460	OESA400	BEF460/OESA400	1SFN085708R1000	1	0.340
AF460 ... AF750	OESA630 to OESA800	BEF750/OESA800	1SFN086108R1000	1	0.740

**Horizontal assembly**

AF400, AF460	OESA400...LR	OESA460H/OESA400	1SFN085709R1000	1	1.250
--------------	--------------	------------------	-----------------	---	-------

Note: The BEF connection bars provided for the A145 ... A300 contactors can be used for the AF145 ... AF300 contactors.

03

1SFC10103C0201 Rev. B

## Mounting plates



PN460

Mounting plates with fixing holes for the specified 3-pole contactors and overload relays.

For 3-pole contactors		For overload relays	Type	Order code	Pkg qty	Weight (1 pce) kg
-----------------------	--	---------------------	------	------------	---------	-------------------

### Mounting plates for Direct on line starters

AF400, AF460		E500DU	PN460-11	1SFN095705R1000	1	2.120
AF580, AF750		E800DU	PN750-11	1SFN096105R1000	1	2.500

For two contactors side by side with space for mechanical interlock		For one or two overload relays	Type	Order code	Pkg qty	Weight (1 pce) kg
---	--	--------------------------------	------	------------	---------	-------------------

### Mounting plates for mechanical interlocked contactors, reversing starters and two speed starters for double windings

AF400, AF460		E500DU	PN460-21	1SFN095701R1000	1	3.490
AF580, AF750		E800DU	PN750-21	1SFN096101R1000	1	4.230

For main and delta contactors	For star contactor (1)	For overload relays	Type	Order code	Pkg qty	Weight (1 pce) kg
-------------------------------	------------------------	---------------------	------	------------	---------	-------------------

### Mounting plates for star-delta starters and two speed starters for single windings

AF400, AF460	A300, AF400	E500DU	PN460-41	1SFN095703R1000	1	5.310
AF580, AF750	AF400 ... AF580	E800DU	PN750-41	1SFN096103R1000	1	6.320

(1) Space for mechanical interlock included.

# Adapter plates

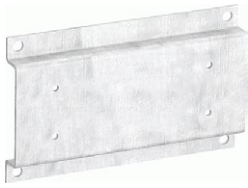

PR146-1

1SFC101048V0001

Adapter plates with fixing holes for replacing installed contactors.

From contactors	To contactor	Type	Order code	Pkg qty	Weight (1 pce) kg
A95, AF95, A110, AF110	AF116, AF140, AF146	PR146-1	1SFN094200R1000	1	0.300
EH150, EH160, EH175, EH210, EG160	AF190, AF205	PR210-1	1SFN094900R1000	1	0.440
EH250, EH260, EH300	AF265, AF305, AF370	PR300-1	1SFN095300R1000	1	0.560
EH370, EH550, EG315	AF400, AF460, AF580	PR460-1	1SFN095700R1000	1	0.900
EH700, EH800	AF750	PR750-1	1SFN096100R1000	1	0.500
OKYM150, OKYM175	AF190	PR185-2	1SFN095100R1001	1	0.500
OKYM200, OKYM250	AF265, AF305, AF370	PR300-2	1SFN095300R1001	1	0.500
OKYM315	AF400, AF460	PR400-2	1SFN095700R1002	1	0.820
OKYM400	AF400, AF460	PR460-2	1SFN095700R1001	1	0.800
OKYM500	AF580	PR580-2	1SFN096100R1002	1	0.700
EH550, EG630, OKYM630	AF580, AF750	PR750-2	1SFN096100R1001	1	1.100

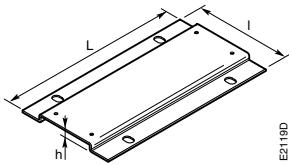

EZ118D

## Dimensions (mm)

Type of the plate	Dimensions			Fixing holes mm
	L	l	h	
PR146-1	150	90	15	4 x Ø 6.5
PR210-1	200	132	11.5	4 x Ø 7
PR300-1	200	172	11.5	4 x Ø 7
PR460-1	278	198	11.5	4 x Ø 7
PR750-1	283	244	11.5	4 x Ø 7
PR185-2	202	152	11.2	4 x Ø 11
PR300-2	202	152	11.2	4 x Ø 11
PR400-2	278	151	11.5	4 x Ø 11
PR460-2	278	176	11.5	4 x Ø 11
PR580-2	283	176	11.5	4 x Ø 11
PR750-2	283	255	11.5	4 x Ø 14

Fixing holes according to the plate types

# Low Voltage Ride Through (LVRT) modules



RU19/120

1SFC101223V0001

RU19 is designed to meet the Low Voltage Ride Through (LVRT) requirements for grid connections by staying operational during voltage dips preventing disturbances on the grid it self.

The RU19 is a separate module connected to the contactors coil connection A1-A2 creating a delay function of the opening of the contactor. When controlled by PLC, the contactor is operated directly without delay functionality. The RU19 can be screw or DIN rail mounted.

For contactor	Rated control circuit voltage Uc V 50/60 Hz	Type	Order code	Weight Pkg (1 pce) kg
AF116 ... AF370 use coil 33 AF400 ... AF1250 use coil 69	110...120	RU19/120	1SFN170801R1001	0.400
AF116 ... AF370 use coil 33 AF400 ... AF1250 use coil 70	230...240	RU19/240	1SFN170801R1002	0.400

AF116 ... AF1250

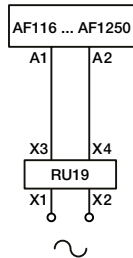

For direct opening of AF400 ... AF1250 contactors, connect through built in PLC interface.

Control inputs

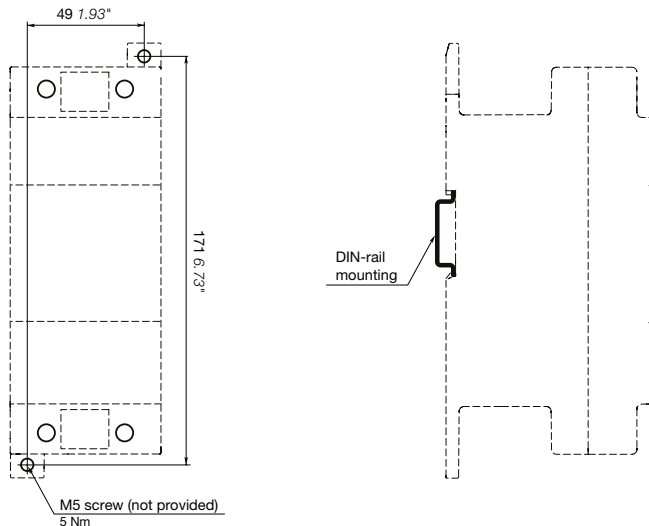
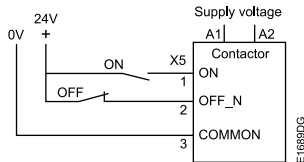

RU19/240

Main dimensions mm, inches

1SFC101077D0201



# Contactor coils, main contact sets and arc chutes



ZAF1650

1SFC0000700201

## Contactor coils

For contactors	Rated control circuit voltage Uc min. ... Uc max.		Type	Order code	Pkg qty	Weight (1 pce) kg
	V 50/60 Hz	V DC				
AF400, AF460	-	24...60	ZAF460	1SFN155770R6806	1	0.525
	48...130	48...130	ZAF460	1SFN155770R6906	1	0.525
	100...250	100...250	ZAF460	1SFN155770R7006	1	0.525
	250...500	250...500	ZAF460	1SFN155770R7106	1	0.525
AF580 ... AF1250	-	24...60	ZAF750	1SFN156170R6806	1	1.335
	48...130	48...130	ZAF750	1SFN156170R6906	1	1.335
	100...250	100...250	ZAF750	1SFN156170R7006	1	1.335
	250...500	250...500	ZAF750	1SFN156170R7106	1	1.335
AF1350 ... AF2050	100...250	100...250	ZAF1650 (1)	1SFN156570R7026	1 set	0.900
			ZP1650 (2)	1SFN166521R1070	1	0.300
AF2650	100...250	100...250	ZAF2650 (1)	1SFN156670R7026	1 set	0.900
			ZP2650 (2)	1SFN166621R1070	1	0.300

ZAF460, ZAF750 : printed circuit board included.

- (1) One set of two coil.
- (2) Printed circuit board.

## Main contact sets

The contact sets for 3-pole contactors consists of six fixed contacts, three moving contacts, springs and the required screws.

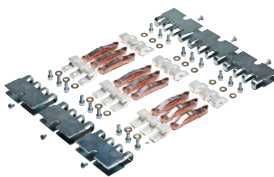

ZL1650

1SFC0000900201

For 3-pole contactors	Type	Order code	Pkg qty	Weight (1 pce) kg	
AF400	ZL400	1SFN165703R1000	1	1.320	
AF460	ZL460	1SFN165903R1000	1	1.320	
AF580	ZL580	1SFN166103R1000	1	1.840	
AF750	ZL750	1SFN166303R1000	1	1.840	
AF1250	ZL1250	1SFN166403R1000	1	1.840	
AF1350	For contactors produced before 2014-01-13, with serial number before 1S16010051403xxxx For contactors produced since 2014-01-13, with serial number above 1S16010051403xxxx	ZL1350	1SFN166503R1000	1	2 500
		ZL1350-1	1SFN166503R1001	1	4 500
AF1650	For contactors produced before 2014-01-13, with serial number before 1S16010051403xxxx For contactors produced since 2014-01-13, with serial number above 1S16010051403xxxx	ZL1650	1SFN166703R1000	1	3 500
		ZL1650-1	1SFN166703R1001	1	4 500
AF2050	For contactors produced before 2014-01-13, with serial number before 1S16010051403xxxx For contactors produced since 2014-01-13, with serial number above 1S16010051403xxxx	ZL2050	1SFN167003R1000	1	3 500
		ZL2050-1	1SFN167003R1001	1	4 500
AF2650 (3)	ZL2650	1SFN166603R1000	1	1.200	

(3) Does not include fixed contacts and screws.

## Arc chutes

For contactors	Type	Order code	Pkg qty	Weight (1 pce) kg
AF400, AF460	ZW460	1SFN165710R1000	1	1.380
AF580, AF750, AF1250	ZW750	1SFN166110R1000	1	1.500
AF1350, AF1650, AF2050	ZW1650	1SFN166510R1001	1	4.560
AF2650	ZW2650	1SFN166610R1000	1	4.000

03

1SFC001037C0201 - Rev. D



---

# Accessories for UA, UA..RA contactors and GA75, GAE75, GAF contactors

<b>3/272</b>	Auxiliary contact blocks
<b>3/278</b>	Electronic timers
<b>3/282</b>	Mechanical and electrical interlock units
<b>3/284</b>	CA5, CE5, CAL, CEL18 and TEF5 fitting details
<b>3/285</b>	Function markers - Mounting piece
<b>3/286</b>	Surge suppressors for contactor coils
<b>3/288</b>	Interface relays
<b>3/290</b>	Mechanical latching units
<b>3/292</b>	Additional terminal blocks and others accessories
<b>3/293</b>	Terminals for control lead connections
<b>3/294</b>	Connection bar for contactors
<b>3/295</b>	Contactors coils and main contact sets
<b>3/404</b>	<b>Voltage code table</b>



For direct product details information, use product type or order code, ex:

- [www.abb.com/productdetails/AF09-30-10-13](http://www.abb.com/productdetails/AF09-30-10-13)
- or [www.abb.com/productdetails/1SBL137001R1310](http://www.abb.com/productdetails/1SBL137001R1310)

# Auxiliary contact blocks



CA5-10



CA5-40E



CAL5-11



CAL18-11

The auxiliary contact blocks are used for the operation of auxiliary circuits and control circuits for standard industrial environments.

Types of auxiliary contact blocks for front mounting:

- CA5 1 or 4-pole block, instantaneous with N.O., N.C. contacts
- CC5 1-pole block, with N.O. leading contact or N.C. lagging contact.

Select the 4-pole auxiliary contact blocks CA5 type, according to the contactor type for compliance with the standard requirements (see "Terminal Marking and Positioning").

Types of auxiliary contact blocks for side mounting:

- CAL 2-pole block instantaneous N.O. + N.C. contacts.

For clipping onto the right- and/or left-hand side of the contactors.

The auxiliary contact blocks are equipped with screw type connecting terminals delivered open, protected against accidental direct contact and bear the corresponding function marking.

For contactors	Auxiliary contacts	Type	Order code	Pkg qty	Weight (1 pce)
					kg

### Front-mounted instantaneous auxiliary contact blocks, 1-pole

UA16 ... UA110	1 0	--	CA5-10	1SBN010010R1010	10	0.014
	0 1	--	CA5-01	1SBN010010R1001	10	0.014
	--	1 0	CC5-10	1SBN010011R1010	10	0.014
	--	0 1	CC5-01	1SBN010011R1001	10	0.014

### Front-mounted instantaneous auxiliary contact blocks, 4-pole

UA16 ... UA30	2 2	--	CA5-22M	1SBN010040R1122	2	0.060
	3 1	--	CA5-31M	1SBN010040R1131	2	0.060
	1 3	--	CA5-13M	1SBN010040R1113	2	0.060
	0 4	--	CA5-04M	1SBN010040R1104	2	0.060
	1 1	1 1	CA5-11/11M	1SBN010040R1118	2	0.060
UA50 ... UA110	2 2	--	CA5-22E	1SBN010040R1022	2	0.060
	3 1	--	CA5-31E	1SBN010040R1031	2	0.060
	4 0	--	CA5-40E	1SBN010040R1040	2	0.060
	0 4	--	CA5-04E	1SBN010040R1004	2	0.060
	1 1	1 1	CA5-11/11E	1SBN010040R1018	2	0.060

### Side-mounted instantaneous auxiliary contact blocks, 2-pole

UA16 ... UA75	1 1	--	CAL5-11	1SBN010020R1011	2	0.050
UA95, UA110, GAF185...GAF2050	1 1	--	CAL18-11	1SBN010720R1011	2	0.050

For each contactor type, refer to "Accessory fitting details" table.

Note:

- The front-mounted auxiliary contact blocks provided for the UA75 contactors can be used with the GA and GAE types
- The CAL auxiliary contact blocks can be used with GA contactors:
  - GA75-10-00: 2 x CAL5-11 blocks
  - GA75-10-11: 1 x CAL5-11 block
  - GAE75-10-00: 1 x CAL5-11 block
  - GAE75-10-11: no add-on block.
- The CAL auxiliary contact blocks can be used with UA..RA contactors. See "Accessory fitting details" for this contactor type.



# Auxiliary contact blocks

## Technical data

	<b>Front mounted</b>	<b>Side mounted</b>	
Types	<b>1-pole CA5, 1-pole CC5, 4-pole CA5</b>	<b>CAL5-11</b>	<b>CAL18-11, CAL18-11B</b>



### Contact utilization characteristics according to IEC

Standards	IEC 60947-5-1 and EN 60947-5-1			
Rated insulation voltage $U_i$ acc. to IEC 60947-5-1	690 V			
Rated operational voltage $U_e$ max.	24...690 V AC			
Conventional thermal current $I_{th}$ - $\theta \leq 40^\circ\text{C}$	16 A			
$I_e$ / Rated operational current AC-15 acc. to IEC 60947-5-1	24-127 V 50/60 Hz	6 A		
	220-240 V 50/60 Hz	4 A		
	380-440 V 50/60 Hz	3 A		
	500-690 V 50/60 Hz	2 A		
Making capacity acc. to IEC 60947-5-1	10 x $I_e$ AC-15			
Breaking capacity acc. to IEC 60947-5-1	10 x $I_e$ AC-15			
$I_e$ / Rated operational current DC-13 acc. to IEC 60947-5-1	24 V DC	6 A / 144 W		
	48 V DC	2.8 A / 134 W		
	72 V DC	1 A / 72 W		
	110 V DC	0.55 A / 60 W		
	125 V DC	0.55 A / 69 W		
	220 V DC	0.3 A / 66 W		
	250 V DC	0.3 A / 75 W		
Short-circuit protection device gG type fuse	10 A			
Rated short-time withstand current $I_{cw}$ $\theta = 40^\circ\text{C}$	for 1.0 s	100 A		
	for 0.1 s	140 A		
Minimum switching capacity	A40 ... A75 contactors	17 V / 1 mA		
	with failure rate acc. to IEC 60947-5-4	$\leq 10^{-7}$		
	A95 ... A110 contactors	24 V / 50 mA	-	24 V / 50 mA (0.5 million of operating cycles)
	with failure rate acc. to IEC 60947-5-4	-	-	$\leq 10^{-6}$
Power dissipation per pole at 6 A	0.1 W			
Mechanical durability Number of operating cycles	10 millions (UA16 ... UA75)	10 millions	5 millions (UA95 ... UA110)	
	3 millions (UA95 ... UA110)		3 millions (GAF185 ... GAF750)	
			0.5 million (GAF1250 ... GAF2050)	
Max. switching frequency	3600 cycles/h			
Electrical durability	Number of operating cycles	see "Electrical durability" curves		
	Max. switching frequency	AC-15	1200 cycles/h	
		DC-13	900 cycles/h	

### Contact utilization characteristics according to UL / CSA

Standards	UL 508, CSA C22.2 N°14
Max. operational voltage	600 V AC, 250 V DC
Pilot duty	A600, Q300
AC thermal rated current	10 A

### Connecting characteristics

Connection capacity (min. ... max.)				
	Rigid solid	1 x	1...4 mm <sup>2</sup>	
		2 x	1...4 mm <sup>2</sup>	
	Flexible with ferrule	1 x	0.75...2.5 mm <sup>2</sup>	
		2 x	0.75...2.5 mm <sup>2</sup>	
	Lugs	$L \leq$	7.7 mm	8 mm
		$L >$	3.7 mm	3.7 mm
Tightening torque	1 Nm			
Degree of protection	Terminals	IP20		
acc. to IEC 60947-1 / EN 60947-1 and IEC 60529 / EN 60529				
Screw terminals	Delivered in open position, screws of unused terminals must be tightened			
All terminals	M3.5			
Screwdriver type	Flat Ø 5.5 / Pozidriv 2			

## Auxiliary contact blocks for severe industrial environments



CE5-01W

The auxiliary contact blocks are used for the operation of auxiliary and control circuits for severe industrial environments.

Types of auxiliary contact blocks for front mounting:

- CE5 1-pole block, instantaneous with N.O. contact or N.C. contact, designed in 2 protection versions:
  - CE5-.. D with built-in microswitch IP40, degree of protection (IP20 on terminals)
  - CE5-.. W with built-in microswitch IP67, degree of protection (IP20 on terminals).

Types of auxiliary contact blocks for side mounting:

- CEL18 1-pole block with built-in microswitch IP67 degree of protection (IP20 on terminals). Instantaneous N.O. or N.C. contact.

For clipping onto the right- and/or left-hand side of the contactors.

The auxiliary contact blocks are equipped with screw type connecting terminals delivered open, protected against accidental direct contact and bear the corresponding function marking.

For contactors	Auxiliary contacts	Type	Order code	Pkg qty	Weight (1 pce)
					kg

### Front-mounting instantaneous auxiliary contact blocks, 1-pole

For contactors	NO	NC	Type	Order code	Pkg qty	Weight (1 pce)	
UA16 ... UA75	1	-	-	CE5-10D0.1	1SBN010015R1010	1	0.020
	-	1	-	CE5-01D0.1	1SBN010015R1001	1	0.020
	1	-	-	CE5-10D2	1SBN010017R1010	1	0.020
	-	1	-	CE5-01D2	1SBN010017R1001	1	0.020
	1	-	-	CE5-10W0.1	1SBN010016R1010	1	0.020
	-	1	-	CE5-01W0.1	1SBN010016R1001	1	0.020
	1	-	-	CE5-10W2	1SBN010018R1010	1	0.020
	-	1	-	CE5-01W2	1SBN010018R1001	1	0.020

### Side-mounting instantaneous auxiliary contact blocks, 1-pole microswitch auxiliary contact N.O. or N.C.

For contactors	NO	NC	Type	Order code	Pkg qty	Weight (1 pce)	
UA95, UA110 GAF185 ... GAF2050	1	0	-	CEL18-10	1SFN010716R1010	1	0.050
UA95, UA110 GAF185 ... GAF2050	0	1	-	CEL18-01	1SFN010716R1001	1	0.050

For each contactor type, refer to "Accessory fitting details" table.

Note: The front-mounted auxiliary contact blocks provided for the UA contactors can be used with the GA and GAE types. The side-mounted auxiliary contact blocks provided for the UA95, UA110 contactors can be used with the GAF types.

# Auxiliary contact blocks

## Technical data

Types	Front-mounted		Side-mounted
	1-pole CE5-..0.1	1-pole CE5-..2	CEL18-10, CEL18-01



### Contact utilization characteristics according to IEC

Standards	IEC 60947-5-1 and EN 60947-5-1		
Rated insulation voltage $U_i$ acc. to IEC 60947-5-1	250 V		
Rated operational voltage $U_e$ max.	125 V	250 V	125 V
Conventional thermal current $I_{th} - \theta \leq 40^\circ C$	0.1 A	2 A	0.1 A
$I_e$ / Rated operational current acc. to IEC 60947-5-1	<b>AC-14</b>	<b>AC-15</b>	<b>AC-14</b>
	24-127 V 50/60 Hz	2 A	0.1 A
	220-240 V 50/60 Hz	2 A	-
Making capacity acc. to IEC 60947-5-1	6 x $I_e$ AC-14	10 x $I_e$ AC-15	6 x $I_e$ AC-14
Breaking capacity acc. to IEC 60947-5-1	6 x $I_e$ AC-14	10 x $I_e$ AC-15	6 x $I_e$ AC-14
$I_e$ / Rated operational current acc. to IEC 60947-5-1	<b>DC-12</b>		
	24 V DC	0.1 A	0.1 A
	48 V DC	0.1 A	0.1 A
	72 V DC	0.1 A	0.1 A
	110 V DC	0.1 A	0.1 A
	125 V DC	-	-
	220 V DC	-	-
Short-circuit protection device	0.1 A (FF type fuses) (1)	10 A (FF type fuses) (1)	0.1 A (FF type fuses) (1)
Minimum switching capacity	A40 ... A75 contactors	3 V / 1 mA	3 V / 1 mA
	With failure rate acc. to IEC 60947-5-4	-	-
	A95 ... A110 contactors	3 V / 1 mA	-
	With failure rate acc. to IEC 60947-5-4	-	-
Mechanical durability	Number of operating cycles	5 millions for CE5-..D0.1 2.5 millions for CE5-..W0.1	5 millions for CE5-..D2 2.5 millions for CE5-..W2
	Max. switching frequency	3600 cycles/h	1200 cycles/h
	Number of operating cycles	2.5 millions for CE5-..D0.1 0.7 millions for CE5-..W0.1	1 million for CE5-..D2 0.3 millions for CE5-..W2
Electrical durability	Number of operating cycles	2.5 millions for CE5-..D0.1 0.7 millions for CE5-..W0.1	1 million for CE5-..D2 0.3 millions for CE5-..W2
	Max. switching frequency	AC-14, AC-15	1200 cycles/h
		DC-12	900 cycles/h

### Contact utilization characteristics according to UL / CSA

Standards	UL 508, CSA C22.2 N°14		
Max. operational voltage	125 V AC / 110 V DC	250 V AC / 220 V DC	125 V
Pilot duty	AC thermal rated current		0.1 A
	0.1 A	2 A	0.1 A

### Connecting characteristics

Connection capacity (min. ... max.)			
	Rigid solid	1 x	1...4 mm <sup>2</sup>
		2 x	1...4 mm <sup>2</sup>
	Flexible with ferrule	1 x	0.75...2.5 mm <sup>2</sup>
		2 x	0.75...2.5 mm <sup>2</sup>
	Bars or lugs	$L \leq$	7.7 mm
		$l >$	3.7 mm
Connection capacity acc. to UL/CSA	1 or 2 x	AWG 18...14	
Tightening torque		1 Nm	
Degree of protection acc. to IEC 60947-1 / EN 60947-1 and IEC 60529 / EN 60529	Terminals	IP20	
	Microswitches	IP40 for CE5-..D0.1	IP40 for CE5-..D2
		IP67 for CE5-..W0.1	IP67 for CE5-..W2
Screw terminals	Delivered in open position, screws of unused terminals must be tightened		
All terminals	M3.5		
Screwdriver type	Flat Ø 5.5 / Pozidriv 2		

(1) or HRC fuses for very fast action (6.3 x 32 mm size).



## Auxiliary contacts

### Electrical durability

#### Electrical durability for AC-15 utilization category

AC-15 utilization category according to IEC 60947-5-1 / EN 60947-5-1:

- making current:  $10 \times I_e$  with  $\cos \phi = 0.7$  and  $U_e$
- breaking current:  $I_e$  with  $\cos \phi = 0.4$  and  $U_e$ .

These curves represent the electrical durability of the built-in or add-on auxiliary contacts, in relation to the breaking current. The curves have been drawn for resistive and inductive loads up to 690 V, 40...60 Hz.

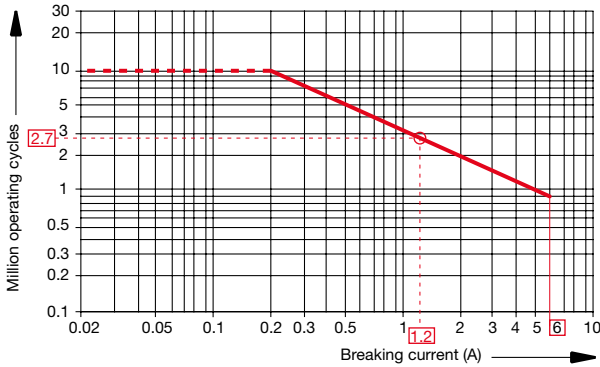

- 1-pole and 4-pole CA5,  
1-pole CC5,  
2-pole CAL5 and CAL18 add-on auxiliary contacts.

Example:

Breaking current = 1.2 A

On the opposite curve at intersection "O" 1.2 A the corresponding value for the electrical durability is approximately 2.7.10<sup>6</sup> operating cycles.

#### Electrical durability for DC-13 utilization category

DC-13 utilization category according to IEC 60947-5-1 / EN 60947-5-1: making and breaking current =  $I_e$  with  $U_e$  value.

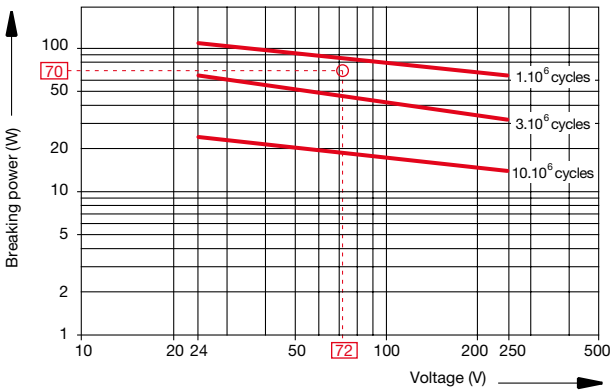

- 1-pole and 4-pole CA5,  
1-pole CC5,  
2-pole CAL5 and CAL18 add-on auxiliary contacts.

Example:

Control of DC electro-magnet:  $U_e$  voltage = 72 V DC and breaking power = 70 W.

On the opposite curve at intersection "O" 72 V / 70 W the corresponding value for the electrical durability is approximately 2.10<sup>6</sup> operating cycles.

# Add-on auxiliary contacts

## Terminal marking and positioning

### 1-pole auxiliary contacts

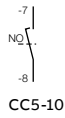
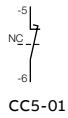
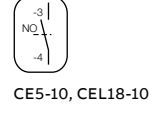
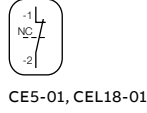
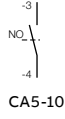
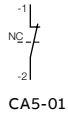

### 2-pole auxiliary contacts

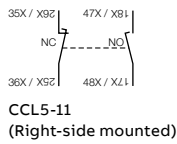
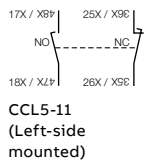
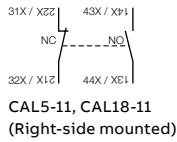
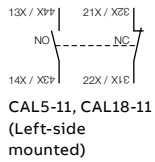

### 4-pole auxiliary contacts

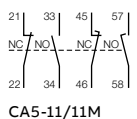
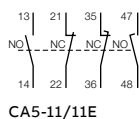
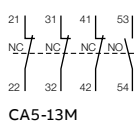
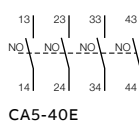
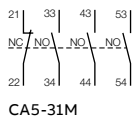
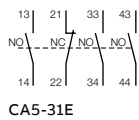
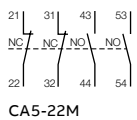
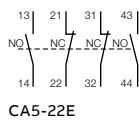
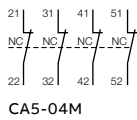
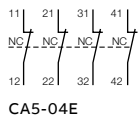

## Electronic timers



TEF5-OFF

1SBC101396F004

TEF5 frontal electronic timers are used for realizing timing function and are available in ON-delay and OFF-delay versions.

Compact solution in cabinet compared to separate timers

TEF5 electronic timers are front-mounted and locked on contactors.

A mechanical indicator allows to show the state of the contactor.

TEF5 electronic timers are supplied by direct wiring to the coil terminals A1 - A2 of the contactor or contactor relay. A varistor is integrated on the timer to offer a built-in protection against surges in the contactor coil.

Available for a wide control voltage range 24...240 V AC/DC

TEF5-ON or TEF5-OFF allow time-delayed functions up to 100 s in 3 distinct time ranges, independently of the control system. The time delay ranges are selected by a switch and the time delay can be adjusted by means of a rotary switch. The timing function is activated by closing or opening the device on which the timer is mounted. The OFF-delay version operates without additional control supply.

For contactors, contactor relays	Time delay range selected by switch	Delay type	Rated control circuit voltage U <sub>c</sub>	Auxiliary contacts	Type	Order code	Weight
			V 50/60 Hz or DC				Pkg (1 pce) kg
UA16 ... UA75	0.1...1 s	ON-delay	24...240	1 1	TEF5-ON	1SBN020312R1000	0.065
GA75, GAE75	1...10 s 10...100 s	OFF-delay	24...240	1 1	TEF5-OFF	1SBN020314R1000	0.065

# Electronic timers

## Technical data





### Contact utilization characteristics according to IEC

Types	TEF5-ON	TEF5-OFF
Standards	IEC 60947-5-1 and EN 60947-5-1	
Rated insulation voltage $U_i$ acc. to IEC 60947-5-1	400 V	
Rated impulse withstand voltage $U_{imp}$	4 kV	
Rated operational voltage $U_e$ max.	240 V	
Rated frequency (without derating)	50 / 60 Hz	
Conventional thermal current $I_{th} - \theta \leq 40^\circ C$	5 A	
$I_e$ / Rated operational current AC-15 acc. to IEC 60947-5-1	24-127 V 50/60 Hz 220-240 V 50/60 Hz	3 A 1.5 A
Making capacity	10 x $I_e$ AC-15 acc. to IEC 60947-5-1	
Breaking capacity	10 x $I_e$ AC-15 acc. to IEC 60947-5-1	
$I_e$ / Rated operational current DC-13 acc. to IEC 60947-5-1	24 V DC	1 A / 24 W
Short-circuit protection device gG type fuse	6 A	
Rated short-time withstand current $I_{cw}$ $\theta = 40^\circ C$	for 1.0 s for 0.1 s	8 A 8 A
Minimum switching capacity with failure rate acc. to IEC 60947-5-4	24 V DC	12 V / 3 mA 10-7
Power dissipation per pole at 3 A	0.1 W	
Function diagram	<p>ON-delay</p>	<p>OFF-delay</p>
<p>Bistable relay inside. Before use, once apply <math>U_c</math> then switch it off in order to initialize position of the contacts.</p>		
Control circuit voltage		
AC control voltage 50/60 Hz	Rated control circuit voltage $U_c$ Average consumption	24...240 V AC 1.5 mA RMS
DC control voltage	Rated control circuit voltage $U_c$ Average consumption	24...240 V DC 1.5 mA
Rated frequency limits	50 / 60 Hz	
Supply voltage range	0.85...1.1 x $U_c$ (at $\theta \leq 70^\circ C$ )	
Overvoltage protection	Varistor included	
Time delay range (t) selected by switch	0.1...1 s 1...10 s 10...100 s	<input type="checkbox"/> <input type="checkbox"/> <input type="checkbox"/>
On-load reiteration accuracy under constant conditions	$\leq 1\%$	
Minimum ON period	0.1 s	1 s
Recovery time	0.15 s	0.1 s
Ambient air temperature	Operation Storage	-25 $^\circ C$ ... +70 $^\circ C$ -40 $^\circ C$ ... +80 $^\circ C$
Climatic withstand	Category B according to IEC 60947-1 Annex Q	
Maximum operating altitude	2000 m	
Mounting positions	Acc. to mounting positions permitted on contactors or contactor relays	
Shock withstand acc. to IEC 60068-2-27 and EN 60068-2-27 (Mounting position 1)	1/2 sinusoidal shock for 11 ms; no change in contact position Same as contactor or contactor relay	
Mechanical durability	Number of operating cycles Max. switching frequency	5 millions operating cycles 3600 cycles/h
Max. electrical switching frequency	AC-15 DC-13	1200 cycles/h 900 cycles/h

# Electronic timers

## Technical data

### Connecting characteristics

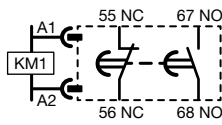
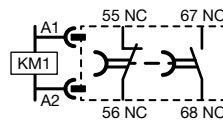
Connection capacity (min. ... max.)	
 Rigid solid	1 x 1...2.5 mm <sup>2</sup> 2 x 1...2.5 mm <sup>2</sup>
 Flexible with non insulated ferrule	1 x 0.75...2.5 mm <sup>2</sup> 2 x 0.75...2.5 mm <sup>2</sup>
 Flexible with insulated ferrule	1 x 0.75...2.5 mm <sup>2</sup> 2 x 0.75...1.5 mm <sup>2</sup>
 Lugs	L ≤ 8 mm l > 3.7 mm
Stripping length	10 mm
Tightening torque	1 N.m / 9 lb.in
Degree of protection acc. to IEC 60947-1 / EN 60947-1 and IEC 60529 / EN 60529	IP20
Screw terminals All terminals	Delivered in open position, screws of unused terminals should be tightened M3.5
Screwdriver type	Flat Ø 5.5 / Pozidriv 2
Terminal Marking	 

—  
**Notes**

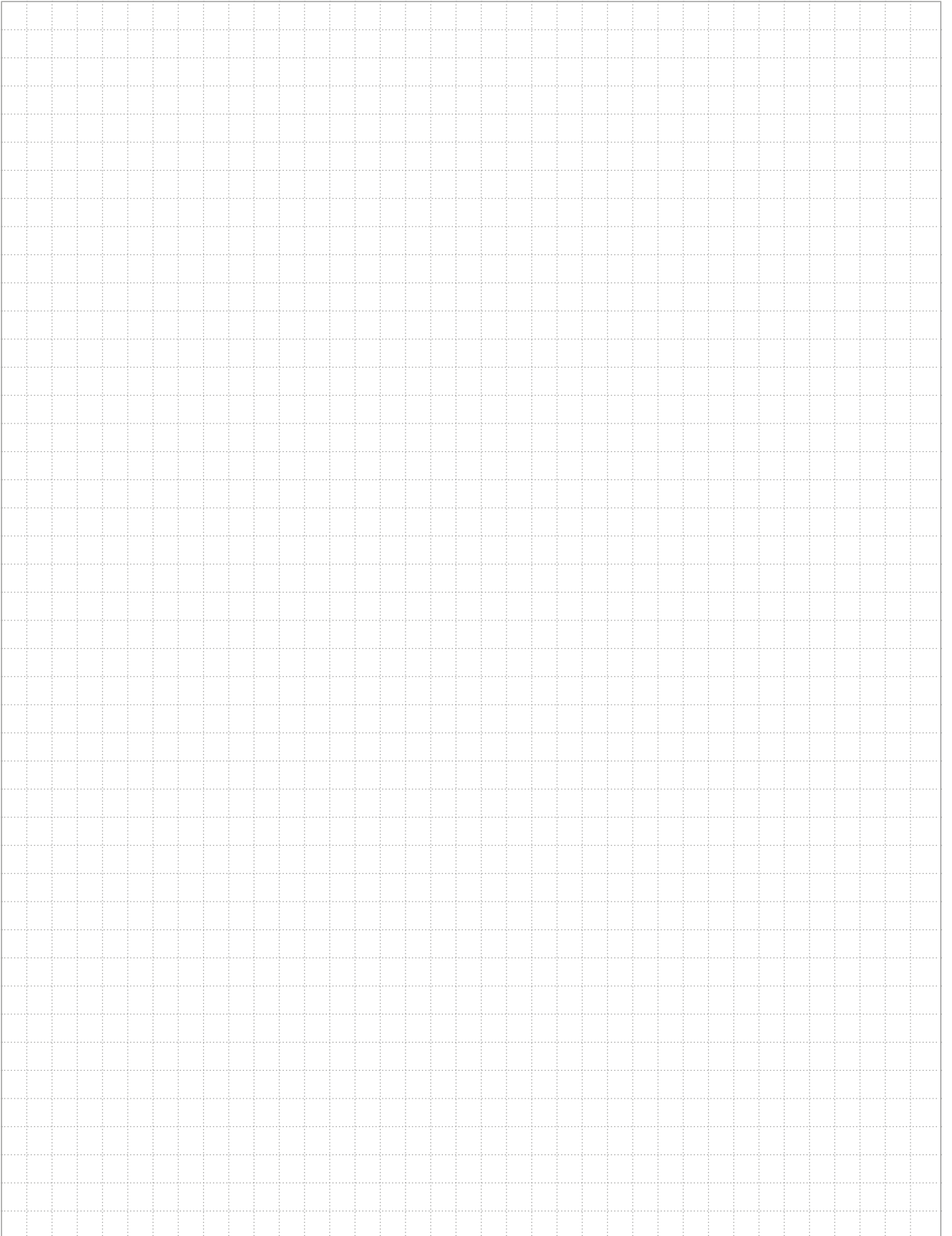

## Mechanical and electrical interlock units



1SBC101429F0014

VE5-2

When mounted between two contactors, the mechanical interlock unit prevents one of the contactors from closing as long as the other contactor is closed.

VE interlock units are used for mechanical and electrical interlocking of two AC or DC operated contactors mounted side by side.

For contactors	Mounting	Type	Order code	Pkg qty	Weight (1 pce) kg
<b>Mechanical and electrical interlock units for two horizontal mounted contactors</b>					
GA75, GAE75	Rail mounting	VE5-2	1SBN030210R1000	1	0.146



# Mechanical and electrical interlock units

## Technical data

Types	<b>VE5-2</b>
-------	--------------



### Contact utilization characteristics according to IEC

Standards	IEC 60947-5-1 and EN 60947-5-1	
Rated insulation voltage $U_i$ acc. to IEC 60947-5-1	690 V	
Rated operational voltage $U_e$ max.	24...690 V	
Conventional thermal current $I_{th} - \theta \leq 40^\circ C$	16 A	
$I_e$ / Rated operational current AC-15 acc. to IEC 60947-5-1	24-127 V 50/60 Hz	6 A
	220-240 V 50/60 Hz	4 A
	380-440 V 50/60 Hz	3 A
	500-690 V 50/60 Hz	2 A
	Making capacity acc. to IEC 60947-5-1	10 x $I_e$ AC-15
Breaking capacity acc. to IEC 60947-5-1	10 x $I_e$ AC-15	
$I_e$ / Rated operational current DC-13 acc. to IEC 60947-5-1	24 V DC	6 A
	48 V DC	2.8 A
	72 V DC	1 A
	125 V DC	0.55 A
	250 V DC	0.3 A
Short-circuit protection device - gG type fuse	10 A	
Rated short-time withstand current $I_{cw}$ $\theta = 40^\circ C$	for 1.0 s	100 A
	for 0.1 s	140 A
Power dissipation per pole at 6 A	0.15 W	
Mechanical durability		
Number of operating cycles	5 millions operating cycles	
Max. switching frequency	600 cycles/h	

### Utilization characteristics according to UL/CSA

Standards	UL 508, CSA C22.2 N°14
Max. operational voltage	600 V

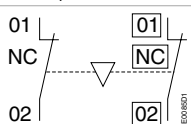

### Connecting characteristics

Connection capacity (min. ... max.)		
 Rigid solid	1 x	1...4 mm <sup>2</sup>
	2 x	1...4 mm <sup>2</sup>
 Flexible with ferrule	1 x	0.75...2.5 mm <sup>2</sup>
	2 x	0.75...2.5 mm <sup>2</sup>
 Lugs	L <	8 mm
	L >	3.5 mm
Tightening torque		
Recommended	1 Nm	
Max.	1.2 Nm	
Degree of protection	IP20	
acc. to IEC 60947-1 / EN 60947-1 and IEC 60529 / EN 60529		
Screw terminals	delivered in open position, screws of unused terminals must be tightened	
All terminals	M3.5	
Screwdriver type	Flat Ø 5.5 / Pozidriv 2	
Terminal marking		

Technical note: when, during switching, the arc time is estimated to more than 40 ms, the closing signal of one of the two contactors must be delayed with respect to the opening signal of the other contactor in order to prevent a short-circuit.  
 Use a TEF5 electronic timer according to application use with time lapse for GA75, GAE75 contactors.

## CA5, CE5, CAL, CEL18 and TEF5 fitting details

Many configurations are possible depending on whether these are front-mounted or side-mounted.

Contactor types	Main poles	Built-in auxiliary contacts	Front-mounted accessories		Electronic timer	Side-mounted accessories		
			Auxiliary contact blocks			Auxiliary contact blocks	Interlock unit	
			1-pole CA5	4-pole CA5	TEF5	2-pole CAL	VE5	
			1-pole CE5			1-pole CEL18		
<b>UA contactors</b>								
UA16 ... UA26	3 0	1 0	1 to 4 x CA5 1 to 2 x CE5 max. (1)	or 1 x 4-pole CA5 + 1 x 1-pole CA5 or CE5 (1)	or 1 x TEF5 + 1 x 1-pole CA5	+ 1 to 2 x CAL5-11	-	
UA30	3 0	1 0	1 to 5 x CA5 1 to 3 x CE5 max. (1)	or 1 x 4-pole CA5 + 1 x 1-pole CA5 or CE5 (1)	or 1 x TEF5 + 1 x 1-pole CA5	+ 1 to 2 x CAL5-11	-	
UA50 ... UA75	3 0	0 0	1 to 6 x CA5 1 to 5 x CE5 max. (2)	or 1 x 4-pole CA5 + 2 x 1-pole CA5 or CE5 (1)	or 1 x TEF5 + 2 x 1-pole CA5	+ 1 to 2 x CAL5-11	-	
	3 0	1 1	1 to 6 x CA5 1 to 5 x CE5 max. (2)	or 1 x 4-pole CA5 + 2 x 1-pole CA5 or CE5 (1)	or 1 x TEF5 + 2 x 1-pole CA5	+ 1 x CAL5-11	-	
UA95, UA110	3 0	0 0	1 to 6 x CA5 1 to 5 x CE5 max. (2)	or 1 x 4-pole CA5 + 2 x 1-pole CA5 or CE5 (1)	-	+ 1 to 2 x CAL18-11	-	
	3 0	1 1	1 to 6 x CA5 1 to 5 x CE5 max. (2)	or 1 x 4-pole CA5 + 2 x 1-pole CA5 or CE5 (1)	-	or 1 to 2 x CEL18	-	
						+ 1 x CAL18-11	-	
						or 1 x CEL18	-	
<b>UA..RA contactors</b>								
UA16-30-10RA	3 0	1 0	-	-	-	+ 1 x CAL5-11	-	
UA26-30-10RA	3 0	1 0	-	-	-	-	-	
UA30-30-10RA	3 0	1 0	1 x CA5	-	-	+ 1 to 2 x CAL5-11	-	
			1 x CE5	-	-	-	-	
UA50-30-00RA	3 0	0 0	1 to 2 x CA5	-	-	+ 1 to 2 x CAL5-11	-	
UA63-30-00RA	3 0	0 0	1 to 2 x CE5	-	-	-	-	
UA75-30-00RA	3 0	0 0	-	-	-	-	-	
UA95-30-00RA	3 0	0 0	1 to 2 x CA5	-	-	+ 1 to 2 x CAL18-11	-	
UA110-30-00RA	3 0	0 0	1 to 2 x CE5	-	-	or 1 to 2 x CEL18	-	
<b>GA75, GAE75 contactors</b>								
GA75	1 0	0 0	1 to 6 x CA5 1 to 5 x CE5 max. (2)	or 1 x 4-pole CA5 + 2 x 1-pole CA5 or CE5 (2)	or 1 x TEF5 + 2 x 1-pole CA5	+ 1 to 2 x CAL5-11	or 1 x VE5-2	
		1 1	1 to 6 x CA5 1 to 5 x CE5 max. (2)	or 1 x 4-pole CA5 + 2 x 1-pole CA5 or CE5 (2)	or 1 x TEF5 + 2 x 1-pole CA5	-	+ 1 x CAL5-11	or 1 x VE5-2
GAE75	1 0	0 0	1 to 6 x CA5 1 to 5 x CE5 max. (2)	or 1 x 4-pole CA5 + 2 x 1-pole CA5 or CE5 (2)	or 1 x TEF5 + 2 x 1-pole CA5	+ 1 x CAL5-11	or 1 x VE5-2	
		1 1	1 to 6 x CA5 1 to 5 x CE5 max. (2)	or 1 x 4-pole CA5 + 2 x 1-pole CA5 or CE5 (2)	or 1 x TEF5 + 2 x 1-pole CA5	-	-	-
						-	-	

Notes regarding combination of CE5 with other accessories:

(1) The total number of N.O. or N.C. CE5 and other additional N.C. CA5 auxiliary contacts is limited to 3. CE5 auxiliary contacts not allowed in mounting position 5.

(2) The total number of N.O. or N.C. CE5 and other additional N.C. CA5 auxiliary contacts is limited to 5.

## Function markers

### Mounting piece



BA5-50

1SBC575874F0301

#### BA5-50 Function markers

Set of 50 function markers designed to be clipped onto the front face of devices. Details can be added to these markers using a ball point pen, indelible felt-tip pen or pentel white.

Self-adhesive labels (not supplied) can also be added to them.

Marker dimensions: 7 x 19 mm (0.276" x 0.748").

For contactors	Type	Order code	Pkg qty	Weight (1 pce) kg
UA, UA..RA and accessories GA75, GAE75	BA5-50	1SBN110000R1000	1	0.017



BP16

1SBC586724F0302

#### BP16 Mounting piece

Mounting piece for screw fixing (M4, not supplied) of UA, UA..RA series contactors indicated in the table below.

Easy handling of screwdrivers and screw driving.

Add-on mounting piece on contactor's rear face, offering a wide fixing facility.

For contactors	Type	Order code	Pkg qty	Weight (1 pce) kg
UA16, UA16..RA	BP16	1SBN111403R1000	100	0.141

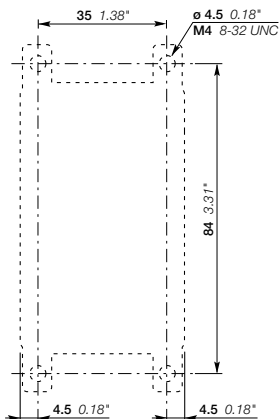

Drilling plan for UA16, UA16..RA contactors with BP16

## Surge suppressors for contactor coils

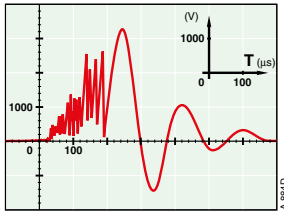

The operation of inductive circuits causes overvoltages, in particular on opening of the contactor coil. The electromagnetic energy stored in the coil during contactor closing is restored on opening in the form of surges, the slope and amplitude of which may rise to several kilovolts. A number of drawbacks are observed ranging from interference on the electronic devices to breakdown of insulators and even destruction of certain sensitive components. The graph opposite reproduces the oscillogram showing voltage discharges at the terminals of a 42 V / 50 Hz coil without peak clipping. The coil was switched by 8 series-connected poles of a contactor relay.

Following a burst of discharges with a very steep slope a damped oscillation emerges with a peak value of 3500 V.

### Overvoltage Factor

The overvoltage factor  $k$  is defined as the ratio of the maximum overvoltage peak value  $\hat{U}_s$  to the peak value  $\hat{U}_c$  of the coil rated control voltage  $U_c$ :

$$k = \frac{\hat{U}_s \text{ max.}}{\hat{U}_c} \quad \text{in DC: } k = \frac{\hat{U}_s \text{ max.}}{U_c} \quad \text{or in AC: } k = \frac{\hat{U}_s \text{ max.}}{U_c \sqrt{2}}$$

For example the following is obtained for the above graph:  $k = \frac{3500}{42 \sqrt{2}} \approx 60$

To reduce the harmful effects of these overvoltages, ABB has developed a range of surge suppressors designed to reduce the  $k$  factor defined above and to limit or even completely eliminate the high pre-damping voltage frequencies.

Each case is different, but the technical data tolerances and the generous sizing of parts have enabled us to reduce the number of variants.

We have chosen the following solutions: transil diodes, varistors and RC blocks.

Note: A varistor is a resistor whose value decreases to a very large extent when a certain voltage is applied at its terminals.



For contactors	Rated control circuit voltage $U_c$		Type	Order code	Pkg qty	Weight (1 pce) kg
	V	AC DC				
UA, UA..RA GA75, GAE75	24...50	● ●	RV5/50	1SBN050010R1000	2	0.015
	50...133	● ●	RV5/133	1SBN050010R1001	2	0.015
	110...250	● ●	RV5/250	1SBN050010R1002	2	0.015
	250...440	● ●	RV5/440	1SBN050010R1003	2	0.015
UA, UA..RA GA75	24...50	● -	RC5-2/50	1SBN050200R1000	2	0.015
	50...133	● -	RC5-2/133	1SBN050200R1001	2	0.015
	110...250	● -	RC5-2/250	1SBN050200R1002	2	0.015
	250...440	● -	RC5-2/440	1SBN050200R1003	2	0.015
GAE75	12...32	- ●	RT5/32	1SBN050020R1000	2	0.015
	25...65	- ●	RT5/65	1SBN050020R1001	2	0.015
	50...90	- ●	RT5/90	1SBN050020R1002	2	0.015
	77...150	- ●	RT5/150	1SBN050020R1003	2	0.015
	150...264	- ●	RT5/264	1SBN050020R1004	2	0.015

## Surge suppressors for contactor coils

### Technical data

Varistor	RV5/50	RV5/133	RV5/250	RV5/440	
Rated control circuit voltage Uc	24...50 V AC	50...133 V AC	110...250 V AC	250...440 V AC	
Residual overvoltage (clipping voltage)	24...50 V DC	50...133 V DC	110...250 V DC	250...440 V DC	
	132 V AC	270 V AC	480 V AC	825 V AC	
	132 V DC	270 V DC	480 V DC	825 V DC	
Opening time growth factor	1.1...1.5				
Operating temperature	-20...+70 °C				
Connection to the coil terminals (parallel mounting)	Clip-on for both fixing and connection.				
Fixing	Clipped onto the top part of the contactor base without change in contactor overall dimensions.				
Advantages	High energy absorption: good damping - Unpolarized system.				
Drawback	Clipping as from Uvdr*, thus voltage front up to this point.				
	*Uvdr = Varistor operating voltage (voltage dependent resistor), tolerance ± 10 %.				
RC type	RC5-2/50	RC5-2/133	RC5-2/250	RC5-2/440	
Rated control circuit voltage Uc	24...50 V AC	50...133 V AC	110...250 V AC	250...440 V AC	
Residual overvoltage (clipping voltage)	2 to 3 x Uc max.				
Opening time growth factor	1.2...1.3				
Operating temperature	-20...+70 °C				
Connection to the coil terminals (parallel mounting)	Clip-on for both fixing and connection.				
Fixing	Clipped onto the top part of the contactor base without change in contactor overall dimensions.				
Advantages	Very fast clipping - Attenuation of steep fronts and thus of high frequencies. No operating delays.				
Transil diode	RT5/32	RT5/65	RT5/90	RT5/150	RT5/264
Rated control circuit voltage Uc	12...32 V DC	25...65 V DC	50...90 V DC	77...150 V DC	150...264 V DC
Residual overvoltage (clipping voltage)	50 V DC	100 V DC	150 V DC	210 V DC	390 V DC
Opening time growth factor	1.5...3				
Operating temperature	-20...+70 °C				
Connection to the coil terminals (parallel mounting)	Clip-on for both fixing and connection.				
Fixing	Clipped onto the top part of the contactor base without change in contactor overall dimensions.				
Advantages	Good energy absorption - Unpolarized system - Simple, reliable system.				
Drawback	A certain delay on drop out which does not however reduce contactor breaking capacity.				

### Wiring diagrams

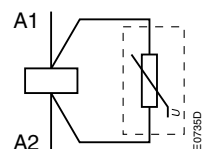

Varistor

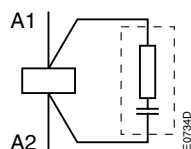

RC type

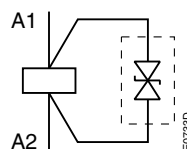

Transil diode

### Dimensions

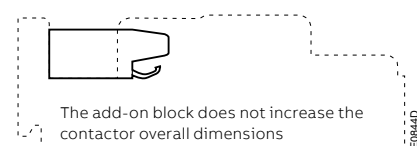

RV5, RC5, RT5

## Interface relays



RA5-1

RA5-1 interface relay is designed to receive 24 V DC signals delivered by PLC's or other sources with a low output power and to restore them with sufficient power to operate the coils of the relevant contactors.

RA5-1 interface relay is made up of a miniature electromechanical relay equipped with a N.O. contact and with a low consumption 24 V DC coil.

The interface relay coil is controlled by the PLC while the N.O. contact ensures switching of the power contactor.

Coil switching gives rise to overvoltages which have adverse effects on the electronic devices, insulators and, more generally, on component lifetime. The RA5-1 is equipped with surge suppressors:

- on the 24 V DC relay coil via a diode,
- on the power contactor coil via a varistor.

Furthermore, the RA5-1 is protected against relay pole reversal by a diode inserted between the E1 and E2 input terminals.





For contactors	Coil voltages	Rated control circuit voltage Uc	Type	Order code	Pkg qty	Weight (1 pce)
	V 50/60 Hz	V DC				kg
UA, UA..RA	24...250	24	RA5-1	1SBN060300R1000	1	0.050
GA75			RA5-1	1SBN060300T1000	10	0.050

# Interface relays

## Technical data

Type	<b>RA5-1</b>
<b>Utilization characteristics according to IEC</b>	
Standards	IEC 60255-5
Rated insulation voltage $U_i$ acc. to IEC 60947-4-1	250 V AC
Ambient air temperature	
In free air operation	at $U_c = 24$ V DC (between E1 and E2) -25...+70 °C
Storage	from 0.85 to 1.1 x $U_c$ -25...+55 °C
Storage	-40...+70 °C
Climatic withstand	Complies with that of associated contactors
Maximum operating altitude	3000 m
Mounting positions	No limitation
Fixing	Using the contactor A1 and A2 terminal connecting parts

## Connecting characteristics

Connection capacity (min. ... max.)	
 Rigid solid	1 x 1...4 mm <sup>2</sup>
 Flexible with ferrule	2 x 1...4 mm <sup>2</sup>
 Flexible with ferrule	1 x 0.75...2.5 mm <sup>2</sup>
 Flexible with ferrule	2 x 0.75...2.5 mm <sup>2</sup>
 Lugs	L < 8 mm
	I > 3.5 mm
Tightening torque	
Recommended	1 Nm
Max.	1.2 Nm
Degree of protection acc. to IEC 60947-1 / EN 60947-1 and IEC 60529 / EN 60529	Protection against direct contact in acc. with EN 50274 RA5-1 wired and mounted on the associated contactor
Screw terminals	Delivered in open position, screws of unused terminals must be tightened
All terminals	M3.5
Screwdriver type	Flat Ø 5.5 / Pozidriv 2

## Working data

Surge suppression	
For contactor coil	Varistor
For interface relay coil	Diode
Protection against polarity reversal between terminals E1 and E2	Diode
Interface relay operating time	Closing and drop-out ≤ 10 ms
Total operating time, interface relay + contactor	
Between energization and:	
N.O. contact closing	20...37 ms
N.C. contact opening	17...32 ms
Between de-energization and:	
N.O. contact opening	17...25 ms
N.C. contact closing	20...28 ms

## Electrical input data

Control voltage (E1 and E2 terminals) $U_c$	
Rated value	24 V DC
Max. range at ambient temperature 20 °C	19...30 V DC
Max. consumption for $U_c = 24$ V DC, $\theta = 20$ °C	0.3 W
"0" status (relay open)	for $U_c$ ≤ 2.4 V DC
	for $I_c$ < 1 mA
"1" status (relay closed)	for $U_c$ ≥ 19 V DC
Max. short supply interruption immunity time	2 ms

## Electrical output data

Switching voltage (A0 and A2 terminals)	≤ 250 V AC
Electrical durability	
Number of operating cycles	2 millions (600 cycles/h) on UA16(RA) ... UA75(RA), GA75, GAE75 contactors 0.5 million (600 cycles/h) on UA95(RA) and UA110(RA) contactors

## Connection

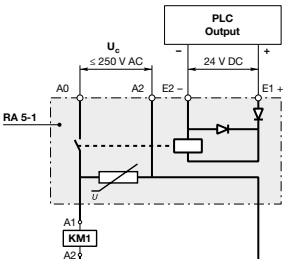

The "E1+" and "E2-" input terminals must be connected, according to their polarity, to the PLC output. The RA5-1 is equipped with two terminal pads for connection to the A1 and the A2 terminals of the contactor coil.

This coil is supplied between the A0 and the A2 terminals of the RA 5-1.

Mounting: terminal pads clamped inside the contactor coil terminals.



## Mechanical latching units



WB75-A

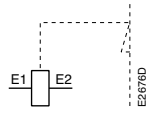

Terminal marking

For converting standard contactors into latched contactors.

The WB75-A block contains a mechanical latching device with electromagnetic impulse unlatching (AC or DC) or manual unlatching.

Captive screw type connecting terminals, built-in cable clamps, M3.5 (+,-) pozidriv 2 screw with screwdriver guidance; delivered untightened and protected against accidental direct contact.

### Operation

After closing, the contactor continues to be held in the closed position by the latching mechanism should the supply voltage fail at the contactor coil terminals.

Contactor opening can be controlled:

- electrically by an impulse (AC or DC) on the WB75-A block coil.  
(the coil is not designed to be permanently energized)
- manually by pressing the pushbutton on the front face of the WB75-A block.

### Mounting

The WB75-A block is clipped onto the front face of the 1-stack contactor where it takes up two slots. The two other slots may accept CA5... single pole auxiliary contacts (1 block on each side of the mechanical latch).

For contactors	Rated control circuit voltage U <sub>c</sub>		Type	Order code	Pkg qty	Weight (1 pce) kg
	V 50 Hz or DC	V 60 Hz				
UA16 ... UA75, GA75, GAE75	24	24...28	WB75-A	FPTN372726R1001	1	0.120
	42	42...48	WB75-A	FPTN372726R1002	1	0.120
	48	48...55	WB75-A	FPTN372726R1003	1	0.120
	110	110...127	WB75-A	FPTN372726R1004	1	0.120
	220...230	220...255	WB75-A	FPTN372726R1006	1	0.120
	230...240	230...277	WB75-A	FPTN372726R1005	1	0.120
	380...415	380...440	WB75-A	FPTN372726R1007	1	0.120
	415...440	440...480	WB75-A	FPTN372726R1008	1	0.120

# Mechanical latching units





## Technical data

Type	<b>WB75-A</b>
------	---------------

### Utilization characteristics according to IEC

Rated insulation voltage $U_i$ acc. to IEC 60947-1	690 V	
Max. electrical impulse time		
On AC coil (with load factor 5 %)	20 s	
On DC coil (with load factor 3 %)	8 s	
Min. electrical impulse time		
For latching (energizing of the contactor coil)	AC	50 ms (UA, GA contactors)
	DC	50 ms (GAE contactors)
For pull-out (energizing of the WB block coil)	AC	30 ms (UA, GA contactors)
	DC	50 ms (GAE contactors)
Coil operating limits	AC or DC supply	0.85...1.1 x $U_c$
AC control voltage 50/60 Hz		
Rated control circuit voltage $U_c$	24...480 V AC	
Coil consumption	Average pull-in value	90 VA
	Average holding value	60 VA
DC control voltage		
Rated control circuit voltage $U_c$	24...440 V DC	
Coil consumption	Average pull-in value	110 W
	Average holding value	110 W
On contactor closing (latching)		
Between coil energization and:	N.O. contact closing	No difference with the operation of a contactor without mechanical latching unit
	N.C. contact opening	No difference with the operation of a contactor without mechanical latching unit
On contactor opening (unlatching)		
Between WB coil energization and:	N.O. contact opening	5...25 ms
	N.C. contact closing	7...28 ms
Mechanical durability	Number of operating cycles	1 million operating cycles
Max. switching frequency	3600 cycles/h with on-load factor of 8 %	

### Connecting characteristics

Connection capacity (min. ... max.)		
	Rigid solid	1 x 1...4 mm <sup>2</sup>
		2 x 1...4 mm <sup>2</sup>
	Flexible with ferrule	1 x 0.75...2.5 mm <sup>2</sup>
		2 x 0.75...2.5 mm <sup>2</sup>
	Lugs	L < 8 mm
		L > 3.5 mm
Tightening torque	Recommended	1 Nm
	Max.	1.2 Nm
Screw terminals	Delivered in open position, screws of unused terminals must be tightened	
All terminals	M3.5	
Screwdriver type	Flat Ø 5.5 / Pozidriv 2	

## Additional terminal blocks and other accessories

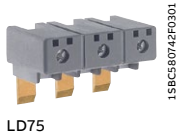

LD75

### Terminal blocks





The LD terminal blocks are designed to increase the connecting capacity of the contactor on which they are fitted and for preparation of the wiring before final connection on the contactor.

The LD blocks are 3-pole terminal blocks with tunnel terminals.

The LD75 terminal blocks are fixed in the 3 independent slots located above the built-in connectors.

For contactors	Type	Order code	Pkg qty	Weight (1 pce) kg
UA50(RA) ... UA75(RA)	LD75	1SBN073508R1000	1	0.115

### Technical data

Types	LD75
Rated insulation voltage $U_i$ acc. to IEC 60947-4-1 acc. to UL / CSA	690 V 600 V
Main terminals	 Screw terminals with single connector 10x11 mm
Connection capacity (min. ... max.)	
 Rigid Solid ( $\leq 4 \text{ mm}^2$ )	} 1 x 6...50 mm <sup>2</sup> 2 x 6...25 mm <sup>2</sup>
 Stranded ( $\geq 6 \text{ mm}^2$ )	
 Flexible with ferrule	1 x 6...35 mm <sup>2</sup>
 Bars	2 x 6...16 mm <sup>2</sup> 10 mm
Tightening torque	4 Nm
Degree of protection acc. to IEC 60947-1 / EN 60947-1 and IEC 60529 / EN 60529	IP10
Screw terminals	Delivered in closed position M6 Screwdriver type pozidriv 2
Note: The utilization of LD additional terminal blocks leaves the possibility to connect the following cables directly into the contactor main terminals.	
	LD75
Possible cross section of rigid cable in the contactor terminals	50 mm <sup>2</sup>

### Terminal enlargements

Enlargement pieces designed to increase the width of the contactor terminal pads in order to allow larger connections to be mounted.

Sets containing 3 tin plated copper bars fixed by an isolating spacer.

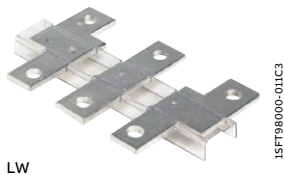

LW

For contactors	Dimensions		Type	Order code	Pkg qty	Weight (1 pce) kg
	hole $\varnothing$ mm	bar mm				
UA95, UA110	6.5	15 x 3	LW110	1SFN074307R1000	1	0.100

# Terminals for control lead connections



LK75-L



LK75-F

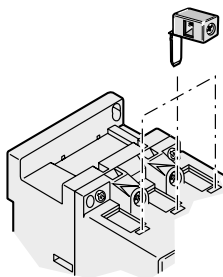

LK positioning

Terminals designed to connect the control conductors to the main poles of the UA and GA contactors and derivative versions.

Accessories clipped into the slots placed above each power terminal connector.

The LK75 are fitted with a pin designed to hold them in place until the connector has been fully clamped with its power cable.

- Degree of protection IP20
- Connecting terminal delivered in open position: cable clamp and M3.5 (+,-) pozidriv 2 screw.
- Cable cross-sectional area:
  - 1 or 2 rigid conductors.....1...4 mm<sup>2</sup>
  - 1 or 2 flexible conductors with cable end ..... 0.75...2.5 mm<sup>2</sup>
- Tightening torque for the LK screw:
  - recommended .....1.00 Nm
  - maxi. ....1.20 Nm

For contactors	Type	Order code	Pkg qty	Weight (1 pce) kg
Right and left on: UA50(RA) ... UA75(RA) GA75, GAE75	LK75-L	1SBN073552R1003	2	0.006
Opposite on: UA50(RA) ... UA75(RA) GA75, GAE75	LK75-F	1SBN073552R1002	2	0.006

Note: The LK terminals provided for the UA contactors can be used with the AM types.

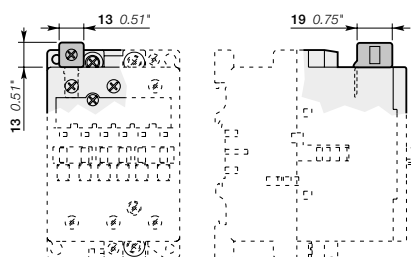

LK75-L

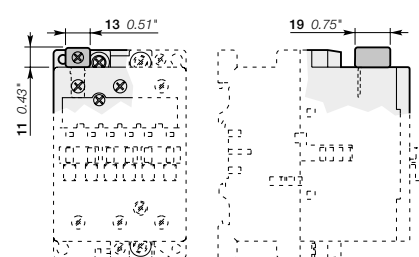

LK75-F

Main dimensions mm, inches

## Connection bar for contactor

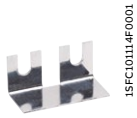

LP185



LP2050

For contactors	Type	Order code	Pkg qty	Weight (1 pce) kg
<b>Connection bar for contactor</b>				
GAF185	LP185	1SFN074712R1000	2	0.300
GAF300	LP300	1SFN075112R1000	2	0.400
GAF460	LP460	1SFN075712R1000	4	0.550
GAF750	LP750	1SFN076112R1000	4	0.950
GAF1250	LP1250	1SFN076412R1000	4	1.900
GAF1650, GAF2050	LP2050	1SFN076512R1000	4	2.900

### Maximum continuous current with two parallel connection strips per pole

Connexion kit (includes 4 pcs of connection strips)	Ie max
2 x LP185	220 A
2 x LP300	370 A
1 x LP460	600 A
1 x LP750	800 A
1 x LP1250	900 A
1 x LP2050	1650 A

# Contactor coils and main contact sets



1SBG573802P0302

ZA16

## Contactor coils

For contactors	Rated control circuit		Type	Order code	Pkg qty	Weight (1 pce) kg
	voltage Uc					
	V 50 Hz	V 60 Hz				
UA16,	24	24	ZA16	1SBN151410R8106	1	0.093
	110	110...120	ZA16	1SBN151410R8406	1	0.093
	220...230	230...240	ZA16	1SBN151410R8006	1	0.093
	230...240	240...260	ZA16	1SBN151410R8806	1	0.093
	380...400	400...415	ZA16	1SBN151410R8506	1	0.093
	400...415	415...440	ZA16	1SBN151410R8606	1	0.093
UA26, UA30,	24	24	ZA40	1SBN152410R8106	1	0.148
	110	110...120	ZA40	1SBN152410R8406	1	0.148
	220...230	230...240	ZA40	1SBN152410R8006	1	0.148
	230...240	240...260	ZA40	1SBN152410R8806	1	0.148
	380...400	400...415	ZA40	1SBN152410R8506	1	0.148
	400...415	415...440	ZA40	1SBN152410R8606	1	0.148
UA50 ... UA75 GA75	24	24	ZA75	1SBN153510R8106	1	0.166
	110	110...120	ZA75	1SBN153510R8406	1	0.166
	220...230	230...240	ZA75	1SBN153510R8006	1	0.166
	230...240	240...260	ZA75	1SBN153510R8806	1	0.166
	380...400	400...415	ZA75	1SBN153510R8506	1	0.166
	400...415	415...440	ZA75	1SBN153510R8606	1	0.166
UA95, UA110	24	24	ZA110	1SBN154310R8106	1	0.170
	110	110...120	ZA110	1SBN154310R8406	1	0.170
	220...230	230...240	ZA110	1SBN154310R8006	1	0.170
	230...240	240...260	ZA110	1SBN154310R8806	1	0.170
	380...400	400...415	ZA110	1SBN154310R8506	1	0.170
	400...415	415...440	ZA110	1SBN154310R8606	1	0.170
GAF460	-	24...60	ZAF460	1SBN155770R6806	1	0.525
	48...130	48...130	ZAF460	1SBN155770R6906	1	0.525
	100...250	100...250	ZAF460	1SBN155770R7006	1	0.525
	250...500	250...500	ZAF460	1SBN155770R7106	1	0.525
	-	24...60	ZAF750	1SBN156170R6806	1	1.335
GAF750 ... AF1250	48...130	48...130	ZAF750	1SBN156170R6906	1	1.335
	100...250	100...250	ZAF750	1SBN156170R7006	1	1.335
	250...500	250...500	ZAF750	1SBN156170R7106	1	1.335
	100...250	100...250	ZAF1650 (1) ZP1650 (2)	1SBN156570R7026 1SBN166521R1070	1 set 1	0.900 0.300

ZAF460, ZAF750 : printed circuit board included.  
 (1) One set of two coil.  
 (2) Printed circuit board.



1SFC1000F0201

ZAF1650

## Main contact sets

The contact sets for 3-pole contactors consists of six fixed contacts, three moving contacts, springs and the required screws.

For contactors	Type	Order code	Pkg qty	Weight (1 pce) kg
UA50	ZLU50	1SBN163502R1000	1	0.115
UA63	ZLU63	1SBN163702R1000	1	0.145
UA75	ZLU75	1SBN164102R1000	1	0.145
UA95	ZLU95	1SBN164302R1000	1	0.190
UA110	ZLU110	1SBN164502R1000	1	0.190



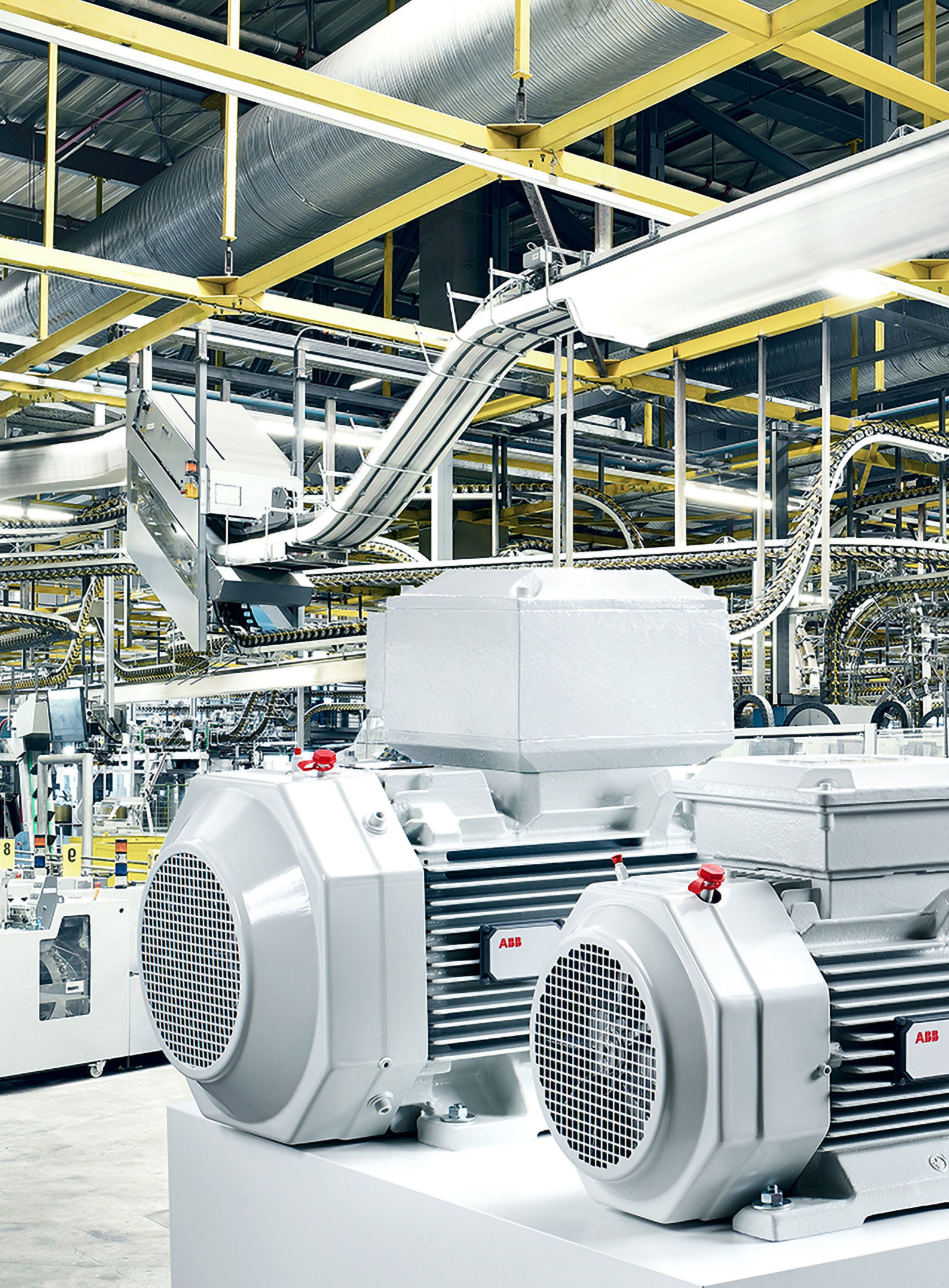



---

# Accessories for EK550, EK1000 4-pole contactors

- 3/298** Auxiliary contact blocks
- 3/302** Mechanical interlock units, terminal shrouds and connection sets
- 3/303** Surge suppressors for contactor coils
- 3/305** Main contact sets - Arc chutes
- 3/306** Contactor coils
- 3/404** **Voltage code table**



For direct product details information, use product type or order code, ex:

- [www.abb.com/productdetails/AF09-30-10-13](http://www.abb.com/productdetails/AF09-30-10-13)
- or [www.abb.com/productdetails/1SBL137001R1310](http://www.abb.com/productdetails/1SBL137001R1310)

# Auxiliary contact blocks

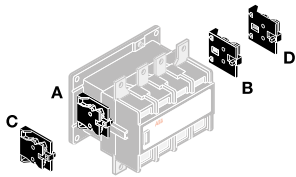

Mounting positions of the CAL16-11

E2074D

The auxiliary contact blocks are used for the operation of auxiliary circuits and control circuits.

Types of auxiliary contact blocks for standard industrial environments:

- CAL instantaneous with N.O. + N.C. contacts
- CCL N.O. leading contact + N.C. lagging contact.

The auxiliary contact blocks are equipped with screw type connecting terminals delivered open, protected against accidental direct contact, and bear the corresponding function marking. Mounting: Screwed onto the right and / or lefthand side of the EK550, EK1000 contactors.

For contactors	Number of blocks	Auxiliary contacts	Type	Order code	Pkg qty	Weight (1 pce)
						kg

### 2-pole auxiliary contacts N.O. + N.C.

EK	Number of blocks	N.O.	N.C.	Type	Order code	Pkg qty	Weight (1 pce)
	1	1	--	CAL16-11A	SK829002-A	1	0.050
	1	1	--	CAL16-11B	SK829002-B	1	0.050
	1	1	--	CAL16-11C	SK829002-C	1	0.050
	1	1	--	CAL16-11D	SK829002-D	1	0.050
	1	1	- 1	CCL16-11E (1)	SK829002-E	1	0.050

(1) Mounting of CCL16-11E blocks does not allow an additional second block to be added on top of it. All DC operated EK contactors are equipped with one CCL16-11E on the right side.

## Auxiliary contact blocks

### Technical data

Types	2-pole CAL 16-11, 2-pole CCL 16-11
-------	------------------------------------





### Contact utilization characteristics according to IEC

Standards	IEC 60947-5-1 and EN 60947-5-1	
Rated insulation voltage $U_i$ acc. to IEC 60947-5-1	690 V	
Rated operational voltage $U_e$ max.	24...690 V	
Conventional thermal current $I_{th} - \theta \leq 40^\circ\text{C}$	10 A	
Rated frequency (without derating)	50/60 Hz	
$I_e$ / Rated operational current AC-15 acc. to IEC 60947-5-1	24-127 V	6 A
	220-240 V	6 A
	380-440 V	4 A
	500-690 V	1 A
Making capacity acc. to IEC 60947-5-1	10 x $I_e$ AC-15	
Breaking capacity acc. to IEC 60947-5-1	10 x $I_e$ AC-15	
$I_e$ / Rated operational current DC-13 acc. to IEC 60947-5-1	24 V DC	6 A
	48 V DC	6 A
	72 V DC	4 A
	125 V DC	1.8 A
	250 V DC	0.6 A
Short-circuit protection device gG type fuse	10 A	
Rated short-time withstand current $I_{cw}$ $\theta = 40^\circ\text{C}$	for 1.0 s	50 A
	for 0.1 s	100 A
Minimum switching capacity with failure rate acc. to IEC 60947-5-4	0.25 VA / 12 V or 0.25 VA / 5 mA	
Power dissipation per pole at 6 A	0.2 W	
Mechanical durability	Number of operating cycles	10 millions operating cycles
	Max. switching frequency	3600 cycles/h
Electrical durability	Number of operating cycles	see "Electrical durability" curves
	Max. switching frequency	1200 cycles/h

### Contact utilization characteristics according to UL / CSA

Max. operational voltage	600 V
Pilot duty	A600

### Connecting characteristics

Connection capacity (min. ... max.)		
	Rigid solid	1 x 0.5...2.5 mm <sup>2</sup>
		2 x 0.5...2.5 mm <sup>2</sup>
	Flexible with ferrule	1 x 0.5...2.5 mm <sup>2</sup>
		2 x 0.5...2.5 mm <sup>2</sup>
	Flexible with insulated ferrule	1 x 0.5...1.5 mm <sup>2</sup>
		2 x 0.5...1.5 mm <sup>2</sup>
	Lugs	L ≤ 8 mm
		l > 3.7 mm
Tightening torque	Recommended	1.00 Nm
	Max.	1.20 Nm
Degree of protection acc. to IEC 60947-1 / EN 60947-1 and IEC 60529 / EN 60529	IP20	
Screw terminals	Delivered in open position, screws of unused terminals must be tightened	
	All terminals	M3.5
Screwdriver type	Pozidriv 2	

# Auxiliary contacts

## Electrical durability

### Electrical Durability for AC-15 Utilization Category

AC-15 utilization category according to IEC 60947-5-1 / EN 60947-5-1:

- making current:  $10 \times I_e$  with  $\cos \phi = 0.7$  and  $U_e$
- breaking current:  $I_e$  with  $\cos \phi = 0.4$  and  $U_e$ .

This curve represents the electrical durability of the auxiliary contacts in relation to the breaking current. The curve has been drawn for resistive and inductive loads up to 690 V, 40...60 Hz.

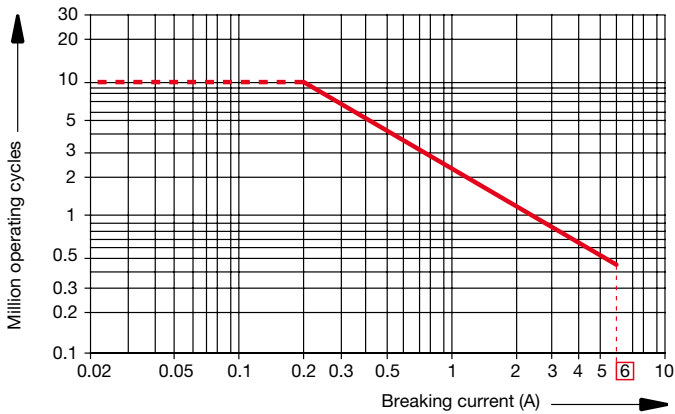

2-pole CAL16... and CCL16... auxiliary contact blocks

### Electrical Durability for DC-13 Utilization Category

DC-13 utilization category according to IEC 60947-5-1 / EN 60947-5-1:

- making and breaking current =  $I_e$  with  $U_e$  value.

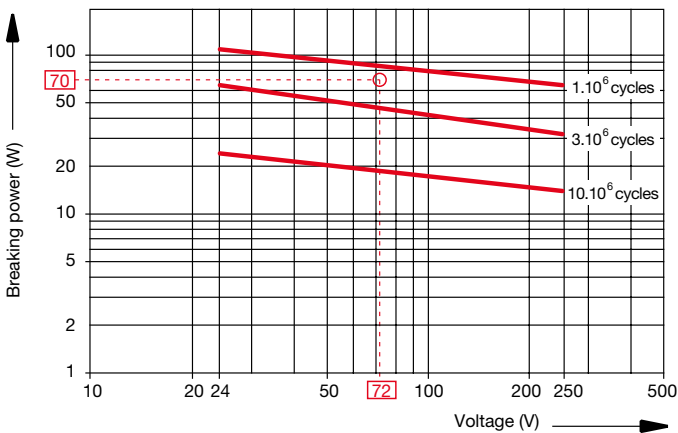

2-pole CAL16... and CCL16... auxiliary contact blocks

Example:

Control of d.c. electro-magnet:  $U_e$  voltage = 72 V d.c. and breaking power = 70 W.

On the opposite curve at intersection "O" 72 V / 70 W the corresponding value for the electrical durability is approximately 2.10<sup>6</sup> cycles.

## Add-on auxiliary contacts

Terminal marking and positioning

### 2-pole auxiliary contacts



CAL16-11A



CAL16-11B



CAL16-11C



CAL16-11 D



CAL16-11E

## Mechanical interlock units, terminal shrouds and connection sets



A0890C4

### Mechanical interlock units

The mechanical interlock unit prevents one of the contactors from closing as long as the other contactor is closed.

VH800 interlock unit is used for the mechanical interlocking of two horizontal mounted EK550, EK1000 contactors. Mounting plate is included.

For contactors	Type	Order code	Pkg qty	Weight (1 pce) kg
----------------	------	------------	---------	-------------------

### Mechanical interlock unit for two horizontal mounted contactors

EK550, EK1000	VH800	SK829070-F	1	6.000
---------------	-------	------------	---	-------

### Terminal shrouds

The use of terminal shrouds on the main terminals of EK contactors is required in electrical panels or cubicles to be built in compliance with the rules for protection against direct contact with live parts in acc. with EN 50274.

On EK550, EK1000 contactors:

- The auxiliary contact blocks and coils are designed to provide an IP20 degree of protection
- The main terminals, equipped with lugs or connectors, can be protected against accidental direct contact after wiring (EN 50274) by the addition of terminal shrouds (see table below).

Each terminal shroud protects all the terminals on one side of the contactor. Two terminal shrouds should be provided for each separate contactor.

For contactors	Type	Order code	Pkg qty	Weight (1 pce) kg
EK550	LT550-EK	SK178001-LB	1	0.190
EK1000	LT1000-EK	SK178001-MB	1	0.200

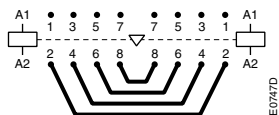

E0747D

BSS550, BSS1000

### Connection sets

Connection between the main poles of two 4-pole contactors mounted side by side so that they operate as source reversing contactors.

These sets are made up of four downstream connections. BSS550, BSS1000 – Bare, solid copper bars.

For contactors	Type	Order code	Pkg qty	Weight (1 pce) kg
----------------	------	------------	---------	-------------------

### Mechanical and electrical interlock units for two horizontal mounted contactors

EK550	BSS550	SK829090-E	1	3.300
EK1000	BSS1000	SK829090-H	1	5.500

## Surge suppressors for contactor coils

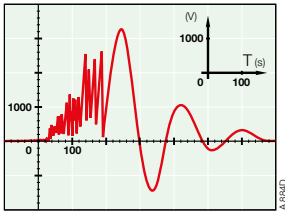

The operation of inductive circuits causes overvoltages, in particular on opening of the contactor coil.

The electromagnetic energy stored in the coil during contactor closing is restored on opening in the form of surges, the slope and amplitude of which may rise to several kilovolts. A number of drawbacks are observed ranging from interference on the electronic devices to breakdown of insulators and even destruction of certain sensitive components.

The graph opposite reproduces the oscillogram showing voltage discharges at the terminals of a 42 V / 50 Hz coil without peak clipping. The coil was switched by 8 series-connected poles of a contactor relay.

Following a burst of discharges with a very steep slope a damped oscillation emerges with a peak value of 3500 V.

### Overvoltage Factor

The overvoltage factor  $k$  is defined as the ratio of the maximum overvoltage peak value  $\hat{U}_s$  to the peak value  $\hat{U}_c$  of the coil rated control voltage  $U_c$ :

$$k = \frac{\hat{U}_s \text{ max.}}{\hat{U}_c} \quad \text{in DC: } k = \frac{\hat{U}_s \text{ max.}}{U_c} \quad \text{or in AC: } k = \frac{\hat{U}_s \text{ max.}}{U_c \sqrt{2}}$$

For example the following is obtained for the above graph:  $k = \frac{3500}{42 \sqrt{2}} \approx 60$

To reduce the harmful effects of these overvoltages, ABB has developed a range of surge suppressors designed to reduce the  $k$  factor defined above and to limit or even completely eliminate the high pre-damping voltage frequencies.

Each case is different, but the technical data tolerances and the generous sizing of parts have enabled us to reduce the number of variants.

We have chosen the following solutions: transil diodes, varistors and RC blocks.

Note: A varistor is a resistor whose value decreases to a very large extent when a certain voltage is applied at its terminals.

For contactors	Rated control circuit voltage $U_c$		Type	Order code	Pkg qty	Weight (1 pce)
	V	AC DC				
EK550, EK1000	48...110	● -	RC-EH800/110	SK829007-C	1	0.015
EK550, EK1000	24...125	- ●	RC-EH800/110	SK829007-C	1	0.015
EK550, EK1000	220...600	● -	RC-EH800/600	SK829007-D	1	0.015



## Surge suppressors for contactor coils

### Technical data

Varistor + RC	RC-EH800/110	RC-EH800/600
Rated control circuit voltage U <sub>c</sub>	48...110 V AC 24...125 V DC	220...600 V AC -
Residual overvoltage (clipping voltage)	205 V AC 205 V DC	1100 V AC -
Opening time growth factor	1.1 ... 1.15	
Operating temperature	-20 ... +70 °C	
Connection to the coil terminals (parallel mounting)	Flexible, accessible leads, equipped with forked lugs	
Fixing	Glued to the top part of the contactor base	
Advantages	<ul style="list-style-type: none"> <li>- High energy absorption: good damping</li> <li>- Unpolarized system</li> <li>- The RC system damps the voltage front under the U<sub>vdr</sub> (1) threshold.</li> </ul>	

(1) U<sub>vdr</sub> = Varistor operating (voltage dependant resistor), tolerance ±10 %.

### Wiring diagrams

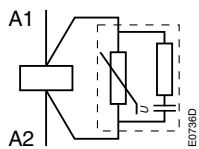

Varistor + RC

### Main dimensions mm

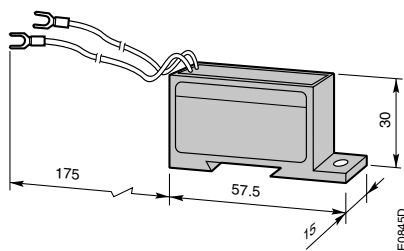

RC-EH

# Main contact sets

## Arc chutes



15FC101226C0304

KZK

### Main contact sets

The contact sets for 4-pole contactors consist of eight fixed contacts, four moving contacts, springs and the necessary screws. In addition, the sets include four moving arcing contacts for EK550, EK1000 contactors.

For contactors	Type	Order code	Pkg qty	Weight (1 pce) kg
EK550	KZK550	SK827204-B	1	2.400
EK1000	KZK1000	SK827204-F	1	3.000

### Arc chutes

The arc chutes sets for EK 4-pole contactors contain 8 pieces.

For contactors	Type	Order code	Pkg qty	Weight (1 pce) kg
EK550	KWK550	5223351-Z	1	3.170
EK1000	KWK1000	5223351-AN	1	3.170

## Contactor coils



KH800

1SFC273813 F0302

### For AC operated coil

Coils for EK550, EK1000 - AC operated.

For contactors	Rated control circuit voltage Uc (1)		Type	Order code	Pkg qty	Weight (1 pce)  kg
	V 50 Hz	V 60 Hz				
EK550, EK1000	48	-	KH800	SK828100-AD	1	0.950
	110	110...120	KH800	SK828100-EF	1	0.950
	110...115	115...127	KH800	SK828100-EG	1	0.950
	220	220...240	KH800	SK828100-EL	1	0.950
	220...230	230...255	KH800	SK828100-EM	1	0.950
	380...400	400...440	KH800	SK828100-ER	1	0.950
	400...415	-	KH800	SK828100-AR	1	0.950

(1) Other control voltages, see voltage code table.

### For DC operated coil

Coils for EK550, EK1000 - DC operated with sets including a DC coil, an economy resistor and a insertion contact.

For contactors	Rated control circuit voltage Uc (1)		Type	Order code	Pkg qty	Weight (1 pce)  kg
	V DC					
EK550, EK1000	24		KP800	SK828150-DB	1 set	1.060
	110		KP800	SK828150-DE	1 set	1.060
	125		KP800	SK828150-DU	1 set	1.060
	220		KP800	SK828150-DF	1 set	1.060

(1) Other control voltages, see voltage code table.

—  
**Notes**

A large rectangular area filled with a grid of small, light gray dotted lines, intended for handwritten notes.



---

# Contactors and contactor relays

## Terminal marking and positioning, Dimensions

### Terminal marking and positioning

- 3/310** AF, AF..K, AFS 3-pole contactors
- 3/314** AF, EK 4-pole contactors
- 3/317** UA, UA ... RA contactors
- 3/319** NF contactor relays

### Dimensions

- 3/321** AF, AFS, AF ... K 3-pole contactors
- 3/357** AF, EK 4-pole contactors
- 3/372** GA, GAF contactors
- 3/379** UA, UA ... RA contactors
- 3/382** NF contactor relays

- 3/404** **Voltage code table**



For direct product details information, use product type or order code, ex:

- [www.abb.com/productdetails/AF09-30-10-13](http://www.abb.com/productdetails/AF09-30-10-13)
- or [www.abb.com/productdetails/1SBL137001R1310](http://www.abb.com/productdetails/1SBL137001R1310)

# AF09 ... AF96 3-pole contactors

## Terminal marking and positioning

### AF09 ... AF96 contactors - AC / DC operated

Standard devices without addition of auxiliary contacts

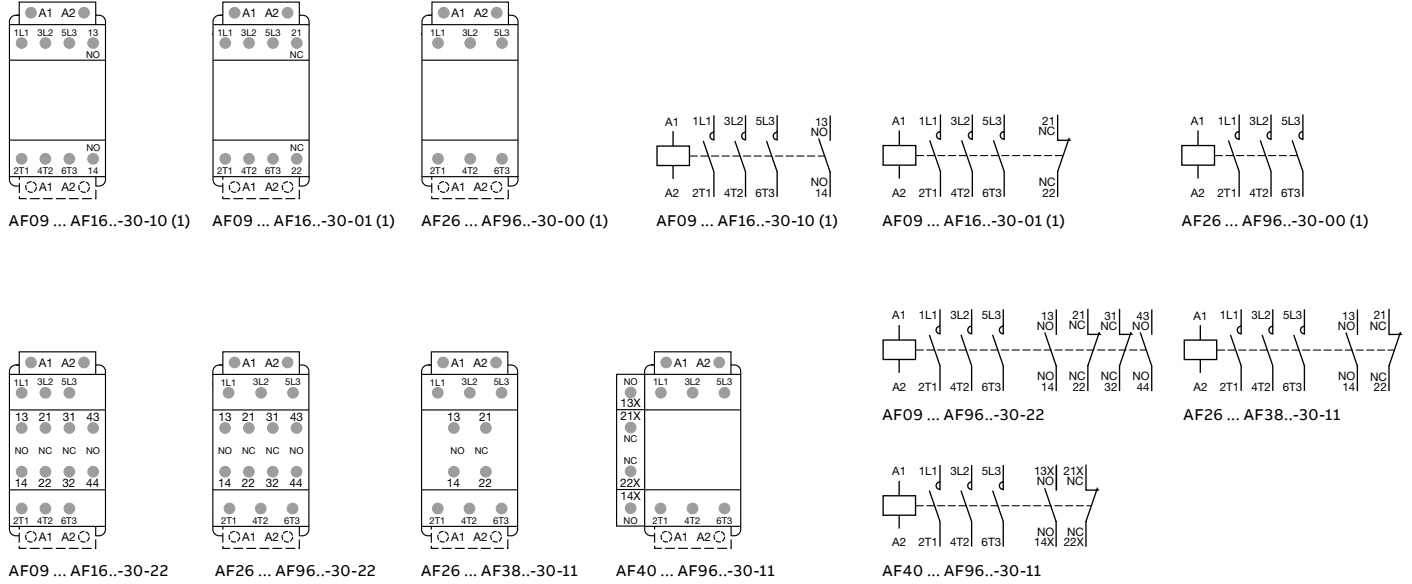

### Other possible contact combinations with auxiliary contacts added by the user

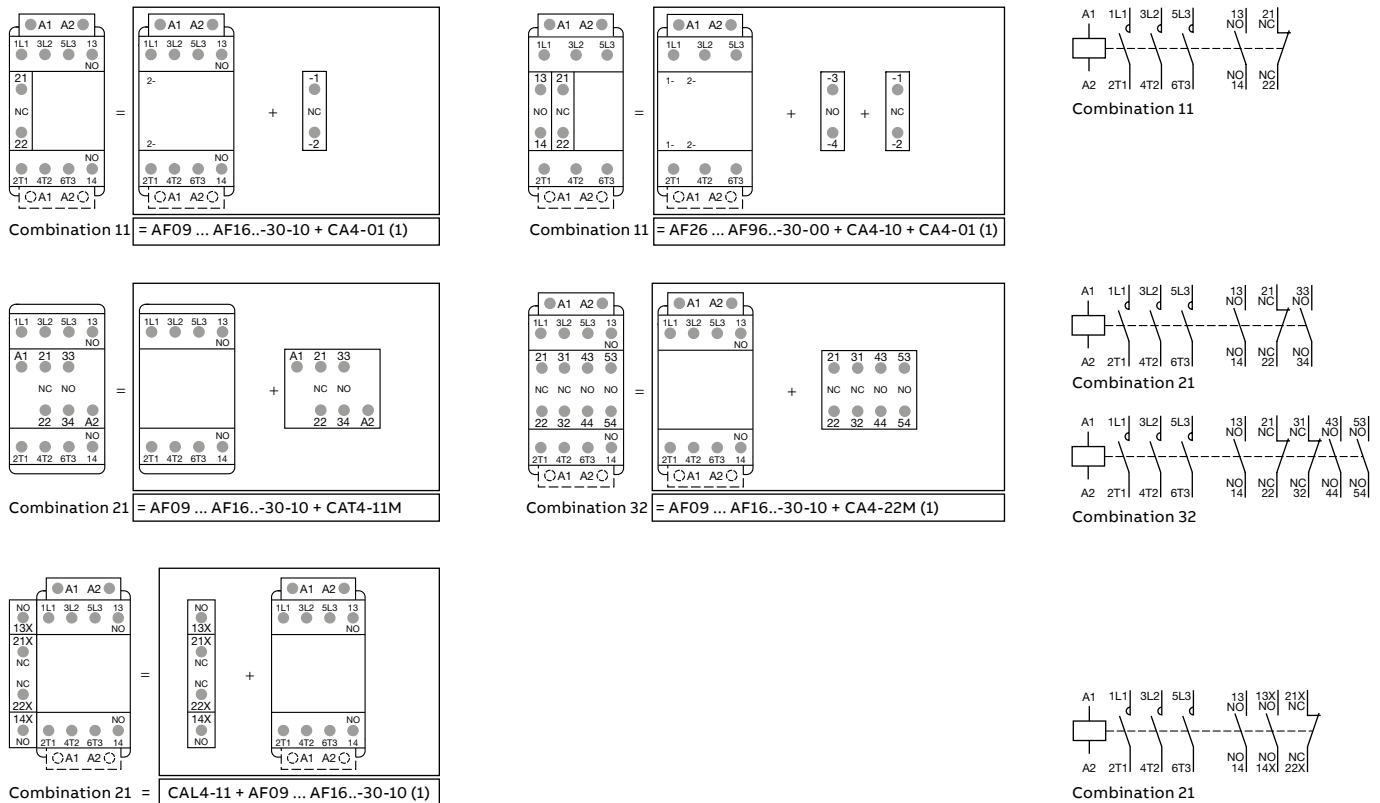

Note: only AF...Z contactor with DC control voltages 12...20 V DC (coil 20) and 24 V DC (coil 30) need to respect the connection polarities indicated close to the coil terminals:

A1+ for the positive pole and A2- for the negative pole.

(1) For AF09...K... AF38...K contactors with Push-in Spring terminals, terminal marking and positioning are the same.



# AF116 ... AF370 3-pole contactors

## Terminal marking and positioning

### AF116 ... AF370 contactors - AC / DC operated

Standard devices without addition of auxiliary contacts

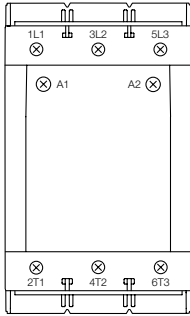

AF116 ... AF370-30-00

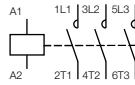

AF116 ... AF370-30-00

### Standard devices with factory mounted auxiliary contacts

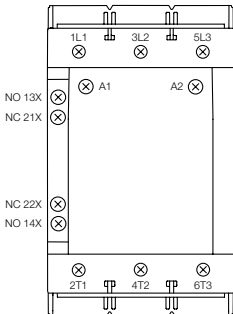

AF116 ... AF370-30-11

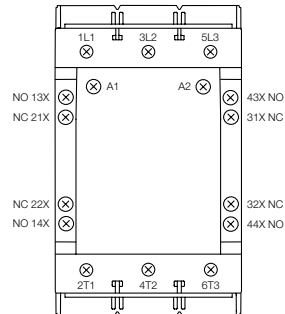

AF116 ... AF370-30-22



AF116 ... AF370-30-11

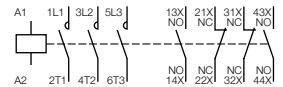

AF116 ... AF370-30-22

# AF400 ... AF2850 3-pole contactors

## Terminal marking and positioning

### AF400 ... AF1250 contactors - AC / DC operated

Standard devices with factory mounted auxiliary contacts

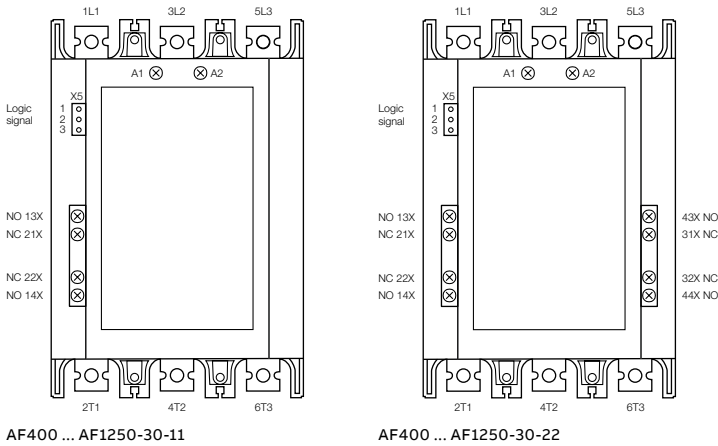

#### Control with logic signal

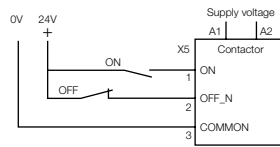

AF400 ... AF1250-30-11, AF400 ... AF1250-30-22

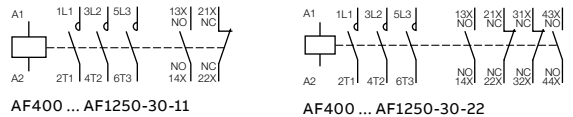

### AF1350 ... AF2850 contactors - AC / DC operated

Standard devices with factory mounted auxiliary contacts

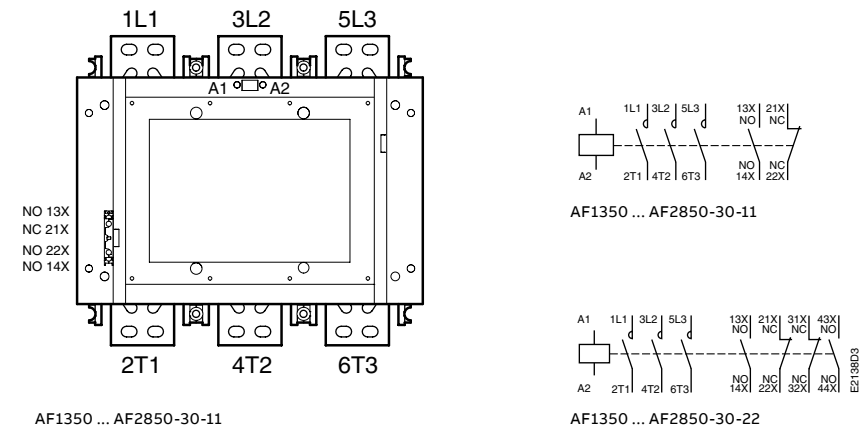

#### Wiring diagrams when used with transistor output

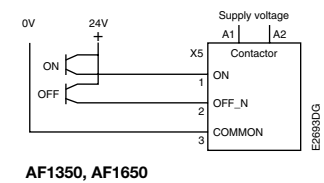

#### when used with transistor output

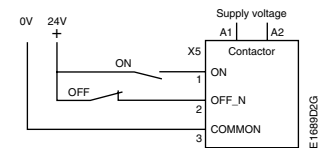

# AFS09 ... AFS750 3-pole contactors for safety applications

Terminal marking and positioning

## AFS09 ... AFS96 contactors - AC / DC operated

Standard devices

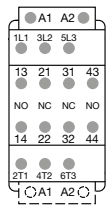

AFS09 ... AFS16...-30-22

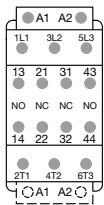

AFS26 ... AFS96...-30-22

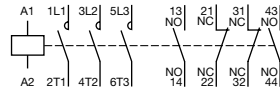

AFS09 ... AFS96...-30-22

## AFS116 ... AFS370 contactors - AC / DC operated

Standard devices with factory mounted auxiliary contacts

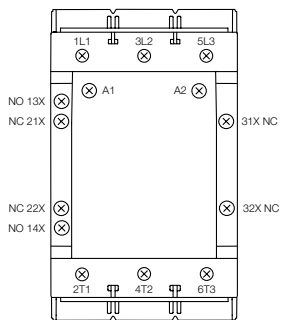

AFS116 ... AFS370-30-12

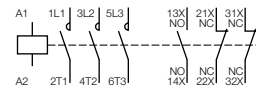

AFS116 ... AFS370-30-12

## AFS400 ... AFS750 contactors - AC / DC operated

Standard devices with factory mounted auxiliary contacts

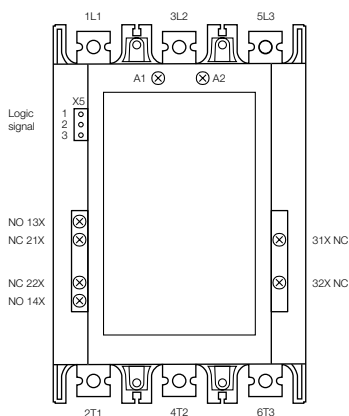

AFS400 ... AFS750-30-12

### Control with logic signal

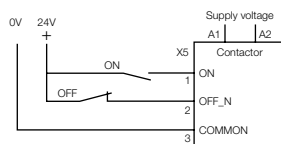

AFS400 ... AFS750-30-12

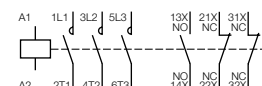

AFS400 ... AFS750-30-12

# AF09 ... AF80 4-pole contactors

## Terminal marking and positioning

### AF09 ... AF38 contactors - AC / DC operated

Standard devices without addition of auxiliary contacts

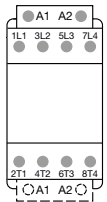

AF09 ... AF80...-40-00

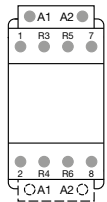

AF09 ... AF40...-22-00  
AF80-22-00

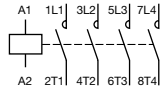

AF09 ... AF80...-40-00

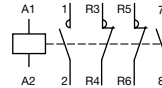

AF09 ... AF40...-22-00  
AF80-22-00

### Other possible contact combinations with auxiliary contacts added by the user

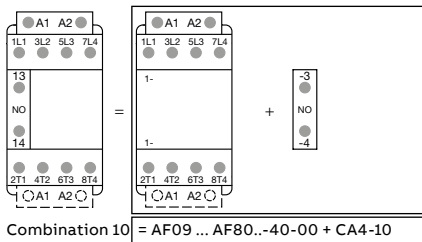

Combination 10 = AF09 ... AF80...-40-00 + CA4-10

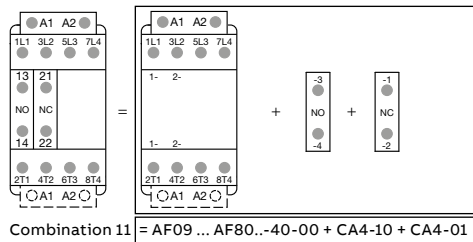

Combination 11 = AF09 ... AF80...-40-00 + CA4-10 + CA4-01

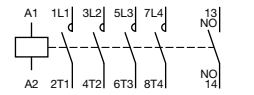

Combination 10

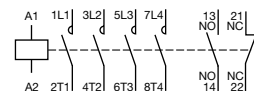

Combination 11

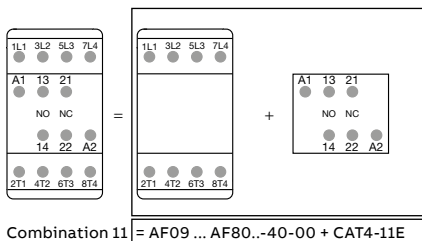

Combination 11 = AF09 ... AF80...-40-00 + CAT4-11E

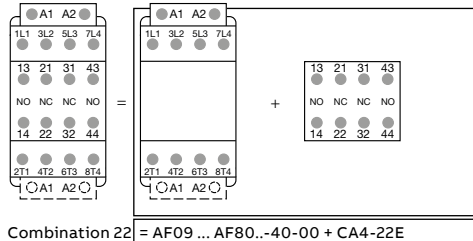

Combination 22 = AF09 ... AF80...-40-00 + CA4-22E

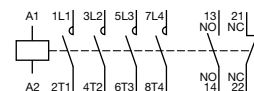

Combination 11

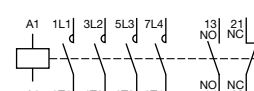

Combination 22

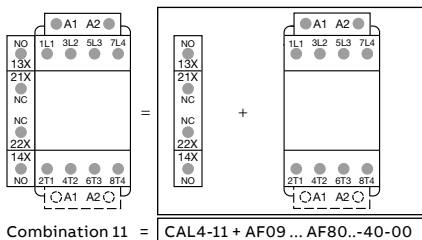

Combination 11 = CAL4-11 + AF09 ... AF80...-40-00

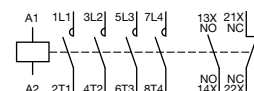

Combination 11

Note: only AF..Z contactor with DC control voltages 12...20 V DC (coil 20) and 24 V DC (coil 30) need to respect the connection polarities indicated close to the coil terminals: A1+ for the positive pole and A2- for the negative pole.

# AF116 ... AF370 4-pole contactors

## Terminal marking and positioning

### AF116 ... AF370 contactors - AC / DC operated

Standard devices without addition of auxiliary contacts

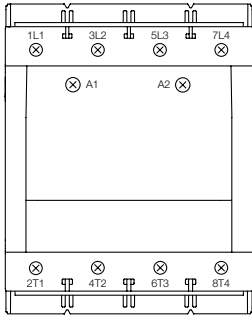

AF116 ... AF370-40-00

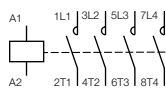

AF116 ... AF370-40-00

### Standard devices with factory mounted auxiliary contacts

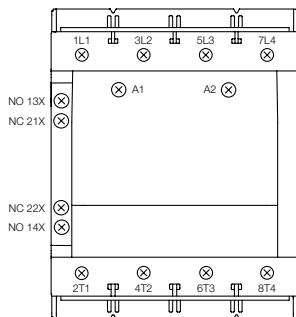

AF116 ... AF370-40-11

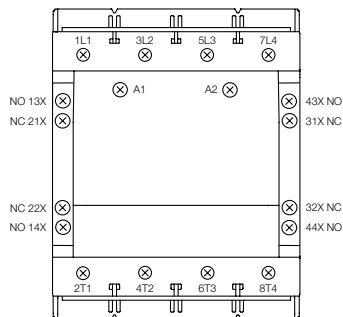

AF116 ... AF370-40-22

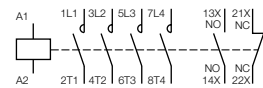

AF116 ... AF370-40-11

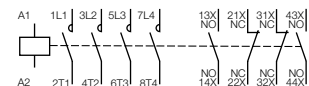

AF116 ... AF370-40-22

# EK 4-pole contactors

## Terminal marking and positioning

### EK550, EK1000 contactors - AC operated

#### Standard devices

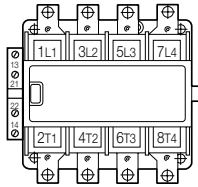

EK550, EK1000-40-11

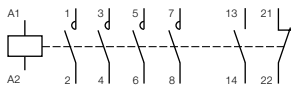

EK550, EK1000-40-11

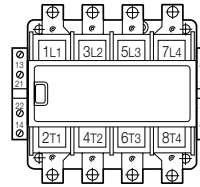

EK550, EK1000-40-22

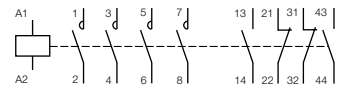

EK550, EK1000-40-22

#### Other possible contact combinations with auxiliary contacts added by the user

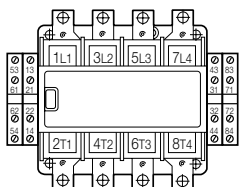

Combination 44

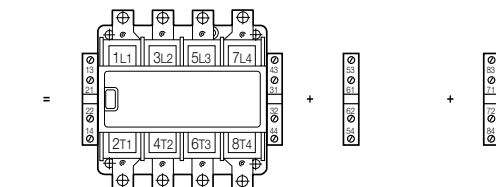

EK550, EK1000-40-22 + CAL16-11C + CAL16-11D

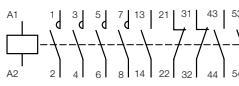

Combination 44

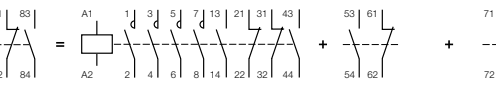

EK550, EK1000-40-22 + CAL16-11C + CAL16-11D

### EK550, EK1000 contactors - with multifrequency coil or DC operated

#### Standard devices

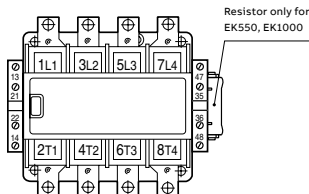

EK550, EK1000-40-21

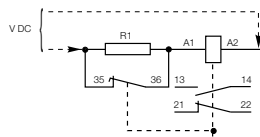

EK550, EK1000 DC operated

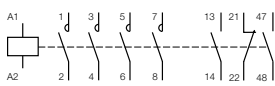

EK550, EK1000-40-21

#### Other possible contact combinations with auxiliary contacts added by the user

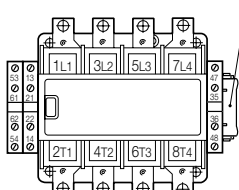

Combination 32

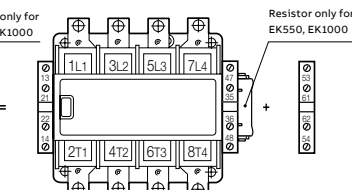

EK550, EK1000-40-21 + CAL16-11C

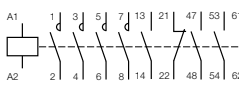

Combination 32

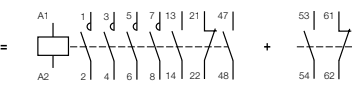

EK550, EK1000-40-21 + CAL16-11C

# UA..RA contactors

## Terminal marking and positioning

### UA..RA contactors - AC operated

Standard devices without addition of auxiliary contacts

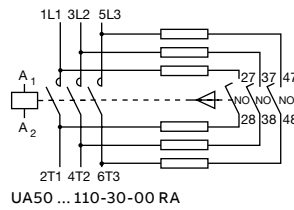
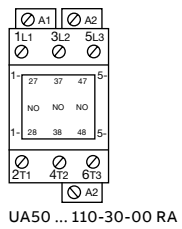
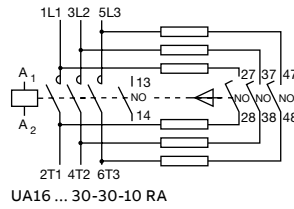
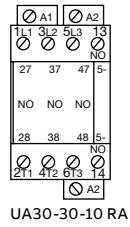
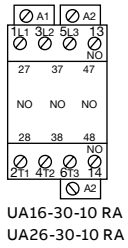



# UA... contactors

## Terminal marking and positioning

03

### UA... contactors - AC operated

Standard devices without addition of auxiliary contacts

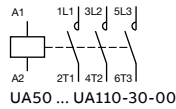
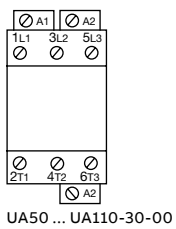
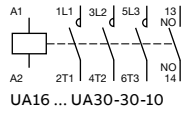
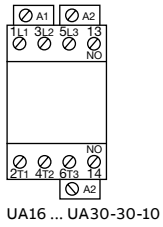

### Standard devices with factory mounted auxiliary contacts

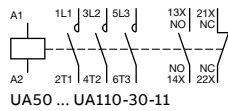
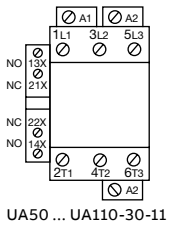

# NF contactor relays

## Terminal marking and positioning

### Standard devices without addition of auxiliary contacts

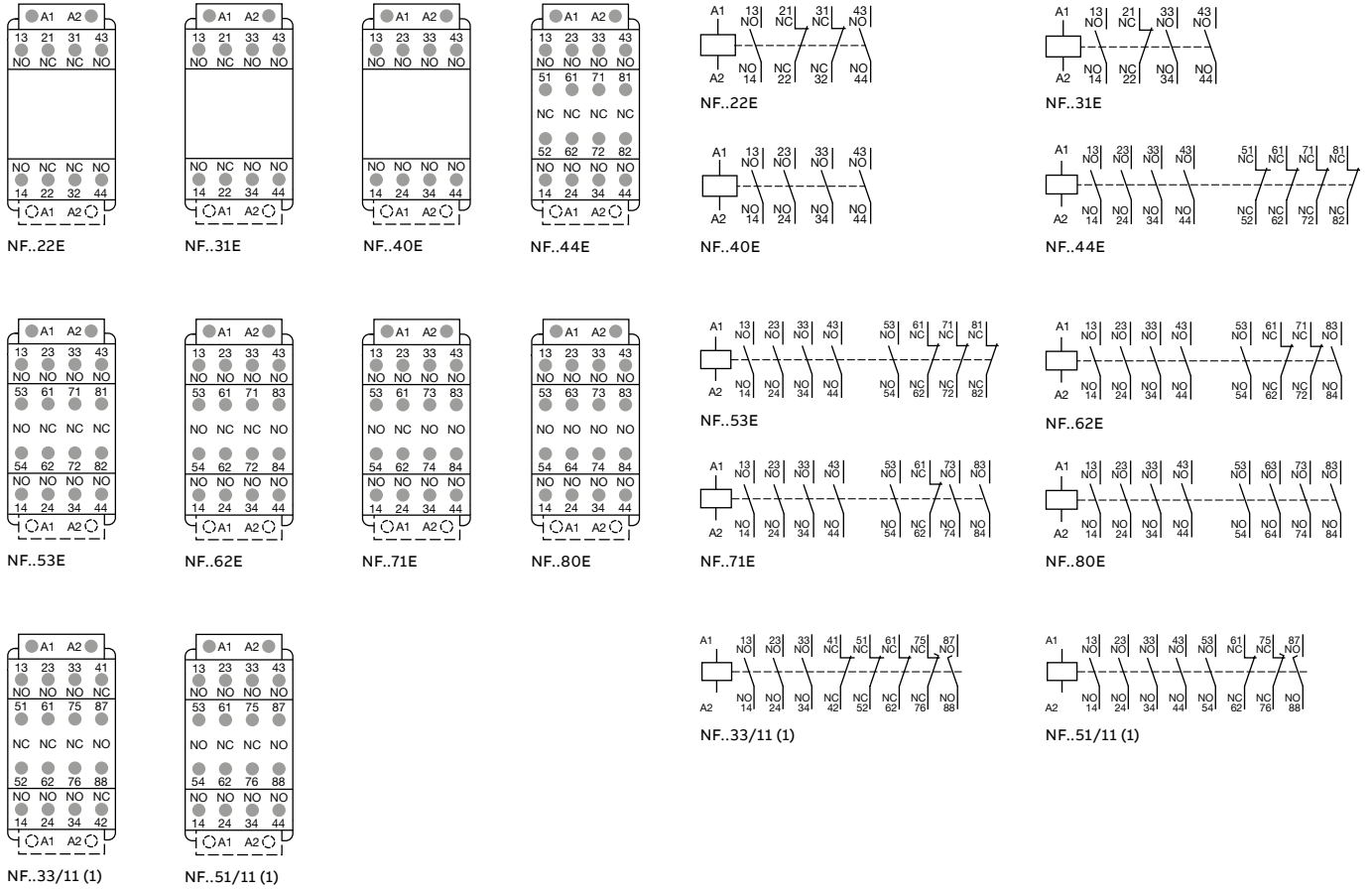

### Other possible contact combinations with auxiliary contacts added by the user

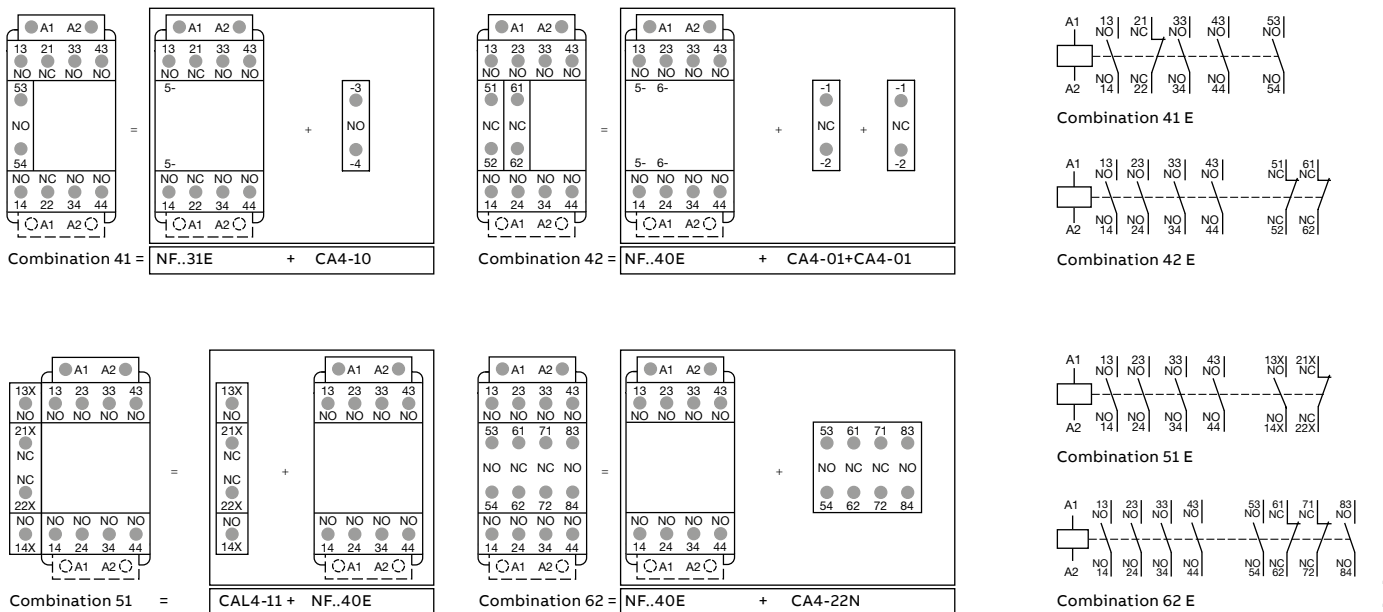

Note: only NFZ contactor relays with DC control voltages 12...20 V DC (coil 20) and 24 V DC (coil 30) need to respect the connection polarities indicated close to the coil terminals: A1+ for the positive pole and A2- for the negative pole.

(1) Not available with Contactor relays with Push-in Spring terminals.

# NF add-on auxiliary contacts

## Terminal marking and positioning

03

### 1-pole auxiliary contacts

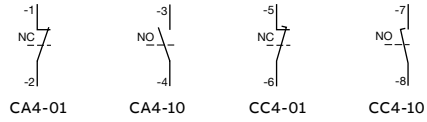

### 2-pole auxiliary contacts

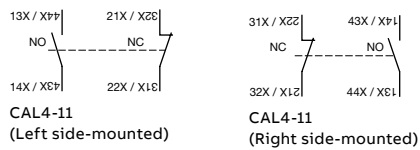

### 4-pole auxiliary contacts

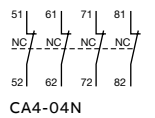
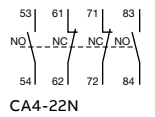
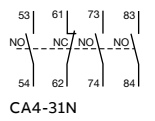
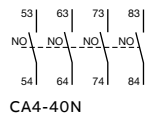
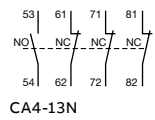

# AF09, AF12, AF16 3-pole contactors

## Dimensions

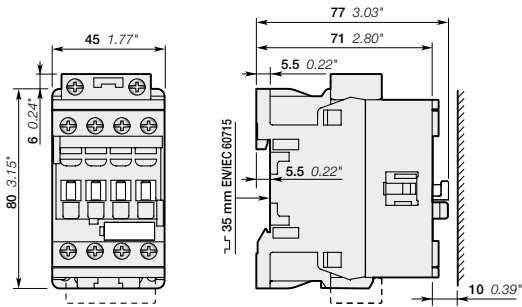

AF09, AF12, AF16

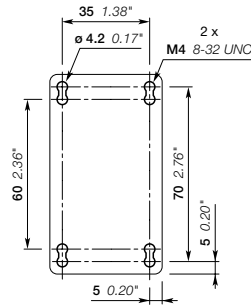

AF09, AF12, AF16

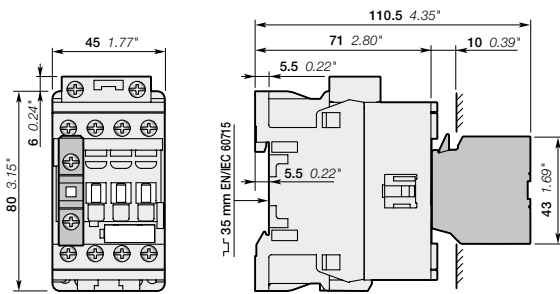

AF09, AF12, AF16  
+ CA4, CC4 1-pole auxiliary contact block

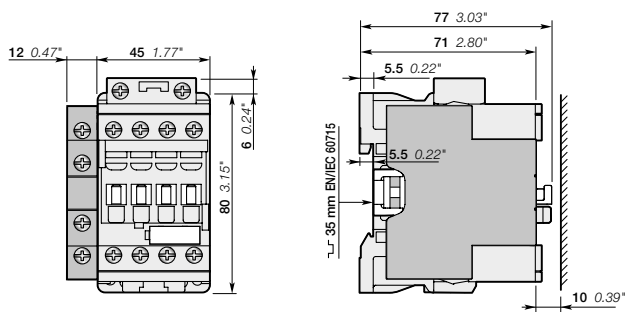

AF09, AF12, AF16  
+ CAL4-11 2-pole auxiliary contact block

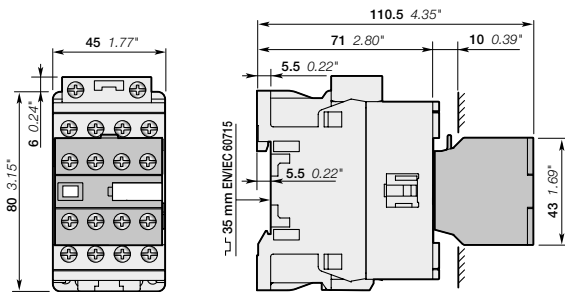

AF09, AF12, AF16  
+ CA4 4-pole auxiliary contact block

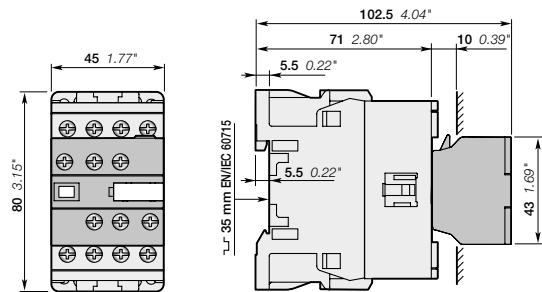

AF09, AF12, AF16  
+ CAT4 2-pole auxiliary contact and coil terminal block

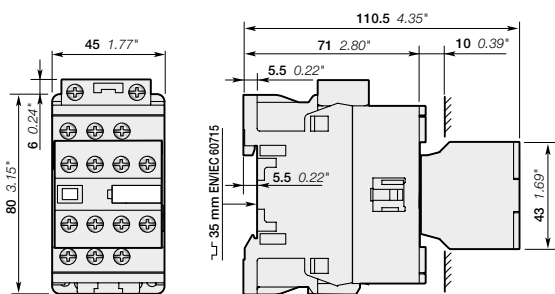

AF09, AF12, AF16...-30-22

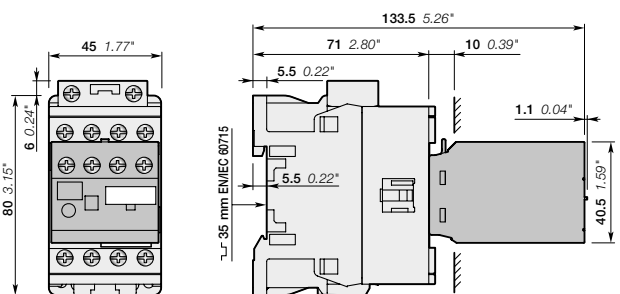

AF09, AF12, AF16  
+ TEF4 electronic timer

(1) Note: For AF09 ... AF16 contactors, lateral distance to grounded component 2 mm 0.08" min.  
24 V DC operated contactor (coil 30) depth + 20 mm + 0.79".

Main dimensions mm, inches (1)

# AF09, AF12, AF16 3-pole contactors

## Dimensions

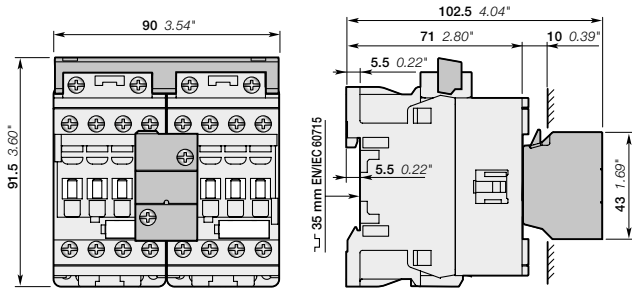

AF09, AF12, AF16  
+ VEM4 mechanical and electrical interlock set

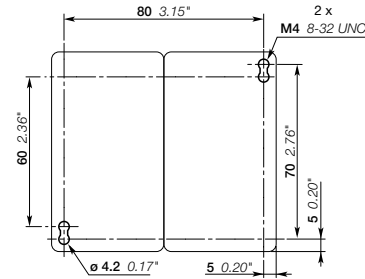

AF09, AF12, AF16  
+ VEM4 mechanical and electrical interlock set

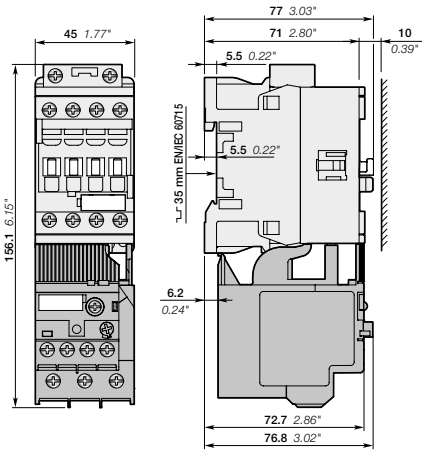

AF09, AF12, AF16  
+ TF42 thermal overload relay

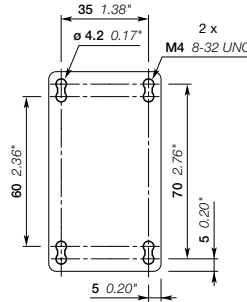

AF09, AF12, AF16  
+ TF42, EF19

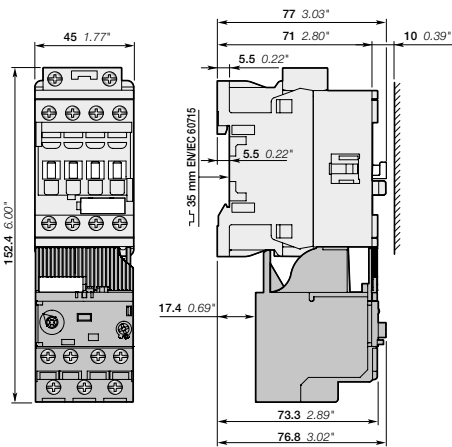

AF09, AF12, AF16 3-pole contactors  
+ EF19 electronic overload relay

(1) Note: For AF09 ... AF16 contactors, lateral distance to grounded component 2 mm 0.08" min.  
24 V DC operated contactor (coil 30) depth + 20 mm + 0.79".

Main dimensions mm, inches (1)

# AF26, AF30, AF38 3-pole contactors

## Dimensions

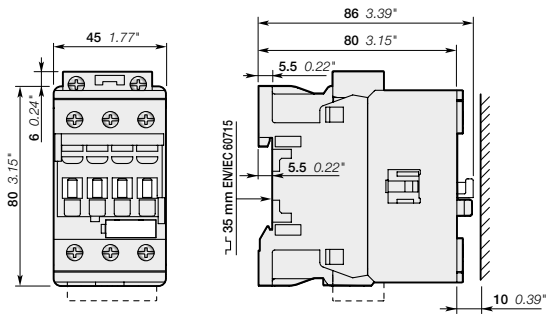

AF26, AF30, AF38

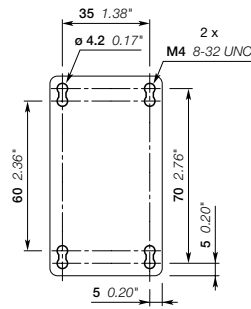

AF26, AF30, AF38

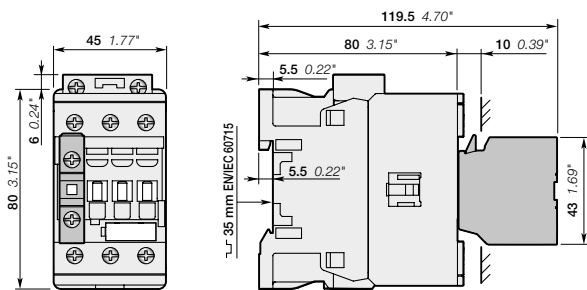

AF26, AF30, AF38  
+ CA4, CC4 1-pole auxiliary contact block

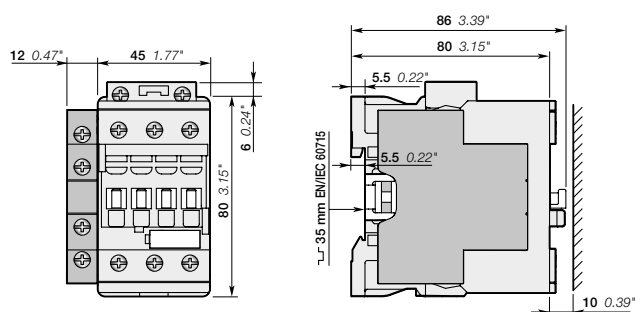

AF26, AF30, AF38  
+ CAL4-11 2-pole auxiliary contact block

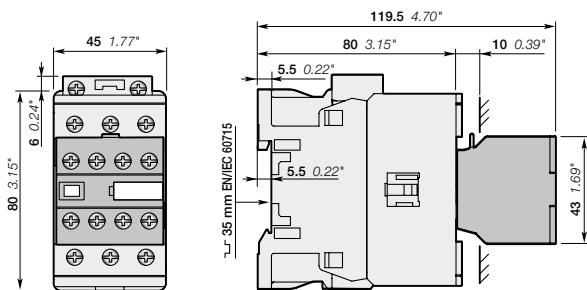

AF26, AF30, AF38  
+ CA4 4-pole auxiliary contact block

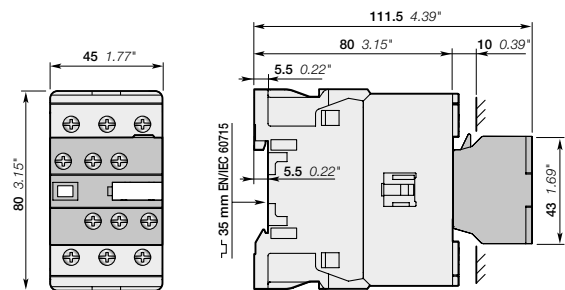

AF26, AF30, AF38  
+ CAT4 2-pole auxiliary contact and coil terminal block

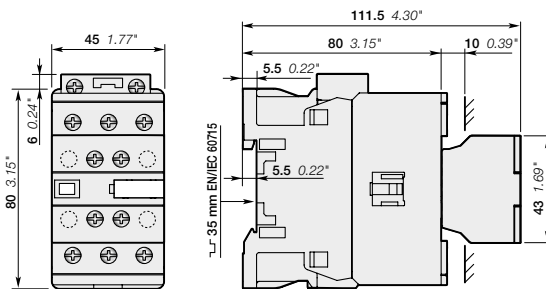

AF26, AF30, AF38...-30-11  
AF26, AF30, AF38...-30-22

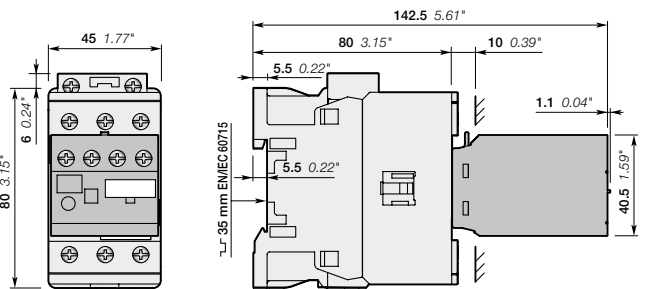

AF26, AF30, AF38  
+ TEF4 electronic timer

(1) Note: For AF26 ... AF38 contactors, lateral distance to grounded component 2 mm (0.08") min. 24 V DC operated contactor (coil 30) depth + 20 mm (+ 0.79").

Main dimensions mm, inches (1)

# AF26, AF30, AF38 3-pole contactors

## Dimensions

30

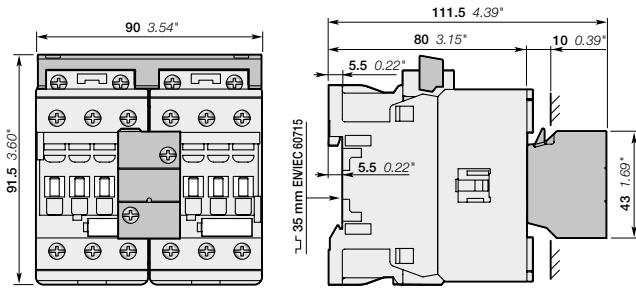

AF26, AF30, AF38  
+ VEM4 mechanical and electrical interlock set

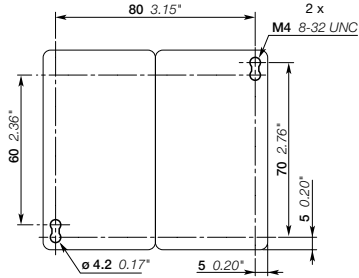

AF26, AF30, AF38  
+ VEM4 mechanical and electrical interlock set

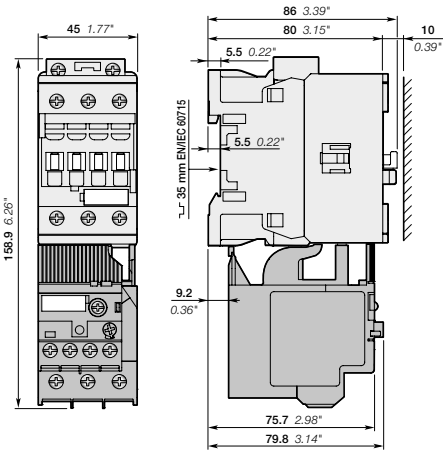

AF26, AF30, AF38  
+ TF42 thermal overload relay

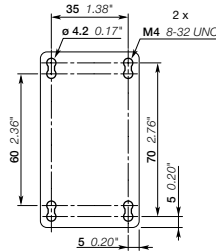

AF26, AF30, AF38  
+ TF42, EF19, EF45

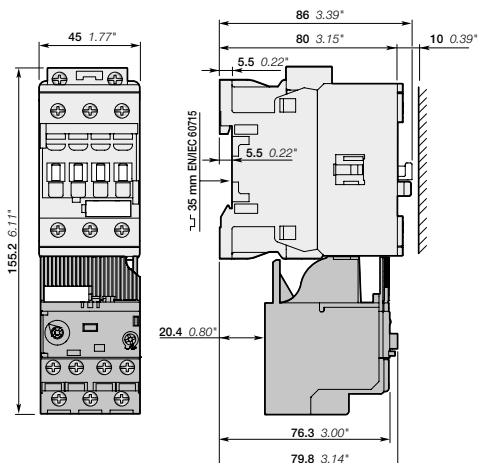

AF26 3-pole contactors  
+ EF19 electronic overload relay

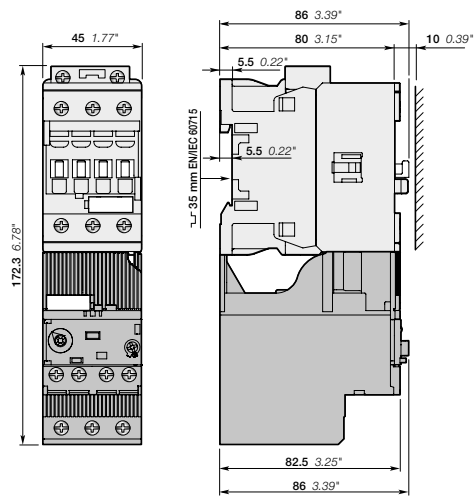

AF26, AF30, AF38 3-pole contactors  
+ EF45 electronic overload relay

(1) Note: For AF26 ... AF38 contactors, lateral distance to grounded component 2 mm (0.08") min.  
24 V DC operated contactor (coil 30) depth + 20 mm (+ 0.79").

Main dimensions mm, inches (1)



# AF40 ... AF65 3-pole contactors

## Dimensions

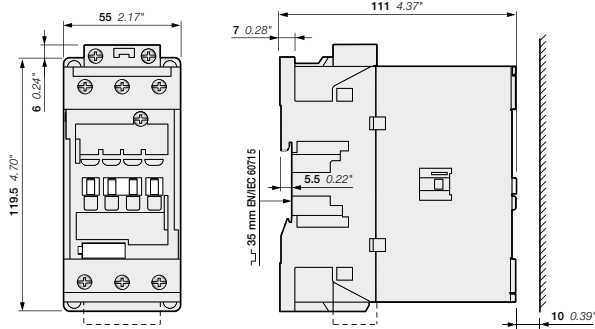

AF40, AF52, AF65

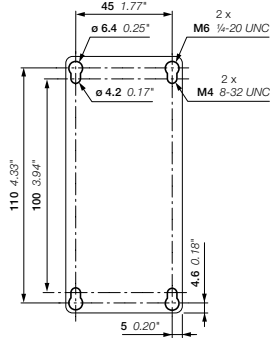

AF40, AF52, AF65

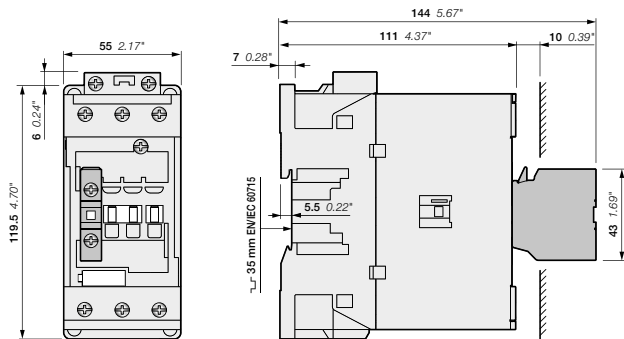

AF40, AF52, AF65  
+ CA4, CC4 1-pole auxiliary contact block

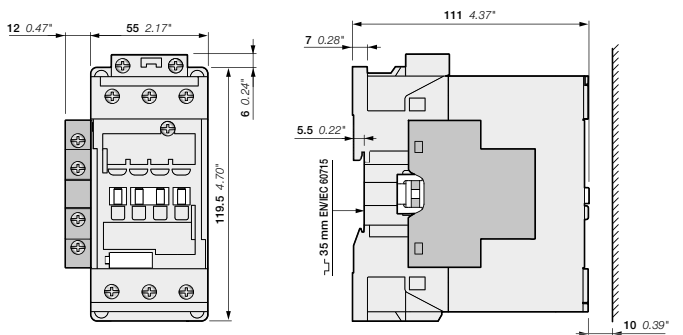

AF40, AF52, AF65-30-00 + CAL4-11 2-pole auxiliary contact block  
AF40, AF52, AF65-30-11

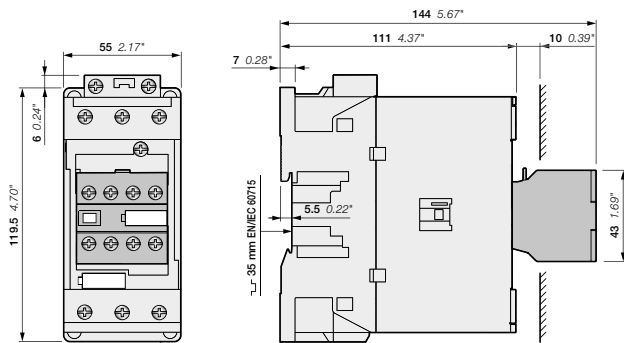

AF40, AF52, AF65  
+ CA4 4-pole auxiliary contact block

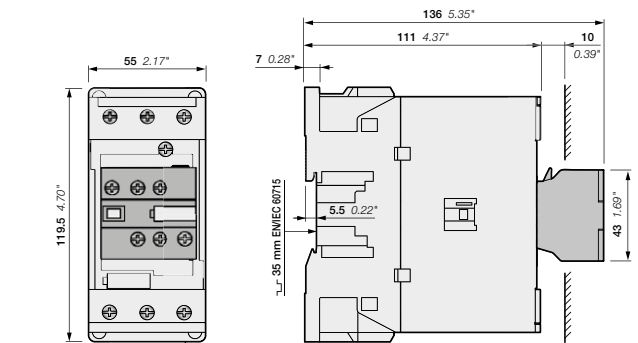

AF40, AF52, AF65  
+ CAT4 2-pole auxiliary contact and coil terminal block

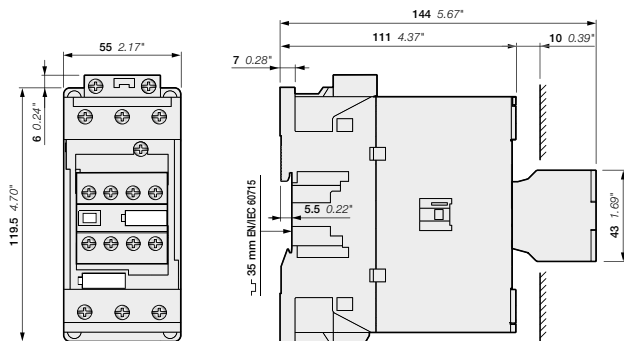

AF40, AF52, AF65...-30-22

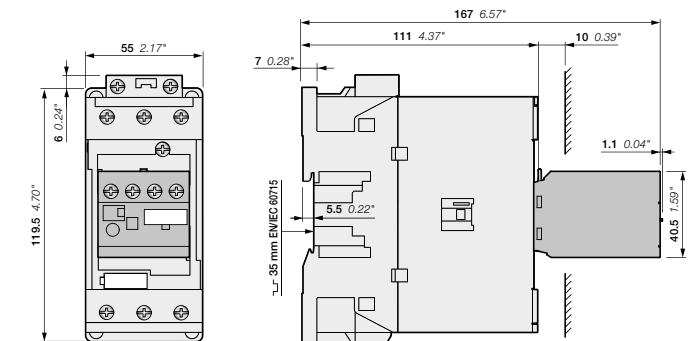

AF40, AF52, AF65  
+ TEF4 electronic timer

Main dimensions mm, inches

# AF40 ... AF65 3-pole contactors

## Dimensions

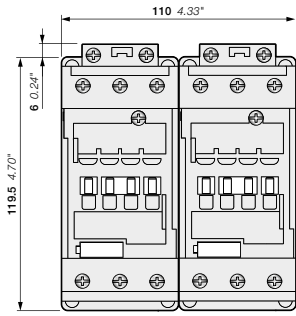

AF40, AF52, AF65  
+ VM96-4 mechanical interlock unit

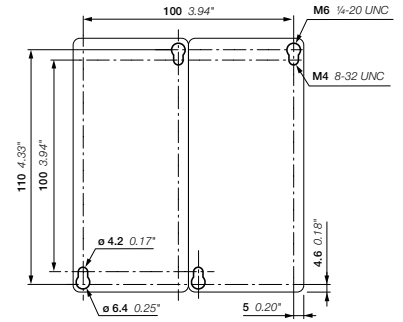
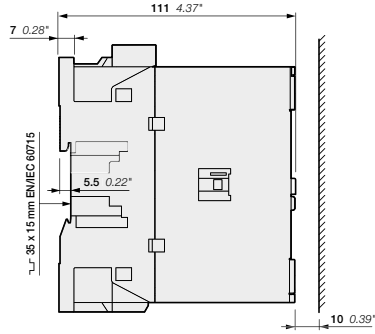

AF40, AF52, AF65  
+ VM96-4 mechanical interlock set

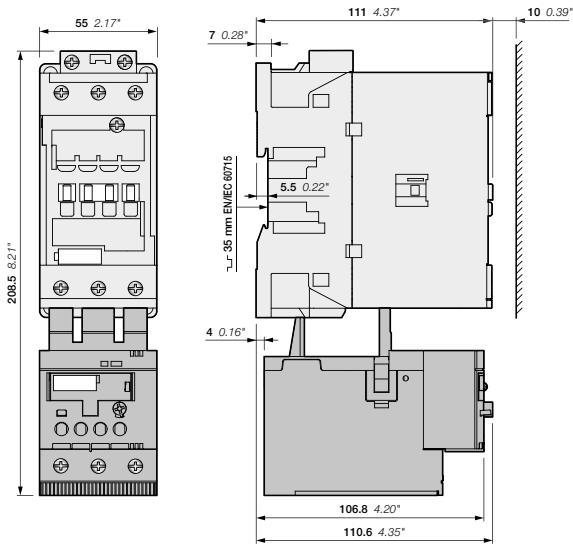

AF40, AF52, AF65  
+ TF65 thermal overload relay

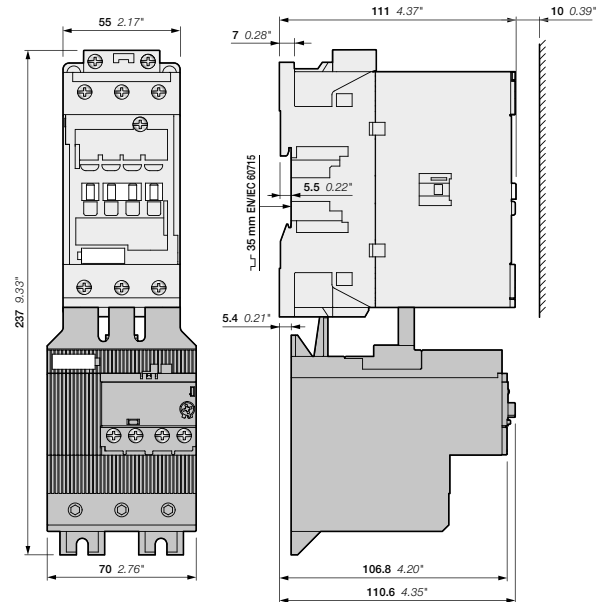

AF40, AF52, AF65  
+ EF65 electronic overload relay

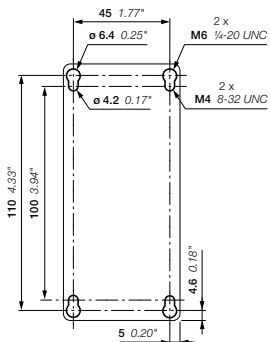

AF40, AF52, AF65  
+ TF65, EF65

Main dimensions mm, inches

# AF80 ... AF96 3-pole contactors

## Dimensions

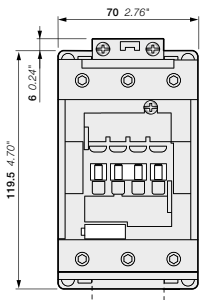

AF80, AF96

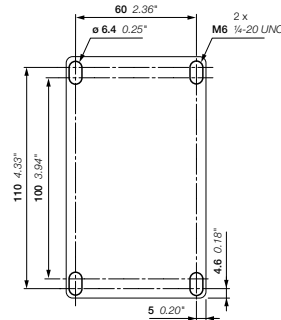
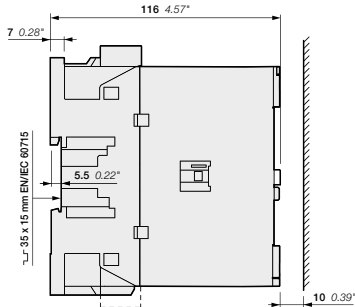

AF80, AF96

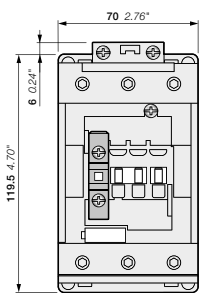

AF80, AF96  
+ CA4, CC4 1-pole auxiliary contact block

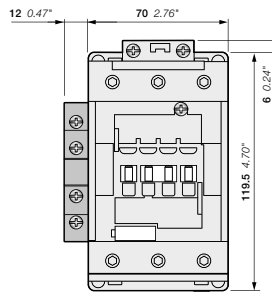
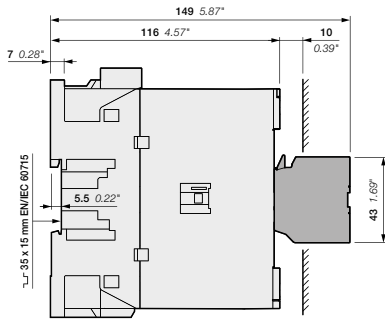

AF80, AF96-30-00 + CAL4-11 2-pole auxiliary contact block  
AF80, AF96-30-11

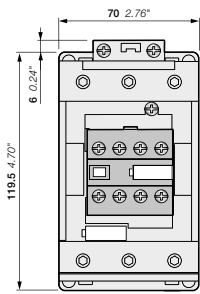
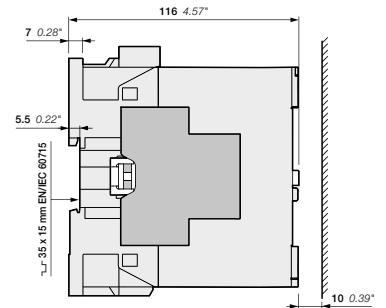

AF80, AF96  
+ CA4 4-pole auxiliary contact block

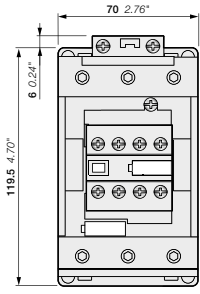
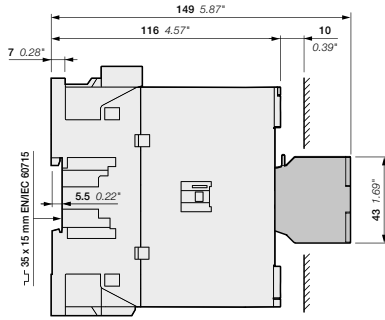

AF80, AF96...-30-22

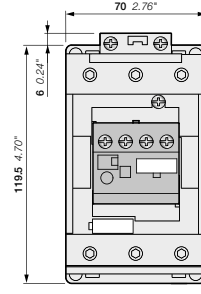
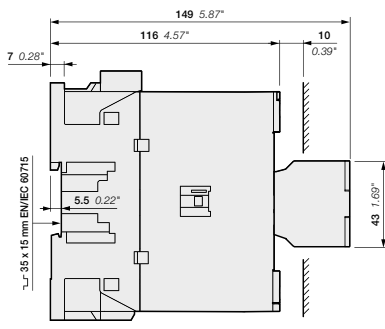

AF80, AF96  
+ TEF4 electronic timer

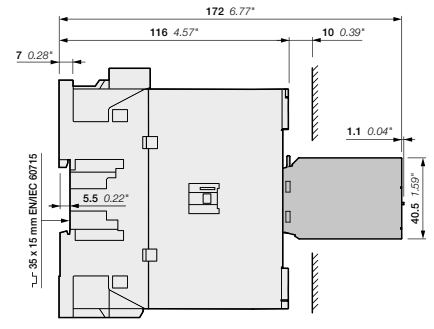

Main dimensions mm, inches

# AF80 ... AF96 3-pole contactors

## Dimensions

30

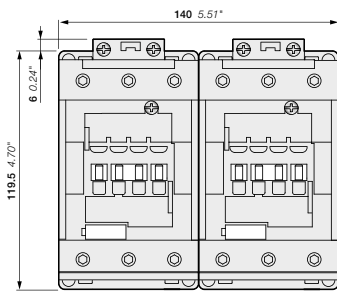

AF80, AF96  
+ VM96-4 mechanical interlock unit

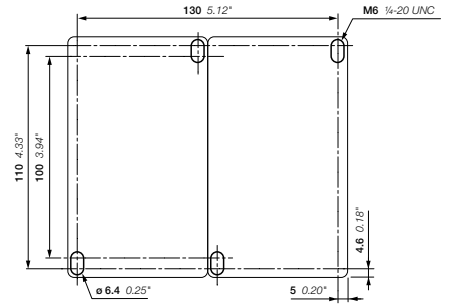
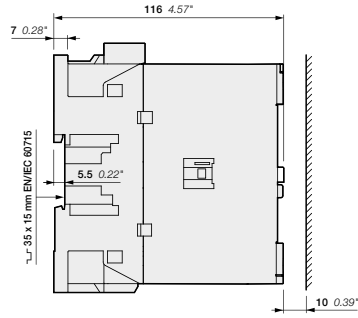

AF80, AF96  
+ VM96-4 mechanical interlock set

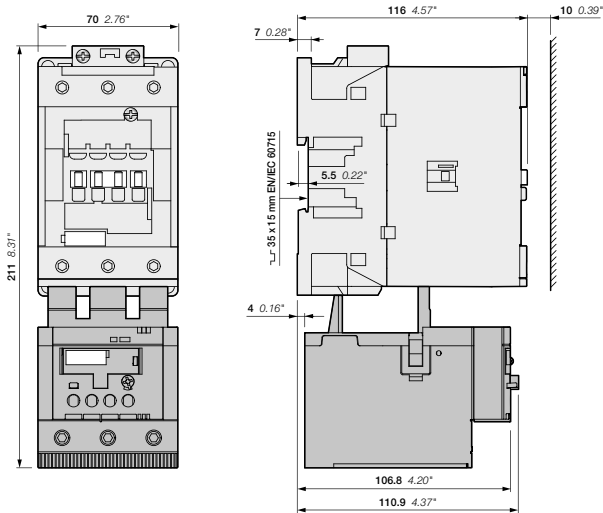

AF80, AF96  
+ TF96 thermal overload relay

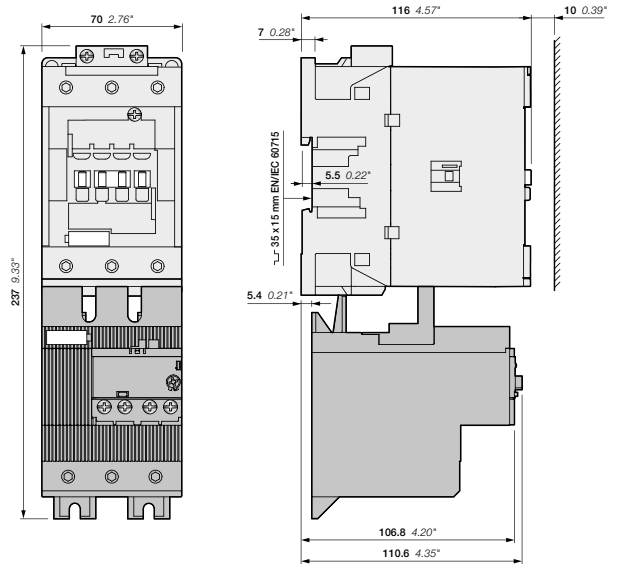

AF80, AF96  
+ EF96 electronic overload relay

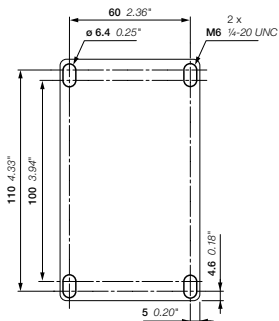

AF80, AF96  
+ TF96, EF96

Main dimensions mm, inches

# AF116, AF140, AF146 3-pole contactors

## Dimensions

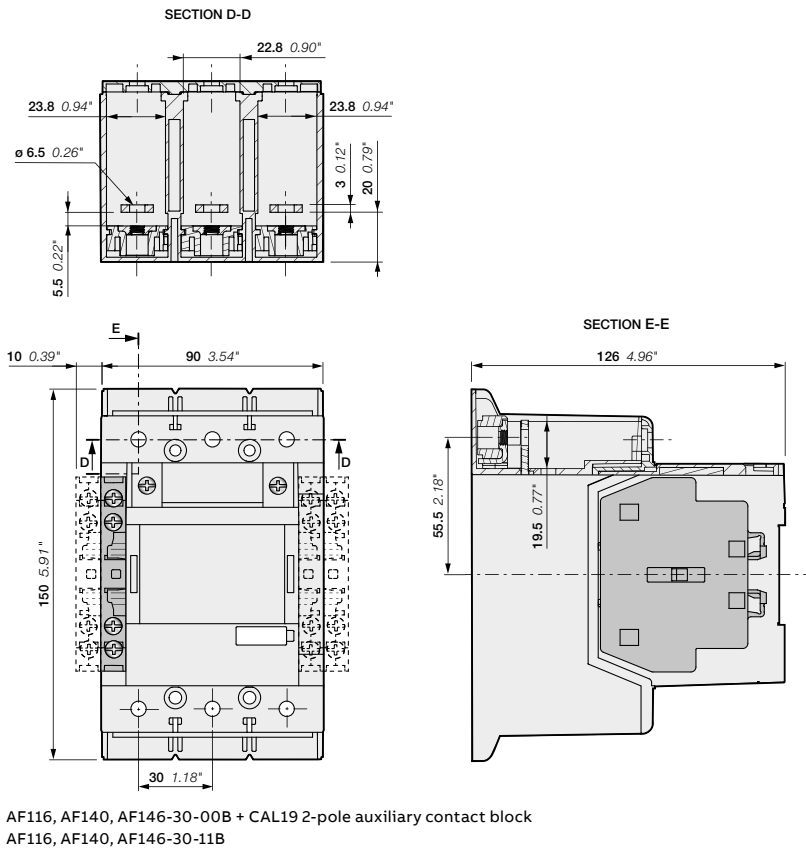
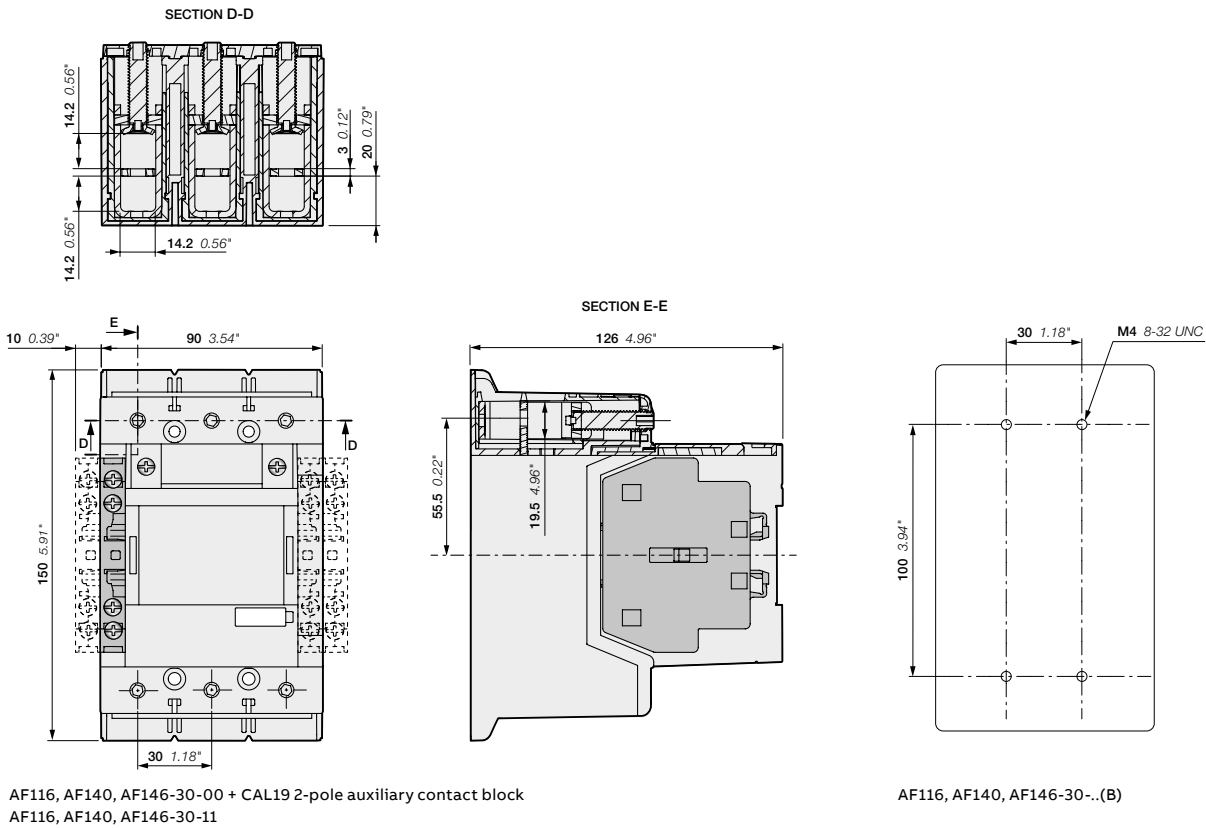

Main dimensions mm, inches

# AF116, AF140, AF146 3-pole contactors With built-in PLC interface (coil code 33, 34)

## Dimensions

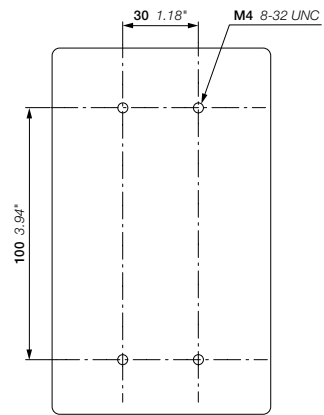
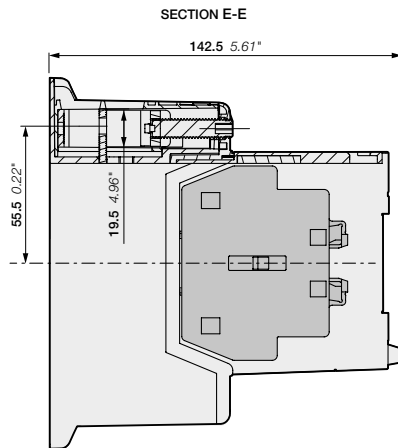
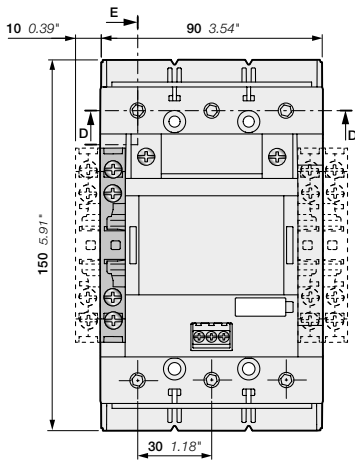
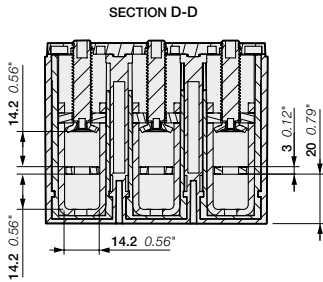

AF116, AF140, AF146-30-00 + CAL19 2-pole auxiliary contact block  
AF116, AF140, AF146-30-11

AF116, AF140, AF146-30-...(B)

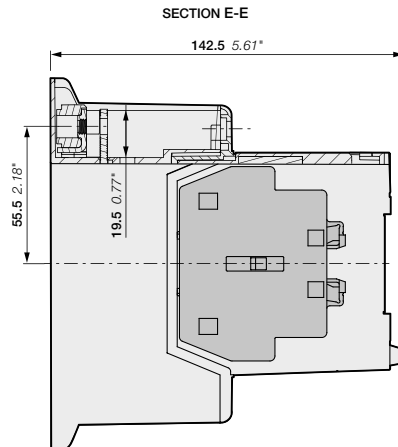
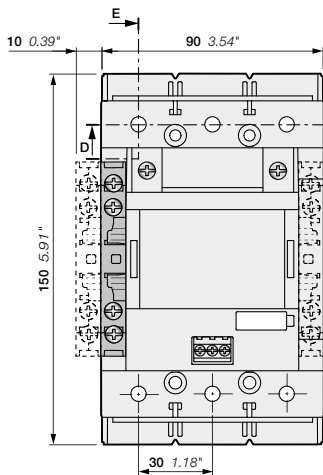
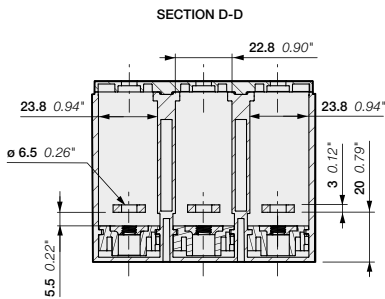

AF116, AF140, AF146-30-00B + CAL19 2-pole auxiliary contact block  
AF116, AF140, AF146-30-11B

Main dimensions mm, inches

# AF116, AF140, AF146 3-pole contactors

## Dimensions

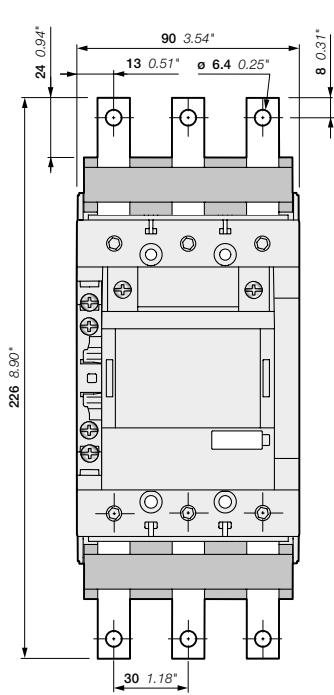

AF116, AF140, AF146-30-11  
+ LX140 terminal extension

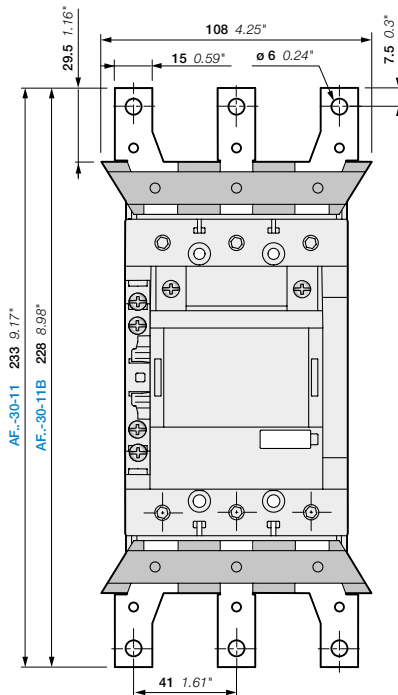

AF116, AF140, AF146-30-11(B)  
+ LW140(B) terminal enlargement

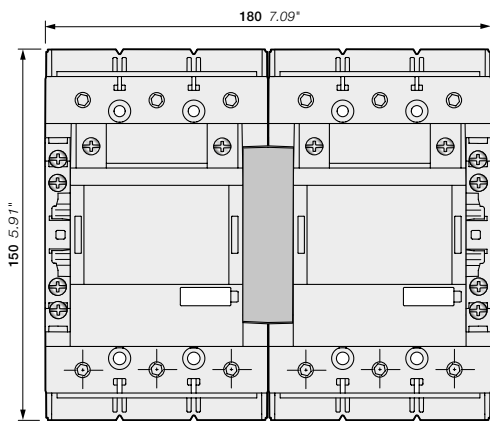
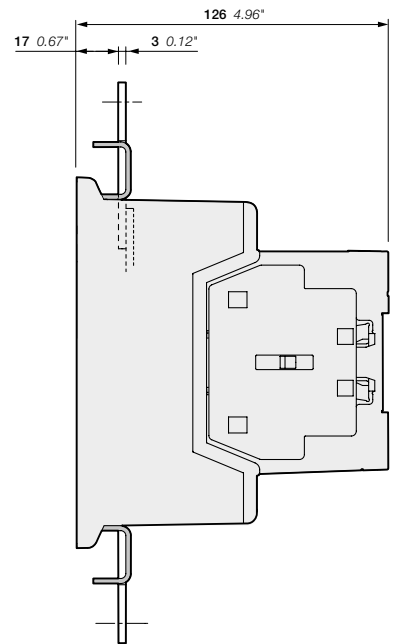

AF116, AF140, AF146-30-11(B)  
+ VM19 mechanical interlocking unit

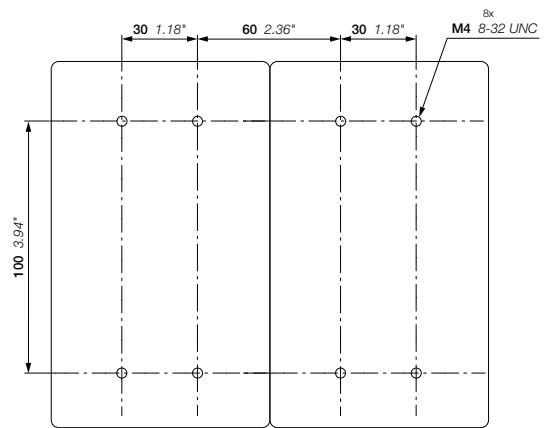
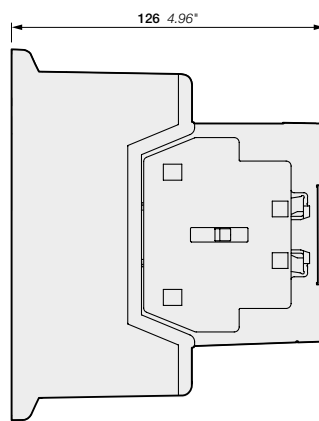

AF116, AF140, AF146-30-11(B)  
+ VM19 mechanical interlocking unit

Main dimensions mm, inches



# AF116, AF140, AF146 3-pole contactors

## Dimensions

E3

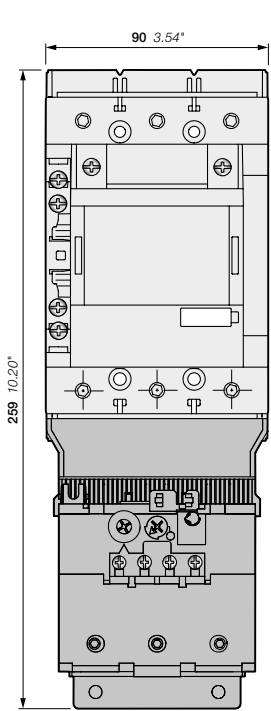

AF116, AF140-30-11(B)  
+ TF140 thermal overload relay

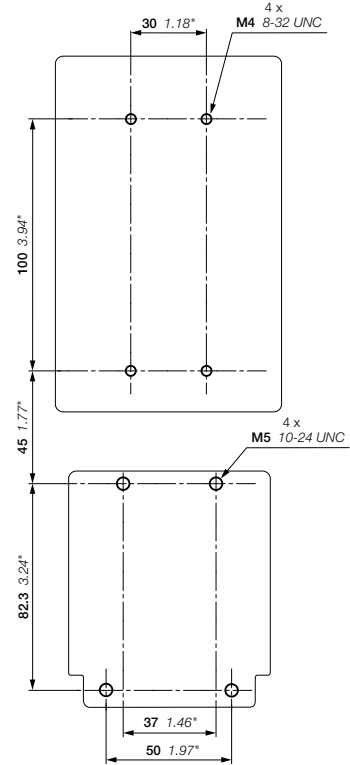
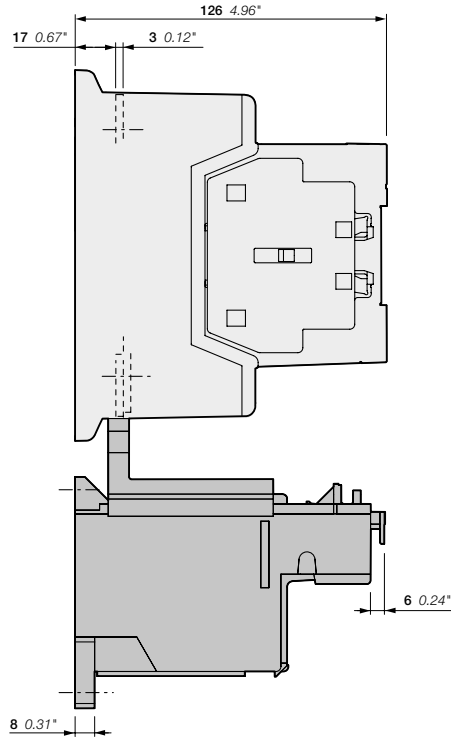

AF116, AF140-30-11(B)  
+ TF140 thermal overload relay

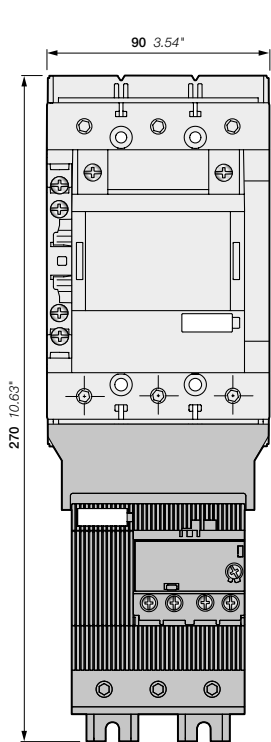

AF116, AF140, AF146-30-11(B)  
+ EF146 electronic overload relay

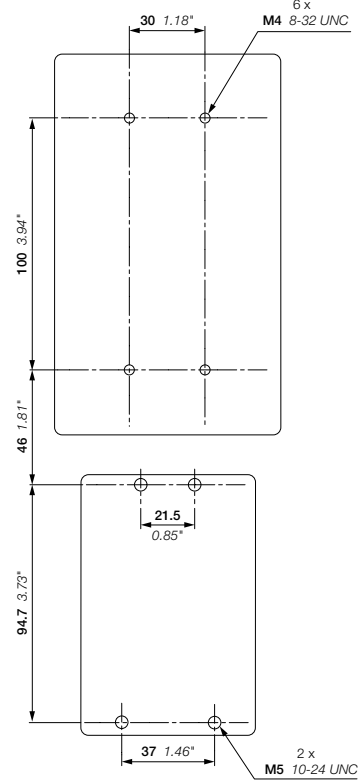
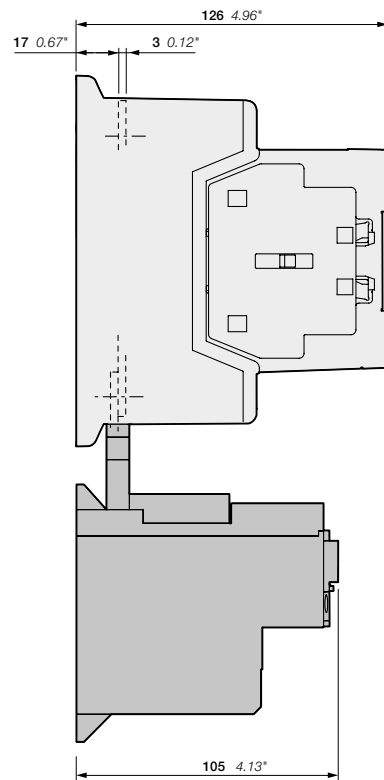

AF116, AF140, AF146-30-11(B)  
+ EF146 electronic overload relay

Main dimensions mm, inches

# AF190, AF205 3-pole contactors

## Dimensions

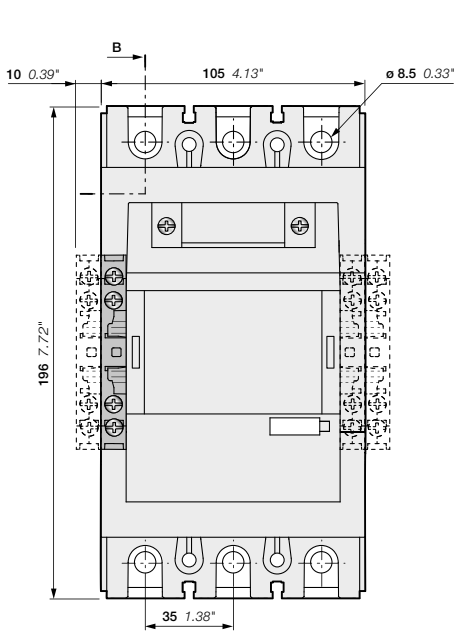

AF190, AF205-30-00 + CAL19 2-pole auxiliary contact block  
AF190, AF205-30-11

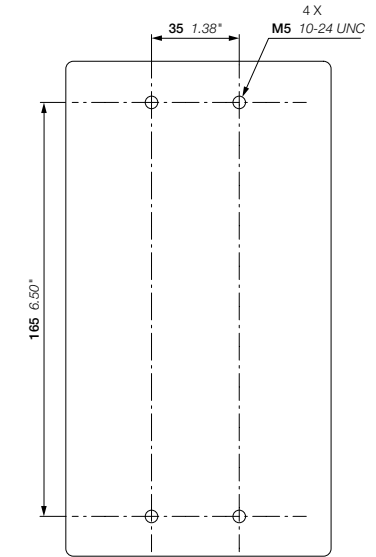
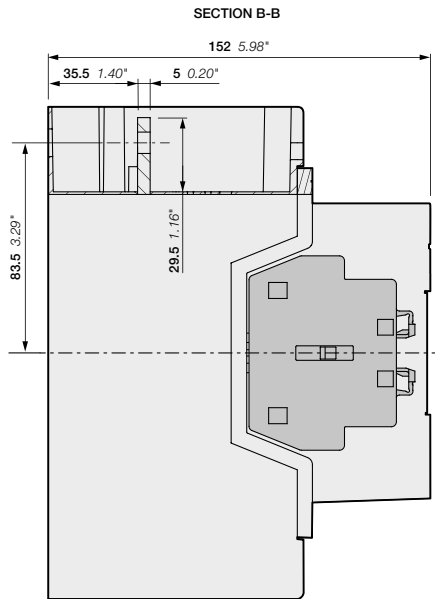

AF190, AF205

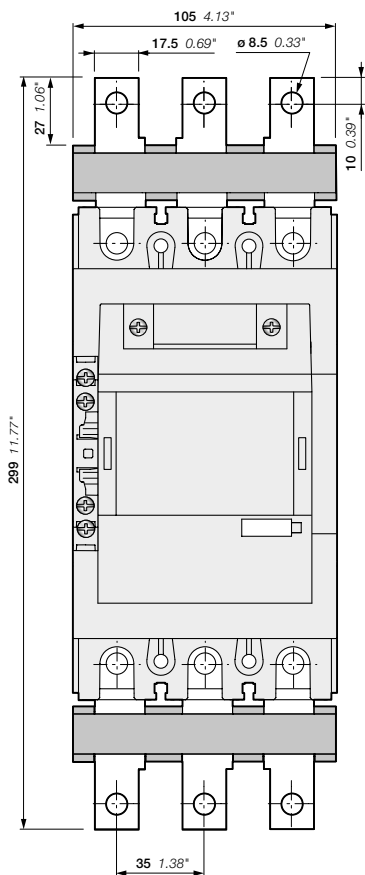

AF190, AF205-30-11  
+ LX205 terminal extension

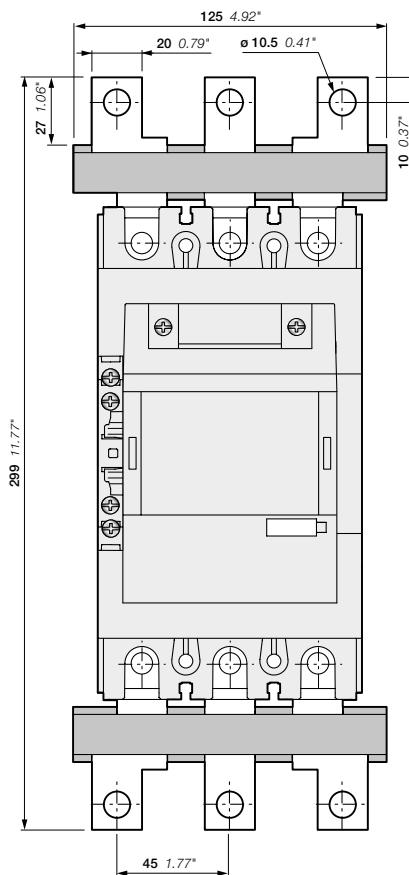

AF190, AF205-30-11  
+ LW205 terminal enlargement

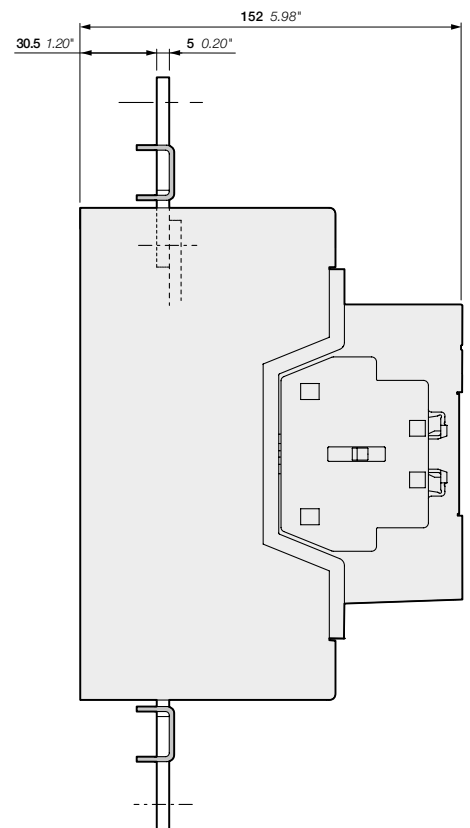

Main dimensions mm, inches

# AF190, AF205 3-pole contactors With built-in PLC interface (coil code 33, 34)

## Dimensions

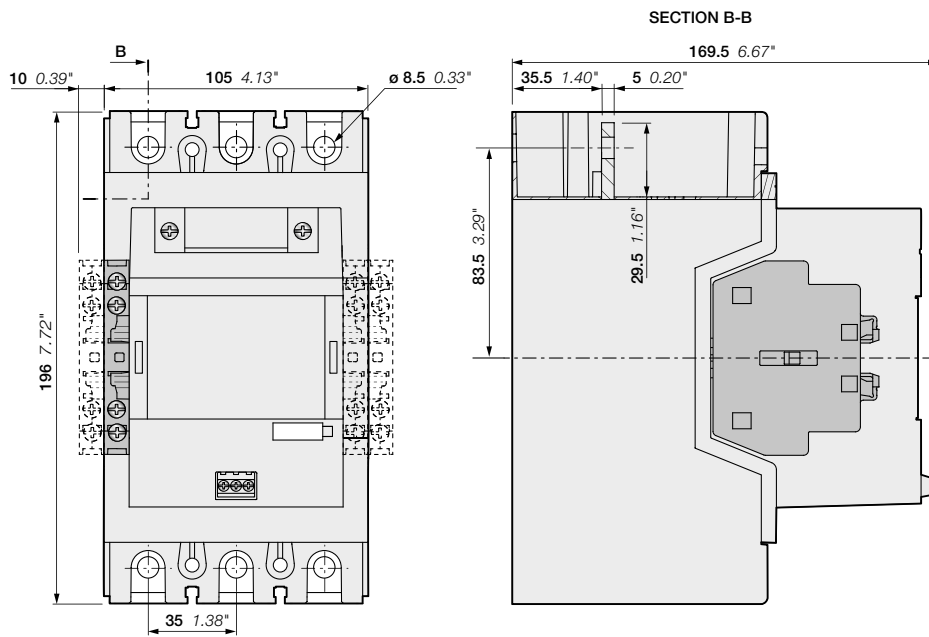

AF190, AF205-30-00 + CAL19 2-pole auxiliary contact block  
 AF190, AF205-30-11

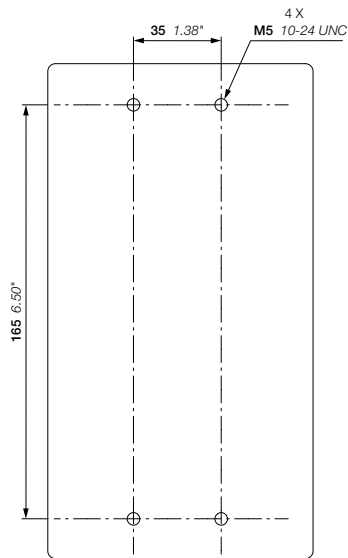

AF190, AF205

Main dimensions mm, inches

# AF190, AF205 3-pole contactors

## Dimensions

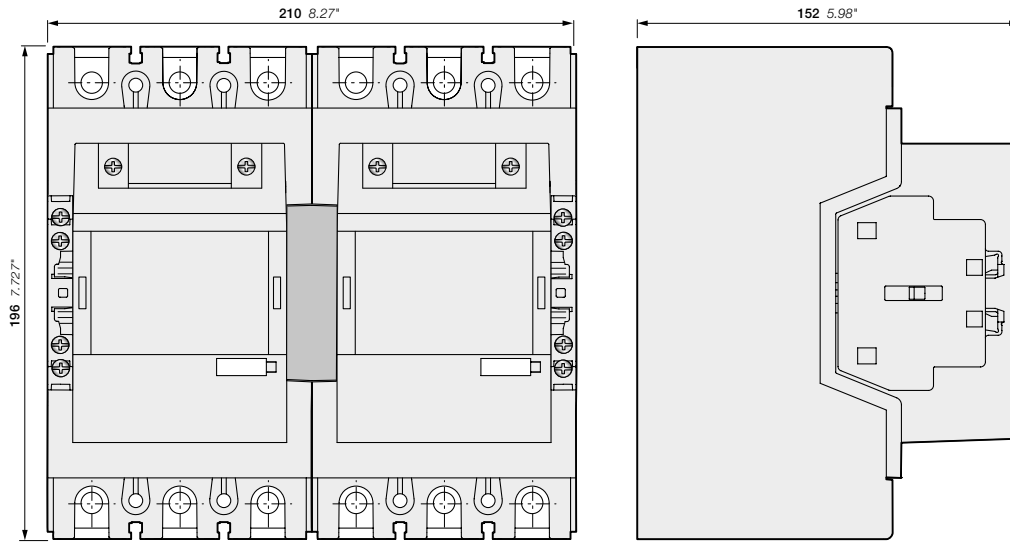

AF190, AF205-30-11  
+ VM19 mechanical interlocking unit

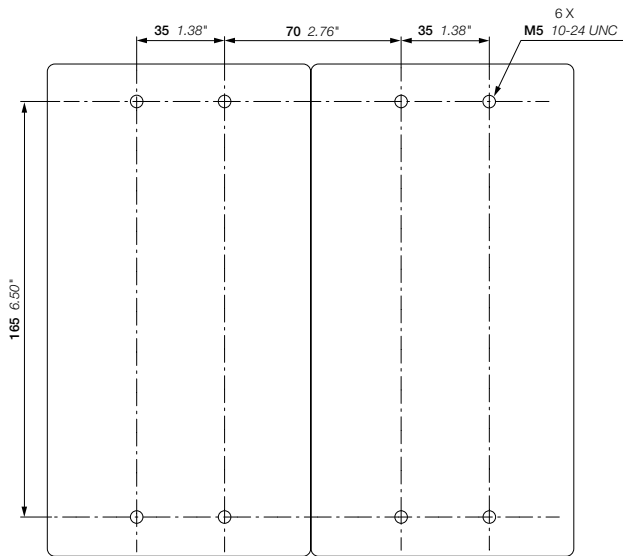

AF190, AF205  
+ VM19 mechanical interlocking unit

Main dimensions mm, inches

# AF190, AF205 3-pole contactors

## Dimensions

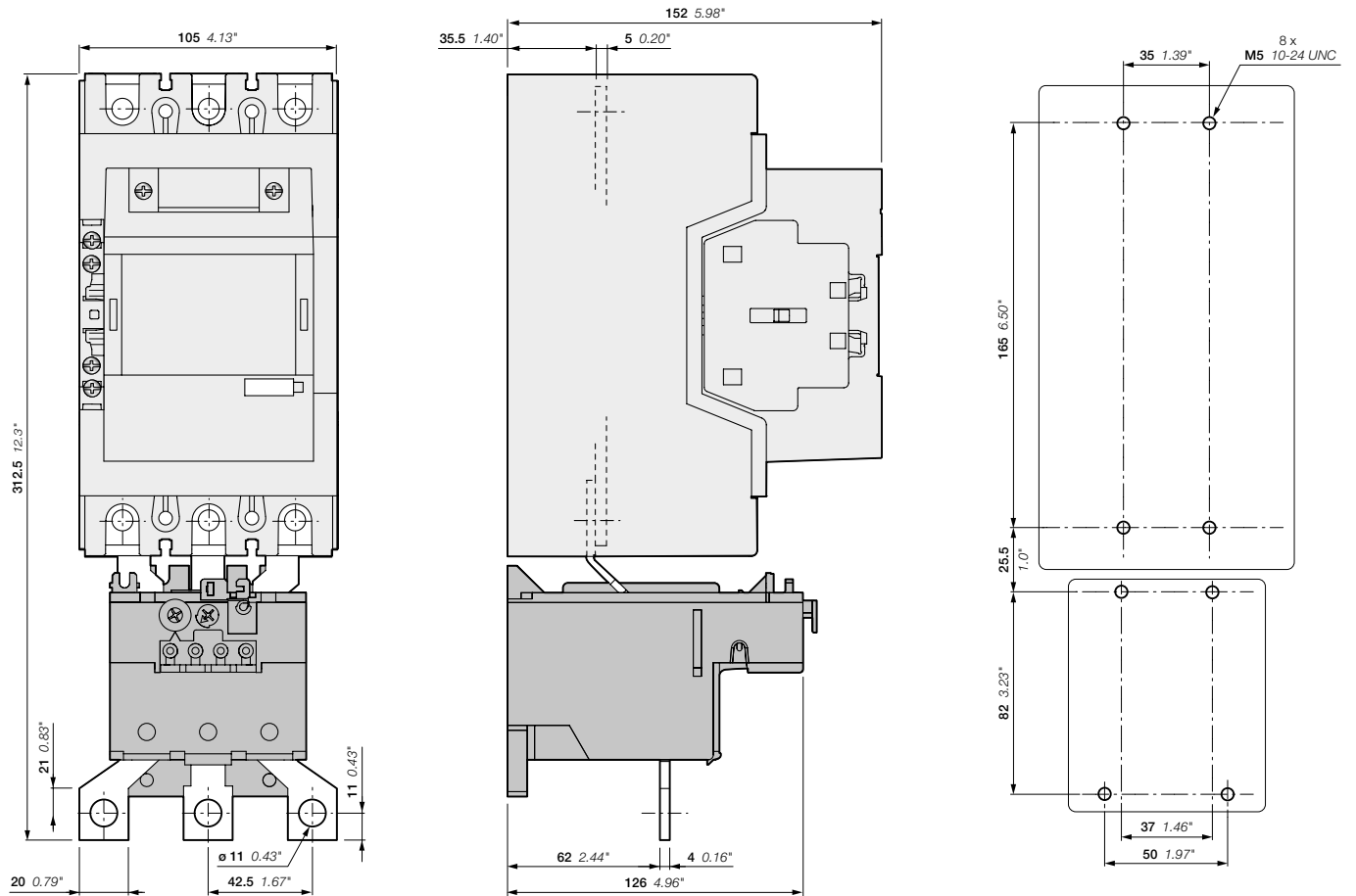

AF190, AF205-30-11  
+ TA200DU thermal overload relay

AF190, AF205  
+ TA200DU thermal overload relay

Main dimensions mm, inches

# AF190, AF205 3-pole contactors

## Dimensions

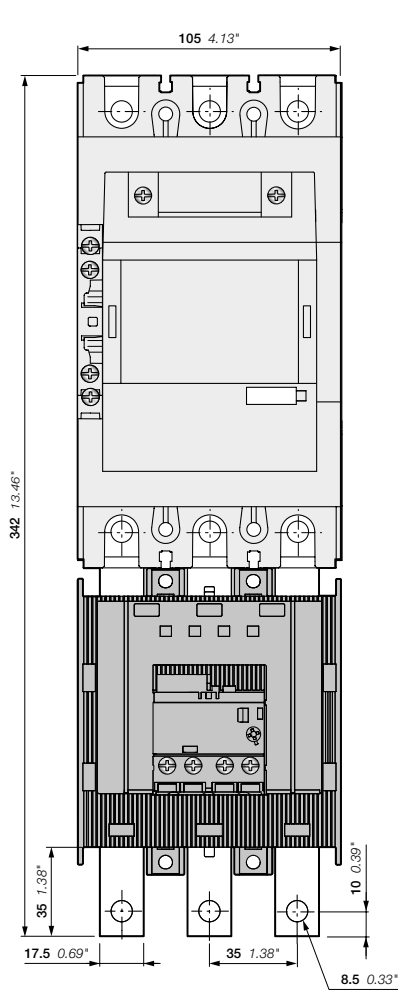

AF190, AF205-30-11  
+ EF205 electronic overload relay

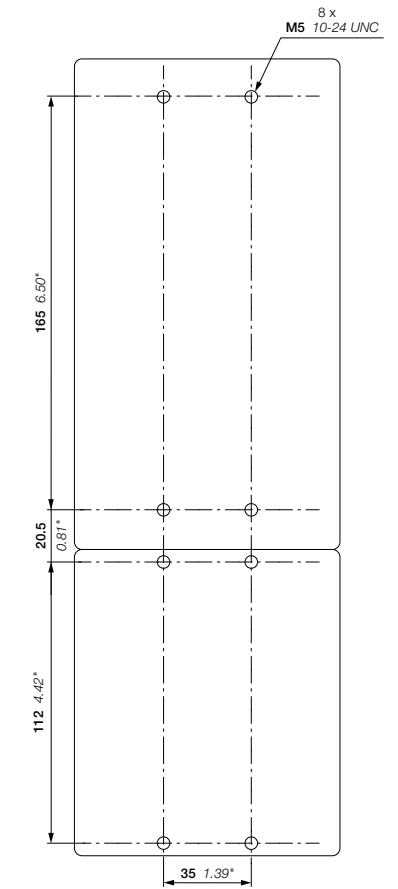
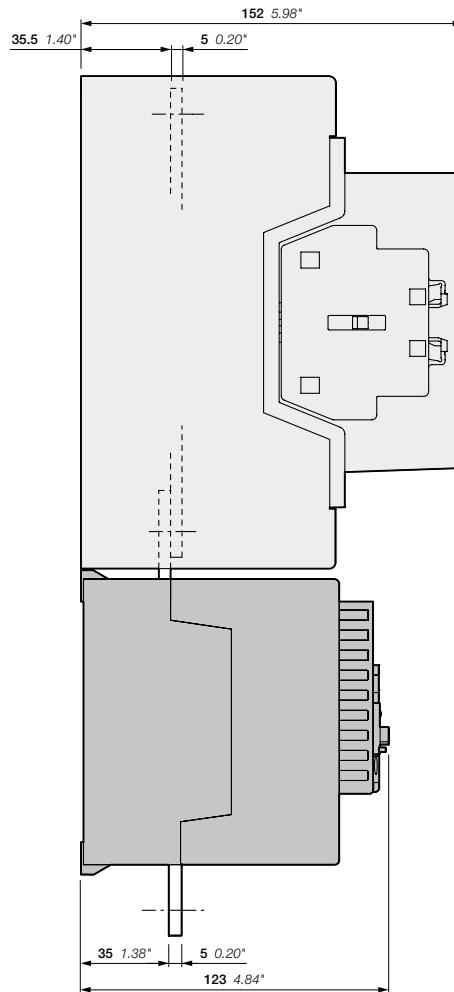

AF190, AF205  
+ EF205 electronic overload relay

Main dimensions mm, inches

# AF265, AF305, AF370 3-pole contactors

## Dimensions

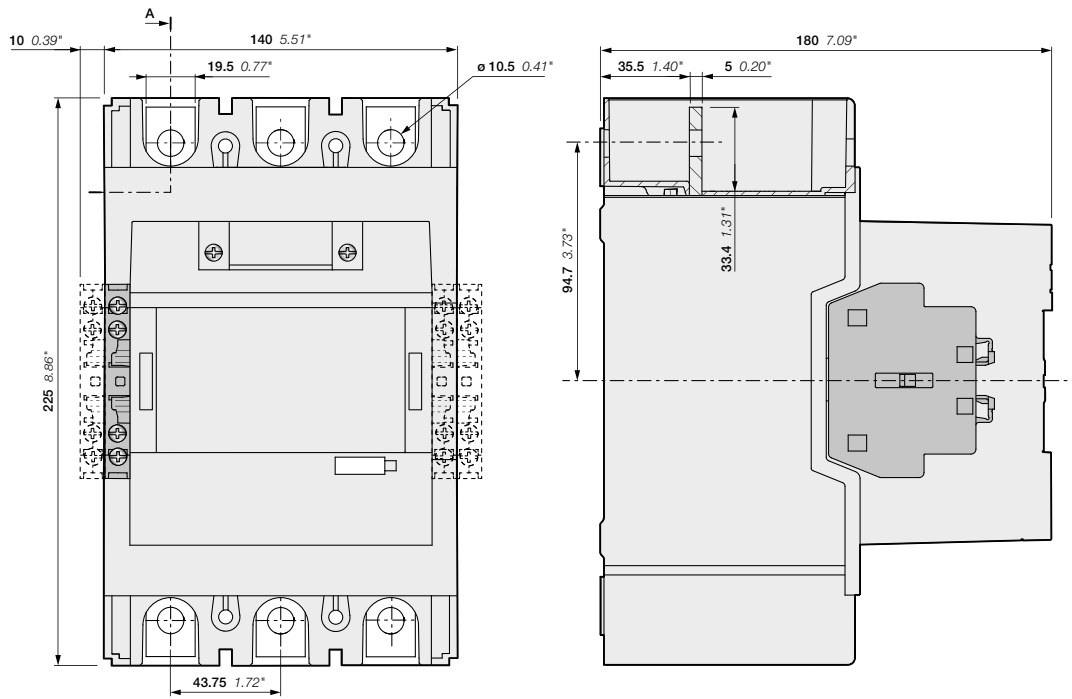

AF265, AF305, AF370-30-00 + CAL19 2-pole contact block  
 AF265, AF305, AF370-30-11

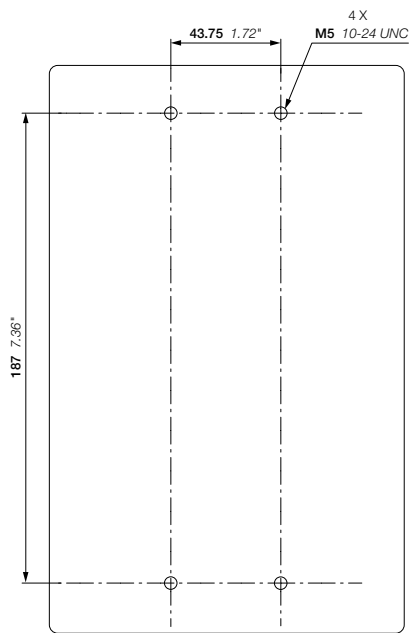

AF265, AF305, AF370

Main dimensions mm, inches



# AF265, AF305, AF370 3-pole contactors with built-in PLC interface (coil code 33, 34)

## Dimensions

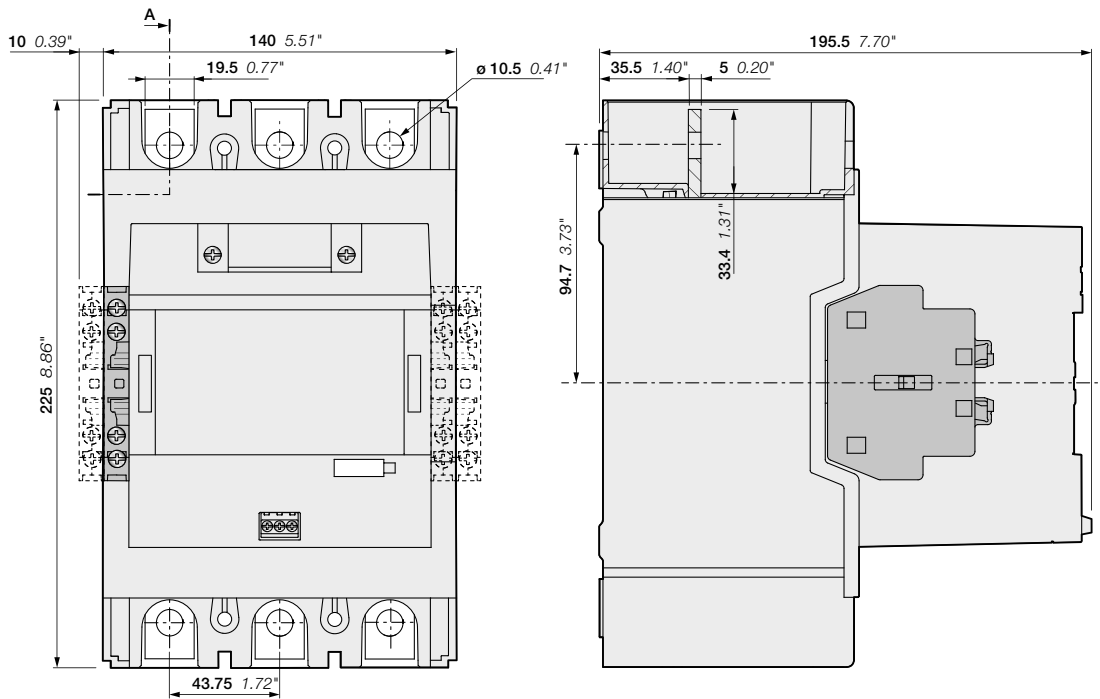

AF265, AF305, AF370-30-00 + CAL19 2-pole contact block  
 AF265, AF305, AF370-30-11

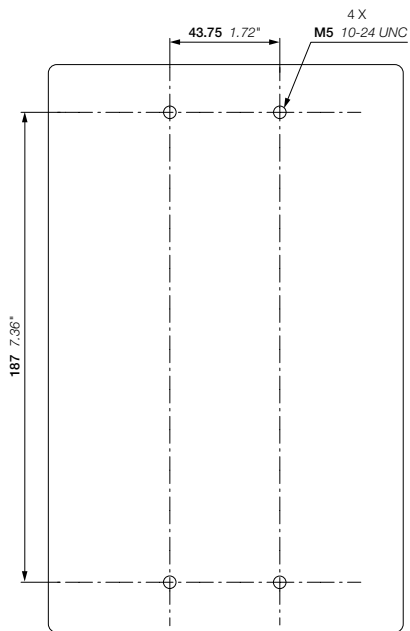

AF265, AF305, AF370

Main dimensions mm, inches

# AF265, AF305, AF370 3-pole contactors

## Dimensions

E0

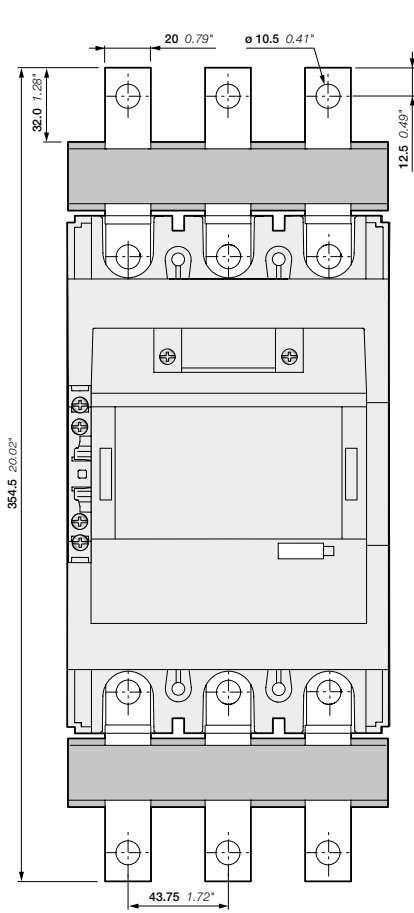

AF265, AF305, AF370-30-11  
+ LX370 terminal extension

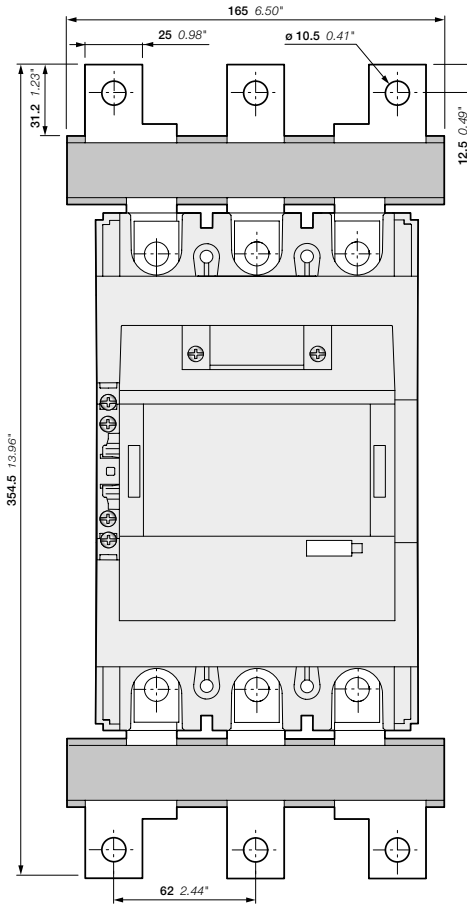

AF265, AF305, AF370-30-11  
+ LW370 terminal enlargement

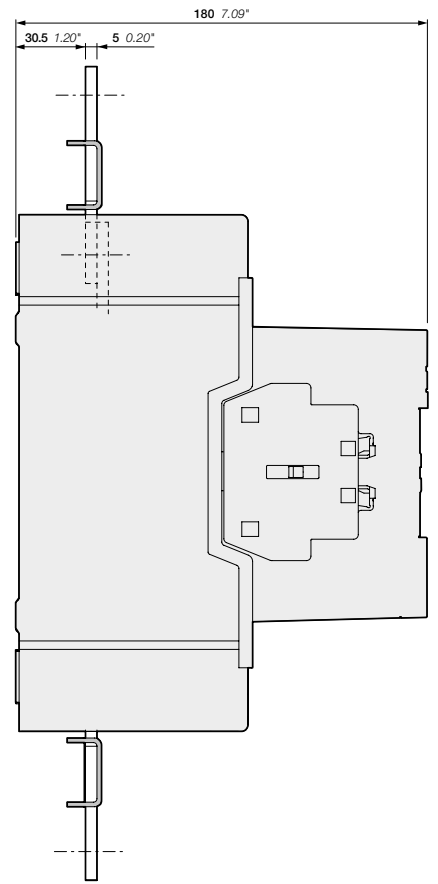

Main dimensions mm, inches

# AF265, AF305, AF370 3-pole contactors

## Dimensions

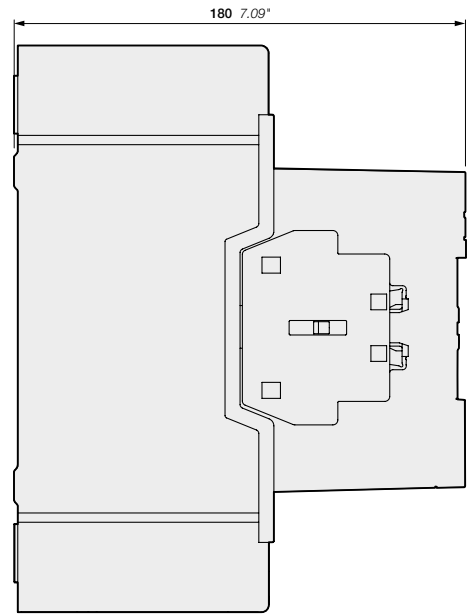
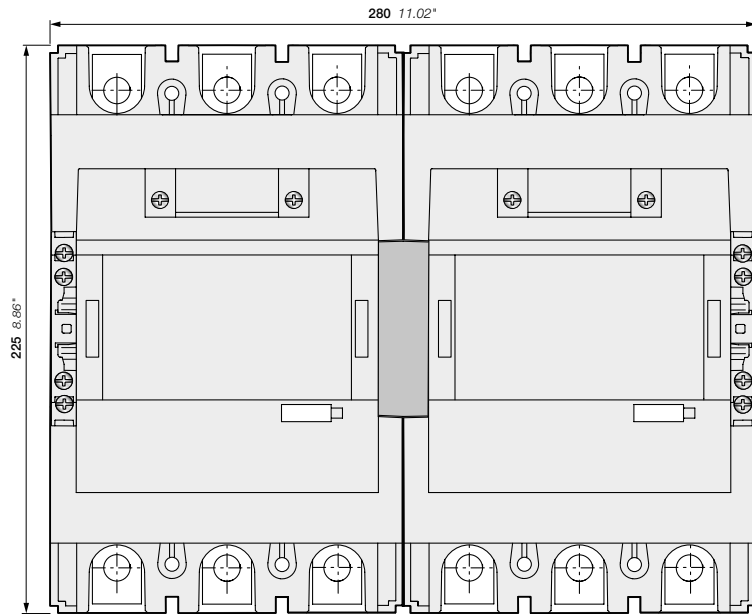

AF265, AF305, AF370-30-11  
+ VM19 mechanical interlocking unit

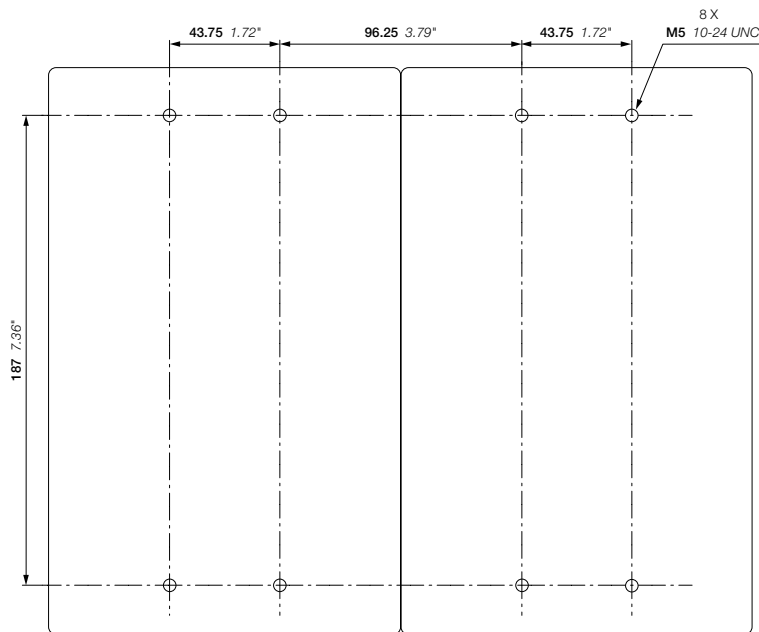

AF265, AF305, AF370  
+ VM19 mechanical interlocking unit

Main dimensions mm, inches

# AF265, AF305, AF370 3-pole contactors

## Dimensions

E3

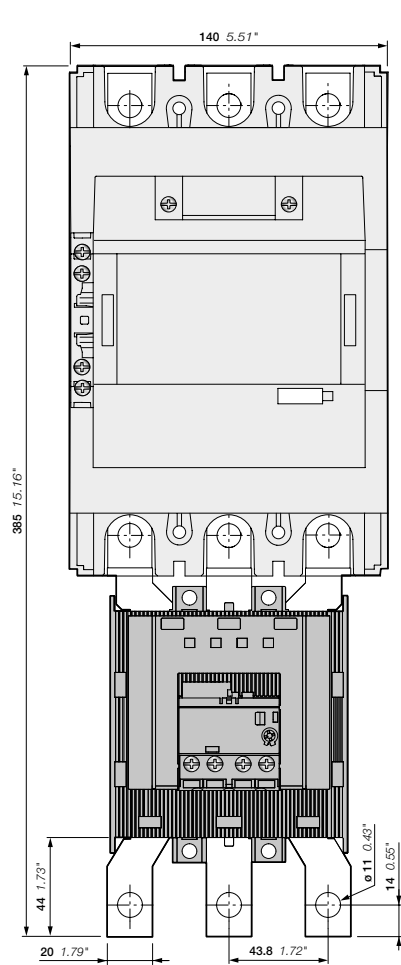

AF265, AF305, AF370-30-11  
+ EF370 electronic overload relay

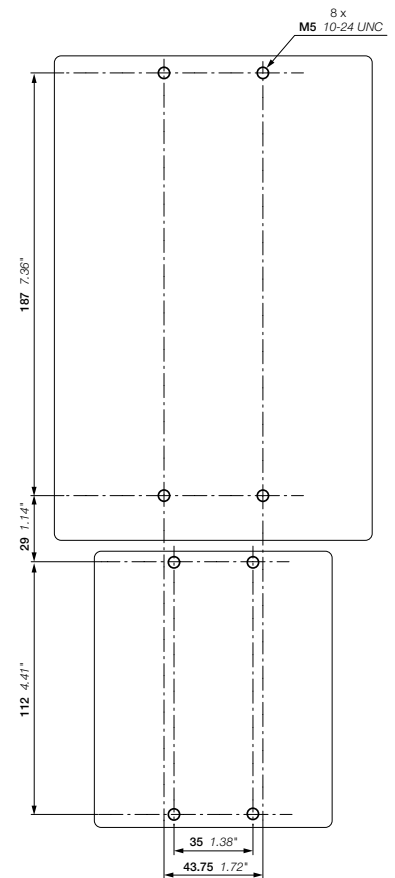
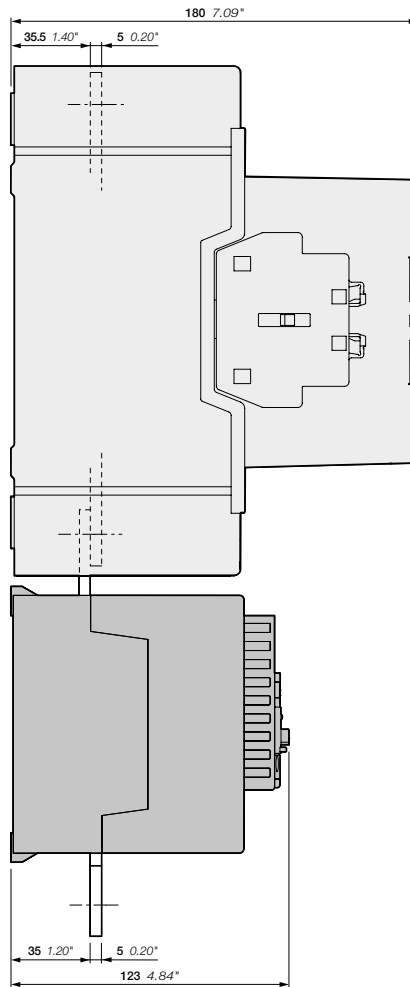

AF265, AF305, AF370  
+ EF370 electronic overload relay

Main dimensions mm, inches

# AF400 and AF460 3-pole contactors

## Dimensions

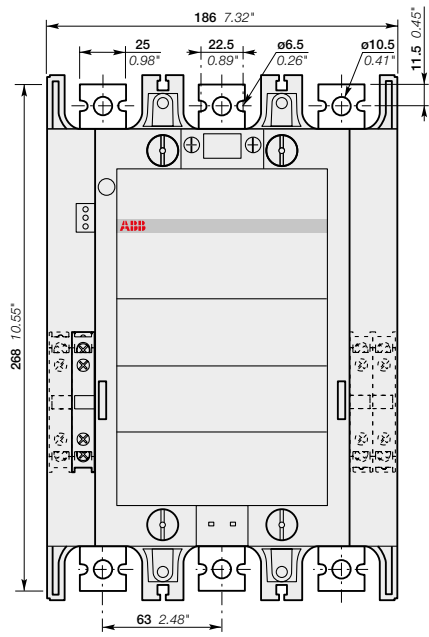

AF400, AF460-30-11

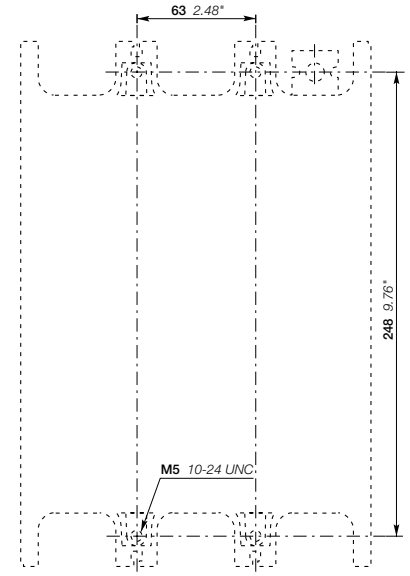
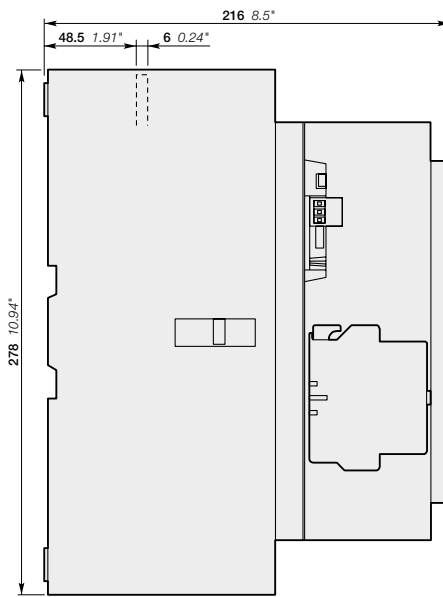

AF400, AF460

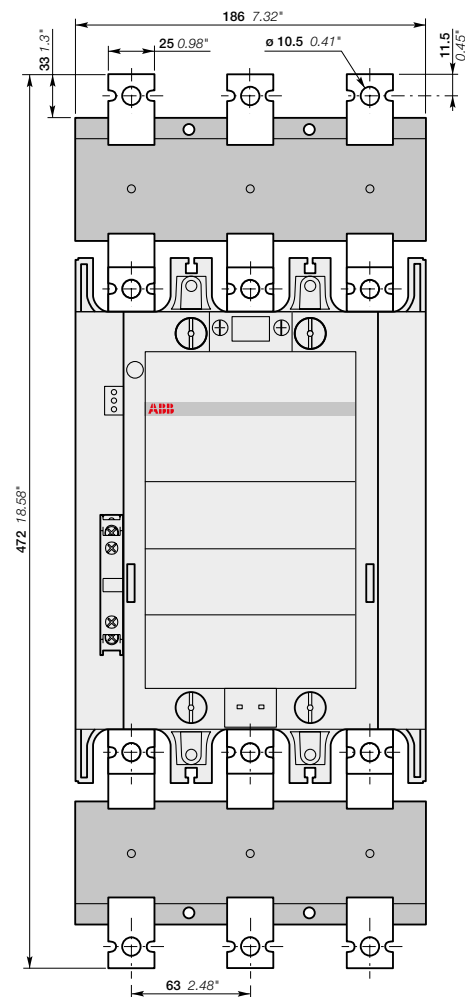

AF400, AF460-30-11  
+ LX460 terminal extension

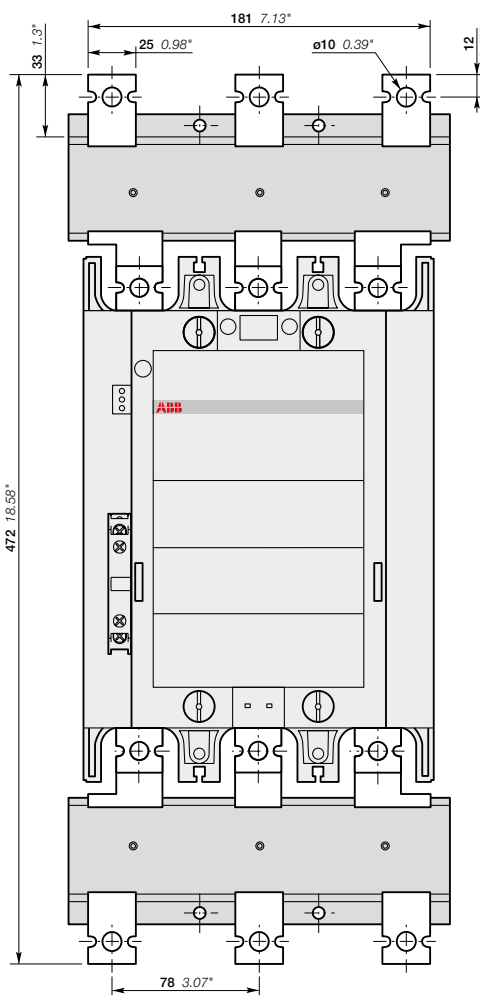

AF400, AF460-30-11  
+ LW460 terminal enlargement

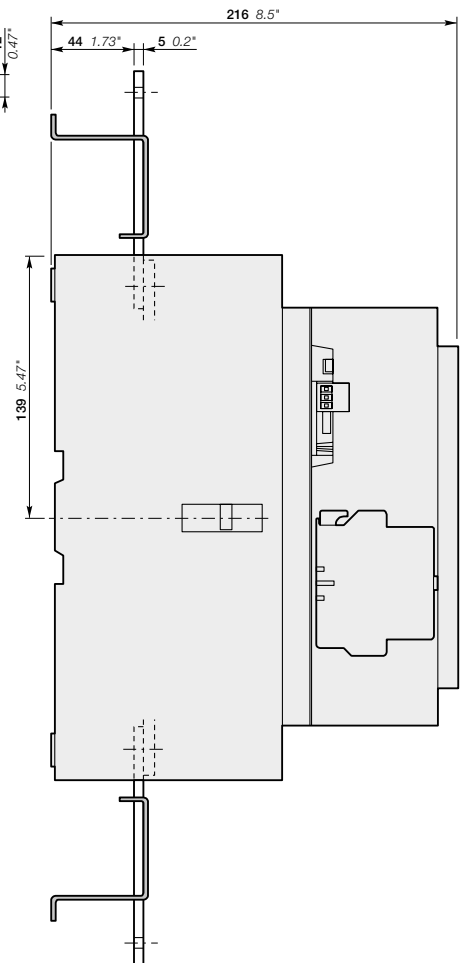

Main dimensions mm, inches

# AF400 and AF460 3-pole contactors

## Dimensions

30

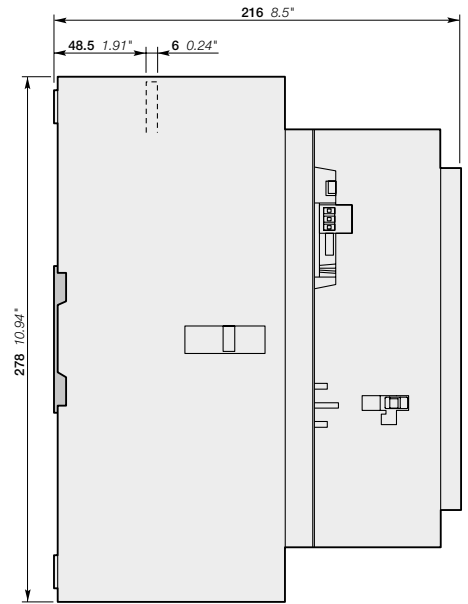
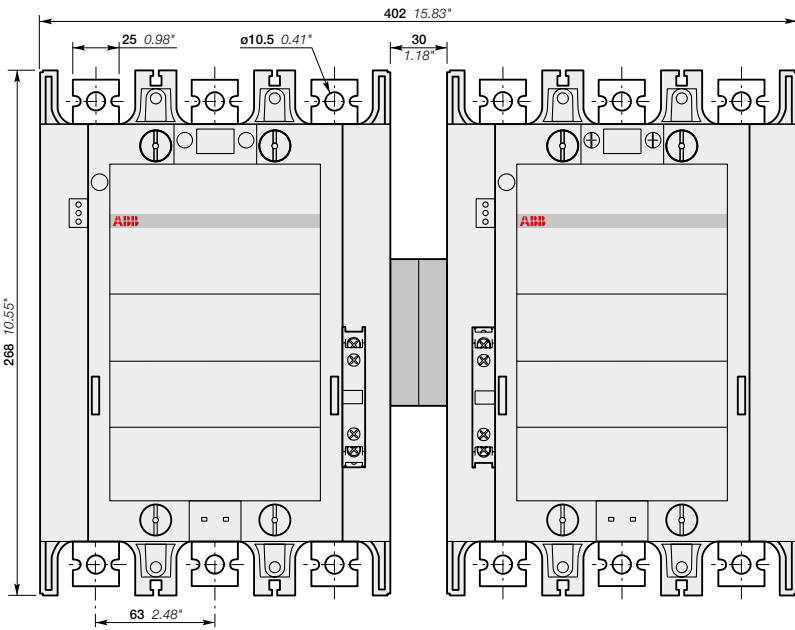

AF400, AF460-30-11  
+ VM750H mechanical interlock unit

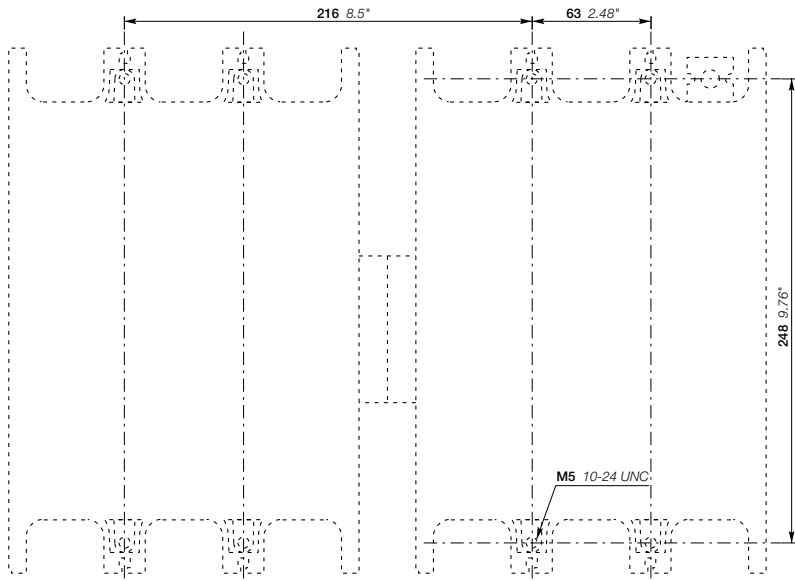

AF400, AF460  
+ VM750H mechanical interlock unit

Main dimensions mm, inches

# AF400 and AF460 3-pole contactors

## Dimensions

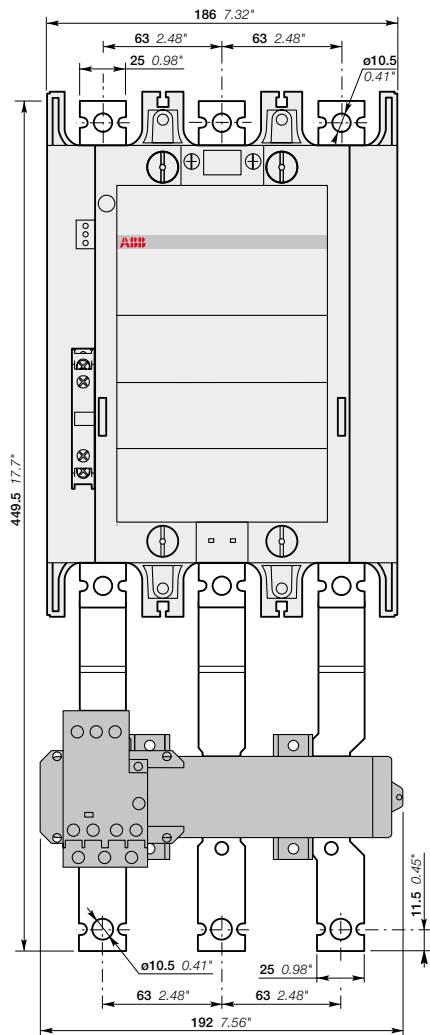

AF400, AF460-30-11  
+ EF460 electronic O/L relay

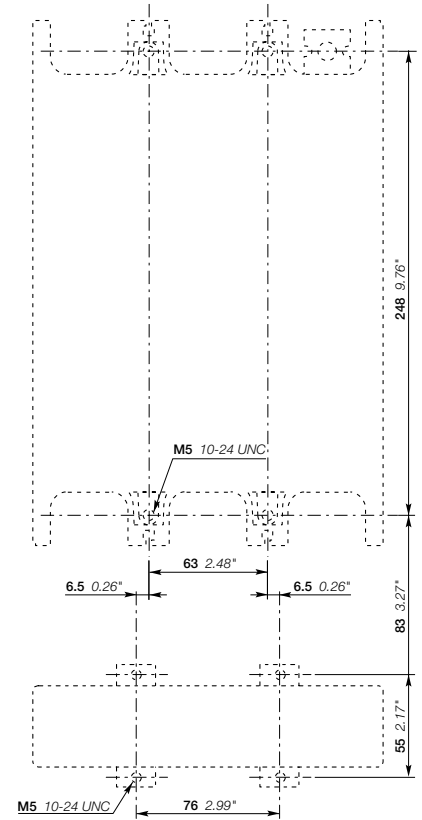
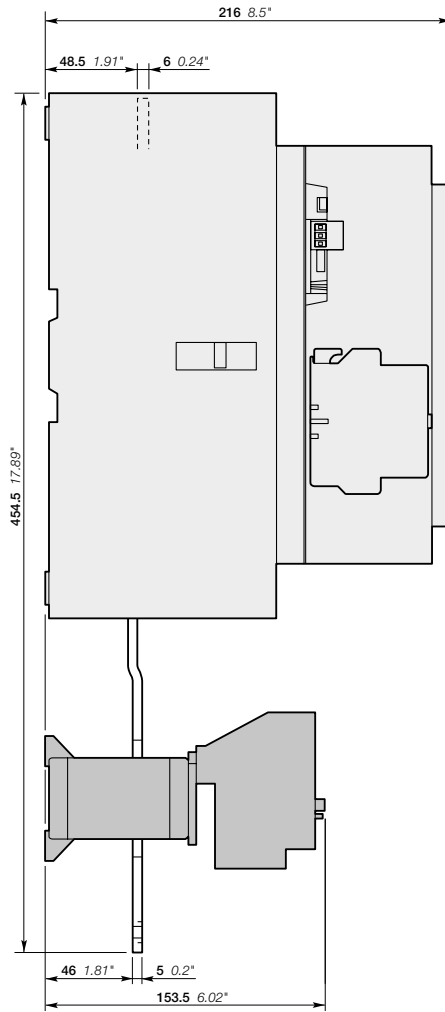

AF400, AF460  
+ EF460 electronic O/L relay

Main dimensions mm, inches



# AF580 and AF750 3-pole contactors

## Dimensions

03

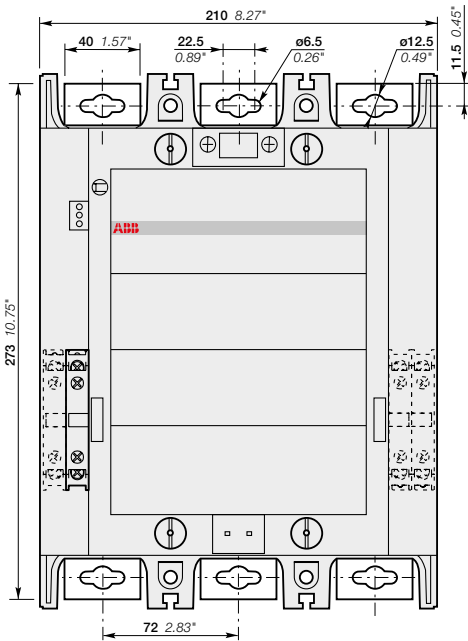

AF580 and AF750-30-11

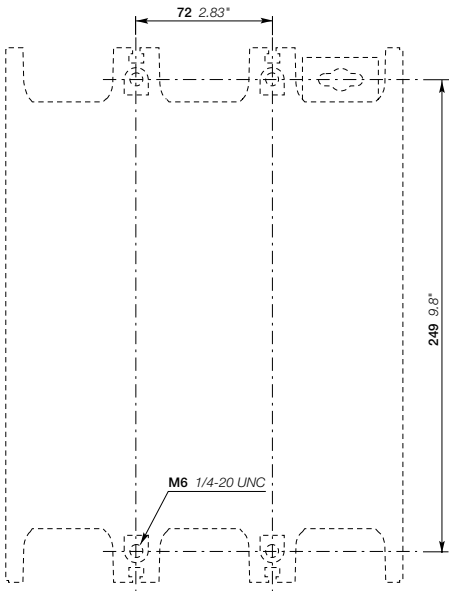
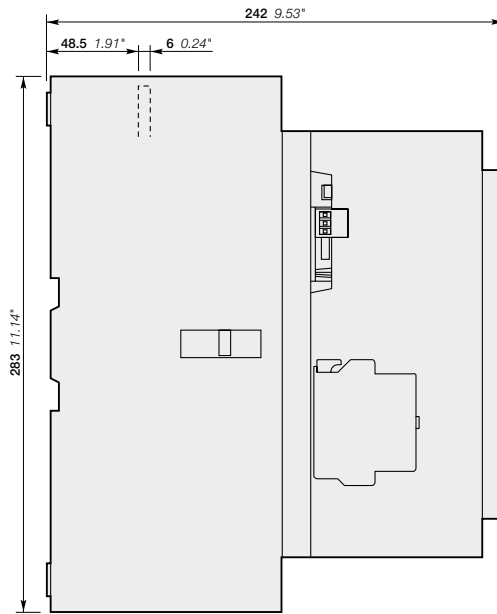

AF580 and AF750

Main dimensions mm, inches

# AF580 and AF750 3-pole contactors

## Dimensions

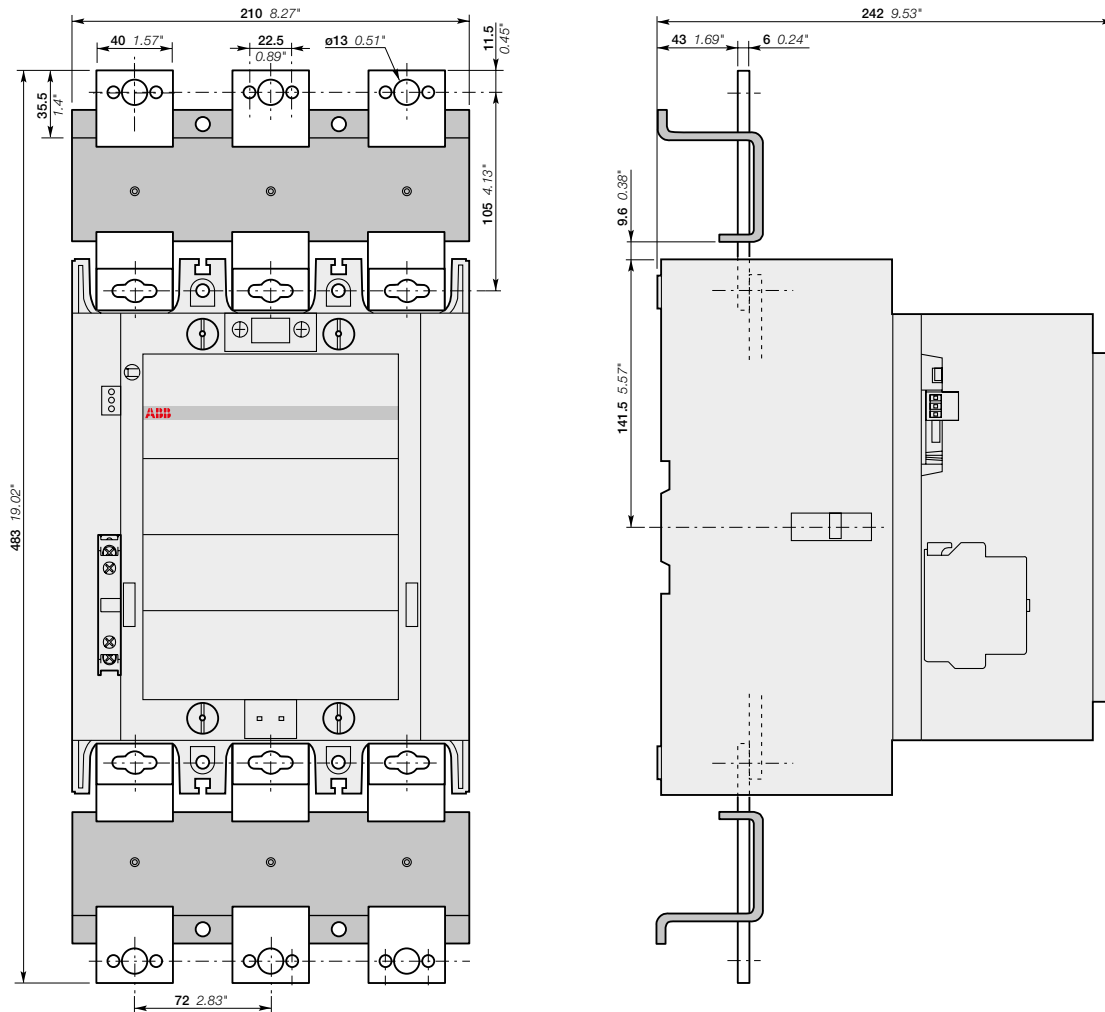

AF580 and AF750-30-11  
+ LX750 terminal extension

Main dimensions mm, inches

# AF580 and AF750 3-pole contactors

## Dimensions

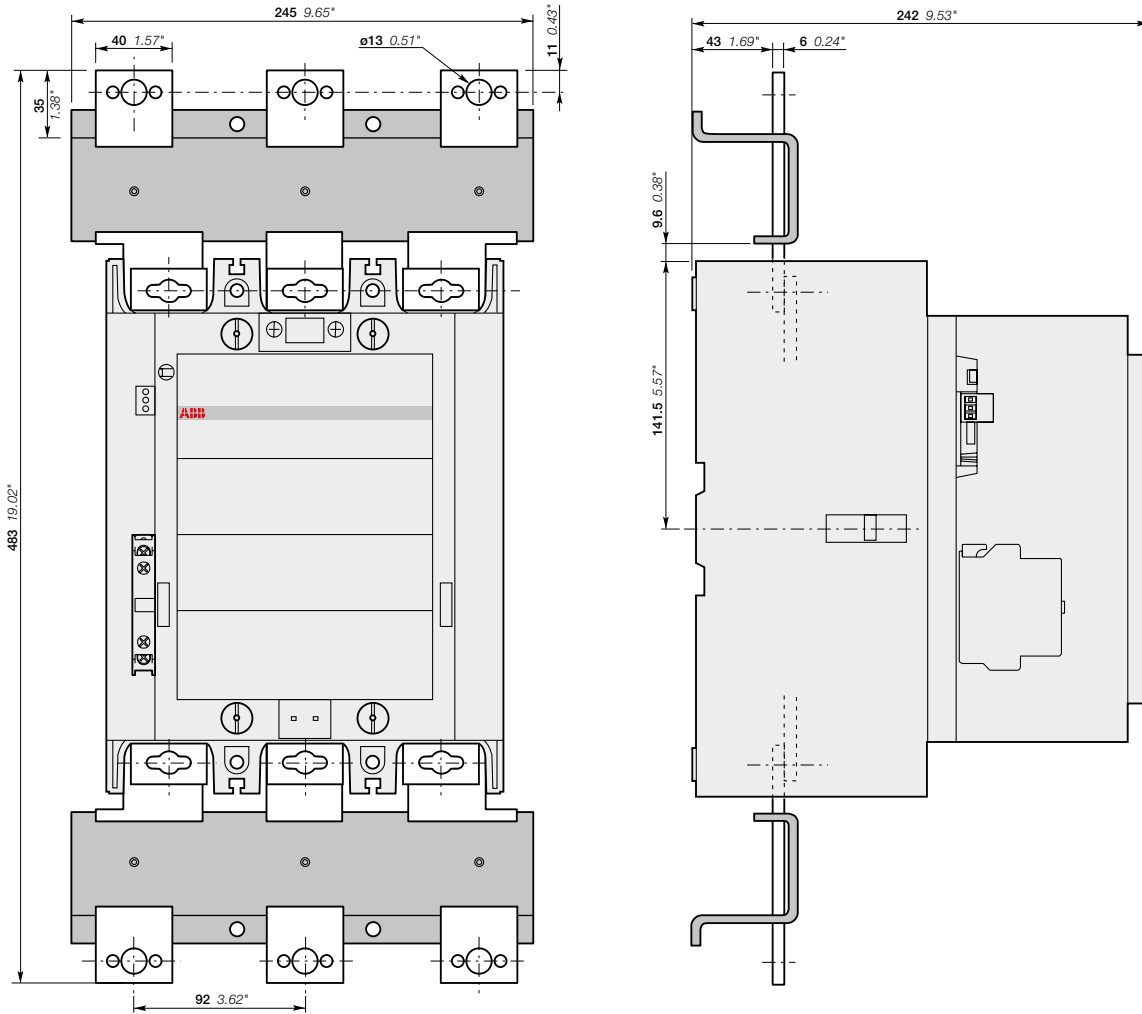

AF580 and AF750-30-11  
+ LW750 terminal enlargement

# AF580 and AF750 3-pole contactors

## Dimensions

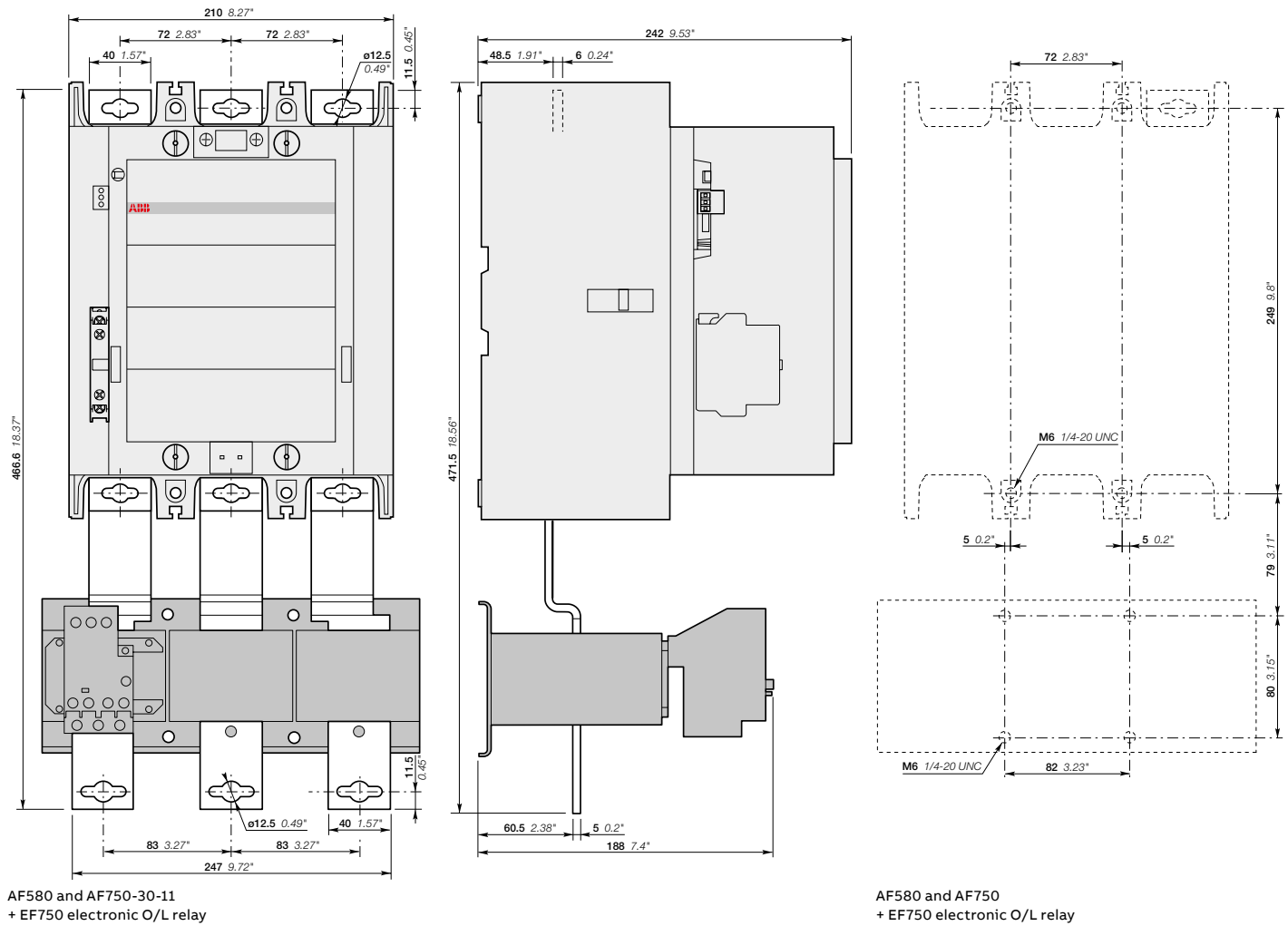

Main dimensions mm, inches

# AF580 and AF750 3-pole contactors

## Dimensions

03

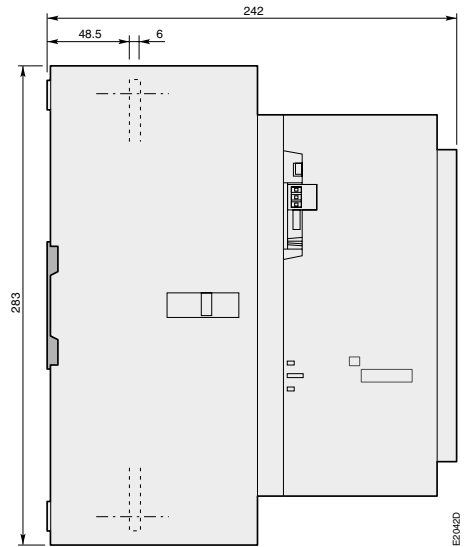
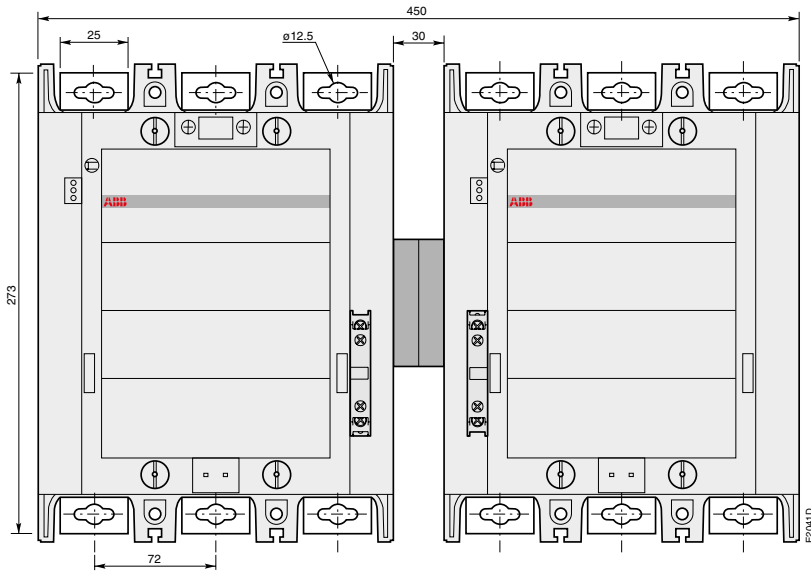

AF580 and AF750-30-11  
+ VM 750H mechanical interlock unit

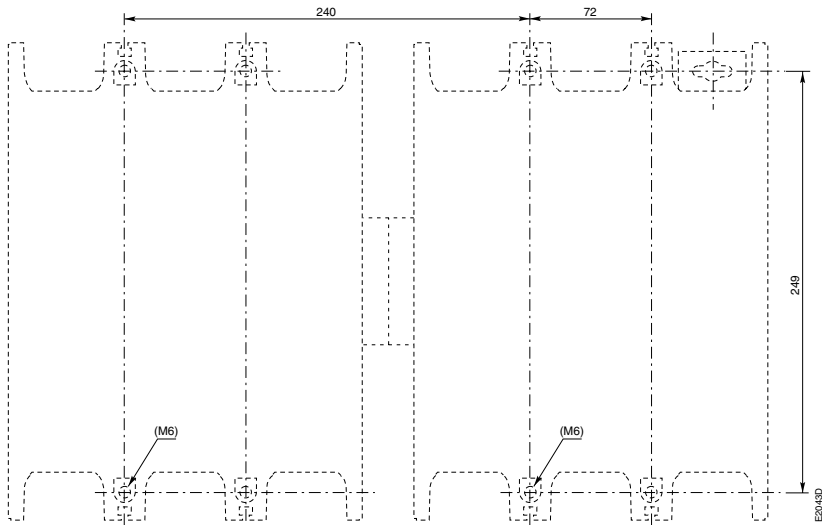

AF580 and AF750  
+ VM 750H mechanical interlock unit

Main dimensions mm, inches

# AF1250 3-pole contactors

## Dimensions

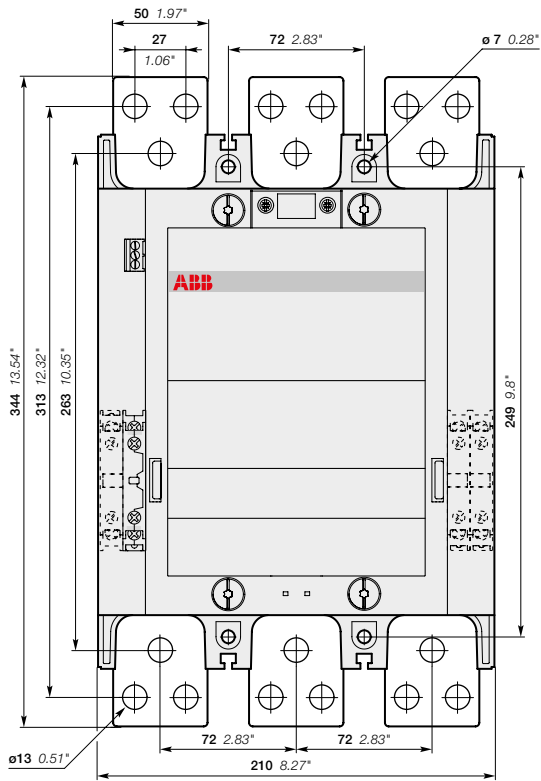

AF1250-30-11

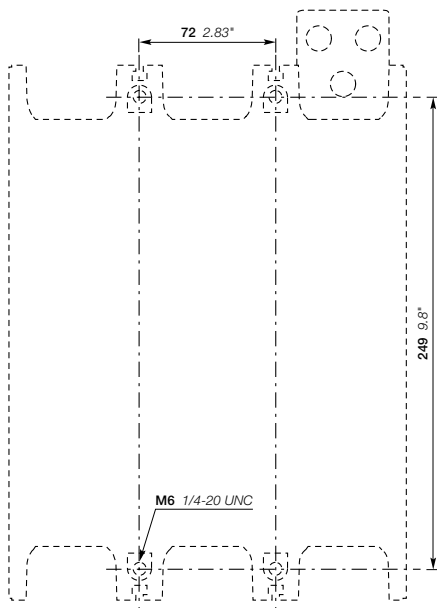
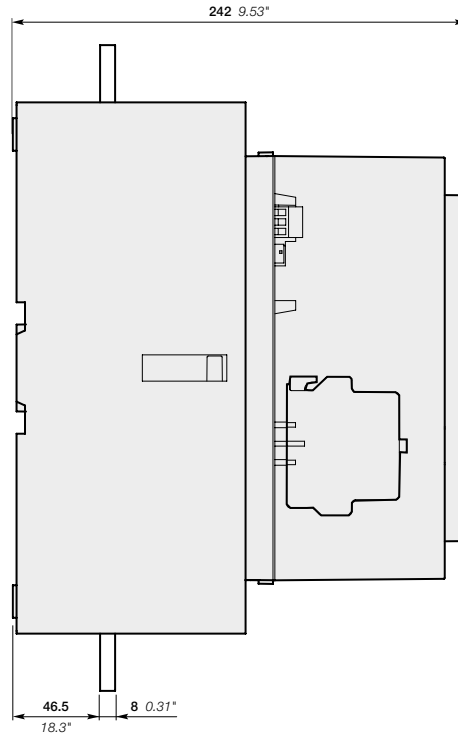

AF1250

Main dimensions mm, inches

# AF1250 3-pole contactors

## Dimensions

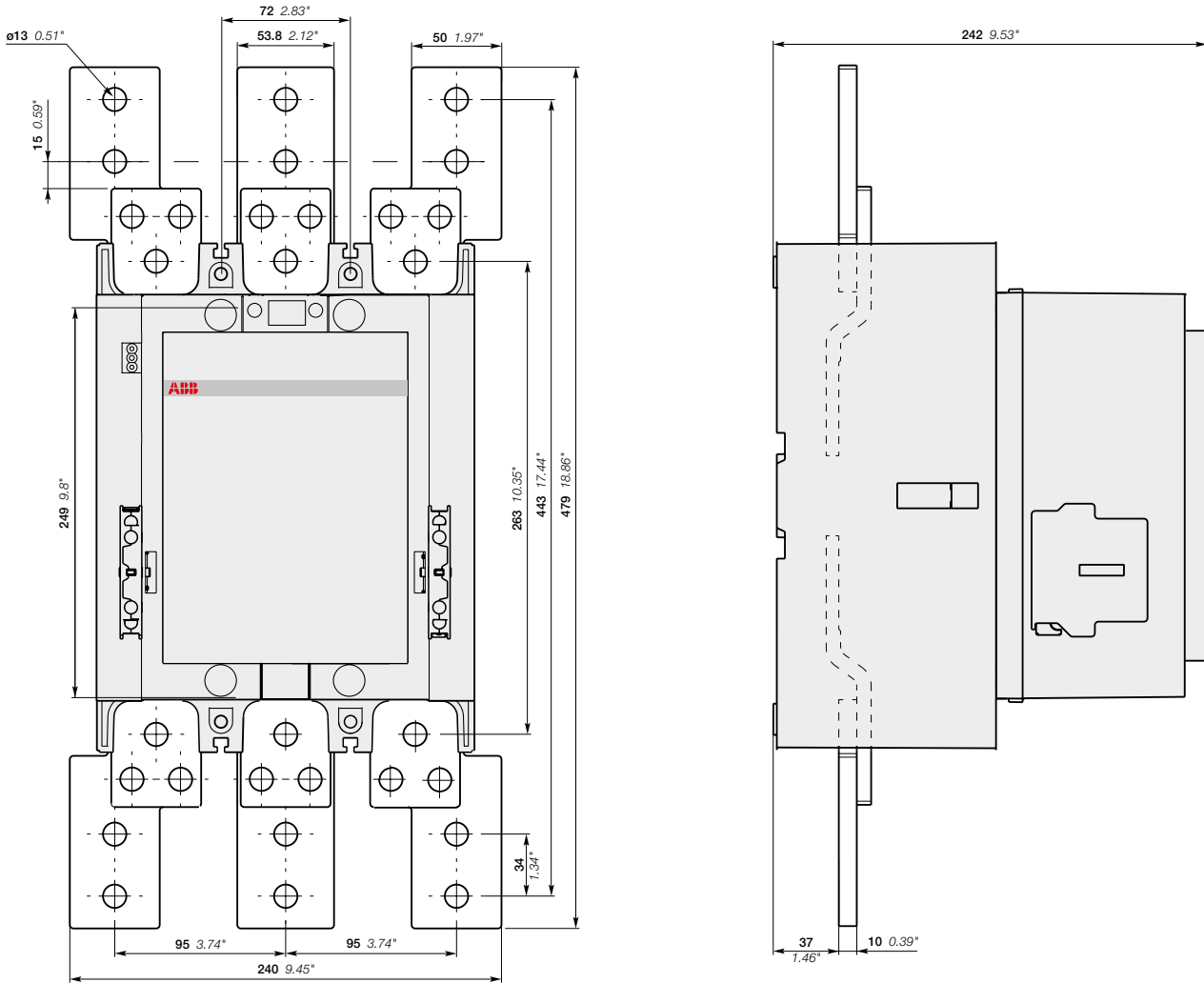

AF1250-30-11  
+ LW1250 terminal enlargement

Main dimensions mm, inches



# AF1350, AF1650, AF2050 and AF2850 3-pole contactors

## Dimensions

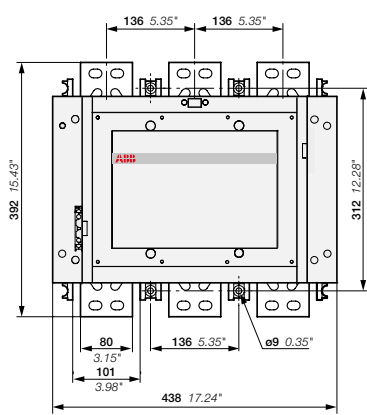
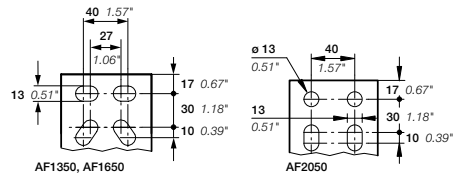

AF1350, AF1650, AF2050-30-11

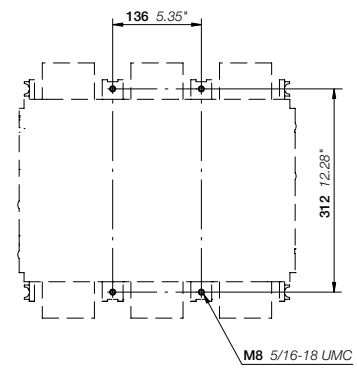
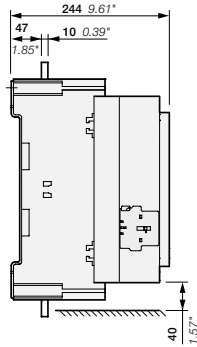

AF1350, AF1650, AF2050

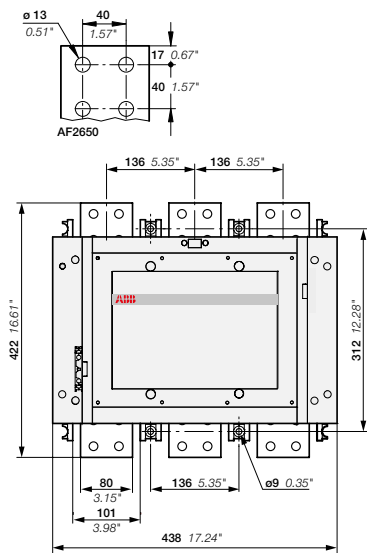

AF2850-30-11

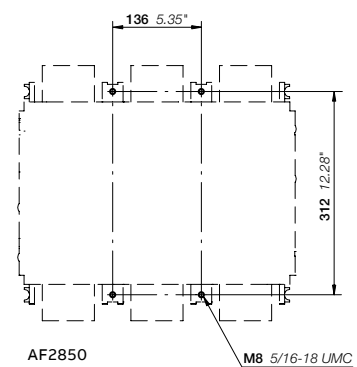
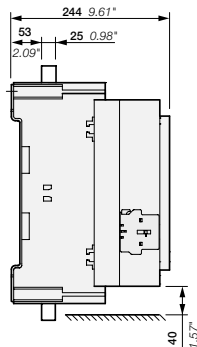

AF2850

Main dimensions mm, inches

# AF1350, AF1650, AF2050 and AF2850 3-pole contactors

## Dimensions

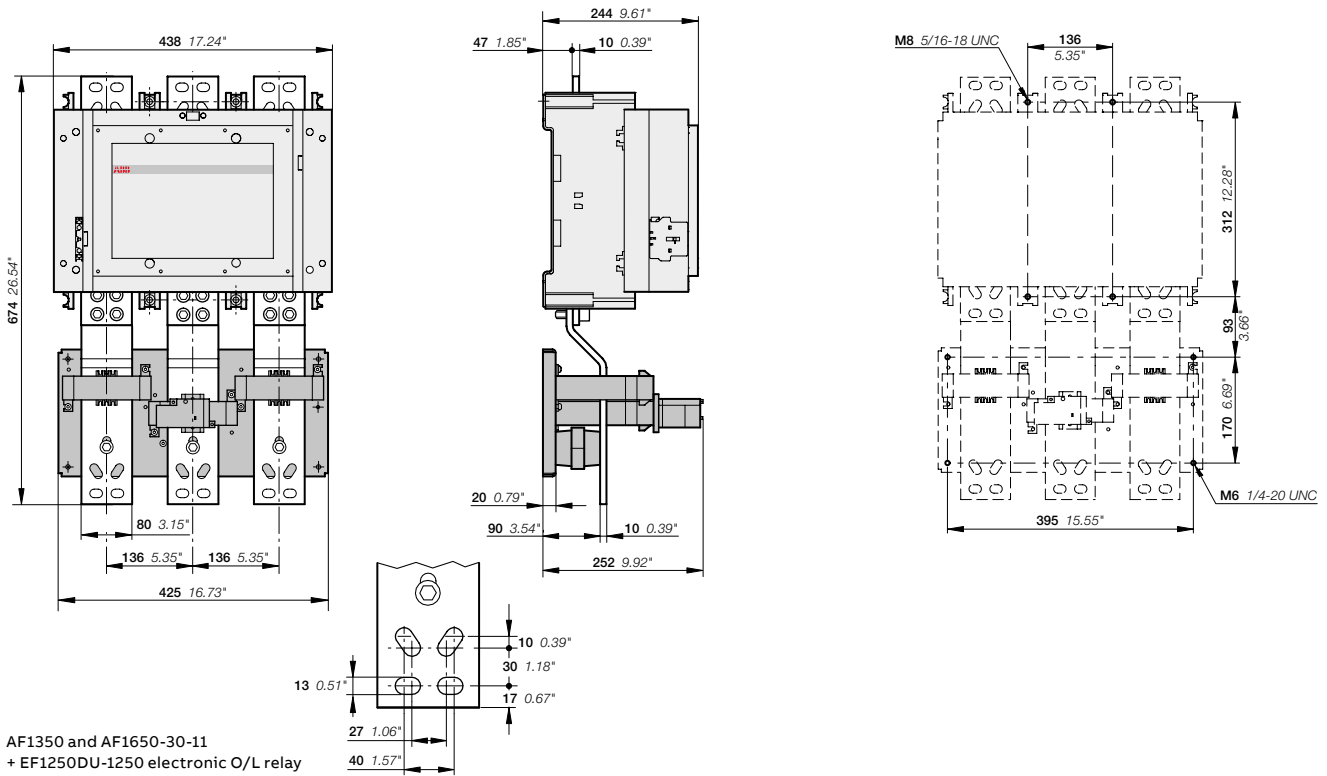

AF1350 and AF1650-30-11 + EF1250DU-1250 electronic O/L relay

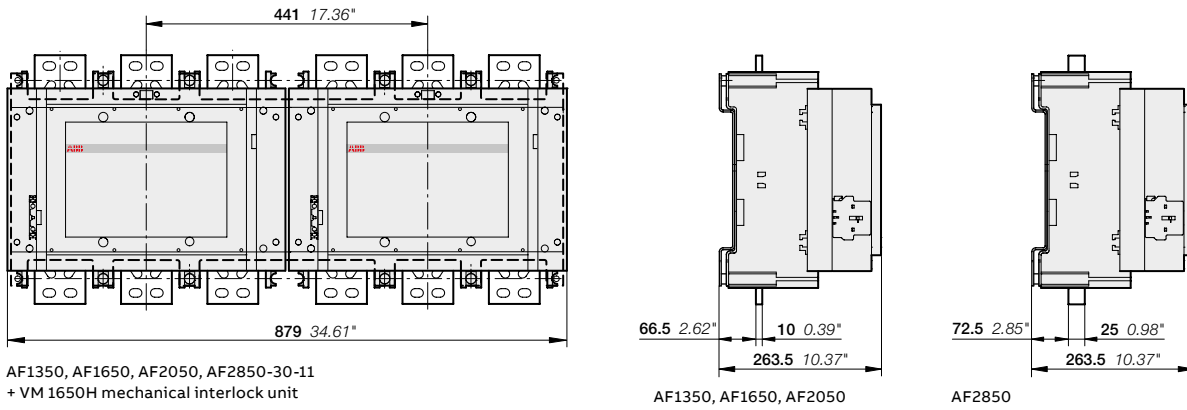

AF1350, AF1650, AF2050, AF2850-30-11 + VM1650H mechanical interlock unit

AF1350, AF1650, AF2050

AF2850

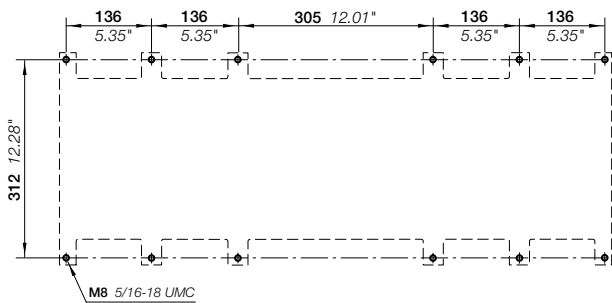

AF1350, AF1650, AF2050, AF2850 + VM1650H mechanical interlock unit

Main dimensions mm, inches

# AF09..K, AF12..K, AF16..K 3-pole contactors - with Push-in Spring terminals

## Dimensions

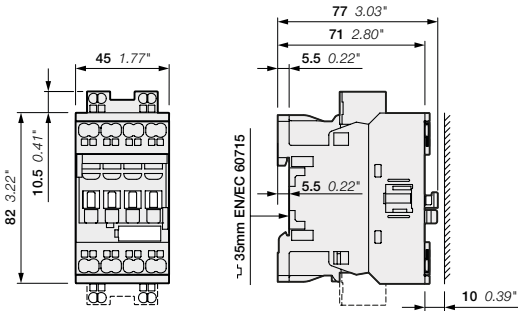

AF09..K, AF12..K, AF16..K

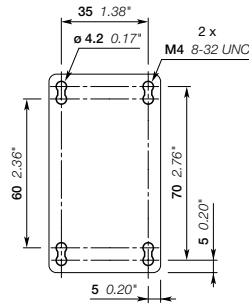

AF09..K, AF12..K, AF16..K

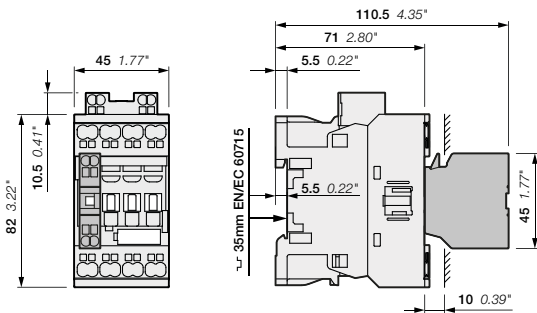

AF09..K, AF12..K, AF16..K  
+ CA4..K 1-pole auxiliary contact block

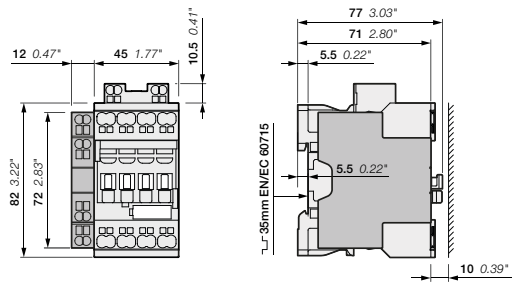

AF09..K, AF12..K, AF16..K  
+ CAL4-11K 2-pole auxiliary contact block

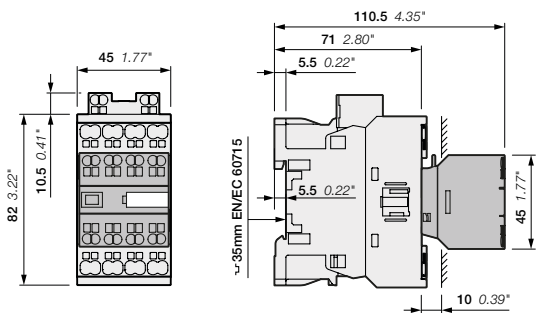

AF09..K, AF12..K, AF16..K  
+ CA4..K 4-pole auxiliary contact block

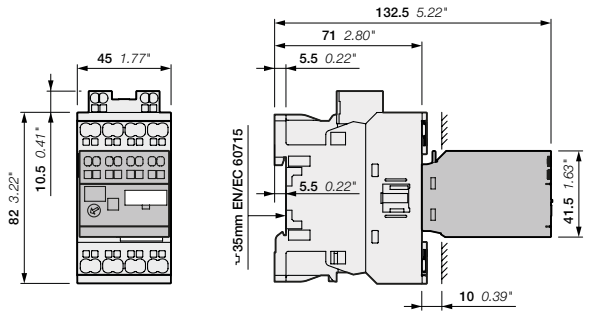

AF09..K, AF12..K, AF16..K  
+ TEF45 electronic timer

Note: For AF09..K ... AF16..K contactors, lateral distance to grounded component 2 mm 0.08" min  
24 V DC operated contactor (coil 30) depth + 20 mm (0.79").

Main dimensions mm, inches

# AF26..K, AF30..K, AF38..K 3-pole contactors - with Push-in Spring terminals

## Dimensions

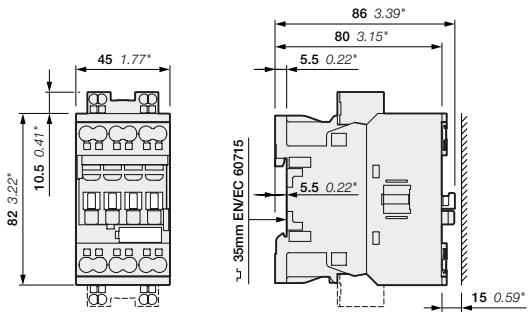

AF26..K, AF30..K, AF38..K

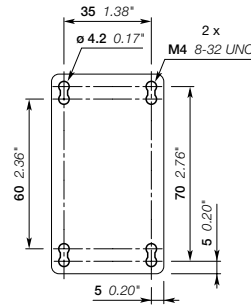

AF26..K, AF30..K, AF38..K

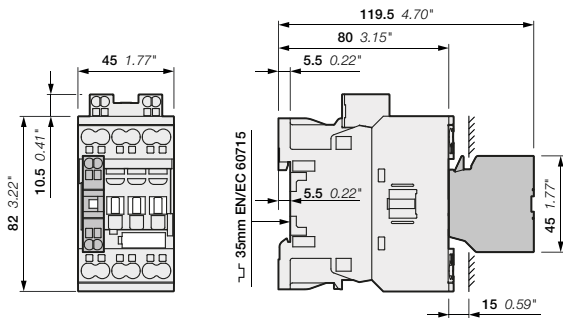

AF26..K, AF30..K, AF38..K  
+ CA4..K 1-pole auxiliary contact block

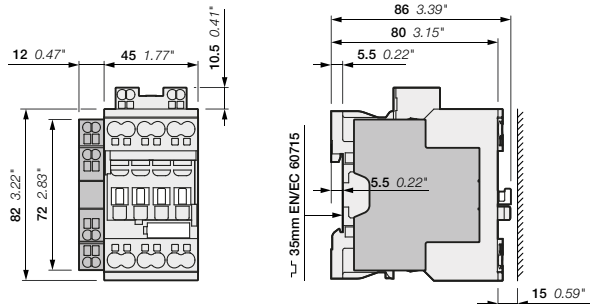

AF26..K, AF30..K, AF38..K  
+ CAL4-11K 2-pole auxiliary contact block

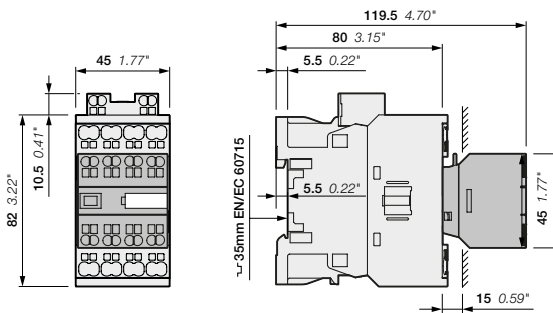

AF26..K, AF30..K, AF38..K  
+ CA4..K 4-pole auxiliary contact block

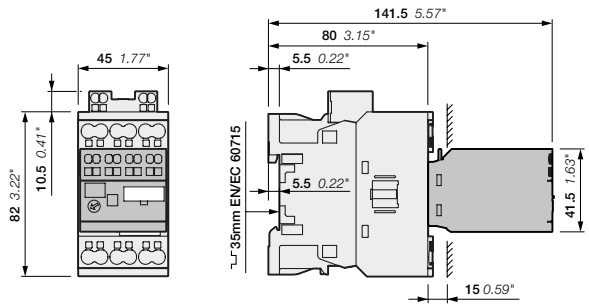

AF26..K, AF30..K, AF38..K  
+ TEF4S electronic timer

Note: For AF26..K ... AF38..K contactors, lateral distance to grounded component 2 mm 0.08" min 24 V DC operated contactor (coil 30) depth + 20 mm (0.79").

Main dimensions mm, inches

# AF09, AF16 4-pole contactors

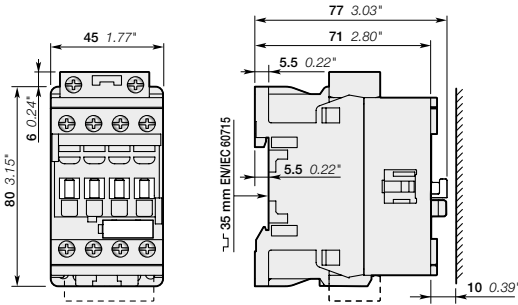

AF09, AF16

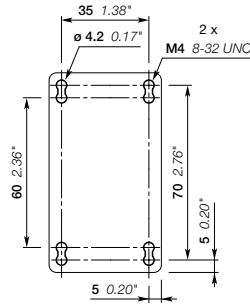

AF09, AF16

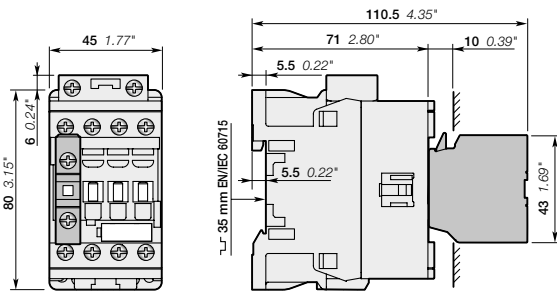

AF09, AF16  
+ CA4, CC4 1-pole auxiliary contact block

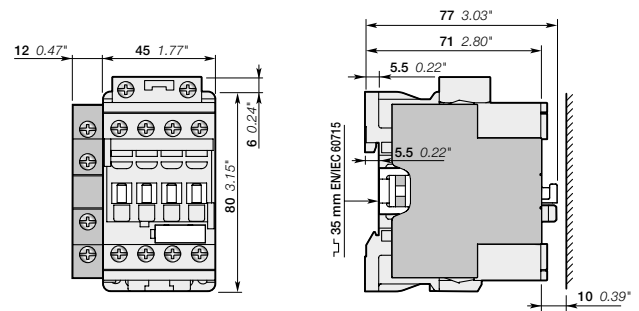

AF09, AF16  
+ CAL4-11 2-pole auxiliary contact block

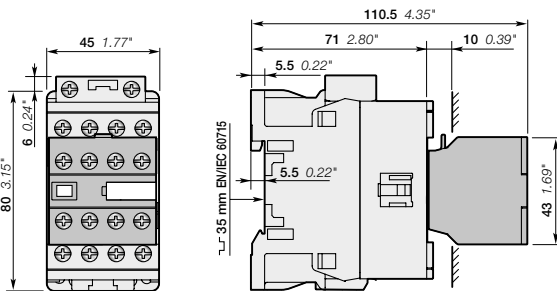

AF09, AF16  
+ CA4 4-pole auxiliary contact block

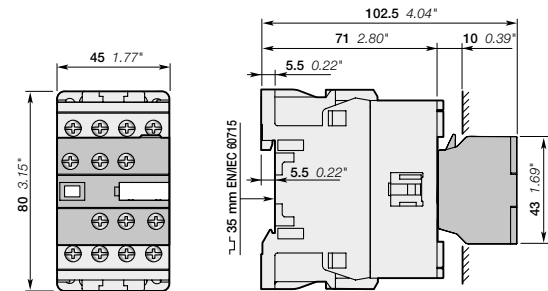

AF09, AF16  
+ CAT4 2-pole auxiliary contact and coil terminal block

(1) Note: contactor lateral distance to grounded component 2 mm 0.08" min.  
24 V DC operated contactor (coil 30) depth + 20 mm 0.79".

# AF09, AF16 4-pole contactors

03

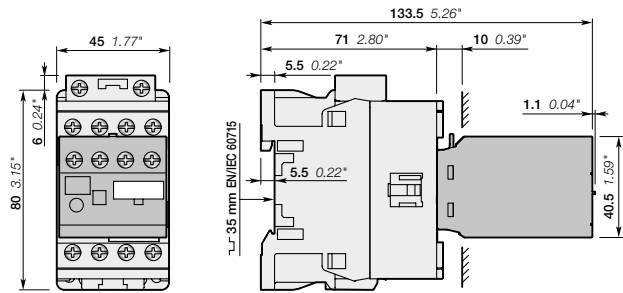

AF09, AF16  
+ TEF4 electronic timer

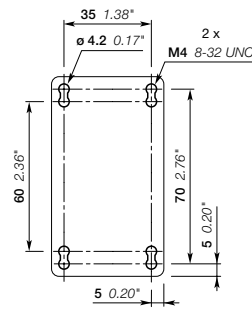

AF09, AF16

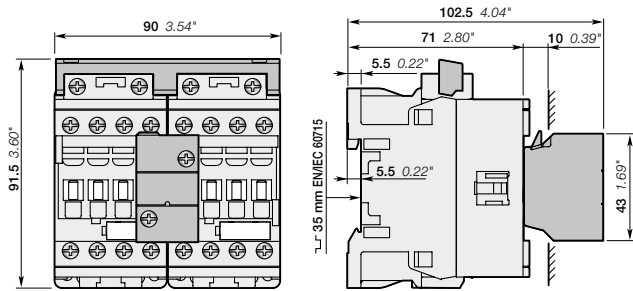

AF09...-40-00, AF16...-40-00  
+ VEM4 mechanical and electrical interlock set

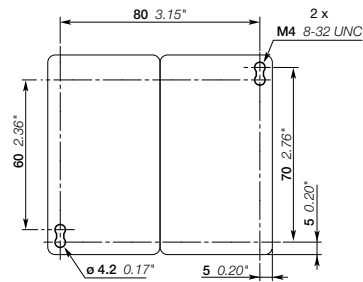

AF09...-40-00, AF16...-40-00  
+ VEM4 mechanical and electrical interlock set

(1) Note: contactor lateral distance to grounded component 2 mm 0.08" min.  
24 V DC operated contactor (coil 30) depth + 20 mm 0.79".

# AF26, AF38 4-pole contactors

## Dimensions

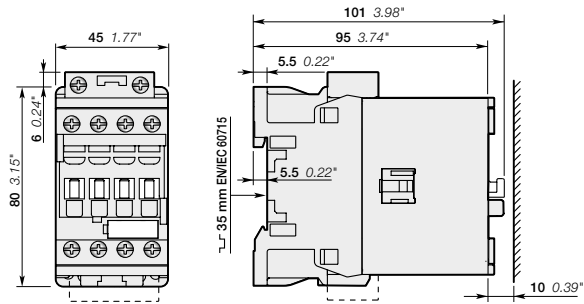

AF26, AF38

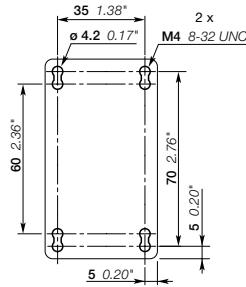

AF26, AF38

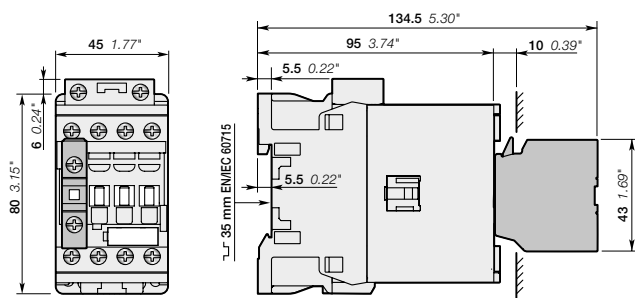

AF26, AF38  
+ CA4, CC4 1-pole auxiliary contact block

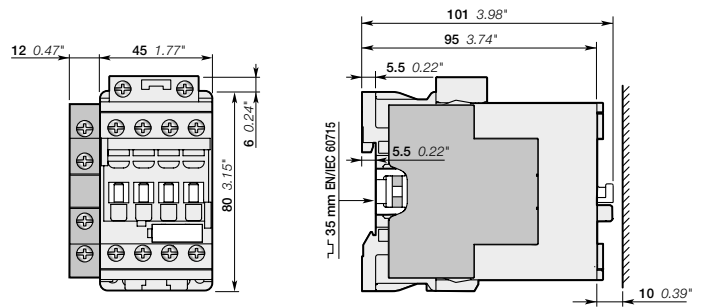

AF26, AF38  
+ CAL4-11 2-pole auxiliary contact block

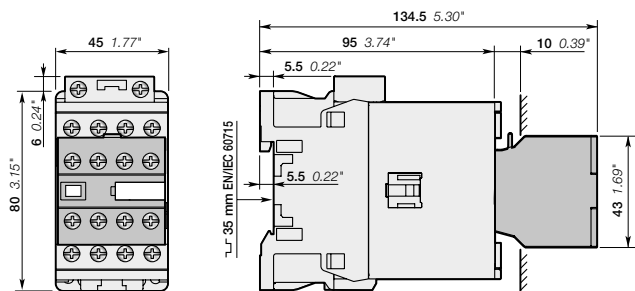

AF26, AF38  
+ CA4 4-pole auxiliary contact block

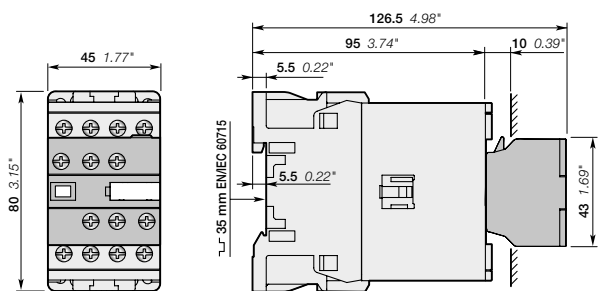

AF26, AF38  
+ CAT4 2-pole auxiliary contact and coil terminal block

Note: For AF26 and AF38 contactors, lateral distance to grounded component 2 mm 0.08" min.

Main dimensions mm, inches



# AF26, AF38 4-pole contactors

## Dimensions

E3

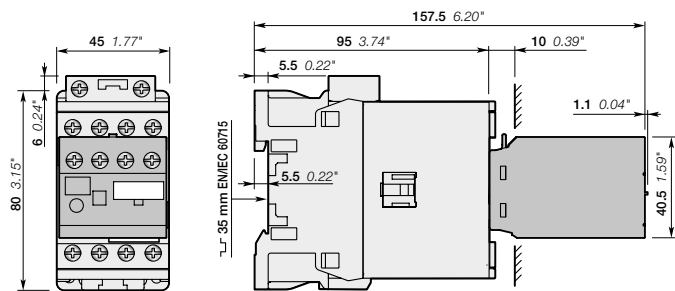

AF26, AF38  
+ TEF4 electronic timer

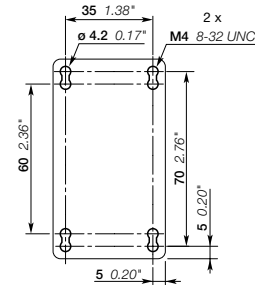

AF26, AF38

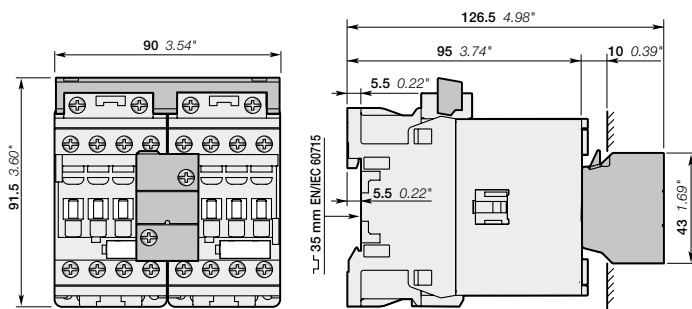

AF26..-40-00, AF38..-40-00  
+ VEM4 mechanical and electrical interlock set

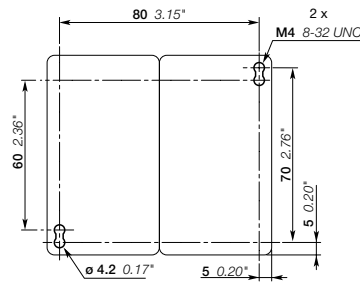

AF26..-40-00, AF38..-40-00  
+ VEM4 mechanical and electrical interlock set

(1) Note: For AF26 and AF38 contactors, lateral distance to grounded component 2 mm 0.08" min.

Main dimensions mm, inches (1)

# AF40, AF52 4-pole contactors

## Dimensions

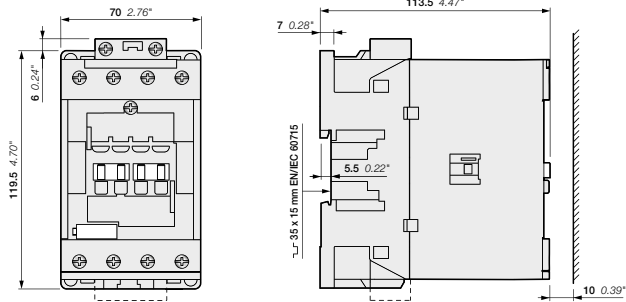

AF40, AF52

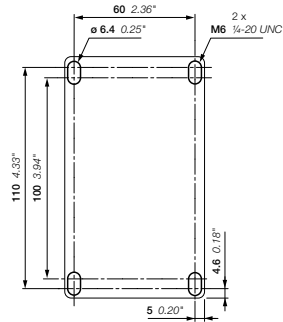

AF40, AF52

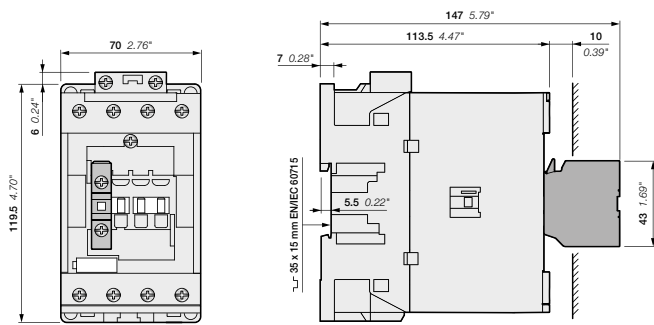

AF40, AF52  
+ CA4, CC4 1-pole auxiliary contact block

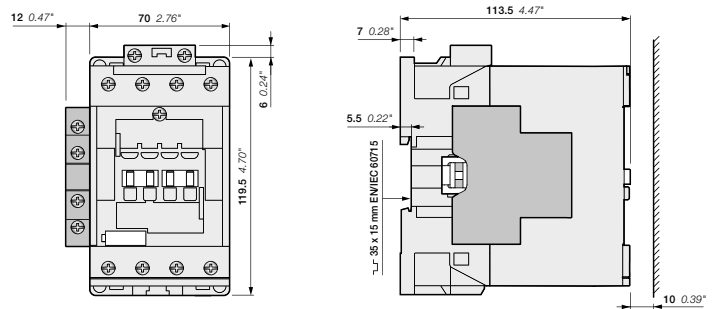

AF40, AF52  
+ CAL4-11 2-pole auxiliary contact block

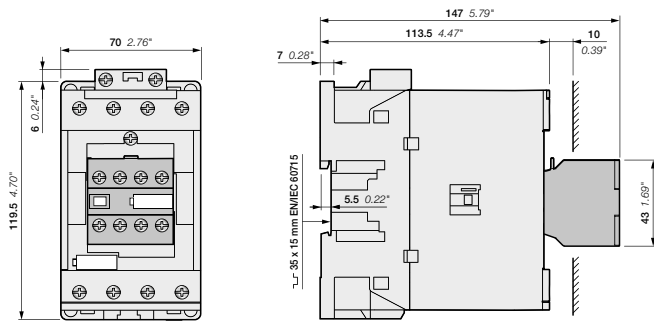

AF40, AF52  
+ CA4 4-pole auxiliary contact block

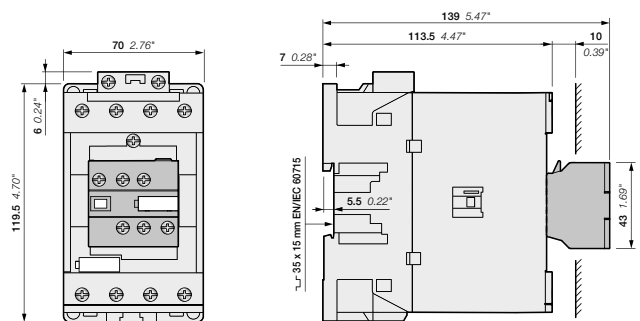

AF40, AF52  
+ CAT4 2-pole auxiliary contact and coil terminal block

Main dimensions mm, inches

# AF40, AF52 4-pole contactors

## Dimensions

30

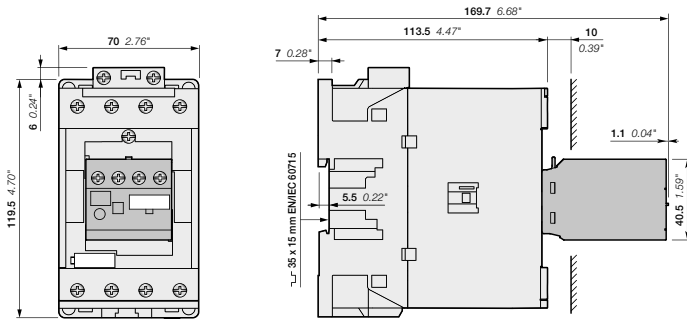

AF40, AF52  
+ TEF4 electronic timer

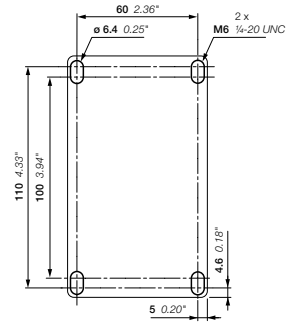

AF40, AF52

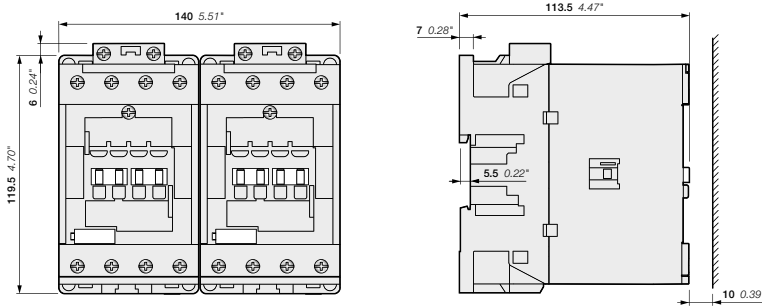

AF40, AF52  
+ VM96-4 mechanical interlock unit

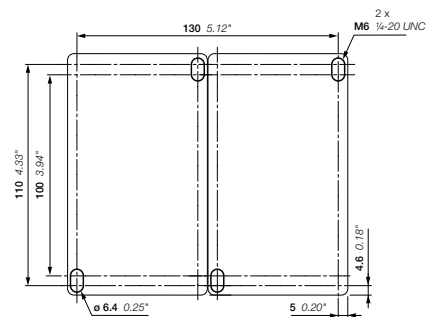

AF40, AF52  
+ VM96-4 mechanical interlock unit

Main dimensions mm, inches

# AF80 4-pole contactors

## Dimensions

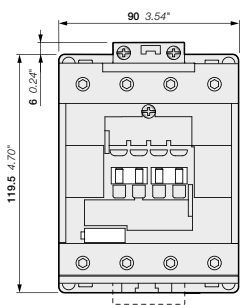

AF80

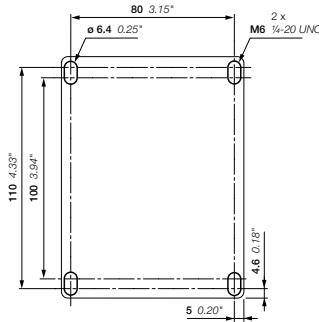
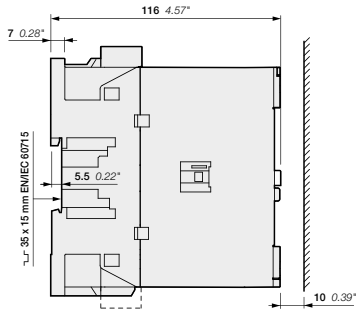

AF80

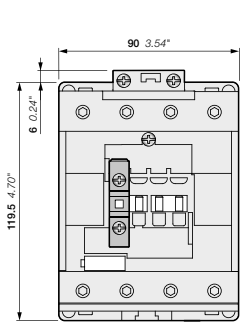

AF80  
+ CA4, CC4 1-pole auxiliary contact block

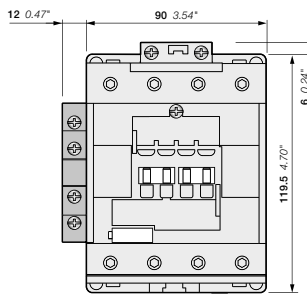
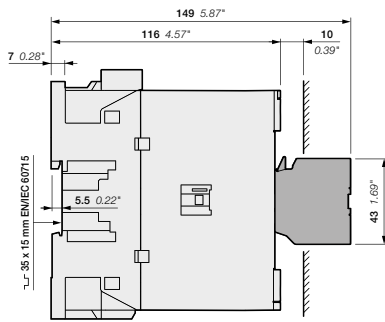

AF80  
+ CAL4-11 2-pole auxiliary contact block

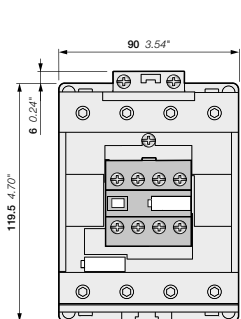
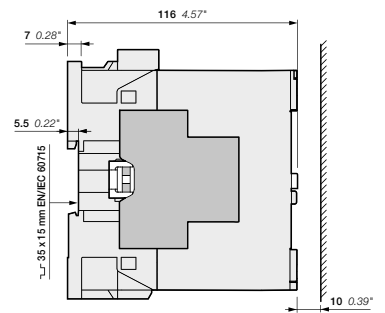

AF80  
+ CA4 4-pole auxiliary contact block

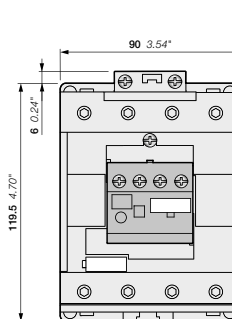
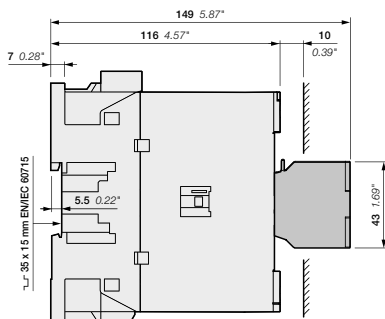

AF80  
+ TEF4 Electronic timer

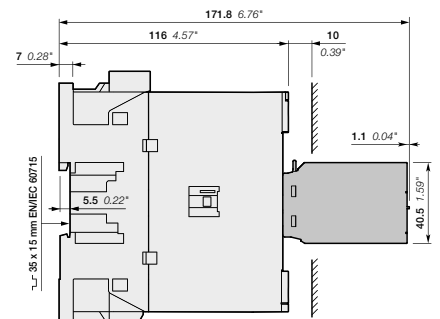

Main dimensions mm, inches

# AF80 4-pole contactors

## Dimensions

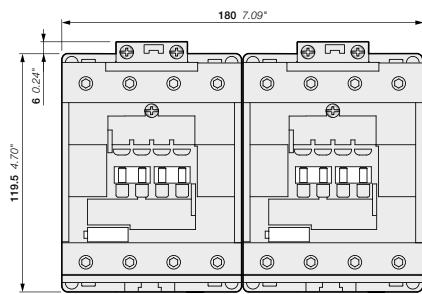

AF80  
+ CA4, CC4 1-pole auxiliary contact block

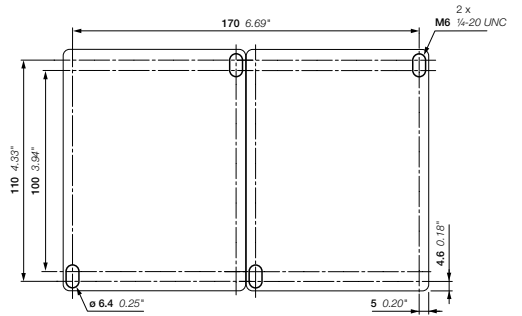
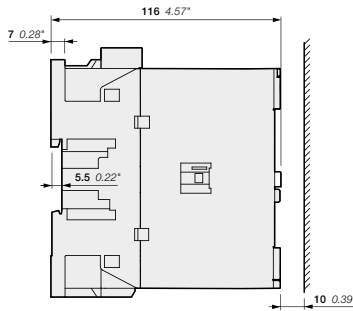

AF80  
+ VM96-4 mechanical interlock unit

Main dimensions mm, inches

# AF116, AF140 4-pole contactors

## Dimensions

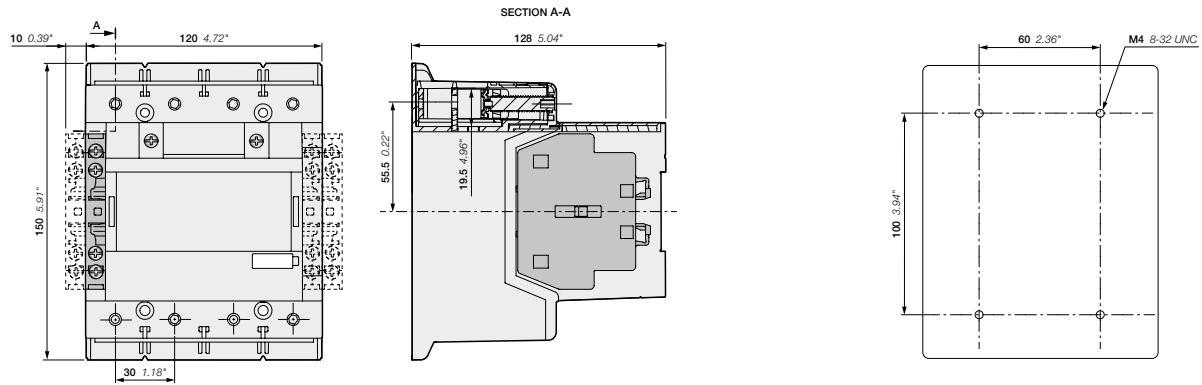

AF116, AF140-40-00 + CAL19 2-pole auxiliary contact block  
AF116, AF140-40-11

AF116, AF140-40-..(B)

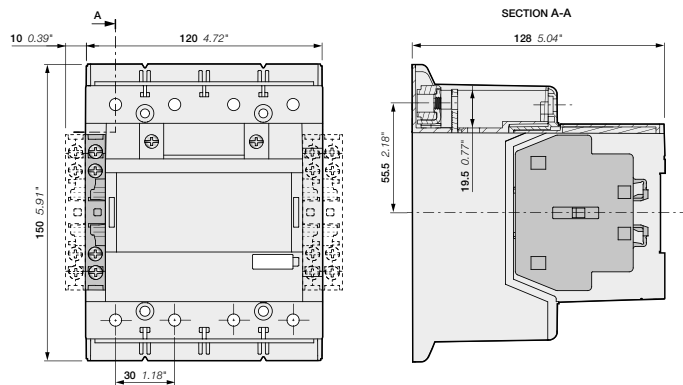

AF116, AF140-40-00B + CAL19 2-pole auxiliary contact block  
AF116, AF140-40-11B

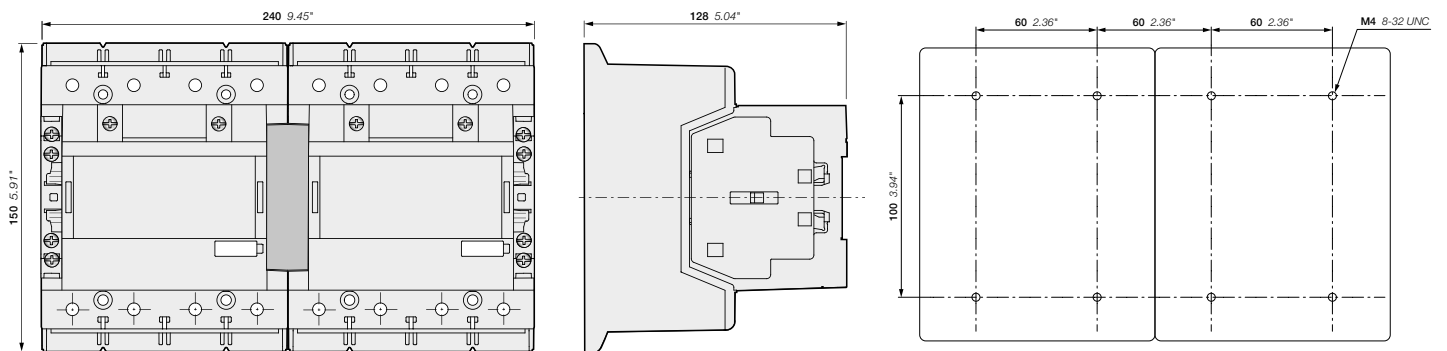

AF116, AF140-40-11  
+ VM19 mechanical interlocking unit

AF116, AF140  
+ VM19 mechanical interlocking unit

Main dimensions mm, inches

# AF190, AF205 4-pole contactors

## Dimensions

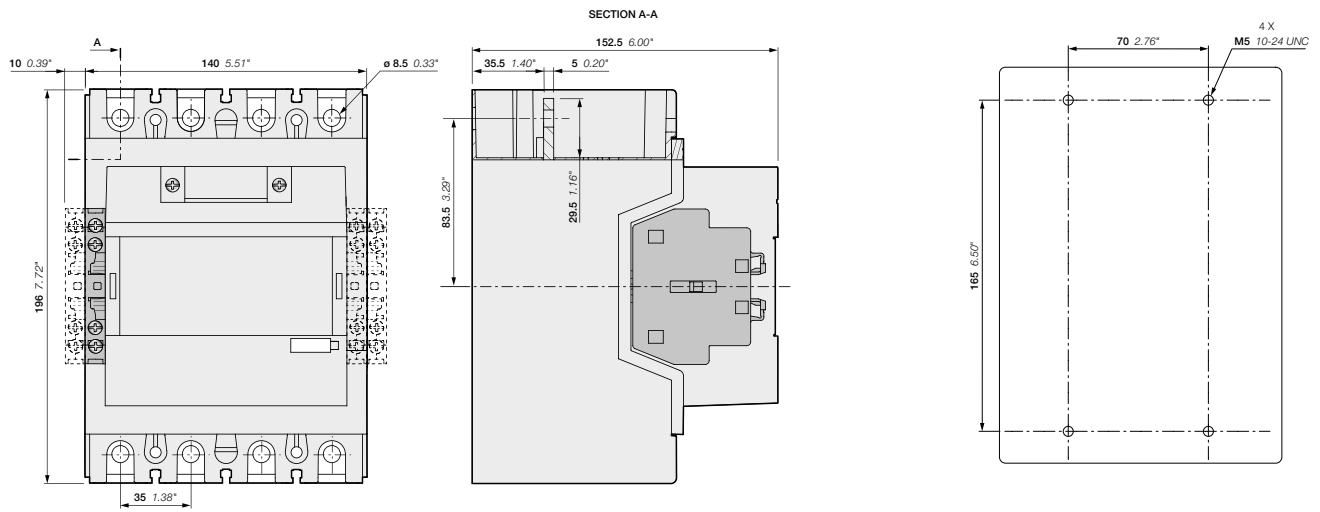

AF190, AF205-40-00 + CAL19 2-pole auxiliary contact block  
AF190, AF205-40-11

AF190, AF205-40

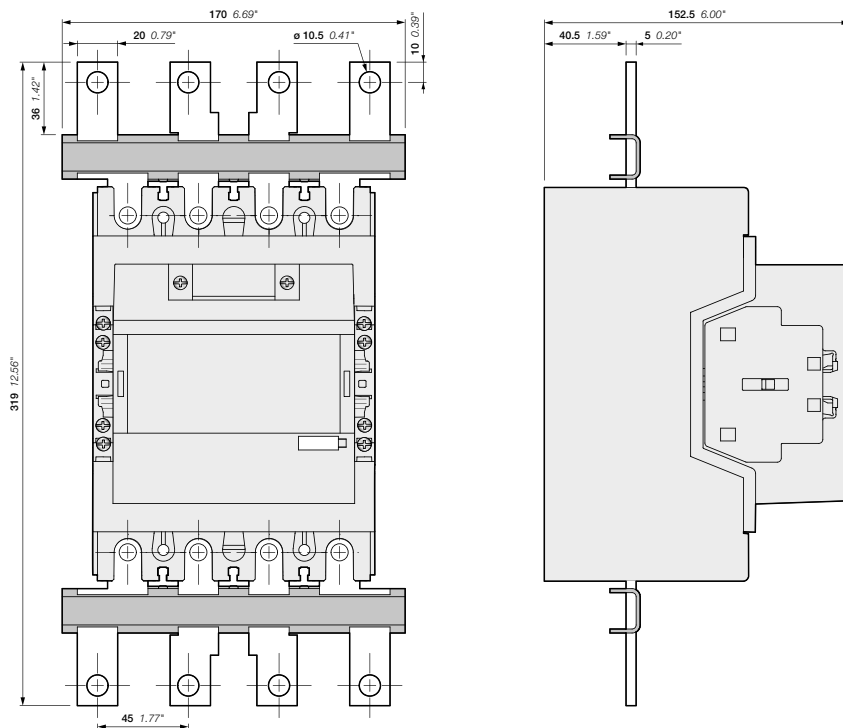

AF190, AF205-40-11  
+ LW205-40 terminal enlargement

Main dimensions mm, inches



# AF190, AF205 4-pole contactors

## Dimensions

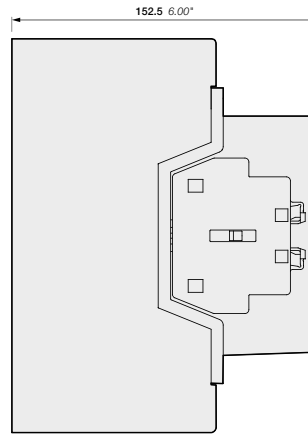
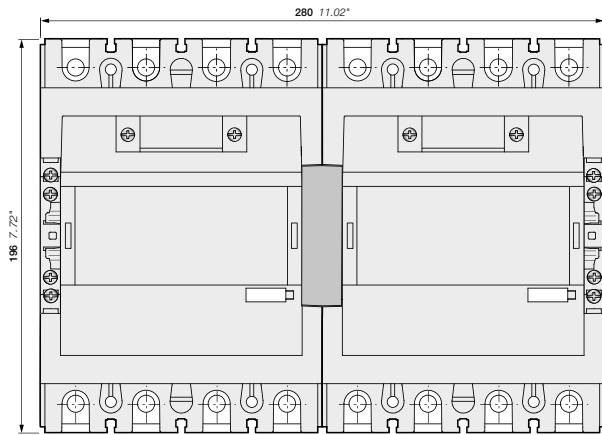

AF190, AF205-40-11  
+ VM19 mechanical interlocking unit

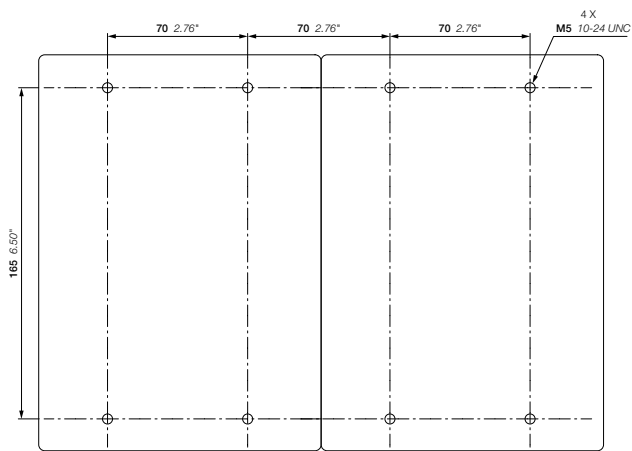

AF190, AF205  
+ VM19 mechanical interlocking unit

Main dimensions mm, inches

# AF265, AF305, AF370 4-pole contactors

## Dimensions

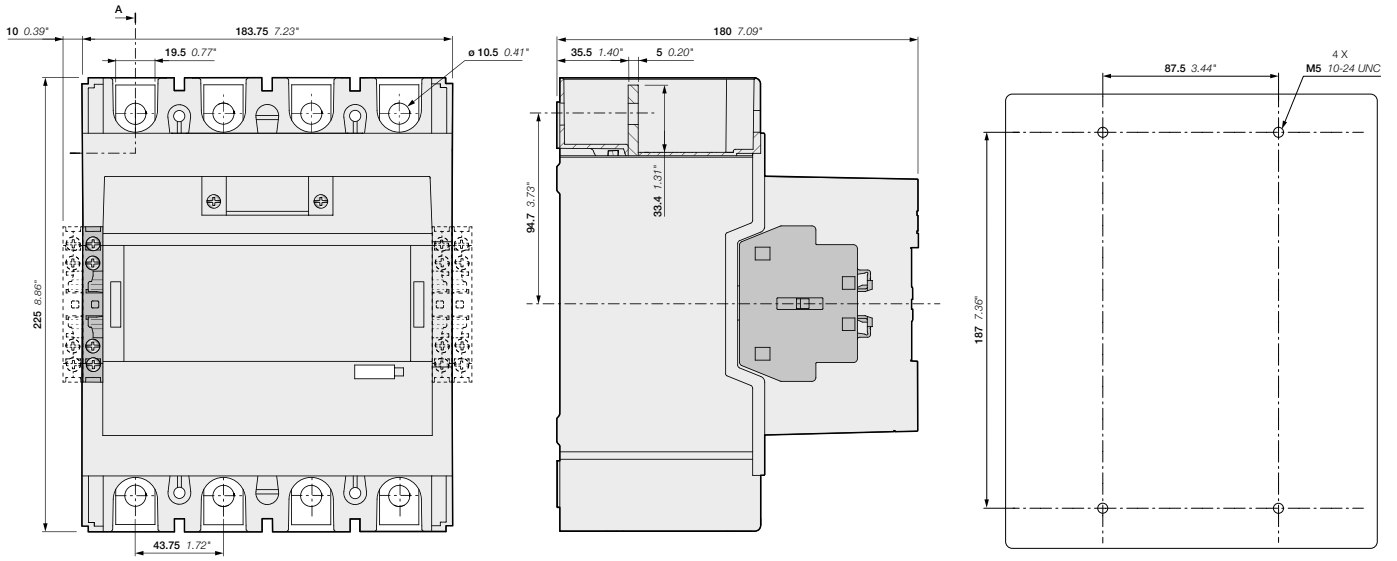

AF265, AF305, AF370-40-00 + CAL19 2-pole auxiliary contact block  
AF265, AF305, AF370-40-11

AF265, AF305, AF370

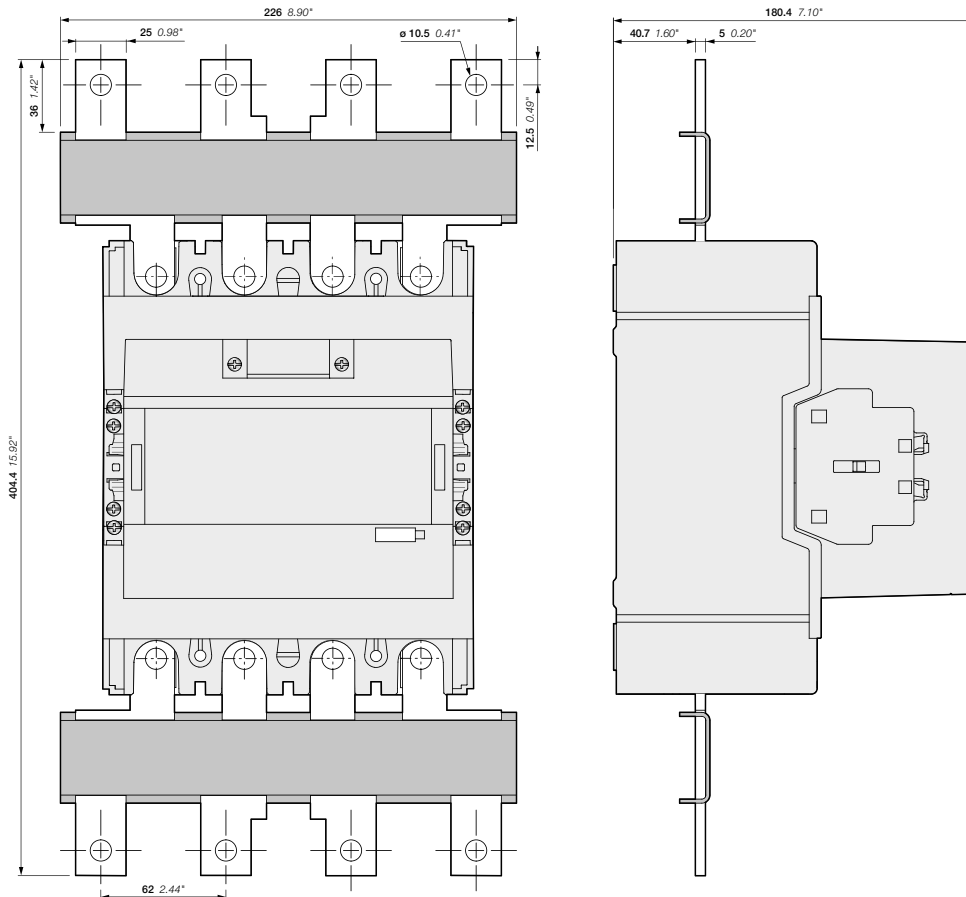

AF265, AF305, AF370-40-11  
+ LW370-40 terminal enlargement

Main dimensions mm, inches

# AF265, AF305, AF370 4-pole contactors

## Dimensions

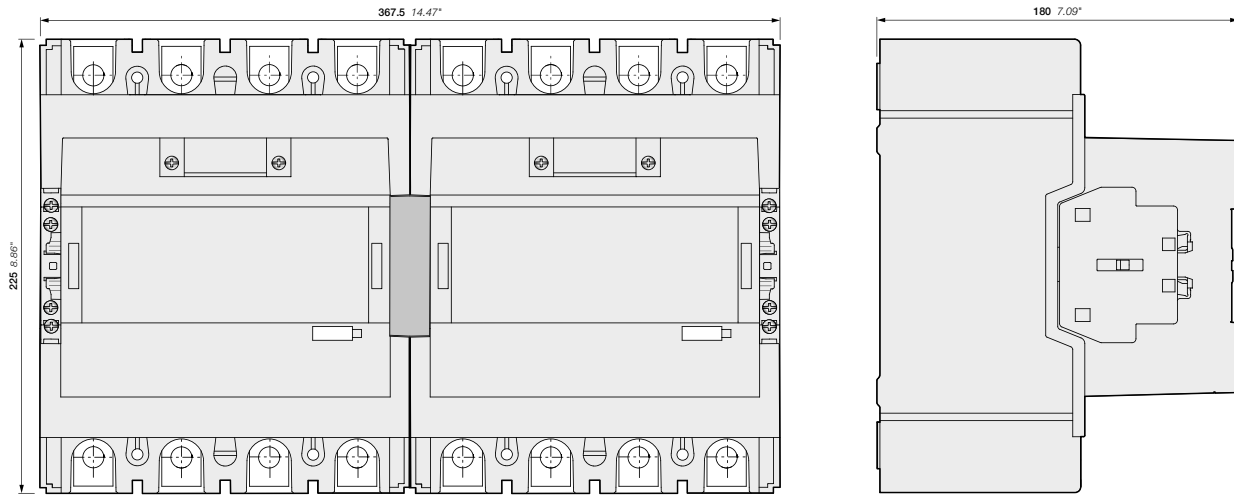

AF265, AF305, AF370-40-11  
+ VM19 mechanical interlocking unit

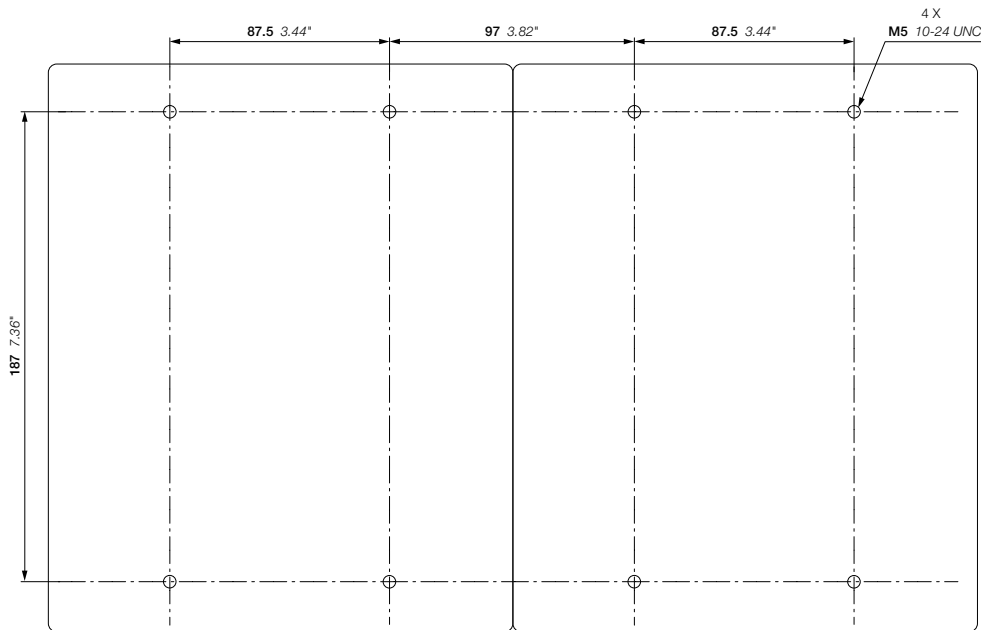

AF265, AF305, AF370  
+ VM19 mechanical interlocking unit

Main dimensions mm, inches

# EK550, EK1000 4-pole contactors AC operated

## Dimensions

03

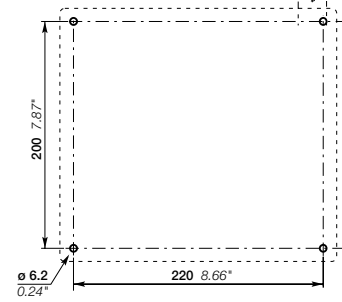
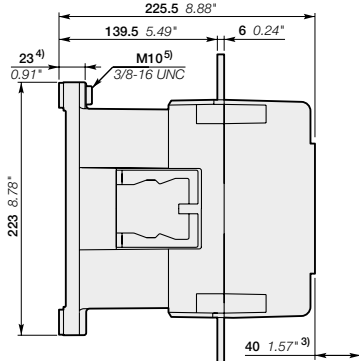
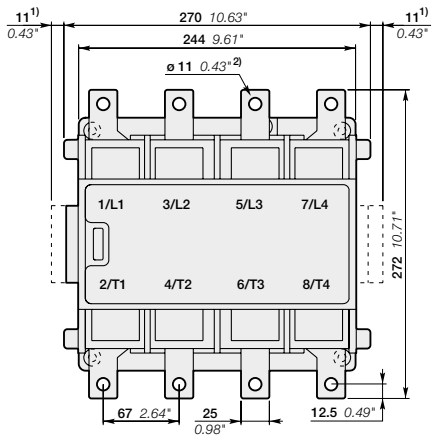

EK550

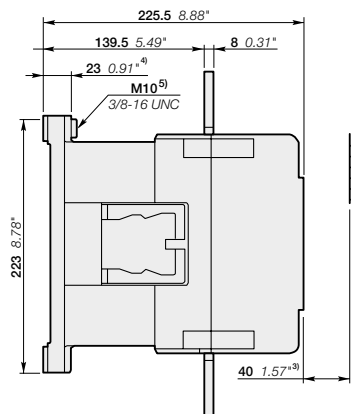
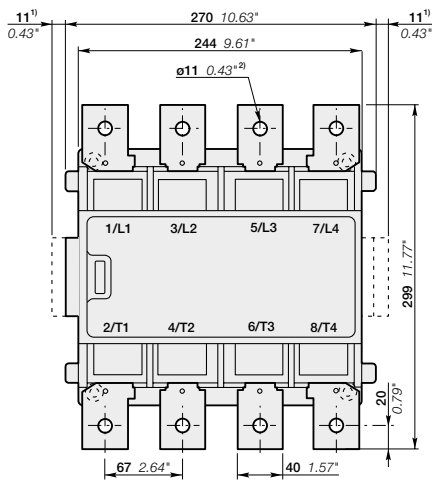

- 1) Dimension for extra auxiliary contact block
- 2) Screw, nut and washer by-packed
- 3) Min. distance to uninsulated wall
- 4) Damping elements are included
- 5) Earthing screw

EK1000

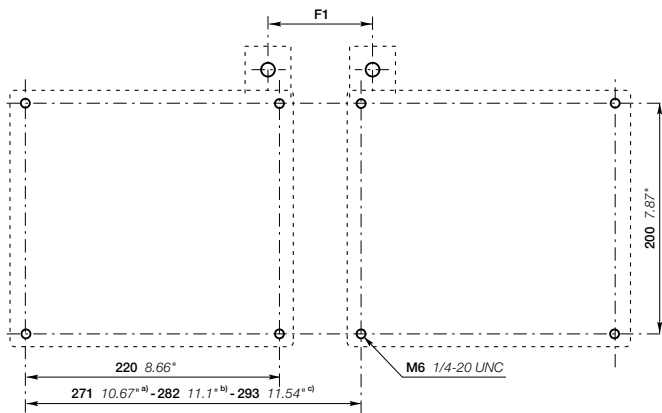

- a) Min. dim Makes distance F1 = 70
- b) Includes space for three auxiliary contact blocks between the contactors
- c) Includes space for four auxiliary contact blocks between the contactors

EK1000

Main dimensions mm, inches

# EK550, EK1000 4-pole contactors DC operated

## Dimensions

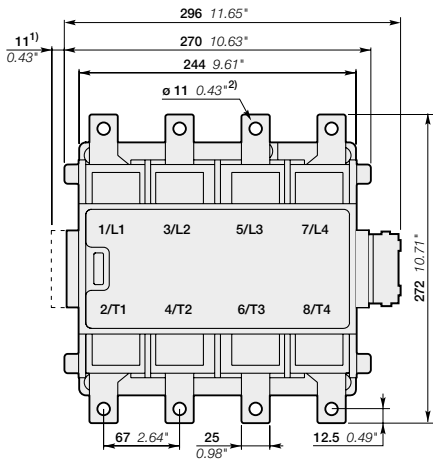

EK550

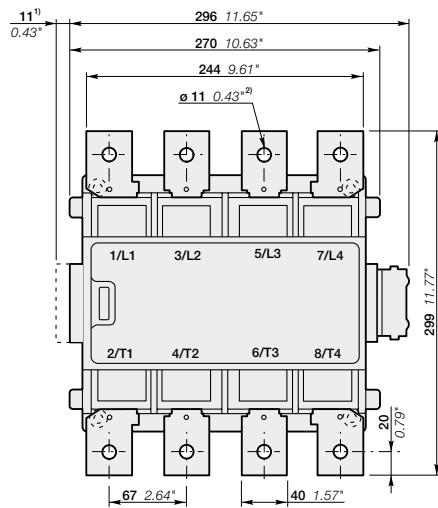
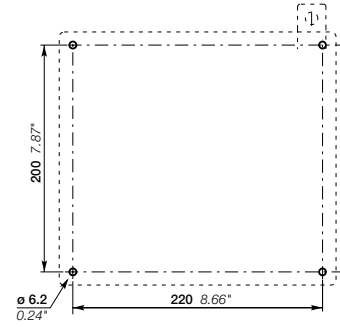
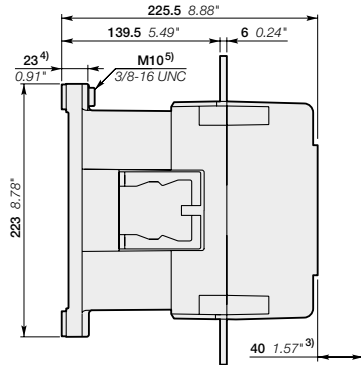

EK1000

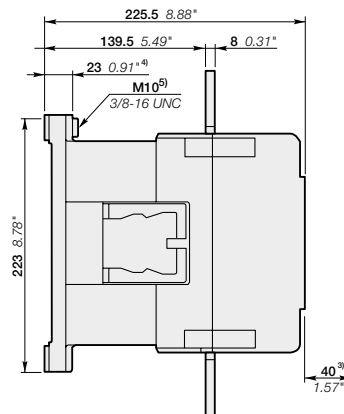

- 1) Dimension for extra auxiliary contact block
- 2) Screw, nut and washer by-packed
- 3) Min. distance to uninsulated wall
- 4) Damping elements are included
- 5) Earthing screw

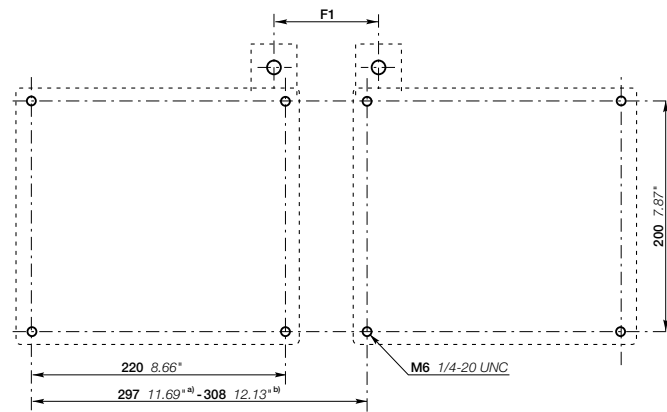

EK1000

- a) Min. dim.
- b) Includes space for two auxiliary contact blocks and the dc-unit between the contactors

Main dimensions mm, inches

# GA75 ... GAF2050 contactors

## Terminal marking and positioning

### GA75 contactors - AC operated

Standard devices without addition of auxiliary contacts

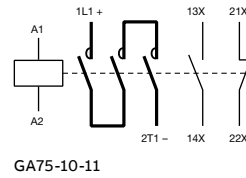
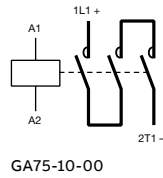
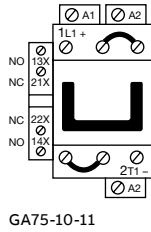
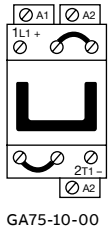

### GAE75 contactors - DC operated

Standard devices without addition of auxiliary contacts

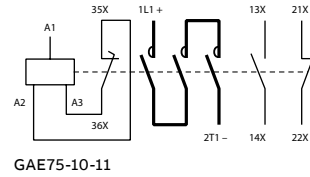
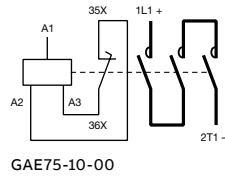
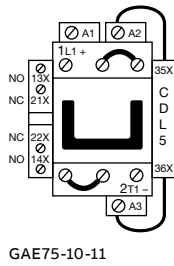
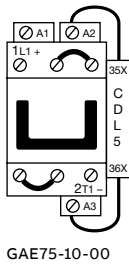

### GAF185 ... GAF2050 contactors - AC / DC operated

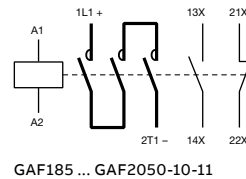
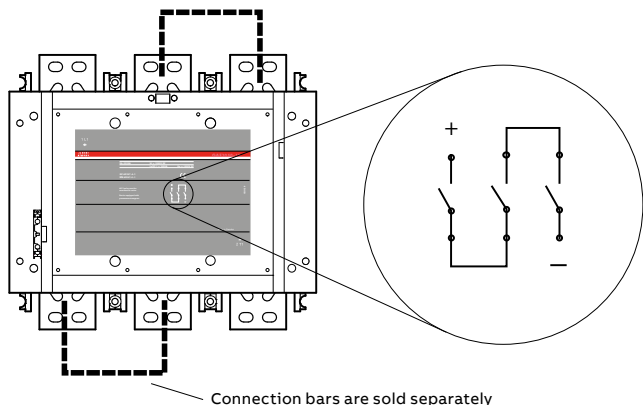

GAF185 ... GAF2050-10-11

GAF185 ... GAF2050-10-11

# GA75, GAE75 1-pole contactor

## Dimensions

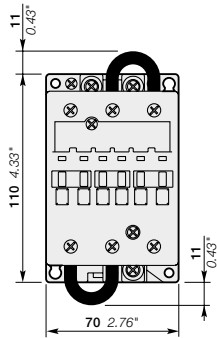

GA75-10-00

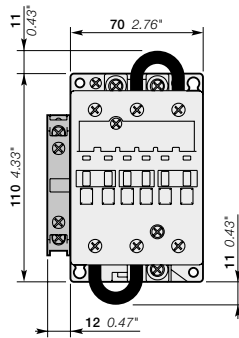

GA75-10-11

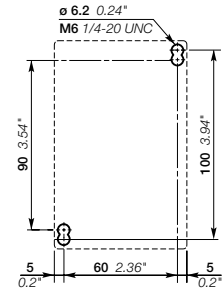
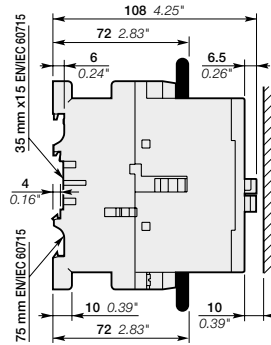

GA75

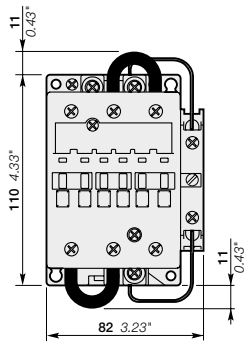

GAE75-10-00

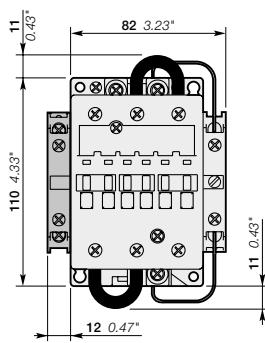

GAE75-10-11

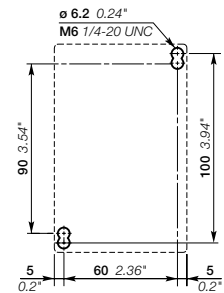
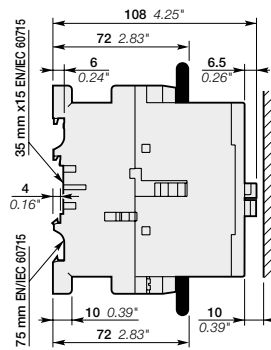

GAE75

Main dimensions mm, inches



# GAF185, GAF300 3-pole contactor

## Dimensions

E3

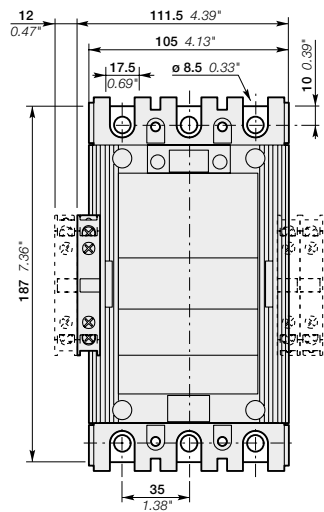

GAF185-30-11

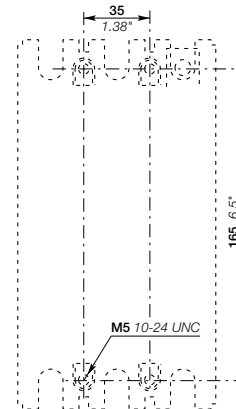
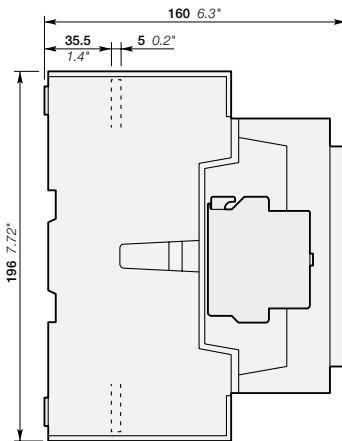

GAF185-30-11

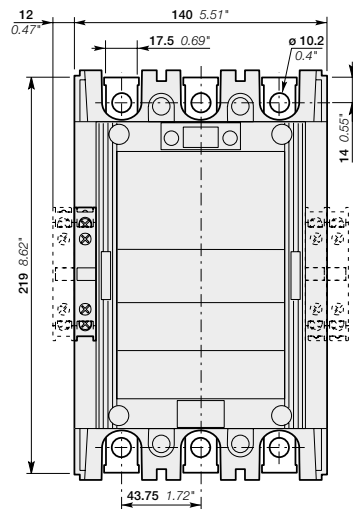

GAF300-30-11

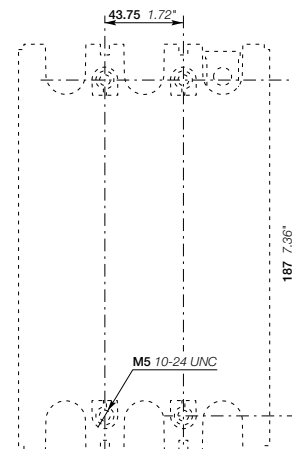
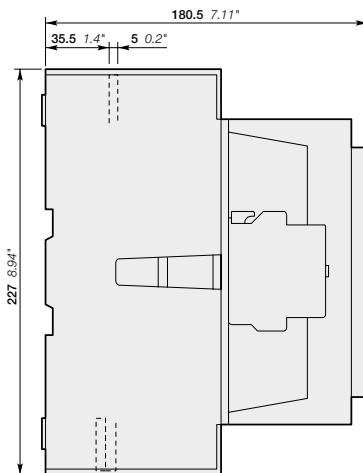

GAF300-30-11

Main dimensions mm, inches

# GAF460 3-pole contactor

## Dimensions

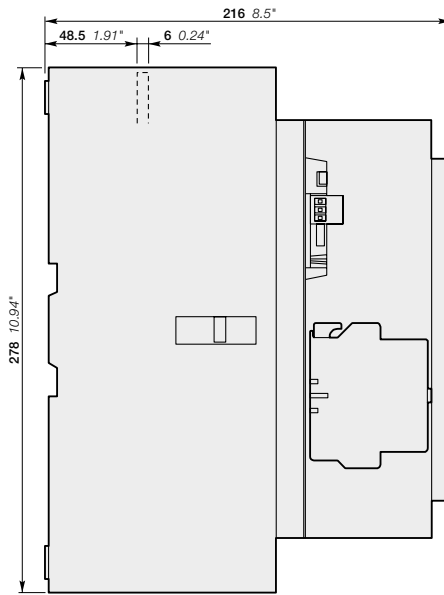
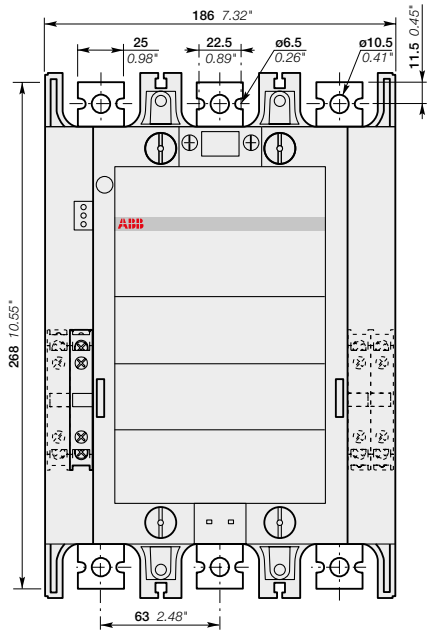

GAF460-30-11

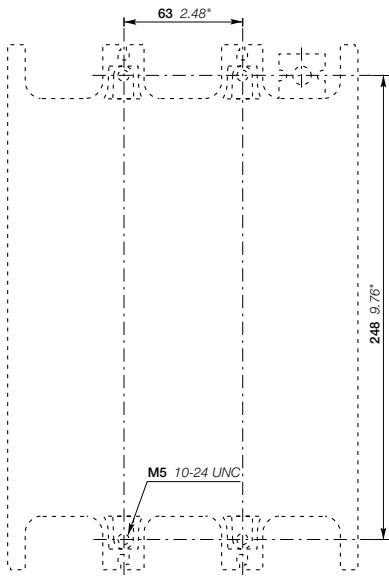

Main dimensions mm, inches

# GAF750 3-pole contactor

## Dimensions

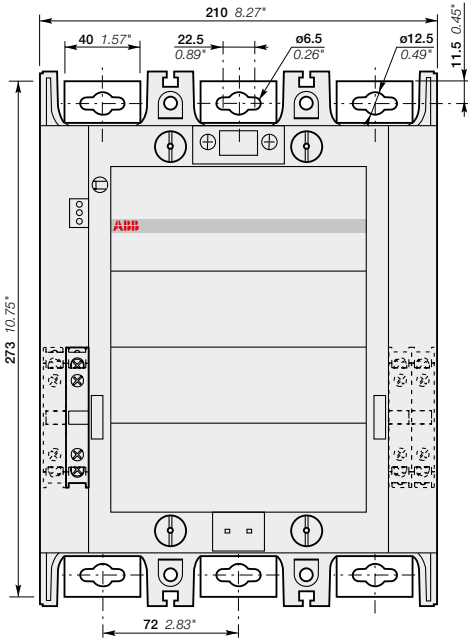

GAF750-30-11

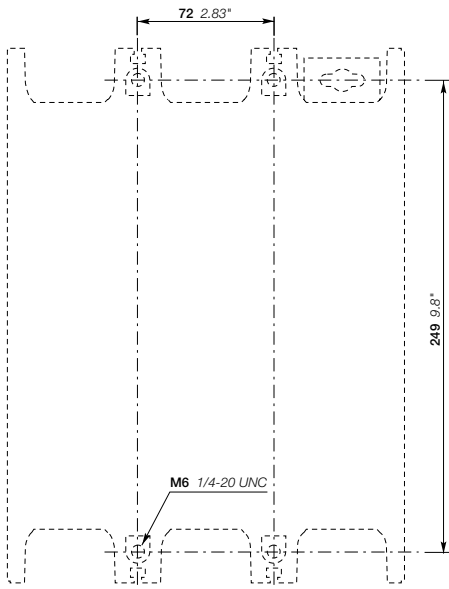
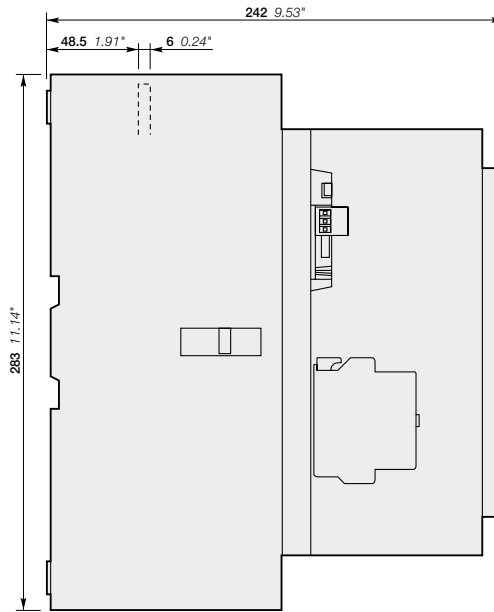

Main dimensions mm, inches

# GAF1250 3-pole contactor

## Dimensions

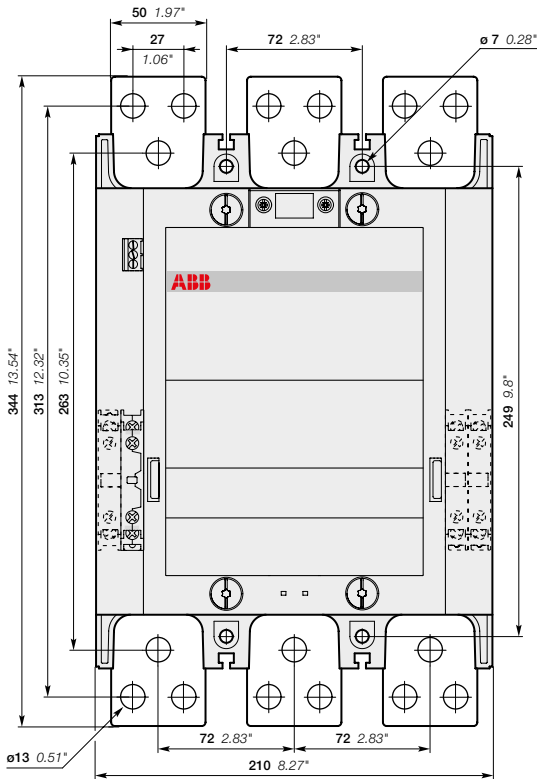

GAF1250-30-11

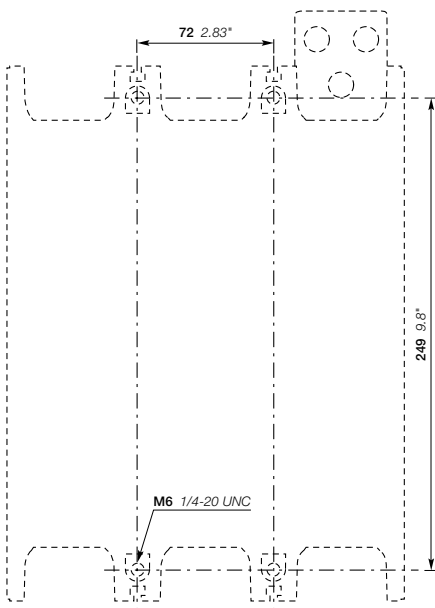
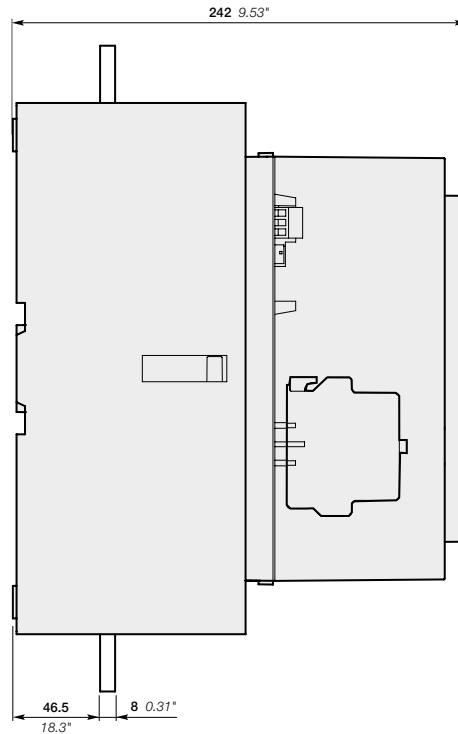

Main dimensions mm, inches

# GAF1650, GAF2050 3-pole contactor

## Dimensions

EO

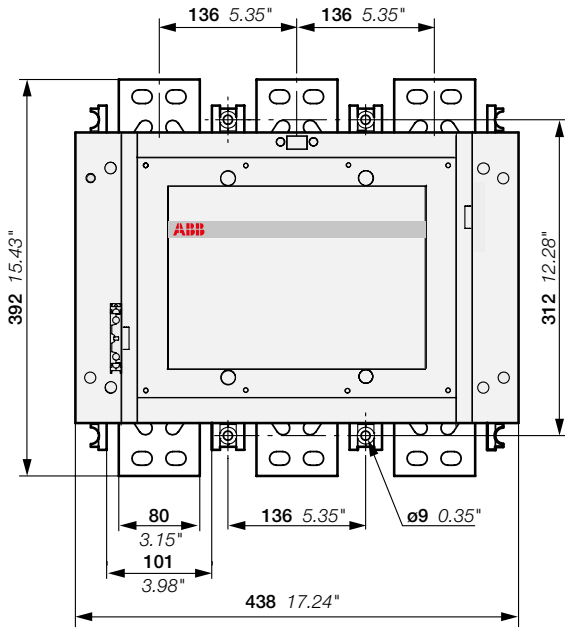
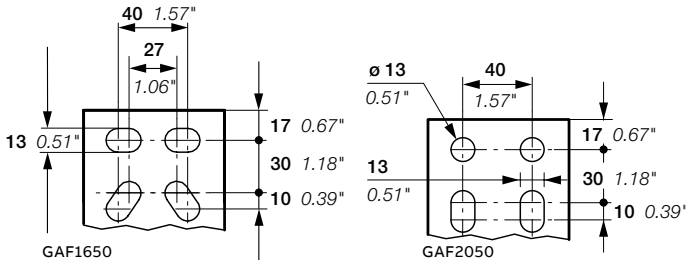

GAF1650, GAF2050-30-11

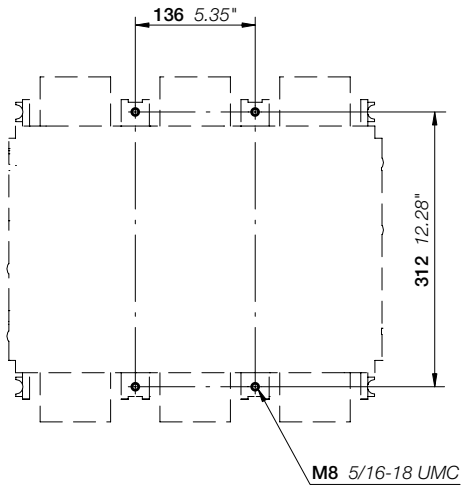
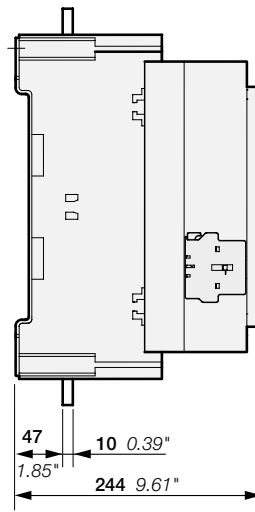

Main dimensions mm, inches

# UA..RA 3-pole contactors for capacitor switching

Unlimited peak current  $\hat{I}$

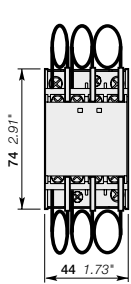

UA16..RA

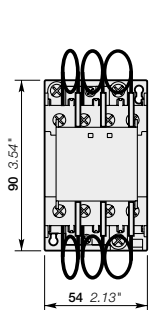
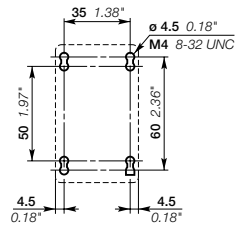
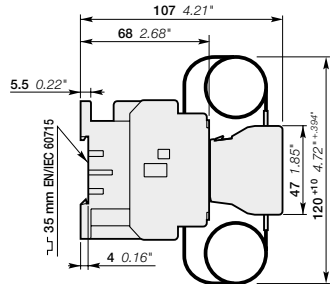

UA26..RA

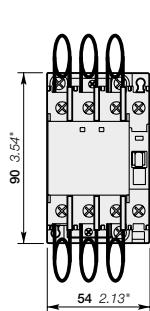
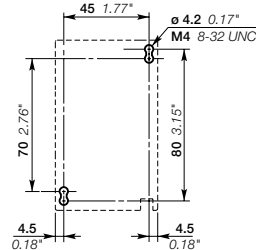
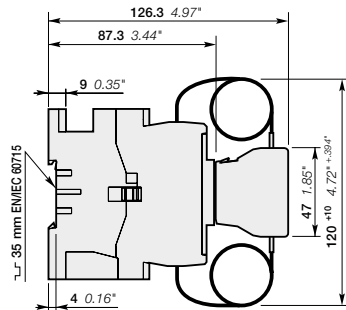

UA30..RA

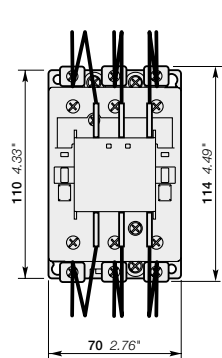
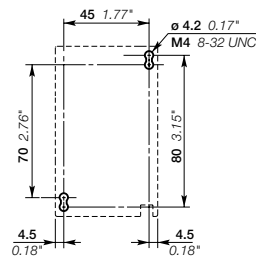
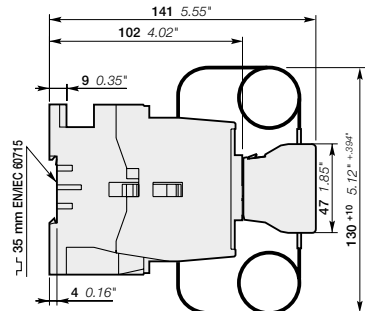

UA50..RA, UA63..RA, UA75..RA

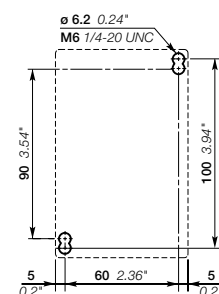
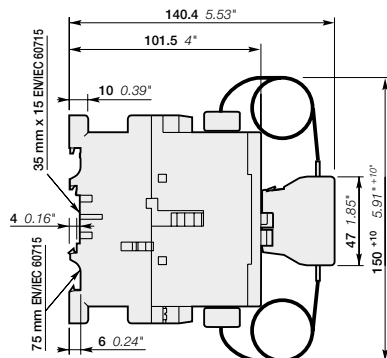

Main dimensions mm, inches

# UA..RA 3-pole contactors for capacitor switching

Unlimited peak current  $\hat{I}$

03

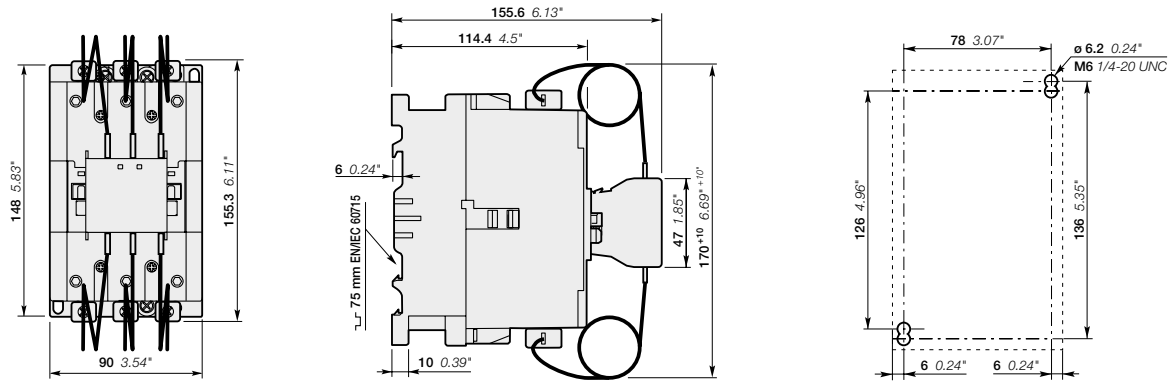

UA95..RA, UA110..RA

Main dimensions mm, inches

# UA.. 3-pole contactors for capacitor switching

## Dimensions

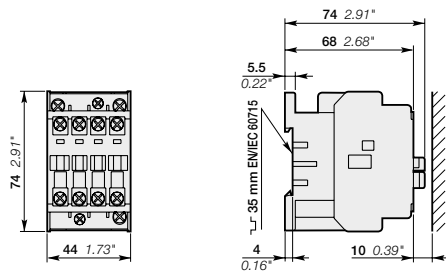

UA16

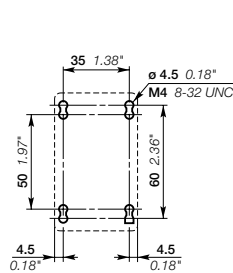

UA16 drilling plan

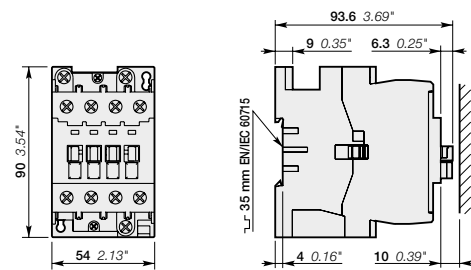

UA26

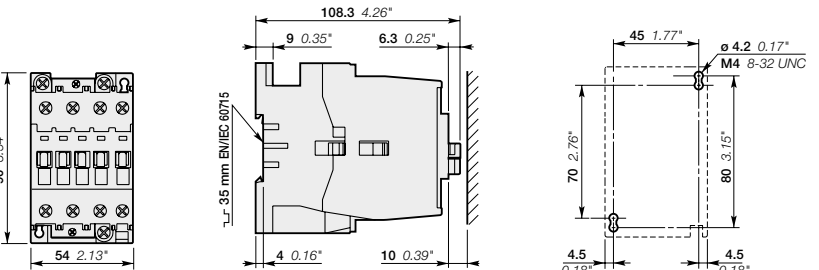

UA26, UA30 drilling plan

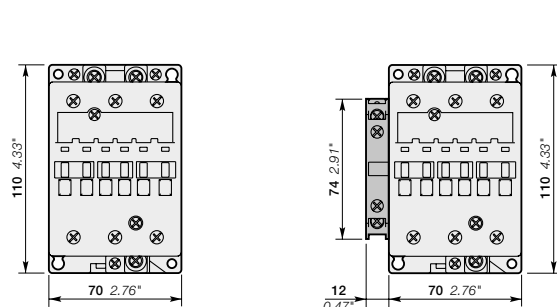

UA50, UA63, UA75-30-00

UA50, UA63, UA75-30-11

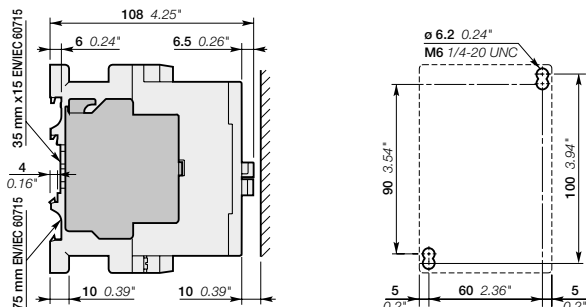

Drilling plan

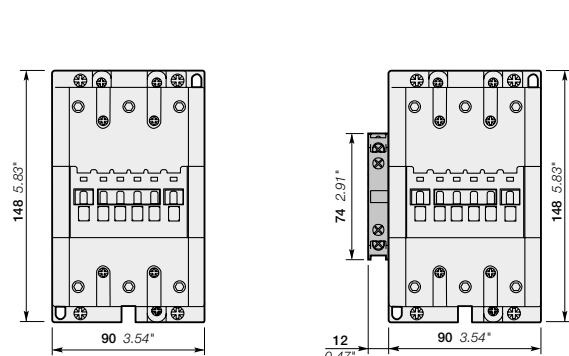

UA95, UA110-30-00

UA95, UA110-30-11

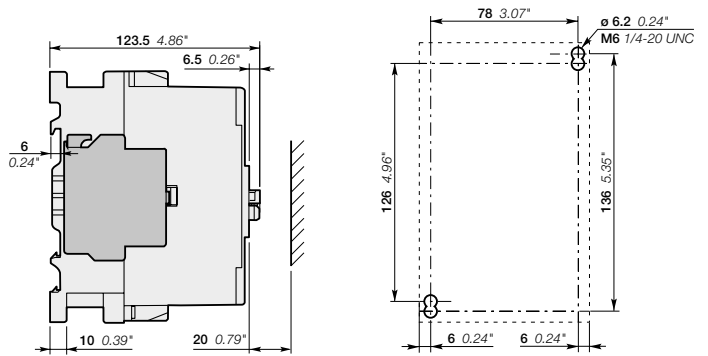

Drilling plan

Main dimensions mm, inches



# NF contactor relays

## Dimensions

E3

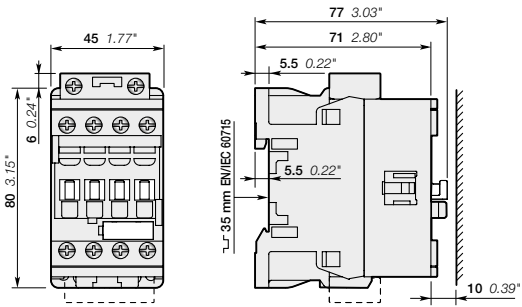

NF..22E, NF..31E, NF..40E

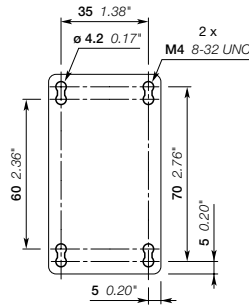

NF

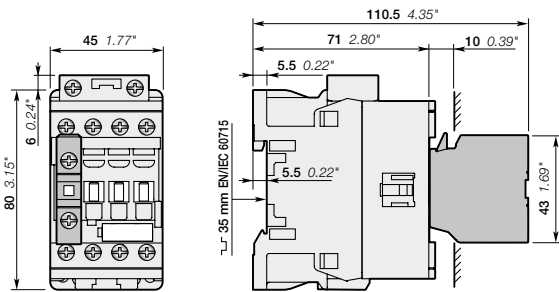

NF..22E, NF..31E, NF..40E  
+ CA4, CC4 1-pole auxiliary contact block

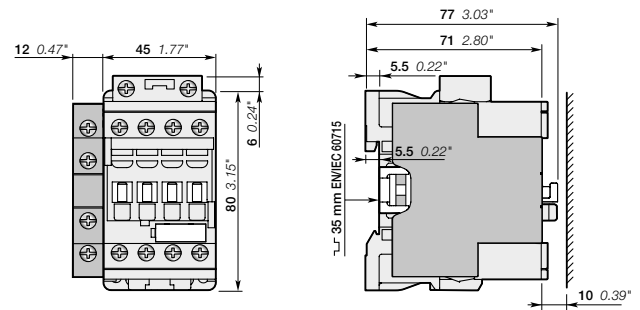

NF..22E, NF..31E, NF..40E  
+ CAL4-11 2-pole auxiliary contact block

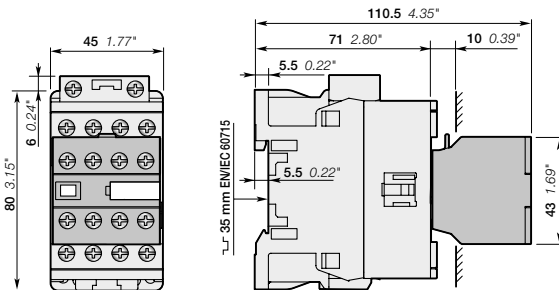

NF..22E, NF..31E, NF..40E  
+ CA4 4-pole auxiliary contact block

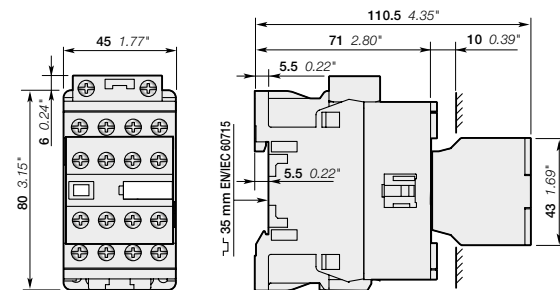

NF..44E, NF..53E, NF..62E, NF..71E, NF..80E, NF..33/11, NF..51/11

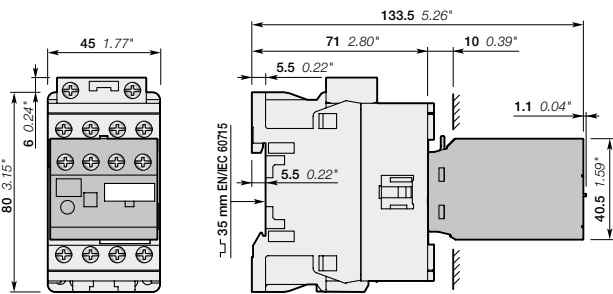

NF..22E, NF..31E, NF..40E  
+ TEFA4 electronic timer

(1) Note: contactor relay lateral distance to grounded component 2 mm 0.08" min.  
24 V DC operated contactor relay (coil 30) depth + 20 mm 0.79".

Main dimensions mm, inches (1)

—  
**Notes**

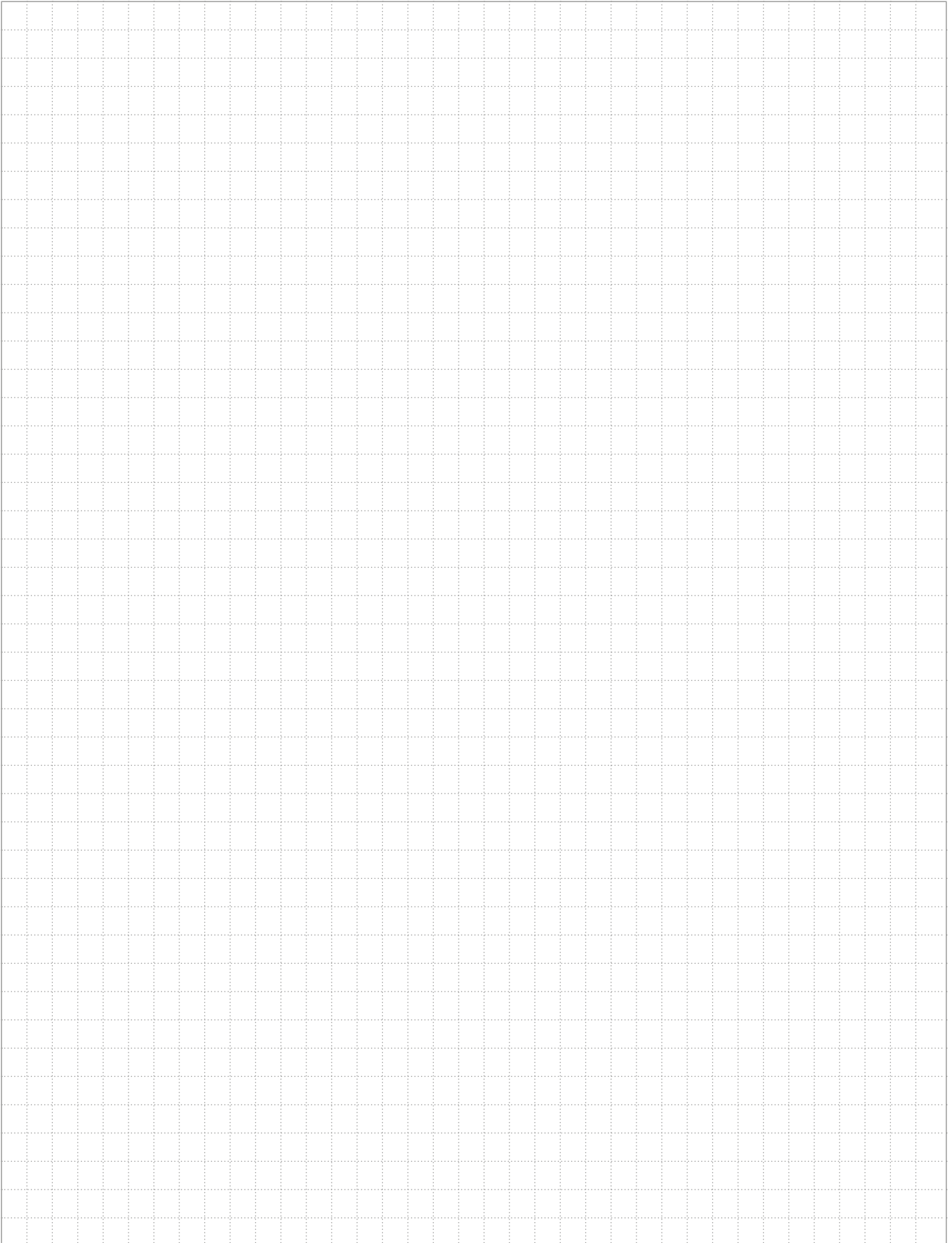



---

# Other contactor application data

## Contactor selection

- 3/386** Control of three-phase slip-ring motors
- 3/388** Autotransformer starters
- 3/389** Three-phase transformer switching
- 3/391** Lighting circuit switching
- 3/400** Parallel connection of main poles
- 3/401** Temporary or intermittent duty
- 3/402** Influence of the length of conductors used in contactor control circuit

## 3/404 Voltage code table

## 3/409 Questionnaire for product specifications



For direct product details information, use product type or order code, ex:

- [www.abb.com/productdetails/AF09-30-10-13](http://www.abb.com/productdetails/AF09-30-10-13)
- or [www.abb.com/productdetails/1SBL137001R1310](http://www.abb.com/productdetails/1SBL137001R1310)

## Control of three-phase slip-ring motors

### Contactors selection

#### General

Three kinds of contactors are used to control three-phase slip-ring motors: the stator contactor, the acceleration contactor(s) and the rotor short-circuit contactor. Refer to the diagram opposite.

The selection tables below concern complete smooth starting, excluding specific cases, such as: intermittent operation, regenerative current, controlled slipping, etc. for which you need to consult our specialised departments.

The starting and breaking technical data for slip-ring motors are defined in standard IEC 60947-4-1 in the AC-2 utilization category. The load factor is defined by the equation:

$$\text{L.F. (\%)} = \frac{\text{Operating cycle}}{\text{Cycle time (Operating cycle + Rest cycle)}} \times 100$$

#### Stator contactor

Closing of the starting current, conditioned by the value of the rotor resistances: it may reach 1.5 to 4 times rated motor operational current.

Breaking of the rated operational current, or of the starting current, with possible regenerative current.

The following table gives the permissible values of the  $I_e$  / AC-2 rated operational stator current, as a function of load factor.

Temperature of 60 °C for AF09 ... AF370 and 55 °C for AF400 ... AF1650 maximum near the contactor.

Maximum switching frequency and electrical durability in AC-2 category: see "Technical data".

Contactor types				AF09	AF12	AF16	AF26	AF30	AF38	AF40	AF52	AF65	AF80	AF96	
Load factor	15 %	$I_e$ / AC-2	A	18	24	33	52	64	76	79	106	124	154	184	
	25 %	$I_e$ / AC-2	A	15	20	31	44	54	65	68	90	111	136	163	
	40 %	$I_e$ / AC-2	A	13	17	26	38	46	55	58	77	94	116	139	
	60 %	$I_e$ / AC-2	A	11	14	22	31	38	46	48	64	78	96	115	
S7 acc. to IEC 60034-1: periodical continuous duty with electrical breaking				A	9	12	18	26	32	38	40	53	65	80	96

#### Acceleration contactors

The sizing of these contactors is based on the AC-1 rated operational current (see "Technical data") that we recall below for the maximum ambient temperature of 60 °C for AF09 to AF370 and 55 °C for AF400 to AF1650.

The table below lists the factors to be applied to the AC-1 current of the contactors in order to obtain the maximal permissible value of the rotor current after contactor closing for star connection. If delta connection is used, increase by 50 % this current. This table takes into account the number of cycles an hour (without inching) and the current flow time per cycle, in the contactor.

Number of cycles an hour	1	3	6	12	20	30	60	120
Current flow time per cycle	Factors applicable to $I_e$ / AC-1							
5 s	5.2	4.9	4.7	4.3	4.0	3.7	3.4	2.8
10 s	3.8	3.6	3.4	3.1	3.0	2.8	2.6	2.2
20 s	2.8	2.7	2.6	2.5	2.4	2.2	2.0	1.6
30 s	2.4	2.3	2.2	2.1	2.1	1.9	1.7	-
40 s	2.2	2.1	2.0	1.9	1.9	1.7	1.5	-
60 s	1.9	1.8	1.8	1.7	1.7	1.5	-	-

Contactors	AF09	AF12	AF16	AF26	AF30	AF38	AF40	AF52	AF65	AF80	AF96
Rated operational current $I_e$ / AC-1 for air temperature near the contactor $\leq$ 60 °C	A 25	28	30	40	42	42	60	80	90	100	105

#### Rotor short-circuit contactor

The duty of this contactor is characterized by small closing stresses. The decisive factor is the thermal stress. Delta connection of the contactor is considered (reduce currents by 35 % if star connection is used).

The following table gives the permissible values of the rated operational rotor current, as a function of load factor.

Temperature: 60 °C for AF09 to AF370 and 55 °C for AF400 to AF1650 maximum near the contactor.

Contactor types				AF09	AF12	AF16	AF26	AF30	AF38	AF40	AF52	AF65	AF80	AF96
Load factor	15 %	$I_e$	A	63	71	76	102	107	107	152	203	228	254	266
	25 %	$I_e$	A	57	64	69	92	96	96	137	183	206	229	241
	40 %	$I_e$	A	49	55	59	78	82	82	117	157	176	196	206
	60 %	$I_e$	A	43	48	51	68	72	72	103	137	154	171	180
S7 acc. to IEC 60034-1: periodical continuous duty with electrical breaking				A	36	41	44	58	61	87	116	131	145	152
Rated operational rotor voltage:														
- Maximum values for starting and breaking				V	1380 (1600 in star connection)								2000 (2300 in star connection)	
- Maximum values for starting and electrical braking				V	690 (730 in star connection)								690 (730 in star connection)	

# Control of three-phase slip-ring motors

## Contactor selection

### Example of a three-stroke starter

- The first stroke corresponds to energization of the motor by the stator contactor: all the resistances are operational in the rotor circuit
- At the second stroke, the acceleration contactor short-circuits the first resistance stack
- At the third stroke, the rotor short-circuit contactor is activated by eliminating the last resistance stack, thus completing the starting period.

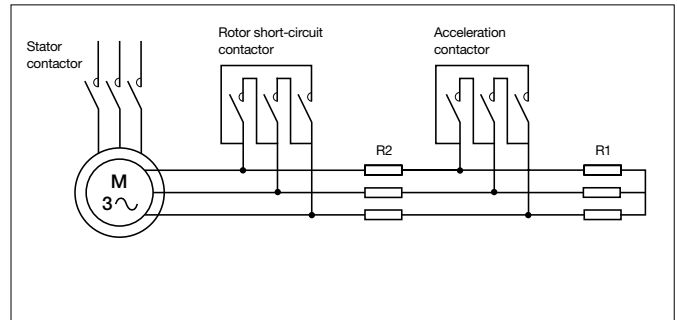

Contactor types				AF116	AF140	AF190	AF205	AF265	AF305	AF370	AF400	AF460	AF580	AF750	AF1350	AF1650
Load factor	15 %	le / AC-2	A	220	335	360	425	530	625	750	850	950	1150	1500	1720	2100
	25 %	le / AC-2	A	185	270	300	350	440	515	620	680	780	975	1250	1430	1750
	40 %	le / AC-2	A	150	215	250	300	370	430	515	580	650	800	1050	1200	1470
	60 %	le / AC-2	A	135	180	220	255	315	370	430	480	550	700	900	1030	1250
S7 acc. to IEC 60034-1: periodical continuous duty with electrical breaking			A	116	140	190	210	265	305	370	400	460	580	750	860	1050

Contactors		AF116	AF140	AF190	AF205	AF265	AF305	AF370	AF400	AF460	AF580	AF750	AF1350	AF1650
Rated operational current $I_e$ / AC-1 for air temperature near the contactor $\leq 60^\circ\text{C}$ (AF116-AF370) $\leq 55^\circ\text{C}$ (AF400-AF1650)	A	145	175	250	300	350	400	500	500	600	700	800	1150	1450

Contactor types				AF116	AF140	AF190	AF205	AF265	AF305	AF370	AF400	AF460	AF580	AF750	AF1350	AF1650	
Load factor	15 %	le	A	330	540	580	750	830	950	1050	1200	1400	1650	1900	2400	2800	
	25 %	le	A	300	490	530	650	725	830	915	1050	1250	1450	1650	2100	2500	
	40 %	le	A	260	425	460	575	630	720	800	950	1100	1300	1450	1850	2200	
	60 %	le	A	230	375	400	500	575	650	700	810	975	1150	1300	1650	1950	
S7 acc. to IEC 60034-1: periodical continuous duty with electrical breaking			A	200	300	350	380	480	550	640	700	840	980	1150	1500	1800	
Rated operational rotor voltage:																	
- Maximum values for starting and breaking	V	2200 (2600 in star connection)						3000 (3600 in star connection)									
- Maximum values for starting and electrical braking	V	690 (730 in star connection)															

# Autotransformer starters

## Contactor selection

### General

An autotransformer starter allows to start a squirrel cage motor with a reduced starting current due to the reduced voltage within the accelerating duration. Unlike the star-delta wiring, this autotransformer starting method needs three wires and three terminals on the motor. At the starting period, the motor is wired to the autotransformer taps: the star contactor "KM3" and the autotransformer contactor "KM2" are closed, the motor is under reduced voltage. Consequently, the torque is reduced as the square of the applied voltage. The autotransformers are generally equipped of three taps at each phase in order to adapt the starting parameters to the field requirements. When the motor reaches 80...95 % of its nominal speed, the star contactor opens. Then, the line contactor "KM1" is making and the autotransformer contactor is opening. This starting process is done without any network interruption.

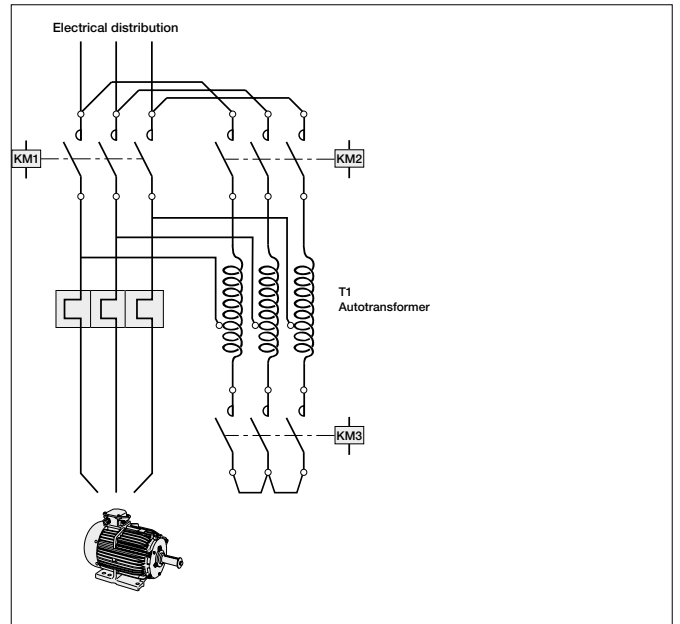

Selection Table (I<sub>d</sub> starting current / I<sub>n</sub> nominal current < 8 - Acceleration time ≤ 20s - 30 cycles / h max.)

kW motor ratings 50/60 Hz					Contactors					
					KM1 line	KM2 autotransformer taps:			KM3 star	
220/240 V	380/400 V	415 V	440 V	690 V		90 %	80 %	70 %	60 %	
4	7.5	7.5	7.5	9	AF16	AF16	AF12	AF09	AF09	AF09
6.5	11	11	11	15	AF26	AF26	AF16	AF16	AF09	AF16
11	18.5	18.5	18.5	22	AF38	AF30	AF26	AF26	AF16	AF26
15	22	30	30	30	AF52	AF52	AF38	AF30	AF26	AF30
18.5	30	37	37	37	AF65	AF52	AF40	AF30	AF26	AF38
22	37	45	45	45	AF80	AF65	AF52	AF40	AF30	AF40
25	45	55	55	55	AF96	AF80	AF65	AF52	AF38	AF52
30	55	55	75	55	AF116	AF116	AF80	AF65	AF52	AF65
37	75	75	90	75	AF140	AF140	AF96	AF80	AF65	AF65
45	75	75	90	90	AF146	AF140	AF96	AF80	AF65	AF65
55	90	90	110	132	AF190	AF146	AF116	AF96	AF65	AF80
55	110	110	132	160	AF205	AF190	AF140	AF116	AF80	AF96
75	132	132	160	200	AF265	AF265	AF190	AF140	AF96	AF116
90	160	160	160	250	AF305	AF265	AF205	AF190	AF116	AF140
110	200	200	200	315	AF370	AF370	AF265	AF190	AF140	AF190
132	250	250	250	355	AF460	AF400	AF305	AF265	AF190	AF205
160	315	355	355	500	AF580	AF580	AF400	AF305	AF205	AF305
220	400	425	450	600	AF750	AF750	AF580	AF400	AF305	AF400
257	475	500	560	900	AF1350	AF750	AF580	AF460	AF400	AF460
315	560	600	670	1000	AF1650	AF1350	AF750	AF580	AF460	AF580



# Three-phase transformer switching

## Contactors selection

### AC-6a Utilization category according to IEC 60947-4-1

#### General

Switching the primary of 3-phase transformers, on energization of the transformer, is characterized by high current peaks due to the magnetization phenomena.

#### Selection Table

The tables below show the operational ratings for:

- current peaks up to 20 to 30 times the transformer nominal current
- maximum switching frequency of 60 operating cycles per hour
- air ambient temperature ≤ 40 °C.

AC / DC operated contactors	AF09	AF12	AF16	AF26	AF30	AF38	AF40	AF52	AF65	AF80	AF96	
Operational power at Ue: 50/60 Hz - according to AC-6a												
220 / 240 V	kVA	4	5	6	10	13	14	15	19	21	23	25
380 / 400 V	kVA	7	8	10	17	22	25	26	33	36	39	44
415 / 440 V	kVA	8	9	11	18	24	27	28.5	36	40	43	48
500 V	kVA	9	11	13	22	28	32	34.5	43	48	52	57
660 / 690 V	kVA	12.5	14	18	29	37	43	45.5	57	64	68	75
Max. permissible I <sub>peak</sub>	A	350	400	500	800	1000	1200	1250	1550	1750	1900	2100

AC / DC operated contactors	AF116	AF140	AF190	AF205	AF265	AF305	AF370	AF400	AF460	AF580	AF750	AF1350	AF1650	
Operational power at Ue: 50/60 Hz - according to AC-6a														
220 / 240 V	kVA	26	30	42	45	55	63	76	95	100	110	130	160	190
380 / 400 V	kVA	46	52	73	75	94	108	132	165	170	190	240	275	350
415 / 440 V	kVA	50	57	80	80	103	118	144	180	190	210	270	325	390
500 V	kVA	60	68	96	100	124	143	173	220	230	250	320	-	-
660 / 690 V	kVA	80	90	127	130	164	188	228	290	300	310	410	-	-
Max. permissible I <sub>peak</sub>	A	2100	2400	3300	3500	4300	4900	6000	7700	8400	9300	12000	-	-



—  
**Notes**

03

A large rectangular area filled with a grid of small, light gray dotted lines, intended for handwritten notes.

## Lighting circuit switching

### Contactor selection

#### General

Contactor selection criteria for control of lighting circuits are as follows:

- type, power rating and number of lamps
- connection mode
- current values on closing and in steady state
- power factor
- presence or not of correction capacitors.

#### Lighting circuits

In a given circuit, the number and power rating of lamps are defined and cannot result in overload. Only short-circuit protection has to be provided. gG fuses or modular circuit-breakers will be chosen for this purpose.

The lamps have very specific technical data, according to their construction type.

- Incandescent lamps have a very high current on closing: more than 15 times nominal current. They do not introduce a large phase displacement between current and voltage
- Fluorescent tubes are equipped with a ballast whose purpose is two-fold: contribute to ignition and limit current to nominal value once steady state is reached. This ballast is a reactor that considerably lowers the power factor. It may or may not be compensated.

Individual compensation  
(parallel compensation)

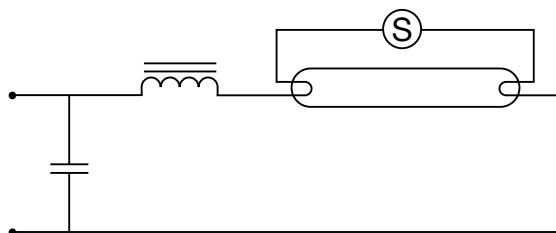

Serial compensation in dual mounting

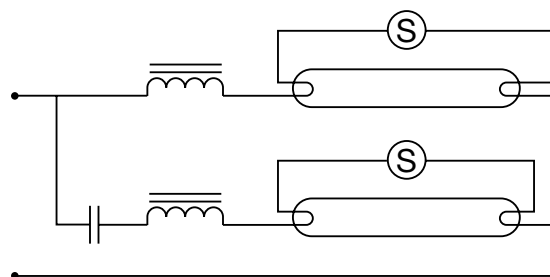

#### Selection of contactors

The following tables indicate, for each contactor type, the maximum permissible number of lamps per phase. Air temperature, near the contactor, must be limited to 60 °C. Numbers are given for a 230 V voltage distributed between phase and neutral: single-phase (phase + neutral) or three-phase (3 phases + neutral) distribution, lamps are wired in star connection. In the case of a three-phase supply without neutral, 230 V phase-to-phase, the permissible number of lamps per phase will be that given in the tables multiplied by 0.58.

#### Example:

120 x 100 W / 230 V incandescent lamps - 400 V three-phase network with distributed neutral.

Calculate the number of lamps per phase:  $120 : 3 = 40$ . On the 100 W line of the incandescent lamp table, contactor AF09 is limited to 38 lamps per phase, you must thus select contactor AF12 which accepts up to 43 lamps per phase.

## Lighting circuit switching

Contactor selection AF09 ... AF146 3-pole contactors

### Selection table

3-pole AC / DC operated contactors			AF09	AF12	AF16	AF26	AF30	AF38	AF40	AF52	AF65	AF80	AF96	AF116	AF140	AF146
Lamp characteristics			Maximum permissible number of lamps per phase													
W	A	μF														

#### Incandescent and halogen lamps

according to AC-5b

##### Voltage: 220/240 V AC

60	0.27	-	64	72	77	103	129	148	177	207	233	259	277	430	519	541
100	0.45	-	38	43	46	62	77	89	106	124	140	155	166	258	311	324
200	0.91	-	19	21	23	30	38	44	52	61	69	77	82	127	154	160
300	1.37	-	12	14	15	20	25	29	35	41	46	51	54	85	102	107
500	2.28	-	7	8	9	12	15	17	21	24	27	30	33	51	61	64
1000	4.55	-	3	4	4	6	7	8	10	12	13	15	16	25	31	32

#### Fluorescent lamps without compensation - Fluorescent lamps with electronic starter

according to AC-5a

##### Voltage: 220/240 V AC

20	0.38	-	46	51	55	73	84	92	126	147	157	184	210	305	368	384
40	0.45	-	38	43	46	62	71	77	106	124	133	155	177	258	311	324
65	0.70	-	25	27	30	40	45	50	68	80	85	100	114	166	200	209
80	0.80	-	21	24	26	35	40	43	60	70	75	87	100	145	175	183
100	1.15	-	15	16	18	24	27	30	41	48	52	60	69	101	122	127
110	1.20	-	14	16	17	23	26	29	40	46	50	58	66	97	117	122

#### Fluorescent lamps with parallel compensation

according to AC-5a

##### Voltage: 220/240 V AC

20	0.18	5	53	53	53	155	168	176	266	309	325	388	444	644	778	811
40	0.26	5	53	53	53	107	123	134	184	215	230	269	307	446	538	562
65	0.42	7	37	37	37	66	76	83	114	133	142	166	190	276	333	348
80	0.52	7	33	37	37	53	61	67	92	107	115	134	153	223	269	281
100	0.65	16	16	16	16	43	49	53	73	86	92	107	123	178	215	225
110	0.70	18	14	14	14	40	45	49	68	80	85	100	114	166	200	209

#### Fluorescent lamps in dual mounting

according to AC-5a

##### Voltage: 220/240 V AC

2 x 20	2 x 0.14	-	62	69	75	100	114	125	171	200	214	250	285	414	500	521
2 x 40	2 x 0.25	-	35	39	42	56	64	70	96	112	120	140	160	232	280	292
2 x 65	2 x 0.40	-	21	24	26	35	40	43	60	70	75	87	100	145	175	183
2 x 80	2 x 0.48	-	18	20	21	29	33	36	50	58	62	72	83	121	146	152
2 x 100	2 x 0.60	-	14	16	17	23	26	29	40	46	50	58	66	97	117	122
2 x 110	2 x 0.65	-	13	15	16	21	24	26	36	43	46	53	61	89	108	112

#### Compact fluorescent lamps

according to AC-5a

##### Voltage: 220/240 V AC

5	0.045	-	388	433	466	622	711	777	1066	1244	1333	1555	1777	2578	3111	3244
7	0.075	-	233	260	280	373	426	466	640	746	800	933	1066	1547	1867	1947
11	0.105	-	166	185	200	266	304	333	457	533	571	666	761	1105	1333	1390
15	0.135	-	129	144	155	207	237	259	355	414	444	518	592	859	1037	1081
20	0.160	-	109	121	131	175	200	218	300	350	375	437	500	725	875	913
23	0.180	-	97	108	116	155	177	194	266	311	333	388	444	644	778	811

# Lighting circuit switching

Contactor selection AF190 ... AF2650 3-pole contactors

## Selection table

3-pole AC / DC operated contactors			AF190	AF205	AF265	AF305	AF370	AF400	AF460	AF580	AF750	AF1250	AF1350	AF1650	AF2050	AF2650
Lamp characteristics			Maximum permissible number of lamps per phase													
W	A	μF														

### Incandescent and halogen lamps

according to AC-5b

#### Voltage: 220/240 V AC

60	0.27	-	704	759	981	1130	1370	1481	1704	2148	2778	3009	3250	3972	4935	6380
100	0.45	-	422	456	589	678	822	889	1022	1289	1667	1806	1950	2383	2961	3828
200	0.91	-	209	225	291	335	407	440	505	637	824	893	964	1179	1464	1893
300	1.37	-	139	150	193	223	270	292	336	423	547	593	641	783	973	1257
500	2.28	-	83	90	116	134	162	175	202	254	329	356	385	470	584	755
1000	4.55	-	42	45	58	67	81	88	101	127	165	179	193	236	293	379

### Fluorescent lamps without compensation - Fluorescent lamps with electronic starter

according to AC-5a

#### Voltage: 220/240 V AC

20	0.38	-	500	539	697	803	974	1053	1211	1526	1974	2138	2309	2822	3507	4533
40	0.45	-	422	456	589	678	822	889	1022	1289	1667	1806	1950	2383	2961	3828
65	0.70	-	271	293	379	436	529	571	657	829	1071	1161	1254	1532	1904	2461
80	0.80	-	238	256	331	381	463	500	575	725	938	1016	1097	1341	1666	2153
100	1.15	-	165	178	230	265	322	348	400	504	652	707	763	933	1159	1498
110	1.20	-	158	171	221	254	308	333	383	483	625	677	731	894	1110	1435

### Fluorescent lamps with parallel compensation

according to AC-5a

#### Voltage: 220/240 V AC

20	0.18	5	1056	1139	1472	1694	2056	2222	2556	3222	4167	4514	4875	5958	7403	9569
40	0.26	5	731	788	1019	1173	1423	1538	1769	2231	2885	3125	3375	4125	5125	6625
65	0.42	7	452	488	631	726	881	952	1095	1381	1786	1935	2089	2554	3173	4101
80	0.52	7	365	394	510	587	712	769	885	1115	1442	1563	1688	2063	2563	3313
100	0.65	16	292	315	408	469	569	615	708	892	1154	1250	1350	1650	2050	2650
110	0.70	18	271	293	379	436	529	571	657	829	1071	1161	1254	1532	1904	2461

### Fluorescent lamps in dual mounting

according to AC-5a

#### Voltage: 220/240 V AC

2 x 20	2 x 0.14	-	679	732	946	1089	1321	1429	1643	2071	2679	2902	3134	3830	4759	6152
2 x 40	2 x 0.25	-	380	410	530	610	740	800	920	1160	1500	1625	1755	2145	2665	3445
2 x 65	2 x 0.40	-	238	256	331	381	463	500	575	725	938	1016	1097	1341	1666	2153
2 x 80	2 x 0.48	-	198	214	276	318	385	417	479	604	781	846	914	1117	1388	1794
2 x 100	2 x 0.60	-	158	171	221	254	308	333	383	483	625	677	731	894	1110	1435
2 x 110	2 x 0.65	-	146	158	204	235	285	308	354	446	577	625	675	825	1025	1325

### Compact fluorescent lamps

according to AC-5a

#### Voltage: 220/240 V AC

5	0.045	-	4222	4556	5889	6778	8222	8889	10222	12889	16667	18056	19500	23833	29611	38278
7	0.075	-	2533	2733	3533	4067	4933	5333	6133	7733	10000	10833	11700	14300	17767	22967
11	0.105	-	1810	1952	2524	2905	3524	3810	4381	5524	7143	7738	8357	10214	12690	16405
15	0.135	-	1407	1519	1963	2259	2741	2963	3407	4296	5556	6019	6500	7944	9870	12759
20	0.160	-	1188	1281	1656	1906	2313	2500	2875	3625	4688	5078	5484	6703	8328	10766
23	0.180	-	1056	1139	1472	1694	2056	2222	2556	3222	4167	4514	4875	5958	7403	9569

## Lighting circuit switching

Contactor selection AF09 ... AF146 3-pole contactors

### Selection table

3-pole AC / DC operated contactors			AF09	AF12	AF16	AF26	AF30	AF38	AF40	AF52	AF65	AF80	AF96	AF116	AF140	AF146
Lamp characteristics			Maximum permissible number of lamps per phase													
W	A	μF														

### Low pressure sodium vapour lamps without compensation

Voltage: 220/240 V AC

35	1.4	-	9	10	12	15	15	16	23	31	35	39	42	70	85	89
55	1.4	-	9	10	12	15	15	16	23	31	35	39	42	70	85	89
90	2.1	-	6	7	8	10	10	10	15	20	23	26	28	47	57	59
135	3.1	-	4	4	5	6	7	7	10	14	15	17	19	32	38	40
180	3.1	-	4	4	5	6	7	7	10	14	15	17	19	32	38	40

### Low pressure sodium vapour lamps with parallel compensation

Voltage: 220/240 V AC

35	0.6	20	12	12	12	35	36	38	55	73	81	91	100	164	198	207
55	0.6	20	12	12	12	35	36	38	55	73	81	91	100	164	198	207
90	0.9	25	10	10	10	23	24	25	36	48	55	61	66	110	132	138
135	0.9	45	5	5	5	18	18	19	34	34	36	57	59	110	132	138
180	0.9	45	5	5	5	18	18	19	34	34	36	57	59	110	132	138

### High pressure sodium vapour lamps without compensation

Voltage: 220/240 V AC

150	1.8	-	7	8	9	11	12	12	18	24	27	30	33	45	54	57
250	3.0	-	4	5	5	7	7	7	11	14	16	18	20	27	33	34
400	4.4	-	3	3	3	4	5	5	7	10	11	12	13	18	22	23
600	6.2	-	2	2	2	3	3	3	5	7	7	8	9	13	16	16
1000	10.3	-	1	1	1	2	2	2	3	4	4	5	5	8	10	10

### High pressure sodium vapour lamps with parallel compensation

Voltage: 220/240 V AC

150	1.0	20	12	12	12	21	22	23	33	43	49	55	60	93	112	117
250	1.5	36	7	7	7	14	14	15	22	29	33	36	40	62	75	78
400	2.5	48	5	5	5	8	8	9	13	17	19	22	24	37	45	47
600	3.3	65	3	3	3	6	6	6	10	13	15	16	18	28	34	35
1000	6.2	100	2	2	2	3	3	3	5	7	7	8	9	15	18	19

### High pressure mercury vapour lamps without compensation

Voltage: 220/240 V AC

50	0.60	-	22	25	28	35	36	38	55	73	82	91	100	152	190	214
80	0.80	-	16	18	21	26	27	28	41	55	61	68	75	114	143	160
125	1.15	-	11	13	14	18	19	20	28	38	43	47	52	79	99	112
250	2.15	-	6	6	7	9	10	10	15	20	23	25	27	42	53	60
400	3.25	-	4	4	5	6	6	7	10	13	15	16	18	28	35	39
700	5.40	-	2	2	3	3	4	4	6	8	9	10	11	17	21	24
1000	7.50	-	1	2	2	2	2	3	4	5	6	7	8	12	15	17

Voltage: 380/415 V AC

2000	8.00	-	1	1	2	2	2	2	4	5	6	6	7	11	14	16
------	------	---	---	---	---	---	---	---	---	---	---	---	---	----	----	----

### High pressure mercury vapour lamps with compensation

Voltage: 220/240 V AC

50	0.28	7	36	36	36	75	78	82	117	157	176	196	214	326	407	458
80	0.43	8	31	31	31	48	51	53	76	102	115	127	139	212	265	298
125	0.66	10	20	22	25	31	33	34	50	66	75	83	90	138	173	194
250	1.28	18	10	11	13	16	17	17	25	34	38	42	46	71	89	100
400	2.05	25	6	7	8	10	10	11	16	21	24	26	29	44	56	63
700	3.55	40	3	4	4	5	6	6	9	12	13	15	16	26	32	36
1000	4.83	60	2	3	3	4	4	4	6	9	10	11	12	19	24	27

Voltage: 380/415 V AC

2000	5.45	35	2	2	3	3	4	4	6	8	9	10	11	17	21	24
------	------	----	---	---	---	---	---	---	---	---	---	----	----	----	----	----

# Lighting circuit switching

Contactor selection AF190 ... AF2650 3-pole contactors

## Selection table

3-pole AC / DC operated contactors			AF190	AF205	AF265	AF305	AF370	AF400	AF460	AF580	AF750	AF1250	AF1350	AF1650	AF2050	AF2650
Lamp characteristics			Maximum permissible number of lamps per phase													
W	A	μF														

### Low pressure sodium vapour lamps without compensation

Voltage: 220/240 V AC

35	1.4	-	115	124	161	185	225	243	279	352	455	493	533	651	809	1046
55	1.4	-	115	124	161	185	225	243	279	352	455	493	533	651	809	1046
90	2.1	-	77	83	107	123	150	162	186	235	304	329	355	434	539	697
135	3.1	-	52	56	73	84	101	110	126	159	206	223	241	294	365	472
180	3.1	-	52	56	73	84	101	110	126	159	206	223	241	294	365	472

### Low pressure sodium vapour lamps with parallel compensation

Voltage: 220/240 V AC

35	0.6	20	269	290	375	432	524	567	652	822	1063	1151	1243	1519	1888	2440
55	0.6	20	269	290	375	432	524	567	652	822	1063	1151	1243	1519	1888	2440
90	0.9	25	179	194	250	288	349	378	434	548	708	767	829	1013	1258	1627
135	0.9	45	179	194	250	288	349	378	434	548	708	767	829	1013	1258	1627
180	0.9	45	179	194	250	288	349	378	434	548	708	767	829	1013	1258	1627

### High pressure sodium vapour lamps without compensation

Voltage: 220/240 V AC

150	1.8	-	74	80	103	119	144	156	179	226	292	313	338	413	513	663
250	3.0	-	44	48	62	71	86	93	107	135	175	188	203	248	308	398
400	4.4	-	30	33	42	49	59	64	73	92	119	128	138	169	210	271
600	6.2	-	21	23	30	34	42	45	52	65	85	91	98	120	149	192
1000	10.3	-	13	14	18	21	25	27	31	39	51	55	59	72	90	116

### High pressure sodium vapour lamps with parallel compensation

Voltage: 220/240 V AC

150	1.0	20	152	164	212	244	296	320	368	464	600	625	675	825	1025	1325
250	1.5	36	101	109	141	163	197	213	245	309	400	417	450	550	683	883
400	2.5	48	61	66	85	98	118	128	147	186	240	250	270	330	410	530
600	3.3	65	46	50	64	74	90	97	112	141	182	189	205	250	311	402
1000	6.2	100	25	26	34	39	48	52	59	75	97	101	109	133	165	214

### High pressure mercury vapour lamps without compensation

Voltage: 220/240 V AC

50	0.60	-	261	333	380	475	570	570	665	760	998	1188	1283	1568	1948	2518
80	0.80	-	196	249	285	356	428	428	499	570	748	891	962	1176	1461	1888
125	1.15	-	136	173	198	248	297	297	347	397	520	620	669	818	1016	1313
250	2.15	-	73	93	106	133	159	159	186	212	278	331	358	437	543	703
400	3.25	-	48	61	70	88	105	105	123	140	184	219	237	289	360	465
700	5.40	-	29	37	42	53	63	63	74	84	111	132	143	174	216	280
1000	7.50	-	21	27	30	38	46	46	53	61	80	95	103	125	156	201

Voltage: 380/415 V AC

2000	8.00	-	20	25	29	36	43	43	50	57	75	89	96	118	146	189
------	------	---	----	----	----	----	----	----	----	----	----	----	----	-----	-----	-----

### High pressure mercury vapour lamps with compensation

Voltage: 220/240 V AC

50	0.28	7	560	713	814	1018	1221	1221	1425	1629	2138	2545	2748	3359	4173	5395
80	0.43	8	365	464	530	663	795	795	928	1060	1392	1657	1790	2187	2717	3513
125	0.66	10	238	302	345	432	518	518	605	691	907	1080	1166	1425	1770	2289
250	1.28	18	122	156	178	223	267	267	312	356	468	557	601	735	913	1180
400	2.05	25	76	97	111	139	167	167	195	222	292	348	375	459	570	737
700	3.55	40	44	56	64	80	96	96	112	128	169	201	217	265	329	425
1000	4.83	60	32	41	47	59	71	71	83	94	124	148	159	195	242	313

Voltage: 380/415 V AC

2000	5.45	35	29	37	42	52	63	63	73	84	110	131	141	173	214	277
------	------	----	----	----	----	----	----	----	----	----	-----	-----	-----	-----	-----	-----

## Lighting circuit switching

Contactor selection AF09 ... AF146 3-pole contactors

### Selection table

3-pole AC / DC operated contactors			AF09	AF12	AF16	AF26	AF30	AF38	AF40	AF52	AF65	AF80	AF96	AF116	AF140	AF146
Lamp characteristics			Maximum permissible number of lamps per phase													
W	A	μF														

### Metal halide vapour lamps without compensation

#### Voltage: 220/240 V AC

250	3	-	4	5	5	7	7	7	11	14	16	18	20	27	33	38
400	4	-	3	3	4	5	5	5	8	11	12	13	15	20	25	28
1000	9.5	-	1	1	1	2	2	2	3	4	5	5	6	8	11	12
2000	16.5	-	0	0	1	1	1	1	2	2	3	3	3	5	6	7

#### Voltage: 380/415 V AC

2000	10.5	-	1	1	1	2	2	2	3	4	4	5	5	8	10	11
------	------	---	---	---	---	---	---	---	---	---	---	---	---	---	----	----

### Metal halide vapour lamps with compensation

#### Voltage: 220/240 V AC

250	1.32	33	7	7	7	15	16	17	25	33	37	41	45	69	86	97
400	2.22	45	5	5	5	9	9	10	14	19	22	24	27	41	51	58
1000	5.14	85	2	2	3	4	4	4	6	8	9	10	11	18	22	25
2000	11.5	148	1	1	1	1	1	2	2	3	4	4	5	8	10	11

#### Voltage: 380/415 V AC

2000	6.10	60	2	2	2	3	3	3	5	7	8	9	9	15	19	21
------	------	----	---	---	---	---	---	---	---	---	---	---	---	----	----	----

## Lighting circuit switching

Contactor selection AF190 ... AF2650 3-pole contactors

### Selection table

3-pole AC / DC operated contactors			AF190	AF205	AF265	AF305	AF370	AF400	AF460	AF580	AF750	AF1250	AF1350	AF1650	AF2050	AF2650
Lamp characteristics			Maximum permissible number of lamps per phase													
W	A	μF														

### Metal halide vapour lamps without compensation

#### Voltage: 220/240 V AC

250	3	-	46	58	67	83	100	100	117	133	175	208	225	275	342	442
400	4	-	34	44	50	63	75	75	88	100	131	156	169	206	256	331
1000	9.5	-	14	18	21	26	32	32	37	42	55	66	71	87	108	139
2000	16.5	-	8	11	12	15	18	18	21	24	32	38	41	50	62	80

#### Voltage: 380/415 V AC

2000	10.5	-	13	17	19	24	29	29	33	38	50	60	64	79	98	126
------	------	---	----	----	----	----	----	----	----	----	----	----	----	----	----	-----

### Metal halide vapour lamps with compensation

#### Voltage: 220/240 V AC

250	1.32	33	119	151	173	216	259	259	302	345	453	540	583	713	885	1144
400	2.22	45	71	90	103	128	154	154	180	205	270	321	347	424	526	680
1000	5.14	85	30	39	44	55	67	67	78	89	116	139	150	183	227	294
2000	11.5	148	14	17	20	25	30	30	35	40	52	62	67	82	102	131

#### Voltage: 380/415 V AC

2000	6.10	60	26	33	37	47	56	56	65	75	98	117	126	154	192	248
------	------	----	----	----	----	----	----	----	----	----	----	-----	-----	-----	-----	-----



## Lighting circuit switching

Contactor selection AF09 ... AF370 4-pole contactors

### Selection table

4-pole AC / DC operated contactors			AF09	AF16	AF26	AF38	AF40	AF52	AF80	AF116	AF140	AF190	AF205	AF265	AF305	AF370
Lamp characteristics			Maximum permissible number of lamps per phase													
W	A	μF														

### Incandescent and halogen lamps

according to AC-5b

#### Voltage: 220/240 V AC

60	0.27	-	64	77	103	114	177	207	259	430	519	704	759	981	1130	1370
100	0.45	-	38	46	62	68	106	124	155	258	311	422	456	589	678	822
200	0.91	-	19	23	30	34	52	61	77	127	154	209	225	291	335	407
300	1.37	-	12	15	20	22	35	41	51	85	102	139	150	193	223	270
500	2.28	-	7	9	12	13	21	24	30	51	61	83	90	116	134	162
1000	4.55	-	3	4	6	6	10	12	15	25	31	42	45	58	67	81

### Fluorescent lamps without compensation - Fluorescent lamps with electronic starter

according to AC-5a

#### Voltage: 220/240 V AC

20	0.38	-	46	55	73	81	126	147	184	305	368	500	539	697	803	974
40	0.45	-	38	46	62	68	106	124	155	258	311	422	456	589	678	822
65	0.70	-	25	30	40	44	68	80	100	166	200	271	293	379	436	529
80	0.80	-	21	26	35	38	60	70	87	145	175	238	256	331	381	463
100	1.15	-	15	18	24	26	41	48	60	101	122	165	178	230	265	322
110	1.20	-	14	17	23	25	40	46	58	97	117	158	171	221	254	308

### Fluorescent lamps with parallel compensation

according to AC-5a

#### Voltage: 220/240 V AC

20	0.18	5	53	53	110	110	266	309	309	644	778	1056	1139	1472	1694	2056
40	0.26	5	53	53	107	110	184	215	269	446	538	731	788	1019	1173	1423
65	0.42	7	37	37	66	73	114	133	166	276	333	452	488	631	726	881
80	0.52	7	33	37	53	59	92	107	134	223	269	365	394	510	587	712
100	0.65	16	16	16	34	34	73	86	96	178	215	292	315	408	469	569
110	0.70	18	14	14	30	30	68	80	86	166	200	271	293	379	436	529

### Fluorescent lamps in dual mounting

according to AC-5a

#### Voltage: 220/240 V AC

2 x 20	2 x 0.14	-	62	75	100	110	171	200	250	414	500	679	732	946	1089	1321
2 x 40	2 x 0.25	-	35	42	56	62	96	112	140	232	280	380	410	530	610	740
2 x 65	2 x 0.40	-	21	26	35	38	60	70	87	145	175	238	256	331	381	463
2 x 80	2 x 0.48	-	18	21	29	32	50	58	72	121	146	198	214	276	318	385
2 x 100	2 x 0.60	-	14	17	23	25	40	46	58	97	117	158	171	221	254	308
2 x 110	2 x 0.65	-	13	16	21	23	36	43	53	89	108	146	158	204	235	285

### Compact fluorescent lamps

according to AC-5a

#### Voltage: 220/240 V AC

5	0.045	-	388	466	622	688	1066	1244	1555	2578	3111	4222	4556	5889	6778	8222
7	0.075	-	233	280	373	413	640	746	933	1547	1867	2533	2733	3533	4067	4933
11	0.105	-	166	200	266	295	457	533	666	1105	1333	1810	1952	2524	2905	3524
15	0.135	-	129	155	207	229	355	414	518	859	1037	1407	1519	1963	2259	2741
20	0.160	-	109	131	175	193	300	350	437	725	875	1188	1281	1656	1906	2313
23	0.180	-	97	116	155	172	266	311	388	644	778	1056	1139	1472	1694	2056

### Low pressure sodium vapour lamps without compensation

#### Voltage: 220/240 V AC

35	1.4	-	9	12	15	16	23	31	39	70	85	115	124	161	185	225
55	1.4	-	9	12	15	16	23	31	39	70	85	115	124	161	185	225
90	2.1	-	6	8	10	10	15	20	26	47	57	77	83	107	123	150
135	3.1	-	4	5	6	7	10	14	17	32	38	52	56	73	84	101
180	3.1	-	4	5	6	7	10	14	17	32	38	52	56	73	84	101

### Low pressure sodium vapour lamps with parallel compensation

#### Voltage: 220/240 V AC

35	0.6	20	12	12	27	27	55	73	77	164	198	269	290	375	432	524
55	0.6	20	12	12	27	27	55	73	77	164	198	269	290	375	432	524
90	0.9	25	10	10	22	22	36	48	61	110	132	179	194	250	288	349
135	0.9	45	5	5	12	12	34	34	34	110	132	179	194	250	288	349
180	0.9	45	5	5	12	12	34	34	34	110	132	179	194	250	288	349

# Lighting circuit switching

## Contactors selection AF09 ... AF370 4-pole contactors

### Selection table

4-pole AC / DC operated contactors			AF09	AF16	AF26	AF38	AF40	AF52	AF80	AF116	AF140	AF190	AF205	AF265	AF305	AF370
Lamp characteristics			Maximum permissible number of lamps per phase													
W	A	µF														

### High pressure sodium vapour lamps without compensation

#### Voltage: 220/240 V AC

150	1.8	-	7	9	11	12	18	24	30	45	54	74	80	103	119	144
250	3.0	-	4	5	7	7	11	14	18	27	33	44	48	62	71	86
400	4.4	-	3	3	4	5	7	10	12	18	22	30	33	42	49	59
600	6.2	-	2	2	3	3	5	7	8	13	16	21	23	30	34	42
1000	10.3	-	1	1	2	2	3	4	5	8	10	13	14	18	21	25

### High pressure sodium vapour lamps with parallel compensation

#### Voltage: 220/240 V AC

150	1.0	20	12	12	21	23	33	43	55	93	112	152	164	212	244	296
250	1.5	36	7	7	14	15	22	29	36	62	75	101	109	141	163	197
400	2.5	48	5	5	8	9	13	17	22	37	45	61	66	85	98	118
600	3.3	65	3	3	6	6	10	13	16	28	34	46	50	64	74	90
1000	6.2	100	2	2	3	3	5	7	8	15	18	25	26	34	39	48

### High pressure mercury vapour lamps without compensation

#### Voltage: 220/240 V AC

50	0.60	-	22	28	35	38	55	73	91	152	190	261	333	380	475	570
80	0.80	-	16	21	26	28	41	55	68	114	143	196	249	285	356	428
125	1.15	-	11	14	18	20	28	38	47	79	99	136	173	198	248	297
250	2.15	-	6	7	9	10	15	20	25	42	53	73	93	106	133	159
400	3.25	-	4	5	6	7	10	13	16	28	35	48	61	70	88	105
700	5.40	-	2	3	3	4	6	8	10	17	21	29	37	42	53	63
1000	7.50	-	1	2	2	3	4	5	7	12	15	21	27	30	38	46

#### Voltage: 380/415 V AC

2000	8	-	1	2	2	2	4	5	6	11	14	20	25	29	36	43
------	---	---	---	---	---	---	---	---	---	----	----	----	----	----	----	----

### High pressure mercury vapour lamps with compensation

#### Voltage: 220/240 V AC

50	0.28	7	36	36	75	79	117	157	196	326	407	560	713	814	1018	1221
80	0.43	8	31	31	48	53	76	102	127	212	265	365	464	530	663	795
125	0.66	10	20	25	31	34	50	66	83	138	173	238	302	345	432	518
250	1.28	18	10	13	16	17	25	34	42	71	89	122	156	178	223	267
400	2.05	25	6	8	10	11	16	21	26	44	56	76	97	111	139	167
700	3.55	40	3	4	5	6	9	12	15	26	32	44	56	64	80	96
1000	4.83	60	2	3	4	4	6	9	11	19	24	32	41	47	59	71

#### Voltage: 380/415 V AC

2000	5.45	35	2	3	3	4	6	8	10	17	21	29	37	42	52	63
------	------	----	---	---	---	---	---	---	----	----	----	----	----	----	----	----

### Metal halide vapour lamps without compensation

#### Voltage: 220/240 V AC

250	3	-	4	5	7	7	11	14	18	27	33	46	58	67	83	100
400	4	-	3	4	5	5	8	11	13	20	25	34	44	50	63	75
1000	9.5	-	1	1	2	2	3	4	5	8	11	14	18	21	26	32
2000	16.5	-	0	1	1	1	2	2	3	5	6	8	11	12	15	18

#### Voltage: 380/415 V AC

2000	10.5	-	1	1	2	2	3	4	5	8	10	13	17	19	24	29
------	------	---	---	---	---	---	---	---	---	---	----	----	----	----	----	----

### Metal halide vapour lamps with compensation

#### Voltage: 220/240 V AC

250	1.32	33	7	7	15	16	25	33	41	69	86	119	151	173	216	259
400	2.22	45	5	5	9	10	14	19	24	41	51	71	90	103	128	154
1000	5.14	85	2	3	4	4	6	8	10	18	22	30	39	44	55	67
2000	11.5	148	1	1	1	2	2	3	4	8	10	14	17	20	25	30

#### Voltage: 380/415 V AC

2000	6.10	60	2	2	3	3	5	7	9	15	19	26	33	37	47	56
------	------	----	---	---	---	---	---	---	---	----	----	----	----	----	----	----

## Parallel connection of main poles

### General

Purpose: Increasing the AC resistive load by wiring connection of main poles in parallel.

Remarks:

- Parallel connection of main poles to increase the DC resistive load is not acceptable
- Parallel connection of main poles does not increase the breaking capacity.

The table below shows the uprating factor for  $I_e$  / AC-1 max. in relation to the number of poles wired connected in parallel and for a maximum switching frequency.

Note: The poles can be connected in parallel via following connecting strips. See details and permissible current in "Accessory" part.

- LP, LH, LY and LF for parallel connection of 2 or 3 poles
- LG for parallel connection of 4 poles.

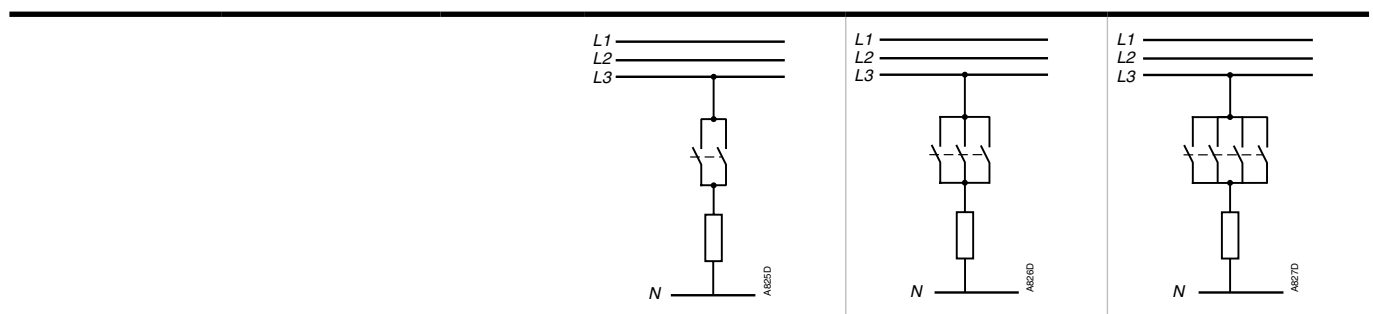

	2 poles in parallel	3 poles in parallel	4 poles in parallel
<b>Factor to be applied to the rated operational current <math>I_e</math> / AC-1 to obtain the permissible current <math>I_e</math> / AC-1 with "n" poles in parallel</b>			

<b>3-pole contactors</b>					
AC operated	DC operated	Cycles / h	Factor to be applied to the rated operational current $I_e$ / AC-1 to obtain the permissible current $I_e$ / AC-1 with "n" poles in parallel		
AF09 ... AF96	AF09 ... AF96	600	1.6	2.2	-
AF116 ... AF1250	AF116 ... AF1250	300	1.6	2.2	-
AF1350 ... AF2650	AF1350 ... AF2650	30	1.6	2.2	-

<b>4-pole contactors</b>					
AC operated	DC operated	Cycles / h	Factor to be applied to the rated operational current $I_e$ / AC-1 to obtain the permissible current $I_e$ / AC-1 with "n" poles in parallel		
AF09 ... AF38	AF09 ... AF38	600	1.6	2.2	2.6
A45 ... A75	AE45 ... AE75	300	1.6	2.2	2.6
AF45 ... AF75	TAE45 ... TAE75				
EK	EK	300	1.6	2.2	2.8

## Temporary or intermittent duty

### Utilization of contactors for temporary / intermittent duty

The table below shows the factor (known as "On-load factor") to be applied to the rated operational current  $I_e$  / AC-1 to obtain the permissible operational current  $I_e$  / AC-1 in relation to the switching frequency and the current flow time per cycle.

Operating cycles per hour	1	2	3	6	12	20	30	60	120	
Preferred classes acc. to IEC 60947-4-1	1	-	3	-	12	-	30	-	120	
Current flow time per cycle	Factors applicable to $I_e$ / AC-1									
5 s	5.2	5	4.9	4.7	4.3	4.0	3.7	3.4	2.8	
10 s	3.8	3.7	3.6	3.4	3.1	3.0	2.8	2.6	2.2	
20 s	2.8	2.7	2.7	2.6	2.5	2.4	2.2	2.0	1.5	
30 s	2.4	2.3	2.3	2.2	2.1	2.1	1.9	1.7	-	
40 s	2.2	2.1	2.1	2.0	1.9	1.9	1.7	1.5	-	
60 s	1.9	1.8	1.8	1.8	1.7	1.7	1.5	-	-	

**Example:**

**AF09 contactor (intermittent duty, resistive load)**

Rated operational current  $I_e$  / AC-1 at 60 °C

(see "Technical data: main pole utilization characteristics") 25 A

Switching frequency 2 operating cycles/h

Current flow time per cycle 20 s

Factor to be applied to the current  $I_e$  / AC-1 2.7

Permissible current:  $2.7 \times 25 = 67$  A

# Influence of the length of conductors used in contactor control circuit



AF40-30-00

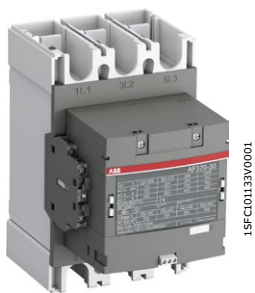

AF370-30-11

Under certain conditions the excessive length of the control circuit conductors may prevent the contactor from carrying out closing and opening orders.

- **no closing:** due to excessive voltage drop (in AC or DC)
- **no opening:** due to excessive capacitance (in AC).

### Contactor Closing (contactor with AC or DC operated coil).

The voltage drop is due to the pull-in current (pull-in power) and to the resistance of the control circuit conductors.

The table and graph below can be used to determine the single length of line feeders (distance between the control device and the contactor coil) in relation to:

- the coil pull-in consumption.
- the supply voltage.
- the connecting wire cross-sectional area.

The graph has been drawn for a max. line voltage drop of 5 %.

Coil pull-in consumption (average value)

3-pole contactors	AC control supply 50/60 Hz	DC control supply	4-pole contactors	AC control supply 50/60 Hz	DC control supply
AF09, AF12, AF16, AF26, AF30, AF38	50 VA	50 W	AF09, AF16, AF26, AF38	50 VA	50 W
AF09Z, AF12Z, AF16Z, AF26Z, AF30Z, AF38Z	20 VA	20 W	AF09Z, AF16Z, AF26Z, AF38Z	20 W	20 W
AF40, AF52, AF65	25 VA	25 W	AF40, AF52, AF80	40 VA	40 W
AF80, AF96	40 VA	40 W	AF116, AF140	185 VA	170 W
AF116, AF140, AF146	180 VA	170 W	AF190, AF205	190 VA	180 W
AF190, AF205	195 VA	185 W	AF265, AF305, AF370	405 VA	445 W
AF265, AF305, AF370	405 VA	465 W			
AF400, AF460	1005 VA	960 W			
AF580, AF750, AF1250	940 VA	900 W			
AF1350, AF1650, AF2050, AF2650	2450 VA	2290 W			

### Permissible single length for the control circuit conductors on contactor closing:

Depending on the coil pull-in power consumption on the supply voltage and on the control circuit conductor cross-sectional area.

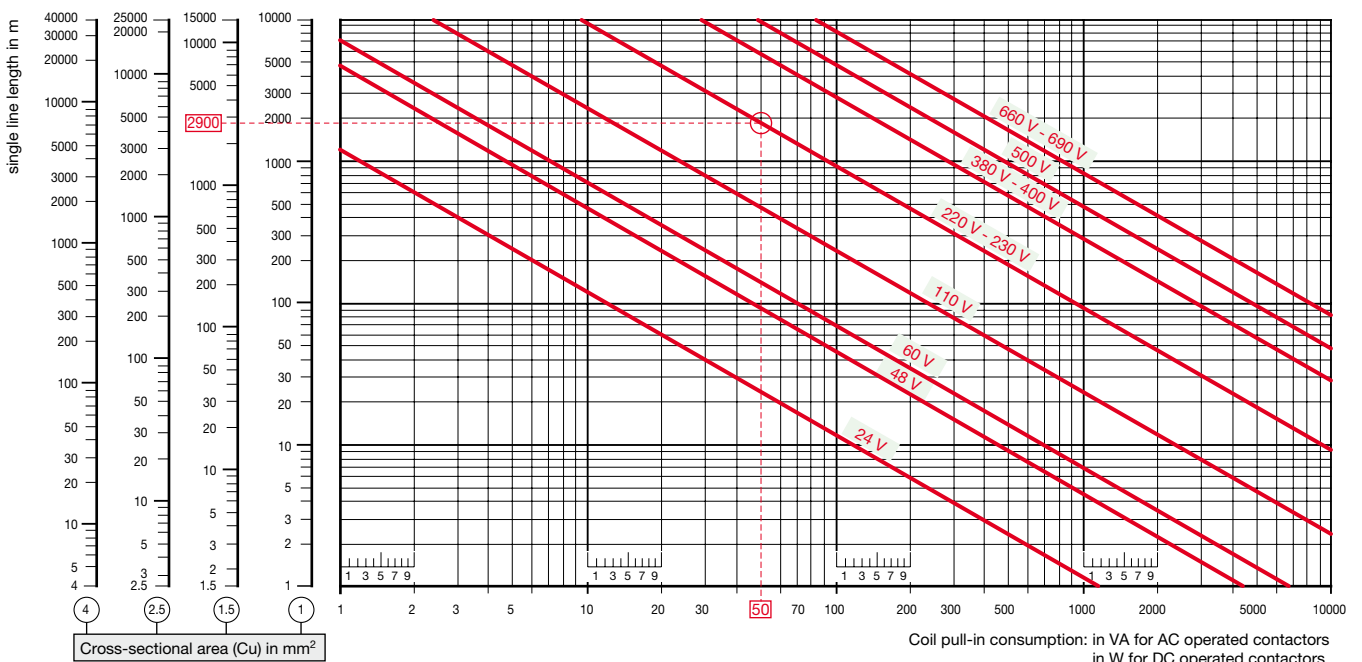

Example AF09 contactor: Coil voltage: 230 V 50 Hz, contactor coil pull-in power consumption: 50 VA, control circuit conductor cross-sectional area: Cu 1.5 mm². Max. permissible length: 2900 m.

# Influence of the length of conductors used in contactor control circuit

## Single control line length

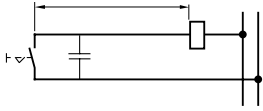

**Wiring diagram A**  
Via maintained pushbutton and 2-core cable (with a capacity of 0.2 μF/km, for example).

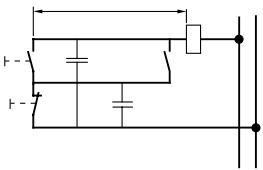

**Wiring diagram B**  
Via momentary pushbutton plus hold-in contact and 3-core cable (with a capacity of 2 x 0.2 = 0.4 μF/km, for example).

## Contactor Opening (contactor with AC operated coil)

Under certain conditions, an AC operated contactor does not open when the control circuit is de-energized.

This is due to a critical capacity of the excessively long control circuit line and the type of contactor coil control layout (see diagrams A and B opposite). This may be caused by the following factors:

- high control voltage
- low coil holding consumption
- low contactor drop-out voltage (according to IEC 60947-4-1: 0.2 to 0.75 x U<sub>c</sub>).

If lines longer than those indicated are required, the following measures must be taken:

- select a contactor with a higher rating
- select a lower control voltage
- connect "Rp" resistance in parallel with the contactor coil:

$$R_P = \frac{103}{C} \quad (\text{with } C \text{ in } \mu\text{F})$$

The table and graph below can be used to determine the single length of line feeders (distance between the control device and the contactor coil) in relation to:

- the coil holding consumption VA
- the supply voltage
- the capacity in μF/km (depending on the control layout).

Wiring diagrams A and B opposite show two supply and coil control wiring examples.

Coil holding consumption (average value)

3-pole contactors	AC control supply	4-pole contactors	AC control supply
	50/60 Hz		50/60 Hz
AF09, AF12, AF16, AF26, AF30, AF38	2.2 VA	AF09, AF16, AF26, AF38	2.2 VA
AF09Z, AF12Z, AF16Z, AF26Z, AF30Z, AF38Z	1.7 VA	AF09Z, AF16Z, AF26Z, AF38Z	1.7 VA
AF40, AF52, AF65, AF80, AF96	4 VA	AF40, AF52, AF80	4 VA
AF116, AF140, AF146	8.9 VA	AF116, AF140, AF190, AF205	8 VA
AF190, AF205	9.3 VA	AF265, AF305, AF370	16 VA
AF265, AF305, AF370	16.6 VA		
AF400, AF460, AF580, AF750, AF1250	12 VA		
AF1350, AF1650, AF2050, AF2650	48 VA		

## Permissible single length for the control circuit conductors on contactor opening:

Depending on the coil holding power consumption, on the supply voltage and on the control circuit conductor capacity.

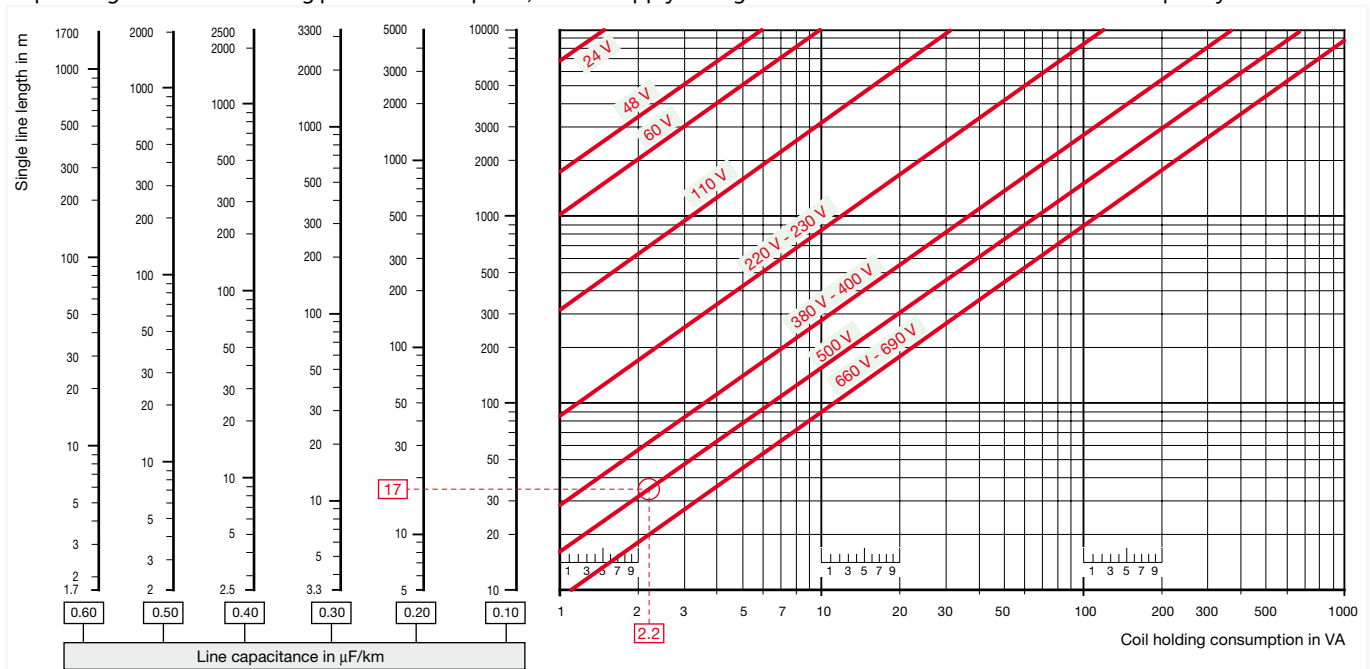

Example AF16 contactor: Coil voltage U<sub>c</sub> = 500 V, 50 Hz, 2.2 VA contactor coil holding consumption, control type: diagram A, via maintained pushbutton, and 2-core cable with a capacity of 0.2 μF/km. Max. permissible length: 17 m.

## Voltage code table

The below tables indicate the available coil voltages and corresponding digits for order codes. When placing an order, please give the order code. Select a standard contactor from ordering detail pages. Change the coil voltage code in the order code according to the table below. Example: for contactor AF400-30-11 and coil 100...250 V 50/60 Hz, the order code is: 1SFL577001R7011.

AF09 ... AF370 3-pole contactors

AF09 ... AF370 4-pole contactors



### AF116 ... AF370 3-pole contactors with built-in PLC interface

	AC coil code 50/60 Hz	DC coil code
33	100...250 V	100...250 V
34	250...500 V	250...500 V

AF400 ... AF2650 3-pole contactors

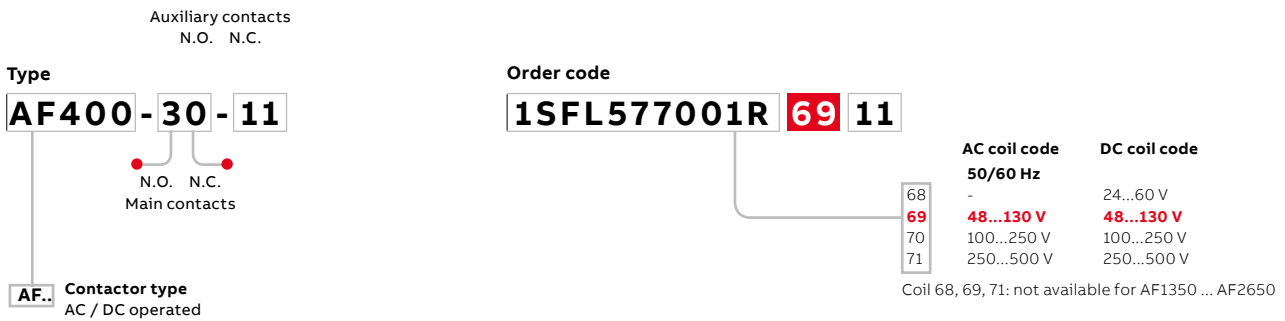

AF09 ... AF38 3- and 4-pole contactors - low consumption

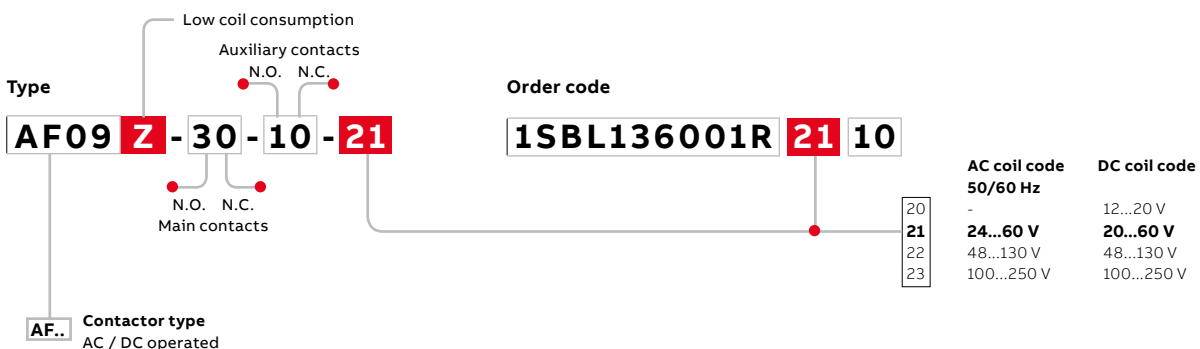

## Voltage code table

### NF contactor relays



### NF contactor relays with overlapping of lagging / leading contacts

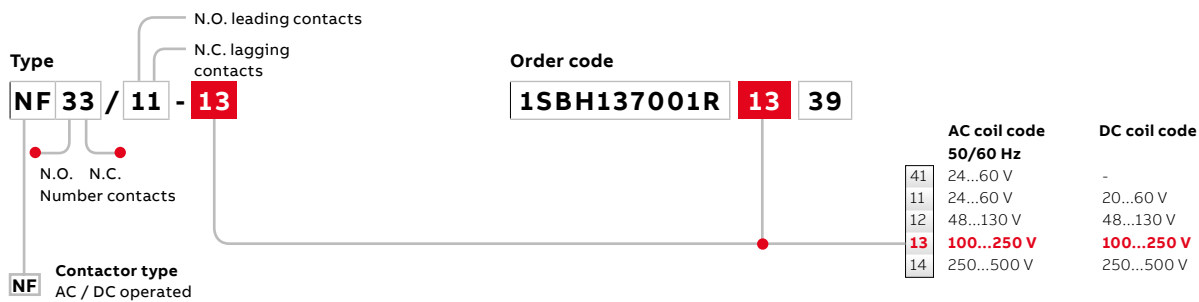

### NF contactor relays - low consumption

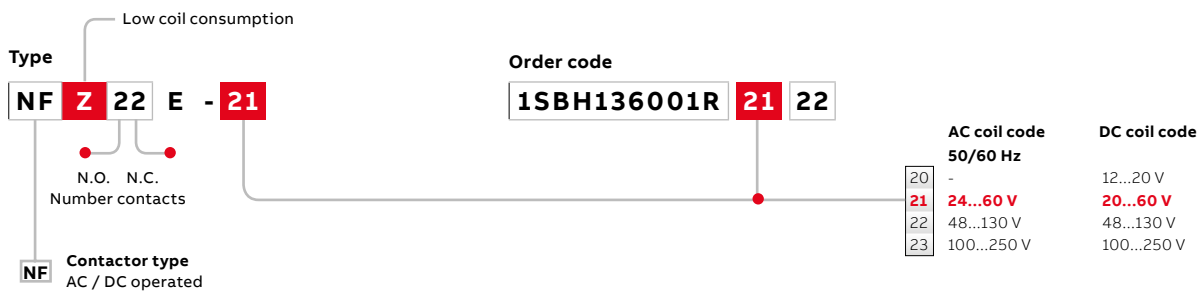

### NF contactor relays with overlapping of lagging / leading contacts - low consumption





# Voltage code table

## GA contactors

**Type**  
**GA75 - 10 - 00**

**Contactor type**  
GA DC switching - AC operated  
GAE DC switching - DC operated

**Order code**  
**1SBL411025R 82 00**

Contactors: GA		Contactors: GAE	
AC coil code		DC coil code	
81	50 Hz 24 V	60 Hz 24 V	80 12 V
<b>82</b>	<b>42 V</b>	<b>42 V</b>	81 24 V
83	48 V	48 V	82 42 V
84	110 V	110...120 V	83 48 V
89	110...115 V	115...127 V	86 110 V
80	220...230 V	230...240 V	87 125 V
88	230...240 V	240...260 V	88 220 V
42	230...240 V	277 V	89 240 V
85	380...400 V	400...415 V	38 250 V
86	400...415 V	415...440 V	

Codes in bold for dual frequency coils.

## GAF185 ... GAF300 contactors

**Type**  
**GAF185 - 10 - 11**

**Contactor type**  
GAF AC / DC operated

**Order code**  
**1SFL497025R 69 11**

AC coil code		DC coil code
72	50/60 Hz - 20...60 V	
<b>69</b>	<b>48...130 V</b>	<b>48...130 V</b>
70	100...250 V	100...250 V

## GAF460 ... GAF1250 contactors

**Type**  
**GAF460 - 10 - 11**

**Contactor type**  
GAF AC / DC operated

**Order code**  
**1SFL597025R 69 11**

AC coil code		DC coil code
68	50/60 Hz - 24...60 V	
<b>69</b>	<b>48...130 V</b>	<b>48...130 V</b>
70	100...250 V	100...250 V
71	250...500 V	250...500 V

## Voltage code table

### GAF1650, GAF2050 contactors

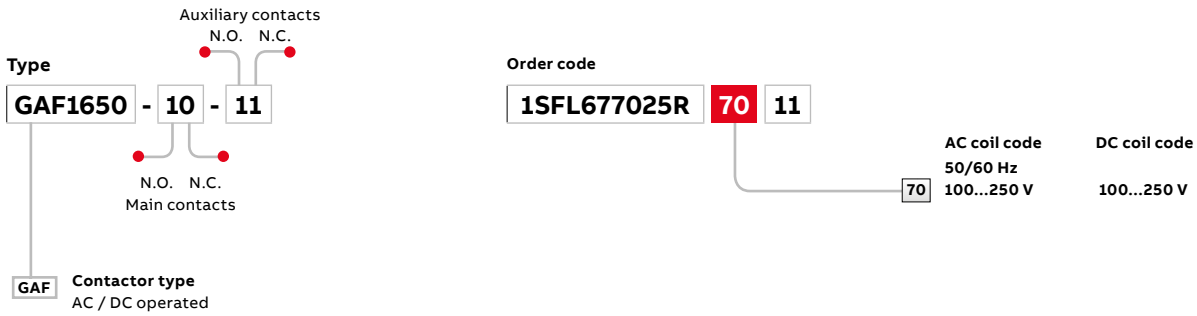

### UA..RA contactors

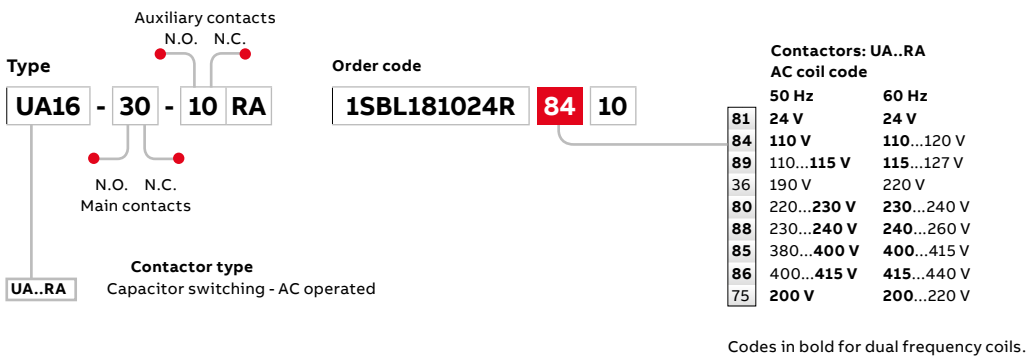

### UA contactors

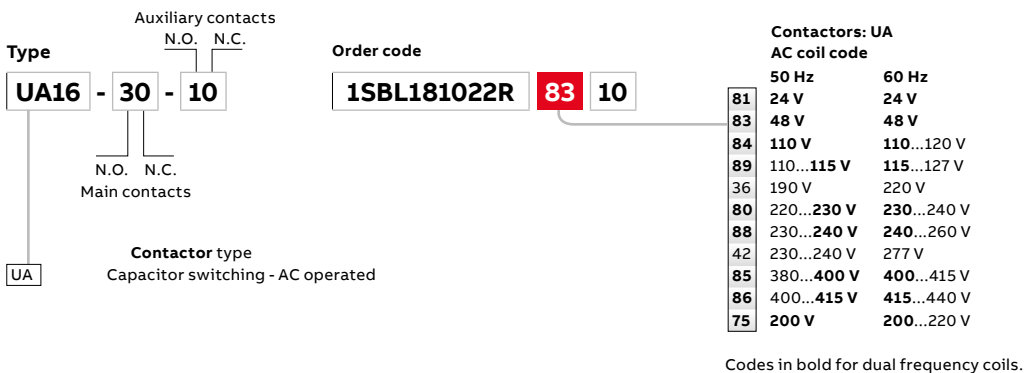

# Voltage code table

## EK550, EK1000 contactors

**Type**

**EK550 - 40 - 11**

**EK**

**Contactor type**  
AC operated or DC operated

**Main contacts**  
N.O. N.C.

**Auxiliary contacts**  
N.O. N.C.

**Order code**

**SK827041 - AD**

**AC coil code**

	50 Hz	60 Hz
AD	48 V	-
AE	-	110 V
AF	110 V	120 V
AG	127 V	-
AZ	-	208 V
AH	190 V	220 V
AK	-	240 V
AL	220...230 V	240 V
AM	230...240 V	-
AN	-	380 V
AP	380...400 V	440 V
AR	400...415 V	-
AS	-	480 V
AT	440 V	-
AU	500 V	-
AV	-	600 V

**Dual frequency coil code**

	50 Hz	60 Hz
EF	110 V	110...120 V
EG	110...115 V	115...127 V
EL	220 V	220...240 V
EM	220...230 V	230...255 V
EP	380 V	380...415 V
ER	380...400 V	400...440 V

2 auxiliary contact blocks maximum per contactor, ambient temperature ≤ 55 °C and mounting positions 2 and 6 excluded.

**DC coil code**

DB	24 V
DC	36 V
DD	48 V
DT	60 V
DG	75 V
DE	110 V
DU	125 V
DF	220 V

# Questionnaire for product specifications: Block contactors

Tel.: e-mail:  
Segments:

Tel.: e-mail:  
Date:

## Application

Type: No of phases:  
Utilisation category (AC/DC): % AC4 if any:  
Rated operational voltage Ue: V Cos j:  
  
Frequency: Hz L/R: ms  
Nominal current In: A  
Making current: A Breaking current: A  
Duty:  continuous  temporary  intermittent  
Load factor (% of ON time): %  
Number of cycles per hour: or per year:  
Expected durability: operating cycles  
Number of main poles N.O.: N.C.:  
Other information:

## Control circuit

Rated control Uc voltage: V  DC  AC f: Hz  
Minimum / maximum: V to V  
Surge suppressor: type:  
Interface with PLC: mA V DC  
Accessories:  
Number of auxiliary contacts: N.O.: N.C.:  
Low level contacts: mA V  DC  AC

## Installation

Ambient temperature:  
Ambient environment:  
Humidity: %  
Chemical pollution:  
Other:  
Mounting position, see drawing below (Position 4:  
please consult factory):

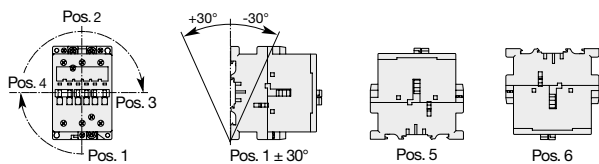

Wiring:  Clamping screws or cage connectors  
 Cable lugs (ring tongue)  
Other: Cross section:  
Additional comments:

## Protection

Short circuit protection:  
Type:  Fuse  Circuit breaker  Manual motor starter  
Max short circuit current: A  
Motor protection:  Overload relay  Manual Motor Starter  Electronic overload relay

## Logistic and packaging

Quantity by batch:  
Delivery order:  
Expected quantity: per year  
Expected first delivery date: and Qty:  
Quantity on first 6 month: on first year:

## Approvals and other requirements

Reference standards:  
Required approvals:  
Customer specifications:  
Shock and vibrations:  
Specific quality assurance clauses:  
Other comments:

# Questionnaire for product specifications: Block contactors

Other comments:

.....

.....

.....

.....

.....

.....

.....

.....

.....

## User Guide for the questionnaire

**This document is used to define the contactor specifications according to the complete information on the application. Do not hesitate to join some complementary documents if necessary (schemes, tables, customer specification...).**

Please see below some definitions to help you :

### Operating cycle

Includes one making operation and one breaking operation.

### Electrical Durability

Number of on-load operating cycles that the contactor is able to carry out. It depends on the utilization category.

### Mechanical Durability

Number of no-current operating cycles that the contactor is able to carry out

### Load Factor

Ratio of the on-load operating time to the total cycle time x 100 (%).

### Intermittent Duty

Duty during which the contactor is successively closed or open for periods which are too short to enable the contactor to achieve thermal balance.

### Temporary Duty

Duty in which the main contacts of the contactor remain closed for periods insufficient to allow the equipment to reach stabilized temperature, the unload periods being separated by off-load periods of sufficient duration to restore the ambient temperature

### Continuous Duty

Duty in which the main contacts of the contactor remain closed, with a continuous current during enough time to reach thermal stabilization, but no more than eight hours without interruption.

### Ambient Temperature

Air temperature close to the contactor.

### Mounting Position

Comply with the manufacturer's instructions. Restrictions could be taken into account for certain mounting positions.

A contactor's duty is characterized by the utilization category together with the rated operational voltage and current indicated:

### Utilization categories for contactors according to IEC 60947-4-1

### Utilization categories for contactor relays according to IEC 60947-5-1

See our catalog p7/8

### Making and breaking current

Current at contactor closing or at contactor opening

### Time constant L/R (for DC circuit)

Ratio of the inductance to the resistance ( $L/R = \text{mH}/\Omega = \text{ms}$ )

—  
**Notes**

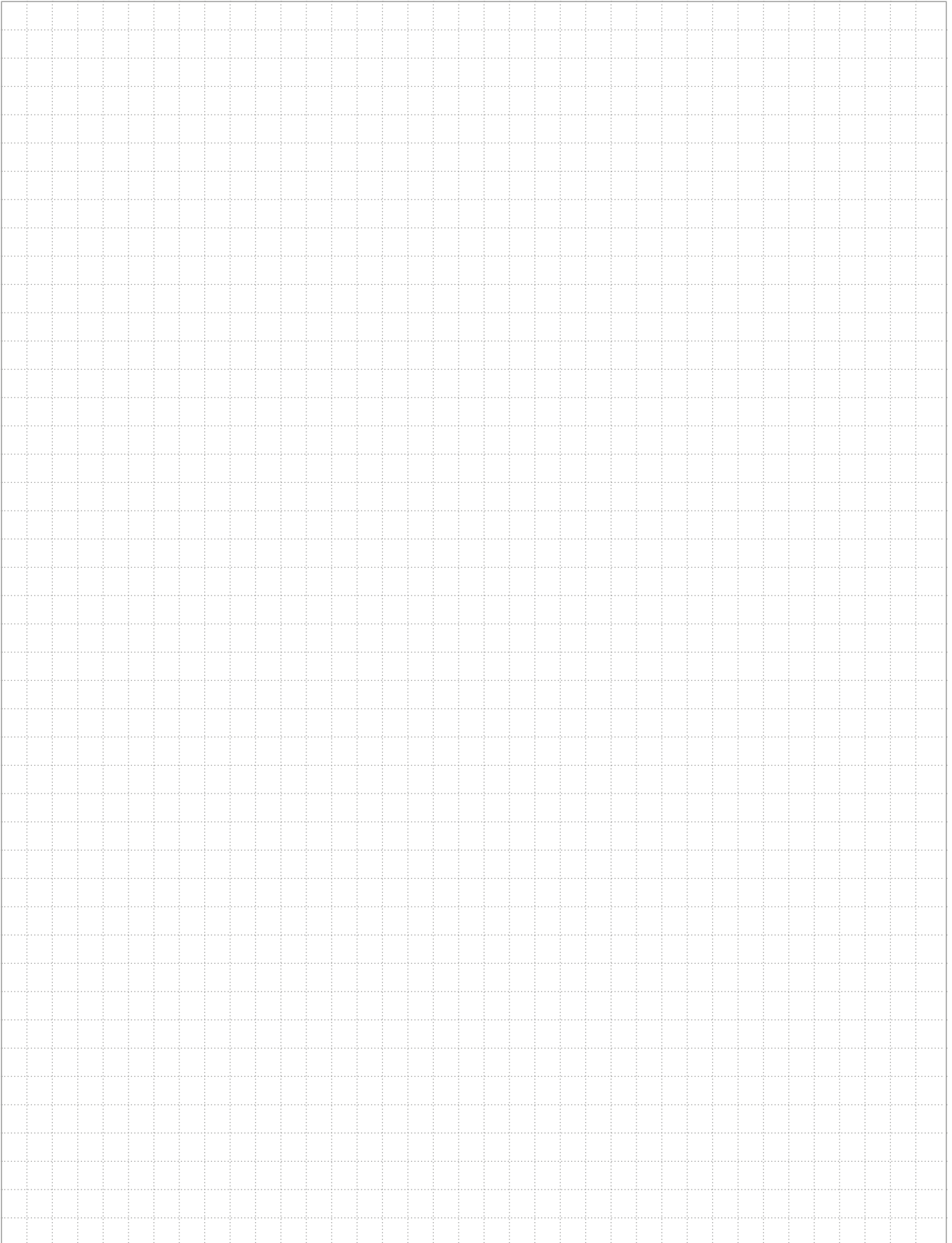



**For direct product details information, use product type or order code, ex:**

[www.abb.com/productdetails/BC6-30-10-07](http://www.abb.com/productdetails/BC6-30-10-07)

or

[www.abb.com/productdetails/GJL1213001R0107](http://www.abb.com/productdetails/GJL1213001R0107)

---

# B mini contactors

## K mini contactor relays

**4/3 Presentation**

**4/6 Overview**

### **With screw terminals**

**4/8** 3-pole contactors AC and DC operated

**4/10** 3-pole reversing contactors AC and DC operated

**4/14** 3-pole interface contactors DC operated

**4/15** 4-pole contactors AC and DC operated

**4/17** Contactor relays AC and DC operated

**4/19** Interface contactor relays DC operated

### **With soldering pins**

**4/20** 3-pole contactors AC and DC operated

**4/22** 3-pole reversing contactors AC and DC operated

**4/26** 3-pole interface contactors DC operated

**4/27** Contactor relays AC and DC operated

**4/29** Interface contactor relays DC operated

### **With flat pin connection**

**4/30** 3-pole contactors AC and DC operated

**4/32** 3-pole reversing contactors AC and DC operated

**4/36** 3-pole interface contactors DC operated

**4/37** Contactor relays AC and DC operated

**4/39** Interface contactor relays DC operated

**4/40 Technical data**

**4/47 Accessories**

**4/52 Location of the connection terminals  
and terminal designation**

**4/53 Dimension drawings**





## B mini contactors

### Flexibility in small spaces



Mini contactors are ideally suited for applications where reliability is a must and space is at a premium. The dimensions, technical features and the variety of the assortment provide customers a high flexibility in a wide-range of applications.

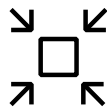

#### Space-saving

##### Designed to be mini

This type of contactor is a specialist for applications in small spaces. It comes with three different terminal types. Side or front auxiliary contact blocks can be mounted to match the requirements of width or depth limitations.



#### Optimum interface

##### Great flexibility

B mini offer many possibilities to adapt to any project. It offers screw terminals, soldering pins or flat pin connectors and different coil versions. This makes this contactor a perfect fit and simplifies the installation greatly.



#### Speed up your projects

##### Simpler by design

You can easily combine a manual motor starter or overload relay with a mini contactor in order to create the solution of your choice. Reversing starters come pre-assembled from the factory, which saves time. With the right accessories, this range is simple to use.

# B mini contactor

## Smart - flexibility and diversity in a small size

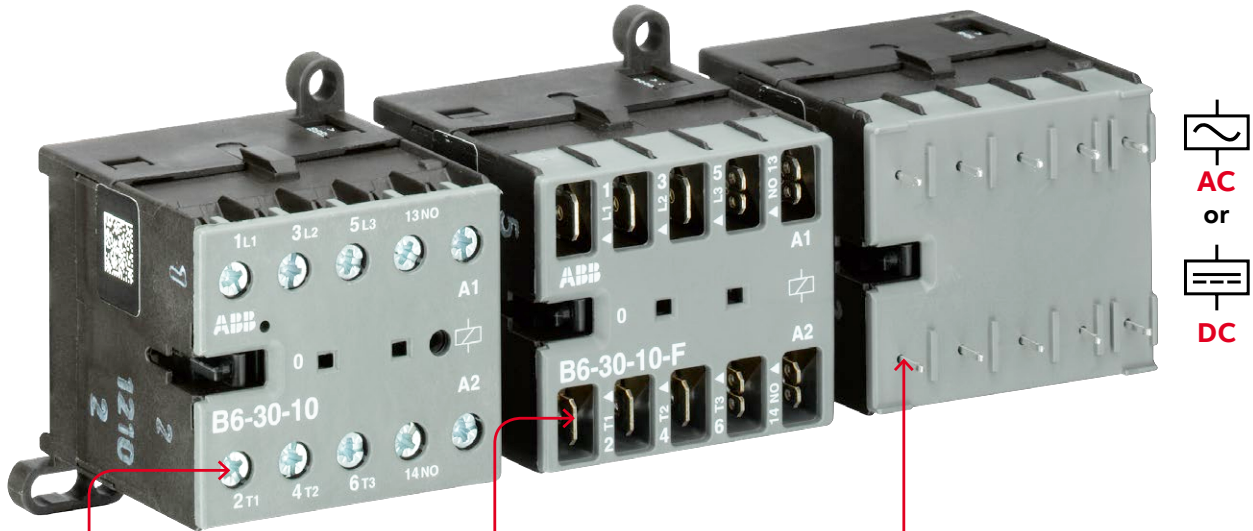

### Screw

#### Screw terminals

This conventional terminal type enables a quick connection to an installation using just a one size screwdriver. All terminal screws, from power to control, are aligned and accessible from the front for easy tightening.



### Flat pins

#### Flat pin terminals

Thanks to really quick plug-in assembling, good reliability of the connection and low costs, the flat pin terminals are already the favorite choice in many industry sectors. The best option when high connection speed is required.



### Soldering pins

#### Soldering pin terminals

This connection type allows an easy installation on PCB boards, where all components have to be soldered in place. The soldering pins sustain currents up to AC-1/AC-3 12 A.



### Mountable in just about any place

According to the available space, auxiliary contacts can be mounted on the front or at the side of the B mini. Also, additional surge protection can be fitted on any side of the contactor.



### Save assembly time

This range offers reversing starters delivered as one piece from the factory. It avoids mounting mistakes and secures operation. It is also available with mechanical interlock for special demands.

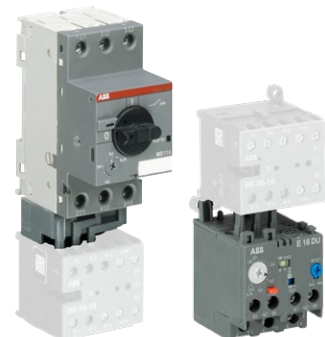

### Perfect fit

Mini contactors match manual motor starters or overload relays. This creates a space-saving and easy to install motor starting solution for a complete protection and control of your devices.

## B mini contactor

### Compact - a tiny specialist for specific needs

#### Choose your specialist.

No matter what kind of application - The B range includes contactors with low power consumption coils and integrated surge suppression for direct control by PLC. Dedicated relay versions for control functions or for small loads are also available.

#### Motors control

With a maximum rated operational power AC-3 of 5.5 kW at 400 V the B Mini Contactors are the best solution for controlling the small motors inside your products. If the both direction control is needed, the reversing contactors are always ready to help.



#### Resistive loads

Not only motors! The ABB Mini Contactors can be used for the activation of your AC-1 / DC-1 loads up to 20 A as well. Heaters, coffee machines and ovens are just examples of products in which it is possible to utilize this reliable and silent device as a component.



#### Extreme conditions

Manufactured with resistant and high performances materials, the B Mini Contactors can be precious allies even for applications in extreme conditions. Specific versions with wide operating temperature ranges and coil voltage ranges are part of our offer.



Courtesy of Steven Engineering, Inc - (800) 258-9200 - sales@steveneng.com - www.stevenengineering.com

# Mini contactors



				Screw terminals			
<b>AC Control supply</b>							
3-pole contactors		Coil consumption 3.5 W	Type	<b>B6</b>	<b>B7</b>	-	-
3-pole reversing contactors		Coil consumption 3.5 W	Type	-	-	<b>VB6</b> <b>VB6A (2)</b>	<b>VB7</b> <b>VB7A (2)</b>
4-pole contactors		Coil consumption 3.5 W	Type	<b>B6</b>	<b>B7</b>	<b>(3)</b>	<b>(3)</b>
<b>DC Control supply</b>							
3-pole contactors		Coil consumption 3.5 W	Type	<b>BC6</b>	<b>BC7</b> <b>B7D (1)</b>	-	-
3-pole reversing contactors		Coil consumption 3.5 W	Type	-	-	<b>VBC6</b> <b>VBC6A (2)</b>	<b>VBC7</b> <b>VBC7A (2)</b>
3-pole interface contactors		Coil consumption 1.4 ... 2.8 W	Type	<b>BC6</b> <b>B6S (1)</b>	<b>BC7</b> <b>B7S (1)</b>	<b>(3)</b>	<b>(3)</b>
4-pole contactors		Coil consumption 3.5 W	Type	<b>BC6</b>	<b>B7D</b>	<b>(3)</b>	<b>(3)</b>
IEC	Rated operational power AC-3	220-230-240 V	kW	2.2	3	2.2	3
		380-400 V	kW	4	5.5	4	5.5
	Rated operational current AC-1	400 V, $\theta \leq 40^\circ\text{C}$	A	20	20	20	20
UL/CSA	3-phase motor rating	220-240 V AC	hp	2	3	2	3
		440-480 V AC	hp	3	5	3	5
	General use rating		A	12 (300 V)	16 (600 V)	12 (300 V)	16 (600 V)
<b>Main accessories</b>							
Auxiliary contact blocks		Front mounting		CAF6			
		Side mounting		CA6	-		
Connection sets		For reversing contactors		BSM6-30			
Surge suppressors		Varistor (AC/DC)		RV-BC6			
<b>Overload relays</b>							
Thermal overload relays			Class 10	T16			
Thermal and phase failure protection, with single setup possible							
Electronic overload relays			Class 10E, 20E, 30E	E16DU			
With single setup possible							
<b>Manual motor starters</b>							
Thermal / magnetic protection			Class 10	MS116, MS132			
Magnetic only types				MO132			
Connecting link to manual motor starters				BEA7/132			

## Mini contactor relays



				Screw terminals			
<b>AC Control supply</b>							
4-pole contactor relays		Coil consumption 3.5 W	Type	<b>K6</b>			
<b>DC Control supply</b>							
4-pole contactor relays		Coil consumption 3.5 W	Type	<b>KC6</b>			
4-pole interface contactor relays		Coil consumption 1.4 ... 2.8 W	Type	<b>KC6, K6S (1)</b>			
IEC	Rated operational current AC-15	220-230-240 V	A	4			
		380-400 V	A	3			
	Rated operational current DC-13	24 V	A	2.5			
<b>Main accessories</b>							
Auxiliary contact blocks		Front mounting		CAF6			
		Side mounting		CA6-11K			

(1) With integrated surge suppressor

(2) With safety blocking function

(3) Please visit: <https://new.abb.com/low-voltage/products/motor-protection/3-pole-contactors-and-overload-relays-for-motor-starting/mini-contactors>





**Soldering pins**

**Flat pins**

B6...P	B7...P	-	-	B6...F	B7...F	-	-
-	-	VB6...P	VB7...P	-	-	VB6...F	VB7...F
(3)	(3)	VB6A...P (2)	VB7A...P (2)	(3)	(3)	VB6A...F (2)	VB7A...F (2)
(3)	(3)	(3)	(3)	(3)	(3)	(3)	(3)
2.2	3	2.2	3	2.2	3	2.2	3
4	5.5	4	5.5	4	5.5	4	5.5
12	12	12	12	20	20	20	20
2	3	2	3	2	3	2	3
3	5	3	5	3	5	3	5
12 (300 V)	16 (600 V)	12 (300 V)	16 (600 V)	12 (300 V)	16 (600 V)	12 (300 V)	16 (600 V)
-	-	-	-	-	-	-	-
CA6-11K-P	-	-	-	CA6-11K-F	-	-	-
-	-	-	-	-	-	-	-
-	-	-	-	-	-	-	-
-	-	-	-	-	-	-	-
MS116, MS132	-	-	-	MS116, MS132	-	-	-
MO132	-	-	-	MO132	-	-	-
-	-	-	-	-	-	-	-



**Soldering pins**

**Flat pins**

K6...P	K6...F
KC6...P	KC6...F
KC6...P	KC6...F
4	4
3	3
2.5	2.5
-	-
CA6-11K-P	CA6-11K-F

# B6, B7 3-pole mini contactors – with screw terminals

4 to 5.5 kW

AC operated



B6-30-10

2CDC211001F0010



B7-30-10

2CDC211014F0011

B6, B7 3-pole mini contactors are compact control products mainly used for switching resistive or motor loads up to 690 V AC.

These contactors are designed with:

- 3 main poles and one built-in auxiliary contact
- control circuit: AC operated, low coil consumption (3.5 VA at pull-in and at holding)
- hum-free coil
- add-on auxiliary contact blocks for front or side mounting and a wide range of accessories
- designed for rail or wall mounting

IEC		UL/CSA		Rated control circuit voltage UC		Auxiliary contacts fitted	Type	Order code	Pkg qty	Weight (1 pce)
Rated operational power	operational current $\theta \leq 40^\circ\text{C}$	3-phase motor rating	General use rating	50 Hz	60 Hz					
400 V	AC-3	AC-1	hp	V AC	V AC					kg

### B6 mini contactors

Rated operational power	operational current	3-phase motor rating	General use rating	Rated control circuit voltage UC 50 Hz	Rated control circuit voltage UC 60 Hz	Auxiliary contacts fitted	Type	Order code	Pkg qty	Weight (1 pce)
4	20	3	300 V / 12 A	24	24	1 0	B6-30-10-01	GJL1211001R0101	10	0.175
						0 1	B6-30-01-01	GJL1211001R0011	10	0.175
				42	42	1 0	B6-30-10-02	GJL1211001R0102	10	0.175
						0 1	B6-30-01-02	GJL1211001R0012	10	0.175
				48	48	1 0	B6-30-10-03	GJL1211001R0103	10	0.175
						0 1	B6-30-01-03	GJL1211001R0013	10	0.175
				110 ... 127	110 ... 127	1 0	B6-30-10-84	GJL1211001R8104	10	0.175
						0 1	B6-30-01-84	GJL1211001R8014	10	0.175
				220 ... 240	220 ... 240	1 0	B6-30-10-80	GJL1211001R8100	10	0.175
						0 1	B6-30-01-80	GJL1211001R8010	10	0.175
				380 ... 415	380 ... 415	1 0	B6-30-10-85	GJL1211001R8105	10	0.175
						0 1	B6-30-01-85	GJL1211001R8015	10	0.175

### B7 mini contactors

Rated operational power	operational current	3-phase motor rating	General use rating	Rated control circuit voltage UC 50 Hz	Rated control circuit voltage UC 60 Hz	Auxiliary contacts fitted	Type	Order code	Pkg qty	Weight (1 pce)
5.5	20	5	600 V / 16 A	24	24	1 0	B7-30-10-01	GJL1311001R0101	10	0.175
						0 1	B7-30-01-01	GJL1311001R0011	10	0.175
				42	42	1 0	B7-30-10-02	GJL1311001R0102	10	0.175
						0 1	B7-30-01-02	GJL1311001R0012	10	0.175
				48	48	1 0	B7-30-10-03	GJL1311001R0103	10	0.175
						0 1	B7-30-01-03	GJL1311001R0013	10	0.175
				110 ... 127	110 ... 127	1 0	B7-30-10-84	GJL1311001R8104	10	0.175
						0 1	B7-30-01-84	GJL1311001R8014	10	0.175
				220 ... 240	220 ... 240	1 0	B7-30-10-80	GJL1311001R8100	10	0.175
						0 1	B7-30-01-80	GJL1311001R8010	10	0.175
				380 ... 415	380 ... 415	1 0	B7-30-10-85	GJL1311001R8105	10	0.175
						0 1	B7-30-01-85	GJL1311001R8015	10	0.175

Other types on request

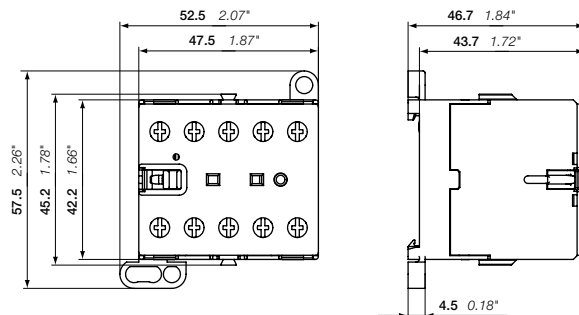

B6, B7

Main dimensions mm, inches

2CDC102098C0201

# BC6, BC7, B7D 3-pole mini contactors – with screw terminals

4 to 5.5 kW

DC operated



BC6-30-10



BC7-30-10

BC6, BC7, B7D 3-pole mini contactors are compact control products mainly used for switching resistive or motor loads up to 690 V AC.

These contactors are designed with:

- 3 main poles and one built-in auxiliary contact
- control circuit: DC operated, low coil consumption (3.5 W at pull-in and at holding)
- hum-free coil
- add-on auxiliary contact blocks for front or side mounting and a wide range of accessories
- designed for rail or wall mounting

IEC	UL/CSA		Rated control circuit voltage UC	Auxiliary contacts fitted	Type	Order code	Pkg qty	Weight (1 pce)
Rated operational power	3-phase motor rating	General use rating						
400 V AC-3	480 V		VDC					kg
kW	hp							

### BC6 mini contactors

Rated power (kW)	Rated current (A)	3-phase motor rating (hp)	Rated voltage (V)	Rated current (A)	UC	Contacts	Type	Order code	Pkg qty	Weight (kg)	
4	20	3	300 V / 12 A	12	12	1 0	BC6-30-10-07	GJL1213001R0107	10	0.175	
						0 1	BC6-30-01-07	GJL1213001R0017	10	0.175	
						24	1 0	BC6-30-10-01	GJL1213001R0101	10	0.175
							0 1	BC6-30-01-01	GJL1213001R0011	10	0.175
						48	1 0	BC6-30-10-16	GJL1213001R1106	10	0.175
							0 1	BC6-30-01-16	GJL1213001R1016	10	0.175
						60	1 0	BC6-30-10-03	GJL1213001R0103	10	0.175
							0 1	BC6-30-01-03	GJL1213001R0013	10	0.175
						110 ... 125	1 0	BC6-30-10-04	GJL1213001R0104	10	0.175
							0 1	BC6-30-01-04	GJL1213001R0014	10	0.175
						220 ... 240	1 0	BC6-30-10-05	GJL1213001R0105	10	0.175
							0 1	BC6-30-01-05	GJL1213001R0015	10	0.175

### BC7 mini contactors

Rated power (kW)	Rated current (A)	3-phase motor rating (hp)	Rated voltage (V)	Rated current (A)	UC	Contacts	Type	Order code	Pkg qty	Weight (kg)	
5.5	20	5	600 V / 16 A	12	12	1 0	BC7-30-10-07	GJL1313001R0107	10	0.175	
						0 1	BC7-30-01-07	GJL1313001R0017	10	0.175	
						24	1 0	BC7-30-10-01	GJL1313001R0101	10	0.175
							0 1	BC7-30-01-01	GJL1313001R0011	10	0.175
						48	1 0	BC7-30-10-16	GJL1313001R1106	10	0.175
							0 1	BC7-30-01-16	GJL1313001R1016	10	0.175
						60	1 0	BC7-30-10-03	GJL1313001R1103	10	0.175
							0 1	BC7-30-01-03	GJL1313001R0013	10	0.175
						110 ... 125	1 0	BC7-30-10-04	GJL1313001R0104	10	0.175
							0 1	BC7-30-01-04	GJL1313001R0014	10	0.175
						220 ... 240	1 0	BC7-30-10-05	GJL1313001R0105	10	0.175
							0 1	BC7-30-01-05	GJL1313001R0015	10	0.175

### B7D mini contactors with integrated suppressor diode

Rated power (kW)	Rated current (A)	3-phase motor rating (hp)	Rated voltage (V)	Rated current (A)	UC	Contacts	Type	Order code	Pkg qty	Weight (kg)	
5.5	20	5	600 V / 16 A	24	24	1 0	B7D-30-10-01	GJL1317001R0101	10	0.175	
						0 1	B7D-30-01-01	GJL1317001R0011	10	0.175	
						220	1 0	B7D-30-10-05	GJL1317001R0105	10	0.175
							0 1	B7D-30-01-05	GJL1317001R0015	10	0.175

Other types on request

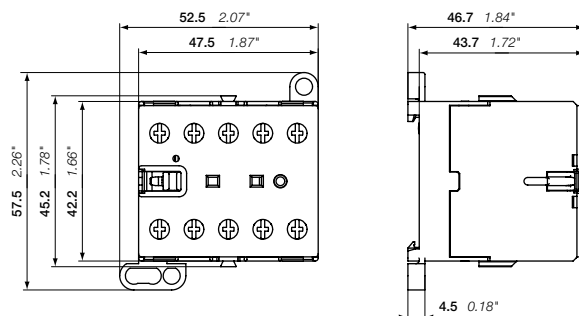

BC6, BC7, B7D

Main dimensions mm, inches



# VB6, VB7 3-pole mini reversing contactors – with screw terminals

4 to 5.5 kW

AC operated



2CDC11006F0011

VB7-30-10

VB6, VB7 3-pole compact design reversing contactors are space optimized control products mainly used for switching resistive or motor loads up to 690 V AC.

These reversing contactors are designed with:

- built-in mechanical interlock. The coils must be mutually interlocked electrically and coils must be de-energised for 50 ms at least to prevent phase to phase short circuit on the arc.
- control circuit: AC operated, low coil consumption (3.5 VA at pull-in and at holding)
- hum-free coil
- add-on auxiliary contact blocks for front mounting
- designed for rail or wall mounting

IEC	UL/CSA		Rated control circuit voltage UC		Auxiliary contacts fitted	Type	Order code	Pkg qty	Weight (1 pce)
	Rated operational power	3-phase current $\theta \leq 40^\circ\text{C}$	General motor use rating	50 Hz					
400 V AC-3	AC-1	480 V	50 Hz	60 Hz					
kW	A	hp	V AC	V AC					kg

### VB6 mini reversing contactors

Rated power (kW)	3-phase current (A)	General motor use rating (hp)	Rated voltage (V AC)	Rated current (A)	Control circuit (V AC)	Coil type	Order code	Pkg qty	Weight (kg)	
4	20	3	300 V / 12 A	24	24	1 0	VB6-30-10-01	GJL1211901R0101	5	0.355
						0 1	VB6-30-01-01	GJL1211901R0011	5	0.355
				42	42	1 0	VB6-30-10-02	GJL1211901R0102	5	0.355
						0 1	VB6-30-01-02	GJL1211901R0012	5	0.355
				48	48	1 0	VB6-30-10-03	GJL1211901R0103	5	0.355
						0 1	VB6-30-01-03	GJL1211901R0013	5	0.355
				110 ... 127	110 ... 127	1 0	VB6-30-10-84	GJL1211901R8104	5	0.355
						0 1	VB6-30-01-84	GJL1211901R8014	5	0.355
				220 ... 240	220 ... 240	1 0	VB6-30-10-80	GJL1211901R8100	5	0.355
						0 1	VB6-30-01-80	GJL1211901R8010	5	0.355
				380 ... 415	380 ... 415	1 0	VB6-30-10-85	GJL1211901R8105	5	0.355
						0 1	VB6-30-01-85	GJL1211901R8015	5	0.355

### VB7 mini reversing contactors

Rated power (kW)	3-phase current (A)	General motor use rating (hp)	Rated voltage (V AC)	Rated current (A)	Control circuit (V AC)	Coil type	Order code	Pkg qty	Weight (kg)	
5.5	20	5	600 V / 16 A	24	24	1 0	VB7-30-10-01	GJL1311901R0101	5	0.355
						0 1	VB7-30-01-01	GJL1311901R0011	5	0.355
				42	42	1 0	VB7-30-10-02	GJL1311901R0102	5	0.355
						0 1	VB7-30-01-02	GJL1311901R0012	5	0.355
				48	48	1 0	VB7-30-10-03	GJL1311901R0103	5	0.355
						0 1	VB7-30-01-03	GJL1311901R0013	5	0.355
				110 ... 127	110 ... 127	1 0	VB7-30-10-84	GJL1311901R8104	5	0.355
						0 1	VB7-30-01-84	GJL1311901R8014	5	0.355
				220 ... 240	220 ... 240	1 0	VB7-30-10-80	GJL1311901R8100	5	0.355
						0 1	VB7-30-01-80	GJL1311901R8010	5	0.355
				380 ... 415	380 ... 415	1 0	VB7-30-10-85	GJL1311901R8105	5	0.355
						0 1	VB7-30-01-85	GJL1311901R8015	5	0.355

Other types on request

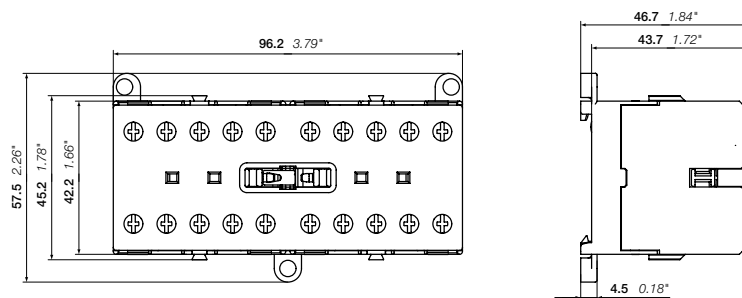

VB6, VB7

Main dimensions mm, inches

2CDC102016C0201

# VBC6, VBC7 3-pole mini reversing contactors – with screw terminals

4 to 5.5 kW

DC operated



VBC6-30-10

2CDC211042F0011



VBC7-30-10

2CDC211001F0011

VBC6, VBC7 3-pole compact design reversing contactors are space optimized control products mainly used for switching resistive or motor loads up to 690 V AC.

These reversing contactors are designed with:

- built-in mechanical interlock. The coils must be mutually interlocked electrically and coils must be de-energised for 50 ms at least to prevent phase to phase short circuit on the arc.
- control circuit: DC operated, low coil consumption (3.5 W at pull-in and at holding)
- hum-free coil
- add-on auxiliary contact blocks for front mounting
- designed for rail or wall mounting

IEC	UL/CSA		Rated control circuit voltage UC	Auxiliary contacts fitted	Type	Order code	Pkg qty	Weight (1 pce)
Rated operational power	3-phase current $\theta \leq 40^\circ\text{C}$	General use rating						
400 V AC-3	AC-1	3-phase motor rating 480 V	V DC					kg
kW	A	hp						

### VBC6 mini reversing contactors

Rated power (kW)	Rated current (A)	Rated hp	Rated voltage (V)	Rated current (A)	Coil voltage (V DC)	Coil current (A)	Type	Order code	Pkg qty	Weight (kg)	
4	20	3	300 V / 12 A	12	12	1	0	VBC6-30-10-07	GJL1213901R0107	5	0.355
						0	1	VBC6-30-01-07	GJL1213901R0017	5	0.355
				24	24	1	0	VBC6-30-10-01	GJL1213901R0101	5	0.355
						0	1	VBC6-30-01-01	GJL1213901R0011	5	0.355
				48	48	1	0	VBC6-30-10-16	GJL1213901R1106	5	0.355
						0	1	VBC6-30-01-16	GJL1213901R1016	5	0.355
				60	60	1	0	VBC6-30-10-03	GJL1213901R0103	5	0.355
						0	1	VBC6-30-01-03	GJL1213901R0013	5	0.355
				110 ... 125	110 ... 125	1	0	VBC6-30-10-04	GJL1213901R0104	5	0.355
						0	1	VBC6-30-01-04	GJL1213901R0014	5	0.355
				220 ... 240	220 ... 240	1	0	VBC6-30-10-05	GJL1213901R0105	5	0.355
						0	1	VBC6-30-01-05	GJL1213901R0015	5	0.355

### VBC7 mini reversing contactors

Rated power (kW)	Rated current (A)	Rated hp	Rated voltage (V)	Rated current (A)	Coil voltage (V DC)	Coil current (A)	Type	Order code	Pkg qty	Weight (kg)	
5.5	20	5	600 V / 16 A	12	12	1	0	VBC7-30-10-07	GJL1313901R0107	5	0.355
						0	1	VBC7-30-01-07	GJL1313901R0017	5	0.355
				24	24	1	0	VBC7-30-10-01	GJL1313901R0101	5	0.355
						0	1	VBC7-30-01-01	GJL1313901R0011	5	0.355
				48	48	1	0	VBC7-30-10-16	GJL1313901R1106	5	0.355
						0	1	VBC7-30-01-16	GJL1313901R1016	5	0.355
				60	60	1	0	VBC7-30-10-03	GJL1313901R0103	5	0.355
						0	1	VBC7-30-01-03	GJL1313901R0013	5	0.355
				110 ... 125	110 ... 125	1	0	VBC7-30-10-04	GJL1313901R0104	5	0.355
						0	1	VBC7-30-01-04	GJL1313901R0014	5	0.355
				220 ... 240	220 ... 240	1	0	VBC7-30-10-05	GJL1313901R0105	5	0.355
						0	1	VBC7-30-01-05	GJL1313901R0015	5	0.355

Other types on request

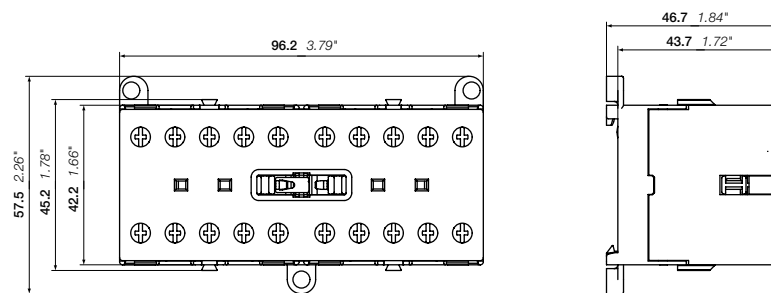

VBC6, VBC7

Main dimensions mm, inches

2CDC10201TC0201

# VB6A, VB7A 3-pole mini reversing contactors – with screw terminals

4 to 5.5 kW

AC operated – with safety blocking function



VB6A-30-10

2CDC211037F0011



VB7A-30-10

2CDC211009F0011

VB6A, VB7A 3-pole compact design reversing contactors are space optimized control products mainly used for switching resistive or motor loads up to 690 V AC.

These reversing contactors are designed with:

- built-in mechanical interlock and safety blocking function. The safety blocking function is triggered if the voltage is applied to the coil of the contactor to be switched on before the contactor to be switched off has dropped out. The contactor coils are designed for continuous operation when the contactor is de-energised i.e. the coil is not damaged if the mechanical interlock prevents switch-on of the contactor with the coil voltage applied.
- control circuit: AC operated, low coil consumption (3.5 VA at pull-in and at holding)
- hum-free coil
- add-on auxiliary contact blocks for front mounting
- designed for rail or wall mounting

IEC		UL/CSA		Rated control circuit voltage UC		Auxiliary contacts fitted	Type	Order code	Pkg qty	Weight (1 pce)
Rated operational power	current $\theta \leq 40^\circ\text{C}$	3-phase motor rating	General use rating	50 Hz	60 Hz					
400 V	AC-3	AC-1	480 V	V AC	V AC					kg
kW	A	hp								

### VB6A mini reversing contactors with safety blocking function

4	20	3	300 V / 12 A	24	24	1 0	VB6A-30-10-01	GJL121191R0101	5	0.355
				42	42	0 1	VB6A-30-01-01	GJL121191R0011	5	0.355
						1 0	VB6A-30-10-02	GJL121191R0102	5	0.355
						0 1	VB6A-30-01-02	GJL121191R0012	5	0.355
				48	48	1 0	VB6A-30-10-03	GJL121191R0103	5	0.355
						0 1	VB6A-30-01-03	GJL121191R0013	5	0.355
				110 ... 127	110 ... 127	1 0	VB6A-30-10-84	GJL121191R8104	5	0.355
						0 1	VB6A-30-01-84	GJL121191R8014	5	0.355
				220 ... 240	220 ... 240	1 0	VB6A-30-10-80	GJL121191R8100	5	0.355
						0 1	VB6A-30-01-80	GJL121191R8010	5	0.355
				380 ... 415	380 ... 415	1 0	VB6A-30-10-85	GJL121191R8105	5	0.355
						0 1	VB6A-30-01-85	GJL121191R8015	5	0.355

### VB7A mini reversing contactors with safety blocking function

5.5	20	5	600 V / 16 A	24	24	1 0	VB7A-30-10-01	GJL131191R0101	5	0.355
				42	42	0 1	VB7A-30-01-01	GJL131191R0011	5	0.355
						1 0	VB7A-30-10-02	GJL131191R0102	5	0.355
						0 1	VB7A-30-01-02	GJL131191R0012	5	0.355
				48	48	1 0	VB7A-30-10-03	GJL131191R0103	5	0.355
						0 1	VB7A-30-01-03	GJL131191R0013	5	0.355
				110 ... 127	110 ... 127	1 0	VB7A-30-10-84	GJL131191R8104	5	0.355
						0 1	VB7A-30-01-84	GJL131191R8014	5	0.355
				220 ... 240	220 ... 240	1 0	VB7A-30-10-80	GJL131191R8100	5	0.355
						0 1	VB7A-30-01-80	GJL131191R8010	5	0.355
				380 ... 415	380 ... 415	1 0	VB7A-30-10-85	GJL131191R8105	5	0.355
						0 1	VB7A-30-01-85	GJL131191R8015	5	0.355

Other types on request

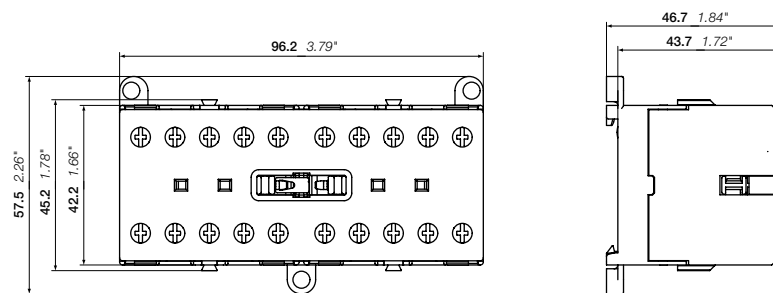

VB6A, VB7A

Main dimensions mm, inches

2CDC102018C0201

# VBC6A, VBC7A 3-pole mini reversing contactors – with screw terminals

4 to 5.5 kW

DC operated – with safety blocking function



VBC6A-30-10

2CDC21044F0011



VBC7A-30-10

2CDC21007F0011

VBC6A, VBC7A 3-pole compact design reversing contactors are space optimized control products mainly used for switching resistive or motor loads up to 690 V AC.

These reversing contactors are designed with:

- built-in mechanical interlock and safety blocking function. The safety blocking function is triggered if the voltage is applied to the coil of the contactor to be switched on before the contactor to be switched off has dropped out. The contactor coils are designed for continuous operation when the contactor is de-energised i.e. the coil is not damaged if the mechanical interlock prevents switch-on of the contactor with the coil voltage applied.
- control circuit: DC operated, low coil consumption (3.5 W at pull-in and at holding)
- hum-free coil
- add-on auxiliary contact blocks for front mounting
- designed for rail or wall mounting

IEC	UL/CSA		Rated control circuit voltage UC	Auxiliary contacts fitted	Type	Order code	Pkg qty	Weight (1 pce)
Rated operational power	3-phase motor rating	General use rating						
400 V AC-3 kW	AC-1 A	480 V hp	VDC					kg

### VBC6A mini reversing contactors with safety blocking function

Rated power	Rated current	3-phase motor rating	General use rating	Rated control circuit voltage UC	Number of auxiliary contacts	Order code	Pkg qty	Weight (1 pce)	
4	20	3	300 V / 12 A	12	1 0	VBC6A-30-10-07	GJL1213911R0107	5	0.355
					0 1	VBC6A-30-01-07	GJL1213911R0017	5	0.355
					1 0	VBC6A-30-10-01	GJL1213911R0101	5	0.355
					0 1	VBC6A-30-01-01	GJL1213911R0011	5	0.355
					1 0	VBC6A-30-10-16	GJL1213911R1106	5	0.355
					0 1	VBC6A-30-01-16	GJL1213911R1016	5	0.355
					1 0	VBC6A-30-10-03	GJL1213911R0103	5	0.355
					0 1	VBC6A-30-01-03	GJL1213911R0013	5	0.355
					1 0	VBC6A-30-10-04	GJL1213911R0104	5	0.355
					0 1	VBC6A-30-01-04	GJL1213911R0014	5	0.355
					1 0	VBC6A-30-10-05	GJL1213911R0105	5	0.355
					0 1	VBC6A-30-01-05	GJL1213911R0015	5	0.355

### VBC7A mini reversing contactors with safety blocking function

Rated power	Rated current	3-phase motor rating	General use rating	Rated control circuit voltage UC	Number of auxiliary contacts	Order code	Pkg qty	Weight (1 pce)	
5.5	20	5	600 V / 16 A	12	1 0	VBC7A-30-10-07	GJL1313911R0107	5	0.355
					0 1	VBC7A-30-01-07	GJL1313911R0017	5	0.355
					1 0	VBC7A-30-10-01	GJL1313911R0101	5	0.355
					0 1	VBC7A-30-01-01	GJL1313911R0011	5	0.355
					1 0	VBC7A-30-10-16	GJL1313911R1106	5	0.355
					0 1	VBC7A-30-01-16	GJL1313911R1016	5	0.355
					1 0	VBC7A-30-10-03	GJL1313911R0103	5	0.355
					0 1	VBC7A-30-01-03	GJL1313911R0013	5	0.355
					1 0	VBC7A-30-10-04	GJL1313911R0104	5	0.355
					0 1	VBC7A-30-01-04	GJL1313911R0014	5	0.355
					1 0	VBC7A-30-10-05	GJL1313911R0105	5	0.355
					0 1	VBC7A-30-01-05	GJL1313911R0015	5	0.355

Other types on request

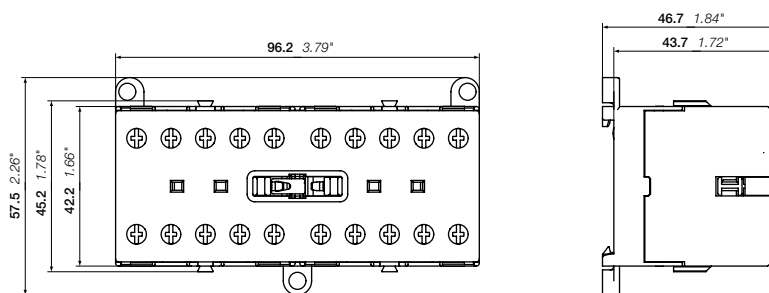

VBC6A, VBC7A

Main dimensions mm, inches

04

2CDC102019C0201

# BC6, BC7 3-pole interface mini contactors – with screw terminals

4 to 5.5 kW  
DC operated



BC6-30-10



BC7-30-10

BC6, BC7 3-pole interface mini contactors are compact control products mainly used for switching resistive or motor loads up to 690 V AC.

These contactors are designed with:

- 3 main poles and one built-in auxiliary contact
- control circuit: DC operated, very low coil consumption. Suitable for direct control by PLC-outputs
- hum-free coil
- no auxiliary contact block permitted for mounting
- designed for rail or wall mounting

IEC	UL/CSA		Rated control circuit voltage UC	Auxiliary contacts fitted	Type	Order code	Pkg qty	Weight (1 pce)
Rated operational power	3-phase current $\theta \leq 40^\circ\text{C}$	General motor rating						
400 V AC-3	AC-1		VDC					kg
kW	A	hp						

### DC operation 24 V / 1.4 W

Power (kW)	Current (A)	Motor Rating (hp)	Rated Voltage (V)	Rated Current (A)	UC	Type	Order code	Pkg qty	Weight (kg)
4	20	3	300 V / 12 A	24	1 0	BC6-30-10-1.4-81	GJL1213001R8101	10	0.175
					0 1	BC6-30-01-1.4-81	GJL1213001R8011	10	0.175
5.5	20	5	600 V / 16 A	24	1 0	BC7-30-10-1.4-81	GJL1313001R8101	10	0.175
					0 1	BC7-30-01-1.4-81	GJL1313001R8011	10	0.175

### DC operation 17 ... 32 V / 2.4 W

Power (kW)	Current (A)	Motor Rating (hp)	Rated Voltage (V)	Rated Current (A)	UC	Type	Order code	Pkg qty	Weight (kg)
4	20	3	300 V / 12 A	17 ... 32	1 0	BC6-30-10-2.4-51	GJL1213001R5101	10	0.175
					0 1	BC6-30-01-2.4-51	GJL1213001R5011	10	0.175
5.5	20	5	600 V / 16 A	17 ... 32	1 0	BC7-30-10-2.4-51	GJL1313001R5101	10	0.175
					0 1	BC7-30-01-2.4-51	GJL1313001R5011	10	0.175

### Connection to PLCs with integrated protective circuit

#### DC operation 24 V / 1.7 W

Power (kW)	Current (A)	Motor Rating (hp)	Rated Voltage (V)	Rated Current (A)	UC	Type	Order code	Pkg qty	Weight (kg)
4	20	3	300 V / 12 A	24	1 0	B6S-30-10-1.7-71	GJL1213001R7101	10	0.175
					0 1	B6S-30-01-1.7-71	GJL1213001R7011	10	0.175
5.5	20	5	600 V / 16 A	24	1 0	B7S-30-10-1.7-71	GJL1313001R7101	10	0.175
					0 1	B7S-30-01-1.7-71	GJL1313001R7011	10	0.175

#### DC operation 17 ... 32 V / 2.8 W

Power (kW)	Current (A)	Motor Rating (hp)	Rated Voltage (V)	Rated Current (A)	UC	Type	Order code	Pkg qty	Weight (kg)
4	20	3	300 V / 12 A	17 ... 32	1 0	B6S-30-10-2.8-72	GJL1213001R7102	10	0.175
					0 1	B6S-30-01-2.8-72	GJL1213001R7012	10	0.175
5.5	20	5	600 V / 16 A	17 ... 32	1 0	B7S-30-10-2.8-72	GJL1313001R7102	10	0.175
					0 1	B7S-30-01-2.8-72	GJL1313001R7012	10	0.175

Other types on request

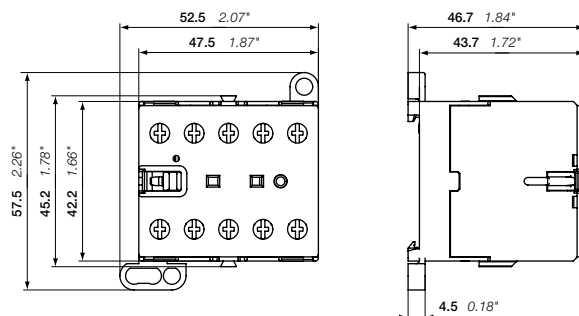

BC6, BC7

Main dimensions mm, inches

# B6, B7 4-pole mini contactors – with screw terminals

4 to 5.5 kW

AC operated



B6-22-00

2CDC11028F0011

B6, B7 4-pole mini contactors are compact control products mainly used for switching resistive loads up to 690 V AC.

These contactors are designed with:

4 main poles

- control circuit: AC operated, low coil consumption (3.5 VA at pull-in and at holding)
- hum-free coil
- add-on auxiliary contact blocks for front or side mounting and a wide range of accessories
- designed for rail or wall mounting

IEC	UL/CSA	Rated control circuit voltage UC	Auxiliary contacts fitted	Type	Order code	Pkg qty	Weight (1 pce)
Rated operational current $\theta \leq 40^\circ\text{C}$ AC-1 A	General use rating	50/60 Hz  V AC					kg

### 4 N.O. main poles

20	300 V / 12 A	24	0 0	B6-40-00-01	GJL1211201R0001	10	0.175
		42	0 0	B6-40-00-02	GJL1211201R0002	10	0.175
		48	0 0	B6-40-00-03	GJL1211201R0003	10	0.175
		110 ... 127	0 0	B6-40-00-84	GJL1211201R8004	10	0.175
		220 ... 240	0 0	B6-40-00-80	GJL1211201R8000	10	0.175
20	600 V / 16 A	24	0 0	B7-40-00-01	GJL1311201R0001	10	0.175
		42	0 0	B7-40-00-02	GJL1311201R0002	10	0.175
		48	0 0	B7-40-00-03	GJL1311201R0003	10	0.175
		110 ... 127	0 0	B7-40-00-84	GJL1311201R8004	10	0.175
		220 ... 240	0 0	B7-40-00-80	GJL1311201R8000	10	0.175

### 2 N.O. + 2 N.C. main poles

20	300 V / 12 A	24	0 0	B6-22-00-01	GJL1211501R0001	10	0.175
		42	0 0	B6-22-00-02	GJL1211501R0002	10	0.175
		48	0 0	B6-22-00-03	GJL1211501R0003	10	0.175
		110 ... 127	0 0	B6-22-00-84	GJL1211501R8004	10	0.175
		220 ... 240	0 0	B6-22-00-80	GJL1211501R8000	10	0.175
20	600 V / 16 A	24	0 0	B7-22-00-01	GJL1311501R0001	10	0.175
		42	0 0	B7-22-00-02	GJL1311501R0002	10	0.175
		48	0 0	B7-22-00-03	GJL1311501R0003	10	0.175
		110 ... 127	0 0	B7-22-00-84	GJL1311501R8004	10	0.175
		220 ... 240	0 0	B7-22-00-80	GJL1311501R8000	10	0.175

Other types on request

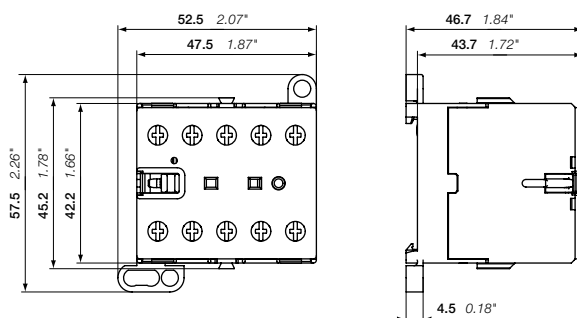

B6, B7

Main dimensions mm, inches

04

2CDC102009C0201

# BC6, B7D 4-pole mini contactors – with screw terminals

4 to 5.5 kW

DC operated



BC6-22-00

2CDC11032F00101

BC6, B7D 4-pole mini contactors are compact control products mainly used for switching resistive loads up to 690 V AC.

These contactors are designed with:

- 4 main poles
- control circuit: DC operated, low coil consumption (3.5 W at pull-in and at holding)
- hum-free coil
- add-on auxiliary contact blocks for front or side mounting
- designed for rail or wall mounting

IEC	UL/CSA	Rated control circuit voltage UC	Auxiliary contacts fitted	Type	Order code	Pkg qty	Weight (1 pce)
Rated operational current $\theta \leq 40^\circ\text{C}$ AC-1 A	General use rating	V DC					kg

### 4 N.O. main poles

20	600 V / 16 A	24	0 0	B7D-40-00-01	GJL1317201R0001	10	0.175
		220	0 0	B7D-40-00-05	GJL1317201R0005	10	0.175

### 2 N.O. + 2 N.C. main poles

20	300 V / 12 A	12	0 0	BC6-22-00-07	GJL1213501R0007	10	0.175
		24	0 0	BC6-22-00-01	GJL1213501R0001	10	0.175
		42	0 0	BC6-22-00-02	GJL1213501R0002	10	0.175
		48	0 0	BC6-22-00-16	GJL1213501R1006	10	0.175
		60	0 0	BC6-22-00-03	GJL1213501R0003	10	0.175
		110 ... 125	0 0	BC6-22-00-04	GJL1213501R0004	10	0.175
		220 ... 240	0 0	BC6-22-00-05	GJL1213501R0005	10	0.175

Other types on request

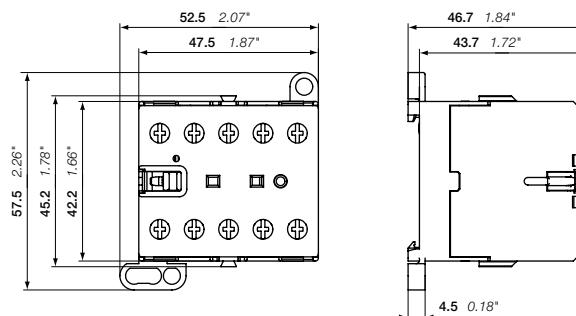

BC6, B7D

Main dimensions mm, inches

2CDC102021C0201

# K6 4-pole mini contactor relays – with screw terminals

AC operated



K6-22Z

2CDC21101R0011



K6-31Z

2CDC211004F0010

K6 4-pole mini-contactor relays are space optimized control products mainly used for control functions or for small loads up to AC-15 4 A / 240 V.

These contactors are designed with:

- 4-poles with various contact combinations
- control circuit: AC operated, low coil consumption (3.5 VA at pull-in and at holding)
- hum-free coil
- add-on auxiliary contact blocks for front or side mounting
- designed for rail or wall mounting

Rated control circuit voltage		Type	Order code	Pkg qty	Weight (1 pce)
UC					
50 Hz	60 Hz				
V AC	V AC				kg

### K6 4-pole mini contactor relays

UC	UC	Type	Order code	Pkg qty	Weight (1 pce)
24	24	K6-22Z-01	GJH1211001R0221	10	0.175
42	42	K6-22Z-02	GJH1211001R0222	10	0.175
48	48	K6-22Z-03	GJH1211001R0223	10	0.175
110 ...127	110 ...127	K6-22Z-84	GJH1211001R8224	10	0.175
220 ... 240	220 ... 240	K6-22Z-80	GJH1211001R8220	10	0.175
380 ... 415	380 ... 415	K6-22Z-85	GJH1211001R8225	10	0.175
24	24	K6-31Z-01	GJH1211001R0311	10	0.175
42	42	K6-31Z-02	GJH1211001R0312	10	0.175
48	48	K6-31Z-03	GJH1211001R0313	10	0.175
110 ...127	110 ...127	K6-31Z-84	GJH1211001R8314	10	0.175
220 ... 240	220 ... 240	K6-31Z-80	GJH1211001R8310	10	0.175
380 ... 415	380 ... 415	K6-31Z-85	GJH1211001R8315	10	0.175
24	24	K6-40E-01	GJH1211001R0401	10	0.175
42	42	K6-40E-02	GJH1211001R0402	10	0.175
48	48	K6-40E-03	GJH1211001R0403	10	0.175
110 ...127	110 ...127	K6-40E-84	GJH1211001R8404	10	0.175
220 ... 240	220 ... 240	K6-40E-80	GJH1211001R8400	10	0.175
380 ... 415	380 ... 415	K6-40E-85	GJH1211001R8405	10	0.175

Other types on request

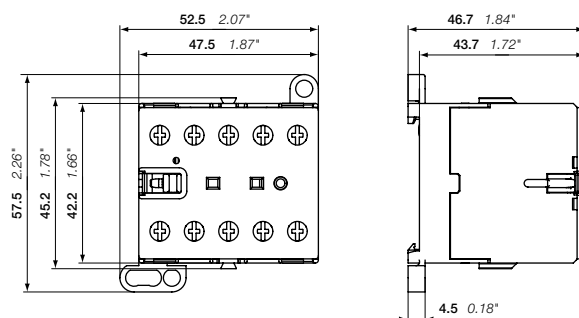

K6

Main dimensions mm, inches



# KC6 4-pole mini contactor relays – with screw terminals

DC operated



KC6-22Z

2CDC211016F0011

KC6 4-pole mini-contactor relays are space optimized control products mainly used for control functions or for small loads up to AC-15 4 A / 240 V.

These contactors are designed with:

- 4-poles with various contact combinations
- control circuit: DC operated, low coil consumption (3.5 W at pull-in and at holding)
- hum-free coil
- add-on auxiliary contact blocks for front or side mounting
- designed for rail or wall mounting

Rated control circuit voltage UC VDC	Type	Order code	Pkg qty	Weight (1 pce) kg
--	------	------------	------------	-------------------------

**KC6 4-pole mini contactor relays**

12	KC6-22Z-07	GJH1213001R0227	10	0.175
24	KC6-22Z-01	GJH1213001R0221	10	0.175
48	KC6-22Z-16	GJH1213001R1226	10	0.175
60	KC6-22Z-03	GJH1213001R0223	10	0.175
110 ... 125	KC6-22Z-04	GJH1213001R0224	10	0.175
220 ... 240	KC6-22Z-05	GJH1213001R0225	10	0.175
12	KC6-31Z-07	GJH1213001R0317	10	0.175
24	KC6-31Z-01	GJH1213001R0311	10	0.175
48	KC6-31Z-16	GJH1213001R1316	10	0.175
60	KC6-31Z-03	GJH1213001R0313	10	0.175
110 ... 125	KC6-31Z-04	GJH1213001R0314	10	0.175
220 ... 240	KC6-31Z-05	GJH1213001R0315	10	0.175
12	KC6-40E-07	GJH1213001R0407	10	0.175
24	KC6-40E-01	GJH1213001R0401	10	0.175
48	KC6-40E-16	GJH1213001R1406	10	0.175
60	KC6-40E-03	GJH1213001R0403	10	0.175
110 ... 125	KC6-40E-04	GJH1213001R0404	10	0.175
220 ... 240	KC6-40E-05	GJH1213001R0405	10	0.175

Other types on request

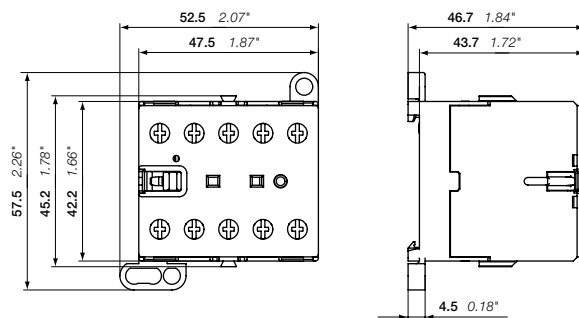

KC6

Main dimensions mm, inches

2CDC102012C0201

# KC6 4-pole interface mini contactor relays – with screw terminals

DC operated



KC6-31Z

2CDC211017F0011

KC6 4-pole interface mini-contactor relays are space optimized control products mainly used for control functions or for small loads up to AC-15 4 A / 240 V.

These contactors are designed with:

- 4-poles with various contact combinations
- control circuit: DC operated, very low coil consumption. Suitable for direct control by PLC-outputs
- hum-free coil
- no auxiliary contact block permitted for mounting
- designed for rail or wall mounting

Rated control circuit voltage UC VDC	Type	Order code	Pkg qty	Weight (1 pce) kg
--	------	------------	------------	-------------------------

**DC operation 24 V / 1.4 W**

24	KC6-31Z-1.4-81	GJH1213001R8311	10	0.175
24	KC6-40E-1.4-81	GJH1213001R8401	10	0.175

**DC operation 17 ... 32 V / 2.4 W**

17 ... 32	KC6-31Z-2.4-51	GJH1213001R5311	10	0.175
17 ... 32	KC6-40E-2.4-51	GJH1213001R5401	10	0.175

**Connection to PLCs with integrated protective circuit**

**DC operation 24 V / 1.7 W**

24	K6S-22Z-1.7-71	GJH1213001R7221	10	0.175
24	K6S-31Z-1.7-71	GJH1213001R7311	10	0.175
24	K6S-40E-1.7-71	GJH1213001R7401	10	0.175

**DC operation 17 ... 32 V / 2.8 W**

17 ... 32	K6S-22Z-2.8-72	GJH1213001R7222	10	0.175
17 ... 32	K6S-31Z-2.8-72	GJH1213001R7312	10	0.175
17 ... 32	K6S-40E-2.8-72	GJH1213001R7402	10	0.175

Other types on request

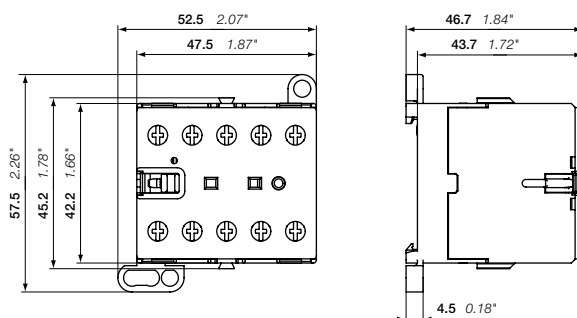

KC6

Main dimensions mm, inches

04

2CDC102013C0201

# B6, B7 3-pole mini contactors – with soldering pins

4 to 5.5 kW

AC operated



B6-30-10-P

2CDC211003P0010



B7-30-10-P

2CDC211011P0011

B6..P and B7..P 3-pole mini contactors are compact control products mainly used for switching resistive or motor loads up to 690 V AC.

These contactors are designed with:

- 3 main poles and one built-in auxiliary contact
- control circuit: AC operated, low coil consumption (3.5 VA at pull-in and at holding)
- hum-free coil
- add-on auxiliary contact blocks for side mounting
- designed for soldering on PCB boards

IEC	UL/CSA		Rated control circuit voltage UC		Auxiliary contacts fitted	Type	Order code	Pkg qty	Weight (1 pce)
	Rated power	operational current $\theta \leq 40^\circ\text{C}$	3-phase motor rating	General use rating					
400 V AC-3	AC-1	480 V							kg
kW	A	hp		V AC		V AC			

### B6 mini contactors

IEC	UL/CSA	Rated power	operational current $\theta \leq 40^\circ\text{C}$	3-phase motor rating	General use rating	Rated control circuit voltage UC	50 Hz	60 Hz	Auxiliary contacts fitted	Type	Order code	Pkg qty	Weight (1 pce)	
4	12	3	300 V / 12 A	24	24	24	1	0	1	0	B6-30-10-P-01	GJL1211009R0101	10	0.170
							0	1	0	1	B6-30-01-P-01	GJL1211009R0011	10	0.170
							1	0	1	0	B6-30-10-P-02	GJL1211009R0102	10	0.170
							0	1	0	1	B6-30-01-P-02	GJL1211009R0012	10	0.170
							1	0	1	0	B6-30-10-P-03	GJL1211009R0103	10	0.170
							0	1	0	1	B6-30-01-P-03	GJL1211009R0013	10	0.170
							1	0	1	0	B6-30-10-P-84	GJL1211009R8104	10	0.170
							0	1	0	1	B6-30-01-P-84	GJL1211009R8014	10	0.170
							1	0	1	0	B6-30-10-P-80	GJL1211009R8100	10	0.170
							0	1	0	1	B6-30-01-P-80	GJL1211009R8010	10	0.170
							1	0	1	0	B6-30-10-P-85	GJL1211009R8105	10	0.170
							0	1	0	1	B6-30-01-P-85	GJL1211009R8015	10	0.170

### B7 mini contactors

IEC	UL/CSA	Rated power	operational current $\theta \leq 40^\circ\text{C}$	3-phase motor rating	General use rating	Rated control circuit voltage UC	50 Hz	60 Hz	Auxiliary contacts fitted	Type	Order code	Pkg qty	Weight (1 pce)	
5.5	12	5	600 V / 16 A	24	24	24	1	0	1	0	B7-30-10-P-01	GJL1311009R0101	10	0.170
							0	1	0	1	B7-30-01-P-01	GJL1311009R0011	10	0.170
							1	0	1	0	B7-30-10-P-02	GJL1311009R0102	10	0.170
							0	1	0	1	B7-30-01-P-02	GJL1311009R0012	10	0.170
							1	0	1	0	B7-30-10-P-03	GJL1311009R0103	10	0.170
							0	1	0	1	B7-30-01-P-03	GJL1311009R0013	10	0.170
							1	0	1	0	B7-30-10-P-84	GJL1311009R8104	10	0.170
							0	1	0	1	B7-30-01-P-84	GJL1311009R8014	10	0.170
							1	0	1	0	B7-30-10-P-80	GJL1311009R8100	10	0.170
							0	1	0	1	B7-30-01-P-80	GJL1311009R8010	10	0.170
							1	0	1	0	B7-30-10-P-85	GJL1311009R8105	10	0.170
							0	1	0	1	B7-30-01-P-85	GJL1311009R8015	10	0.170

Other types on request

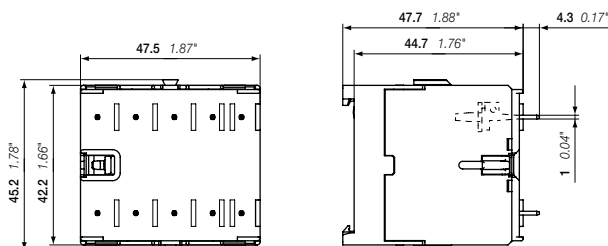

B6, B7

Main dimensions mm, inches

2CDC102023C0201

# BC6, BC7 3-pole mini contactors – with soldering pins

4 to 5.5 kW

DC operated



BC7-30-10-P

2CDC211030F0011

BC6..P and BC7..P 3-pole mini contactors are compact control products mainly used for switching resistive or motor loads up to 690 V AC.

These contactors are designed with:

- 3 main poles and one built-in auxiliary contact
- control circuit: DC operated, low coil consumption (3.5 W at pull-in and at holding)
- hum-free coil
- add-on auxiliary contact blocks for side mounting
- designed for soldering on PCB boards

IEC	UL/CSA		Rated control circuit voltage UC	Auxiliary contacts fitted	Type	Order code	Pkg qty	Weight (1 pce)
Rated operational power	3-phase motor rating	General use rating						
400 V AC-3	AC-1	480 V	V DC					kg
kW	A	hp						

### BC6 mini contactors with 3 N.O. main poles

Rated power	Rated current	Main poles	Rated voltage	Rated current	UC	1 N.O.	1 N.C.	Order code	Pkg qty	Weight	
4	12	3	300 V / 12 A	12	V DC	1	0	BC6-30-10-P-07	GJL1213009R0107	10	0.170
						0	1	BC6-30-01-P-07	GJL1213009R0017	10	0.170
				24	1	0	BC6-30-10-P-01	GJL1213009R0101	10	0.170	
					0	1	BC6-30-01-P-01	GJL1213009R0011	10	0.170	
				48	1	0	BC6-30-10-P-16	GJL1213009R1106	10	0.170	
					0	1	BC6-30-01-P-16	GJL1213009R1016	10	0.170	
				60	1	0	BC6-30-10-P-03	GJL1213009R0103	10	0.170	
					0	1	BC6-30-01-P-03	GJL1213009R0013	10	0.170	
				110 ... 125	1	0	BC6-30-10-P-04	GJL1213009R0104	10	0.170	
					0	1	BC6-30-01-P-04	GJL1213009R0014	10	0.170	
				220 ... 240	1	0	BC6-30-10-P-05	GJL1213009R0105	10	0.170	
					0	1	BC6-30-01-P-05	GJL1213009R0015	10	0.170	

### BC7 mini contactors with 3 N.O. main poles

Rated power	Rated current	Main poles	Rated voltage	Rated current	UC	1 N.O.	1 N.C.	Order code	Pkg qty	Weight	
5.5	12	5	600 V / 16 A	12	V DC	1	0	BC7-30-10-P-07	GJL1313009R0107	10	0.170
						0	1	BC7-30-01-P-07	GJL1313009R0017	10	0.170
				24	1	0	BC7-30-10-P-01	GJL1313009R0101	10	0.170	
					0	1	BC7-30-01-P-01	GJL1313009R0011	10	0.170	
				48	1	0	BC7-30-10-P-16	GJL1313009R1106	10	0.170	
					0	1	BC7-30-01-P-16	GJL1313009R1016	10	0.170	
				60	1	0	BC7-30-10-P-03	GJL1313009R0103	10	0.170	
					0	1	BC7-30-01-P-03	GJL1313009R0013	10	0.170	
				110 ... 125	1	0	BC7-30-10-P-04	GJL1313009R0104	10	0.170	
					0	1	BC7-30-01-P-04	GJL1313009R0014	10	0.170	
				220 ... 240	1	0	BC7-30-10-P-05	GJL1313009R0105	10	0.170	
					0	1	BC7-30-01-P-05	GJL1313009R0015	10	0.170	

### BC6 mini contactors 2 N.O. + 1 N.C. main poles

Rated power	Rated current	Main poles	Rated voltage	Rated current	UC	2 N.O.	1 N.C.	Order code	Pkg qty	Weight	
4	12	3	300 V / 12 A	V DC	24	1	0	BC6-21-10-P-01	GJL1213109R0101	10	0.170
					48	1	0	BC6-21-10-P-16	GJL1213109R1106	10	0.170
					60	1	0	BC6-21-10-P-03	GJL1213109R0103	10	0.170
					110 ... 125	1	0	BC6-21-10-P-04	GJL1213109R0104	10	0.170
					220 ... 240	1	0	BC6-21-10-P-05	GJL1213109R0105	10	0.170

Other types on request

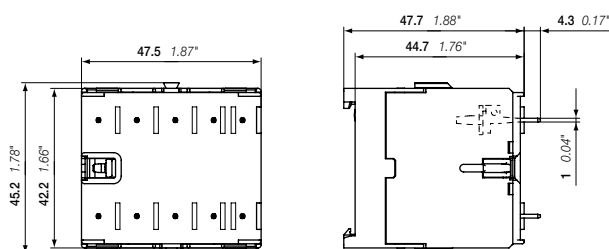

B6, B7

Main dimensions mm, inches

2CDC102024C0201

# VB6, VB7 3-pole mini reversing contactors – with soldering pins

4 to 5.5 kW

AC operated



VB7-30-10-P

1100050601

VB6..P, VB7..P 3-pole compact design reversing contactors are space optimized control products mainly used for switching resistive or motor loads up to 690 V AC.

These reversing contactors are designed with:

- built-in mechanical interlock. The coils must be mutually interlocked electrically and coils must be de-energised for 50 ms at least to prevent phase to phase short circuit on the arc
- control circuit: AC operated, low coil consumption (3.5 VA at pull-in and at holding)
- hum-free coil
- no auxiliary contact block permitted for mounting
- designed for soldering on PCB boards

IEC	UL/CSA		Rated control circuit voltage		Auxiliary contacts fitted	Type	Order code	Pkg qty	Weight (1 pce)
	Rated operational power	3-phase motor current $\theta \leq 40^\circ\text{C}$	General use rating	UC					
400 V AC-3	AC-1	480 V	hp						
kW	A			V AC	V AC				kg

### VB6 mini reversing contactors

Rated power	Rated current	3-phase motor rating	General use rating	UC	50 Hz	60 Hz	Auxiliary contacts	Type	Order code	Pkg qty	Weight (1 pce)
4	12	3	300 V / 12 A	24	24	1	0	VB6-30-10-P-01	GJL1211909R0101	5	0.345
						0	1	VB6-30-01-P-01	GJL1211909R0011	5	0.345
				42	42	1	0	VB6-30-10-P-02	GJL1211909R0102	5	0.345
						0	1	VB6-30-01-P-02	GJL1211909R0012	5	0.345
				48	48	1	0	VB6-30-10-P-03	GJL1211909R0103	5	0.345
						0	1	VB6-30-01-P-03	GJL1211909R0013	5	0.345
				110 ... 127	110 ... 127	1	0	VB6-30-10-P-84	GJL1211909R8104	5	0.345
						0	1	VB6-30-01-P-84	GJL1211909R8014	5	0.345
				220 ... 240	220 ... 240	1	0	VB6-30-10-P-80	GJL1211909R8100	5	0.345
						0	1	VB6-30-01-P-80	GJL1211909R8010	5	0.345
				380 ... 415	380 ... 415	1	0	VB6-30-10-P-85	GJL1211909R8105	5	0.345
						0	1	VB6-30-01-P-85	GJL1211909R8015	5	0.345

### VB7 mini reversing contactors

Rated power	Rated current	3-phase motor rating	General use rating	UC	50 Hz	60 Hz	Auxiliary contacts	Type	Order code	Pkg qty	Weight (1 pce)
5.5	12	5	600 V / 16 A	24	24	1	0	VB7-30-10-P-01	GJL1311909R0101	5	0.345
						0	1	VB7-30-01-P-01	GJL1311909R0011	5	0.345
				42	42	1	0	VB7-30-10-P-02	GJL1311909R0102	5	0.345
						0	1	VB7-30-01-P-02	GJL1311909R0012	5	0.345
				48	48	1	0	VB7-30-10-P-03	GJL1311909R0103	5	0.345
						0	1	VB7-30-01-P-03	GJL1311909R0013	5	0.345
				110 ... 127	110 ... 127	1	0	VB7-30-10-P-84	GJL1311909R8104	5	0.345
						0	1	VB7-30-01-P-84	GJL1311909R8014	5	0.345
				220 ... 240	220 ... 240	1	0	VB7-30-10-P-80	GJL1311909R8100	5	0.345
						0	1	VB7-30-01-P-80	GJL1311909R8010	5	0.345
				380 ... 415	380 ... 415	1	0	VB7-30-10-P-85	GJL1311909R8105	5	0.345
						0	1	VB7-30-01-P-85	GJL1311909R8015	5	0.345

Other types on request

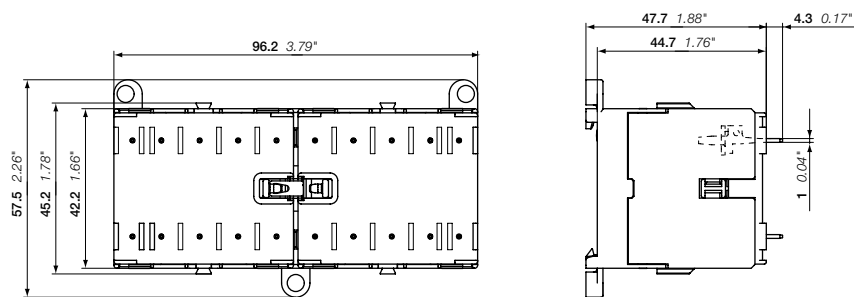

VB6, VB7

Main dimensions mm, inches

2CDC102025C0201

# VBC6, VBC7 3-pole mini reversing contactors – with soldering pins

4 to 5.5 kW

DC operated



VBC7-30-10-P

2CDC21009P001

VBC6..P, VBC7..P 3-pole compact design reversing contactors are space optimized control products mainly used for switching resistive or motor loads up to 690 V AC.

These reversing contactors are designed with:

- built-in mechanical interlock. The coils must be mutually interlocked electrically and coils must be de-energised for 50 ms at the least to prevent phase to phase short circuit on the arc
- control circuit: DC operated, low coil consumption (3.5 W at pull-in and at holding)
- hum-free coil
- no auxiliary contact block permitted for mounting
- designed for soldering on PCB boards

IEC	UL/CSA		Rated control circuit voltage UC	Auxiliary contacts fitted	Type	Order code	Pkg qty	Weight (1 pce)
Rated operational power	3-phase motor rating	General use rating						
400 V AC-3 kW	AC-1 A	480 V hp	V DC					kg

### VBC6 mini reversing contactors

4	12	3	300 V / 12 A	12	1 0	VBC6-30-10-P-07	GJL1213909R0107	5	0.345
					0 1	VBC6-30-01-P-07	GJL1213909R0017	5	0.345
				24	1 0	VBC6-30-10-P-01	GJL1213909R0101	5	0.345
					0 1	VBC6-30-01-P-01	GJL1213909R0011	5	0.345
				48	1 0	VBC6-30-10-P-06	GJL1213909R0106	5	0.345
					0 1	VBC6-30-06-P-06	GJL1213909R0016	5	0.345
				60	1 0	VBC6-30-10-P-03	GJL1213909R0103	5	0.345
					0 1	VBC6-30-01-P-03	GJL1213909R0013	5	0.345
				110 ... 125	1 0	VBC6-30-10-P-04	GJL1213909R0104	5	0.345
					0 1	VBC6-30-01-P-04	GJL1213909R0014	5	0.345
				220 ... 240	1 0	VBC6-30-10-P-05	GJL1213909R0105	5	0.345
					0 1	VBC6-30-01-P-05	GJL1213909R0015	5	0.345

### VBC7 mini reversing contactors

5.5	12	5	600 V / 16 A	12	1 0	VBC7-30-10-P-07	GJL1313909R0107	5	0.345
					0 1	VBC7-30-01-P-07	GJL1313909R0017	5	0.345
				24	1 0	VBC7-30-10-P-01	GJL1313909R0101	5	0.345
					0 1	VBC7-30-01-P-01	GJL1313909R0011	5	0.345
				48	1 0	VBC7-30-10-P-16	GJL1313909R1106	5	0.345
					0 1	VBC7-30-01-P-16	GJL1313909R1016	5	0.345
				60	1 0	VBC7-30-10-P-03	GJL1313909R0103	5	0.345
					0 1	VBC7-30-01-P-03	GJL1313909R0013	5	0.345
				110 ... 125	1 0	VBC7-30-10-P-04	GJL1313909R0104	5	0.345
					0 1	VBC7-30-01-P-04	GJL1313909R0014	5	0.345
				220 ... 240	1 0	VBC7-30-10-P-05	GJL1313909R0105	5	0.345
					0 1	VBC7-30-01-P-05	GJL1313909R0015	5	0.345

Other types on request

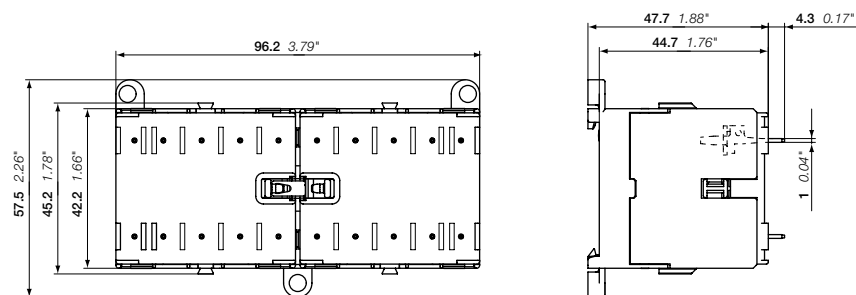

VBC6, VBC7

Main dimensions mm, inches

2CDC102025C0201

# VB6A, VB7A 3-pole mini reversing contactors – with soldering pins

4 to 5.5 kW

AC operated – with safety blocking function



VB7-30-01-P

2CDC11013F0010

VB6A..P, VB7A..P 3-pole compact design reversing contactors are space optimized control products mainly used for switching resistive or motor loads up to 690 V AC.

These reversing contactors are designed with:

- built-in mechanical interlock and safety blocking function. The safety blocking function is triggered if the voltage is applied to the coil of the contactor to be switched on before the contactor to be switched off has dropped out. The contactor coils are designed for continuous operation when the contactor is de-energised i.e. the coil is not damaged if the mechanical interlock prevents switch-on of the contactor with the coil voltage applied.
- control circuit: AC operated, low coil consumption (3.5 VA at pull-in and at holding)
- hum-free coil
- no auxiliary contact block permitted for mounting
- designed for soldering on PCB boards

IEC	UL/CSA		Rated control circuit voltage UC		Auxiliary contacts fitted	Type	Order code	Pkg qty	Weight (1 pce)
	Rated operational power	3-phase motor rating	General use rating	50 Hz					
400 V AC-3 kW	AC-1 A	480 V hp	VAC	VAC					kg

### VB6A mini reversing contactors with safety blocking function

IEC	UL/CSA	Rated control circuit voltage UC	Auxiliary contacts fitted	Type	Order code	Pkg qty	Weight (1 pce)			
4	12	3	300 V / 12 A	24	24	1 0	VB6A-30-10-P-01	GJL1211919R0101	5	0.345
						0 1	VB6A-30-01-P-01	GJL1211919R0011	5	0.345
				42	42	1 0	VB6A-30-10-P-02	GJL1211919R0102	5	0.345
						0 1	VB6A-30-01-P-02	GJL1211919R0012	5	0.345
				48	48	1 0	VB6A-30-10-P-03	GJL1211919R0103	5	0.345
						0 1	VB6A-30-01-P-03	GJL1211919R0013	5	0.345
				110 ... 127	110 ... 127	1 0	VB6A-30-10-P-84	GJL1211919R8104	5	0.345
						0 1	VB6A-30-01-P-84	GJL1211919R8014	5	0.345
				220 ... 240	220 ... 240	1 0	VB6A-30-10-P-80	GJL1211919R8100	5	0.345
						0 1	VB6A-30-01-P-80	GJL1211919R8010	5	0.345
				380 ... 415	380 ... 415	1 0	VB6A-30-10-P-85	GJL1211919R8105	5	0.345
						0 1	VB6A-30-01-P-85	GJL1211919R8015	5	0.345

### VB7A mini reversing contactors with safety blocking function

IEC	UL/CSA	Rated control circuit voltage UC	Auxiliary contacts fitted	Type	Order code	Pkg qty	Weight (1 pce)			
5.5	12	5	600 V / 16 A	24	24	1 0	VB7A-30-10-P-01	GJL1311919R0101	5	0.345
						0 1	VB7A-30-01-P-01	GJL1311919R0011	5	0.345
				42	42	1 0	VB7A-30-10-P-02	GJL1311919R0102	5	0.345
						0 1	VB7A-30-01-P-02	GJL1311919R0012	5	0.345
				48	48	1 0	VB7A-30-10-P-03	GJL1311919R0103	5	0.345
						0 1	VB7A-30-01-P-03	GJL1311919R0013	5	0.345
				110 ... 127	110 ... 127	1 0	VB7A-30-10-P-84	GJL1311919R8104	5	0.345
						0 1	VB7A-30-01-P-84	GJL1311919R8014	5	0.345
				220 ... 240	220 ... 240	1 0	VB7A-30-10-P-80	GJL1311919R8100	5	0.345
						0 1	VB7A-30-01-P-80	GJL1311919R8010	5	0.345
				380 ... 415	380 ... 415	1 0	VB7A-30-10-P-85	GJL1311919R8105	5	0.345
						0 1	VB7A-30-01-P-85	GJL1311919R8015	5	0.345

Other types on request

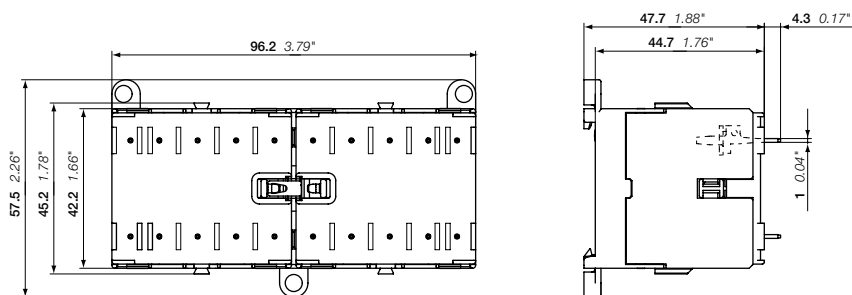

VB6A, VB7A

Main dimensions mm, inches

2CDC102027C0201

# VBC7A 3-pole mini reversing contactors – with soldering pins

4 to 5.5 kW

DC operated – with safety blocking function



VBC7A-30-10-P

2CDC11009F0011

VBC7A..P 3-pole compact design reversing contactors are space optimized control products mainly used for switching resistive or motor loads up to 690 V AC.

These reversing contactors are designed with:

- built-in mechanical interlock and safety blocking function. The safety blocking function is triggered if the voltage is applied to the coil of the contactor to be switched on before the contactor to be switched off has dropped out. The contactor coils are designed for continuous operation when the contactor is de-energised i.e. the coil is not damaged if the mechanical interlock prevents switch-on of the contactor with the coil voltage applied.
- control circuit: AC operated, low coil consumption (3.5 W at pull-in and at holding)
- hum-free coil
- no auxiliary contact block permitted for mounting
- designed for soldering on PCB boards

IEC	UL/CSA		Rated control circuit voltage UC	Auxiliary contacts fitted	Type	Order code	Pkg qty	Weight (1 pce)
Rated operational power 400 V AC-3 kW	3-phase motor rating 480 V AC-1 A	General use rating hp	V DC					kg

### VBC7A mini reversing contactors with safety blocking function

Rated operational power kW	3-phase motor rating hp	General use rating	Rated control circuit voltage UC	Auxiliary contacts fitted	Type	Order code	Pkg qty	Weight (1 pce)	
5.5	12	5	600 V / 16 A	12	1 0	VBC7A-30-10-P-07	GJL1313919R0107	5	0.345
					0 1	VBC7A-30-01-P-07	GJL1313919R0017	5	0.345
				24	1 0	VBC7A-30-10-P-01	GJL1313919R0101	5	0.345
					0 1	VBC7A-30-01-P-01	GJL1313919R0011	5	0.345
				48	1 0	VBC7A-30-10-P-16	GJL1313919R1106	5	0.345
					0 1	VBC7A-30-01-P-16	GJL1313919R1016	5	0.345
				60	1 0	VBC7A-30-10-P-03	GJL1313919R0103	5	0.345
					0 1	VBC7A-30-01-P-03	GJL1313919R0013	5	0.345
				110 ... 125	1 0	VBC7A-30-10-P-04	GJL1313919R0104	5	0.345
					0 1	VBC7A-30-01-P-04	GJL1313919R0014	5	0.345
				220 ... 240	1 0	VBC7A-30-10-P-05	GJL1313919R0105	5	0.345
					0 1	VBC7A-30-01-P-05	GJL1313919R0015	5	0.345

Other types on request

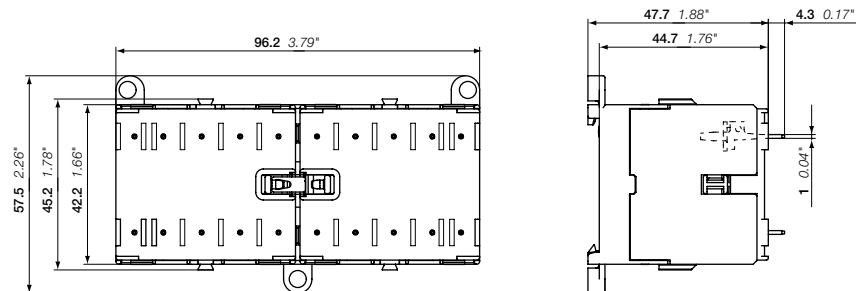

VBC7A

Main dimensions mm, inches

04

2CDC102028C0201



# BC6, BC7 3-pole interface mini contactors – with soldering pins

4 to 5.5 kW

DC operated



BC7-30-10-P

BC6..P, BC7..P 3-pole interface mini contactors are compact control products mainly used for switching resistive or motor loads up to 690 V AC.

These contactors are designed with:

- 3 main poles and one built-in auxiliary contact
- control circuit: DC operated, very low coil consumption. Suitable for direct control by PLC-outputs
- hum-free coil
- no auxiliary contact block permitted for mounting
- designed for soldering on PCB boards

IEC		UL/CSA		Rated control circuit voltage UC	Auxiliary contacts fitted	Type	Order code	Pkg qty	Weight (1 pce)
Rated operational power	current $\theta \leq 40^\circ\text{C}$	3-phase motor rating	General use rating						
400 V	AC-3	480 V		V DC					kg

### DC operation 24 V / 1.4 W

Rated power	Rated current	3-phase motor rating	General use rating	Rated control circuit voltage UC	Auxiliary contacts fitted	Type	Order code	Pkg qty	Weight (1 pce)
4	12	3	300 V / 12 A	24	1 0	BC6-30-10-P-1.4-81	GJL1213009R8101	10	0.170
					0 1	BC6-30-01-P-1.4-81	GJL1213009R8011	10	0.170
5.5	12	5	600 V / 16 A	24	1 0	BC7-30-10-P-1.4-81	GJL1313009R8101	10	0.170
					0 1	BC7-30-01-P-1.4-81	GJL1313009R8011	10	0.170

### DC operation 17 ... 32 V / 2.4 W, I<sub>th</sub> < 8 A

Rated power	Rated current	3-phase motor rating	General use rating	Rated control circuit voltage UC	Auxiliary contacts fitted	Type	Order code	Pkg qty	Weight (1 pce)
4	12	3	300 V / 12 A	17 ... 32	1 0	BC6-30-10-P-2.4-51	GJL1213009R5101	10	0.170
					0 1	BC6-30-01-P-2.4-51	GJL1213009R5011	10	0.170
5.5	12	5	600 V / 16 A	17 ... 32	1 0	BC7-30-10-P-2.4-51	GJL1313009R5101	10	0.170
					0 1	BC7-30-01-P-2.4-51	GJL1313009R5011	10	0.170

Other types on request

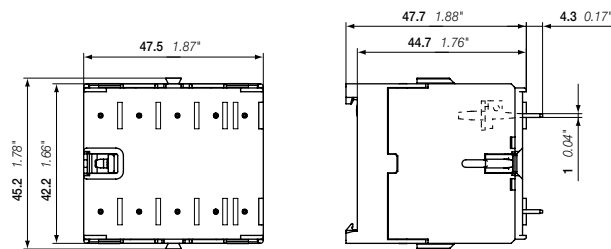

BC6, BC7

Main dimensions mm, inches

# K6 4-pole mini contactor relays – with soldering pins

AC operated



K6-22Z-P

2CDC11022P011

K6..P 4-pole mini-contactor relays are space optimized control products mainly used for control functions or for small loads up to 4 A.

These contactors are designed with:

- 4-poles with various contact combinations
- control circuit: AC operated, low coil consumption (3.5 VA at pull-in and at holding)
- hum-free coil
- add-on auxiliary contact block for side mounting
- designed for soldering on PCB boards

Rated control circuit voltage		Type	Order code	Pkg qty	Weight (1 pce)
UC					
50 Hz	60 Hz				
V AC	V AC				kg

### K6 4-pole mini contactor relays

UC	UC	Type	Order code	Pkg qty	Weight
24	24	K6-22Z-P-01	GJH1211009R0221	10	0.170
42	42	K6-22Z-P-02	GJH1211009R0222	10	0.170
48	48	K6-22Z-P-03	GJH1211009R0223	10	0.170
110 ...127	110 ...127	K6-22Z-P-84	GJH1211009R8224	10	0.170
220 ... 240	220 ... 240	K6-22Z-P-80	GJH1211009R8220	10	0.170
380 ... 415	380 ... 415	K6-22Z-P-85	GJH1211009R8225	10	0.170
24	24	K6-31Z-P-01	GJH1211009R0311	10	0.170
42	42	K6-31Z-P-02	GJH1211009R0312	10	0.170
48	48	K6-31Z-P-03	GJH1211009R0313	10	0.170
110 ...127	110 ...127	K6-31Z-P-84	GJH1211009R8314	10	0.170
220 ... 240	220 ... 240	K6-31Z-P-80	GJH1211009R8310	10	0.170
380 ... 415	380 ... 415	K6-31Z-P-85	GJH1211009R8315	10	0.170
24	24	K6-40E-P-01	GJH1211009R0401	10	0.170
42	42	K6-40E-P-02	GJH1211009R0402	10	0.170
48	48	K6-40E-P-03	GJH1211009R0403	10	0.170
110 ...127	110 ...127	K6-40E-P-84	GJH1211009R8404	10	0.170
220 ... 240	220 ... 240	K6-40E-P-80	GJH1211009R8400	10	0.170
380 ... 415	380 ... 415	K6-40E-P-85	GJH1211009R8405	10	0.170

Other types on request

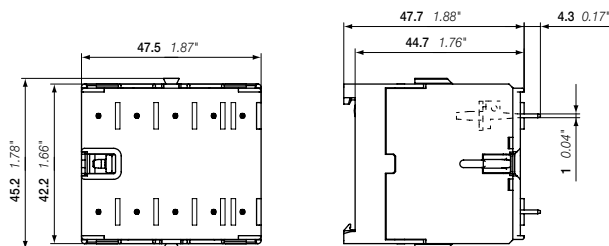

K6

Main dimensions mm, inches

04

2CDC102030C0201

# KC6 4-pole mini contactor relays – with soldering pins

DC operated



2CDC211025F0011

KC6-22Z-P



2CDC211023F0011

KC6-31Z-P

KC6..P 4-pole mini-contactor relays are space optimized control products mainly used for control functions or for small loads up to 4 A.

These contactors are designed with:

- 4-poles with various contact combinations
- control circuit: DC operated, low coil consumption (3.5 W at pull-in and at holding)
- hum-free coil
- add-on auxiliary contact block for side mounting
- designed for soldering on PCB boards

Rated control circuit voltage UC VDC	Type	Order code	Pkg qty	Weight (1 pce) kg
--	------	------------	------------	-------------------------

### K6 4-pole mini contactor relays

12	KC6-22Z-P-07	GJH1213009R0227	10	0.170
24	KC6-22Z-P-01	GJH1213009R0221	10	0.170
48	KC6-22Z-P-16	GJH1213009R1226	10	0.170
110 ... 125	KC6-22Z-P-04	GJH1213009R0224	10	0.170
220 ... 240	KC6-22Z-P-05	GJH1213009R0225	10	0.170
24	KC6-31Z-P-01	GJH1213009R0311	10	0.170
48	KC6-31Z-P-16	GJH1213009R1316	10	0.170
110 ... 125	KC6-31Z-P-04	GJH1213009R0314	10	0.170
220 ... 240	KC6-31Z-P-05	GJH1213009R0315	10	0.170
12	KC6-40E-P-07	GJH1213009R0407	10	0.170
24	KC6-40E-P-01	GJH1213009R0401	10	0.170
48	KC6-40E-P-16	GJH1213009R1406	10	0.170
110 ... 125	KC6-40E-P-04	GJH1213009R0404	10	0.170
220 ... 240	KC6-40E-P-05	GJH1213009R0405	10	0.170

Other types on request

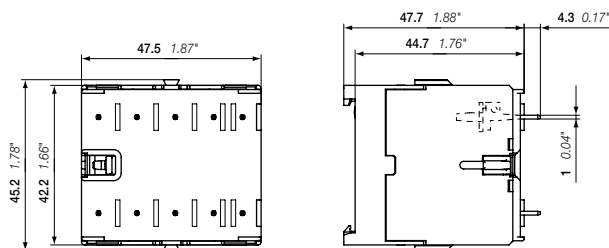

KC6  
Main dimensions mm, inches

# KC6 4-pole interface mini contactor relays – with solderings pins

DC operated



KC6-31Z-P-1.4

2CDC11023F0011

KC6..P 4-pole interface mini-contactor relays are space optimized control products mainly used for control functions or for small loads up to 4 A.

These contactors are designed with:

- 4-poles with various contact combinations
- control circuit: DC operated, very low coil consumption. Suitable for direct control by PLC-outputs
- hum-free coil
- no auxiliary contact block permitted for mounting
- designed for soldering on PCB boards

Rated control circuit voltage UC VDC	Type	Order code	Pkg qty	Weight (1 pce) kg
<b>DC operation 24 V / 1.4 W</b>				
24	KC6-31Z-P-1.4-81	GJH1213009R8311	10	0.170
24	KC6-40E-P-1.4-81	GJH1213009R8401	10	0.170
<b>DC operation 17 ... 32 V / 2.4 W</b>				
17 ... 32	KC6-31Z-P-2.4-51	GJH1213009R5311	10	0.170
17 ... 32	KC6-40E-P-2.4-51	GJH1213009R5401	10	0.170

Other types on request

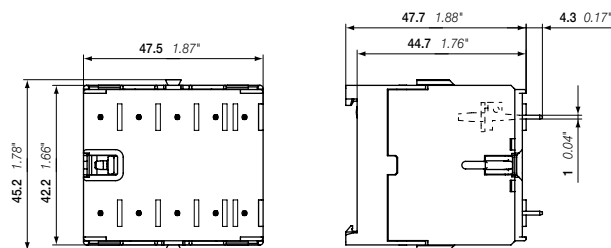

KC6  
Main dimensions mm, inches

04

2CDC102032C0201

# B6, B7 3-pole mini contactors – with flat pin connection

4 to 5.5 kW

AC operated



B6-30-10-F



B7-30-10-F

B6..F, B7..F 3-pole mini contactors are compact control products mainly used for switching resistive or motor loads up to 690 V AC.

These contactors are designed with:

- flat pin connection for plug-in wiring and shake proven connection
- 3 main poles and one built-in auxiliary contact
- control circuit: AC operated, low coil consumption (3.5 VA at pull-in and at holding)
- hum-free coil
- add-on auxiliary contact blocks for side mounting
- designed for rail or wall mounting

IEC		UL/CSA		Rated control circuit voltage UC		Auxiliary contacts fitted	Type	Order code	Pkg qty	Weight (1 pce)
Rated operational power	current $\theta \leq 40^\circ\text{C}$	3-phase motor rating	General use rating	50 Hz	60 Hz					
400 V AC-3	AC-1	480 V		V AC	V AC					kg
kW	A	hp								

### B6 mini contactors

Rated power (kW)	Rated current (A)	3-phase motor rating (hp)	General use rating	50 Hz (V AC)	60 Hz (V AC)	1 0	0 1	Type	Order code	Pkg qty	Weight (1 pce)
4	20	3	300 V / 12 A	24	24	1 0	0 1	B6-30-10-F-01	GJL1211003R0101	10	0.170
						1 0	0 1	B6-30-01-F-01	GJL1211003R0011	10	0.170
				42	42	1 0	0 1	B6-30-10-F-02	GJL1211003R0102	10	0.170
						1 0	0 1	B6-30-01-F-02	GJL1211003R0012	10	0.170
				48	48	1 0	0 1	B6-30-10-F-03	GJL1211003R0103	10	0.170
						1 0	0 1	B6-30-01-F-03	GJL1211003R0013	10	0.170
				110 ... 127	110 ... 127	1 0	0 1	B6-30-10-F-84	GJL1211003R8104	10	0.170
						1 0	0 1	B6-30-01-F-84	GJL1211003R8014	10	0.170
				220 ... 240	220 ... 240	1 0	0 1	B6-30-10-F-80	GJL1211003R8100	10	0.170
						1 0	0 1	B6-30-01-F-80	GJL1211003R8010	10	0.170
				380 ... 415	380 ... 415	1 0	0 1	B6-30-10-F-85	GJL1211003R8105	10	0.170
						1 0	0 1	B6-30-01-F-85	GJL1211003R8015	10	0.170

### B7 mini contactors

Rated power (kW)	Rated current (A)	3-phase motor rating (hp)	General use rating	50 Hz (V AC)	60 Hz (V AC)	1 0	0 1	Type	Order code	Pkg qty	Weight (1 pce)
5.5	20	5	600 V / 16 A	24	24	1 0	0 1	B7-30-10-F-01	GJL1311003R0101	10	0.170
						1 0	0 1	B7-30-01-F-01	GJL1311003R0011	10	0.170
				42	42	1 0	0 1	B7-30-10-F-02	GJL1311003R0102	10	0.170
						1 0	0 1	B7-30-01-F-02	GJL1311003R0012	10	0.170
				48	48	1 0	0 1	B7-30-10-F-03	GJL1311003R0103	10	0.170
						1 0	0 1	B7-30-01-F-03	GJL1311003R0013	10	0.170
				110 ... 127	110 ... 127	1 0	0 1	B7-30-10-F-84	GJL1311003R8104	10	0.170
						1 0	0 1	B7-30-01-F-84	GJL1311003R8014	10	0.170
				220 ... 240	220 ... 240	1 0	0 1	B7-30-10-F-80	GJL1311003R8100	10	0.170
						1 0	0 1	B7-30-01-F-80	GJL1311003R8010	10	0.170
				380 ... 415	380 ... 415	1 0	0 1	B7-30-10-F-85	GJL1311003R8105	10	0.170
						1 0	0 1	B7-30-01-F-85	GJL1311003R8015	10	0.170

Other types on request

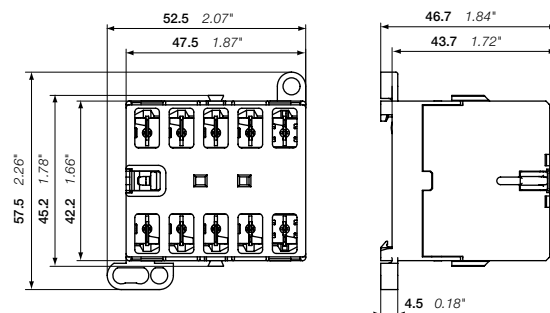

B6, B7

Main dimensions mm, inches

# BC6, BC7 3-pole mini contactors – with flat pin connection

4 to 5.5 kW

DC operated



BC6-30-10-F



BC7-30-10-F

BC6..F, BC7..F 3-pole mini contactors are compact control products mainly used for switching resistive or motor loads up to 690 V AC.

These contactors are designed with:

- flat pin connection for plug-in wiring and shake proven connection
- 3 main poles and one built-in auxiliary contact
- control circuit: DC operated, low coil consumption (3.5 W at pull-in and at holding)
- hum-free coil
- add-on auxiliary contact blocks for side mounting
- designed for rail or wall mounting

IEC		UL/CSA		Rated control circuit voltage UC	Auxiliary contacts fitted	Type	Order code	Pkg qty	Weight (1 pce)
Rated operational power	current θ ≤ 40 °C	3-phase motor rating 480 V	General use rating						
400 V AC-3	AC-1	hp		V DC					kg

### BC6 mini contactors

Rated power (kW)	Rated current (A)	3-phase motor rating (hp)	Rated voltage (V)	Rated current (A)	Coil voltage (V)	Coil current (A)	Order code	Pkg qty	Weight (kg)
4	20	3	300 V / 12 A	12	1 0	BC6-30-10-F-07	GJL1213003R0107	10	0.170
					0 1	BC6-30-01-F-07	GJL1213003R0017	10	0.170
				24	1 0	BC6-30-10-F-01	GJL1213003R0101	10	0.170
					0 1	BC6-30-01-F-01	GJL1213003R0011	10	0.170
				48	1 0	BC6-30-10-F-16	GJL1213003R1106	10	0.170
					0 1	BC6-30-01-F-16	GJL1213003R1016	10	0.170
				60	1 0	BC6-30-10-F-03	GJL1213003R0103	10	0.170
					0 1	BC6-30-01-F-03	GJL1213003R0013	10	0.170
				110 ... 125	1 0	BC6-30-10-F-04	GJL1213003R0104	10	0.170
					0 1	BC6-30-01-F-04	GJL1213003R0014	10	0.170
				220 ... 240	1 0	BC6-30-10-F-05	GJL1213003R0105	10	0.170
					0 1	BC6-30-01-F-05	GJL1213003R0015	10	0.170

### BC7 mini contactors

Rated power (kW)	Rated current (A)	3-phase motor rating (hp)	Rated voltage (V)	Rated current (A)	Coil voltage (V)	Coil current (A)	Order code	Pkg qty	Weight (kg)
5.5	20	5	600 V / 16 A	12	1 0	BC7-30-10-F-07	GJL1313003R0107	10	0.170
					0 1	BC7-30-01-F-07	GJL1313003R0017	10	0.170
				24	1 0	BC7-30-10-F-01	GJL1313003R0101	10	0.170
					0 1	BC7-30-01-F-01	GJL1313003R0011	10	0.170
				48	1 0	BC7-30-10-F-16	GJL1313003R1106	10	0.170
					0 1	BC7-30-01-F-16	GJL1313003R1016	10	0.170
				60	1 0	BC7-30-10-F-03	GJL1313003R0103	10	0.170
					0 1	BC7-30-01-F-03	GJL1313003R0013	10	0.170
				110 ... 125	1 0	BC7-30-10-F-04	GJL1313003R0104	10	0.170
					0 1	BC7-30-01-F-04	GJL1313003R0014	10	0.170
				220 ... 240	1 0	BC7-30-10-F-05	GJL1313003R0105	10	0.170
					0 1	BC7-30-01-F-05	GJL1313003R0015	10	0.170

Other types on request

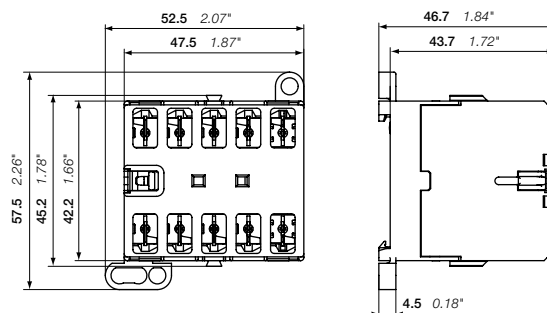

BC6, BC7

Main dimensions mm, inches

# VB7 3-pole mini reversing contactors – with flat pin connection

4 to 5.5 kW

AC operated



2CDC211005F0011

VB7-30-10-F

VB7..F 3-pole compact design reversing contactors are space optimized control products mainly used for switching resistive or motor loads up to 690 V AC.

These reversing contactors are designed with:

- built-in mechanical interlock. The coils must be mutually interlocked electrically and coils must be de-energised for 50 ms at least to prevent phase to phase short circuit on the arc.
- flat pin connection for plug-in wiring and shake proven connection
- control circuit: AC operated, low coil consumption (3.5 VA at pull-in and at holding)
- hum-free coil
- no auxiliary contact block permitted for mounting
- designed for rail and wall mounting

IEC		UL/CSA		Rated control circuit voltage UC		Auxiliary contacts fitted	Type	Order code	Pkg qty	Weight (1 pce)
Rated operational power	current	3-phase motor rating	General use rating	50 Hz	60 Hz					
400 V		480 V		V AC	V AC					kg
AC-3	AC-1									
kW	A	hp								

### VB7 mini reversing contactors

Rated power (kW)	Rated current (A)	3-phase motor rating (hp)	General use rating (V AC)	UC 50 Hz (V AC)	UC 60 Hz (V AC)	NO	NC	Type	Order code	Pkg qty	Weight (1 pce) (kg)
5.5	20	5	600 V / 16 A	24	24	1	0	VB7-30-10-F-01	GJL1311903R0101	5	0.345
						0	1	VB7-30-01-F-01	GJL1311903R0011	5	0.345
				42	42	1	0	VB7-30-10-F-02	GJL1311903R0102	5	0.345
						0	1	VB7-30-01-F-02	GJL1311903R0012	5	0.345
				48	48	1	0	VB7-30-10-F-03	GJL1311903R0103	5	0.345
						0	1	VB7-30-01-F-03	GJL1311903R0013	5	0.345
				110 ... 127	110 ... 127	1	0	VB7-30-10-F-84	GJL1311903R8104	5	0.345
						0	1	VB7-30-01-F-84	GJL1311903R8014	5	0.345
				220 ... 240	220 ... 240	1	0	VB7-30-10-F-80	GJL1311903R8100	5	0.345
						0	1	VB7-30-01-F-80	GJL1311903R8010	5	0.345
				380 ... 415	380 ... 415	1	0	VB7-30-10-F-85	GJL1311903R8105	5	0.345
						0	1	VB7-30-01-F-85	GJL1311903R8015	5	0.345

Other types on request

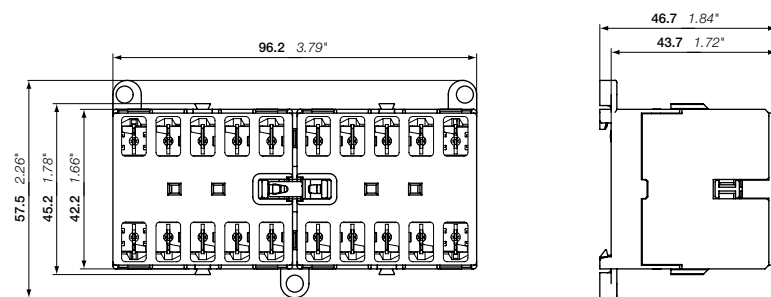

VB7

Main dimensions mm, inches

2CDC10035C0201

# VBC7 3-pole mini reversing contactors – with flat pin connection

4 to 5.5 kW

DC operated

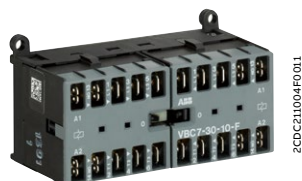

VBC7-30-10-F

VBC7..F 3-pole compact design reversing contactors are space optimized control products mainly used for switching resistive or motor loads up to 690 V AC.

These reversing contactors are designed with:

- built-in mechanical interlock. The coils must be mutually interlocked electrically and coils must be de-energised for 50 ms at least to prevent phase to phase short circuit on the arc
- flat pin connection for plug-in wiring and shake proven connection
- control circuit: DC operated, low coil consumption (3.5 W at pull-in and at holding)
- hum-free coil
- no auxiliary contact block permitted for mounting
- designed for rail and wall mounting

IEC	UL/CSA		Rated control circuit voltage UC	Auxiliary contacts fitted	Type	Order code	Pkg qty	Weight (1 pce)
Rated operational power	3-phase motor rating	General use rating						
400 V AC-3 kW	AC-1 A	480 V hp	V DC					kg

### VBC7 mini reversing contactors

Rated power (kW)	Rated current (A)	3-phase motor rating (hp)	Rated control circuit voltage (V DC)	Rated control circuit current (A)	Rated control circuit power (W)	Type	Order code	Pkg qty	Weight (1 pce)	
5.5	20	5	600 V / 16 A	12	12	1 0	VBC7-30-10-F-07	GJL1313903R0107	5	0.345
						0 1	VBC7-30-01-F-07	GJL1313903R0017	5	0.345
				24	24	1 0	VBC7-30-10-F-01	GJL1313903R0101	5	0.345
						0 1	VBC7-30-01-F-01	GJL1313903R0011	5	0.345
				48	48	1 0	VBC7-30-10-F-16	GJL1313903R1106	5	0.345
						0 1	VBC7-30-01-F-16	GJL1313903R1016	5	0.345
				60	60	1 0	VBC7-30-10-F-03	GJL1313903R0103	5	0.345
						0 1	VBC7-30-01-F-03	GJL1313903R0013	5	0.345
				110 ... 125	110 ... 125	1 0	VBC7-30-10-F-04	GJL1313903R0104	5	0.345
						0 1	VBC7-30-01-F-04	GJL1313903R0014	5	0.345
				220 ... 240	220 ... 240	1 0	VBC7-30-10-F-05	GJL1313903R0105	5	0.345
						0 1	VBC7-30-01-F-05	GJL1313903R0015	5	0.345

Other types on request

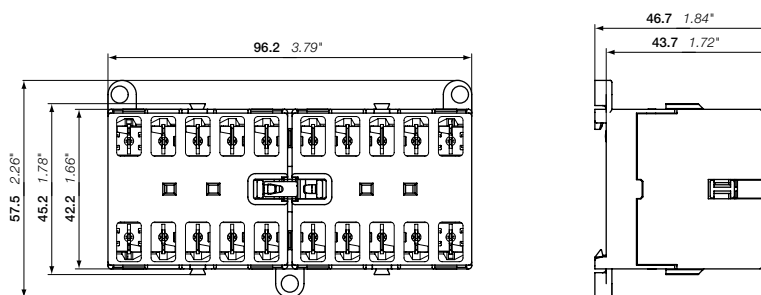

VBC7

Main dimensions mm, inches



# VB7A 3-pole mini reversing contactors – with flat pin connection

4 to 5.5 kW

AC operated – with safety blocking function



VB7A-30-10-F

2CDC21009F0011

VB7A..F 3-pole compact design reversing contactors are space optimized control products mainly used for switching resistive or motor loads up to 690 V AC.

These reversing contactors are designed with:

- built-in mechanical interlock and safety blocking function. The safety blocking function is triggered if the voltage is applied to the coil of the contactor to be switched on before the contactor to be switched off has dropped out. The contactor coils are designed for continuous operation when the contactor is de-energised i.e. the coil is not damaged if the mechanical interlock prevents switch-on of the contactor with the coil voltage applied.
- flat pin connection for plug-in wiring and shake proven connection
- control circuit: AC operated, low coil consumption (3.5 VA at pull-in and at holding)
- hum-free coil
- no auxiliary contact block permitted for mounting
- designed for rail and wall mounting

IEC		UL/CSA		Rated control circuit voltage UC		Auxiliary contacts fitted	Type	Order code	Pkg qty	Weight (1 pce)
Rated operational power	operational current $\theta \leq 40^\circ\text{C}$	3-phase motor rating	General use rating	50 Hz	60 Hz					
400 V	AC-3	480 V		V AC	V AC				pce	kg
kW	A	hp								

### VB7A mini reversing contactors with safety blocking function

Rated operational power (kW)	operational current (A)	3-phase motor rating (hp)	General use rating (V)	50 Hz (V AC)	60 Hz (V AC)	Number of contacts	Type	Order code	Pkg qty	Weight (1 pce) (kg)
5.5	20	5	600 V / 16 A	24	24	1 0	VB7A-30-10-F-01	GJL1311913R0101	5	0.345
						0 1	VB7A-30-01-F-01	GJL1311913R0011	5	0.345
				42	42	1 0	VB7A-30-10-F-02	GJL1311913R0102	5	0.345
						0 1	VB7A-30-01-F-02	GJL1311913R0012	5	0.345
				48	48	1 0	VB7A-30-10-F-03	GJL1311913R0103	5	0.345
						0 1	VB7A-30-01-F-03	GJL1311913R0013	5	0.345
				110 ... 127	110 ... 127	1 0	VB7A-30-10-F-84	GJL1311913R8104	5	0.345
						0 1	VB7A-30-01-F-84	GJL1311913R8014	5	0.345
				220 ... 240	220 ... 240	1 0	VB7A-30-10-F-80	GJL1311913R8100	5	0.345
						0 1	VB7A-30-01-F-80	GJL1311913R8010	5	0.345
				380 ... 415	380 ... 415	1 0	VB7A-30-10-F-85	GJL1311913R8105	5	0.345
						0 1	VB7A-30-01-F-85	GJL1311913R8015	5	0.345

Other types on request

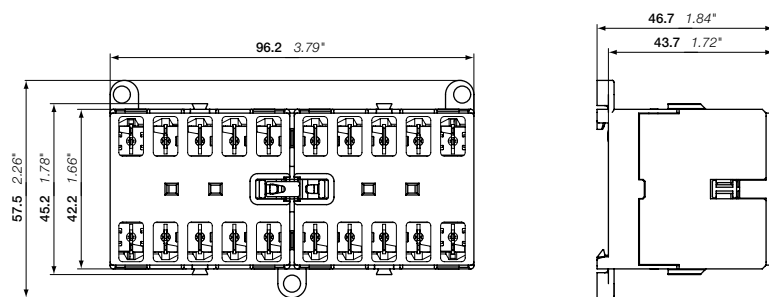

VB7A

Main dimensions mm, inches

2CDC102037C0201

# VBC7A 3-pole mini reversing contactors – with flat pin connection

4 to 5.5 kW

DC operated – with safety blocking function



VBC7A-30-10-F

2CDC21100P0011

VBC7A..F 3-pole compact design reversing contactors are space optimized control products mainly used for switching resistive or motor loads up to 690 V AC.

These reversing contactors are designed with:

- built-in mechanical interlock and safety blocking function. The safety blocking function is triggered if the voltage is applied to the coil of the contactor to be switched on before the contactor to be switched off has dropped out. The contactor coils are designed for continuous operation when the contactor is de-energised i.e. the coil is not damaged if the mechanical interlock prevents switch-on of the contactor with the coil voltage applied.
- flat pin connection for plug-in wiring and shake proven connection
- control circuit: DC operated, low coil consumption (3.5 W at pull-in and at holding)
- hum-free coil
- no auxiliary contact block permitted for mounting
- designed for rail and wall mounting

IEC		UL/CSA		Rated control circuit voltage UC	Auxiliary contacts fitted	Type	Order code	Pkg qty	Weight (1 pce)
Rated operational power	operational current $\theta \leq 40^\circ\text{C}$	3-phase motor rating	General use rating						
400 V	AC-3	AC-1	480 V	V DC					kg

## VBC7A mini reversing contactors with safety blocking function

Rated power (kW)	Rated current (A)	3-phase motor rating (hp)	Rated voltage (V)	Rated current (A)	Control circuit (V DC)	Type	Order code	Pkg qty	Weight (1 pce)	
5.5	20	5	600 V / 16 A	12	12	1 0	VBC7A-30-10-F-07	GJL1313913R0107	5	0.345
						0 1	VBC7A-30-01-F-07	GJL1313913R0017	5	0.345
				24	24	1 0	VBC7A-30-10-F-01	GJL1313913R0101	5	0.345
						0 1	VBC7A-30-01-F-01	GJL1313913R0011	5	0.345
				48	48	1 0	VBC7A-30-10-F-16	GJL1313913R1106	5	0.345
						0 1	VBC7A-30-01-F-16	GJL1313913R1016	5	0.345
				60	60	1 0	VBC7A-30-10-F-03	GJL1313913R0103	5	0.345
						0 1	VBC7A-30-01-F-03	GJL1313913R0013	5	0.345
				110 ... 125	110 ... 125	1 0	VBC7A-30-10-F-04	GJL1313913R0104	5	0.345
						0 1	VBC7A-30-01-F-04	GJL1313913R0014	5	0.345
				220 ... 240	220 ... 240	1 0	VBC7A-30-10-F-05	GJL1313913R0105	5	0.345
						0 1	VBC7A-30-01-F-05	GJL1313913R0015	5	0.345

Other types on request

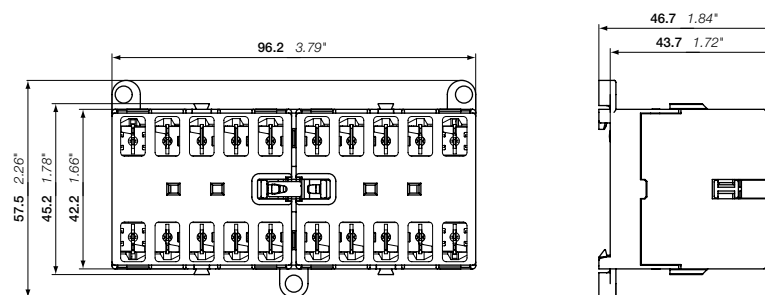

VBC7A

Main dimensions mm, inches

04

2CDC102039C0201

# BC6, BC7 3-pole interface mini contactors – with flat pin connection

4 to 5.5 kW

DC operated



BC6-30-10-F



BC7-30-10-F

BC6..F, BC7..F 3-pole interface mini contactors are compact control products mainly used for switching resistive or motor loads up to 690 V AC.

These contactors are designed with:

- flat pin connection for plug-in wiring and shake proven connection
- 3 main poles and one built-in auxiliary contact
- control circuit: DC operated, very low coil consumption. Suitable for direct control by PLC-outputs
- hum-free coil
- no auxiliary contact block permitted for mounting
- designed for rail or wall mounting

IEC		UL/CSA		Rated control circuit voltage UC	Auxiliary contacts fitted	Type	Order code	Pkg qty	Weight (1 pce)
Rated operational power	current $\theta \leq 40^\circ\text{C}$	3-phase motor rating	General use rating						
400 V	AC-3	480 V		V DC					kg

### DC operation 24 V / 1.4 W

Power (kW)	Current (A)	3-phase motor rating (hp)	General use rating (V/A)	Rated control circuit voltage (V DC)	Auxiliary contacts (1/1)	Type	Order code	Pkg qty	Weight (1 pce)
4	20	3	300 V / 12 A	24	1 0	BC6-30-10-F-1.4-81	GJL1213003R8101	10	0.170
					0 1	BC6-30-01-F-1.4-81	GJL1213003R8011	10	0.170
5.5	20	5	600 V / 16 A	24	1 0	BC7-30-10-F-1.4-81	GJL1313003R8101	10	0.170
					0 1	BC7-30-01-F-1.4-81	GJL1313003R8011	10	0.170

### DC operation 17 ... 32 V / 2.4 W

Power (kW)	Current (A)	3-phase motor rating (hp)	General use rating (V/A)	Rated control circuit voltage (V DC)	Auxiliary contacts (1/1)	Type	Order code	Pkg qty	Weight (1 pce)
4	20	3	300 V / 12 A	17 ... 32	1 0	BC6-30-10-F-2.4-51	GJL1213003R5101	10	0.170
					0 1	BC6-30-01-F-2.4-51	GJL1213003R5011	10	0.170
5.5	20	5	600 V / 16 A	17 ... 32	1 0	BC7-30-10-F-2.4-51	GJL1313003R5101	10	0.170
					0 1	BC7-30-01-F-2.4-51	GJL1313003R5011	10	0.170

Other types on request

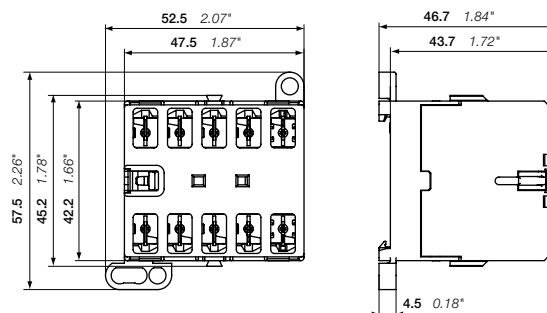

BC6, BC7

Main dimensions mm, inches

# K6 4-pole mini contactor relays – with flat pin connection

AC operated



K6-22Z-F

K6..F 4-pole mini-contactor relays are space optimized control products mainly used for control functions or for small loads up to 4 A.

These contactors are designed with:

- flat pin connection for plug-in wiring and shake proven connection
- 4-poles with various contact combinations
- control circuit: AC operated, low coil consumption (3.5 VA at pull-in and at holding)
- hum-free coil
- add-on auxiliary contact blocks for side mounting
- designed for rail and wall mounting

Rated control circuit voltage		Type	Order code	Pkg qty	Weight (1 pce)
UC					
50 Hz	60 Hz				
VAC	VAC				kg

### K6 4-pole mini contactor relays

24	24	K6-22Z-F-01	GJH1211003R0221	10	0.170
42	42	K6-22Z-F-02	GJH1211003R0222	10	0.170
48	48	K6-22Z-F-03	GJH1211003R0223	10	0.170
110 ...127	110 ...127	K6-22Z-F-84	GJH1211003R8224	10	0.170
220 ... 240	220 ... 240	K6-22Z-F-80	GJH1211003R8220	10	0.170
380 ... 415	380 ... 415	K6-22Z-F-85	GJH1211003R8225	10	0.170
24	24	K6-31Z-F-01	GJH1211003R0311	10	0.170
42	42	K6-31Z-F-02	GJH1211003R0312	10	0.170
48	48	K6-31Z-F-03	GJH1211003R0313	10	0.170
110 ...127	110 ...127	K6-31Z-F-84	GJH1211003R8314	10	0.170
220 ... 240	220 ... 240	K6-31Z-F-80	GJH1211003R8310	10	0.170
380 ... 415	380 ... 415	K6-31Z-F-85	GJH1211003R8315	10	0.170
24	24	K6-40E-F-01	GJH1211003R0401	10	0.170
42	42	K6-40E-F-02	GJH1211003R0402	10	0.170
48	48	K6-40E-F-03	GJH1211003R0403	10	0.170
110 ...127	110 ...127	K6-40E-F-84	GJH1211003R8404	10	0.170
220 ... 240	220 ... 240	K6-40E-F-80	GJH1211003R8400	10	0.170
380 ... 415	380 ... 415	K6-40E-F-85	GJH1211003R8405	10	0.170

Other types on request

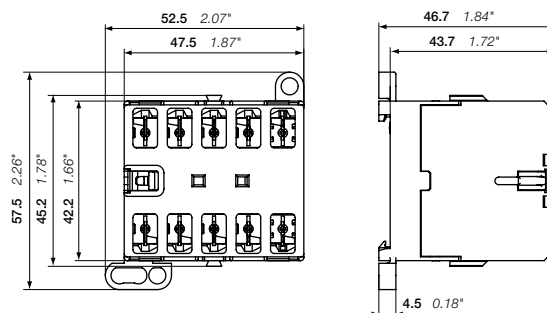

K6

Main dimensions mm, inches

# KC6 4-pole mini contactor relays – with flat pin connection

DC operated



KC6-22Z-F-01

K6..F 4-pole mini-contactor relays are space optimized control products mainly used for control functions or for small loads up to 4 A.

These contactors are designed with:

- flat pin connection for plug-in wiring and shake proven connection
- 4-poles with various contact combinations
- control circuit: AC operated, low coil consumption (3.5 VA at pull-in and at holding)
- hum-free coil
- add-on auxiliary contact blocks for side mounting
- designed for rail and wall mounting

Rated control circuit voltage	Type	Order code	Pkg qty	Weight (1 pce) kg
UC				
VDC				

### K6 4-pole mini contactor relays

Rated current	Type	Order code	Pkg qty	Weight (1 pce) kg
12	KC6-22Z-F-07	GJH1213003R0227	10	0.170
24	KC6-22Z-F-01	GJH1213003R0221	10	0.170
48	KC6-22Z-F-16	GJH1213003R1226	10	0.170
110 ... 125	KC6-22Z-F-04	GJH1213003R0224	10	0.170
220 ... 240	KC6-22Z-F-05	GJH1213003R0225	10	0.170
12	KC6-31Z-F-07	GJH1213003R0317	10	0.170
24	KC6-31Z-F-01	GJH1213003R0311	10	0.170
48	KC6-31Z-F-16	GJH1213003R1316	10	0.170
110 ... 125	KC6-31Z-F-04	GJH1213003R0314	10	0.170
220 ... 240	KC6-31Z-F-05	GJH1213003R0315	10	0.170
24	KC6-40E-F-01	GJH1213003R0401	10	0.170
48	KC6-40E-F-16	GJH1213003R1406	10	0.170
110 ... 125	KC6-40E-F-04	GJH1213003R0404	10	0.170
220 ... 240	KC6-40E-F-05	GJH1213003R0405	10	0.170

Other types on request

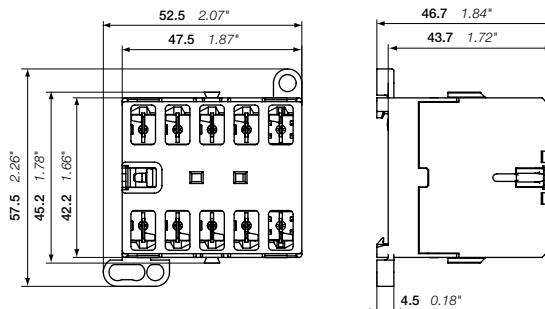

KC6  
Main dimensions mm, inches

2CDC102041C0201

# KC6 4-pole interface mini contactor relays – with flat pin connection

DC operated



KC6-31Z-F-05

KC6..F 4-pole interface mini-contactor relays are space optimized control products mainly used for control functions or for small loads up to 4 A.

These contactors are designed with:

- flat pin connection for plug-in wiring and shake proven connection
- 4-poles with various contact combinations
- control circuit: DC operated, very low coil consumption. Suitable for direct control by PLC-outputs
- hum-free coil
- no auxiliary contact block permitted for mounting
- designed for rail and wall mounting

Rated control circuit voltage UC VDC	Type	Order code	Pkg qty	Weight (1 pce) kg
<b>DC operation 24 V / 1.4 W</b>				
24	KC6-31Z-F-1.4-81	GJH1213003R8311	10	0.170
24	KC6-40E-F-1.4-81	GJH1213003R8401	10	0.170
<b>DC operation 17 ... 32 V / 2.4 W</b>				
17 ... 32	KC6-31Z-F-51	GJH1213003R5311	10	0.170
17 ... 32	KC6-40E-F-51	GJH1213003R5401	10	0.170

Other types on request

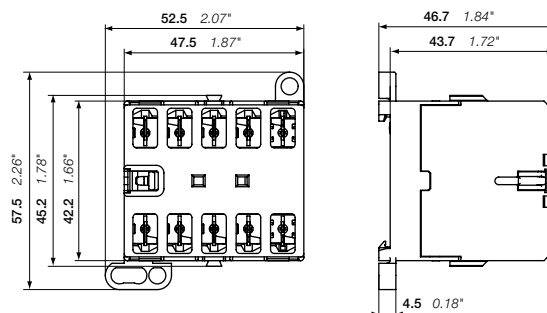

KC6

Main dimensions mm, inches

04

2CDC102045C0201

## B6, B7, BC6, BC7 3- and 4-pole mini contactors

### VB6, VB7, VBC6, VBC7 3- and 4-pole mini reversing contactors

#### Technical data

##### Main pole – Utilization characteristics according to IEC

Contactor types	AC operated	<b>B6, VB6, VB6A</b>	<b>B7, VB7, VB7A</b>
	DC operated	<b>BC6, VBC6, VBC6A</b>	<b>BC7, VBC7, VBC7A</b>
Standards		IEC/EN 60947-1, IEC/EN 60947-4-1	
Rated operational voltage U <sub>e</sub> max		690 V AC	
Rated frequency (without derating)		DC or 50 / 60 Hz	
Conventional free-air thermal current I <sub>th</sub> acc. to IEC 60947-4-1, open contactors, θ ≤ 40 °C, with conductor cross-sectional area		Screw terminal types: 20 A Flat pin types: 20 A Soldering pin types: 12 A	
AC-1 Utilization category for air temperature close to contactor θ ≤ 40 °C			
I <sub>e</sub> / Rated operational current AC-1	220-230-240 V	Screw terminal types: 20 A Flat pin types: 20 A Soldering pin types: 12 A	
U <sub>e</sub> max ≤ 690 V, 50/60 Hz	380-400 V	Screw terminal types: 20 A Flat pin types: 20 A Soldering pin types: 12 A	
	440 V	Screw terminal types: 20 A Flat pin types: 20 A Soldering pin types: 12 A	
	500 V	12 A	
	690 V	6 A	
AC-1 Utilization category for air temperature close to contactor θ ≤ 55 °C			
I <sub>e</sub> / Rated operational current AC-1	220-230-240 V	Screw terminal types: 16 A Flat pin types: 16 A Soldering pin types: 12 A	
U <sub>e</sub> max ≤ 690 V, 50/60 Hz	380-400 V	Screw terminal types: 16 A Flat pin types: 16 A Soldering pin types: 12 A	
	440 V	Screw terminal types: 16 A Flat pin types: 16 A Soldering pin types: 12 A	
	500 V	12 A	
	690 V	6 A	
AC-3 Utilization category for air temperature close to contactor θ ≤ 55 °C			
I <sub>e</sub> / Rated operational current AC-3	220 / 230 / 240 V	8.9 / 8.5 / 8.1 A	11.8 / 11.3 / 10.8 A
3-phase motors	380 / 400 V	8.9 / 8.5 A	12.1 / 11.5 A
	440 V	7.4 A	10.1 A
	500 V	6.8 A	9.2 A
	690 V	3.8 A	3.8 A
Rated operational power AC-3	220-230-240 V	2.2 kW	3 kW
	380-400 V	4 kW	5.5 kW
	440 V	4 kW	5.5 kW
	500 V	4 kW	5.5 kW
	690 V	3 kW	3 kW
DC-1 Utilization category for air temperature close to contactor θ ≤ 55 °C			
I <sub>e</sub> / Rated operational current DC-1	110 V	-	4 A
	220 V	-	0.6 A
DC-3 Utilization category for air temperature close to contactor θ ≤ 55 °C			
I <sub>e</sub> / Rated operational current DC-3	110 V	-	1.5 A
	220 V	-	0.25 A
DC-5 Utilization category for air temperature close to contactor θ ≤ 55 °C			
I <sub>e</sub> / Rated operational current DC-5	110 V	-	0.4 A
	220 V	-	0.2 A
Rated making capacity AC-3		10 x I <sub>e</sub> AC-3 acc. to IEC 60947-4-1	
Rated breaking capacity AC-3		8 x I <sub>e</sub> AC-3 acc. to IEC 60947-4-1	
Short-circuit protection device for contactors without thermal O/L relay - motor protection excluded		Type 1: 25 A / Type 2: 25 A	
U <sub>e</sub> ≤ 500 V AC - fuse type gG		Type 1: 25 A / Type 2: 25 A	
Rated short-time withstand current I <sub>CW</sub> at 40 °C ambient temperature, in free air from a cold state	10 s	64 A	96 A
Minimum switching capacity		17 V ; 200 mA	
Maximum breaking capacity cos φ = 0.45	at 400 V	64 A	96 A
Maximum electrical switching frequency	AC-1	300 cycles/h	
	AC-3	600 cycles/h	
	DC-1, DC-3, DC-5	600 cycles/h	

# B6, B7, BC6, BC7 3- and 4-pole mini contactors VB6, VB7, VBC6, VBC7 3- and 4-pole mini reversing contactors

## Technical data

### Main pole – Utilization characteristics according to UL/NEMA/CSA

Contactor types	AC operated	<b>B6, VB6, VB6A</b>	<b>B7, VB7, VB7A</b>
	DC operated	<b>BC6, VBC6, VBC6A</b>	<b>BC7, VBC7, VBC7A</b>
Standards		UL 508, CSA C22.2 N°14	
Maximum operational voltage		600 V	
UL/CSA general use rating		12 A / 300 V	16 A / 600 V
UL/CSA maximum 1-phase motor rating			
Full load current	120 V AC	5.8 A	13.8 A
	240 V AC	4.9 A	10.0 A
Horse power rating	120 V AC	0.25 hp	0.75 hp
	240 V AC	0.5 hp	1.5 hp
UL/CSA maximum 3-phase motor rating			
Full load current (1)	200 / 208 V AC	4.8 / 4.6 A	7.8 / 10.6 A
	220-240 V AC	6.8 A	9.6 A
	440-480 V AC	4.8 A	7.6 A
	550-600 V AC	1.7 A	6.1 A
Horse power rating (1)	200 / 208 V AC	1 hp	2 / 3 hp
	220-240 V AC	2 hp	3 hp
	440-480 V AC	3 hp	5 hp
	550-600 V AC	1 hp	5 hp
Resistive Heating	300 V per pole	8 A	8 A
Incandescent Lamps	300 V per pole	6 A	6 A
Fluorescent Lamps	300 V per pole	8.4 A	8.4 A
Short-circuit protection device for contactors without thermal overload relay - motor protection excluded			
Fuse rating	600 V	40 A	
Fuse type, 600 V	600 V	Class J	
Maximum electrical switching frequency			
For resistive loads AC-1		300 cycles/h	
For motor loads AC-3		600 cycles/h	

(1) For the corresponding kW/A or hp/A values of 1500 r.p.m, 50 Hz or 1800 r.p.m, 60 Hz, 3-phase motors, see "Motor rated operational powers and currents".

### General technical data

Contactor types	AC operated	<b>B6, VB6, VB6A</b>	<b>B7, VB7, VB7A</b>
	DC operated	<b>BC6, VBC6, VBC6A</b>	<b>BC7, VBC7, VBC7A</b>
Rated insulation voltage Ui			
acc. to IEC 60947-4-1		690 V	
acc. to UL/CSA		600 V	
Rated impulse withstand voltage Uimp		6 kV	
Ambient air temperature, close to contactor			
Operation	Fitted with thermal overload relay	-25 ... +50 °C	
	Without thermal overload relay	-25 ... +55 °C	
Storage		-40 ... +80 °C	
Climatic withstand		Acc. to IEC 60947-1 Annex Q	
Maximum operating altitude (without derating)		2000 m	
Mechanical durability		10 <sup>7</sup> operating cycles	
Resistance to shock		Half-sine	
acc. IEC 60068-2-27 and EN 60068-2-27		15 g / 11 ms	
acc. to IEC/EN 60947-1 Annex. Q		Category E	
Resistance to vibrations		Sinusoidal	
acc. IEC 60068-2-27 and EN 60068-2-27		5 g / 3 ... 150 Hz	
acc. to IEC/EN 60947-1 Annex. Q		Category E	



# B6, B7, BC6, BC7 3- and 4-pole mini contactors

## VB6, VB7, VBC6, VBC7 3- and 4-pole mini reversing contactors

### Technical data

#### Magnet system characteristics for B6, B7 contactors

Contactor types	AC operated	<b>B6, VB6</b>	<b>B7, VB7</b>
Coil operating limits acc. to IEC 60947-4-1	AC supply	0.85 ... 1.1 x U <sub>c</sub>	
AC control voltage		See ordering tables	
Rated control circuit voltage UC		See ordering tables	
Coil consumption	Average pull-in value	3.5 VA / 3.5 W	
	Average holding value	3.5 VA / 3.5 W	
Drop-out voltage		0.20 ... 0.75 % of U <sub>c</sub>	

#### Magnet system characteristics for BC6, BC7 contactors

Contactor types	DC operated	<b>BC6, VBC6</b>	<b>BC7, VBC7</b>
Coil operating limits acc. to IEC 60947-4-1	DC supply	0.85 ... 1.1 x U <sub>c</sub>	
AC control voltage		See ordering tables	
Rated control circuit voltage UC		See ordering tables	
Coil consumption (1)	Average pull-in value	3.5 VA / 3.5 W	
	Average holding value	3.5 VA / 3.5 W	
Drop-out voltage in % of UC min		0.10 ... 0.75 x UC	

(1) Interface mini-contactors: see coil consumption on ordering details pages

#### Mounting characteristics and conditions for use

Contactor types	AC operated	<b>B6, VB6, VB6A</b>	<b>B7, VB7, VB7A</b>
	DC operated	<b>BC6, VBC6, VBC6A</b>	<b>BC7, VBC7, VBC7A</b>
Mounting positions			
Mounting distances	The contactors can be assembled side by side		
Fixing			
On rail acc. to IEC 60715, EN 60715	35 x 7.5 mm or 35 x 15 mm		
By screws (not supplied)	2 x M4 screws placed diagonally		

# B6, B7, BC6, BC7 3- and 4-pole mini contactors VB6, VB7, VBC6, VBC7 3- and 4-pole mini reversing contactors

## Technical data





### Built-in auxiliary contact according to IEC

Types		Built-in auxiliary contacts
Standards		IEC/EN 60947-1, IEC/EN 60947-4-1
Rated operational voltage U <sub>e</sub> max		690 V
Rated frequency (without derating)		DC or 50 / 60 Hz
Conventional free-air thermal current I <sub>th</sub> θ ≤ 40 °C		6 A
I <sub>e</sub> / Rated operational current AC-15 acc. to IEC 60947-5-1	24 V 50/60 Hz	4 A
	110-120 V 50/60 Hz	4 A
	220-230-240 V 50/60 Hz	4 A
	380-400 V 50/60 Hz	3 A
	440 V 50/60 Hz	3 A
I <sub>e</sub> / Rated operational current DC-13 acc. to IEC 60947-5-1	24 V DC	2.5 A
	110 V DC	0.7 A
	220 - 240 V DC	0.4 A
Short-circuit protection device		6 A, Type gG
Minimum switching capacity with failure rate acc. to IEC 60947-5-4		17 V / 5 mA
Maximum electrical switching frequency	AC-15	600 cycles/h
	DC-13	600 cycles/h

### Built-in auxiliary contact according to UL/CSA

Types		Built-in auxiliary contacts
Max. operational voltage		600 V AC
Pilot duty		A600
AC thermal rated current		5 A

### Connection characteristics

Contactor types	AC operated	B6, VB6, VB6A	B7, VB7, VB7A
	DC operated	BC6, VBC6, VBC6A	BC7, VBC7, VBC7A
Main terminals (1)	 <p>Screw terminals with cable clamp</p>		
Connection capacity			
Main conductors (poles)			
 Rigid: solid	1 or 2 x	1 ... 4 mm <sup>2</sup>	
 Flexible without ferrule	1 or 2 x	1 ... 2.5 mm <sup>2</sup>	
Connection capacity acc. to UL/CSA		1 or 2 x AWG 22 ... 10	
Stripping length		9 mm	
Tightening torques		0.8 ... 1.1 Nm / 7 lb.in	
Connection capacity – auxiliary conductors (built-in auxiliary terminals + coil terminals)			
 Rigid: solid	1 or 2 x	1 ... 4 mm <sup>2</sup>	
 Flexible without ferrule	1 or 2 x	1 ... 2.5 mm <sup>2</sup>	
Connection capacity acc. to UL/CSA		1 or 2 x AWG 22 ... 10	
Stripping length		9 mm	
Tightening torques			
Coil terminals		0.8 ... 1.1 Nm / 7 lb.in	
Built-in auxiliary terminals		0.8 ... 1.1 Nm / 7 lb.in	
Degree of protection acc. to IEC 60947-1 / EN 60947-1 and IEC 60529 / EN 60529			
Main terminals		IP20	
Coil terminals		IP20	
Built-in auxiliary terminals		IP20	
Screw terminals (Delivered in open position, screws of unused terminals must be tightened)			
All terminals		M3	
Screwdriver type		Flat Ø 5.5 mm / Pozidriv 1	

(1) Soldering pin connection acc. to DIN 40801: 0.8 x 1 mm / 0.8 x 2.54 mm  
Flat pin connection acc. to DIN 46248: 1 x 6.3 mm / 1 x 2.8 mm

## K6, KC6 4-pole mini contactor relays

### Technical data

#### Main pole – Utilization characteristics according to IEC

Contactor types	AC operated	<b>K6</b>
	DC operated	<b>KC6</b>
Standards	IEC/EN 60947-1, IEC/EN 60947-4-1, IEC/EN 60947-5-1	
Rated operational voltage U <sub>max</sub>	690 V	
Rated frequency (without derating)	DC or 50 / 60 Hz	
Conventional free-air thermal current I <sub>th</sub> θ ≤ 40 °C	6 A	
I <sub>e</sub> / Rated operational current AC-15 acc. to IEC 60947-5-1	24 V 50/60 Hz	4 A
	110-120 V 50/60 Hz	4 A
	220-230-240 V 50/60 Hz	4 A
	380-400 V 50/60 Hz	3 A
	440 V 50/60 Hz	3 A
	480-500 V 50/60 Hz	2 A
	I <sub>e</sub> / Rated operational current DC-13 acc. to IEC 60947-5-1	24 V DC
110 V DC		0.7 A
220-240 V DC		0.4 A
Short-circuit protection device for contactors U <sub>e</sub> ≤ 500 V AC, fuse type gG	6 A	
Minimum switching capacity	17 V / 5 mA	
Maximum electrical switching frequency	AC-15	600 cycles/h
	DC-13	600 cycles/h

#### Main pole – Utilization characteristics according to UL/NEMA/CSA

Contactor types	AC operated	<b>K6</b>
	DC operated	<b>KC6</b>
Standards	UL 508, CSA C22.2 No14	
Maximum operational voltage	600 V AC	
Pilot duty	A600	

## K6, KC6 4-pole mini contactor relays

### Technical data

#### General technical data

Contactor relay types	AC operated	<b>K6</b>
	DC operated	<b>KC6</b>
Rated insulation voltage Ui		690 V
acc. to IEC 60947-5-1		600 V
acc. to UL/CSA		6 kV
Rated impulse withstand voltage Uimp		6 kV
Electromagnetic compatibility		
Ambient air temperature close to contactor relay	Operation in free air	-25 ... +55 °C
	Storage	-40 ... +80 °C
Climatic withstand		Acc. to IEC 60068-2-30
Maximum operating altitude (without derating)		2000 m
Mechanical durability		10 <sup>7</sup> operating cycles
Resistance to shock		Half-sine
acc. IEC 60068-2-27 and EN 60068-2-27		15 g / 11ms
acc. to IEC/EN 60947-1 Annex. Q		Category E
Resistance to vibrations		Sinusoidal
acc. IEC 60068-2-27 and EN 60068-2-27		5 g / 3 ... 150 Hz
acc. to IEC/EN 60947-1 Annex. Q		Category E

#### Magnet system characteristics for K6 contactor relays

Contactor relay types	AC operated	<b>K6</b>
Coil operating limits acc. to IEC 60947-4-1	AC supply	<b>0.85 ... 1.1 x UC</b>
AC control voltage		
Coil consumption	Average pull-in value	3.5 VA / 3.5 W
	Average holding value	3.5 VA / 3.5 W
Drop-out voltage in % of UC min.		Approx. 20 ... 75%

#### Magnet system characteristics for KC6 contactor relays

Contactor relay types	DC operated	<b>KC6</b>
Coil operating limits acc. to IEC 60947-5-1	DC supply	0.85 ... 1.1 x UC
DC control voltage		
Coil consumption	Average pull-in value	3.5 VA / 3.5 W
	Average holding value	3.5 VA / 3.5 W
Drop-out voltage in % of UC min.		10 ... 75 %

## K6, KC6 4-pole mini contactor relays

### Technical data

#### Mounting characteristics and conditions for use

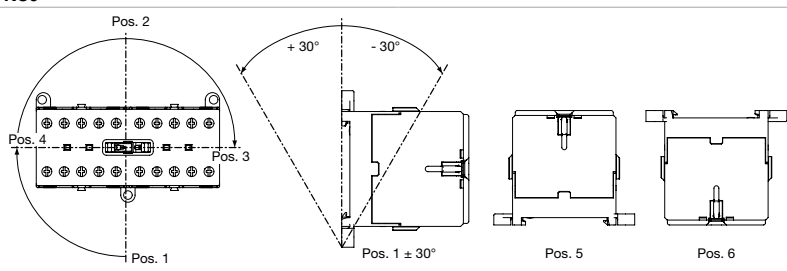
Contactor types	AC operated	<b>K6</b>
	DC operated	<b>KC6</b>
Mounting positions		
Mounting distances	The contactors can be assembled side by side.	
Fixing	<p>On rail acc. to IEC 60715, EN 60715</p> <p>By screws (not supplied)</p>	
	<p>35 x 7.5 mm or 35 x 15 mm</p> <p>2 x M4 screws placed diagonally</p>	

#### Connecting characteristics

Contactor relay types	AC operated	<b>K6</b>
	DC operated	<b>KC6</b>
Main terminals(1)	 <p>Screw terminals with cable clamp</p>	
Connection capacity	<p>Main conductors (poles)</p> <p>■ Rigid: solid</p> <p>▨ Flexible without ferrule</p>	
	1 or 2 x	1 ... 4 mm <sup>2</sup>
	1 or 2 x	1 ... 2.5 mm <sup>2</sup>
Connection capacity acc. to UL/CSA	1 or 2 x	AWG 22 ... 10
Stripping length	9 mm	
Tightening torques	0.8 ... 1.1 Nm / 7 lb.in	
Degree of protection acc. to IEC 60947-1 / EN 60947-1 and IEC 60529 / EN 60529	IP20	
All	(Delivered in open position, screws of unused terminals must be tightened)	
Screw terminals	M3	
All terminals	M3	
Screwdriver type	Flat Ø 5.5 / Pozidriv 1	

(1) Soldering pin connection acc. to DIN 40801: 0.8 x 1 mm / 0.8 x 2.54 mm  
 Flat pin connection acc. to DIN 46248: 1 x 6.3 mm / 1 x 2.8 mm

---

# Accessories

- 4/48 Accessories for B 3-pole and 4-pole mini contactors, VB 3-pole and 4-pole mini reversing**
- 4/50 Accessories for K 4-pole mini contactor relays**
- 4/52 Location of the connection terminals and terminal designation**
- 4/53 Dimension drawings**

# Accessories for mini contactors

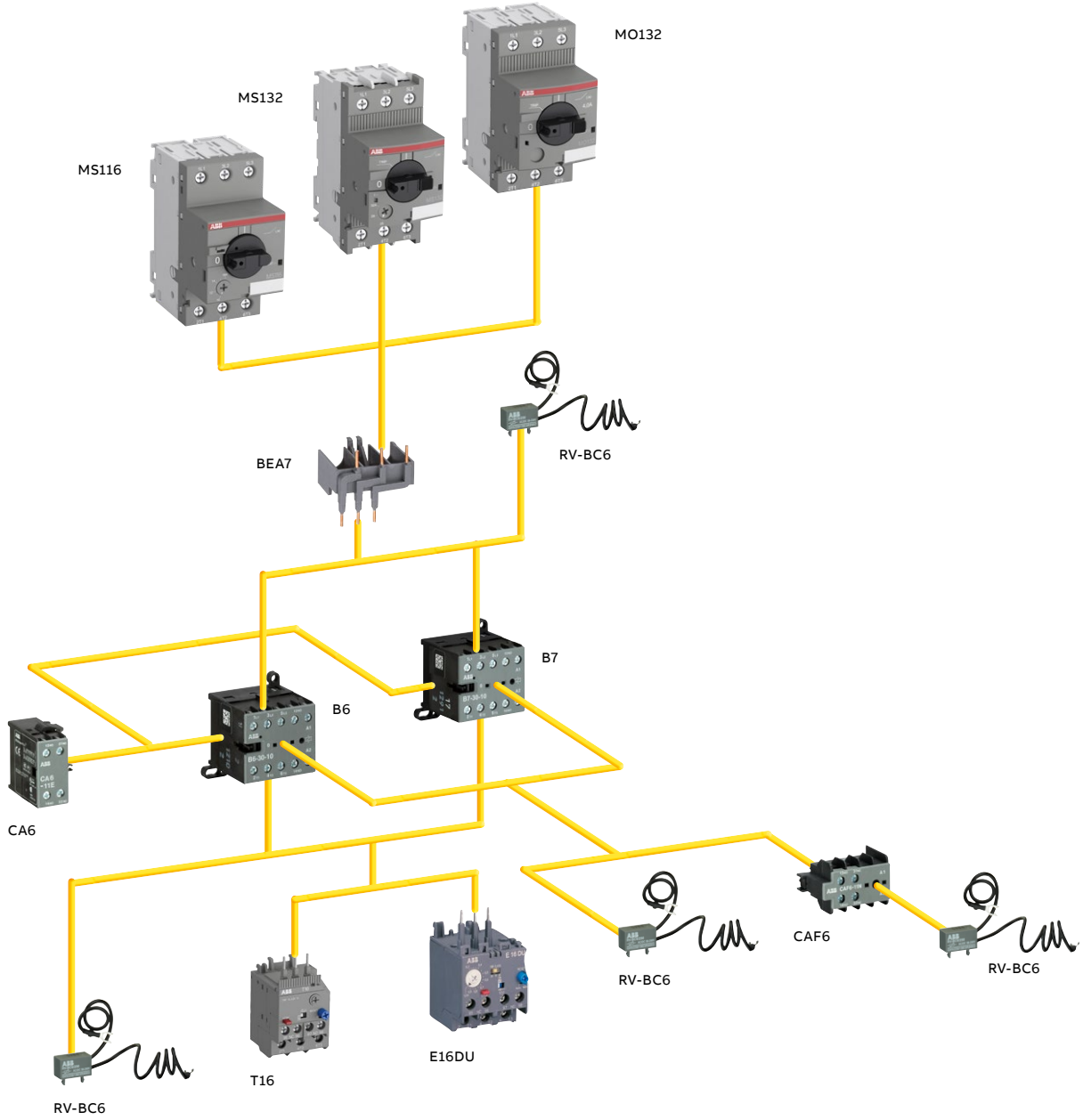

Note: The picture is valid for screw terminal contactors only.

# B6, B7, BC6, BC7 3- and 4-pole mini contactors VB6, VB7, VBC6, VBC7 3-pole mini reversing contactors

## Accessories



CAF6-11N

2CDC211012F0010



CA6-11E

2CDC211008F0010



CA6-11E-P

2CDC211018F0011



CA6-11E-F

2CDC211020F0011



CAF6-11N

2CDC211007F0010



BSM6-30

SST2792R



LT6-B

2CDC231012F0011

Suitable for	Auxiliary contacts	Type	Order code	Pkg qty	Weight (1 pce)
					kg

### Front mounted instantaneous auxiliary contact blocks (not allowed for mounting on B6S, B7S, interface contactors) (1)

B6-, B7-40-00, BC6-, BC7-40-00	1 1	CAF6-11E	GJL1201330R0002	10	0.020
VB6, VB7, VBC6, VBC7, VB6A, VB7A	2 0	CAF6-20E	GJL1201330R0006	10	0.020
VBC6A, VBC7A	0 2	CAF6-02E	GJL1201330R0010	10	0.020
B6-, B7-30-10, BC6-, BC7-30-10	1 1	CAF6-11M	GJL1201330R0003	10	0.020
VB6, VB7, VBC6, VBC7, VB6A, VB7A	2 0	CAF6-20M	GJL1201330R0007	10	0.020
VBC6A, VBC7A	0 2	CAF6-02M	GJL1201330R0011	10	0.020
B6-, B7-30-01, BC6-, BC7-30-01	1 1	CAF6-11N	GJL1201330R0004	10	0.020
VB6, VB7, VBC6, VBC7, VB6A, VB7A	2 0	CAF6-20N	GJL1201330R0008	10	0.020
VBC6A, VBC7A	0 2	CAF6-02N	GJL1201330R0012	10	0.020

### Side mounted instantaneous auxiliary contact block (1)

B6-, B7-40-00, BC6-, BC7-40-00	1 1	CA6-11E	GJL1201317R0002	10	0.030
B6-, B7-30-10, BC6-, BC7-30-10	1 1	CA6-11M	GJL1201317R0003	10	0.030
B6-, B7-30-01, BC6-, BC7-30-01	1 1	CA6-11N	GJL1201317R0004	10	0.030

### Side mounted instantaneous auxiliary contact block with soldering pins (2)

B6-, B7-40-00-P, BC6-, BC7-40-00-P	1 1	CA6-11E-P	GJL1201319R0002	10	0.025
B6-, B7-30-10-P, BC6-, BC7-30-10-P	1 1	CA6-11M-P	GJL1201319R0003	10	0.025
B6-, B7-30-01-P, BC6-, BC7-30-01-P	1 1	CA6-11N-P	GJL1201319R0004	10	0.025

### Side mounted instantaneous auxiliary contact block with flat pin connection (2)

B6-, B7-40-00-F, BC6-, BC7-40-00-F	1 1	CA6-11E-F	GJL1201318R0002	10	0.025
B6-, B7-30-10-F, BC6-, BC7-30-10-F	1 1	CA6-11M-F	GJL1201318R0003	10	0.025
B6-, B7-30-01-F, BC6-, BC7-30-01-F	1 1	CA6-11N-F	GJL1201318R0004	10	0.025

### Soldering socket (Ith = 10 A, AC-3: 500 V / 8 A, 690 V / 3.5 A, UL: 300 V / 8 A)

B6, B7, BC6, BC7	LB6	GJL1201902R0001	10	0.020
2-pole aux.contact blocks CA	LB6-CA	GJL1201903R0001	10	0.010

(1) CA6 and CAF6 must not be fitted simultaneously.

Suitable for	Rated control circuit voltage UC V DC	Connection type	Type	Order code	Pkg qty	Weight (1 pce) kg
--------------	---------------------------------------	-----------------	------	------------	---------	-------------------

### Surge suppressors for contactor coils

BC6, BC7	24 ... 60	Cable lug	RV-BC6/60	GHV2501902R0002	10	0.005
	50 ... 250	Cable lug	RV-BC6/250	GHV2501903R0002	10	0.005

Note: Mini contactors for AC operation have an integrated protective circuit

### Connecting links with manual motor starters

To connect B..VB.. mini contactor to MS116, MS132	BEA7/132	15BN080906R1002	10	0.013
To connect B..VB.. mini contactors to MS325	BEA7/325	15BN080906R1001	10	0.021

### Connection sets for reversing contactors

VB6, VB7, VBC6, VBC7, VB6A, VB7A, VBC6A, VBC7A, cross-section 1.8 mm <sup>2</sup>	BSM6-30	GJL1201908R0001	10	0.010
---	---------	-----------------	----	-------

### Parallel connecting link

B6, B7, BC6, BC7	LP6	GJL1201907R0001	100	0.009
------------------	-----	-----------------	-----	-------

### Cover cap, transparent fitting to DIN rail design, sealable

B6, B7, BC6, BC7	LT6-B	GJL1201906R0001	10	0.015
------------------	-------	-----------------	----	-------

### Plastic label for markings

B6, B7, BC6, BC7	BA5-50	15BN110000R1000	50	0.020
------------------	--------	-----------------	----	-------



# K6, KC6 4-pole mini contactor relays

## Accessories



CAF6-11K

2CDC211019F0010



CA6-11K

2CDC11009F0010



CA6-11K-P

2CDC211011F0010



CA6-11K-F

2CDC211010F0010



LT6-B

2CDC211006F0010



RV-BC6/250

2CDC11007F0010

Suitable for	Auxiliary contacts	Type	Order code	Pkg qty	Weight (1 pce)
					kg

### Front mounted instantaneous auxiliary contact blocks (1)

K6, KC6	1 1	CAF6-11K	GJL1201330R0001	10	0.020
	2 0	CAF6-20K	GJL1201330R0005	10	0.020
	0 2	CAF6-02K	GJL1201330R0009	10	0.020

### Side mounted instantaneous auxiliary contact block (1)

K6, KC6	1 1	CA6-11K	GJL1201317R0001	10	0.030
---------	-----	---------	-----------------	----	-------

### Side mounted instantaneous auxiliary contact block with soldering pins (2)

K6..P, KC6..P	1 1	CA6-11K-P	GJL1201319R0001	10	0.025
---------------	-----	-----------	-----------------	----	-------

### Side mounted instantaneous auxiliary contact block with flat pin connection (2)

K6..F, KC6..F	1 1	CA6-11K-F	GJL1201318R0001	10	0.025
---------------	-----	-----------	-----------------	----	-------

### Soldering socket (Ie < 8 A)

K6, KC6		LB6	GJL1201902R0001	10	0.020
2-pole auxiliary contact blocks CA		LB6-CA	GJL1201903R0001	10	0.010

(1) CA6 and CAF6 must not be fitted simultaneously.

Suitable for	Rated control circuit voltage	Connection type	Type	Order code	Pkg qty	Weight (1 pce)
	UC VDC					kg

### Surge suppressors for contactor coils

KC6	24 ... 60	Cable lug	RV-BC6/60	GHV2501902R0002	10	0.005
	50 ... 250	Cable lug	RV-BC6/250	GHV2501903R0002	10	0.005

Note: Mini contactors for AC operation have an integrated protective circuit

### Cover cap, transparent fitting to DIN rail design, sealable

K6, KC6		LT6-B	GJL1201906R0001	10	0.015
---------	--	-------	-----------------	----	-------

# B6, B7, BC6, BC7 3- and 4-pole mini contactors VB6, VB7, VBC6, VBC7 3- and 4-pole mini reversing contactors

## Technical data



### Auxiliary contacts for front mounting and side mounting according to IEC

Types	CA6, CAF6	
Standards	IEC/EN 60947-1, IEC/EN 60947-4-1	
Rated operational voltage Ue max	690 V	
Rated frequency (without derating)	DC or 50 / 60 Hz	
Conventional free-air thermal current Ith θ ≤ 40 °C	6 A	
Ie / Rated operational current AC-15 acc. to IEC 60947-5-1	24 V 50/60 Hz	4 A
	110-120 V 50/60 Hz	4 A
	220-230-240 V 50/60 Hz	4 A
	380-400 V 50/60 Hz	3 A
	440 V 50/60 Hz	3 A
Ie / Rated operational current DC-13 acc. to IEC 60947-5-1	24 V DC	2.5 A
	110 V DC	0.7 A
	220 - 240 V DC	0.4 A
Short-circuit protection device	6 A, Type gG	
Minimum switching capacity with failure rate acc. to IEC 60947-5-4	17 V / 5 mA	
Maximum electrical switching frequency	AC-15	600 cycles/h
	DC-13	600 cycles/h

### Auxiliary contacts for front mounting and side mounting according to UL/CSA

Types	CA6, CAF6	
Max. operational voltage	600 V AC	
Pilot duty	A600	
AC thermal rated current	5 A	

### Connection characteristics

Types	CA6, CAF6	
Auxiliary terminals (1)	 <p>Screw terminals with cable clamp</p>	
Connection capacity – auxiliary conductors (built-in auxiliary terminals + coil terminals)		
 Rigid: solid	1 or 2 x	1 ... 4 mm <sup>2</sup>
 Flexible without ferrule	1 or 2 x	1 ... 2.5 mm <sup>2</sup>
Connection capacity acc. to UL/CSA	1 or 2 x	AWG 22 ... 10
Stripping length	9 mm	
Tightening torques	0.8 ... 1.1 Nm / 7 lb.in	
Degree of protection acc. to IEC 60947-1 / EN 60947-1 and IEC 60529 / EN 60529	IP20	
Auxiliary terminals	IP20	
Screw terminals	(Delivered in open position, screws of unused terminals must be tightened)	
All terminals	M3	
Screwdriver type	Flat Ø 5.5 mm / Pozidriv 1	

(1) Soldering pin connection acc. to DIN 40801: 0.8 x 1 mm / 0.8 x 2.54 mm  
Flat pin connection acc. to DIN 46248: 1 x 6.3 mm / 1 x 2.8 mm

# Mini contactors

Location of the connection terminals and terminal designation

## Mini contactors

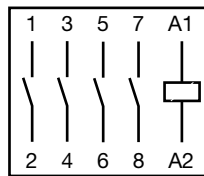

B6(7)-40-00 ...  
BC6(7)-40-00 ...

2CDC12001F0012

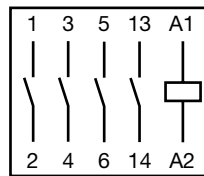

B6(7)-30-10 ...  
BC6(7)-30-10 ...

2CDC12002F0012

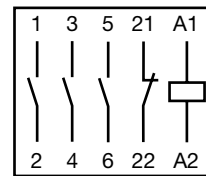

B6(7)-30-01 ...  
BC6(7)-30-01 ...

2CDC12003F0012

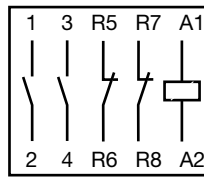

B6(7)-22-00 ...  
BC6(7)-22-00 ...

2CDC12004F0012

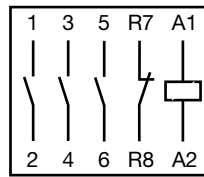

B6(7)-31-00 ...  
BC6(7)-31-00 ...

2CDC12005F0012

## Compact reversing contactors

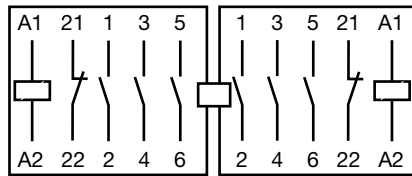

VB6(7)-30-01 ...  
VBC6(7)-30-01 ...

2CDC12006F0012

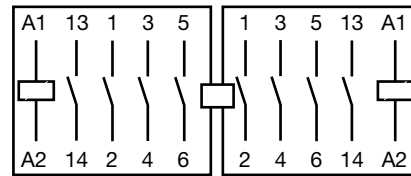

VB6(7)-30-10 ...  
VBC6(7)-30-10 ...

2CDC12007F0012

## Mini contactor relays

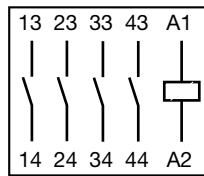

K6-40E ...  
KC6-40E ...

2CDC12008F0012

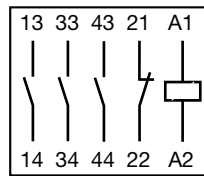

K6-31Z ...  
KC6-31Z ...

2CDC12009F0012

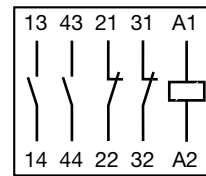

K6-22Z ...  
KC6-22Z ...

2CDC12010F0012

## Auxiliary switches

### CA6...

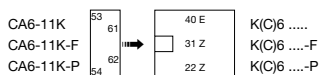
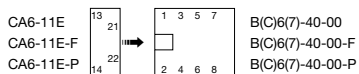

### CAF...

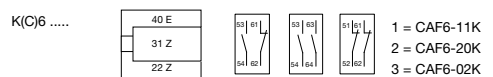
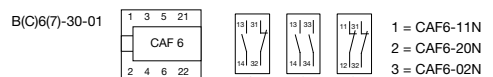
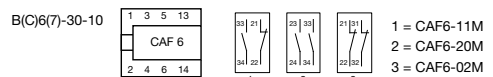
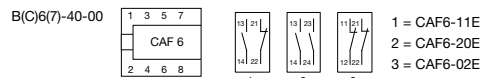

# Mini contactors and contactor relays

## Dimension drawings with accessories

### Front mounted auxiliary contact blocks, with screw terminals

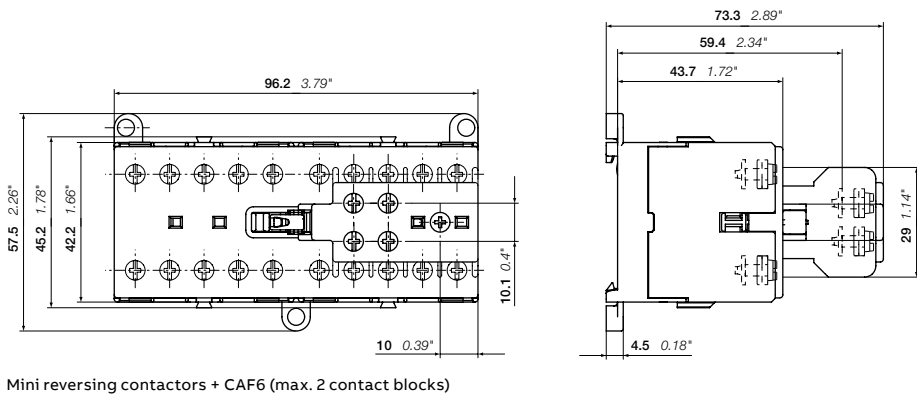
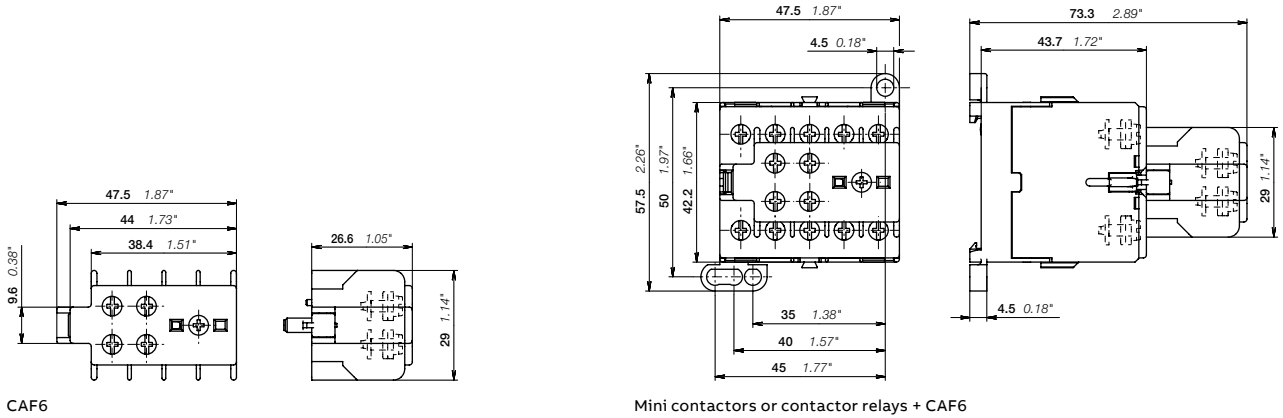

### Side mounted auxiliary contact blocks, with screw terminals

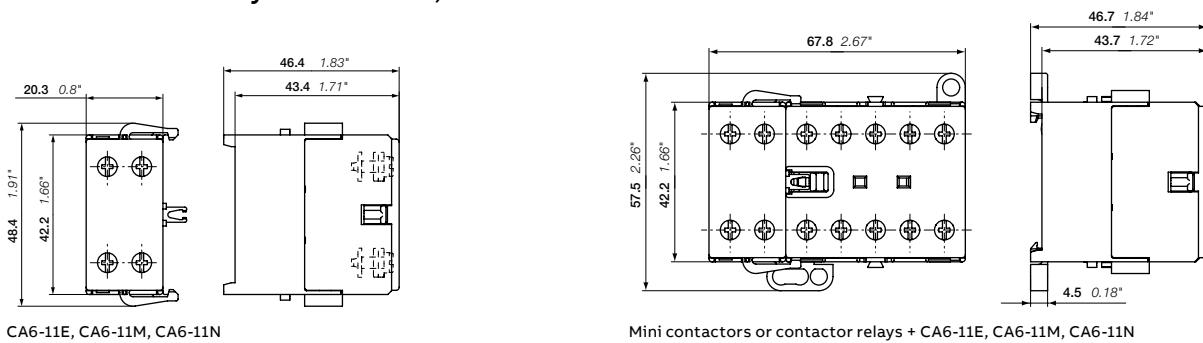

Main dimensions mm, inches

# Mini contactors and contactor relays

## Dimension drawings with accessories

### Side mounted auxiliary contact blocks, with soldering pins

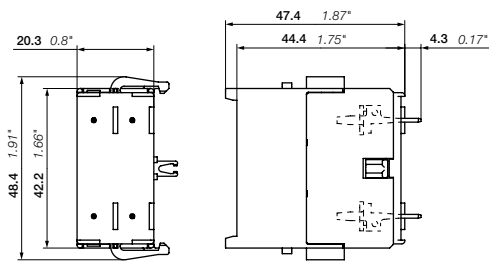

CA6-11E-P, CA6-11M-P, CA6-11N-P

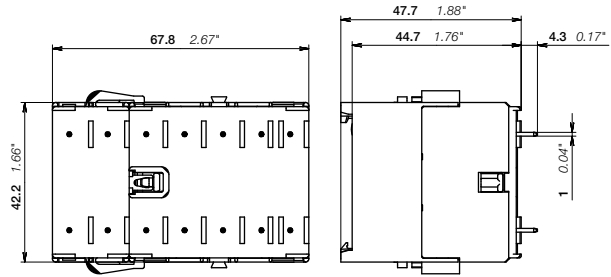

Mini contactors or contactor relays + CA6-11E-P, CA6-11M-P, CA6-11N-P

### Side mounted auxiliary contact blocks, with flat pin connection

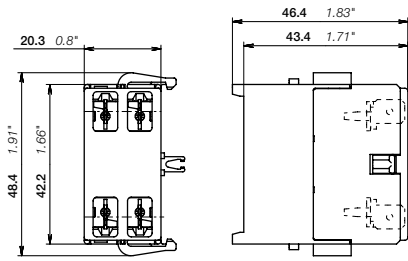

CA6-11E-F, CA6-11M-F, CA6-11N-F

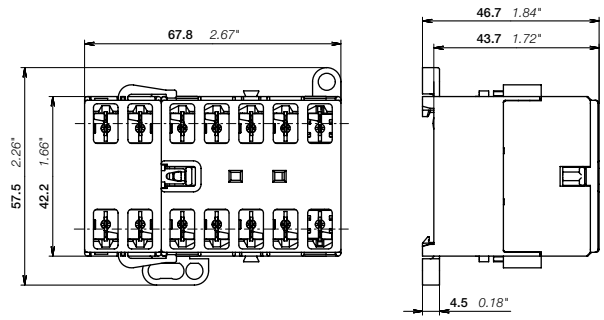

Mini contactors or contactor relays + CA6-11E-F, CA6-11M-F, CA6-11N-F

### Front mounted cover cap for DIN rail panel installation

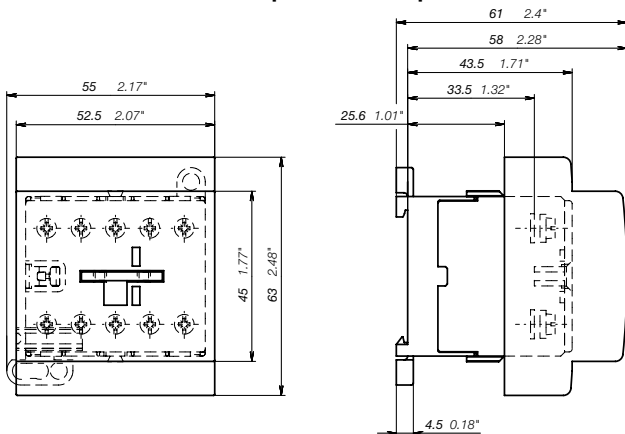

Mini contactors or contactor relays + LT6-B cover cap

# Mini contactors and contactor relays

## Dimension drawings with accessories

### Drilling plans for wall mounting

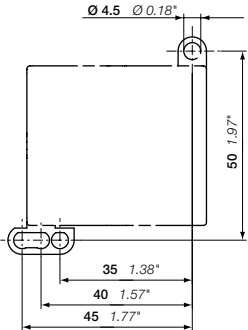

Mini contactors or contactor relays with screw terminals and flat pin connection

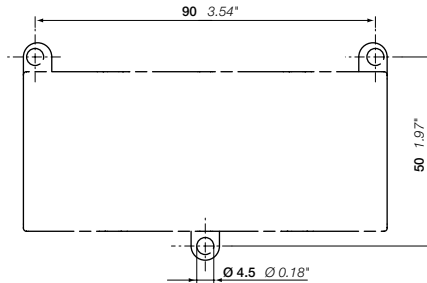

Mini reversing contactors with screw terminals and flat pin connection

### Drilling plans for PCBA

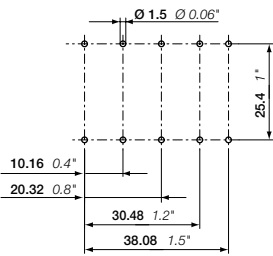

Mini contactors or contactor relays with soldering pins

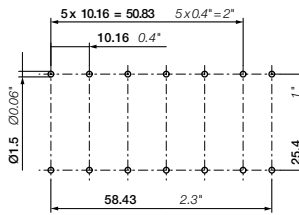

Mini contactors or contactor relays with soldering pins + CA6-11E-P, CA6-11M-P, CA6-11N-P

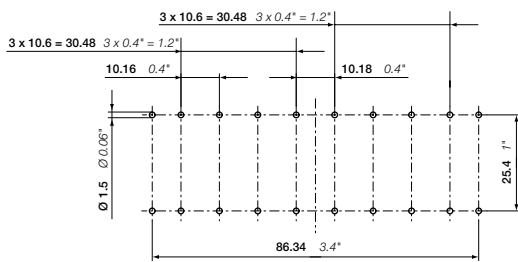

Mini reversing contactors with soldering pins



**For direct product details information, use product type or order code, ex:**

[www.abb.com/productdetails/AS09-30-10-20](http://www.abb.com/productdetails/AS09-30-10-20)  
or  
[www.abb.com/productdetails/1SBL101001R2010](http://www.abb.com/productdetails/1SBL101001R2010)

---

# AS 3-pole contactors and NS 3-pole contactor relays with screw terminals

## **3-pole contactors**

- 5/3** Overview
- 5/8** AS09 ... AS16 AC operated
- 5/9** ASL09 ... ASL16 DC operated
- 5/10** AS09 ... AS16 AC operated - 2-stack
- 5/11** ASL09 ... ASL16 DC operated - 2-stack
- 5/12** Main accessories
- 5/14** Technical data
- 5/20** Electrical durability
- 5/22** Terminal marking and positioning
- 5/24** Dimensions

## **Contactor relays**

- 5/28** Overview
- 5/30** NS AC operated
- 5/31** NSL DC operated
- 5/32** Main accessories
- 5/34** Technical data
- 5/38** Terminal marking and positioning
- 5/40** Dimensions

## **Accessories**

- 5/42** Auxiliary contact blocks
- 5/45** Electronic timers
- 5/48** Surge suppressors
- 5/50** Mechanical interlock unit and other accessories
- 5/51** Connection accessories for starting solutions

## **5/52 Voltage code table**





# AS contactors

Efficient and space saving

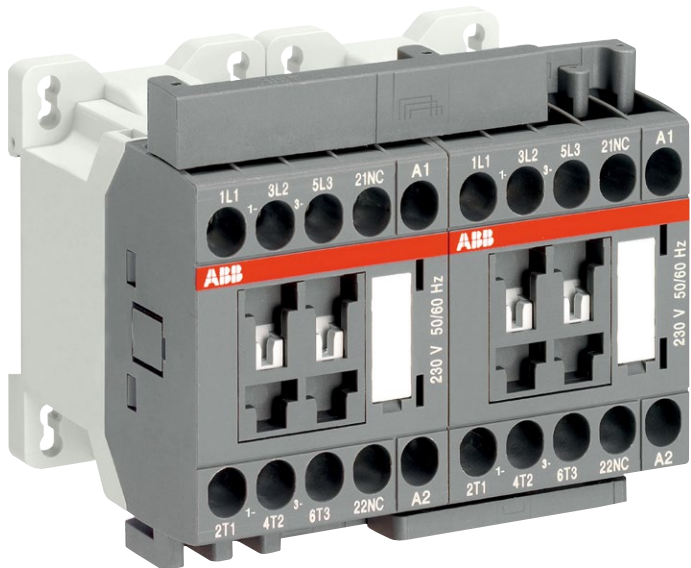

The compact AS contactor range allows you to optimize equipment design and is a reliable, time and cost saving solution.



## Speed up your projects

### Simpler by design

AS contactors come in one single size and are designed to make life easy for engineering, handling and wiring purposes. These products follow a simple marking pattern, which enables a quick identification of their individual features.



## Easy to install

### Easy to use

Make engineering a simple process with AS contactors. Every product is delivered with opened terminals, located directly on the front for easy access. Every terminal is screwdriver guided. Spring terminal versions are also available for a time-saving and reliable connection alternative.



## Space saving

### Space optimization

The addition of accessories keeps the panel smart and compact, while providing additional features. Interlocking kits and surge suppression are clipped into the housing without adding width to the small frame of the contactor.

# Compact and efficient

## Optimize your equipment dimensions!

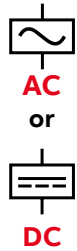
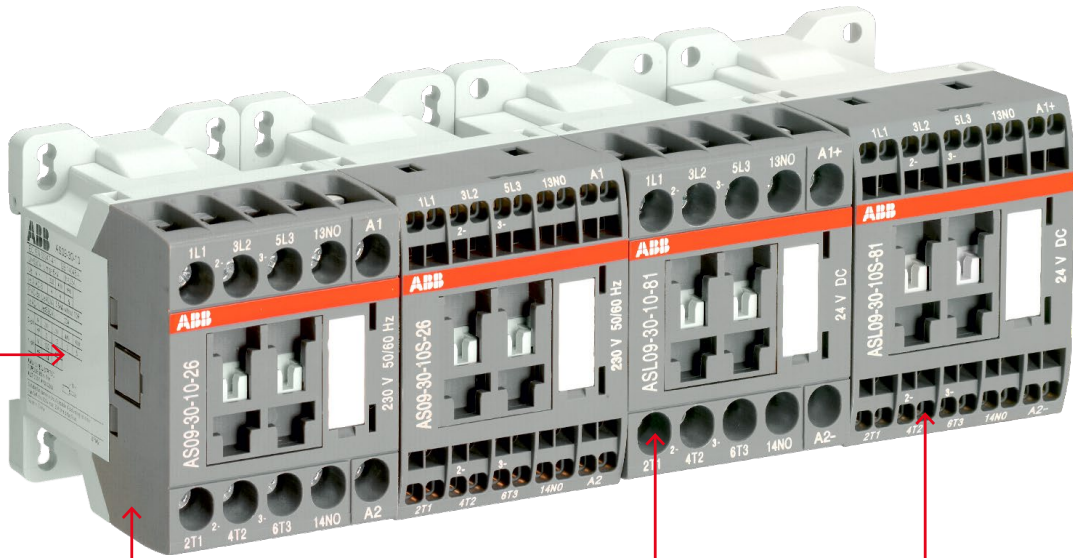

**W 45 x H 68 x D 72.5 mm**

**Easy to engineer with just one size**

For motor starting solutions up to 7.5 kW at 400 V and 3 hp at 440 V, contactors are in one frame size for both AC and DC coils.



**Screw**

**Screw terminal**  
On top of that, they are available with screw or spring terminals.



**Spring**

**Spring terminal**

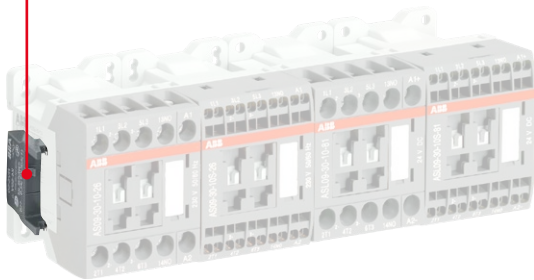

### Side clip-on surge suppressors

This add-on snaps and connects to the side of the housing and does not add width to the frame. The coil terminals remain accessible this way.

90 mm

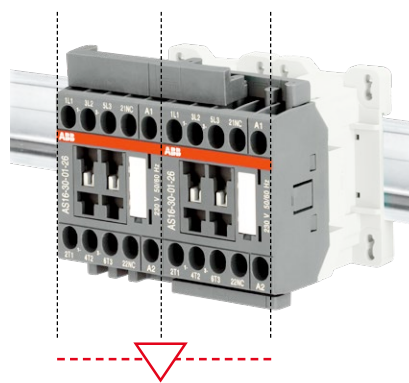

### Compact reversing contactors

With their low consumption coil of only 3 W, AS contactors can be controlled directly by most PLC's. For 24 V control circuits, this is only 125 mA.

# Easy to use

## Space-saving and intuitive



### Make your control circuits reliable

Built-in and add-on auxiliary contacts offer high reliability for low signals and meet the requirements for mechanically linked and mirror contacts according to IEC standards.

### Two types of terminals, for even more choices

As an alternative to the conventional screw terminals, spring terminals are often used in applications with vibrations. Both types are able to accommodate two cables. This way, AS offers the right type of terminal depending on the installation.

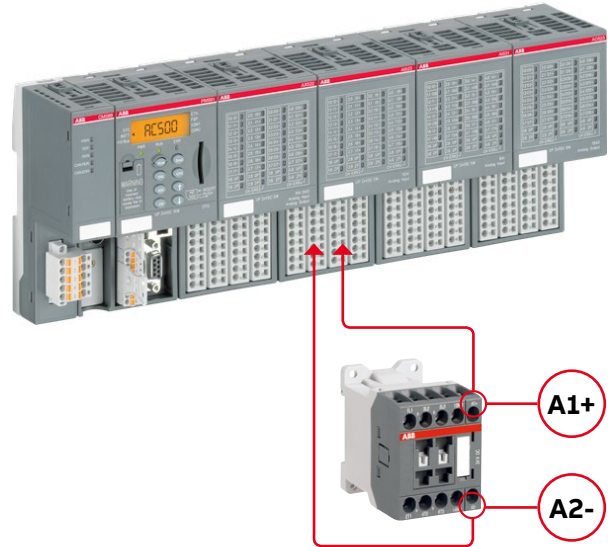

### Direct control by PLC

With their low consumption coil of only 3 W, AS contactors can be controlled directly by most PLC's. For 24 V control circuits, this is only 125 mA.

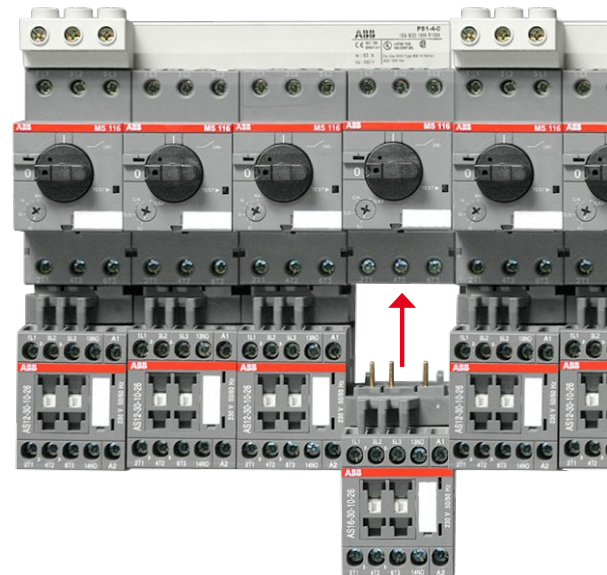

### Choose reliable and time-saving solutions

AS contactors can easily be connected to manual motor starters or overload relays. The connecting accessories prevent mistakes and save time when assembling starter combinations.

# 3-pole contactors

## Main accessories



AS09 ... AS16  
3-pole contactors

05

## Main accessories for contactors

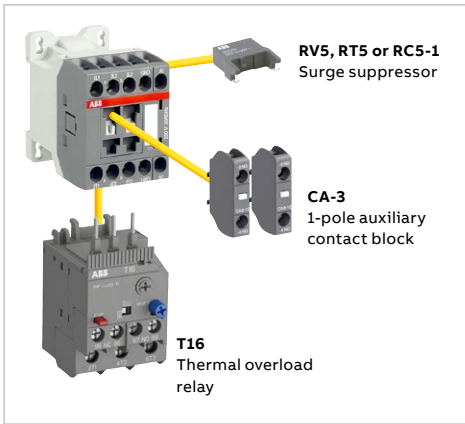

## Main accessories for starting solutions

### Direct-on-line starter

### Reversing starter

### Star-delta starter

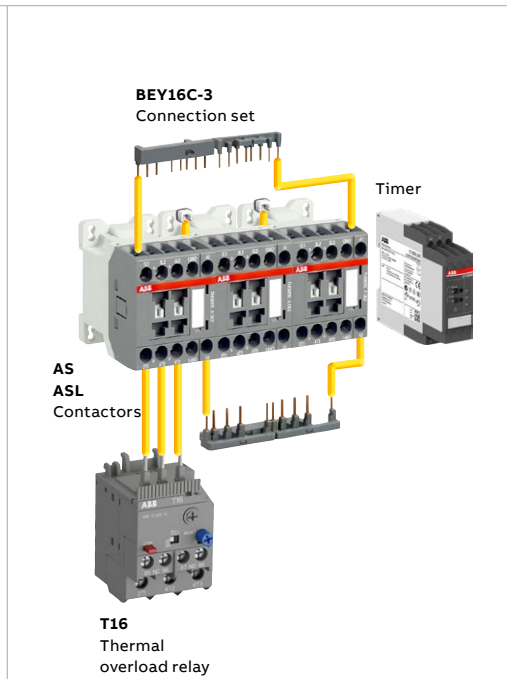
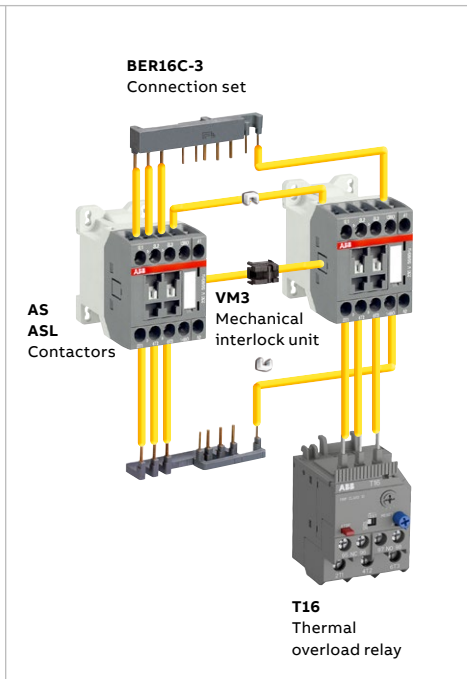
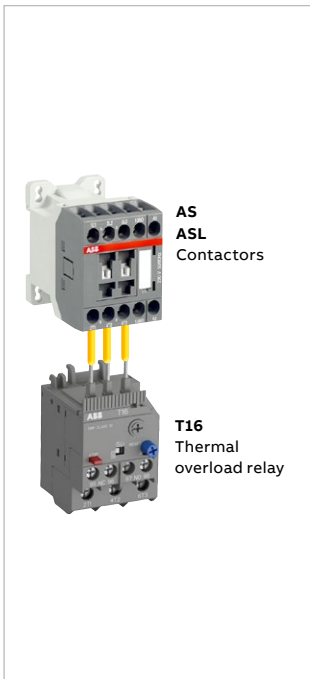

15BC10129250201



## 3-pole contactors



### Screw terminals

	AC control voltage	<b>AS09</b>	<b>AS12</b>	<b>AS16</b>
	DC control voltage	<b>ASL09</b>	<b>ASL12</b>	<b>ASL16</b>

### Switching of 3-phase cage motors

	IEC	<b>AC-3</b>	Rated operational power	400 V	4 kW	5.5 kW	7.5 kW	
			Rated operational current	$\theta \leq 60^\circ\text{C}$	400 V	9 A	12 A	15.5 A
				$\theta \leq 60^\circ\text{C}$	415 V	9 A	12 A	15.5 A
				$\theta \leq 60^\circ\text{C}$	690 V	5 A	7 A	9 A
UL / CSA	3-phase motor rating		440-480 V	5 hp	7.5 hp	10 hp		
NEMA size				00	00	0		

### Protection of 3-phase motors

Thermal overload relays		<b>T16...</b>					
		0.10...0.13	0.23...0.31	0.55...0.74	1.30...1.70	3.10...4.20	7.60...10.0
		0.13...0.17	0.31...0.41	0.74...1.00	1.70...2.30	4.20...5.70	10.0...13.0
		0.17...0.23	0.41...0.55	1.00...1.30	2.30...3.10	5.70...7.60	13.0...16.0

### Switching of resistive circuits

	IEC	<b>AC-1</b>	Rated operational current	$\theta \leq 40^\circ\text{C}$	690 V	22 A	24 A	24 A
			$\theta \leq 60^\circ\text{C}$	690 V	18 A	20 A	20 A	
			$\theta \leq 70^\circ\text{C}$	690 V	15 A	16 A	16 A	
			With conductor cross-sectional area		2.5 mm <sup>2</sup>	2.5 mm <sup>2</sup>	2.5 mm <sup>2</sup>	
UL / CSA	General use rating		600 V AC	20 A	20 A	20 A		
With conductor cross-sectional area		AWG 12	AWG 12	AWG 12				

### Main accessories

Auxiliary contact blocks	Front mounting		1-pole <b>CA3-10</b> or <b>CA3-01</b>
Interlocks	Mechanical		<b>VM3</b>
Surge suppressors	Side-mounted (without additional width)		<b>RV5</b> (Varistor) AC / DC <b>RC5-1</b> (Capacitor) AC <b>RT5</b> (Transil diode) DC
Connection sets	Reversing starters Star-delta starters		<b>BER16C-3</b> <b>BEY16C-3</b>
Connecting link	With manual motor starter		<b>BEA16-3</b>

# AS09 ... AS16 3-pole contactors

4 to 7.5 kW

AC operated



AS09-30-10

AS09 ... AS16 contactors are mainly used for controlling 3-phase motors and power circuits up to 690 V AC and 220 V DC.

These contactors are of the block type design with:

- 3 main poles and 1 built-in auxiliary contact
- control circuit: AC operated
- add-on auxiliary contact blocks for front mounting and a comprehensive range of accessories.

IEC	UL/CSA		Rated control circuit voltage		Auxiliary contacts fitted	Type	Order code	Weight				
	Rated operational power	current $\theta \leq 40^\circ\text{C}$	3-phase motor rating 480 V	General use rating 600 V AC					Uc (1)			
400 V AC-3	AC-1	A	hp	A	V 50 Hz	V 60 Hz		kg				
4	22	5	20	24	24		AS09-30-10-20	1SBL101001R2010	0.220			
							AS09-30-01-20	1SBL101001R2001	0.220			
							230	230	1 0	AS09-30-10-26	1SBL101001R2610	0.220
							0 1	AS09-30-01-26	1SBL101001R2601	0.220		
5.5	24	7.5	20	24	24		AS12-30-10-20	1SBL111001R2010	0.220			
							AS12-30-01-20	1SBL111001R2001	0.220			
							230	230	1 0	AS12-30-10-26	1SBL111001R2610	0.220
							0 1	AS12-30-01-26	1SBL111001R2601	0.220		
7.5	24	10	20	24	24		AS16-30-10-20	1SBL121001R2010	0.220			
							AS16-30-01-20	1SBL121001R2001	0.220			
							230	230	1 0	AS16-30-10-26	1SBL121001R2610	0.220
							0 1	AS16-30-01-26	1SBL121001R2601	0.220		

Note: for multiple packaging, please contact your ABB local sales organization.

(1) Other control voltages see voltage code table.

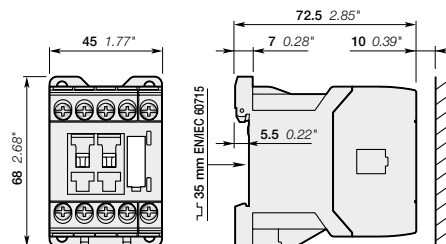

AS09, AS12, AS16

Main dimensions mm, inches

## ASL09 ... ASL16 3-pole contactors

4 to 7.5 kW

DC operated



ASL09-30-10

ASL09 ... ASL16 contactors are mainly used for controlling 3-phase motors and power circuits up to 690 V AC and 220 V DC.

These contactors are of the block type design with:

- 3 main poles and 1 built-in auxiliary contact
- control circuit: low consumption (3 W at pull-in and holding) DC operated with solid core magnet. Suitable for direct control by PLC outputs (the polarity on the coil terminals A1+ and A2- must be respected)
- add-on auxiliary contact blocks for front mounting and a comprehensive range of accessories.

IEC		UL/CSA		Rated control circuit voltage Uc (1)	Auxiliary contacts fitted	Type	Order code	Weight Pkg (1 pce) kg
Rated operational power	current $\theta \leq 40^\circ\text{C}$	3-phase motor rating 480 V	General use rating 600 V AC					
400 V AC-3 kW	AC-1 A	hp	A	V DC				
4	22	5	20	24	1 0 0 1	ASL09-30-10-81 ASL09-30-01-81	1SBL103001R8110 1SBL103001R8101	0.280 0.280
5.5	24	7.5	20	24	1 0 0 1	ASL12-30-10-81 ASL12-30-01-81	1SBL113001R8110 1SBL113001R8101	0.280 0.280
7.5	24	10	20	24	1 0 0 1	ASL16-30-10-81 ASL16-30-01-81	1SBL123001R8110 1SBL123001R8101	0.280 0.280

Note: for multiple packaging, please contact your ABB local sales organization.  
(1) Other control voltages see voltage code table.

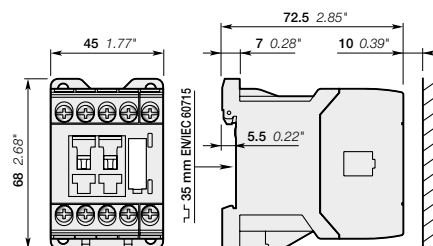

ASL09, ASL12, ASL16

Main dimensions mm, inches

05

1SBC10130250201 - Rev. A



# AS09 ... AS16 2-stack 3-pole contactors

4 to 7.5 kW

AC operated



AS09-30-32

AS09 ... AS16 contactors are mainly used for controlling 3-phase motors and power circuits up to 690 V AC and 220 V DC.

These contactors are of the block type design with:

- 1st stack with 3 main poles and 1 N.O. built-in auxiliary contact
- 2nd stack with permanently fixed 2 N.O. + 2 N.C. auxiliary contact block. The auxiliary contact elements are mechanically linked (side-marked symbol) and the N.C. auxiliary contacts are mirror contacts
- control circuit: AC operated
- a comprehensive range of accessories.

IEC		UL/CSA		Rated control circuit voltage Uc (1)		Auxiliary contacts fitted	Type	Order code	Weight
Rated operational power	current $\theta \leq 40^\circ\text{C}$	3-phase motor rating 480 V	General use rating 600 V AC	V 50 Hz	V 60 Hz				
400 V AC-3	AC-1	480 V	600 V AC						kg
kW	A	hp	A						
4	22	5	20	24	24	3 2	AS09-30-32-20	1SBL101001R2032	0.260
				230	230	3 2	AS09-30-32-26	1SBL101001R2632	0.260
5.5	24	7.5	20	24	24	3 2	AS12-30-32-20	1SBL111001R2032	0.260
				230	230	3 2	AS12-30-32-26	1SBL111001R2632	0.260
7.5	24	10	20	24	24	3 2	AS16-30-32-20	1SBL121001R2032	0.260
				230	230	3 2	AS16-30-32-26	1SBL121001R2632	0.260

Note: for multiple packaging, please contact your ABB local sales organization.  
 (1) Other control voltages see voltage code table.

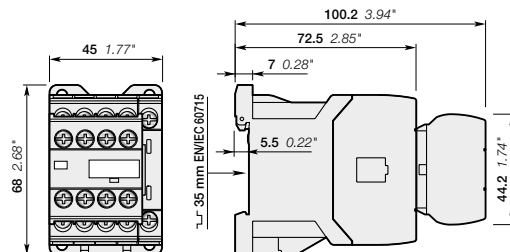

AS09, AS12, AS16

Main dimensions mm, inches

## ASL09 ... ASL16 2-stack 3-pole contactors

4 to 7.5 kW

DC operated



ASL09-30-32

ASL09 ... ASL16 contactors are mainly used for controlling 3-phase motors and power circuits up to 690 V AC and 220 V DC.

These contactors are of the block type design with:

- 1st stack with 3 main poles and 1 N.O. built-in auxiliary contact
- 2nd stack with permanently fixed 2 N.O. + 2 N.C. auxiliary contact block. The auxiliary contact elements are mechanically linked (side-marked symbol) and the N.C. auxiliary contacts are mirror contacts
- control circuit: low consumption (3 W at pull-in and holding) DC operated with solid core magnet. Suitable for direct control by PLC outputs (the polarity on the coil terminals A1+ and A2- must be respected)
- a comprehensive range of accessories.

IEC		UL/CSA		Rated control circuit voltage Uc (1)	Auxiliary contacts fitted	Type	Order code	Weight Pkg (1 pce)
Rated operational power	current $\theta \leq 40^\circ\text{C}$	3-phase motor rating 480 V	General use rating 600 V AC					
400 V AC-3	AC-1			V DC				kg
kW	A	hp	A					
4	22	5	20	24	3 2	ASL09-30-32-81	1SBL103001R8132	0.320
5.5	24	7.5	20	24	3 2	ASL12-30-32-81	1SBL113001R8132	0.320
7.5	24	10	20	24	3 2	ASL16-30-32-81	1SBL123001R8132	0.320

Note: for multiple packaging, please contact your ABB local sales organization.  
(1) Other control voltages see voltage code table.

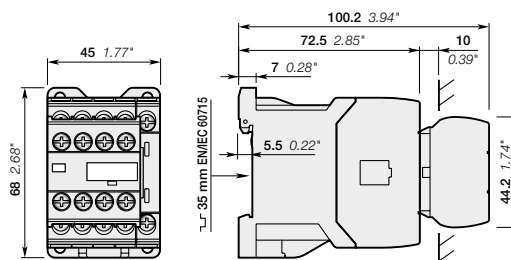

ASL09, ASL12, ASL16

Main dimensions mm, inches

# AS09 ... AS16 and ASL09 ... ASL16 3-pole contactors

## Main accessories

### Contactor and main accessories (other accessories available)

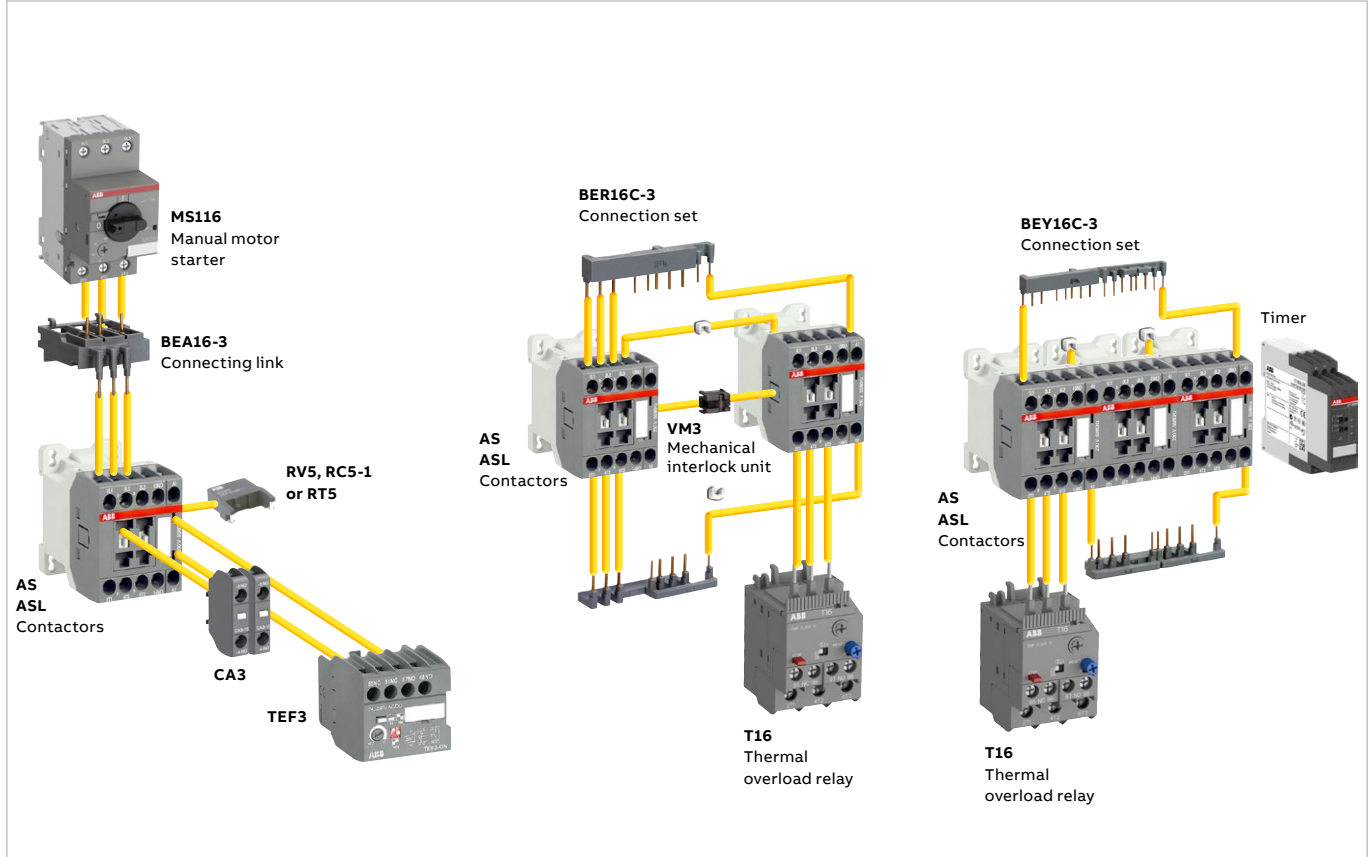

### Main accessory fitting details

Many configurations of accessories are possible depending on whether these are front-mounted or side-mounted.

Contactor types	Main poles	Built-in auxiliary contacts	Front-mounted accessories			Side-mounted accessories		
			Auxiliary contact blocks	Electronic timer	Mechanical interlock unit (between 2 contactors)	Surge suppressors		
			1-pole CA3	TEF3	VM3	RV5	or RC5-1	
AS09 ... AS16	3 0	1 0	2 max.	or 1	+	+		
	3 0	0 1						
AS09 ... AS16	3 0	3 2	-	-	1	+	RV5	or RC5-1
ASL09 ... ASL16	3 0	1 0	2 max.	or 1	+	+	RV5	or RT5
	3 0	0 1						
ASL09 ... ASL16	3 0	3 2	-	-	1	+	RV5	or RT5

### Overload relays fitting details (1)

Contactor types	Thermal overload relays
AS09 ... AS16	T16 (0.10...16 A)
ASL09 ... ASL16	

The addition of an overload relay on the contactor does not prevent fitting of many other accessories as shown above.  
 (1) Direct mounting - No kit required.

# AS09 ... AS16 and ASL09 ... ASL16 3-pole contactors

## Main accessories



CA3-10



TEF3-ON



VM3



RV5



BEA16-3

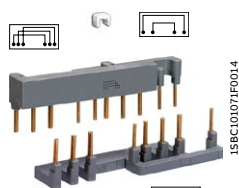

BER16C-3

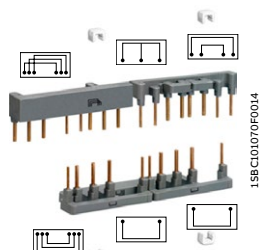

BEY16C-3

### Front-mounted instantaneous auxiliary contact blocks

For contactors	Auxiliary contacts	Type	Order code	Pkg qty	Weight (1 pce)
					kg
AS09 ... AS16	1 0	CA3-10	1SBN011010T1010	10	0.011
ASL09 ... ASL16	0 1	CA3-01	1SBN011010T1001	10	0.011

### Front-mounted electronic timer

For contactors	Rated control circuit voltage - Uc	Type	Order code	Pkg qty	Weight (1 pce)
	V				kg
<b>ON-delay</b>					
AS09 ... AS16, ASL09 ... ASL16	24...240 V AC/DC	TEF3-ON	1SBN021012R1000	1	0.065
<b>OFF-delay</b>					
AS09 ... AS16, ASL09 ... ASL16	24...240 V AC/DC	TEF3-OFF	1SBN021014R1000	1	0.065

### Mechanical interlock unit

For contactors	Type	Order code	Pkg qty	Weight (1 pce)
AS09 ... AS16, ASL09 ... ASL16	VM3	1SBN031005T1000	10	0.002

### Surge suppressors

For contactors	Rated control circuit voltage - Uc		Type	Order code	Pkg qty	Weight (1 pce)
	V	AC DC				
AS09 ... AS16, ASL09 ... ASL16	24...50	● ●	RV5/50	1SBN050010R1000	2	0.015
	50...133	● ●	RV5/133	1SBN050010R1001	2	0.015
	110...250	● ●	RV5/250	1SBN050010R1002	2	0.015
	250...440	● ●	RV5/440	1SBN050010R1003	2	0.015
AS09 ... AS16	24...50	● -	RC5-1/50	1SBN050100R1000	2	0.012
	50...133	● -	RC5-1/133	1SBN050100R1001	2	0.012
	110...250	● -	RC5-1/250	1SBN050100R1002	2	0.012
ASL09 ... ASL16	250...440	● -	RC5-1/440	1SBN050100R1003	2	0.012
	12...32	- ●	RT5/32	1SBN050020R1000	2	0.015
	25...65	- ●	RT5/65	1SBN050020R1001	2	0.015
	50...90	- ●	RT5/90	1SBN050020R1002	2	0.015
	77...150	- ●	RT5/150	1SBN050020R1003	2	0.015
	150...264	- ●	RT5/264	1SBN050020R1004	2	0.015

### Connecting links with manual motor starters

For contactors	Manual motor starter	Type	Order code	Pkg qty	Weight (1 pce)
AS09 ... AS16	MS116-0.16 ... MS116-16	BEA16-3	1SBN081006T1000	10	0.019
ASL09 ... ASL16	MS132-0.16 ... MS132-16				

### Connection sets for reversing contactors

For contactors	Mechanical interlock unit	Type	Order code	Pkg qty	Weight (1 pce)
AS09 ... AS16, ASL09 ... ASL16	with or without VM3	BER16C-3	1SBN081012R1000	1	0.035

Note: BER16C-3 connection set includes two BB3 fixing clips, and an electrical interlocking when fitted on contactors with built-in N.C. auxiliary contacts. BER16C-3 can be used with or without VM3 mechanical interlock unit.

### Connection sets for star-delta starting



For contactors	Mech. interlock unit between Star & Delta contactors	Type	Order code	Pkg qty	Weight (1 pce)
AS09 ... AS12, ASL09 ... ASL12	with or without VM3	BEY16C-3	1SBN081018R2000	1	0.041

Note: BEY16C-3 connection set includes two BB3 fixing clips, and an electrical interlocking when fitted on Star and Delta contactors with built-in N.C. auxiliary contacts. BEY16C-3 can be used with or without VM3 mechanical interlock unit.

# AS09 ... AS16 and ASL09 ... ASL16 3-pole contactors

## Technical data

### Main pole - Utilization characteristics according to IEC

Contactor types	AC operated	<b>AS09</b>	<b>AS12</b>	<b>AS16</b>
	DC operated	<b>ASL09</b>	<b>ASL12</b>	<b>ASL16</b>
Standards	IEC 60947-1 / 60947-4-1 and EN 60947-1 / 60947-4-1			
Rated operational voltage U <sub>e</sub> max.	690 V			
Rated frequency (without derating)	50 / 60 Hz			
Conventional free-air thermal current I <sub>th</sub> acc. to IEC 60947-4-1, open contactors, $\theta \leq 40^\circ\text{C}$	22 A		25 A	25 A
With conductor cross-sectional area	2.5 mm <sup>2</sup>		4 mm <sup>2</sup>	4 mm <sup>2</sup>
AC-1 Utilization category				
For air temperature close to contactor				
I <sub>e</sub> / Rated operational current AC-1	$\theta \leq 40^\circ\text{C}$	22 A	24 A	24 A
U <sub>e</sub> max. $\leq 690\text{ V}, 50/60\text{ Hz}$	$\theta \leq 60^\circ\text{C}$	18 A	20 A	20 A
	$\theta \leq 70^\circ\text{C}$	15 A	16 A	16 A
With conductor cross-sectional area	2.5 mm <sup>2</sup>			
AC-3 Utilization category				
For air temperature close to contactor $\theta \leq 60^\circ\text{C}$				
I <sub>e</sub> / Max. rated operational current AC-3 (1)				
	220-230-240 V	9 A	12 A	15.7 A
	400 V	9 A	12 A	15.5 A
	415 V	9 A	12 A	15.5 A
	440 V	8 A	11 A	13.6 A
	500 V	8 A	11 A	12.5 A
	690 V	5 A	7 A	9 A
	 3-phase motors			
Rated operational power AC-3 (1)				
	220-230-240 V	2.2 kW	3 kW	4 kW
	400 V	4 kW	5.5 kW	7.5 kW
	415 V	4 kW	5.5 kW	7.5 kW
	440 V	4 kW	5.5 kW	7.5 kW
	500 V	4 kW	5.5 kW	7.5 kW
	690 V	4 kW	5.5 kW	7.5 kW
	 1500 r.p.m. 50 Hz 1800 r.p.m. 60 Hz 3-phase motors			
Rated making capacity AC-3	10 x I <sub>e</sub> AC-3 acc. to IEC 60947-4-1			
Rated breaking capacity AC-3	8 x I <sub>e</sub> AC-3 acc. to IEC 60947-4-1			
AC-8a Utilization category				
(without thermal overload relay - U <sub>e</sub> 400 V 50/60 Hz - $\theta \leq 40^\circ\text{C}$ )				
I <sub>e</sub> / Rated operational current AC-8a	12 A		16 A	22 A
Rated operational power AC-8a	5.5 kW		7.5 kW	11 kW
Short-circuit protection device for contactors without thermal overload relay - Motor protection excluded (2)				
U <sub>e</sub> $\leq 500\text{ V AC}$ - gG type fuse	25 A			
Rated short-time withstand current I <sub>cw</sub>	1 s	230 A	250 A	250 A
at 40 °C ambient temperature,	10 s	100 A	124 A	124 A
in free air from a cold state	30 s	65 A	75 A	75 A
	1 min	50 A	55 A	55 A
	15 min	22 A	24 A	24 A
Maximum breaking capacity				
cos $\phi = 0.45$	at 440 V	155 A		
	at 690 V	90 A		
Power dissipation per pole	I <sub>e</sub> / AC-1	1 W	1.2 W	1.2 W
	I <sub>e</sub> / AC-3	0.16 W	0.3 W	0.5 W
Max. electrical switching frequency	AC-1	600 cycles/h		
	AC-3	1200 cycles/h		
	AC-4	300 cycles/h		

(1) For the corresponding kW/A or hp/A values of 1500 r.p.m, 50 Hz or 1800 r.p.m, 60 Hz, 3-phase motors, see "Motor rated operational powers and currents".

(2) For the protection of motor starters against short circuits, see "Coordination with short-circuit protection devices".

# AS09 ... AS16 and ASL09 ... ASL16 3-pole contactors

## Technical data

### Main pole - Utilization characteristics according to UL / NEMA / CSA

Contactor types	AC operated	<b>AS09</b>	<b>AS12</b>	<b>AS16</b>	
	DC operated	<b>ASL09</b>	<b>ASL12</b>	<b>ASL16</b>	
Standards	UL 508, CSA C22.2 N°14				
Max. operational voltage	690 V				
NEMA size	00		00	0	
NEMA continuous amp rating	Thermal current	9 A	9 A	18 A	
NEMA maximum horse power ratings 1-phase, 60 Hz	115 V AC	1/3 hp	1/3 hp	1 hp	
	230 V AC	1 hp	1 hp	2 hp	
NEMA maximum horse power ratings 3-phase, 60 Hz	200 V AC	1 1/2 hp	1 1/2 hp	3 hp	
	230 V AC	1 1/2 hp	1 1/2 hp	3 hp	
	460 V AC	2 hp	2 hp	5 hp	
	575 V AC	2 hp	2 hp	5 hp	
UL / CSA general use rating	600 V AC	20 A	20 A	20 A	
	With conductor cross-sectional area	AWG 12	AWG 12	AWG 12	
UL / CSA maximum 1-phase motor rating	Full load current	120 V AC	7.2 A	9.8 A	13.8 A
		240 V AC	8 A	10 A	12 A
Horse power rating	120 V AC	1/3 hp	1/2 hp	3/4 hp	
	240 V AC	1 hp	1-1/2 hp	2 hp	
UL / CSA maximum 3-phase motor rating	Full load current (1)	200-208 V AC	7.8 A	7.8 A	11 A
		220-240 V AC	6.8 A	9.6 A	15.2 A
		440-480 V AC	7.6 A	11 A	14 A
		550-600 V AC	9 A	11 A	11 A
		Horse power rating (1)	200-208 V AC	2 hp	2 hp
	220-240 V AC	2 hp	3 hp	5 hp	
	440-480 V AC	5 hp	7-1/2 hp	10 hp	
	550-600 V AC	7-1/2 hp	10 hp	10 hp	
Short-circuit protection device for contactors without thermal overload relay - Motor protection excluded	Fuse rating	40 A	50 A	60 A	
	Fuse type, 600 V	J			
	Max. electrical switching frequency				
For general use	600 cycles/h				
For motor use	1200 cycles/h				

(1) For the corresponding kW/A or hp/A values of 1500 r.p.m, 50 Hz or 1800 r.p.m, 60 Hz, 3-phase motors, see "Motor rated operational powers and currents".

### General technical data

Contactor types	AC operated	<b>AS09</b>	<b>AS12</b>	<b>AS16</b>
	DC operated	<b>ASL09</b>	<b>ASL12</b>	<b>ASL16</b>
Rated insulation voltage Ui	690 V			
acc. to IEC 60947-4-1	600 V			
acc. to UL / CSA	6 kV			
Rated impulse withstand voltage Uimp.	6 kV			
Ambient air temperature close to contactor				
Operation	Fitted with thermal overload relay	-25...+60 °C		
	Without thermal overload relay	-40...+70 °C		
Storage	-60...+80 °C			
Climatic withstand	Category B according to IEC 60947-1 Annex Q			
Maximum operating altitude (without derating)	3000 m			
Mechanical durability	10 millions operating cycles			
Number of operating cycles	3600 cycles/h			
Max. switching frequency				
Shock withstand	1/2 sinusoidal shock for 11 ms: no change in contact position, closed or open position			
acc. to IEC 60068-2-27 and EN 60068-2-27	Shock direction	AS contactors - AC operated	ASL contactors - DC operated	
Mounting position 1	A	20 g	20 g closed position / 10 g open position	
	B1	10 g closed position / 5 g open position	15 g closed position / 5 g open position	
	B2	15 g	10 g	
	C1	20 g closed position / 9 g open position	15 g closed position / 8 g open position	
	C2	20 g closed position / 14 g open position	14 g closed position / 8 g open position	
Vibration withstand acc. to IEC 60068-2-6	5...300 Hz / 3 g closed position / 2 g open position			

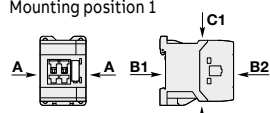

15BC0148950201

# AS09 ... AS16 and ASL09 ... ASL16 3-pole contactors

## Technical data

### Magnet system characteristics for AS09 ... AS16 contactors

Contactor types		AC operated	AS09	AS12	AS16	
Coil operating limits acc. to IEC 60947-4-1		AC supply	0.85...1.1 x U <sub>c</sub> (at θ ≤ 60 °C); U <sub>c</sub> (at θ ≤ 70 °C)			
AC control voltage	Rated control circuit voltage U <sub>c</sub>	at 50 Hz	24...415 V			
		at 60 Hz	24...415 V			
Coil consumption	Average pull-in value	50 Hz	33 VA			
		60 Hz	33 VA			
		50/60 Hz	33 VA			
		Average holding value	50 Hz	6.5 VA / 1.5 W		
			60 Hz	5 VA / 1.2 W		
	50/60 Hz	6.5 VA / 1.5 W				
Drop-out voltage			Approx. 30...50 % of U <sub>c</sub>			
Operating time						
Between coil energization and:	N.O. contact closing		9...24 ms			
	N.C. contact opening		6...18 ms			
Between coil de-energization and:	N.O. contact opening (1)		5...19 ms			
	N.C. contact closing (1)		7...22 ms			
(1) The use of RC5-1 surge suppressor increases opening time by a factor of 2 to 3						

### Magnet system characteristics for ASL09 ... ASL16 contactors

Contactor types		DC operated	ASL09	ASL12	ASL16
Coil operating limits acc. to IEC 60947-4-1		DC supply	0.85...1.1 x U <sub>c</sub> (at θ ≤ 60 °C); U <sub>c</sub> (at θ ≤ 70 °C)		
DC control voltage	Rated control circuit voltage U <sub>c</sub>		12...240 V DC		
		Coil consumption	3 W		
	Average pull-in value		3 W		
	Average holding value		3 W		
Drop-out voltage			Approx. 10...40 % of U <sub>c</sub>		
Coil time constant	Open	L/R	12 ms		
	Closed	L/R	40 ms		
Operating time					
Between coil energization and:	N.O. contact closing		36...59 ms		
	N.C. contact opening		31...53 ms		
Between coil de-energization and:	N.O. contact opening (1)		13...17 ms		
	N.C. contact closing (1)		15...20 ms		
(1) The use of RT5 surge suppressor increases opening time by a factor of 1.1 to 1.2					









### Mounting characteristics and conditions for use

Contactor types		AC operated	AS09	AS12	AS16
		DC operated	ASL09	ASL12	ASL16
Mounting positions					
Mounting distances			The contactors can be assembled side by side.		
Fixing	On rail according to IEC 60715, EN 60715		35 x 7.5 mm or 35 x 15 mm		
	By screws (not supplied)		2 x M4 screws placed diagonally		

# AS09 ... AS16 and ASL09 ... ASL16 3-pole contactors

## Technical data

### Connecting characteristics

Contactor types	AC operated	<b>AS09</b>	<b>AS12</b>	<b>AS16</b>
	DC operated	<b>ASL09</b>	<b>ASL12</b>	<b>ASL16</b>
Main terminals	 <p>Screw terminals with cable clamp</p>			
Connection capacity (min. ... max.)				
Main conductors (poles)				
 Rigid solid	1 x	0.75...4 mm <sup>2</sup>		
	2 x	0.75...4 mm <sup>2</sup>		
 Flexible with non insulated ferrule	1 x	0.75...2.5 mm <sup>2</sup>		
	2 x	0.75...2.5 mm <sup>2</sup>		
 Flexible with insulated ferrule	1 x	0.75...2.5 mm <sup>2</sup>		
	2 x	0.75...1.5 mm <sup>2</sup>		
 Bars or lugs	L ≤	7.7 mm		
	l >	3.2 mm		
Connection capacity acc. to UL / CSA	1 or 2 x	AWG 18...12		
Stripping length	9 mm			
Tightening torque	Recommended	1.00 Nm / 9 lb.in		
	Max.	1.20 Nm		
Auxiliary conductors (built-in auxiliary terminals + coil terminals)				
 Rigid solid	1 x	0.75...2.5 mm <sup>2</sup>		
	2 x	0.75...2.5 mm <sup>2</sup>		
 Flexible with non insulated ferrule	1 x	0.75...2.5 mm <sup>2</sup>		
	2 x	0.75...2.5 mm <sup>2</sup>		
 Flexible with insulated ferrule	1 x	0.75...2.5 mm <sup>2</sup>		
	2 x	0.75...1.5 mm <sup>2</sup>		
 Lugs	L ≤	7.7 mm		
	l >	3.2 mm		
Connection capacity acc. to UL / CSA	1 or 2 x	AWG 18...14		
Stripping length				
Tightening torque				
Coil terminals	Recommended	1.00 Nm / 9 lb.in		
	Max.	1.20 Nm		
Built-in auxiliary terminals	Recommended	1.00 Nm / 9 lb.in		
	Max.	1.20 Nm		
Degree of protection				
acc. to IEC 60947-1 / EN 60947-1 and IEC 60529 / EN 60529				
All terminals	IP20			
Screw terminals	Delivered in open position, screws of unused terminals must be tightened			
All terminals	M3			
Screwdriver type	Flat Ø 5.5 / Pozidriv 2			



## AS09 ... AS16 and ASL09 ... ASL16 3-pole contactors

### Technical data

#### Built-in auxiliary contacts according to IEC

Contactor types	AC operated	<b>AS09</b>	<b>AS12</b>	<b>AS16</b>
	DC operated	<b>ASL09</b>	<b>ASL12</b>	<b>ASL16</b>
Rated operational voltage U <sub>e</sub> max.		690 V		
Rated frequency (without derating)		50 / 60 Hz		
Conventional free-air thermal current I <sub>th</sub> - θ ≤ 40 °C		10 A		
I <sub>e</sub> / Rated operational current AC-15 acc. to IEC 60947-5-1	24-127 V 50/60 Hz	6 A		
	220-240 V 50/60 Hz	4 A		
	400-440 V 50/60 Hz	3 A		
	500 V 50/60 Hz	2 A		
	690 V 50/60 Hz	2 A		
Making capacity AC-15		10 x I <sub>e</sub> AC-15 acc. to IEC 60947-5-1		
Breaking capacity AC-15		10 x I <sub>e</sub> AC-15 acc. to IEC 60947-5-1		
I <sub>e</sub> / Rated operational current DC-13 acc. to IEC 60947-5-1	24 V DC	6 A / 144 W		
	48 V DC	2.8 A / 134 W		
	72 V DC	1 A / 72 W		
	110 V DC	0.55 A / 60 W		
	125 V DC	0.55 A / 69 W		
	220 V DC	0.27 A / 60 W		
	250 V DC	0.27 A / 68 W		
Short-circuit protection device gG type fuse		10 A		
Rated short-time withstand current I <sub>cw</sub>	for 1.0 s	100 A		
	for 0.1 s	140 A		
Minimum switching capacity with failure rate acc. to IEC 60947-5-4		12 V / 3 mA		
Non-overlapping time between N.O. and N.C. contacts		1.5 ms		
Power dissipation per pole at 6 A		0.1 W		
Max. electrical switching frequency	AC-15	1200 cycles/h		
	DC-13	900 cycles/h		
Mechanically linked contacts acc. to annex L of IEC 60947-5-1		Built-in N.O. or N.C. auxiliary contacts and additional N.O. or N.C. auxiliary contacts (CA3 aux. contact blocks) are mechanically linked contacts.		
Mirror contacts acc. to annex F of IEC 60947-4-1		Built-in N.C. auxiliary contacts or additional N.C. auxiliary contacts (CA3 aux. contact blocks) are mirror contacts.		

#### Built-in auxiliary contacts according to UL / CSA

Contactor types	AC operated	<b>AS09</b>	<b>AS12</b>	<b>AS16</b>
	DC operated	<b>ASL09</b>	<b>ASL12</b>	<b>ASL16</b>
Max. operational voltage		600 V AC, 250 V DC		
Pilot duty		A600, Q300		
AC thermal rated current		10 A		
AC maximum volt-ampere making		7200 VA		
AC maximum volt-ampere breaking		720 VA		
DC thermal rated current		2.5 A		
DC maximum volt-ampere making-breaking		69 VA		

—  
**Notes**

A large rectangular area filled with a grid of small, evenly spaced dotted lines, intended for handwritten notes.

# AS09 ... AS16 and ASL09 ... ASL16 3-pole contactors

## Electrical durability

### Electrical durability for AC-1 utilization category - $U_e \leq 690\text{ V}$

**Note:** AC-1 maximum current is selected according to ambient temperature. Please see technical data.

Switching non-inductive or slightly inductive loads. The breaking current  $I_c$  for AC-1 is equal to the rated operational current of the load. Maximum electrical switching frequency: 600 cycles / hour.

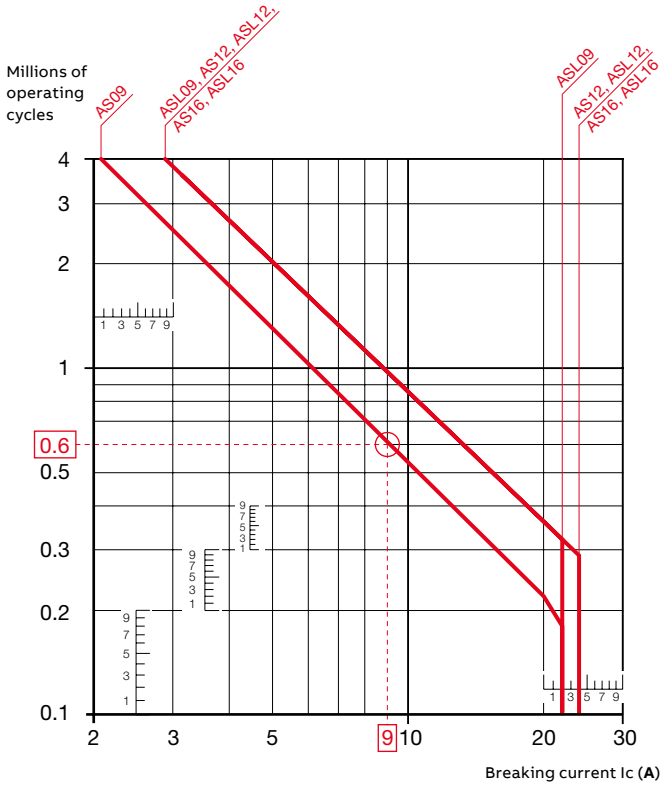

### Example:

Breaking current = 9 A.

On the opposite curve at intersection "O" 9 A the corresponding value for the electrical durability is approximately 0.6 millions operating cycles.

## AS09 ... AS16 and ASL09 ... ASL16 3-pole contactors

### Electrical durability

**Electrical durability for AC-3 utilization category -  $U_e \leq 440\text{ V}$  - Ambient temperature  $\leq 60\text{ }^\circ\text{C}$**

Switching cage motors: starting and switching off running motors. The breaking current  $I_c$  for AC-3 is equal to the rated operational current  $I_e$  ( $I_e$  = motor full load current). Maximum electrical switching frequency: 1200 cycles / hour.

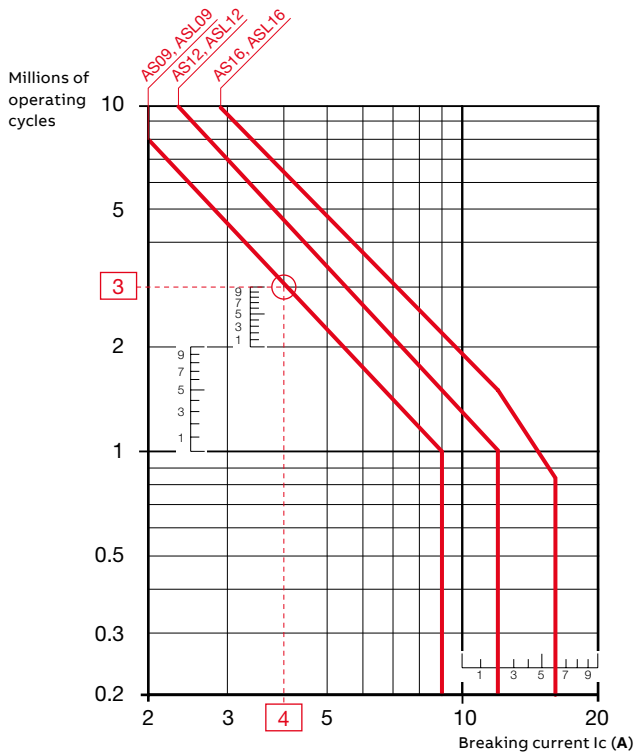

Example:

Breaking current = 4 A.

On the opposite curve at intersection "O" 4 A the corresponding value for the electrical durability is approximately 3 millions operating cycles.

# AS09 ... AS16 3-pole contactors

## Terminal marking and positioning

### AS contactors - AC operated

Standard devices without addition of auxiliary contacts

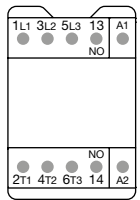

AS09 ... AS16-30-10

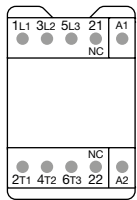

AS09 ... AS16-30-01

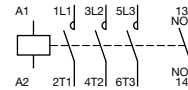

AS09 ... AS16-30-10

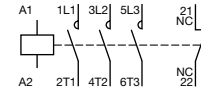

AS09 ... AS16-30-01

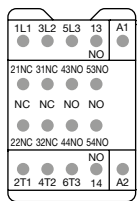

AS09 ... AS16-30-32

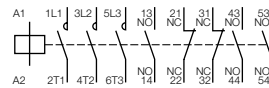

AS09 ... AS16-30-32

### Other possible contact combinations with auxiliary contact blocks added by the user

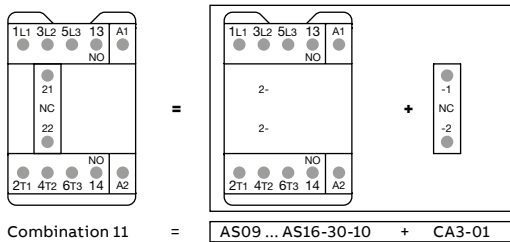

Combination 11

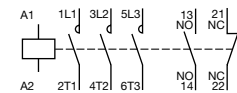

Combination 11

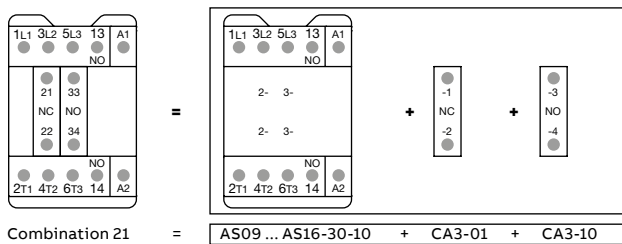

Combination 21

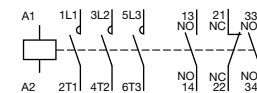

Combination 21

### CA3 1-pole auxiliary contact blocks

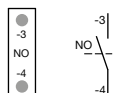

CA3-10

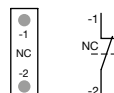

CA3-01

### TEF3 front-mounted electronic timer

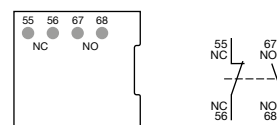

TEF3

# ASL09 ... ASL16 3-pole contactors

## Terminal marking and positioning

### ASL contactors - DC operated (the polarity A1+, A2- must be respected)

Standard devices without addition of auxiliary contacts

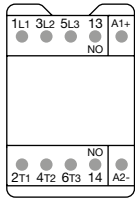

ASL09 ... ASL16-30-10

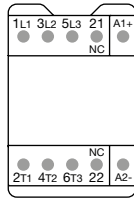

ASL09 ... ASL16-30-01

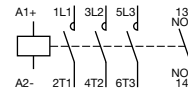

ASL09 ... ASL16-30-10

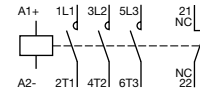

ASL09 ... ASL16-30-01

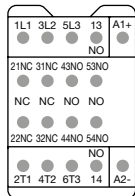

ASL09 ... ASL16-30-32

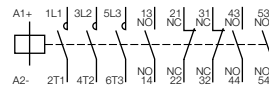

ASL09 ... ASL16-30-32

### Other possible contact combinations with auxiliary contact blocks added by the user

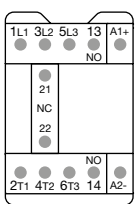

Combination 11

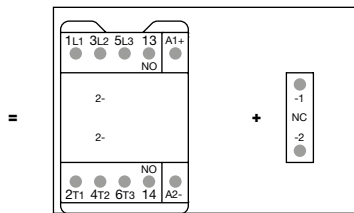

ASL09 ... ASL16-30-10 + CA3-01

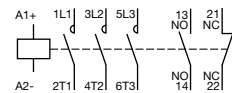

Combination 11

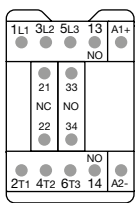

Combination 21

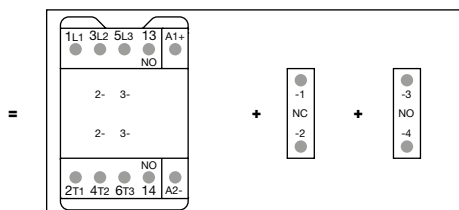

ASL09 ... ASL16-30-10 + CA3-01 + CA3-10

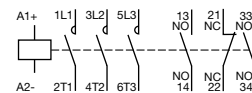

Combination 21

### CA3 1-pole auxiliary contact blocks

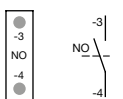

CA3-10

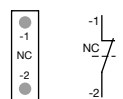

CA3-01

### TEF3 front-mounted electronic timer

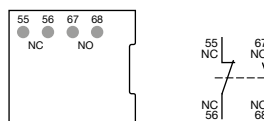

TEF3

# AS09 ... AS16 3-pole contactors

## Dimensions

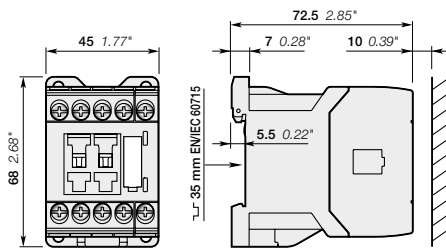

AS09, AS12, AS16

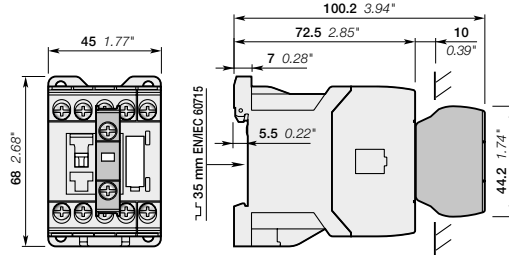

AS09, AS12, AS16  
+ CA3 front-mounted 1-pole auxiliary contact block

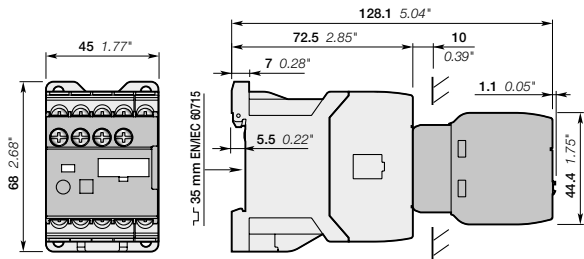
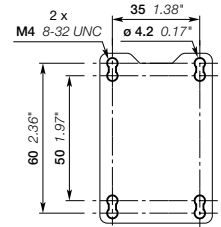

AS09, AS12, AS16  
+ TEF3 electronic timer

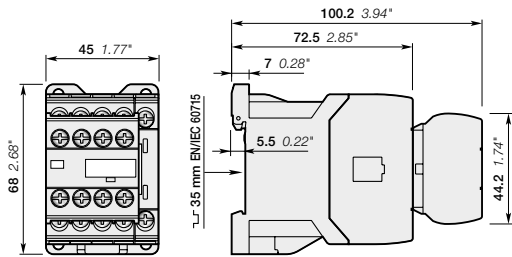

AS09 ... 16-30-32

Main dimensions mm, inches

# AS09 ... AS16 3-pole contactors

## Dimensions

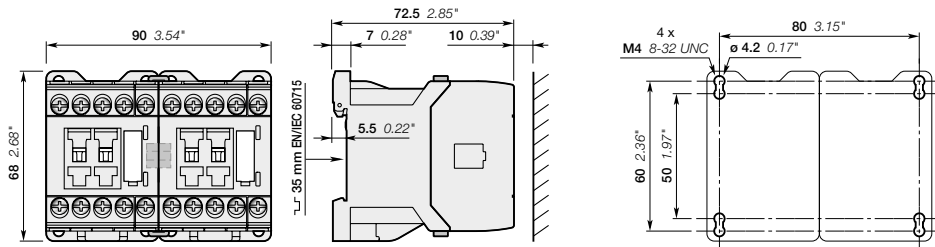

AS09, AS12, AS16  
+ VM3 mechanical interlock unit including two BB3 fixing clips

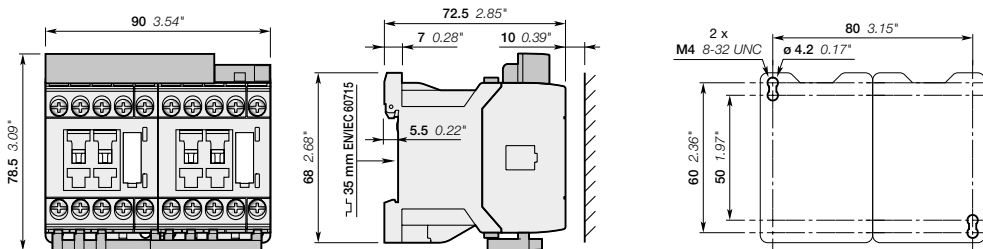

AS09, AS12, AS16  
+ BER16C-3 connection set for reversing starter including two BB3 fixing clips

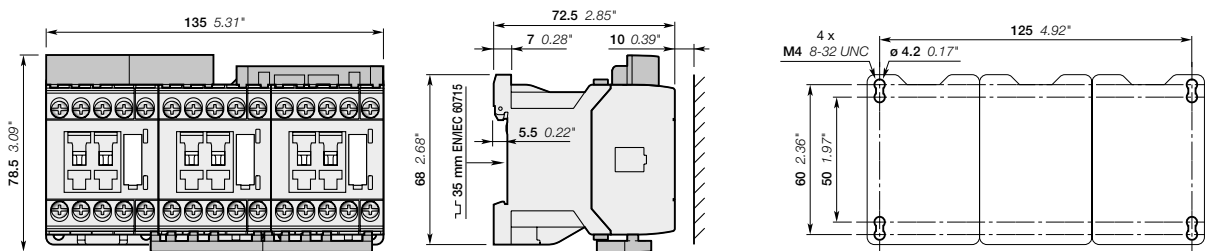

AS09, AS12, AS16  
+ BEY16C-3 connection set for star-delta starter including four BB3 fixing clips

Main dimensions mm, inches



# ASL09 ... ASL16 3-pole contactors

## Dimensions

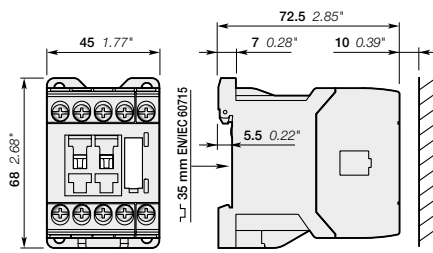

ASL09, ASL12, ASL16

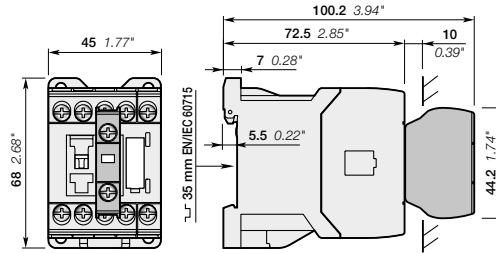

ASL09, ASL12, ASL16  
+ CA3 front-mounted 1-pole auxiliary contact block

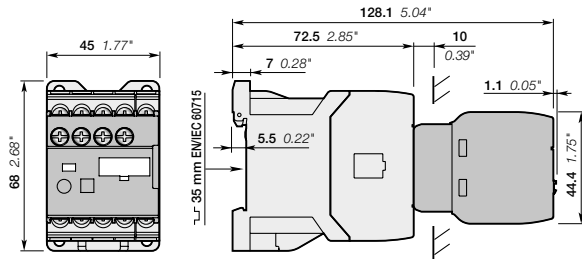
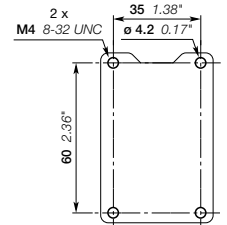

ASL09, ASL12, ASL16  
+ TEF3 electronic timer

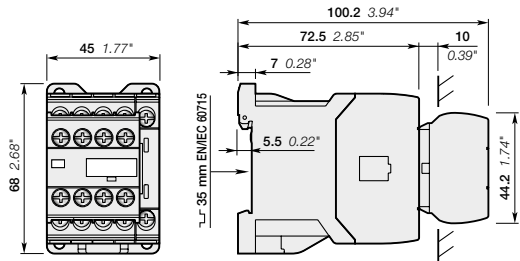

ASL09 ... 16-30-32

Main dimensions mm, inches

# ASL09 ... ASL16 3-pole contactors

## Dimensions

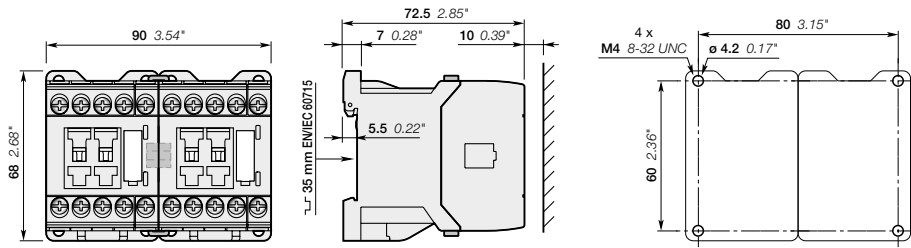

ASL09, ASL12, ASL16  
+ VM3 mechanical interlock unit including two BB3 fixing clips

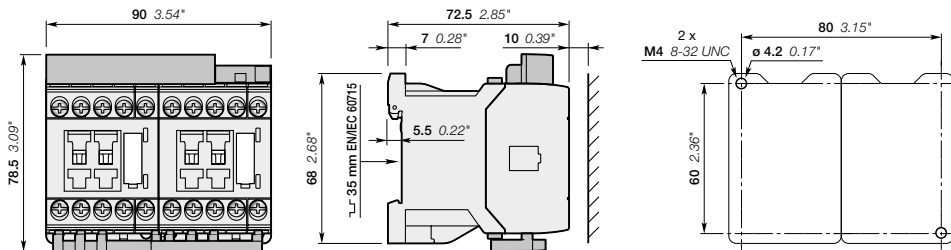

ASL09, ASL12, ASL16  
+ BER16C-3 connection set for reversing starter including two BB3 fixing clips

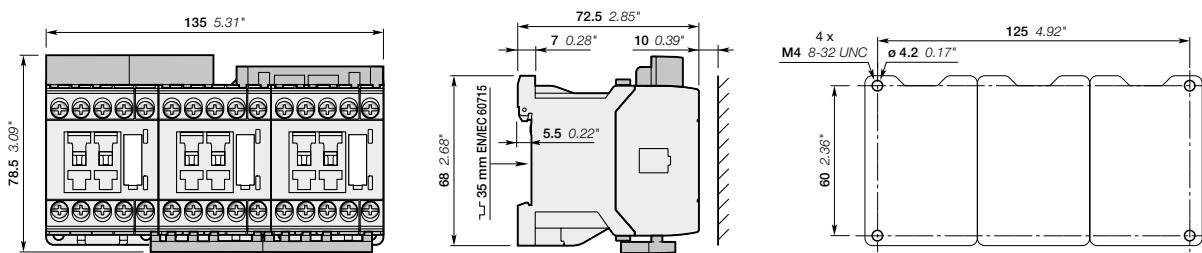

ASL09, ASL12, ASL16  
+ BEY16C-3 connection set for star-delta starter including four BB3 fixing clips

Main dimensions mm, inches

# Contactor relays

Main accessories

05



## 4-pole contactor relays

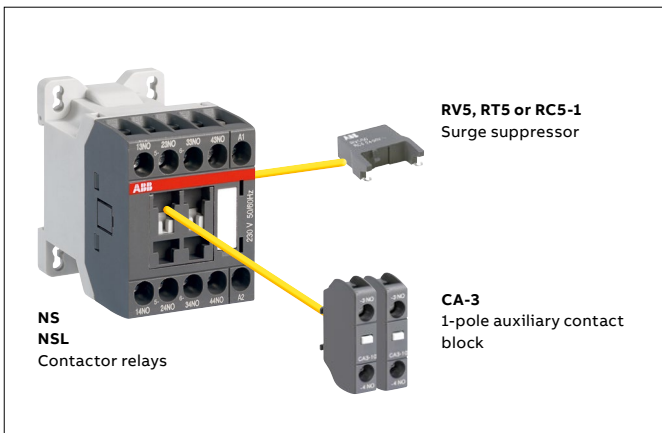

## 8-pole contactor relays

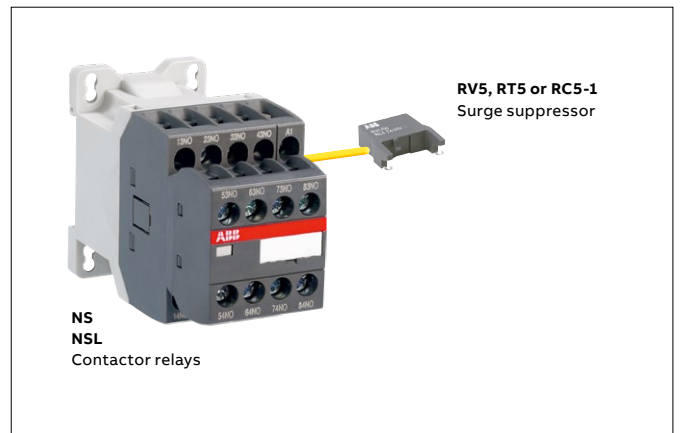

## Contactor relays



### Screw terminals



NS



NSL

	AC control voltage	<b>NS22E</b>	<b>NS31E</b>	<b>NS40E</b>
	DC control voltage	<b>NSL22E</b>	<b>NSL31E</b>	<b>NSL40E</b>
		2 N.O. + 2 N.C.	3 N.O. + 1 N.C.	4 N.O.



NS



NSL

	AC control voltage	<b>NS44E</b>	<b>NS53E</b>	<b>NS62E</b>	<b>NS71E</b>	<b>NS80E</b>
	DC control voltage	<b>NSL44E</b>	<b>NSL53E</b>	<b>NSL62E</b>	<b>NSL71E</b>	<b>NSL80E</b>
		4 N.O. + 4 N.C.	5 N.O. + 3 N.C.	6 N.O. + 2 N.C.	7 N.O. + 1 N.C.	8 N.O.

### Control circuit switching

IEC	Rated operational current AC-15	240 V	4 A
		400 V	3 A
		690 V	2 A
UL / CSA	Pilot Duty	24 V	6 A / 144 W
		250 V	0.27 A / 68 W

### Main accessories

Auxiliary contact blocks	Front mounting	1-pole CA3-10 or CA3-01	
Surge suppressors	Side-mounted (without additional width)	RV5 RC5-1 RT5	(Varistor) AC / DC (Capacitor) AC (Transil diode) DC

# NS contactor relays

## AC operated



NS22E

NS contactor relays are used for switching auxiliary and control circuits.

These contactor relays are designed with:

- 4 poles or 8 poles. Contactor relays have mechanically linked auxiliary contact elements (side-marked symbol)
- control circuit: AC operated
- add-on auxiliary contact blocks for front mounting and a comprehensive range of accessories.

Number of contacts		Rated control circuit voltage U <sub>c</sub> (1)		Type	Order code	Weight Pkg (1 pce) kg
1st stack	2nd stack	V 50 Hz	V 60 Hz			
		24	24	NS22E-20	1SBH101001R2022	0.220
		230	230	NS22E-26	1SBH101001R2622	0.220
		24	24	NS31E-20	1SBH101001R2031	0.220
		230	230	NS31E-26	1SBH101001R2631	0.220
		24	24	NS40E-20	1SBH101001R2040	0.220
		230	230	NS40E-26	1SBH101001R2640	0.220
		24	24	NS44E-20	1SBH101001R2044	0.260
		230	230	NS44E-26	1SBH101001R2644	0.260
		24	24	NS53E-20	1SBH101001R2053	0.260
		230	230	NS53E-26	1SBH101001R2653	0.260
		24	24	NS62E-20	1SBH101001R2062	0.260
		230	230	NS62E-26	1SBH101001R2662	0.260
		24	24	NS71E-20	1SBH101001R2071	0.260
		230	230	NS71E-26	1SBH101001R2671	0.260
		24	24	NS80E-20	1SBH101001R2080	0.260
		230	230	NS80E-26	1SBH101001R2680	0.260

Note: for multiple packaging, please contact your ABB local sales organization.  
 (1) Other control voltages see voltage code table.

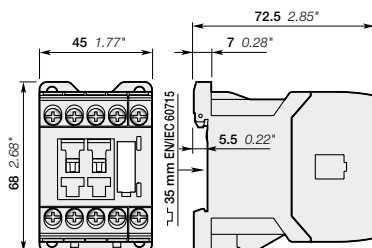

NS22E, NS31E, NS40E

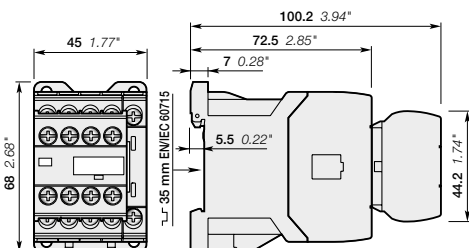

NS44E, NS53E, NS62E, NS71E, NS80E

Main dimensions mm, inches

# NSL contactor relays

DC operated



NSL22E

NSL contactor relays are used for switching auxiliary and control circuits.

These contactor relays are designed with:

- 4 poles or 8 poles. Contactor relays have mechanically linked auxiliary contact elements (side-marked symbol)
- control circuit: low coil consumption (3 W at pull-in and holding) DC operated with solid core magnet. Suitable for direct control by PLC outputs (the polarity on the coil terminals A1+ and A2- must be respected)
- add-on auxiliary contact blocks for front mounting and a comprehensive range of accessories.

Number of contacts		Rated control circuit voltage Uc (1) V DC	Type	Order code	Weight Pkg (1 pce) kg
1st stack	2nd stack				
		24	NSL22E-81	1SBH103001R8122	0.280
		24	NSL31E-81	1SBH103001R8131	0.280
		24	NSL40E-81	1SBH103001R8140	0.280
		24	NSL44E-81	1SBH103001R8144	0.320
		24	NSL53E-81	1SBH103001R8153	0.320
		24	NSL62E-81	1SBH103001R8162	0.320
		24	NSL71E-81	1SBH103001R8171	0.320
		24	NSL80E-81	1SBH103001R8180	0.320

Note: for multiple packaging, please contact your ABB local sales organization.

(1) Other control voltages see voltage code table.

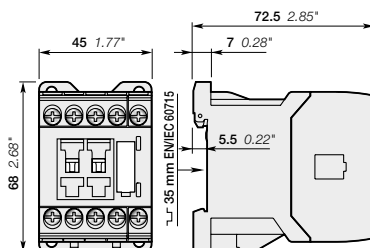

NSL22E, NSL31E, NSL40E

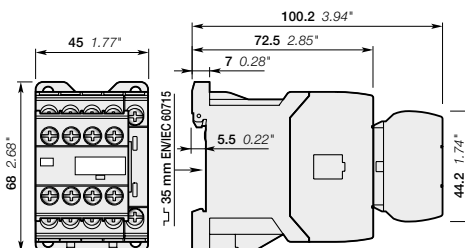

NSL44E, NSL53E, NSL62E, NSL71E, NSL80E

Main dimensions mm, inches

# NS and NSL contactor relays

## Main accessories

### Contactor relays and main accessories (other accessories available)

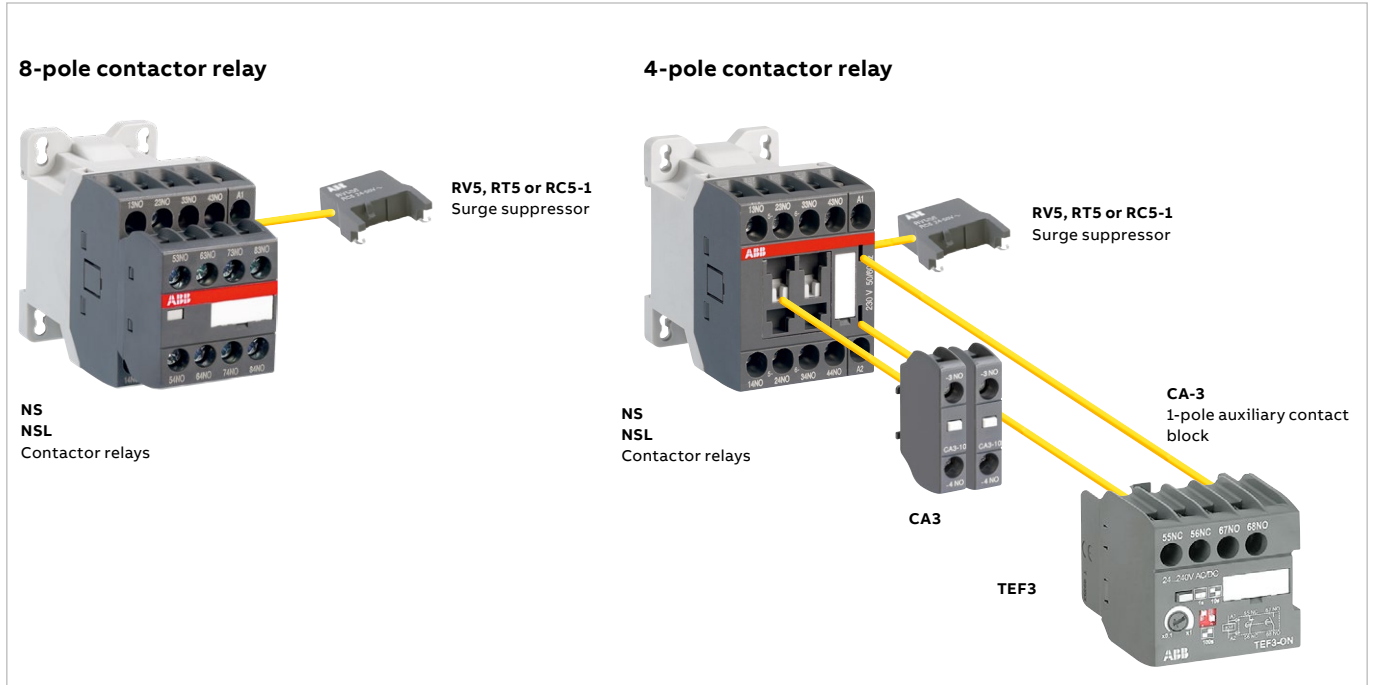

### Main accessory fitting details

Contactor types	Main poles	Front-mounted accessories		Side-mounted accessories	
		Auxiliary contact blocks	Electronic timer	Surge suppressors	
		1-pole CA3	TEF3		
NS..	2 2 E	2 max.	or 1	+ RV5	or RC5-1
NS..	3 1 E				
NS..	4 0 E				
NS..	4 4 E	-	-	RV5	or RC5-1
NS..	5 3 E				
NS..	6 2 E				
NS..	7 1 E				
NS..	8 0 E				
NSL..	2 2 E	2 max.	or 1	+ RV5	or RT5
NSL..	3 1 E				
NSL..	4 0 E				
NSL..	4 4 E	-	-	RV5	or RT5
NSL..	5 3 E				
NSL..	6 2 E				
NSL..	7 1 E				
NSL..	8 0 E				

# NS and NSL contactor relays

## Main accessories



CA3-10

### Front-mounted instantaneous auxiliary contact blocks

For contactor relays	Auxiliary contacts	Type	Order code	Pkg qty	Weight (1 pce)
					kg
NS, NSL	1 0	CA3-10	1SBN011010T1010	10	0.011
	0 1	CA3-01	1SBN011010T1001	10	0.011



TEF3-ON

### Front-mounted electronic timer

For contactors	Rated control circuit voltage - Uc	Type	Order code	Pkg qty	Weight (1 pce)
	V				kg

#### ON-delay

NS, NSL	24...240 V AC/DC	TEF3-ON	1SBN021012R1000	1	0.065
---------	------------------	---------	-----------------	---	-------

#### OFF-delay

NS, NSL	24...240 V AC/DC	TEF3-OFF	1SBN021014R1000	1	0.065
---------	------------------	----------	-----------------	---	-------



RV5

### Surge suppressors

For contactor relays	Rated control circuit voltage - Uc			Type	Order code	Pkg qty	Weight (1 pce)
	V	AC	DC				
NS, NSL	24...50	●	●	RV5/50	1SBN050010R1000	2	0.015
	50...133	●	●	RV5/133	1SBN050010R1001	2	0.015
	110...250	●	●	RV5/250	1SBN050010R1002	2	0.015
	250...440	●	●	RV5/440	1SBN050010R1003	2	0.015
NS	24...50	●	-	RC5-1/50	1SBN050100R1000	2	0.012
	50...133	●	-	RC5-1/133	1SBN050100R1001	2	0.012
	110...250	●	-	RC5-1/250	1SBN050100R1002	2	0.012
	250...440	●	-	RC5-1/440	1SBN050100R1003	2	0.012
NSL	12...32	-	●	RT5/32	1SBN050020R1000	2	0.015
	25...65	-	●	RT5/65	1SBN050020R1001	2	0.015
	50...90	-	●	RT5/90	1SBN050020R1002	2	0.015
	77...150	-	●	RT5/150	1SBN050020R1003	2	0.015
	150...264	-	●	RT5/264	1SBN050020R1004	2	0.015



## NS and NSL contactor relays

### Technical data

#### Contact utilization characteristics according to IEC

Contactor relay types	AC operated	<b>NS</b>
	DC operated	<b>NSL</b>
Standards	IEC 60947-5-1 and EN 60947-5-1	
Rated operational voltage U <sub>e</sub> max.	690 V	
Rated frequency (without derating)	50 / 60 Hz	
Conventional free-air thermal current I <sub>th</sub> - θ ≤ 40 °C	10 A	
I <sub>e</sub> / Rated operational current AC-15 acc. to IEC 60947-5-1	24-127 V 50/60 Hz	6 A
	220-240 V 50/60 Hz	4 A
	400-440 V 50/60 Hz	3 A
	500 V 50/60 Hz	2 A
	690 V 50/60 Hz	2 A
Making capacity AC-15	10 x I <sub>e</sub> AC-15 acc. to IEC 60947-5-1	
Breaking capacity AC-15	10 x I <sub>e</sub> AC-15 acc. to IEC 60947-5-1	
I <sub>e</sub> / Rated operational current DC-13 acc. to IEC 60947-5-1	24 V DC	6 A / 144 W
	48 V DC	2.8 A / 134 W
	72 V DC	1 A / 72 W
	110 V DC	0.55 A / 60 W
	125 V DC	0.55 A / 69 W
	220 V DC	0.27 A / 60 W
	250 V DC	0.27 A / 68 W
Short-circuit protection device for contactors U <sub>e</sub> ≤ 500 V AC - gG type fuse	10 A	
Rated short-time withstand current I <sub>cw</sub>	for 1.0 s	100 A
	for 0.1 s	140 A
Minimum switching capacity with failure rate acc. to IEC 60947-5-4	12 V / 3 mA	
	10 <sup>-7</sup>	
Non-overlapping time between N.O. and N.C. contacts	1.5 ms	
Power dissipation per pole at 6 A	0.1 W	
Max. electrical switching frequency	AC-15	1200 cycles/h
	DC-13	900 cycles/h
Mechanically linked contacts acc. to annex L of IEC 60947-5-1	Built-in N.O. or N.C. auxiliary contacts and additional N.O. or N.C. auxiliary contacts (CA3 aux. contact blocks) are mechanically linked contacts.	

#### Contact utilization characteristics according to UL / CSA

Contactor relay types	AC operated	<b>NS</b>
	DC operated	<b>NSL</b>
Standards	UL 508, CSA C22.2 N°14	
Max. operational voltage	600 V AC, 250 V DC	
Pilot duty	A600, Q300	
AC thermal rated current	10 A	
AC maximum volt-ampere making	7200 VA	
AC maximum volt-ampere breaking	720 VA	
DC thermal rated current	2.5 A	
DC maximum volt-ampere making-breaking	69 VA	

# NS and NSL contactor relays

## Technical data

### Magnet system characteristics for NS contactor relays

Contactor relay types	AC operated	<b>NS</b>	
Coil operating limits acc. to IEC 60947-5-1	AC supply	0.85...1.1 x U <sub>c</sub> (at θ ≤ 60 °C); U <sub>c</sub> (at θ ≤ 70 °C)	
AC control voltage	Rated control circuit voltage U <sub>c</sub>	at 50 Hz	24...415 V
		at 60 Hz	24...415 V
Coil consumption	Average pull-in value	50 Hz	33 VA
		60 Hz	33 VA
		50/60 Hz	33 VA
Average holding value		50 Hz	6.5 VA / 1.5 W
		60 Hz	5 VA / 1.2 W
		50/60 Hz	6.5 VA / 1.5 W
Drop-out voltage		Approx. 30...50 % of U <sub>c</sub>	
Operating time			
Between coil energization and:	N.O. contact closing	9...24 ms	
	N.C. contact opening	6...18 ms	
Between coil de-energization and:	N.O. contact opening (1)	5...19 ms	
	N.C. contact closing (1)	7...22 ms	
(1) The use of RC5-1 surge suppressor increases opening time by a factor of 2 to 3.			

### Magnet system characteristics for NSL contactor relays

Contactor relay types	DC operated	<b>NSL</b>	
Coil operating limits acc. to IEC 60947-5-1	DC supply	0.85...1.1 x U <sub>c</sub> (at θ ≤ 60 °C); U <sub>c</sub> (at θ ≤ 70 °C)	
DC control voltage	Rated control circuit voltage U <sub>c</sub>	Coil consumption	12...240 V DC
		Average pull-in value	3 W
		Average holding value	3 W
Drop-out voltage		Approx. 10...40 % of U <sub>c</sub>	
Coil time constant	Open	L/R	12 ms
	Closed	L/R	40 ms
Operating time			
Between coil energization and:	N.O. contact closing	36...59 ms	
	N.C. contact opening	31...53 ms	
Between coil de-energization and:	N.O. contact opening (1)	13...17 ms	
	N.C. contact closing (1)	15...20 ms	
(1) The use of RT5 surge suppressor increases opening time by a factor of 1.1 to 1.2.			

### Mounting characteristics and conditions for use

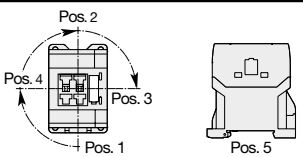
Contactor relay types	AC operated	<b>NS</b>
	DC operated	<b>NSL</b>
Mounting positions		
Mounting distances	The contactor relays can be assembled side by side.	
Fixing	On rail according to IEC 60715, EN 60715	35 x 7.5 mm or 35 x 15 mm
	By screws (not supplied)	2 x M4 screws placed diagonally



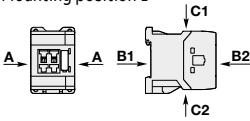

# NS and NSL contactor relays

## Technical data

### General technical data

Contactor relay types	AC operated	<b>NS</b>
	DC operated	<b>NSL</b>
Rated insulation voltage Ui acc. to IEC 60947-5-1		690 V
acc. to UL / CSA		600 V
Rated impulse withstand voltage Uimp.		6 kV
Ambient air temperature close to contactor relay		
Operation in free air		-40...+70 °C
Storage		-60...+80 °C
Climatic withstand		Category B according to IEC 60947-1 Annex Q
Maximum operating altitude (without derating)		3000 m
Mechanical durability		
Number of operating cycles		20 millions operating cycles
Max. switching frequency		3600 cycles/h
Shock withstand		1/2 sinusoidal shock for 11 ms: no change in contact position, closed or open position
acc. to IEC 60068-2-27 and EN 60068-2-27	Shock direction	NS contactor relays - AC operated
Mounting position 1		NSL contactor relays - DC operated
	A	20 g
	B1	5 g
	B2	15 g
	C1	19 g closed position / 8 g open position
	C2	16 g closed position / 13 g open position
		20 g closed position / 10 g open position
		15 g closed position / 5 g open position
		10 g
		19 g closed position / 8 g open position
		14 g closed position / 8 g open position
Vibration withstand acc. to IEC 60068-2-6		5...300 Hz / 3 g closed position / 2 g open position

### Connecting characteristics

Contactor relay types	AC operated	<b>NS</b>
	DC operated	<b>NSL</b>
Main terminals	 Screw terminals with cable clamp	
Connection capacity (min. ... max.)		
Pole and coil terminals		
 Rigid solid	1 x	0.75...2.5 mm <sup>2</sup>
	2 x	0.75...2.5 mm <sup>2</sup>
 Flexible with non insulated ferrule	1 x	0.75...2.5 mm <sup>2</sup>
	2 x	0.75...2.5 mm <sup>2</sup>
 Flexible with insulated ferrule	1 x	0.75...2.5 mm <sup>2</sup>
	2 x	0.75...1.5 mm <sup>2</sup>
 Lugs	L ≤	7.7 mm
	L >	3.2 mm
Connection capacity acc. to UL / CSA	1 or 2 x	AWG 18...14
Stripping length		9 mm
Tightening torque	Recommended	1.00 Nm / 9 lb.in
	Max.	1.20 Nm
Degree of protection	IP20	
acc. to IEC 60947-1 / EN 60947-1 and IEC 60529 / EN 60529		
All terminals	Delivered in open position, screws of unused terminals must be tightened	
Screw terminals	M3	
All terminals	Flat Ø 5.5 / Pozidriv 2	
Screwdriver type		

—  
**Notes**

A large rectangular area filled with a grid of small, light gray dotted lines, intended for handwritten notes.

# NS contactor relays

## Terminal marking and positioning

### NS contactor relays - AC operated

Standard devices without addition of auxiliary contact blocks

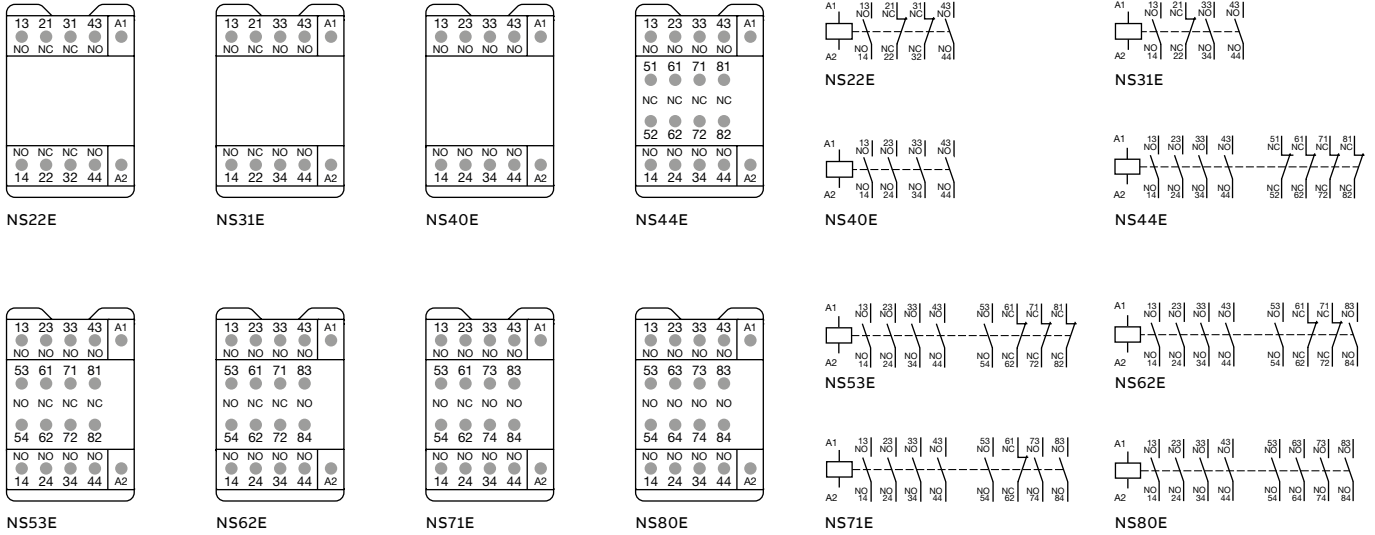

### Other possible contact combinations with auxiliary contact blocks added by the user

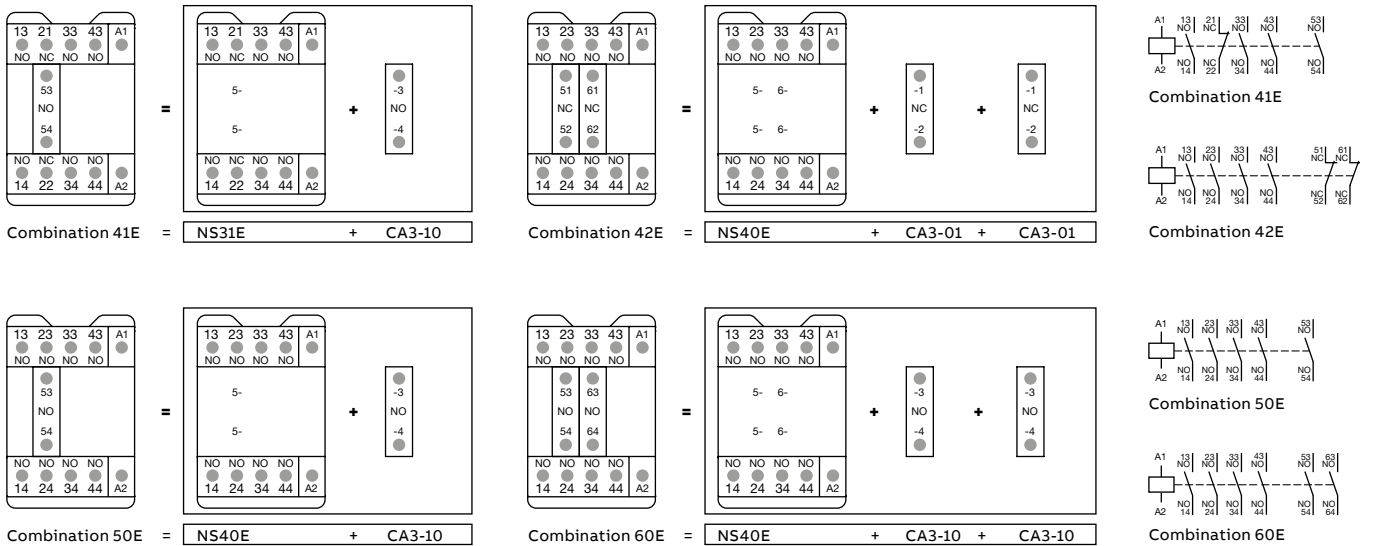

### CA3 1-pole auxiliary contact blocks



### TEF3 front-mounted electronic timer

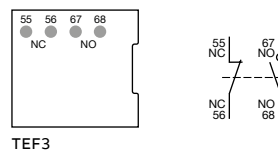

# NSL contactor relays

## Terminal marking and positioning

### NSL contactor relays - DC operated (the polarity A1+, A2- must be respected)

Standard devices without addition of auxiliary contact blocks

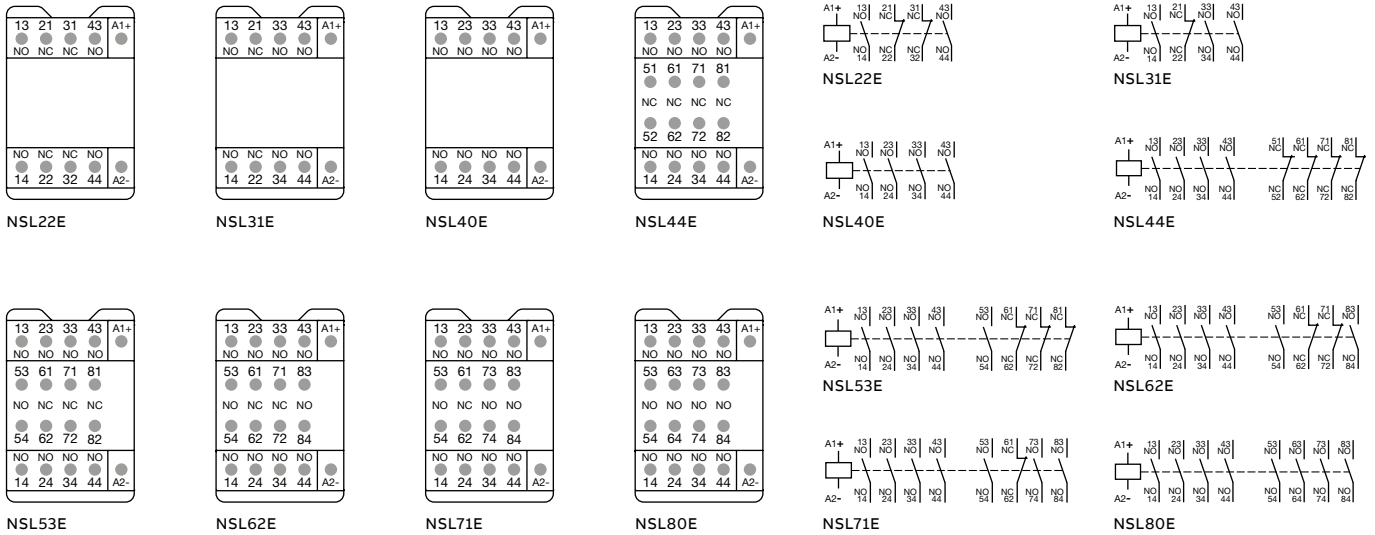

### Other possible contact combinations with auxiliary contact blocks added by the user

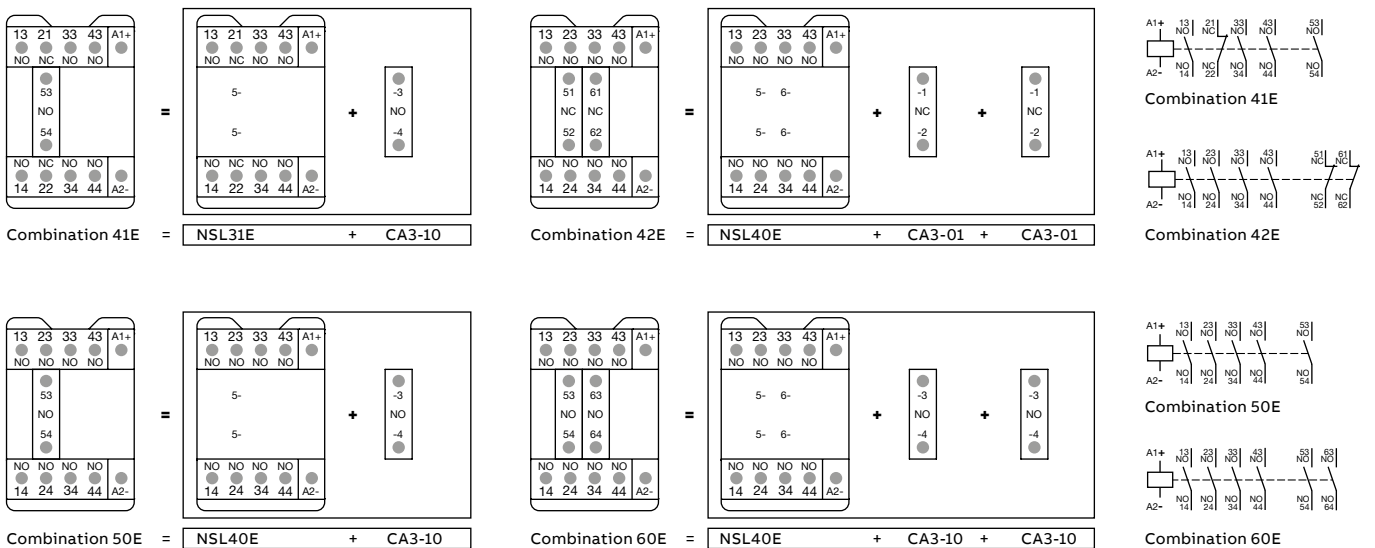

### CA3 1-pole auxiliary contact blocks



### TEF3 front-mounted electronic timer

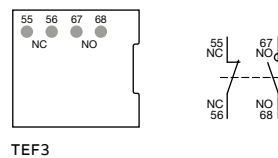

# NS contactor relays

## Dimensions

### 4-pole contactor relays

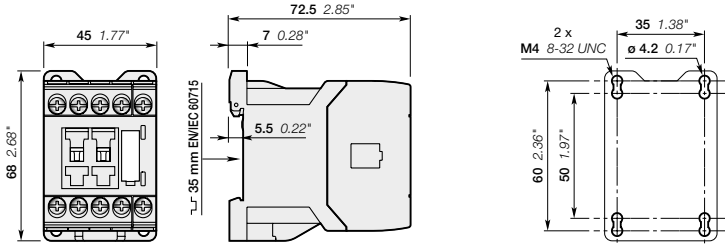

NS22E, NS31E, NS40E

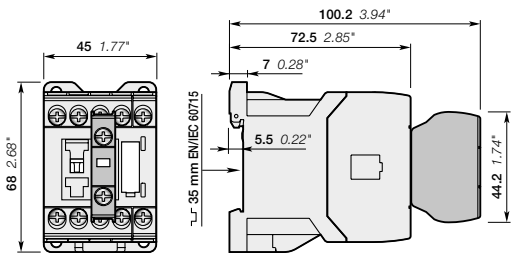

NS22E, NS31E, NS40E  
+ CA3 front-mounted 1-pole auxiliary contact block

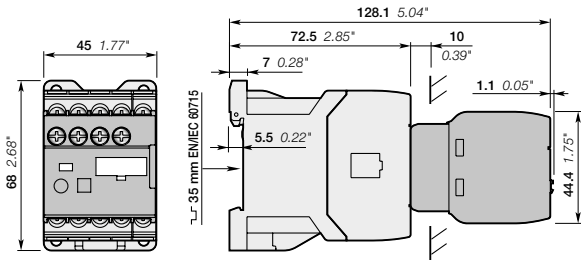

NS22E, NS31E, NS40E  
+ TEF3 electronic timer

### 8-pole contactor relays

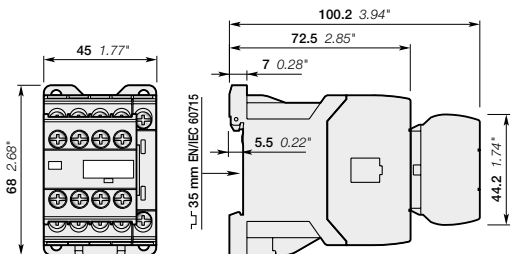

NS44E, NS53E, NS62E, NS71E, NS80E

Main dimensions mm, inches

# NSL contactor relays

## Dimensions

### 4-pole contactor relays

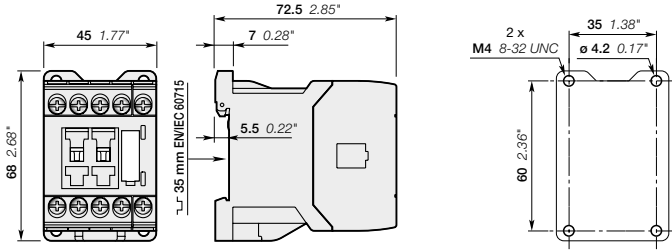

NSL22E, NSL31E, NSL40E

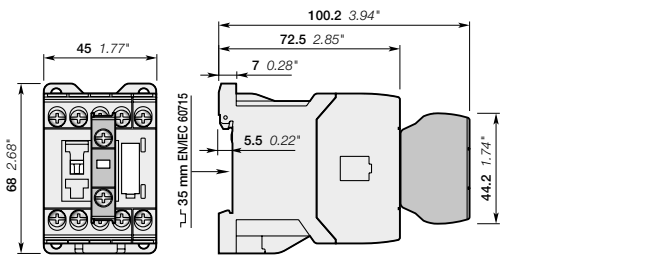

NSL22E, NSL31E, NSL40E  
+ CA3 front-mounted 1-pole auxiliary contact block

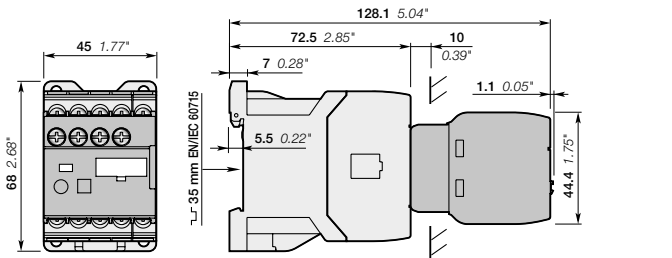

NSL22E, NSL31E, NSL40E  
+ TEF3 electronic timer

### 8-pole contactor relays

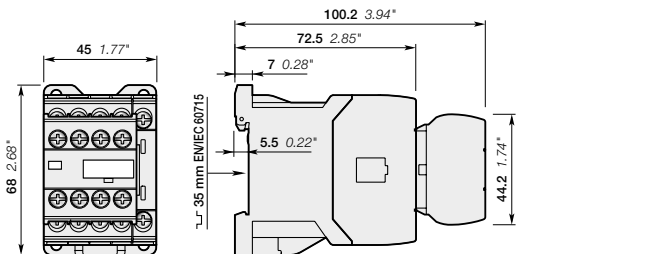

NSL44E, NSL53E, NSL62E, NSL71E, NSL80E

Main dimensions mm, inches



# Auxiliary contact blocks

## Accessories



CA3-10

The auxiliary contact blocks are used for the operation of auxiliary circuits and control circuits. CA3 1-pole auxiliary contact blocks, designed for standard industrial environments, are equipped with:

- N.O. or N.C. contacts.
- Screw-type connecting terminals with cage clamp delivered open.

All 1-pole auxiliary contact blocks are protected against accidental direct contact and bear the corresponding function marking.

A maximum of two 1-pole auxiliary contact blocks can be front-mounted on 1-stack contactors or 1-stack contactor relays.

For contactors	For contactor relays	Contact blocks	Type	Order code	Pkg qty	Weight (1 pce)
						kg

### 1-pole auxiliary contact blocks with screw terminals

AS09 ... AS16	NS, NSL	1 -	CA3-10	1SBN011010T1010	10	0.011
ASL09 ... ASL16		- 1	CA3-01	1SBN011010T1001	10	0.011

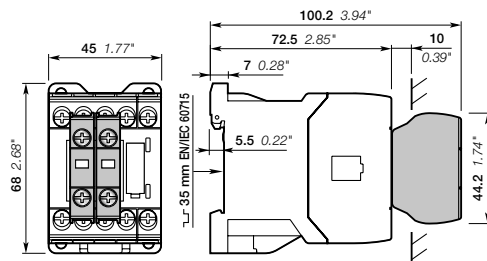

Main dimensions mm, inches

## Auxiliary contact blocks

### Technical data







#### Contact utilization characteristics according to IEC

Types		1-pole CA3														
Standards		IEC 60947-5-1 and EN 60947-5-1														
Rated insulation voltage $U_i$ acc. to IEC 60947-5-1		690 V														
Rated impulse withstand voltage $U_{imp}$		6 kV														
Rated operational voltage $U_e$ max.		690 V														
Conventional thermal current $I_{th} - \theta \leq 40^\circ\text{C}$		10 A														
le / Rated operational current AC-15 acc. to IEC 60947-5-1		<table border="1"> <tr> <td>24-127 V 50/60 Hz</td> <td>6 A</td> </tr> <tr> <td>220-240 V 50/60 Hz</td> <td>4 A</td> </tr> <tr> <td>400-440 V 50/60 Hz</td> <td>3 A</td> </tr> <tr> <td>500 V 50/60 Hz</td> <td>2 A</td> </tr> <tr> <td>690 V 50/60 Hz</td> <td>2 A</td> </tr> </table>	24-127 V 50/60 Hz	6 A	220-240 V 50/60 Hz	4 A	400-440 V 50/60 Hz	3 A	500 V 50/60 Hz	2 A	690 V 50/60 Hz	2 A				
24-127 V 50/60 Hz	6 A															
220-240 V 50/60 Hz	4 A															
400-440 V 50/60 Hz	3 A															
500 V 50/60 Hz	2 A															
690 V 50/60 Hz	2 A															
Making capacity		10 x le AC-15 acc. to IEC 60947-5-1														
Breaking capacity		10 x le AC-15 acc. to IEC 60947-5-1														
le / Rated operational current DC-13 acc. to IEC 60947-5-1		<table border="1"> <tr> <td>24 V DC</td> <td>6 A / 144 W</td> </tr> <tr> <td>48 V DC</td> <td>2.8 A / 134 W</td> </tr> <tr> <td>72 V DC</td> <td>1 A / 72 W</td> </tr> <tr> <td>110 V DC</td> <td>0.55 A / 60 W</td> </tr> <tr> <td>125 V DC</td> <td>0.55 A / 69 W</td> </tr> <tr> <td>220 V DC</td> <td>0.27 A / 60 W</td> </tr> <tr> <td>250 V DC</td> <td>0.27 A / 68 W</td> </tr> </table>	24 V DC	6 A / 144 W	48 V DC	2.8 A / 134 W	72 V DC	1 A / 72 W	110 V DC	0.55 A / 60 W	125 V DC	0.55 A / 69 W	220 V DC	0.27 A / 60 W	250 V DC	0.27 A / 68 W
24 V DC	6 A / 144 W															
48 V DC	2.8 A / 134 W															
72 V DC	1 A / 72 W															
110 V DC	0.55 A / 60 W															
125 V DC	0.55 A / 69 W															
220 V DC	0.27 A / 60 W															
250 V DC	0.27 A / 68 W															
Short-circuit protection device gG type fuse		10 A														
Rated short-time withstand current $I_{cw}$ $\theta = 40^\circ\text{C}$		<table border="1"> <tr> <td>for 1.0 s</td> <td>100 A</td> </tr> <tr> <td>for 0.1 s</td> <td>140 A</td> </tr> </table>	for 1.0 s	100 A	for 0.1 s	140 A										
for 1.0 s	100 A															
for 0.1 s	140 A															
Minimum switching capacity		12 V / 3 mA														
with failure rate acc. to IEC 60947-5-4		10-7														
Power dissipation per pole at 6 A		0.1 W														
Mechanical durability																
Number of operating cycles		10 millions operating cycles														
Max. switching frequency		3600 cycles/h														
Max. electrical switching frequency		<table border="1"> <tr> <td>AC-15</td> <td>1200 cycles/h</td> </tr> <tr> <td>DC-13</td> <td>900 cycles/h</td> </tr> </table>	AC-15	1200 cycles/h	DC-13	900 cycles/h										
AC-15	1200 cycles/h															
DC-13	900 cycles/h															
Mechanically linked contacts acc. to annex L of IEC 60947-5-1		Additional N.O. or N.C. auxiliary contacts (CA3) are mechanically linked contacts														
Mirror contacts acc. to annex F of IEC 60947-4-1		Additional N.C. auxiliary contacts (CA3) are mirror contacts														

#### Contact utilization characteristics according to UL / CSA

Standards		UL 508, CSA C22.2 N°14
Max. operational voltage		690 V AC, 250 V DC
Pilot duty		A600, Q300
AC thermal rated current		10 A
AC maximum volt-ampere making		7200 VA
AC maximum volt-ampere breaking		720 VA
DC thermal rated current		2.5 A
DC maximum volt-ampere making-breaking		69 VA

#### Connecting characteristics

Connection capacity (min. ... max.)		
	Rigid solid	1 x 0.75...2.5 mm <sup>2</sup>
		2 x 0.75...2.5 mm <sup>2</sup>
	Flexible with non insulated ferrule	1 x 0.75...2.5 mm <sup>2</sup>
		2 x 0.75...2.5 mm <sup>2</sup>
	Flexible with insulated ferrule	1 x 0.75...2.5 mm <sup>2</sup>
		2 x 0.75...1.5 mm <sup>2</sup>
	Lugs	L ≤ 7.7 mm
		l > 3.2 mm
Connection capacity acc. to UL / CSA		1 or 2 x AWG 18...14
Stripping length		9 mm
Tightening torque		1 Nm / 9 lb.in
	Recommended	
	Max.	1.20 Nm
Degree of protection acc. to IEC 60947-1 / EN 60947-1 and IEC 60529 / EN 60529		IP20
Screw terminals		Delivered in open position, screws of unused terminals must be tightened
All terminals		M3
Screwdriver type		Flat Ø 5.5 / Pozidriv 2

# Auxiliary contact blocks for AS09 ... AS16, ASL09 ... ASL16 contactors and NS, NSL contactor relays

## Electrical durability

### Electrical durability for AC-15 utilization category - $U_e \leq 400\text{ V}$

AC-15 utilization category according to IEC 60947-5-1 / EN 60947-5-1:

- making current:  $10 \times I_e$  with  $\cos \phi = 0.7$  and  $U_e$
- breaking current:  $I_e$  with  $\cos \phi = 0.4$  and  $U_e$ .

This curve represents the electrical durability of the built-in or add-on auxiliary contacts in relation to the breaking current.

The curve has been drawn for resistive and inductive loads up to 400 V:

- AS09 ... AS16 and ASL09 ... ASL16 contactor built-in auxiliary contacts
- 1-pole CA3
- NS and NSL contactor relays.

05

Millions of operating cycles

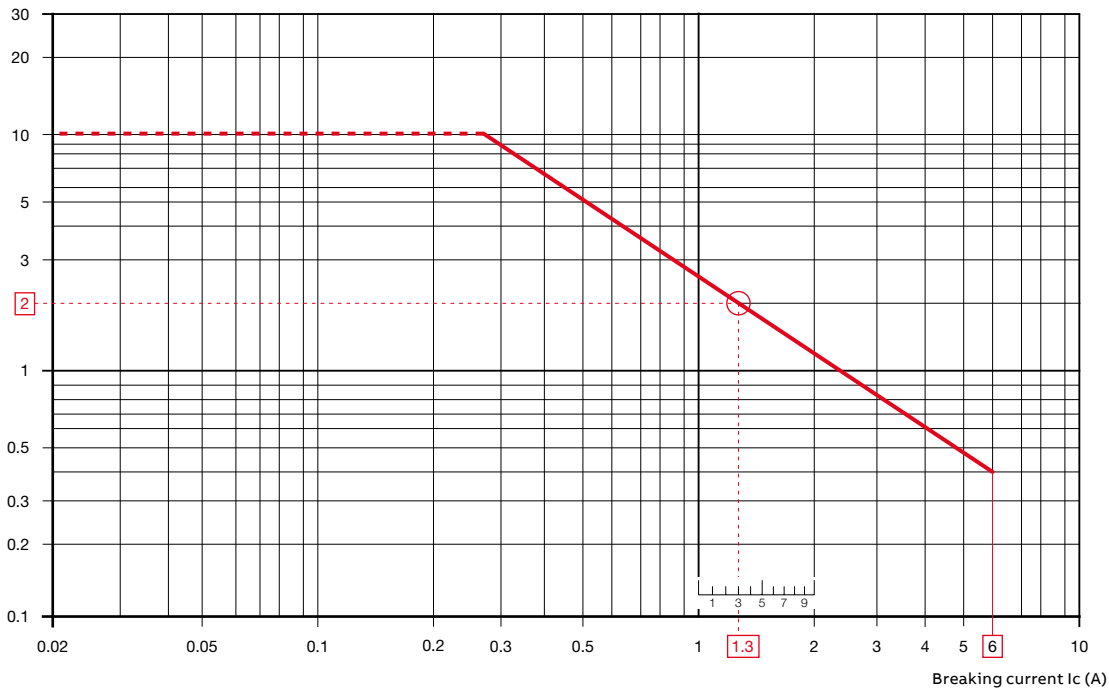

### Example:

Breaking current = 1.3 A

On the opposite curve at intersection "O" 1.3 A the corresponding value for the electrical durability is approximately 2 millions operating cycles.

# Electronic timers



TEF3-ON

1SBCL01337F0010



TEF3-OFF

1SBCL01336F0010

TEF3 frontal electronic timers are used for realizing timing function and are available in ON-delay and OFF-delay versions.

**Compact solution in cabinet compared to separate timers**

TEF3 electronic timers are front-mounted and locked on AS/ASL contactors or NS/NSL contactor relays. A mechanical indicator allows to show the state of the contactor.

**Safe and cost-reduced wiring**

TEF3 electronic timers are supplied by a direct plug-in parallel connection to the coil terminals A1 - A2 of the contactor or contactor relay. A varistor is integrated on the timer to offer a built-in protection against surges in the contactor coil.

**Available for a wide control voltage range 24...240 V AC/DC**

TEF3-ON or TEF3-OFF allow time-delayed functions up to 100 s in 3 distinct time ranges, independently of the control system. The time delay ranges are selected by a switch and the time delay can be adjusted by means of a rotary switch. The timing function is activated by closing or opening the device on which the timer is mounted. The OFF-delay version operates without additional control supply.

For contactors, contactor relays	Time delay range selected by switch	Delay type	Rated control circuit voltage Uc V 50/60 Hz or DC	Auxiliary contacts 	Type	Order code	Weight Pkg (1 pce) kg
AS09 ... AS16	0.1...1 s	ON-delay	24...240	1 1	TEF3-ON	1SBN021012R1000	0.065
ASL09 ... ASL16 NS, NSL	1...10 s 10...100 s	OFF-delay	24...240	1 1	TEF3-OFF	1SBN021014R1000	0.065

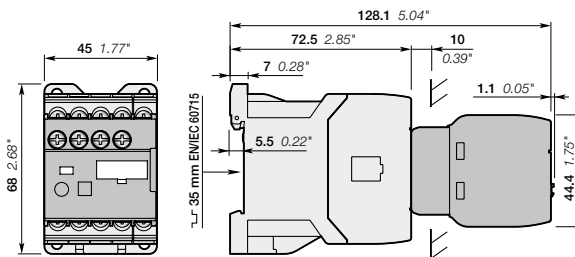

Main dimensions mm, inches

05

1SBCL0150450201

# Electronic timers

## Technical data

### Contact utilization characteristics according to IEC

Types	TEF3-ON	TEF3-OFF
Standards	IEC 60947-5-1 and EN 60947-5-1	
Rated insulation voltage $U_i$ acc. to IEC 60947-5-1	400 V	
Rated impulse withstand voltage $U_{imp}$	4 kV	
Rated operational voltage $U_e$ max.	240 V	
Rated frequency (without derating)	50 / 60 Hz	
Conventional thermal current $I_{th} - \theta \leq 40^\circ C$	5 A	
$I_e$ / Rated operational current AC-15 acc. to IEC 60947-5-1	24-127 V 50/60 Hz 3 A	220-240 V 50/60 Hz 1.5 A
Making capacity acc. to IEC 60947-5-1	10 x $I_e$ AC-15	
Breaking capacity acc. to IEC 60947-5-1	10 x $I_e$ AC-15	
$I_e$ / Rated operational current DC-13 acc. to IEC 60947-5-1	24 V DC 1 A / 24 W	
Short-circuit protection device gG type fuse	6 A	
Rated short-time withstand current $I_{cw}$ $\theta = 40^\circ C$	for 1.0 s 8 A	for 0.1 s 8 A
Minimum switching capacity with failure rate acc. to IEC 60947-5-4	24 V DC 12 V / 3 mA	10-7
Power dissipation per pole at 3 A	0.1 W	
Function diagram	ON-delay	OFF-delay
	Bistable relay inside. Before use, once apply $U_c$ then switch it off in order to initialize position of the contacts.	
Control circuit voltage		
AC control voltage	Rated control circuit voltage $U_c$ 50/60 Hz	24...240 V AC
	Average consumption	1.5 mA RMS
DC control voltage	Rated control circuit voltage $U_c$	24...240 V DC
	Average consumption	1.5 mA
Rated frequency limits	50 / 60 Hz	
Supply voltage range	0.85...1.1 x $U_c$ (at $\theta \leq 70^\circ C$ )	
Overvoltage protection	Varistor included	
Time delay range (t) selected by switch	0.1...1 s <input type="checkbox"/>	
	1...10 s <input type="checkbox"/>	
	10...100 s <input type="checkbox"/>	
On-load reiteration accuracy under constant conditions	$\leq 1\%$	
Minimum ON period	0.1 s	1 s
Recovery time	0.15 s	0.1 s
Ambient air temperature	Operation	-25 °C ... +70 °C
	Storage	-40 °C ... +80 °C
Climatic withstand	Category B according to IEC 60947-1 Annex Q	
Maximum operating altitude	2000 m	
Mounting positions	Mounting positions 1, 1 +/- 30°, 2, 3, 4, 5	
Shock withstand acc. to IEC 60068-2-27 and EN 60068-2-27 (Mounting position 1)	1/2 sinusoidal shock for 11 ms: no change in contact position Same as contactor or contactor relay	
Vibration withstand acc. to IEC 60068-2-6	5...300 Hz 3 g closed position / 2 g open position	
Mechanical durability		
	Number of operating cycles	5 millions operating cycles
	Max. switching frequency	3600 cycles/h
Max. electrical switching frequency	AC-15	1200 cycles/h
	DC-13	900 cycles/h







# Electronic timers

## Technical data

### Contact utilization characteristics according to UL / CSA

Types	TEF3-ON	TEF3-OFF
Standards	UL 508, CSA C22.2 N°14	
Rated insulation voltage Ui acc. to UL / CSA	300 V	
Max. operational voltage	240 V	
Pilot duty	B300, R300	
AC thermal rated current	5 A	
AC maximum volt-ampere making	3600 VA	
AC maximum volt-ampere breaking	360 VA	
DC thermal rated current	1 A	
DC maximum volt-ampere making-breaking	28 VA	

### Connecting characteristics

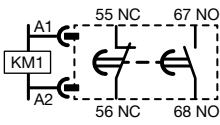
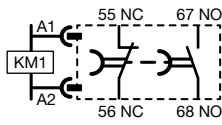
Connection capacity (min. ... max.)		
 Rigid solid	1 x	0.75...2.5 mm <sup>2</sup>
 Rigid solid	2 x	0.75...2.5 mm <sup>2</sup>
 Flexible with non insulated ferrule	1 x	0.75...2.5 mm <sup>2</sup>
 Flexible with non insulated ferrule	2 x	0.75...2.5 mm <sup>2</sup>
 Flexible with insulated ferrule	1 x	0.75...2.5 mm <sup>2</sup>
 Flexible with insulated ferrule	2 x	0.75...1.5 mm <sup>2</sup>
 Lugs	L ≤	7.7 mm
	l >	3.2 mm
Connection capacity acc. to UL / CSA	1 or 2 x	AWG 18...14
Stripping length		9 mm
Tightening torque	Recommended	1 N.m / 9 lb.in
	Max.	1.20 N.m
Degree of protection acc. to IEC 60947-1 / EN 60947-1 and IEC 60529 / EN 60529		IP20
Screw terminals		Delivered in open position, screws of unused terminals should be tightened
All terminals		M3
Screwdriver type		Flat Ø 5.5 / Pozidriv 2
Terminal Marking		 

### Electrical durability for DC-13 utilization category

DC-13 utilization category according to IEC 60947-5-1 / EN 60947-5-1 : making and breaking current Ie and Ue.

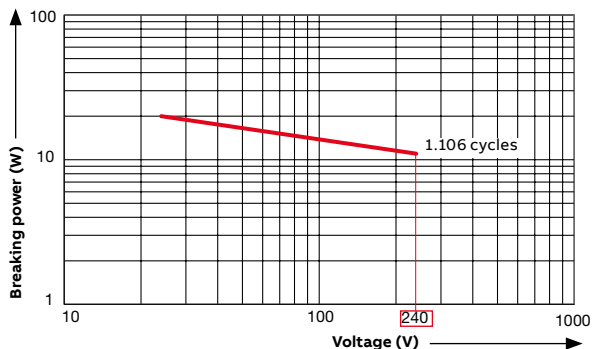

## Surge suppressors for contactor coils

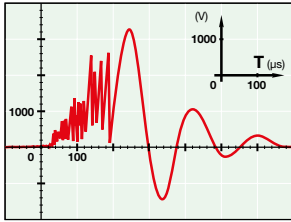

The operation of inductive circuits causes overvoltages, in particular on opening the contactor coil. The electromagnetic energy stored in the coil during contactor closing is restored on opening in the form of surges, the slope and amplitude of which may rise to several kilovolts. A number of drawbacks are observed ranging from interference on the electronic devices to the breakdown of insulators and even the destruction of certain sensitive components.

The graph opposite reproduces the oscillogram showing voltage discharges at the terminals of a 42 V / 50 Hz coil without peak clipping. The coil was switched by 8 series-connected poles of a contactor relay.

Following a burst of discharges with a very steep slope, a damped oscillation emerges with a peak value of 3500 V.

### Overvoltage Factor

The overvoltage factor  $k$  is defined as the ratio of the maximum overvoltage peak value  $\hat{U}_s$  to the peak value  $\hat{U}_c$  of the coil rated control voltage  $U_c$ :

$$k = \frac{\hat{U}_s \text{ max.}}{\hat{U}_c} \quad \text{in DC} \quad k = \frac{\hat{U}_s \text{ max.}}{U_c} \quad \text{in AC} \quad k = \frac{\hat{U}_s \text{ max.}}{U_c \sqrt{2}}$$

For example the following is obtained for the above graph:  $k = \frac{3500}{42 \sqrt{2}} \approx 60$

To reduce the harmful effects of these overvoltages, ABB has developed a range of surge suppressors designed to reduce the  $k$  factor defined above and to limit or even completely eliminate the high pre-damping voltage frequencies.

Each case is different, but the technical data tolerances and generous sizing of parts have enabled us to reduce the number of variants.

We have chosen the following solutions: transil diodes, varistors and RC blocks.

Note: A varistor is a resistor whose value decreases to a very large extent when a certain voltage is applied at its terminals.



RV5



RC5-1



RT5

For contactors	For contactor relays	Rated control circuit voltage - $U_c$		Type	Order code	Pkg qty	Weight (1 pce) kg
		V	AC DC				
AS, ASL	NS, NSL	24...50	● ●	RV5/50	1SBN050010R1000	2	0.015
		50...133	● ●	RV5/133	1SBN050010R1001	2	0.015
		110...250	● ●	RV5/250	1SBN050010R1002	2	0.015
		250...440	● ●	RV5/440	1SBN050010R1003	2	0.015
AS	NS	24...50	● -	RC5-1/50	1SBN050100R1000	2	0.012
		50...133	● -	RC5-1/133	1SBN050100R1001	2	0.012
		110...250	● -	RC5-1/250	1SBN050100R1002	2	0.012
		250...440	● -	RC5-1/440	1SBN050100R1003	2	0.012
ASL	NSL	12...32	- ●	RT5/32	1SBN050020R1000	2	0.015
		25...65	- ●	RT5/65	1SBN050020R1001	2	0.015
		50...90	- ●	RT5/90	1SBN050020R1002	2	0.015
		77...150	- ●	RT5/150	1SBN050020R1003	2	0.015
		150...264	- ●	RT5/264	1SBN050020R1004	2	0.015

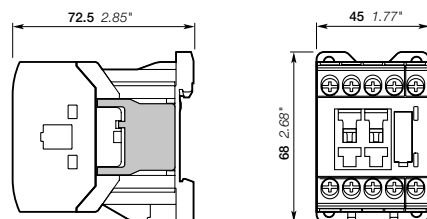

Main dimensions mm, inches

**Easy connection to the coil terminals**  
(parallel mounting)  
Clip-on for both fixing and connection.

**No additional space**  
Clipped onto the right side part of the contactor base without changing contactor overall dimensions and keeping a free access to coil terminals.

# Surge suppressors for contactor coils

## Technical data

Varistor	RV5/50	RV5/133	RV5/250	RV5/440
Rated control circuit voltage $U_c$	24...50 V AC 24...50 V DC	50...133 V AC 50...133 V DC	110...250 V AC 110...250 V DC	250...440 V AC 250...440 V DC
Residual overvoltage (clipping voltage)	132 V AC 132 V DC	270 V AC 270 V DC	480 V AC 480 V DC	825 V AC 825 V DC
Opening time growth factor	none			
Operating temperature	-20...+70 °C			
Advantages	High energy absorption: good damping - Unpolarized system.			
Drawback	Clipping as from $U_{vdr}$ *, thus voltage front up to this point.			
	* $U_{vdr}$ = Varistor operating voltage (voltage dependent resistor), tolerance $\pm 10\%$ .			

RC type	RC5-1/50	RC5-1/133	RC5-1/250	RC5-1/440
Rated control circuit voltage $U_c$	24...50 V AC	50...133 V AC	110...250 V AC	250...440 V AC
Residual overvoltage (clipping voltage)	2 to 3 x $U_c$ max.			
Opening time growth factor	2...3			
Operating temperature	-20...+70 °C			
Advantages	Very fast clipping - Attenuation of steep fronts and thus of high frequencies.			

Transil diode	RT5/32	RT5/65	RT5/90	RT5/150	RT5/264
Rated control circuit voltage $U_c$	12...32 V DC	25...65 V DC	50...90 V DC	77...150 V DC	150...264 V DC
Residual overvoltage (clipping voltage)	50 V DC	100 V DC	150 V DC	210 V DC	390 V DC
Opening time growth factor	1.1...1.2				
Operating temperature	-20...+70 °C				
Advantages	Good energy absorption - Unpolarized system - Simple, reliable system.				
Drawback	Delay on drop out which does not however reduce contactor breaking capacity.				

### Wiring diagrams

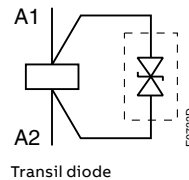
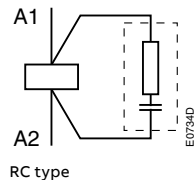
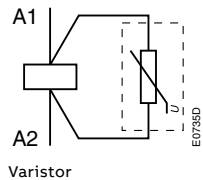



## Mechanical interlock unit and other accessories

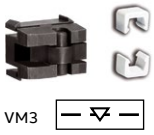

VM3



### Mechanical interlock unit

When mounted between two contactors without additional width, the VM3 mechanical interlock unit prevents one of the contactors from closing as long as the other contactor is closed.

The mechanical interlock unit includes 2 fixing clips.

For contactors		Type	Order code	Pkg qty	Weight (1 pce) kg
Left	Right	VM3	1SBN031005T1000	10	0.002
AS	AS				
ASL	ASL				

Note : VM3 mechanical durability, 5 millions of operating cycles on both reversing contactors.

### Fixing clips

BB3 is a set of 50 fixing clips.

For contactors	Type	Order code	Pkg qty	Weight (1 pce) kg
AS, ASL	BB3	1SBN111020R1000	1	0.009

### Test block

BDT4 test block is suitable for switching on contactor off-load.

Marking on the block indicates the contactor type to fit with.

For contactors	Type	Order code	Pkg qty	Weight (1 pce) kg
AS, ASL, NS, NSL	BDT4	1SBN110122T1000	10	0.007

### Function markers

Box of 16 blank cards (16 markers by card) printable on HTP500 thermal transfer printer and AMS 500 marking table to identify your contactors, overload relays or manual motor starters.

Marker dimensions: 7 x 20 mm (.276" x .787").

For contactors	Type	Order code	Pkg qty	Weight (1 pce) kg
AS, ASL, NS, NSL	BA4	1SNA235156R2700	16	0.011
AMS 500 support plate for 8 BA4	SPRC 1	1SNA360010R1500	1	0.220
HTP500 support plate	HTP500-BA4	1SNA235712R2400	1	0.290



BDT4



BA4

1SNC160101F0014

## Connection accessories for starting solutions

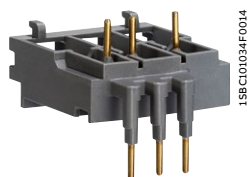

BEA16-3

### Connecting links

The BEA16-3 insulated 3-pole connecting links are used to connect an AC or DC operated contactors with manual motor starters.

The connecting links ensure the electrical and mechanical connection between the contactor and the manual motor starter.

For contactors	Manual motor starter	Type	Order code	Pkg qty	Weight (1 pce) kg
AS09 ... AS16 ASL09 ... ASL16	MS116-0.16 ... MS116-16 MS132-0.16 ... MS132-16	BEA16-3	1SBN081006T1000	10	0.019

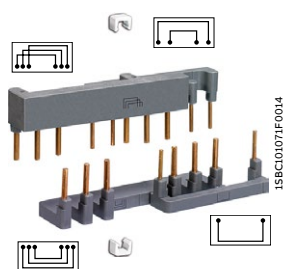

BER16C-3

### Connection sets for reversing contactors

The BER16C-3 connection sets are used for the connections between the main poles of two 3-pole contactors mounted side by side as reversing contactors, including electrical interlocking between built-in N.C. auxiliary contact and coil terminals.

The connection sets are made up of:

- 1 upstream and 1 downstream connections: insulated, solid copper bars,
- 2 connections to realize electrical interlocking between contactors equipped with built-in N.C. auxiliary contacts,
- 2 fixing clips.

For contactors	Mechanical interlock unit	Type	Order code	Pkg qty	Weight (1 pce) kg
2 x AS09 ... AS16 2 x ASL09 ... ASL16	with or without VM3	BER16C-3	1SBN081012R1000	1	0.035

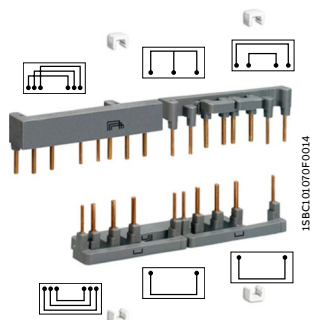

BEY16C-3

### Connection sets for star-delta starting

BEY16C-3 connection sets are designed for star-delta starters whose contactors are assembled according to line delta star mounting.

The connection sets are made up of:

- Line contactor / delta contactor: upstream phase-to-phase connection,
- Delta contactor / star contactor: downstream connection in parallel,
- Star contactor: star point upstream,
- An electrical interlocking between delta and star contactors equipped with built-in N.C. auxiliary contacts,
- 4 fixing clips.

For contactors			Mech. interlock unit between star & delta contactors	Type	Order code	Pkg qty	Weight (1 pce) kg
Line	Delta	Star	with or without VM3	BEY16C-3	1SBN081018R2000	1	0.041
AS09	AS09	AS09					
AS12	AS12	AS09					

# Voltage code table

The below tables indicate the available coil voltages and corresponding digits for order codes. When placing an order, please give either type or order code. Select a standard contactor from ordering detail pages. Change the coil voltage code in the type or in the order code according to the table below. Example: for contactor AS09-30-10 and coil 42 V 50/60 Hz, type is AS09-30-10-21 and order code is 1SBL101001R2110.

## 3-pole contactors

**Type**

**AS16 - 30 - 10 - 26**

**Contactor type**

**AS** AC operated  
**ASL** DC operated

**Order code**

**1SBL121001R 26 10**

20	24 V 24 V	
21	42 V 42 V	
22	48 V 48 V	
23	110 V	110 V
24	115 V	115 V
16	- 120 V	
25	220 V	220 V
26	230 V	230 V
27	240 V	240 V
17	- 277 V	
13	380 V	-
28	400 V	400 V
29	415 V	415 V

<b>80</b>	12 V
81	24 V
83	48 V
84	60 V
86	110 V
87	125 V
88	220 V
89	240 V

## Contactor relays

**Type**

**NS 40 E - 26**

**Contactor type**

**NS** AC operated  
**NSL** DC operated

**Order code**

**1SBH101001R 26 40**

20	24 V 24 V	
21	42 V 42 V	
22	48 V 48 V	
23	110 V	110 V
24	115 V	115 V
16	- 120 V	
25	220 V	220 V
26	230 V	230 V
27	240 V	240 V
17	- 277 V	
13	380 V	-
28	400 V	400 V
29	415 V	415 V

<b>80</b>	12 V
81	24 V
83	48 V
84	60 V
86	110 V
87	125 V
88	220 V
89	240 V

---

# Notes

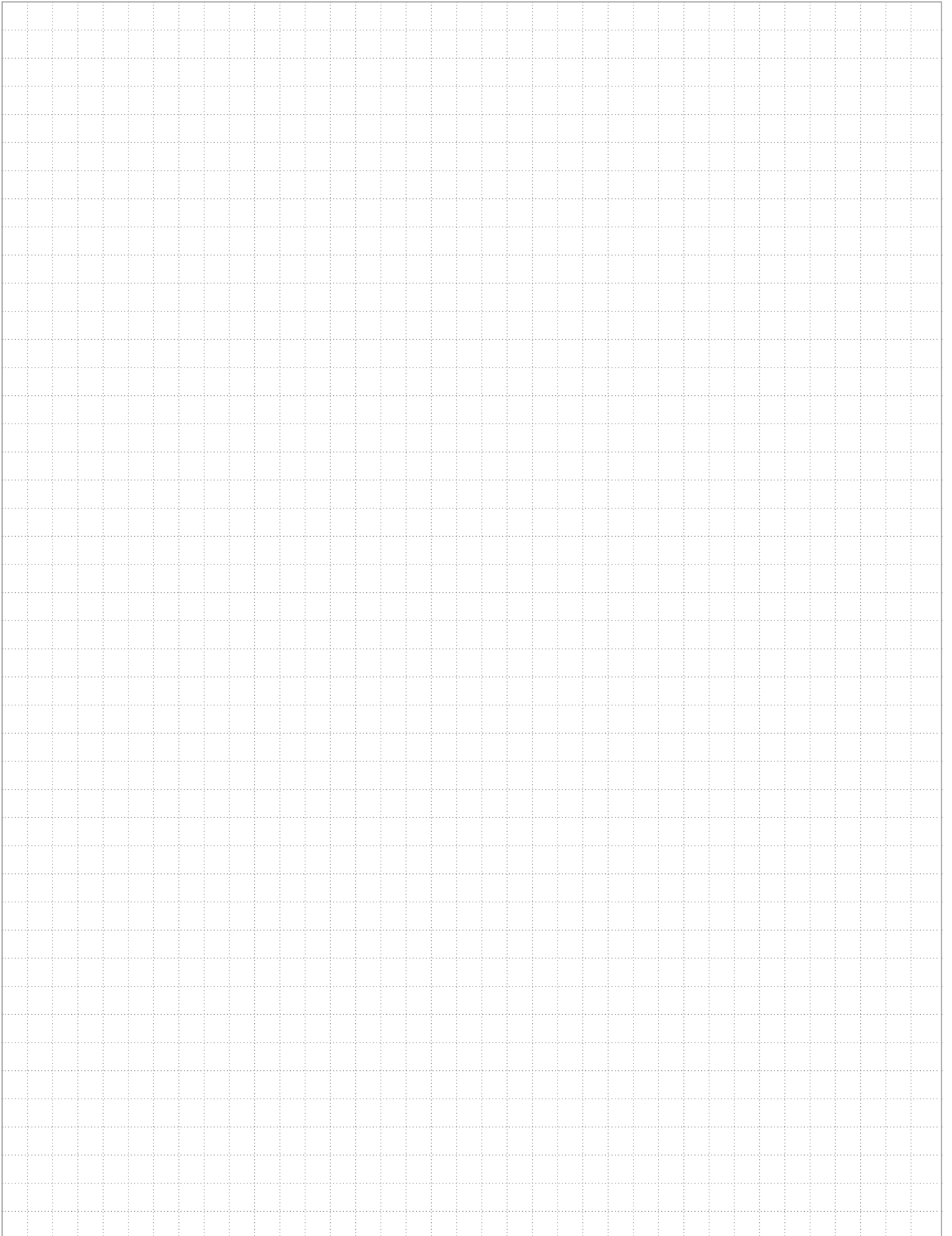







# AS..S 3-pole contactors and NS..S contactor relays with spring terminals

## AS..S 3-pole contactors - with spring terminals

5/56	AS09..S ... AS16..S	AC operated
5/57	ASL09..S ... ASL16..S	DC operated
5/58	AS09..S ... AS16..S	AC operated - 2-stack
5/59	ASL09..S ... ASL16..S	DC operated - 2-stack
5/60	Main accessories	
5/62	Technical data	
5/68	Electrical durability	
5/69	Terminal marking and positioning	
5/71	Main dimensions	

## NS..S contactors relays - with spring terminals

5/73	NS..S	AC operated
5/74	NSL..S	DC operated
5/75	Main accessories	
5/77	Technical data	
5/80	Terminal marking and positioning	
5/82	Main dimensions	

## Accessories

5/84	Auxiliary contact blocks - with spring terminals	
5/88	Surge suppressors for contactor coils	
5/90	Connecting links for starting solution and other accessories	

5/91	<b>Voltage code table</b>	
------	---------------------------	--



For direct product details information, use product type or order code, ex:

- [www.abb.com/productdetails/AF09-30-10-13](http://www.abb.com/productdetails/AF09-30-10-13)
- or [www.abb.com/productdetails/1SBL137001R1310](http://www.abb.com/productdetails/1SBL137001R1310)

# AS09..S ... AS16..S 3-pole contactors

4 to 7.5 kW

AC operated - with spring terminals



AS09-30-10S

AS09 ... AS16 contactors are mainly used for controlling 3-phase motors and power circuits up to 690 V AC and 220 V DC.

These contactors are of the block type design with:

- spring terminals
- 3 main poles and 1 built-in auxiliary contact
- control circuit: AC operated
- add-on auxiliary contact blocks for front mounting and a comprehensive range of accessories.

IEC		UL/CSA		Rated control circuit voltage Uc (1)		Auxiliary contacts fitted	Type	Order code	Weight
Rated operational power	current $\theta \leq 40^\circ\text{C}$	3-phase motor rating 480 V	General use rating 600 V AC	V 50 Hz	V 60 Hz				
400 V AC-3	AC-1								
kW	A	hp	A						kg
4	20	5	12	24	24	1 0	AS09-30-10S-20	1SBL101004R2010	0.220
					24	0 1	AS09-30-01S-20	1SBL101004R2001	0.220
				230	230	1 0	AS09-30-10S-26	1SBL101004R2610	0.220
					230	0 1	AS09-30-01S-26	1SBL101004R2601	0.220
5.5	22	7.5	12	24	24	1 0	AS12-30-10S-20	1SBL111004R2010	0.220
					24	0 1	AS12-30-01S-20	1SBL111004R2001	0.220
				230	230	1 0	AS12-30-10S-26	1SBL111004R2610	0.220
					230	0 1	AS12-30-01S-26	1SBL111004R2601	0.220
7.5	22	10	15.2	24	24	1 0	AS16-30-10S-20	1SBL121004R2010	0.220
					24	0 1	AS16-30-01S-20	1SBL121004R2001	0.220
				230	230	1 0	AS16-30-10S-26	1SBL121004R2610	0.220
					230	0 1	AS16-30-01S-26	1SBL121004R2601	0.220

Note: for multiple packaging, please contact your ABB local sales organization.

(1) Other control voltages see voltage code table.

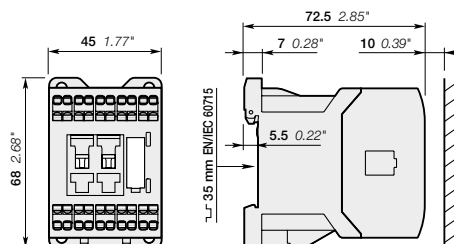

AS09..S, AS12..S, AS16..S

Main dimensions mm, inches

## ASL09..S ... ASL16..S 3-pole contactors

4 to 7.5 kW

DC operated - with spring terminals



ASL09-30-10S

ASL09..S ... ASL16..S contactors are mainly used for controlling 3-phase motors and power circuits up to 690 V AC and 220 V DC.

These contactors are of the block type design with:

- spring terminals
- 3 main poles and 1 built-in auxiliary contact
- control circuit: low consumption (3 W at pull-in and holding) DC operated with solid core magnet. Suitable for direct control by PLC outputs (the polarity on the coil terminals A1+ and A2- must be respected)
- add-on auxiliary contact blocks for front mounting and comprehensive range of accessories.

IEC		UL/CSA		Rated control circuit voltage Uc (1)	Auxiliary contacts fitted	Type	Order code	Weight
Rated operational power	current $\theta \leq 40^\circ\text{C}$	3-phase motor rating 480 V	General use rating 600 V AC					
400 V	AC-3			V DC				kg
kW	A	hp	A					
4	20	5	12	24	1 0	ASL09-30-10S-81	1SBL103004R8110	0.280
					0 1	ASL09-30-01S-81	1SBL103004R8101	0.280
5.5	22	7.5	12	24	1 0	ASL12-30-10S-81	1SBL113004R8110	0.280
					0 1	ASL12-30-01S-81	1SBL113004R8101	0.280
7.5	22	10	15.2	24	1 0	ASL16-30-10S-81	1SBL123004R8110	0.280
					0 1	ASL16-30-01S-81	1SBL123004R8101	0.280

Note: for multiple packaging, please contact your ABB local sales organization.  
 (1) Other control voltages see voltage code table.

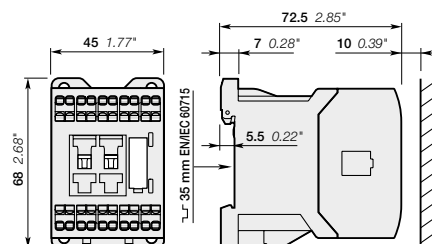

ASL09..S, ASL12..S, ASL16..S

Main dimensions mm, inches



# AS09..S ... AS16..S 2-stack 3-pole contactors

4 to 7.5 kW

AC operated - with spring terminals

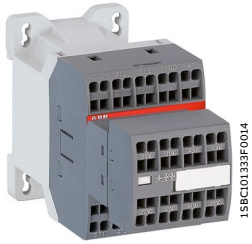

AS09-30-325

AS09..S ... AS16..S contactors are mainly used for controlling 3-phase motors and power circuits up to 690 V AC and 220 V DC.

These contactors are of the block type design with:

- spring terminals
- 1st stack with 3 main poles and 1 N.O. built-in auxiliary contact
- 2nd stack with permanently fixed 2 N.O. + 2 N.C. auxiliary contact block
- the auxiliary contact elements are mechanically linked (side-marked symbol) and the N.C. auxiliary contacts are mirror contacts
- control circuit: AC operated
- a comprehensive range of accessories.

IEC		UL/CSA		Rated control circuit voltage U <sub>c</sub> (1)		Auxiliary contacts fitted	Type	Order code	Weight
Rated operational power	current θ ≤ 40 °C	3-phase motor rating 480 V	General use rating 600 V AC	V 50 Hz	V 60 Hz				
400 V									
AC-3	AC-1						kg		
kW	A	hp	A						
4	20	5	12	24	24	3 2	AS09-30-325-20	1SBL101004R2032	0.260
				230	230	3 2	AS09-30-325-26	1SBL101004R2632	0.260
5.5	22	7.5	12	24	24	3 2	AS12-30-325-20	1SBL111004R2032	0.260
				230	230	3 2	AS12-30-325-26	1SBL111004R2632	0.260
7.5	22	10	15.2	24	24	3 2	AS16-30-325-20	1SBL121004R2032	0.260
				230	230	3 2	AS16-30-325-26	1SBL121004R2632	0.260

Note: for multiple packaging, please contact your ABB local sales organization.  
 (1) Other control voltages see voltage code table.

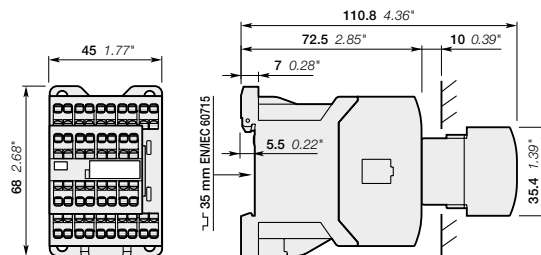

AS09..S, AS12..S, AS16..S

Main dimensions mm, inches

# ASL09..S ... ASL16..S 2-stack 3-pole contactors

4 to 7.5 kW

DC operated - with spring terminals



ASL09-30-32S

ASL09..S ... ASL16..S contactors are mainly used for controlling 3-phase motors and power circuits up to 690 V AC and 220 V DC.

These contactors are of the block type design with:

- spring terminals
- 1st stack with 3 main poles and 1 N.O. built-in auxiliary contact
- 2nd stack with permanently fixed 2 N.O. + 2 N.C. auxiliary contact block
- the auxiliary contact elements are mechanically linked (side-marked symbol) and the N.C. auxiliary contacts are mirror contacts
- control circuit: low consumption (3 W at pull-in and holding) DC operated with solid core magnet. Suitable for direct control by PLC outputs (the polarity on the coil terminals A1+ and A2- must be respected)
- a comprehensive range of accessories.

IEC		UL/CSA		Rated control circuit voltage U <sub>c</sub> (1)	Auxiliary contacts fitted	Type	Order code	Weight
Rated operational power	current θ ≤ 40 °C	3-phase motor rating	General use rating					
400 V		480 V	600 V AC					
AC-3	AC-1			V DC		kg		
kW	A	hp	A					
4	20	5	12	24	3 2	ASL09-30-32S-81	1SBL103004R8132	0.320
5.5	22	7.5	12	24	3 2	ASL12-30-32S-81	1SBL113004R8132	0.320
7.5	22	10	15.2	24	3 2	ASL16-30-32S-81	1SBL123004R8132	0.320

Note: for multiple packaging, please contact your ABB local sales organization.  
 (1) Other control voltages see voltage code table.

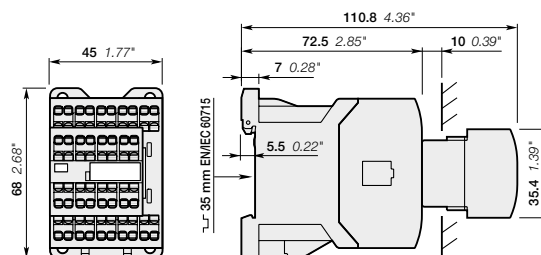

ASL09..S, ASL12..S, ASL16..S

Main dimensions mm, inches

# AS09..S ... AS16..S and ASL09..S ... ASL16..S 3-pole contactors - with spring terminals

## Main accessories

### Contactor and main accessories (other accessories available)

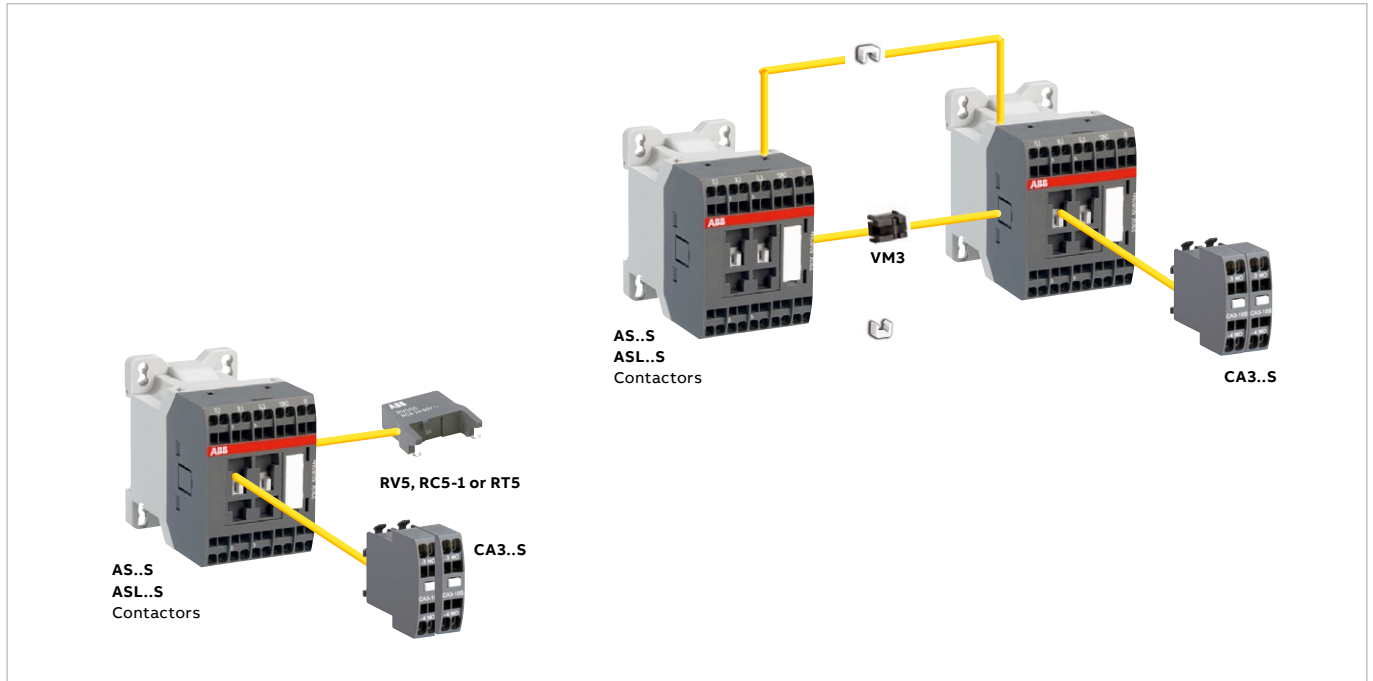

### Main accessory fitting details

Contactor types	Main poles 	Built-in auxiliary contacts 	Front-mounted accessories		Side-mounted accessories	
			Auxiliary contact blocks	Mechanical interlock unit (between 2 contactors)	Surge suppressors	
AS09..S ... AS16..S	3 0	1 0	1-pole CA3..S	VM3	+ RV5	or RC5-1
AS09..S ... AS16..S	3 0	0 1	2 max.	+ 1		
AS09..S ... AS16..S	3 0	3 2	-	1	+ RV5	or RC5-1
ASL09..S ... ASL16..S	3 0	1 0	2 max.	+ 1	+ RV5	or RT5
ASL09..S ... ASL16..S	3 0	0 1				
ASL09..S ... ASL16..S	3 0	3 2	-	1	+ RV5	or RT5

# AS09..S ... AS16..S and ASL09..S ... ASL16..S 3-pole contactors - with spring terminals

Main accessories



CA3-10S

1SBC10107F0014

### Front-mounted instantaneous auxiliary contact blocks

For contactors	Auxiliary contacts	Type	Order code	Pkg qty	Weight (1 pce)
					kg
AS09..S ... AS16..S	1 0	CA3-10S	1SBN011019T1010	10	0.011
ASL09..S ... ASL16..S	0 1	CA3-01S	1SBN011019T1001	10	0.011



VM3



1SBC101069F0014

### Mechanical interlock unit

For contactors	Type	Order code	Pkg qty	Weight (1 pce)
AS09..S ... AS16..S, ASL09..S ... ASL16..S	VM3	1SBN031005T1000	10	0.002



RV5

1SBC574001F0301

### Surge suppressors

For contactors	Rated control circuit voltage - Uc		Type	Order code	Pkg qty	Weight (1 pce)	
	V	AC					DC
AS09..S ... AS16..S, ASL09..S ... ASL16..S	24...50	●	●	RV5/50	1SBN050010R1000	2	0.015
	50...133	●	●	RV5/133	1SBN050010R1001	2	0.015
	110...250	●	●	RV5/250	1SBN050010R1002	2	0.015
	250...440	●	●	RV5/440	1SBN050010R1003	2	0.015
AS09..S ... AS16..S	24...50	●	-	RC5-1/50	1SBN050100R1000	2	0.012
	50...133	●	-	RC5-1/133	1SBN050100R1001	2	0.012
	110...250	●	-	RC5-1/250	1SBN050100R1002	2	0.012
	250...440	●	-	RC5-1/440	1SBN050100R1003	2	0.012
ASL09..S ... ASL16..S	12...32	-	●	RT5/32	1SBN050020R1000	2	0.015
	25...65	-	●	RT5/65	1SBN050020R1001	2	0.015
	50...90	-	●	RT5/90	1SBN050020R1002	2	0.015
	77...150	-	●	RT5/150	1SBN050020R1003	2	0.015
	150...264	-	●	RT5/264	1SBN050020R1004	2	0.015



BEA16-3U

1SBC101384F0010

### Connecting links with manual motor starters

For contactors	Manual motor starter	Type	Order code	Pkg qty	Weight (1 pce)
AS09..S ... AS16..S ASL09..S ... ASL16..S	MS116-0.16 ... MS116-16 MS132-0.16 ... MS132-16	BEA16-3U	1SBN081020R1000	1	0.045

# AS09..S ... AS16..S and ASL09..S ... ASL16..S 3-pole contactors - with spring terminals

## Technical data

### Main pole - Utilization characteristics according to IEC

Contactor types	AC operated	AS09..S	AS12..S	AS16..S
	DC operated	ASL09..S	ASL12..S	ASL16..S
Standards	IEC 60947-1 / 60947-4-1 and EN 60947-1 / 60947-4-1			
Rated operational voltage U <sub>e</sub> max.	690 V			
Rated frequency (without derating)	50 / 60 Hz			
Conventional free-air thermal current I <sub>th</sub> acc. to IEC 60947-4-1, open contactors, $\theta \leq 40^\circ\text{C}$		20 A	22 A	22 A
With conductor cross-sectional area		2.5 mm <sup>2</sup>	2.5 mm <sup>2</sup>	2.5 mm <sup>2</sup>
AC-1 Utilization category				
For air temperature close to contactor				
I <sub>e</sub> / Rated operational current AC-1	$\theta \leq 40^\circ\text{C}$	20 A	22 A	22 A
U <sub>e</sub> max. $\leq 690\text{ V}, 50/60\text{ Hz}$	$\theta \leq 60^\circ\text{C}$	15 A	17 A	17 A
	$\theta \leq 70^\circ\text{C}$	12 A	14 A	14 A
With conductor cross-sectional area		2.5 mm <sup>2</sup>		
AC-3 Utilization category				
For air temperature close to contactor $\theta \leq 60^\circ\text{C}$				
I <sub>e</sub> / Max. rated operational current AC-3 (1)				
	220-230-240 V	9 A	12 A	15.7 A
	400 V	9 A	12 A	15.5 A
	415 V	9 A	12 A	15.5 A
	440 V	8 A	11 A	13.6 A
	500 V	8 A	11 A	12.5 A
	690 V	5 A	7 A	9 A
Rated operational power AC-3 (1)				
	220-230-240 V	2.2 kW	3 kW	4 kW
	400 V	4 kW	5.5 kW	7.5 kW
	415 V	4 kW	5.5 kW	7.5 kW
	440 V	4 kW	5.5 kW	7.5 kW
	500 V	4 kW	5.5 kW	7.5 kW
	690 V	4 kW	5.5 kW	7.5 kW
Rated making capacity AC-3	10 x I <sub>e</sub> AC-3 acc. to IEC 60947-4-1			
Rated breaking capacity AC-3	8 x I <sub>e</sub> AC-3 acc. to IEC 60947-4-1			
AC-8a Utilization category (without thermal overload relay - U <sub>e</sub> 400 V 50/60 Hz - $\theta \leq 40^\circ\text{C}$ )				
I <sub>e</sub> / Rated operational current AC-8a		12 A	16 A	22 A
Rated operational power AC-8a		5.5 kW	7.5 kW	11 kW
Short-circuit protection device for contactors without thermal overload relay - Motor protection excluded (2)				
U <sub>e</sub> $\leq 500\text{ V AC}$ - gG type fuse		25 A		
Rated short-time withstand current I <sub>cw</sub> at 40 °C ambient temperature, in free air from a cold state				
	1 s	230 A	250 A	250 A
	10 s	100 A	124 A	124 A
	30 s	65 A	75 A	75 A
	1 min	50 A	55 A	55 A
	15 min	20 A	22 A	22 A
Maximum breaking capacity cos $\phi = 0.45$				
	at 440 V	155 A		
	at 690 V	90 A		
Power dissipation per pole				
	I <sub>e</sub> / AC-1	0.9 W	1.1 W	1.1 W
	I <sub>e</sub> / AC-3	0.18 W	0.33 W	0.55 W
Max. electrical switching frequency				
	AC-1	600 cycles/h		
	AC-3	1200 cycles/h		
	AC-4	300 cycles/h		

(1) For the corresponding kW/A or hp/A values of 1500 r.p.m. 50 Hz or 1800 r.p.m. 60 Hz, 3-phase motors, see "Motor rated operational powers and currents".

(2) For the protection of motor starters against short circuits, see "Coordination with short-circuit protection devices".

# AS09..S ... AS16..S and ASL09..S ... ASL16..S 3-pole contactors - with spring terminals

## Technical data

### Main pole - Utilization characteristics according to UL / NEMA / CSA

Contactor types	AC operated	AS09..S	AS12..S	AS16..S
	DC operated	ASL09..S	ASL12..S	ASL16..S
Standards	UL 508, CSA C22.2 N°14			
Max. operational voltage	690 V			
NEMA size	00		00	00
NEMA continuous amp rating	Thermal current	9 A		
NEMA maximum horse power ratings 1-phase, 60 Hz	115 V AC	1/3 hp	1/3 hp	1/3 hp
	230 V AC	1 hp	1 hp	1 hp
NEMA maximum horse power ratings 3-phase, 60 Hz	200 V AC	1-1/2 hp	1-1/2 hp	1-1/2 hp
	230 V AC	1-1/2 hp	1-1/2 hp	1-1/2 hp
	460 V AC	2 hp	2 hp	2 hp
	575 V AC	2 hp	2 hp	2 hp
UL / CSA General use rating	600 V AC	12 A	12 A	15.2 A
	With conductor cross-sectional area	AWG 14	AWG 14	AWG 12
UL / CSA maximum 1-phase motor rating	Full load current	120 V AC	7.2 A	9.8 A
		240 V AC	8 A	10 A
Horse power rating	120 V AC	1/3 hp	1/2 hp	3/4 hp
	240 V AC	1 hp	1-1/2 hp	2 hp
UL / CSA maximum 3-phase motor rating	Full load current (1)	200-208 V AC	7.8 A	7.8 A
		220-240 V AC	6.8 A	9.6 A
		440-480 V AC	7.6 A	11 A
		550-600 V AC	9 A	11 A
	Horse power rating (1)	200-208 V AC	2 hp	2 hp
220-240 V AC		2 hp	3 hp	5 hp
440-480 V AC		5 hp	7-1/2 hp	10 hp
	550-600 V AC	7-1/2 hp	10 hp	10 hp
Short-circuit protection device for contactors without thermal overload relay - Motor protection excluded	Fuse rating	40 A	50 A	60 A
	Fuse type, 600 V	J		
	Max. electrical switching frequency	600 cycles/h		
	For general use	600 cycles/h		
	For motor use	1200 cycles/h		

(1) For the corresponding kW/A or hp/A values of 1500 r.p.m, 50 Hz or 1800 r.p.m, 60 Hz, 3-phase motors, see "Motor rated operational powers and currents".

### General technical data

Contactor types	AC operated	AS09..S	AS12..S	AS16..S
	DC operated	ASL09..S	ASL12..S	ASL16..S
Rated insulation voltage Ui	acc. to IEC 60947-4-1	690 V		
	acc. to UL / CSA	600 V		
Rated impulse withstand voltage Uimp.	6 kV			
Ambient air temperature close to contactor	Operation	-40...+70 °C		
	Storage	-60...+80 °C		
Climatic withstand	Category B according to IEC 60947-1 Annex Q			
Maximum operating altitude (without derating)	3000 m			
Mechanical durability	Number of operating cycles	10 millions operating cycles		
	Max. switching frequency	3600 cycles/h		
Shock withstand	1/2 sinusoidal shock for 11 ms: no change in contact position, closed or open position			
	acc. to IEC 60068-2-27 and EN 60068-2-27	Shock direction	AS contactors - AC operated	ASL contactors - DC operated
Mounting position 1	A	20 g	20 g closed position / 10 g open position	
	B1	10 g closed position / 5 g open position	15 g closed position / 5 g open position	
	B2	15 g	10 g	
	C1	20 g closed position / 9 g open position	15 g closed position / 8 g open position	
	C2	20 g closed position / 14 g open position	14 g closed position / 8 g open position	
Vibration withstand	acc. to IEC 60068-2-6	5...300 Hz / 3 g closed position / 2 g open position		

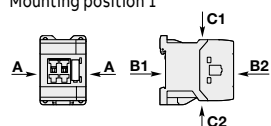

05

15BC0149050201

# AS09..S ... AS16..S and ASL09..S ... ASL16..S 3-pole contactors - with spring terminals

## Technical data

### Magnet system characteristics for AS09..S ... AS16..S contactors

Contactor types		AC operated	AS09..S	AS12..S	AS16..S
Coil operating limits acc. to IEC 60947-4-1		AC supply	0.85...1.1 x U <sub>c</sub> (at θ ≤ 60 °C); U <sub>c</sub> (at θ ≤ 70 °C)		
AC control voltage	Rated control circuit voltage U <sub>c</sub>	at 50 Hz	24...415 V		
		at 60 Hz	24...415 V		
Coil consumption	Average pull-in value	50 Hz	33 VA		
		60 Hz	33 VA		
		50/60 Hz	33 VA		
Average holding value		50 Hz	6.5 VA / 1.5 W		
		60 Hz	5 VA / 1.2 W		
		50/60 Hz	6.5 VA / 1.5 W		
Drop-out voltage			Approx. 30...50 % of U <sub>c</sub>		
Operating time					
Between coil energization and:		N.O. contact closing	9...24 ms		
		N.C. contact opening	6...18 ms		
Between coil de-energization and:		N.O. contact opening (1)	5...19 ms		
		N.C. contact closing (1)	7...22 ms		
(1) The use of RC5-1 surge suppressor increases opening time by a factor of 2 to 3.					

### Magnet system characteristics for ASL09..S ... ASL16..S contactors

Contactor types		DC operated	ASL09..S	ASL12..S	ASL16..S
Coil operating limits acc. to IEC 60947-4-1		DC supply	0.85...1.1 x U <sub>c</sub> (at θ ≤ 60 °C); U <sub>c</sub> (at θ ≤ 70 °C)		
DC control voltage	Rated control circuit voltage U <sub>c</sub>		12...240 V DC		
		Coil consumption			
	Average pull-in value		3 W		
	Average holding value		3 W		
Drop-out voltage			Approx. 10...40 % of U <sub>c</sub>		
Coil time constant	Open	L/R	12 ms		
	Closed	L/R	40 ms		
Operating time					
Between coil energization and:		N.O. contact closing	36...59 ms		
		N.C. contact opening	31...53 ms		
Between coil de-energization and:		N.O. contact opening (1)	13...17 ms		
		N.C. contact closing (1)	15...20 ms		
(1) The use of RT5 surge suppressor increases opening time by a factor of 1.1 to 1.2					







### Mounting characteristics and conditions for use

Contactor types		AC operated	AS09..S	AS12..S	AS16..S
		DC operated	ASL09..S	ASL12..S	ASL16..S
Mounting positions					
Mounting distances		The contactors can be assembled side by side.			
Fixing	On rail according to IEC 60715, EN 60715	35 x 7.5 mm or 35 x 15 mm			
	By screws (not supplied)	2 x M4 screws placed diagonally			

# AS09..S ... AS16..S and ASL09..S ... ASL16..S 3-pole contactors - with spring terminals

## Technical data

### Connecting characteristics

Contactor types	AC operated	<b>AS09..S</b>	<b>AS12..S</b>	<b>AS16..S</b>
	DC operated	<b>ASL09..S</b>	<b>ASL12..S</b>	<b>ASL16..S</b>
Main terminals	 <p>Spring terminals</p>			
Connection capacity (min. ... max.)				
Main conductors (poles)				
 Rigid	1 x	0.75...2.5 mm <sup>2</sup>		
	2 x	0.75...2.5 mm <sup>2</sup>		
 Flexible with non insulated ferrule	1 x	0.75...2.5 mm <sup>2</sup>		
	2 x	0.75...2.5 mm <sup>2</sup>		
 Flexible with insulated ferrule	1 x	0.75...1.5 mm <sup>2</sup>		
	2 x	0.75...1.5 mm <sup>2</sup>		
Connection capacity acc. to UL / CSA	1 or 2 x	AWG 18...12		
Stripping length	10 mm			
Auxiliary conductors (built-in auxiliary terminals + coil terminals)				
 Rigid solid	1 x	0.75...2.5 mm <sup>2</sup>		
	2 x	0.75...2.5 mm <sup>2</sup>		
 Flexible with non insulated ferrule	1 x	0.75...2.5 mm <sup>2</sup>		
	2 x	0.75...2.5 mm <sup>2</sup>		
 Flexible with insulated ferrule	1 x	0.75...1.5 mm <sup>2</sup>		
	2 x	0.75...1.5 mm <sup>2</sup>		
Connection capacity acc. to UL / CSA	1 or 2 x	AWG 18...14		
Stripping length	10 mm			
Degree of protection acc. to IEC 60947-1 / EN 60947-1 and IEC 60529 / EN 60529				
All terminals	IP20			
Screwdriver type	Flat Ø 3.5			



## AS09..S ... AS16..S and ASL09..S ... ASL16..S 3-pole contactors - with spring terminals

### Technical data

#### Built-in auxiliary contacts according to IEC

Contactor types	AC operated	AS09..S	AS12..S	AS16..S
	DC operated	ASL09..S	ASL12..S	ASL16..S
Rated operational voltage U <sub>e</sub> max.		690 V		
Rated frequency (without derating)		50 / 60 Hz		
Conventional free air thermal current I <sub>th</sub> - θ ≤ 40 °C		10 A		
I <sub>e</sub> / Rated operational current AC-15 acc. to IEC 60947-5-1	24-127 V 50/60 Hz	6 A		
	220-240 V 50/60 Hz	4 A		
	400-440 V 50/60 Hz	3 A		
	500 V 50/60 Hz	2 A		
	690 V 50/60 Hz	2 A		
Making capacity AC-15		10 x I <sub>e</sub> AC-15 acc. to IEC 60947-5-1		
Breaking capacity AC-15		10 x I <sub>e</sub> AC-15 acc. to IEC 60947-5-1		
I <sub>e</sub> / Rated operational current DC-13 acc. to IEC 60947-5-1	24 V DC	6 A / 144 W		
	48 V DC	2.8 A / 134 W		
	72 V DC	1 A / 72 W		
	110 V DC	0.55 A / 60 W		
	125 V DC	0.55 A / 69 W		
	220 V DC	0.27 A / 60 W		
	250 V DC	0.27 A / 68 W		
Short-circuit protection device gG type fuse		10 A		
Rated short-time withstand current I <sub>cw</sub>	for 1.0 s	100 A		
	for 0.1 s	140 A		
Minimum switching capacity with failure rate acc. to IEC 60947-5-4		12 V / 3 m		
		10-7		
Non-overlapping time between N.O. and N.C. contacts		1.5 ms		
Power dissipation per pole at 6 A		0.1 W		
Max. electrical switching frequency	AC-15	1200 cycles/h		
	DC-13	900 cycles/h		
Mechanically linked contacts acc. to annex L of IEC 60947-5-1		Built-in N.O. or N.C. auxiliary contacts and additional N.O. or N.C. auxiliary contacts (CA3 aux. contact blocks) are mechanically linked contacts.		
Mirror contacts acc. to annex F of IEC 60947-4-1		Built-in N.C. auxiliary contacts or additional N.C. auxiliary contacts (CA3 aux. contact blocks) are mirror contacts.		

#### Built-in auxiliary contacts according to UL / CSA

Contactor types	AC operated	AS09..S	AS12..S	AS16..S
	DC operated	ASL09..S	ASL12..S	ASL16..S
Max. operational voltage		600 V AC, 250 V DC		
Pilot duty		A600, Q300		
AC thermal rated current		10 A		
AC maximum volt-ampere making		7200 VA		
AC maximum volt-ampere breaking		720 VA		
DC thermal rated current		2.5 A		
DC maximum volt-ampere making-breaking		69 VA		

—  
**Notes**

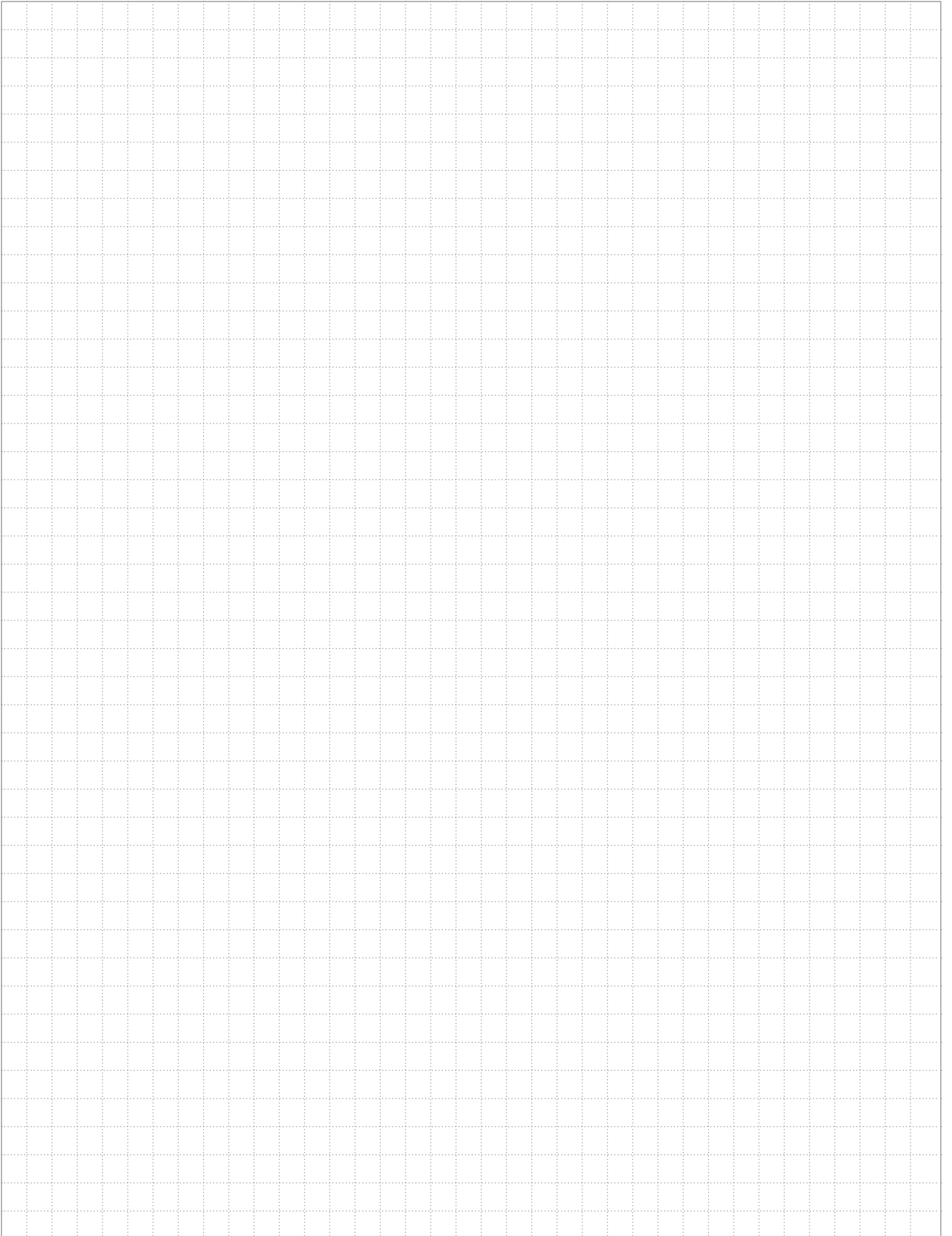

# AS09..S ... AS16..S and ASL09..S ... ASL16..S 3-pole contactors - with spring terminals

## Electrical durability

Electrical durability for AC-1 utilization category -  $U_e \leq 690\text{ V}$

Note: AC-1 maximum current is selected according to ambient temperature. Please see technical data.

Switching non-inductive or slightly inductive loads. The breaking current  $I_c$  for AC-1 is equal to the rated operational current of the load. Maximum electrical switching frequency: 600 cycles / hour.

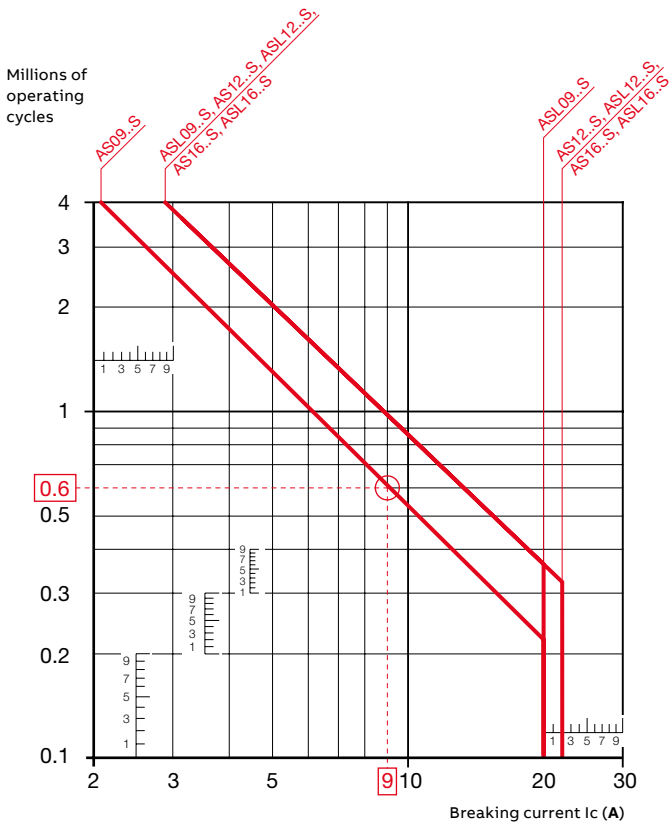

Example:

Breaking current = 9 A.

On the opposite curve at intersection "O" 9 A the corresponding value for the electrical durability is approximately 0.6 millions operating cycles.

# AS09..S ... AS16..S 3-pole contactors - with spring terminals

## Terminal marking and positioning

### AS..S contactors - AC operated

Standard devices without addition of auxiliary contacts

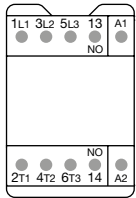

AS09 ... AS16-30-10S

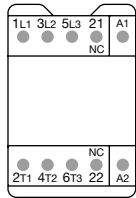

AS09 ... AS16-30-01S

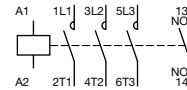

AS09 ... AS16-30-10S

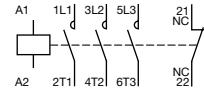

AS09 ... AS16-30-01S

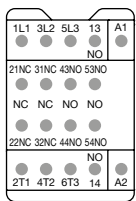

AS09 ... AS16-30-32S

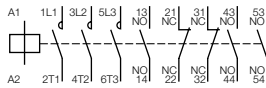

AS09 ... AS16-30-32S

### Other possible contact combinations with auxiliary contact blocks added by the user

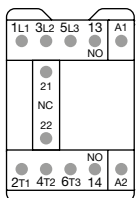

Combination 11

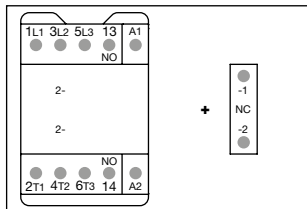

AS09 ... AS16-30-10S + CA3-01S

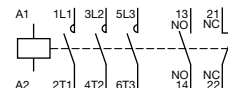

Combination 11

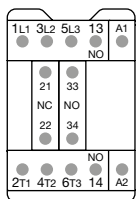

Combination 21

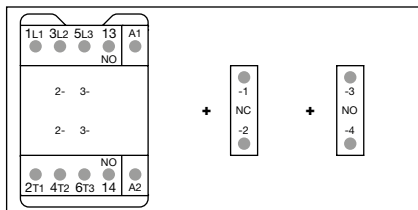

AS09 ... AS16-30-10S + CA3-01S + CA3-10S

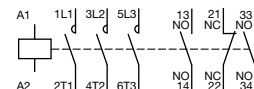

Combination 21

### CA3..S 1-pole auxiliary contact blocks

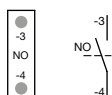

CA3-10S

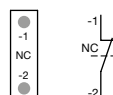

CA3-01S

# ASL09..S ... ASL16..S 3-pole contactors - with spring terminals

## Terminal marking and positioning

### ASL..S contactors - DC operated (the polarity A1+, A2- must be respected)

Standard devices without addition of auxiliary contacts

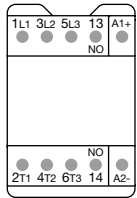

ASL09 ... ASL16-30-10S

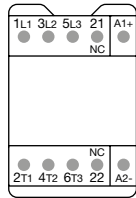

ASL09 ... ASL16-30-01S

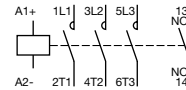

ASL09 ... ASL16-30-10S

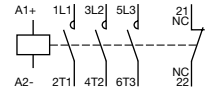

ASL09 ... ASL16-30-01S

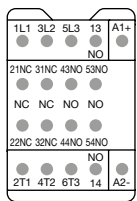

ASL09 ... ASL16-30-32S

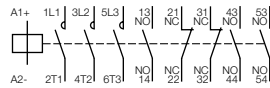

ASL09 ... ASL16-30-32S

### Other possible contact combinations with auxiliary contact blocks added by the user

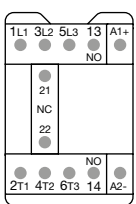

Combination 11

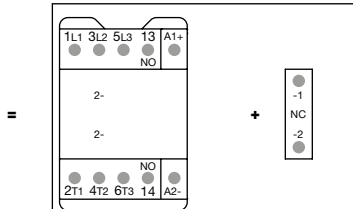

ASL09 ... ASL16-30-10S + CA3-01S

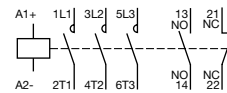

Combination 11

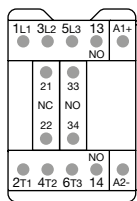

Combination 21

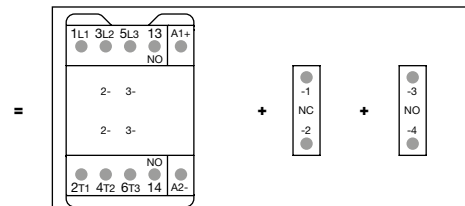

ASL09 ... ASL16-30-10S + CA3-01S + CA3-10S

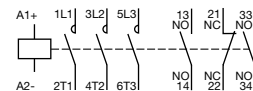

Combination 21

### CA3..S 1-pole auxiliary contact blocks

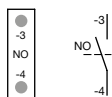

CA3-10S

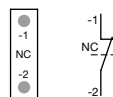

CA3-01S

# AS09..S ... AS16..S 3-pole contactors - with spring terminals

## Dimensions

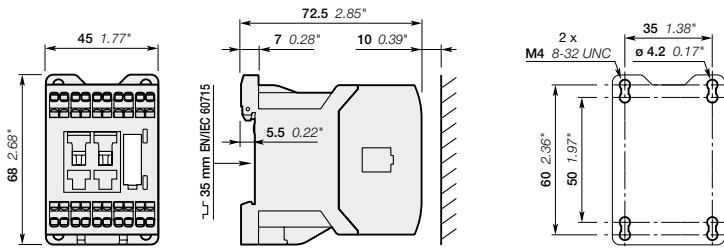

AS09..S, AS12..S, AS16..S

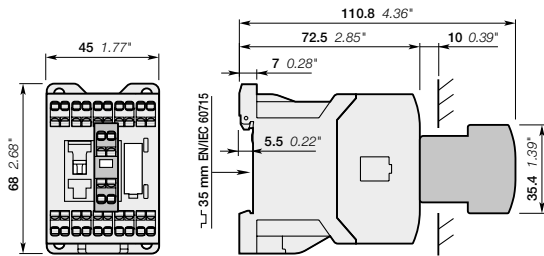

AS09..S, AS12..S, AS16..S  
+ CA3..S front-mounted 1-pole auxiliary contact block

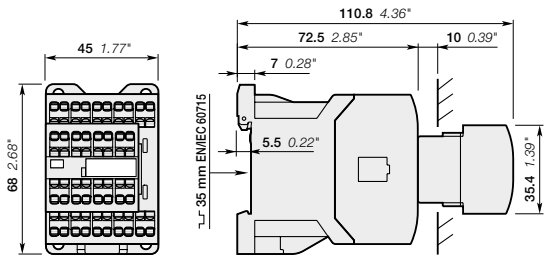

AS09...16-30-32S

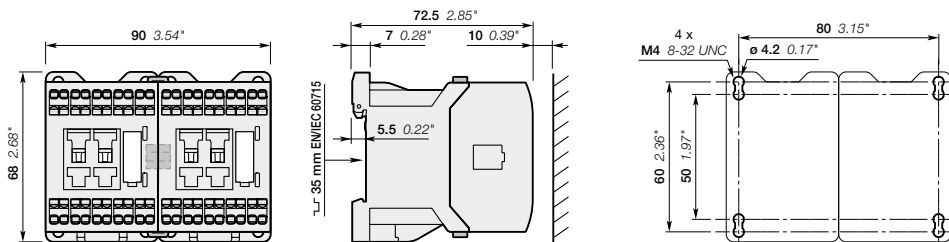

AS09..S, AS12..S, AS16..S  
+ VM3 mechanical interlock unit including two BB3 fixing clips

Main dimensions mm, inches

# ASL09..S ... ASL16..S 3-pole contactors - with spring terminals

## Dimensions

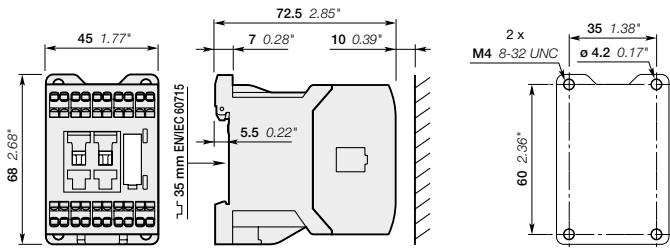

ASL09..S, ASL12..S, ASL16..S

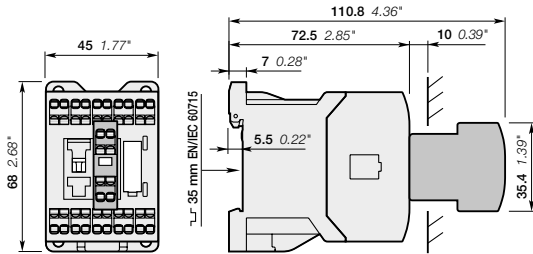

ASL09..S, ASL12..S, ASL16..S  
+ CA3..S front-mounted 1-pole auxiliary contact block

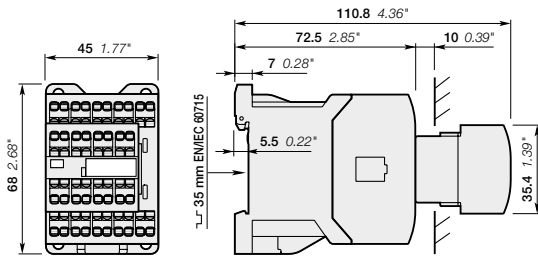

ASL09...16-30-32S

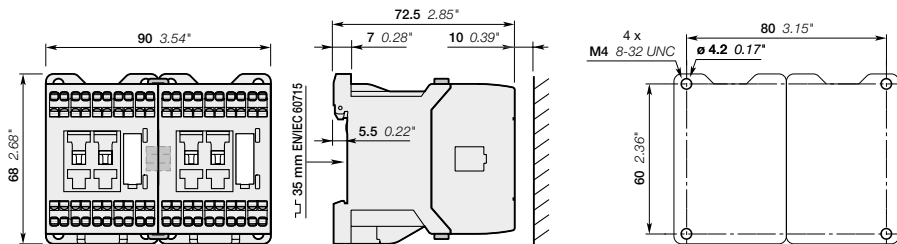

ASL09..S, ASL12..S, ASL16..S  
+ VM3 mechanical interlock unit including two BB3 fixing clips

Main dimensions mm, inches

# NS..S contactor relays - with spring terminals

AC operated



NS22ES

NS..S contactor relays are used for switching auxiliary and control circuits.

These contactor relays are designed with:

- spring terminals
- 4 poles or 8 poles. Contactor relays have mechanically linked auxiliary contact elements (side-marked symbol)
- control circuit: AC operated
- add-on auxiliary contact blocks for front mounting and a comprehensive range of accessories.

Number of contacts		Rated control circuit voltage Uc (1)		Type	Order code	Weight Pkg (1 pce) kg
1st stack	2nd stack	V 50 Hz	V 60 Hz			
		24	24	NS22ES-20	1SBH101004R2022	0.220
		230	230	NS22ES-26	1SBH101004R2622	0.220
		24	24	NS31ES-20	1SBH101004R2031	0.220
		230	230	NS31ES-26	1SBH101004R2631	0.220
		24	24	NS40ES-20	1SBH101004R2040	0.220
		230	230	NS40ES-26	1SBH101004R2640	0.220
		24	24	NS44ES-20	1SBH101004R2044	0.260
		230	230	NS44ES-26	1SBH101004R2644	0.260
		24	24	NS53ES-20	1SBH101004R2053	0.260
		230	230	NS53ES-26	1SBH101004R2653	0.260
		24	24	NS62ES-20	1SBH101004R2062	0.260
		230	230	NS62ES-26	1SBH101004R2662	0.260
		24	24	NS71ES-20	1SBH101004R2071	0.260
		230	230	NS71ES-26	1SBH101004R2671	0.260
		24	24	NS80ES-20	1SBH101004R2080	0.260
		230	230	NS80ES-26	1SBH101004R2680	0.260

Note: for multiple packaging, please contact your ABB local sales organization.

(1) Other control voltages see voltage code table.

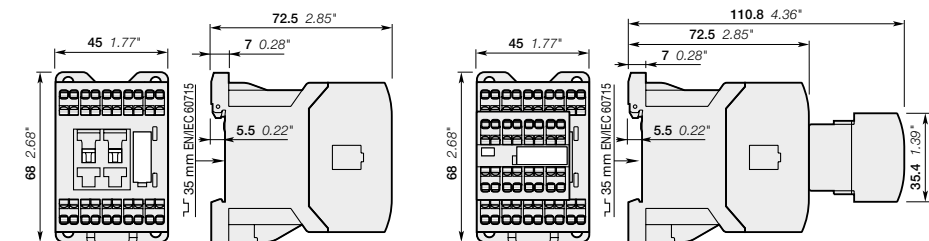

NS22ES, NS31ES, NS40ES

NS44ES, NS53ES, NS62ES, NS71ES, NS80ES

Main dimensions mm, inches



# NSL..S contactor relays - with spring terminals

DC operated



NSL22ES

NSL..S contactor relays are used for switching auxiliary and control circuits.

These contactor relays are designed with:

- spring terminals
- 4 poles or 8 poles. Contactor relays have mechanically linked auxiliary contact elements (side-marked symbol)
- control circuit: low coil consumption (3 W at pull-in and holding) DC operated with solid core magnet. Suitable for direct control by PLC outputs (the polarity on the coil terminals A1+ and A2- must be respected)
- add-on auxiliary contact blocks for front mounting and a comprehensive range of accessories.

Number of contacts		Rated control circuit voltage Uc (1)  V DC	Type	Order code	Weight  Pkg (1 pce) kg
1st stack	2nd stack				
		24	NSL22ES-81	1SBH103004R8122	0.280
		24	NSL31ES-81	1SBH103004R8131	0.280
		24	NSL40ES-81	1SBH103004R8140	0.280
		24	NSL44ES-81	1SBH103004R8144	0.320
		24	NSL53ES-81	1SBH103004R8153	0.320
		24	NSL62ES-81	1SBH103004R8162	0.320
		24	NSL71ES-81	1SBH103004R8171	0.320
		24	NSL80ES-81	1SBH103004R8180	0.320

Note: for multiple packaging, please contact your ABB local sales organization.

(1) Other control voltages see voltage code table.

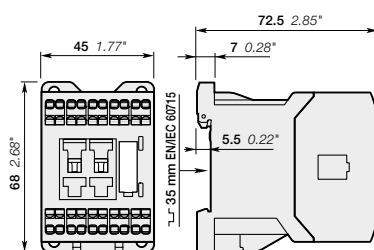

NSL22ES, NSL31ES, NSL40ES

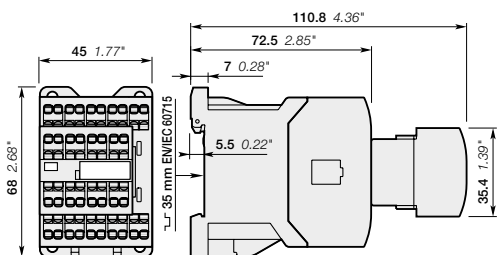

NSL44ES, NSL53ES, NSL62ES, NSL71ES, NSL80ES

Main dimensions mm, inches

# NS..S and NSL..S contactor relays - with spring terminals

## Main accessories

### Contactor relays and main accessories

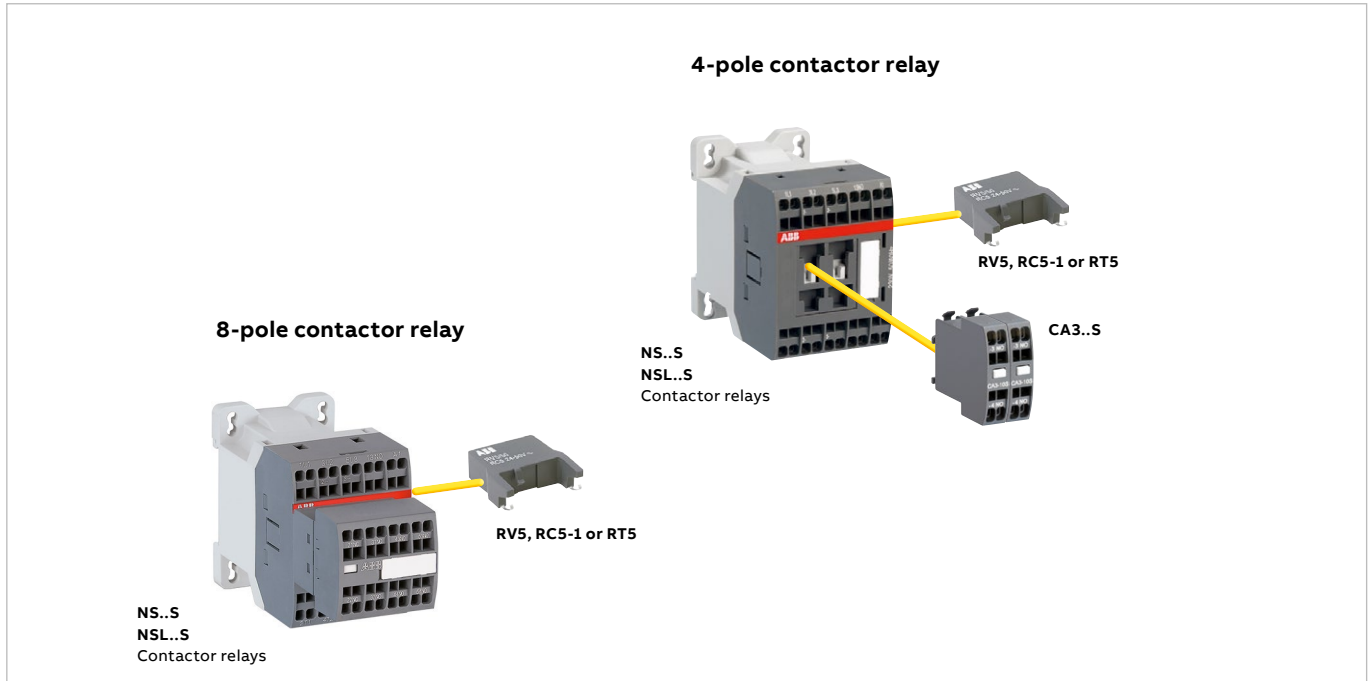

### Main accessory fitting details

Contactor types	Main poles	Front-mounted accessories		Side-mounted accessories	
		Auxiliary contact blocks		Surge suppressors	
		1-pole CA3..S			
NS..S	2 2 E	2 max.	+	RV5	or RC5-1
NS..S	3 1 E				
NS..S	4 0 E				
NS..S	4 4 E	-		RV5	or RC5-1
NS..S	5 3 E				
NS..S	6 2 E				
NS..S	7 1 E				
NS..S	8 0 E				
NSL..S	2 2 E	2 max.	+	RV5	or RT5
NSL..S	3 1 E				
NSL..S	4 0 E				
NSL..S	4 4 E	-		RV5	or RT5
NSL..S	5 3 E				
NSL..S	6 2 E				
NSL..S	7 1 E				
NSL..S	8 0 E				

05

# NS..S and NSL..S contactor relays - with spring terminals

## Main accessories



CA3-10S

### Front mounted instantaneous auxiliary contact blocks

For contactor relays	Auxiliary contacts	Type	Order code	Pkg qty	Weight (1 pce)
					kg
NS..S, NSL..S	1 0	CA3-10S	1SBN011019T1010	10	0.011
	0 1	CA3-01S	1SBN011019T1001	10	0.011



RV5

### Surge suppressors

For contactor relays	Rated control circuit voltage - Uc		Type	Order code	Pkg qty	Weight (1 pce)
	V	AC				
NS..S, NSL..S	24...50	●	●	RV5/50	1SBN050010R1000	2 0.015
	50...133	●	●	RV5/133	1SBN050010R1001	2 0.015
	110...250	●	●	RV5/250	1SBN050010R1002	2 0.015
	250...440	●	●	RV5/440	1SBN050010R1003	2 0.015
NS..S	24...50	●	-	RC5-1/50	1SBN050100R1000	2 0.012
	50...133	●	-	RC5-1/133	1SBN050100R1001	2 0.012
	110...250	●	-	RC5-1/250	1SBN050100R1002	2 0.012
	250...440	●	-	RC5-1/440	1SBN050100R1003	2 0.012
NSL..S	12...32	-	●	RT5/32	1SBN050020R1000	2 0.015
	25...65	-	●	RT5/65	1SBN050020R1001	2 0.015
	50...90	-	●	RT5/90	1SBN050020R1002	2 0.015
	77...150	-	●	RT5/150	1SBN050020R1003	2 0.015
	150...264	-	●	RT5/264	1SBN050020R1004	2 0.015

# NS..S and NSL..S contactor relays - with spring terminals

## Technical data

### Contact utilization characteristics according to IEC

Contactor relay types	AC operated	<b>NS..S</b>
	DC operated	<b>NSL..S</b>
Standards	IEC 60947-5-1 and EN 60947-5-1	
Rated operational voltage Ue max.	690 V	
Rated frequency (without derating)	50 / 60 Hz	
Conventional free-air thermal current Ith $\theta \leq 40^\circ\text{C}$	10 A	
Ie / Rated operational current AC-15 acc. to IEC 60947-5-1	24-127 V 50/60 Hz	6 A
	220-240 V 50/60 Hz	4 A
	400-440 V 50/60 Hz	3 A
	500 V 50/60 Hz	2 A
	690 V 50/60 Hz	2 A
	Making capacity AC-15	10 x Ie AC-15 acc. to IEC 60947-5-1
Breaking capacity AC-15	10 x Ie AC-15 acc. to IEC 60947-5-1	
Ie / Rated operational current DC-13 acc. to IEC 60947-5-1	24 V DC	6 A / 144 W
	48 V DC	2.8 A / 134 W
	72 V DC	1 A / 72 W
	110 V DC	0.55 A / 60 W
	125 V DC	0.55 A / 69 W
	220 V DC	0.27 A / 60 W
	250 V DC	0.27 A / 68 W
	Short-circuit protection device for contactors Ue $\leq$ 500 V AC - gG type fuse	10 A
Rated short-time withstand current Icw at 40 °C ambient temperature, in free air from a cold state	for 1.0 s	100 A
	for 0.1 s	140 A
Minimum switching capacity with failure rate acc. to IEC 60947-5-4	12 V / 3 mA	
Non-overlapping time between N.O. and N.C. contacts	1.5 ms	
Power dissipation per pole at 6 A	0.1 W	
Max. electrical switching frequency	AC-15	1200 cycles/h
	DC-13	900 cycles/h
Mechanically linked contacts acc. to annex L of IEC 60947-5-1	Built-in N.O. or N.C. auxiliary contacts and additional N.O. or N.C. auxiliary contacts (CA3..S aux. contact blocks) are mechanically linked contacts.	

### Contact utilization characteristics according to UL / CSA

Contactor relay types	AC operated	<b>NS..S</b>
	DC operated	<b>NSL..S</b>
Standards	UL 508, CSA C22.2 N°14	
Max. operational voltage	600 V AC, 250 V DC	
Pilot duty	A600, Q300	
AC thermal rated current	10 A	
AC maximum volt-ampere making	7200 VA	
AC maximum volt-ampere breaking	720 VA	
DC thermal rated current	2.5 A	
DC maximum volt-ampere making-breaking	69 VA	

# NS..S and NSL..S contactor relays - with spring terminals

## Technical data

### Magnet system characteristics for NS..S contactor relays

Contactor relay types	AC operated	<b>NS..S</b>	
Coil operating limits acc. to IEC 60947-5-1	AC supply	0.85...1.1 x U <sub>c</sub> (at θ ≤ 60 °C); U <sub>c</sub> (at θ ≤ 70 °C)	
AC control voltage	Rated control circuit voltage U <sub>c</sub>	at 50 Hz 24...415 V	
		at 60 Hz 24...415 V	
Coil consumption	Average pull-in value	50 Hz 33 VA	
		60 Hz 33 VA	
		50/60 Hz 33 VA	
		Average holding value	50 Hz 6.5 VA / 1.5 W
			60 Hz 5 VA / 1.2 W
50/60 Hz 6.5 VA / 1.5 W			
Drop-out voltage		Approx. 30...50 % of U <sub>c</sub>	
Operating time	Between coil energization and:	N.O. contact closing 9...24 ms	
		N.C. contact opening 6...18 ms	
	Between coil de-energization and:	N.O. contact opening (1) 5...19 ms	
		N.C. contact closing (1) 7...22 ms	

(1) The use of RC5-1 surge suppressor increases opening time by a factor of 2 to 3.

### Magnet system characteristics for NSL..S contactor relays

Contactor relay types	DC operated	<b>NSL..S</b>
Coil operating limits acc. to IEC 60947-5-1	DC supply	0.85...1.1 x U <sub>c</sub> (at θ ≤ 60 °C); U <sub>c</sub> (at θ ≤ 70 °C)
DC control voltage	Rated control circuit voltage U <sub>c</sub>	12...240 V DC
Coil consumption	Average pull-in value	3 W
	Average holding value	3 W
Drop-out voltage		Approx. 10...40 % of U <sub>c</sub>
Coil time constant	Open	L/R 12 ms
	Closed	L/R 40 ms
Operating time	Between coil energization and:	N.O. contact closing 36...59 ms
		N.C. contact opening 31...53 ms
	Between coil de-energization and:	N.O. contact opening (1) 13...17 ms
		N.C. contact closing (1) 15...20 ms

(1) The use of RT5 surge suppressor increases opening time by a factor of 1.1 to 1.2.

### Mounting characteristics and conditions for use

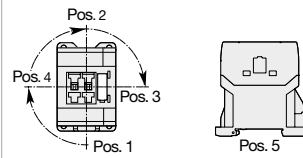
Contactor relay types	AC operated	<b>NS..S</b>
	DC operated	<b>NSL..S</b>
Mounting positions		
Mounting distances	The contactor relays can be assembled side by side.	
Fixing	On rail according to IEC 60715, EN 60715	35 x 7.5 mm or 35 x 15 mm
	By screws (not supplied)	2 x M4 screws placed diagonally



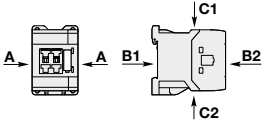

# NS..S and NSL..S contactor relays - with spring terminals

## Technical data

### General technical data

Contactor relay types	AC operated	<b>NS..S</b>	
	DC operated	<b>NSL..S</b>	
Rated insulation voltage Ui acc. to IEC 60947-5-1		690 V	
acc. to UL / CSA		600 V	
Rated impulse withstand voltage Uimp.		6 kV	
Ambient air temperature close to contactor relay			
Operation in free air		-40...+70 °C	
Storage		-60...+80 °C	
Climatic withstand		Category B according to IEC 60947-1 Annex Q	
Maximum operating altitude (without derating)		3000 m	
Mechanical durability			
Number of operating cycles		20 millions operating cycles	
Max. switching frequency		3600 cycles/h	
Shock withstand acc. to IEC 60068-2-27 and EN 60068-2-27		1/2 sinusoidal shock for 11 ms: no change in contact position, closed or open position	
Mounting position 1	Shock direction		
		NS contactor relays - AC operated	NSL contactor relays - DC operated
	A	20 g	20 g closed position / 10 g open position
	B1	5 g	15 g closed position / 5 g open position
	B2	15 g	10 g
	C1	19 g closed position / 8 g open position	19 g closed position / 8 g open position
	C2	16 g closed position / 13 g open position	14 g closed position / 8 g open position
Vibration withstand acc. to IEC 60068-2-6		5...300 Hz 3 g closed position / 2 g open position	

### Connecting characteristics

Contactor relay types	AC operated	<b>NS..S</b>	
	DC operated	<b>NSL..S</b>	
Main terminals		 Spring terminals	
Connection capacity (min. ... max.)			
Pole and coil terminals			
 Rigid solid	1 x	0.75...2.5 mm <sup>2</sup>	
	2 x	0.75...2.5 mm <sup>2</sup>	
 Flexible with non insulated ferrule	1 x	0.75...2.5 mm <sup>2</sup>	
	2 x	0.75...2.5 mm <sup>2</sup>	
 Flexible with insulated ferrule	1 x	0.75...1.5 mm <sup>2</sup>	
	2 x	0.75...1.5 mm <sup>2</sup>	
Connection capacity acc. to UL / CSA	1 or 2 x	AWG 18...14	
Stripping length		10 mm	
Degree of protection acc. to IEC 60947-1 / EN 60947-1 and IEC 60529 / EN 60529			
All terminals		IP20	
Screwdriver type		Flat Ø 3.5	

# NS..S contactor relays - with spring terminals

## Terminal marking and positioning

### NS..S contactor relays - AC operated

Standard devices without addition of auxiliary contact blocks

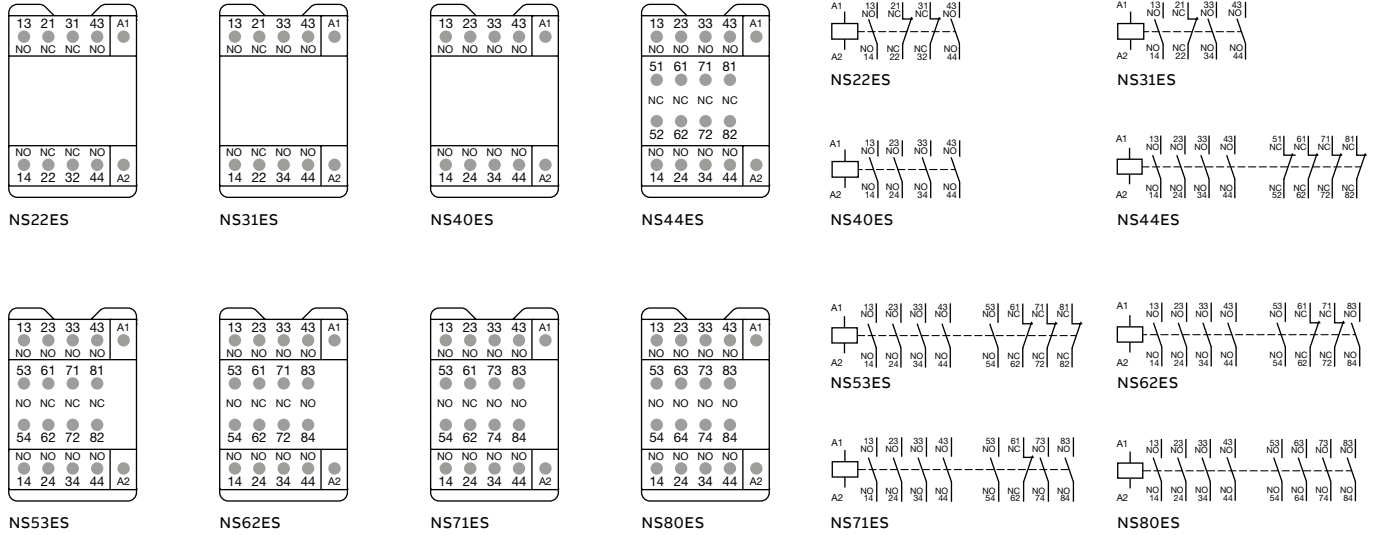

### Other possible contact combinations with auxiliary contact blocks added by the user

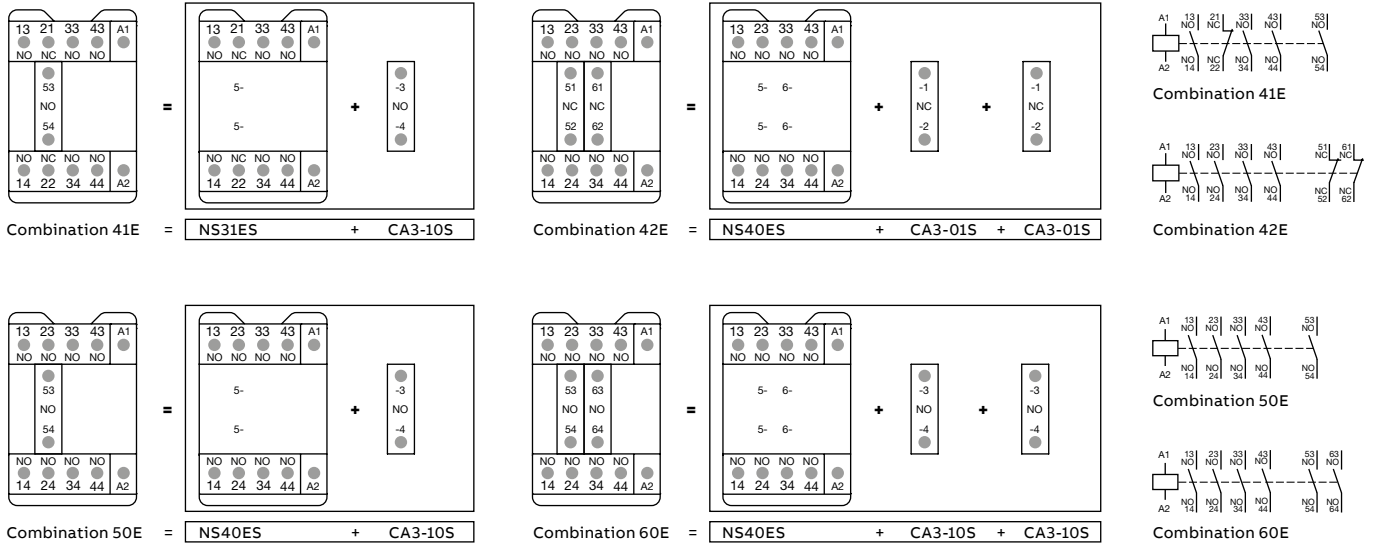

### CA3..S 1-pole auxiliary contact blocks

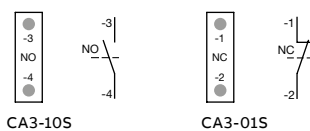

# NSL..S contactor relays - with spring terminals

## Terminal marking and positioning

### NSL..S contactor relays - DC operated (the polarity A1+, A2- must be respected)

Standard devices without addition of auxiliary contact blocks

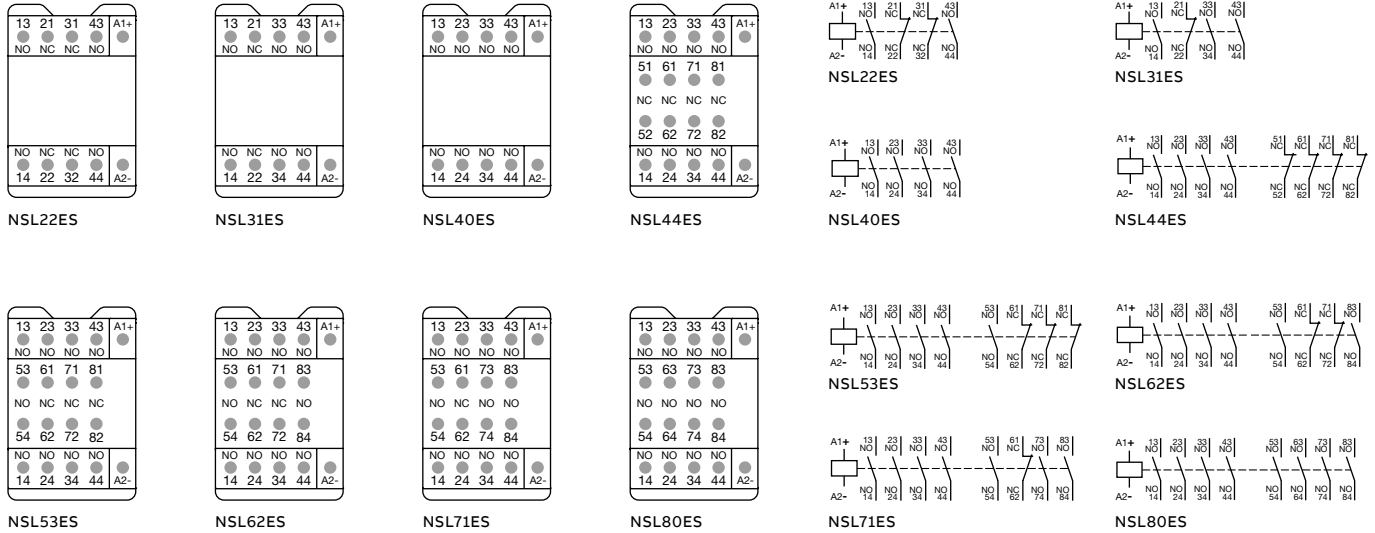

### Other possible contact combinations with auxiliary contact blocks added by the user

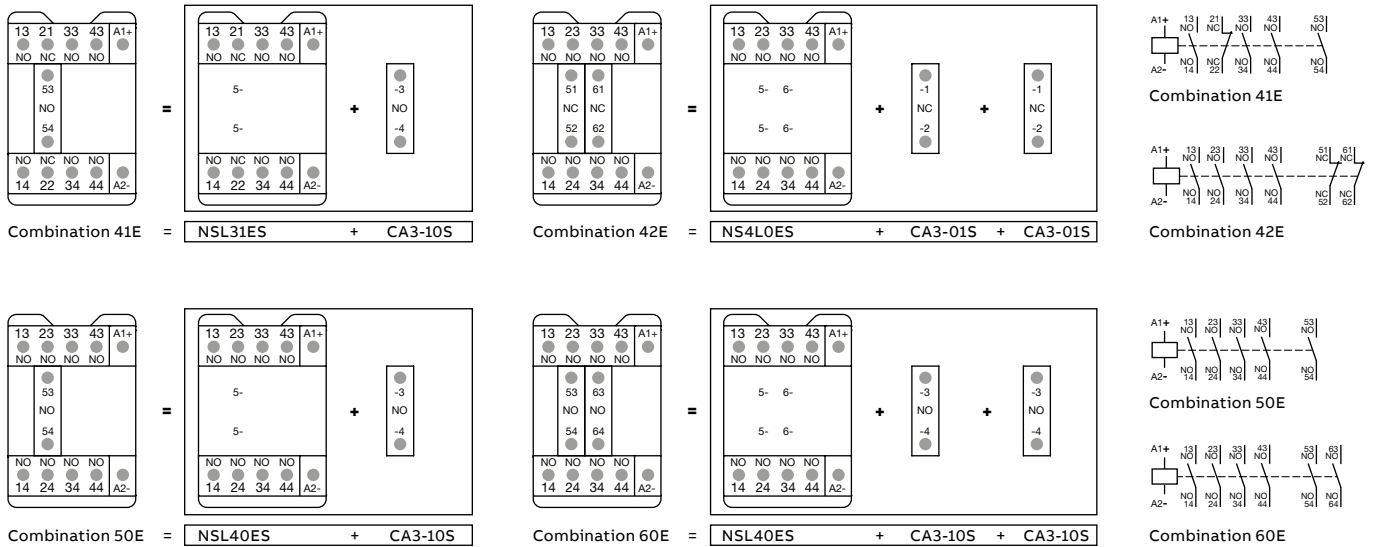

### CA3..S 1-pole auxiliary contact blocks

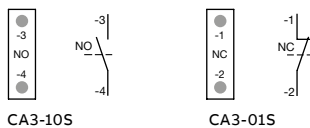



# NS..S contactor relays - with spring terminals

## Dimensions

### 4-pole contactor relays

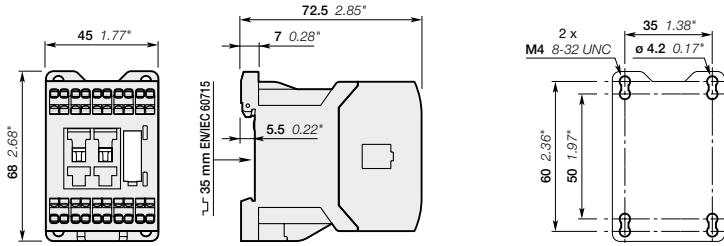

NS22ES, NS31ES, NS40ES

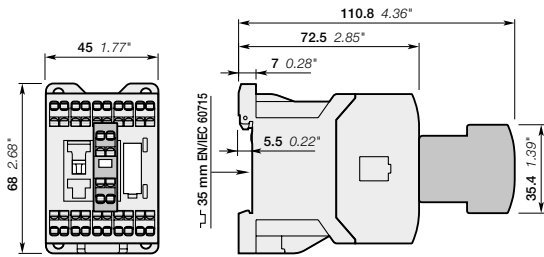

NS22ES, NS31ES, NS40ES  
+ CA3..S front-mounted 1-pole auxiliary contact block

### 8-pole contactor relays

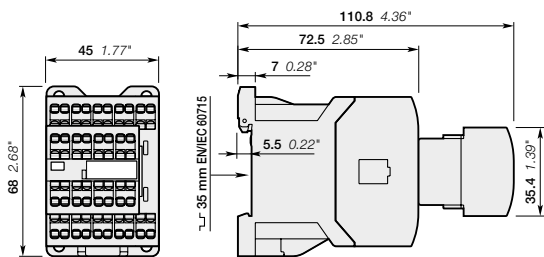

NS44ES, NS53ES, NS62ES, NS71ES, NS80ES

Main dimensions mm, inches

# NSL..S contactor relays - with spring terminals

## Dimensions

### 4-pole contactor relays

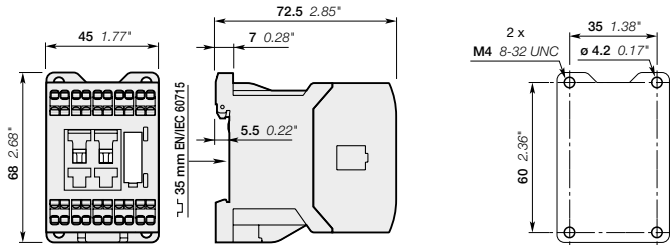

NSL22ES, NSL31ES, NSL40ES

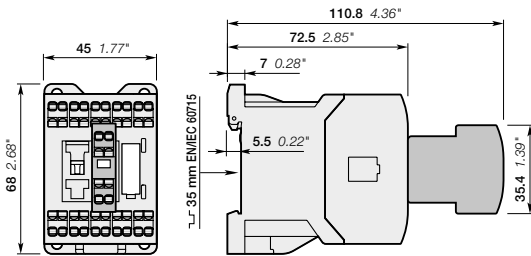

NSL22ES, NSL31ES, NSL40ES  
+ CA3..S front-mounted 1-pole auxiliary contact block

### 8-pole contactor relays

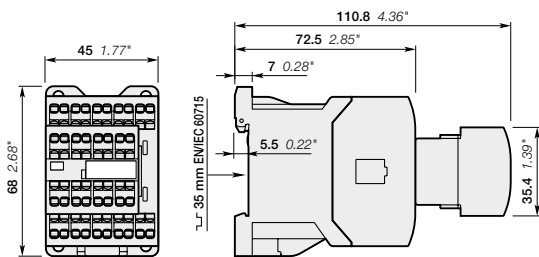

NSL44ES, NSL53ES, NSL62ES, NSL71ES, NSL80ES

Main dimensions mm, inches

## Auxiliary contact blocks - with spring terminals

### Accessories



CA3-10S

The auxiliary contact blocks are used for the operation of auxiliary circuits and control circuits. CA3 1-pole auxiliary contact blocks, designed for standard industrial environments, are equipped with:

- N.O. or N.C. contacts.
- spring-type connecting terminals.

All 1-pole auxiliary contact blocks are protected against accidental direct contact and bear the corresponding function marking.

A maximum of two 1-pole auxiliary contact blocks can be front-mounted on 1-stack contactors or 1-stack contactor relays.

For contactors	For contactor relays	Contact blocks	Type	Order code	Pkg qty	Weight (1 pce)
						kg

#### 1-pole auxiliary contact blocks with spring terminals

AS09..S ... AS16..S	NS..S, NSL..S	1 -	CA3-10S	1SBN011019T1010	10	0.011
ASL09..S ... ASL16..S		- 1	CA3-01S	1SBN011019T1001	10	0.011

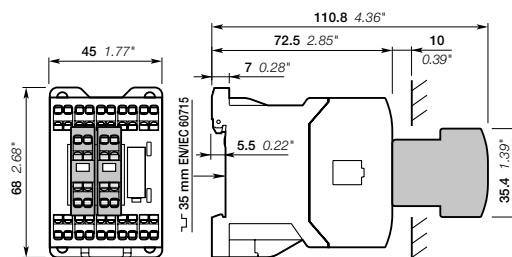

Main dimensions mm, inches

# Auxiliary contact blocks - with spring terminals

## Front mounting

### Technical data

Types	<b>1-pole CA3..S</b>
-------	----------------------



### Contact utilization characteristics according to IEC

Standards	IEC 60947-5-1 and EN 60947-5-1	
Rated insulation voltage $U_i$ acc. to IEC 60947-5-1	690 V	
Rated impulse withstand voltage $U_{imp}$	6 kV	
Rated operational voltage $U_e$ max.	690 V	
Conventional thermal current $I_{th} - \theta \leq 40^\circ C$	10 A	
I <sub>e</sub> / Rated operational current AC-15 acc. to IEC 60947-5-1	24-127 V 50/60 Hz	6 A
	220-240 V 50/60 Hz	4 A
	400-440 V 50/60 Hz	3 A
	500 V 50/60 Hz	2 A
	690 V 50/60 Hz	2 A
Making capacity	10 x I <sub>e</sub> AC-15 acc. to IEC 60947-5-1	
Breaking capacity	10 x I <sub>e</sub> AC-15 acc. to IEC 60947-5-1	
I <sub>e</sub> / Rated operational current DC-13 acc. to IEC 60947-5-1	24 V DC	6 A / 144 W
	48 V DC	2.8 A / 134 W
	72 V DC	1 A / 72 W
	110 V DC	0.55 A / 60 W
	125 V DC	0.55 A / 69 W
	220 V DC	0.27 A / 60 W
	250 V DC	0.27 A / 68 W
Short-circuit protection device gG type fuse	10 A	
Rated short-time withstand current I <sub>cw</sub> $\theta = 40^\circ C$	for 1.0 s	100 A
	for 0.1 s	140 A
Minimum switching capacity with failure rate acc. to IEC 60947-5-4	12 V / 3 mA	
	10-7	
Power dissipation per pole at 6 A	0.1 W	
Mechanical durability	10 millions operating cycles	
Number of operating cycles	3600 cycles/h	
Max. switching frequency	3600 cycles/h	
Max. electrical switching frequency	AC-15	1200 cycles/h
	AC-13	900 cycles/h
Mechanically linked contact acc. to annex L of IEC 60947-5-1	Additional N.O. or N.C. auxiliary contacts (CA3..S aux. contact blocks) are mechanically linked contacts	
Mirror contacts acc. to annex F of IEC 60947-4-1	Additional N.C. auxiliary contacts (CA3..S aux. contact blocks) are mirror contacts	

### Contact utilization characteristics according to UL / CSA

Standards	UL 508, CSA C22.2 N°14	
Max. operational voltage	690 V AC, 250 V DC	
Pilot duty	A600, Q300	
AC thermal rated current	10 A	
AC maximum volt-ampere making	7200 VA	
AC maximum volt-ampere breaking	720 VA	
DC thermal rated current	2.5 A	
DC maximum volt-ampere making-breaking	69 VA	

### Connecting characteristics

Connection capacity (min. ... max.)		
	Rigid solid	1 x 0.75...2.5 mm <sup>2</sup>
		2 x 0.75...2.5 mm <sup>2</sup>
	Flexible with non insulated ferrule	1 x 0.75...2.5 mm <sup>2</sup>
		2 x 0.75...2.5 mm <sup>2</sup>
	Flexible with insulated ferrule	1 x 0.75...1.5 mm <sup>2</sup>
		2 x 0.75...1.5 mm <sup>2</sup>
Connection capacity acc. to UL / CSA	1 or 2 x	AWG 18...14
Stripping length	10 mm	
Degree of protection acc. to IEC 60947-1 / EN 60947-1 and IEC 60529 / EN 60529	IP20	
Screw terminals	Spring terminals	
All terminals	Spring terminals	
Screwdriver type	Flat Ø 3.5	

# Auxiliary contact blocks for AS09..S ... AS16..S, ASL09..S ... ASL16..S contactors and NS, NSL contactor relays - with spring terminals

## Electrical durability

### Electrical durability for AC-15 utilization category - $U_e \leq 400\text{ V}$

AC-15 utilization category according to IEC 60947-5-1 / EN 60947-5-1:

- making current:  $10 \times I_e$  with  $\cos \phi = 0.7$  and  $U_e$
- breaking current:  $I_e$  with  $\cos \phi = 0.4$  and  $U_e$ .

This curve represents the electrical durability of the built-in or add-on auxiliary contacts in relation to the breaking current.

The curve has been drawn for resistive and inductive loads up to 400 V:

- AS09..S ... AS16..S and ASL09..S ... ASL16..S contactor built-in auxiliary contacts
- 1-pole CA3..S
- NS..S and NSL..S contactor relays.

Millions of operating cycles

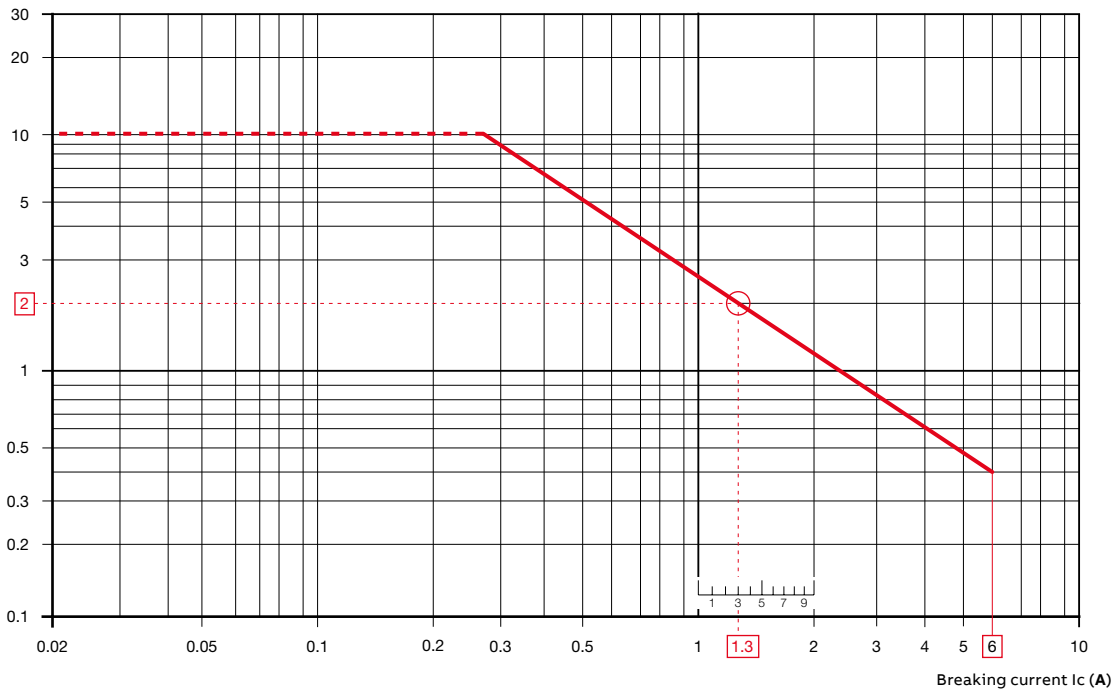

### Example:

Breaking current = 1.3 A

On the opposite curve at intersection "O" 1.3 A the corresponding value for the electrical durability is approximately 2 millions operating cycles.

—  
**Notes**

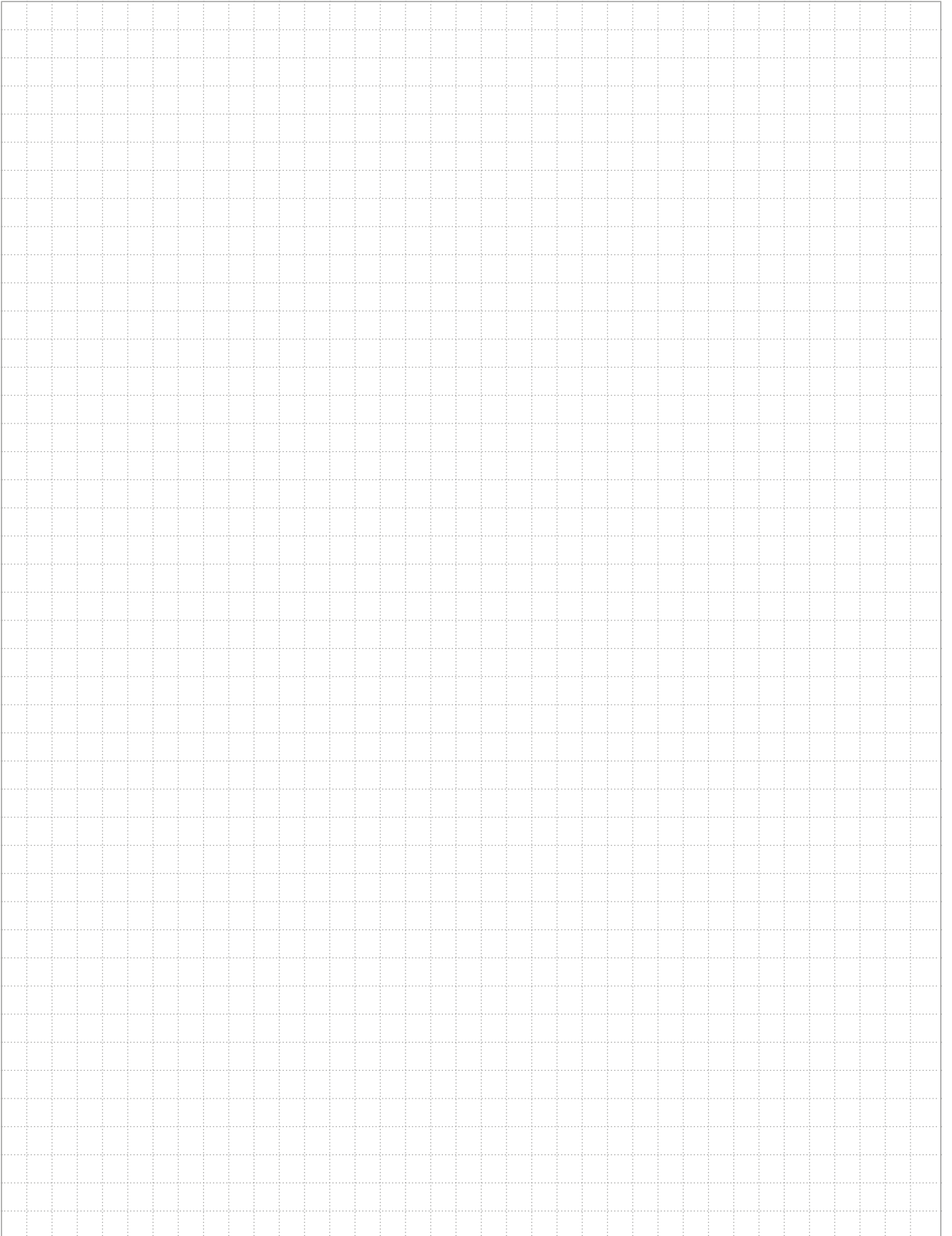

# Surge suppressors for contactor coils

## Accessories

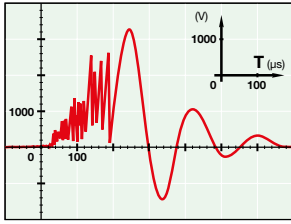

The operation of inductive circuits causes overvoltages, in particular on opening the contactor coil. The electromagnetic energy stored in the coil during contactor closing is restored on opening in the form of surges, the slope and amplitude of which may rise to several kilovolts. A number of drawbacks are observed ranging from interference on the electronic devices to the breakdown of insulators and even the destruction of certain sensitive components.

The graph opposite reproduces the oscillogram showing voltage discharges at the terminals of a 42 V / 50 Hz coil without peak clipping. The coil was switched by 8 series-connected poles of a contactor relay.

Following a burst of discharges with a very steep slope, a damped oscillation emerges with a peak value of 3500 V.

### Overvoltage Factor

The overvoltage factor  $k$  is defined as the ratio of the maximum overvoltage peak value  $\hat{U}_s$  to the peak value  $\hat{U}_c$  of the coil rated control voltage  $U_c$ :

$$k = \frac{\hat{U}_s \text{ max.}}{\hat{U}_c} \quad \text{in DC} \quad k = \frac{\hat{U}_s \text{ max.}}{U_c} \quad \text{in AC} \quad k = \frac{\hat{U}_s \text{ max.}}{U_c \sqrt{2}}$$

For example the following is obtained for the above graph:  $k = \frac{3500}{42 \sqrt{2}} \approx 60$

To reduce the harmful effects of these overvoltages, ABB has developed a range of surge suppressors designed to reduce the  $k$  factor defined above and to limit or even completely eliminate the high pre-damping voltage frequencies.

Each case is different, but the technical data tolerances and generous sizing of parts have enabled us to reduce the number of variants.

We have chosen the following solutions: transil diodes, varistors and RC blocks.

Note: A varistor is a resistor whose value decreases to a very large extent when a certain voltage is applied at its terminals.



RV5



RC5-1



RT5

For contactors	For contactor relays	Rated control circuit voltage - $U_c$		Type	Order code	Pkg qty	Weight (1 pce) kg	
		V	DC					AC
AS...S, ASL...S	NS...S, NSL...S	24...50	●	●	RV5/50	1SBN050010R1000	2	0.015
		50...133	●	●	RV5/133	1SBN050010R1001	2	0.015
		110...250	●	●	RV5/250	1SBN050010R1002	2	0.015
		250...440	●	●	RV5/440	1SBN050010R1003	2	0.015
AS...S	NS...S	24...50	-	●	RC5-1/50	1SBN050100R1000	2	0.012
		50...133	-	●	RC5-1/133	1SBN050100R1001	2	0.012
		110...250	-	●	RC5-1/250	1SBN050100R1002	2	0.012
		250...440	-	●	RC5-1/440	1SBN050100R1003	2	0.012
ASL...S	NSL...S	12...32	●	-	RT5/32	1SBN050020R1000	2	0.015
		25...65	●	-	RT5/65	1SBN050020R1001	2	0.015
		50...90	●	-	RT5/90	1SBN050020R1002	2	0.015
		77...150	●	-	RT5/150	1SBN050020R1003	2	0.015
		150...264	●	-	RT5/264	1SBN050020R1004	2	0.015

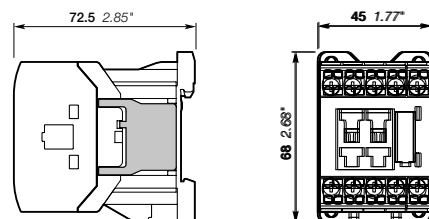

Main dimensions mm, inches

**Easy connection to the coil terminals**  
(parallel mounting)  
Clip-on for both fixing and connection.

**No additional space**  
Clipped onto the right side part of the contactor base without changing contactor overall dimensions and keeping a free access to coil terminals.

# Surge suppressors for contactor coils

## Technical data

Varistor	RV5/50	RV5/133	RV5/250	RV5/440
Rated control circuit voltage Uc	24...50 V AC 24...50 V DC	50...133 V AC 50...133 V DC	110...250 V AC 110...250 V DC	250...440 V AC 250...440 V DC
Residual overvoltage (clipping voltage)	132 V AC 132 V DC	270 V AC 270 V DC	480 V AC 480 V DC	825 V AC 825 V DC
Opening time growth factor	none			
Operating temperature	-20...+70 °C			
Advantages	High energy absorption: good damping - Unpolarized system.			
Drawback	Clipping as from Uvdr*, thus voltage front up to this point.			
	*Uvdr = Varistor operating voltage (voltage dependent resistor), tolerance ± 10 %.			

RC type	RC5-1/50	RC5-1/133	RC5-1/250	RC5-1/440
Rated control circuit voltage Uc	24...50 V AC	50...133 V AC	110...250 V AC	250...440 V AC
Residual overvoltage (clipping voltage)	2 to 3 x Uc max.			
Opening time growth factor	2...3			
Operating temperature	-20...+70 °C			
Advantages	Very fast clipping - Attenuation of steep fronts and thus of high frequencies.			

Transil diode	RT5/32	RT5/65	RT5/90	RT5/150	RT5/264
Rated control circuit voltage Uc	12...32 V DC	25...65 V DC	50...90 V DC	77...150 V DC	150...264 V DC
Residual overvoltage (clipping voltage)	50 V DC	100 V DC	150 V DC	210 V DC	390 V DC
Opening time growth factor	1.1...1.2				
Operating temperature	-20...+70 °C				
Advantages	Good energy absorption - Unpolarized system - Simple, reliable system.				
Drawback	Delay on drop out which does not however reduce contactor breaking capacity.				

### Wiring diagrams

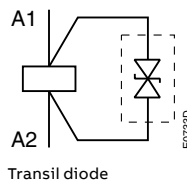
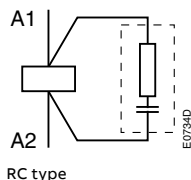
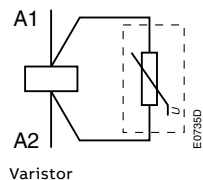



## Connecting links for starting solutions and other accessories



### Connecting links

The BEA16-3U insulated connecting links are used to connect an AS..S AC operated contactor or an ASL..S DC operated contactor with a manual motor starter.

The connecting link ensure the electrical and mechanical connection between the contactor and the manual motor starter.

For contactors	Manual motor starter	Type	Order code	Pkg qty	Weight (1 pce) kg
AS09..S ... AS16..S	MS116-0.16 ... MS116-16	BEA16-3U	1SBN081020R1000	1	0.045
ASL09..S ... ASL16..S	MS132-0.16 ... MS132-16				



### Test block

BDT4 test block is suitable for switching on contactor off-load.

Marking on the block indicates the contactor type to fit with.

For contactors	Type	Order code	Pkg qty	Weight (1 pce) kg
AS..S, ASL..S, NS..S, NSL..S	BDT4	1SBN110122T1000	10	0.007



### Function markers

Box of 16 blank cards (16 markers by card) printable on HTP500 thermal transfer printer and AMS 500 marking table to identify your contactors, overload relays or manual motor starters. Marker dimensions: 7 x 20 mm (.276" x .787").

For contactors	Type	Order code	Pkg qty	Weight (1 pce) kg
AS..S, ASL..S, NS..S, NSL..S	BA4	1SNA235156R2700	16	0.011
AMS 500 support plate for 8 BA4	SPRC 1	1SNA360010R1500	1	0.220
HTP500 support plate	HTP500-BA4	1SNA235712R2400	1	0.290

## Voltage code table

The below tables indicate the available coil voltages and corresponding digits for order codes. When placing an order, please give either type or order code. Select a standard contactor from ordering detail pages. Change the coil voltage code in the type or in the order code according to the table below. Example: for contactor AS09-30-10S and coil 42 V 50/60 Hz, type is AS09-30-10S-21 and order code is 1SBL101004R2110.

### 3-pole contactors - with spring terminals

**Type**  
AS16 - 30 - 10 S - 26

**Order code**  
1SBL121004R 26 10

**Contactor type**  
AS AC operated  
ASL DC operated

**AC coil code**

	50 Hz	60 Hz
20	24 V	24 V
21	42 V	42 V
22	48 V	48 V
23	110 V	110 V
24	115 V	115 V
16	-	120 V
25	220 V	220 V
26	230 V	230 V
27	240 V	240 V
17	-	277 V
13	380 V	-
28	400 V	400 V
29	415 V	415 V

**DC coil code**

80	12 V
81	24 V
83	48 V
84	60 V
86	110 V
87	125 V
88	220 V
89	240 V

### Contactor relays - with spring terminals

**Type**  
NS 40 E S - 26

**Order code**  
1SBH101004R 26 40

**Contactor type**  
NS AC operated  
NSL DC operated

**AC coil code**

	50 Hz	60 Hz
20	24 V	24 V
21	42 V	42 V
22	48 V	48 V
23	110 V	110 V
24	115 V	115 V
16	-	120 V
25	220 V	220 V
26	230 V	230 V
27	240 V	240 V
17	-	277 V
13	380 V	-
28	400 V	400 V
29	415 V	415 V

**DC coil code**

80	12 V
81	24 V
83	48 V
84	60 V
86	110 V
87	125 V
88	220 V
89	240 V



—

**For direct product details information, use product type or order code, ex:**

[www.abb.com/productdetails/T16-1.3](http://www.abb.com/productdetails/T16-1.3)  
or  
[www.abb.com/productdetails/1SAZ711201R1025](http://www.abb.com/productdetails/1SAZ711201R1025)

# Overload relays

## 6/2 Overview

### Thermal overload relays

- 6/4 T16 thermal overload relays – 0.10 to 16.0 A
- 6/8 TF42 thermal overload relays – 0.10 to 38.0 A
- 6/13 TF65 thermal overload relays – 22.0 to 67.0 A
- 6/17 TF96 thermal overload relays – 40.0 to 96.0 A
- 6/21 TF140DU thermal overload relays – 66 to 142 A
- 6/25 TA200DU thermal overload relays – 66 to 200 A

### Electronic overload relays

- 6/29 E16DU, EF19, EF45 electronic overload relays – 0.10 to 45.0 A
- 6/33 EF65, EF96, EF146 electronic overload relays – 20 to 150 A
- 6/37 EF205, EF370 electronic overload relays – 63 to 380 A
- 6/41 EF460, EF750, EF1250DU electronic overload relays  
150 to 1250 A

## 6/44 General accessories

# Thermal and electronic overload relays

## Thermal overload relays

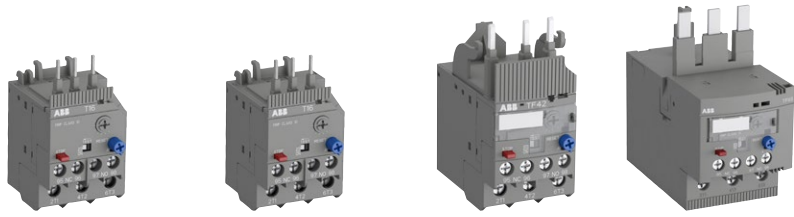

IEC: rated operational power AC-3	400 V	0.06 ... 7.5 kW	0.06 ... 7.5 kW	0.06 ... 18.5 kW	11 ... 37 kW
UL/CSA: 3-phase hp-ratings	480 V	1/2 ... 10 hp	1/2 ... 10 hp	1/2 ... 25 hp	15 ... 50 hp
Fitting to contactors		B6, B7	AS09 ... AS16	AF09 ... AF38	AF40, AF52, AF65
<b>Type</b>		<b>T16</b>	<b>T16</b>	<b>TF42</b>	<b>TF65</b>
Current range		0.10 ... 16 A	0.10 ... 16 A	0.10 ... 38 A	22 ... 67 A
Trip class		10	10	10	10
Single mounting kit		DB16	DB16	DB42	DB65

## Electronic overload relays with integrated CT

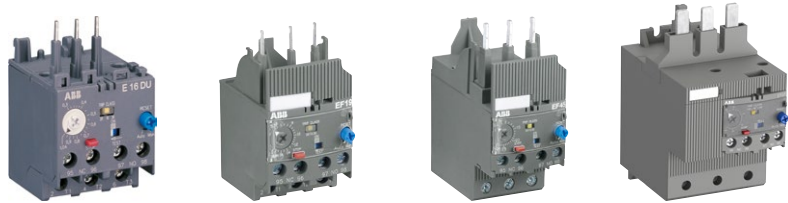

IEC: rated operational power AC-3	400 V	0.06 ... 7.5 kW	0.06 ... 7.5 kW	4 ... 22 kW	7.5 ... 37 kW
UL/CSA: 3-phase hp-ratings	480 V	1/2 ... 10 hp	1/2 ... 10 hp	5 ... 30 hp	15 ... 50 hp
Fitting to contactors		B6, B7, BC6, BC7, VB6, VB7, VBC6, VBC7	AF09 ... AF38	AF26 ... AF38	AF40, AF52, AF65
<b>Type</b>		<b>E16DU</b>	<b>EF19</b>	<b>EF45</b>	<b>EF65</b>
Current range		0.10 ... 18.9 A	0.10 ... 18.9 A	9 ... 45 A	20 ... 70 A
Trip class		10E, 20E, 30E selectable			
Single mounting kit		DB16E	DB19EF	DB45EF	-

## Electronic overload relays with external separate CT



IEC: rated operational power AC-3	400 V	75 ... 250 kW	132 ... 400 kW	250 ... 710 kW
UL/CSA: 3-phase hp-ratings	480 V	100 ... 400 hp	200 ... 500 hp	600 ... 900 hp
Fitting to contactors		AF400, AF460	AF580, AF750, AF1250	AF1350, AF1650, AF2050
<b>Type</b>		<b>EF460</b>	<b>EF750</b>	<b>EF1250DU</b>
Current range		150 ... 500 A	250 ... 800 A	375 ... 1250 A
Trip class		10E, 20E, 30E selectable		

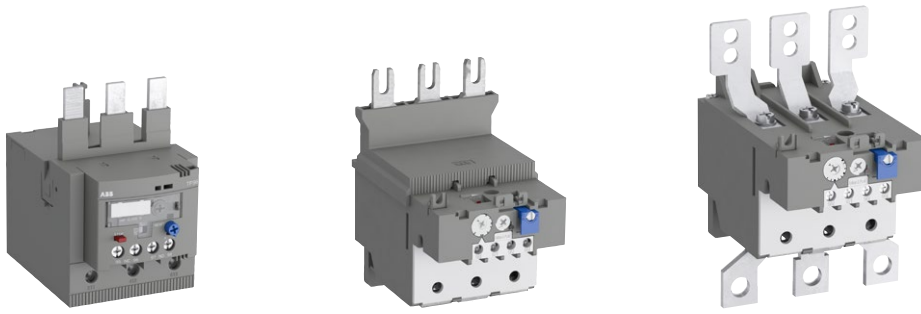

18.5 ... 45 kW	37 ... 75 kW	37 ... 110 kW
30 ... 75 hp	50 ... 100 hp	50 ... 150 hp
AF80, AF96	AF116, AF140, AF146	AF190, AF205
<b>TF96</b>	<b>TF140DU</b>	<b>TA200DU</b>
40 ... 96 A	66 ... 142 A	66 ... 200 A
10	10A	10A
DB96	-	DB200

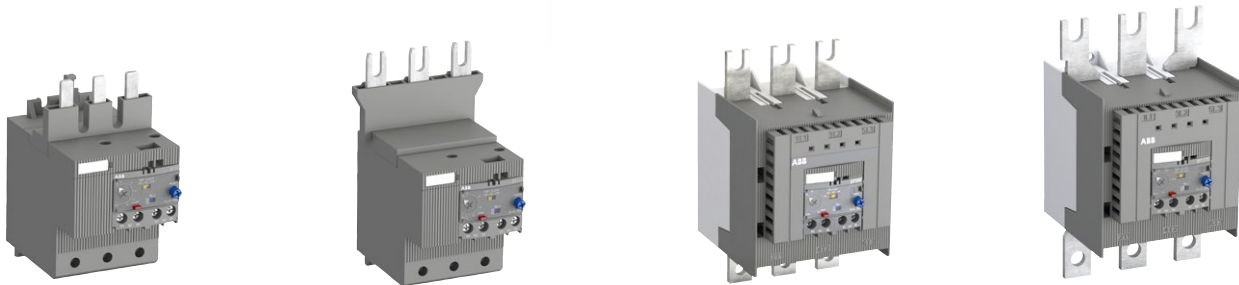

22 ... 55 kW	30 ... 75 kW	37 ... 110 kW	75 ... 200 kW
30 ... 75 hp	50 ... 100 hp	50 ... 150 hp	100 ... 300 hp
AF80, AF96	AF116, AF140, AF146	AF190, AF205	AF265, AF305, AF370
<b>EF96</b>	<b>EF146</b>	<b>EF205</b>	<b>EF370</b>
36 ... 100 A	54 ... 150 A	63 ... 210 A	115 ... 380 A
10E, 20E, 30E selectable			
DB96	-	-	-

### Single mounting kit overview

#### TOL

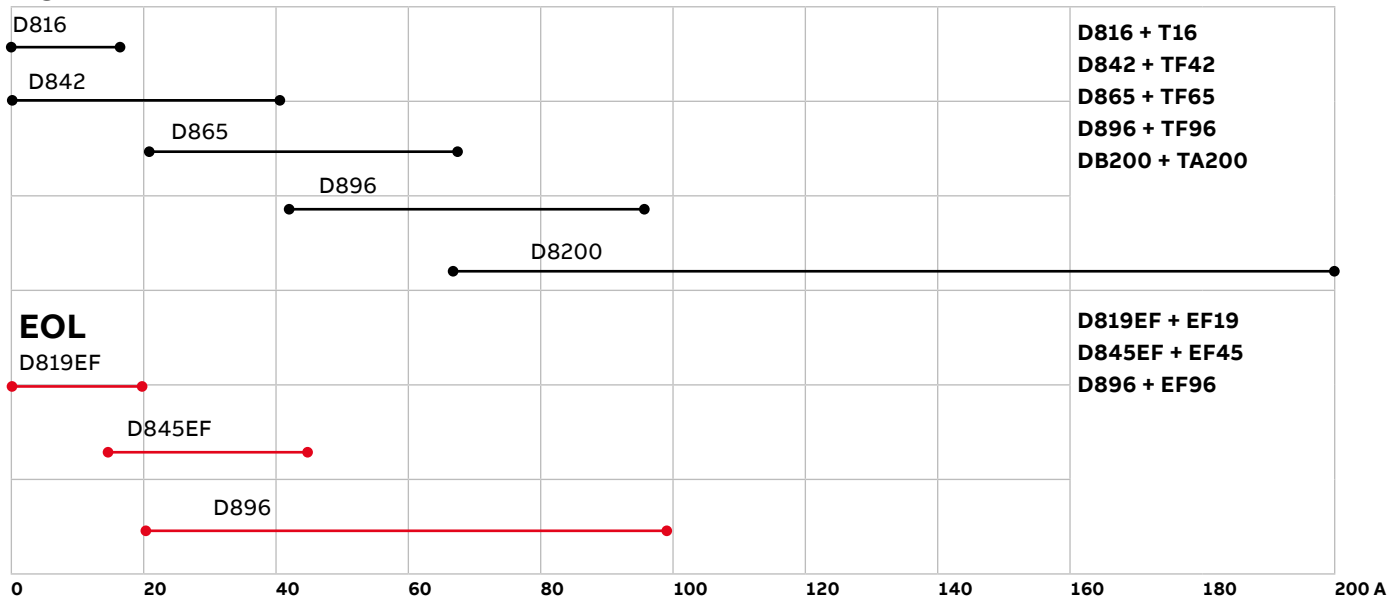

# T16 thermal overload relays – 0.10 to 16.0 A

## Ordering details



T16

2CDC23109F0013



T16 + DB16

2CDC231025F0013



KPR-101L

1SF615124F0002



DB16

2CDC231002F001

The T16 thermal overload relays are economic electromechanical protection devices for the main circuit. They offer reliable protection for motors in the event of overload or phase failure. The devices have trip class 10.

The thermal overload relays are three pole relays with bimetal tripping elements. The motor current flows through the bimetal tripping elements and heats them directly and indirectly. In case of an overload (over current), the bimetal elements bent as a result of the heating. This leads to a release of the relay and a change of the contacts switching position (95-96 / 97-98).

- Manual or automatic reset selectable
- Phase loss sensitive acc. to IEC/EN 60947-4-1
- TEST and STOP function – Trip indication on the front
- Temperature compensation
- Suitable for three- and single-phase applications

Setting range	Short-circuit protective device	Trip class	Type	Order code	Weight (1 pce) kg
A					

### Suitable for AS09...AS16, B6 and B7 all variants

0.10 ... 0.13	0.5 A, fuse type T	10	T16-0.13	1SAZ711201R1005	0.100
0.13 ... 0.17	1.0 A, fuse type T	10	T16-0.17	1SAZ711201R1008	0.100
0.17 ... 0.23	1.0 A, fuse type T	10	T16-0.23	1SAZ711201R1009	0.100
0.23 ... 0.31	1.0 A, fuse type T	10	T16-0.31	1SAZ711201R1013	0.100
0.31 ... 0.41	2.0 A, fuse type gG	10	T16-0.41	1SAZ711201R1014	0.100
0.41 ... 0.55	2.0 A, fuse type gG	10	T16-0.55	1SAZ711201R1017	0.100
0.55 ... 0.74	4.0 A, fuse type gG	10	T16-0.74	1SAZ711201R1021	0.100
0.74 ... 1.00	6.0 A, fuse type gG	10	T16-1.0	1SAZ711201R1023	0.100
1.00 ... 1.30	6.0 A, fuse type gG	10	T16-1.3	1SAZ711201R1025	0.100
1.30 ... 1.70	10.0 A, fuse type gG	10	T16-1.7	1SAZ711201R1028	0.100
1.70 ... 2.30	10.0 A, fuse type gG	10	T16-2.3	1SAZ711201R1031	0.100
2.30 ... 3.10	10.0 A, fuse type gG	10	T16-3.1	1SAZ711201R1033	0.100
3.10 ... 4.20	20.0 A, fuse type gG	10	T16-4.2	1SAZ711201R1035	0.100
4.20 ... 5.70	20.0 A, fuse type gG	10	T16-5.7	1SAZ711201R1038	0.100
5.70 ... 7.60	35.0 A, fuse type gG	10	T16-7.6	1SAZ711201R1040	0.100
7.60 ... 10.0	35.0 A, fuse type gG	10	T16-10	1SAZ711201R1043	0.104
10.0 ... 13.0	40.0 A, fuse type gG	10	T16-13	1SAZ711201R1045	0.104
13.0 ... 16.0	40.0 A, fuse type gG	10	T16-16	1SAZ711201R1047	0.104

### Ordering details accessories

Description	Suitable for	Type	Order code	Weight (1 pce) kg
Single mounting kit	T16	DB16	1SAZ701901R0001	0.032
Reset push button	E16, EF, TF, T16, TA200	KPR-101L	1SF616162R1014	0.027

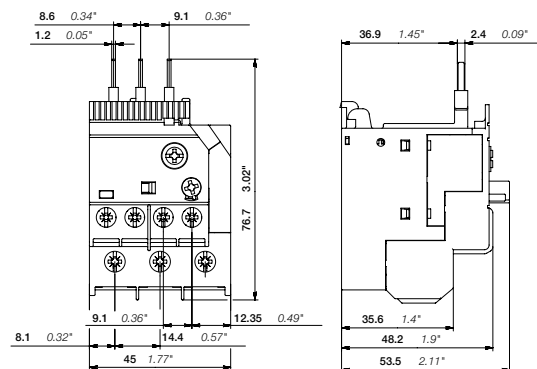

T16

Main dimensions mm, inches

2CDC232008F0008

2CDC106036C0201

# T16 thermal overload relays – 0.10 to 16.0 A

## Technical data

### Main circuit – Utilization characteristics according to IEC/EN

Type	<b>T16</b>
Standards	IEC/EN 60947-4-1, IEC/EN 60947-5-1, IEC/EN 60947-1
Rated operational voltage Ue	690 V AC - V DC
Rated frequency	50/60 Hz
Trip class	10
Number of poles	3
Duty time	100%
Operating frequency without early tripping	Up to 15 operations/h, see "Technical diagram – Intermittent periodic duty"
Rated impulse withstand voltage Uimp	6 kV
Rated insulation voltage Ui	690 V AC

### Auxiliary circuit according to IEC/EN

Type	<b>T16</b>
Rated operational voltage Ue	600 V
Conventional free air thermal current Ith	N.C., 95-96 6 A N.O., 97-98 4 A
Rated frequency	DC, 50/60 Hz
Number of poles	1 N.O. + 1 N.C.
Ie / Rated operational current AC-15 acc. to IEC/EN 60947-5-1 for utilization category	
110-120 V	N.C., 95-96 3.00 A N.O., 97-98 0.75 A
220-230-240 V	N.C., 95-96 3.00 A N.O., 97-98 0.75 A
440 V	N.C., 95-96 0.75 A N.O., 97-98 0.75 A
480-500 V	N.C., 95-96 0.75 A N.O., 97-98 0.75 A
Ie / Rated operational current DC-13 acc. to IEC/EN 60947-5-1 for utilization category	
24 V	N.C., 95-96 1.25 A N.O., 97-98 1.25 A
60 V	N.C., 95-96 0.55 A N.O., 97-98 0.55 A
110-120-125 V	N.C., 95-96 0.55 A N.O., 97-98 0.55 A
250 V	N.C., 95-96 0.27 A N.O., 97-98 0.27 A
Minimum switching capacity	17 V / 3 mA
Short-circuit protective device	N.C., 95-96 6 A, fuse type gG N.O., 97-98 4 A, fuse type gG
Rated impulse withstand voltage Uimp	6 kV
Rated insulation voltage Ui	690 V

### Technical diagram – Intermittent periodic duty

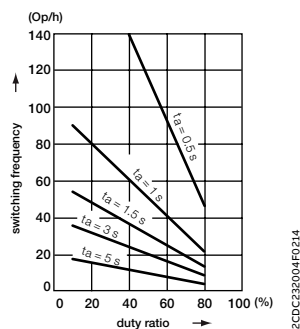

ta: Motor starting time



## T16 thermal overload relays – 0.10 to 16.0 A

### Technical data

#### Main circuit – Utilization characteristics according to UL/CSA

Type	<b>T16</b>
Standards	UL 508, CSA 22.2 No. 14
Maximum operational voltage	600 V AC
Trip rating	125% of FLA
Full load amps (FLA)	See table "Full load amps and short-circuit protective device"
Short-circuit rating RMS symmetrical	See table "Full load amps and short-circuit protective device"
Short-circuit protective device	See table "Full load amps and short-circuit protective device"

#### Auxiliary circuit according to UL/CSA

Type	<b>T16</b>	
Contact rating	N.C., 95-96	B600, Q300
	N.O., 97-98	D300, Q300
Conventional thermal current	N.C., 95-96	5 A
	N.O., 97-98	2.5 A

#### Full load amps and short-circuit protective device

Type	Full load amps (FLA)	Short-circuit protective device 480 / 600 V AC		480 / 600 V AC	
		Short circuit rating RMS symmetrical	Fuse type	Short circuit rating RMS symmetrical	Fuse type
T16-0.13	0.13 A	18 kA	1 A, K5	100 kA	30 A, Class J
T16-0.17	0.17 A	18 kA	1 A, K5	100 kA	30 A, Class J
T16-0.23	0.23 A	18 kA	1 A, K5	100 kA	30 A, Class J
T16-0.31	0.31 A	18 kA	3 A, K5	100 kA	30 A, Class J
T16-0.41	0.41 A	18 kA	3 A, K5	100 kA	30 A, Class J
T16-0.55	0.55 A	18 kA	3 A, K5	100 kA	30 A, Class J
T16-0.74	0.74 A	18 kA	3 A, K5	100 kA	30 A, Class J
T16-1.0	1.00 A	18 kA	6 A, K5	100 kA	30 A, Class J
T16-1.3	1.30 A	18 kA	6 A, K5	100 kA	30 A, Class J
T16-1.7	1.70 A	18 kA	6 A, K5	100 kA	30 A, Class J
T16-2.3	2.30 A	18 kA	10 A, K5	100 kA	30 A, Class J
T16-3.1	3.10 A	18 kA	10 A, K5	100 kA	30 A, Class J
T16-4.2	4.20 A	18 kA	15 A, K5	100 kA	30 A, Class J
T16-5.7	5.70 A	18 kA	20 A, K5	100 kA	30 A, Class J
T16-7.6	7.60 A	18 kA	25 A, K5	100 kA	30 A, Class J
T16-10	10.0 A	18 kA	35 A, K5	100 kA	45 A, Class J
T16-13	13.0 A	18 kA	40 A, K5	100 kA	45 A, Class J
T16-16	16.0 A	18 kA	60 A, K5	100 kA	45 A, Class J

# T16 thermal overload relays – 0.10 to 16.0 A



## Technical data

### General technical data





Type	<b>T16</b>	
Pollution degree	3	
Phase loss sensitive	Yes	
Ambient air temperature		
Operation	Open - compensated	-25 ... +60 °C
	Open	-25 ... +60 °C
Storage		-50 ... +80 °C
Ambient air temperature compensation	Acc. to IEC/EN60947-4-1	
Maximum operating altitude permissible	2000 m	
Resistance to shock acc. to IEC 60068-2-27	25g / 11 ms	
Resistance to vibrations acc. to IEC 60068-2-6	3g / 3 ... 150 Hz	
Mounting position	Position 1-5	
Mounting	Mount on the contactor and tighten the screws of the main circuit terminals or with single mounting kit on DIN rail (35 mm)	
Degree of protection	Housing	IP20
	Main circuit terminals	IP10

### Electrical connection

#### Main circuit

Type	<b>T16</b>	
Connecting capacity		
 Rigid	1 x	0.75 ... 4 mm <sup>2</sup>
	2 x	0.75 ... 1.5 mm <sup>2</sup> or 1.5 ... 4 mm <sup>2</sup> (1)
 Flexible	1 x or 2 x	0.75 ... 4 mm <sup>2</sup>
Stranded acc. to UL/CSA	1 x or 2 x	AWG 18-10
Flexible acc. to UL/CSA	1 x or 2 x	AWG 18-10
Stripping length	12 mm	
Tightening torque	1.1 ... 1.5 Nm / 9 ... 13 lb.in	
Recommended screw driver	M4 (Pozidriv 2)	

#### Auxiliary circuit

Type	<b>T16</b>	
Connecting capacity		
 Rigid	1 x or 2 x	0.75 ... 4 mm <sup>2</sup>
 Flexible with ferrule	1 x or 2 x	0.75 ... 2.5 mm <sup>2</sup>
 Flexible with insulated ferrule	1 x	0.75 ... 2.5 mm <sup>2</sup>
	2 x	0.75 ... 1.5 mm <sup>2</sup>
 Flexible	1 x or 2 x	0.75 ... 1 mm <sup>2</sup> or 1 ... 2.5 mm <sup>2</sup> (1)
Stranded acc. to UL/CSA	1 x or 2 x	AWG 18-12
Flexible acc. to UL/CSA	1 x or 2 x	AWG 18-12
Stripping length	9 mm	
Tightening torque	1.1 ... 1.5 Nm / 9 ... 13 lb.in	
Recommended screw driver	M3 (Pozidriv 2)	

(1) Only connect two different "conductor/wire" cross-sections, if they are within the indicated ranges

# TF42 thermal overload relays – 0.10 to 38.0 A

## Ordering details



TF42

2CDC231006F0013



TF42 + DB42

2CDC231026F0013

The TF42 thermal overload relays are economic electromechanical protection devices for the main circuit. They offer reliable protection for motors in the event of overload or phase failure. The devices have trip class 10.

The thermal overload relays are three pole relays with bimetal tripping elements. The motor current flows through the bimetal tripping elements and heats them directly and indirectly. In case of an overload (over current), the bimetal elements bent as a result of the heating. This leads to a release of the relay and a change of the contacts switching position (95-96 / 97-98).

- Manual or automatic reset selectable
- Phase loss sensitive acc. to IEC/EN 60947-4-1
- TEST and STOP function – Trip indication on the front
- Temperature compensation
- Suitable for three- and single-phase applications
- With ATEX certification

Setting range	Short-circuit protective device	Trip class	Type	Order code	Weight (1 pce) kg
A					

### Suitable for AF09...AF38 contactors

0.10 ... 0.13	0.5 A, fuse type T	10	TF42-0.13	1SAZ721201R1005	0.130
0.13 ... 0.17	1.0 A, fuse type T	10	TF42-0.17	1SAZ721201R1008	0.130
0.17 ... 0.23	1.0 A, fuse type T	10	TF42-0.23	1SAZ721201R1009	0.130
0.23 ... 0.31	1.0 A, fuse type T	10	TF42-0.31	1SAZ721201R1013	0.130
0.31 ... 0.41	2.0 A, fuse type gG	10	TF42-0.41	1SAZ721201R1014	0.130
0.41 ... 0.55	2.0 A, fuse type gG	10	TF42-0.55	1SAZ721201R1017	0.130
0.55 ... 0.74	4.0 A, fuse type gG	10	TF42-0.74	1SAZ721201R1021	0.130
0.74 ... 1.00	6.0 A, fuse type gG	10	TF42-1.0	1SAZ721201R1023	0.130
1.00 ... 1.30	6.0 A, fuse type gG	10	TF42-1.3	1SAZ721201R1025	0.130
1.30 ... 1.70	10.0 A, fuse type gG	10	TF42-1.7	1SAZ721201R1028	0.130
1.70 ... 2.30	10.0 A, fuse type gG	10	TF42-2.3	1SAZ721201R1031	0.130
2.30 ... 3.10	10.0 A, fuse type gG	10	TF42-3.1	1SAZ721201R1033	0.130
3.10 ... 4.20	20.0 A, fuse type gG	10	TF42-4.2	1SAZ721201R1035	0.130
4.20 ... 5.70	20.0 A, fuse type gG	10	TF42-5.7	1SAZ721201R1038	0.130
5.70 ... 7.60	35.0 A, fuse type gG	10	TF42-7.6	1SAZ721201R1040	0.130
7.60 ... 10.0	35.0 A, fuse type gG	10	TF42-10	1SAZ721201R1043	0.130
10.0 ... 13.0	40.0 A, fuse type gG	10	TF42-13	1SAZ721201R1045	0.130
13.0 ... 16.0	40.0 A, fuse type gG	10	TF42-16	1SAZ721201R1047	0.130
16.0 ... 20.0	63.0 A, fuse type gG	10	TF42-20	1SAZ721201R1049	0.145
20.0 ... 24.0	63.0 A, fuse type gG	10	TF42-24	1SAZ721201R1051	0.145
24.0 ... 29.0	63.0 A, fuse type gG	10	TF42-29	1SAZ721201R1052	0.145
29.0 ... 35.0	80.0 A, fuse type gG	10	TF42-35	1SAZ721201R1053	0.145
35.0 ... 38.0/40.0	80.0 A, fuse type gG	10	TF42-38	1SAZ721201R1055	0.145

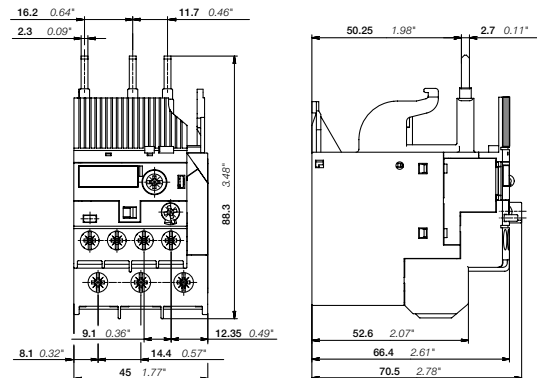

TF42

Main dimensions mm, inches

2CDC232005F0009

2CDC106046C0201

# TF42 thermal overload relays – 0.10 to 38.0 A

## Ordering details



DB42

2CDC231000F0011



KPR-101L

1SFCL51224-F0002

### Ordering details accessories

Description	Suitable for	Type	Order code	Weight (1 pce) kg
Single mounting kit	TF42	DB42	1SAZ701902R0001	0.087
Reset push button	E16, EF, TF, T16, TA200	KPR-101L	1SFA616162R1014	0.019
Remote reset coil 24-30 V AC/DC	TF42, TF65, TF96	DRS-F-01	1SAX101911R1001	0.077
Remote reset coil 48-60 V AC/DC		DRS-F-02	1SAX101911R1002	0.077
Remote reset coil 110-127 V AC/DC		DRS-F-03	1SAX101911R1003	0.077
Remote reset coil 220-240 V AC/DC		DRS-F-04	1SAX101911R1004	0.077

# TF42 thermal overload relays – 0.10 to 38.0 A

## Technical data

### Main circuit – Utilization characteristics according to IEC/EN

Type	TF42
Standards	IEC/EN 60947-4-1, IEC/EN 60947-5-1, IEC/EN 60947-1
Rated operational voltage Ue	690 V AC
Rated frequency	50/60 Hz
Trip class	10
Number of poles	3
Duty time	100%
Operating frequency without early tripping	Up to 15 operations/h, see "Technical diagram – Intermittent periodic duty"
Rated impulse withstand voltage Uimp	6 kV
Rated insulation voltage Ui	690 V AC

### Auxiliary circuit according to IEC/EN

Type	TF42
Rated operational voltage Ue	600 V
Conventional free air thermal current Ith	N.C., 95-96 6 A N.O., 97-98 4 A
Rated frequency	DC, 50/60 Hz
Number of poles	1 N.O. + 1 N.C.
Ie / Rated operational current AC-15 acc. to IEC/EN 60947-5-1 for utilization category	
110-120 V	N.C., 95-96 3.00 A N.O., 97-98 0.75 A
220-230-240 V	N.C., 95-96 3.00 A N.O., 97-98 0.75 A
440 V	N.C., 95-96 0.75 A N.O., 97-98 0.75 A
480-500 V	N.C., 95-96 0.75 A N.O., 97-98 0.75 A
Ie / Rated operational current DC-13 acc. to IEC/EN 60947-5-1 for utilization category	
24 V	N.C., 95-96 1.25 A N.O., 97-98 1.25 A
110-120-125 V	N.C., 95-96 0.55 A N.O., 97-98 0.55 A
250 V	N.C., 95-96 0.27 A N.O., 97-98 0.27 A
Minimum switching capacity	17 V / 3 mA
Short-circuit protective device	N.C., 95-96 6 A, fuse type gG N.O., 97-98 4 A, fuse type gG
Rated impulse withstand voltage Uimp	6 kV
Rated insulation voltage Ui	690 V

### Technical diagram – Intermittent periodic duty

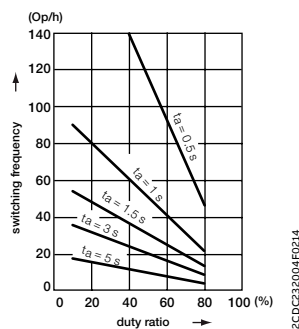

ta: Motor starting time

# TF42 thermal overload relays – 0.10 to 38.0 A

## Technical data

### Main circuit – Utilization characteristics according to UL/CSA

Type	<b>TF42</b>
Standards	UL 508, CSA 22.2 No. 14
Maximum operational voltage	600 V AC
Trip rating	125% of FLA
Full load amps (FLA)	See table "Full load amps and short-circuit protective device"
Short-circuit rating RMS symmetrical	See table "Full load amps and short-circuit protective device"
Short-circuit protective device	See table "Full load amps and short-circuit protective device"

### Auxiliary circuit according to UL/CSA

Type	<b>TF42</b>	
Contact rating	N.C., 95-96	B600, Q300
	N.O., 97-98	D300, Q300
Conventional thermal current	N.C., 95-96	5 A
	N.O., 97-98	2.5 A

### Full load amps and short-circuit protective device

Type	Full load amps (FLA)	Short-circuit protective device			
		480 / 600 V AC		480 / 600 V AC	
		Short circuit rating RMS symmetrical	Fuse type	Short circuit rating RMS symmetrical	Fuse type
TF42-0.13	0.13 A	18 kA	1 A, K5	100 kA	30 A, Class J
TF42-0.17	0.17 A	18 kA	1 A, K5	100 kA	30 A, Class J
TF42-0.23	0.23 A	18 kA	1 A, K5	100 kA	30 A, Class J
TF42-0.31	0.31 A	18 kA	3 A, K5	100 kA	30 A, Class J
TF42-0.41	0.41 A	18 kA	3 A, K5	100 kA	30 A, Class J
TF42-0.55	0.55 A	18 kA	3 A, K5	100 kA	30 A, Class J
TF42-0.74	0.74 A	18 kA	3 A, K5	100 kA	30 A, Class J
TF42-1.0	1.00 A	18 kA	6 A, K5	100 kA	30 A, Class J
TF42-1.3	1.30 A	18 kA	6 A, K5	100 kA	30 A, Class J
TF42-1.7	1.70 A	18 kA	6 A, K5	100 kA	30 A, Class J
TF42-2.3	2.30 A	18 kA	10 A, K5	100 kA	30 A, Class J
TF42-3.1	3.10 A	18 kA	10 A, K5	100 kA	30 A, Class J
TF42-4.2	4.20 A	18 kA	15 A, K5	100 kA	30 A, Class J
TF42-5.7	5.70 A	18 kA	20 A, K5	100 kA	30 A, Class J
TF42-7.6	7.60 A	18 kA	25 A, K5	100 kA	30 A, Class J
TF42-10	10.0 A	18 kA	35 A, K5	100 kA	45 A, Class J
TF42-13	13.0 A	18 kA	40 A, K5	100 kA	45 A, Class J
TF42-16	16.0 A	18 kA	60 A, K5	100 kA	45 A, Class J
TF42-20	20.0 A	18 kA	80 A, K5	100 kA	60 A, Class J
TF42-24	24.0 A	18 kA	80 A, K5	100 kA	60 A, Class J
TF42-29	29.0 A	18 kA	100 A, K5	100 kA	100 A, Class J
TF42-35	35.0 A	18 kA	150 A, K5	100 kA	175 A, Class J
TF42-38	38.0 A	18 kA	150 A, K5	100 kA	175 A, Class J

## TF42 thermal overload relays – 0.10 to 38.0 A





### Technical data

#### General technical data







Type	<b>TF42</b>	
Pollution degree	3	
Phase loss sensitive	Yes	
Ambient air temperature		
Operation	Open - compensated	-25 ... +60 °C
Storage	Open	-25 ... +60 °C
Storage		-50 ... +80 °C
Ambient air temperature compensation	Acc. to IEC/EN60947-4-1	
Maximum operating altitude permissible	2000 m	
Resistance to shock acc. to IEC 60068-2-27	25g / 11 ms	
Resistance to vibrations acc. to IEC 60068-2-6	3g / 3 ... 150 Hz	
Mounting position	Position 1-5	
Mounting	Mount on the contactor and tighten the screws of the main circuit terminals or with single mounting kit on DIN rail (35 mm)	
Degree of protection	Housing	IP20
	Main circuit terminals	IP10

#### Electrical connection

##### Main circuit

Type	<b>TF42</b>	
	<b>(TF42-0.13 ... TF42-16)</b>	<b>(TF42-20 ... TF42-38)</b>
Connecting capacity		
 Rigid	1 x or 2 x	0.75 ... 4 mm <sup>2</sup>
 Flexible with insulated ferrule	1 x or 2 x	0.75 ... 4 mm <sup>2</sup>
 Stranded acc. to UL/CSA	1 x or 2 x	AWG 18-10
 Flexible acc. to UL/CSA	1 x or 2 x	AWG 18-10
Stripping length	12 mm	
Tightening torque	1.5 - 2.5 Nm / 13 ... 22 lb.in	2.5 - 2.7 Nm / 22 lb.in
Recommended screw driver	M4 (Pozidriv 2)	

##### Auxiliary circuit

Type	<b>TF42</b>	
Connecting capacity		
 Rigid	1 x or 2 x	0.75 ... 4 mm <sup>2</sup>
 Flexible with ferrule	1 x or 2 x	0.75 ... 2.5 mm <sup>2</sup>
 Flexible with insulated ferrule	1 x	0.75 ... 2.5 mm <sup>2</sup>
	2 x	0.75 ... 1.5 mm <sup>2</sup>
 Flexible	1 x or 2 x	0.75 ... 1 mm <sup>2</sup> or 1 ... 2.5 mm <sup>2</sup> (1)
 Stranded acc. to UL/CSA	1 x or 2 x	AWG 18-12
 Flexible acc. to UL/CSA	1 x or 2 x	AWG 18-12
Stripping length	9 mm	
Tightening torque	1.1 ... 1.5 Nm / 9 ... 13 lb.in	
Recommended screw driver	M3 (Pozidriv 2)	

(1) Only connect two different "conductor/wire" cross-sections, if they are within the indicated ranges.

# TF65 thermal overload relays – 22.0 to 67.0 A

## Ordering details

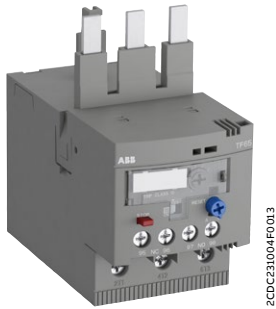

TF65

2CDC231004F013



DB65

2CDC231003V0015



DB65 + TF65

2CDC231004V0015



KPR-101L

15FC15124F0002

The TF65 thermal overload relays are economic electromechanical protection devices for the main circuit. They offer reliable protection for motors in the event of overload or phase failure. The devices have trip class 10.

The thermal overload relays are three pole relays with bimetal tripping elements. The motor current flows through the bimetal tripping elements and heats them directly and indirectly. In case of an overload (over current), the bimetal elements bent as a result of the heating. This leads to a release of the relay and a change of the contacts switching position (95-96 / 97-98).

- Manual or automatic reset selectable
- Phase loss sensitive acc. to IEC/EN 60947-4-1
- TEST and STOP function – Trip indication on the front
- Temperature compensation
- Suitable for three- and single-phase applications
- With ATEX certification (1)

Setting range	Short-circuit protective device	Trip class	Type	Order code	Weight (1 pce) kg
A					

### Suitable for AF40...AF65 contactors

22.0 ... 28.0	80 A, gG Type Fuses	10	TF65-28	1SAZ811201R1001	0.456
25.0 ... 33.0	80 A, gG Type Fuses	10	TF65-33	1SAZ811201R1002	0.456
30.0 ... 40.0	100 A, gG Type Fuses	10	TF65-40	1SAZ811201R1003	0.456
36.0 ... 47.0	125 A, gG Type Fuses	10	TF65-47	1SAZ811201R1004	0.456
44.0 ... 53.0	125 A, gG Type Fuses	10	TF65-53	1SAZ811201R1005	0.456
50.0 ... 60.0	125 A, gG Type Fuses	10	TF65-60	1SAZ811201R1006	0.466
57.0 ... 67.0	160 A, gG Type Fuses	10	TF65-67	1SAZ811201R1007	0.466

### Ordering details accessories

Description	Suitable for	Type	Order code	Weight (1 pce) kg
Single mounting kit	TF65	DB65	1SAZ801901R1001	0.132
Reset push button	E16, EF, TF, T16, TA200	KPR-101L	15FA616162R1014	0.019
Remote reset coil 24-30 V AC / DC	TF42, TF65, TF96	DRS-F-01	1SAX101911R1001	0.077
Remote reset coil 48-60 V AC / DC		DRS-F-02	1SAX101911R1002	0.077
Remote reset coil 110-127 V AC / DC		DRS-F-03	1SAX101911R1003	0.077
Remote reset coil 220-240 V AC / DC		DRS-F-04	1SAX101911R1004	0.077

1) ATEX is valid for products, produced from week 26, 2015.

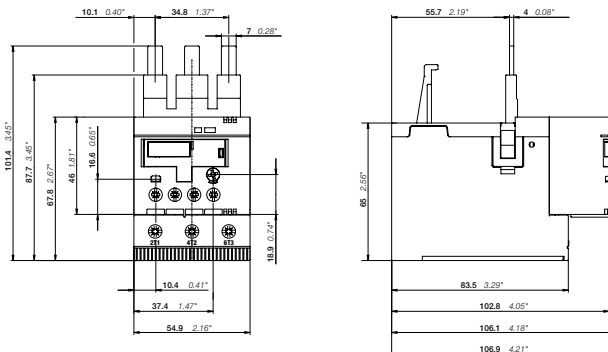

TF65

Main dimensions mm, inches

2CDC232005F0009

2CDC106063 C0201



# TF65 thermal overload relays – 22.0 to 67.0 A

## Technical data

### Main circuit – Utilization characteristics according to IEC/EN

Type	<b>TF65</b>
Standards	IEC/EN 60947-1, IEC/EN 60947-4-1, IEC/EN 60947-5-1
Rated operational voltage Ue	690 V AC
Rated frequency	50/60 Hz
Trip class	10
Number of poles	3
Duty time	100%
Operating frequency without early tripping	Up to 15 operations/h, see "Technical diagram – Intermittent periodic duty"
Rated impulse withstand voltage Uimp	8 kV
Rated insulation voltage Ui	690 V

### Auxiliary circuit according to IEC/EN

Type	<b>TF65</b>
Rated operational voltage Ue	600 V
Conventional free air thermal current Ith	N.C., 95-96 6 A N.O., 97-98 4 A
Rated frequency	DC, 50/60 Hz
Number of poles	1 N.O. + 1 N.C.
Ie / Rated operational current AC-15 acc. to IEC/EN 60947-5-1 for utilization category	
110-120 V	N.C., 95-96 3.00 A N.O., 97-98 0.75 A
220-230-240 V	N.C., 95-96 3.00 A N.O., 97-98 0.75 A
440 V	N.C., 95-96 0.75 A N.O., 97-98 0.75 A
480-500 V	N.C., 95-96 0.75 A N.O., 97-98 0.75 A
Ie / Rated operational current DC-13 acc. to IEC/EN 60947-5-1 for utilization category	
24 V	N.C., 95-96 1.25 A N.O., 97-98 1.25 A
110-120-125 V	N.C., 95-96 0.55 A N.O., 97-98 0.55 A
250 V	N.C., 95-96 0.27 A N.O., 97-98 0.27 A
Minimum switching capacity	17 V / 3 mA
Short-circuit protective device	N.C., 95-96 6 A, gG Type Fuses N.O., 97-98 4 A, gG Type Fuses
Rated impulse withstand voltage Uimp	6 kV
Rated insulation voltage Ui	690 V

### Technical diagram – Intermittent periodic duty

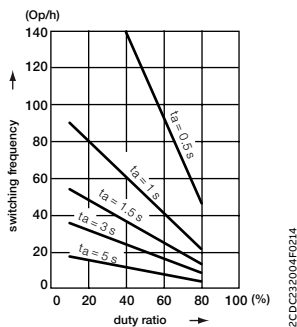

ta: Motor starting time

2CDC32004FD24

# TF65 thermal overload relays – 22.0 to 67.0 A

## Technical data

### Main circuit – Utilization characteristics according to UL/CSA

Type	<b>TF65</b>
Standards	UL 60947-1, UL 60947-4-1
Maximum operational voltage	600 V AC
Trip rating	125% of FLA
Full load amps (FLA)	See table "Full load amps and short-circuit protective device"
Short-circuit rating RMS symmetrical	See table "Full load amps and short-circuit protective device"
Short-circuit protective device	See table "Full load amps and short-circuit protective device"

### Auxiliary circuit according to UL/CSA

Type	<b>TF65</b>	
Contact rating	N.C., 95-96	B600, Q600
	N.O., 97-98	D300, Q600
Conventional thermal current	N.C., 95-96	6 A
	N.O., 97-98	4 A

### Full load amps and short-circuit protective device

Type	Full load amps (FLA)	Short-circuit protective device			
		480 / 600 V AC		480 / 600 V AC	
		Short circuit rating RMS symmetrical	Fuse type	Short circuit rating RMS symmetrical	Fuse type
TF65-28	28 A	5 kA	100 A, K5 / RK5	100 kA	110 A, Class J
TF65-33	33 A	5 kA	100 A, K5 / RK5	100 kA	110 A, Class J
TF65-40	40 A	5 kA	100 A, K5 / RK5	100 kA	110 A, Class J
TF65-47	47 A	5 kA	125 A, K5 / RK5	100 kA	125 A, Class J
TF65-53	53 A	10 kA	125 A, K5 / RK5	100 kA	125 A, Class J
TF65-60	60 A	10 kA	150 A, K5 / RK5	100 kA	150 A, Class J
TF65-67	67 A	10 kA	150 A, K5 / RK5	100 kA	150 A, Class J

# TF65 thermal overload relays – 22.0 to 67.0 A

## Technical data





### General technical data

Type	<b>TF65</b>	
Pollution degree	3	
Phase loss sensitive	Yes	
Ambient air temperature		
Operation (1)	Open - compensated	-40 ... +70 °C
	Open	-40 ... +70 °C
Storage	-50 ... +80 °C	
Ambient air temperature compensation	Acc. to IEC/EN 60947-4-1	
Maximum operating altitude permissible	2000 m	
Resistance to shock acc. to IEC 60068-2-27	25g / 11 ms	
Resistance to vibrations acc. to IEC 60068-2-6	5g / 3 ... 150 Hz	
Mounting position	Position 1 to 6	
Mounting	Mount on the contactor and tighten the screws of the main circuit terminals or with single mounting kit on DIN rail (35 mm)	
Degree of protection	Housing	IP20
	Main circuit terminals	IP10





(1) Valid for TF65 produced from week 11, 2016. Otherwise, -25 ... +60 °C range is valid.  
Derating might be applicable for temperatures > 50°C. Data on request

### Electrical connection

#### Main circuit

Type	<b>TF65</b>	
Connecting capacity		
 Rigid	1 x or 2 x	2.5 ... 16 mm <sup>2</sup>
	1 x	2.5 ... 35 mm <sup>2</sup>
 Flexible with ferrule	1 x or 2 x	2.5 ... 10 mm <sup>2</sup>
	1 x	2.5 ... 35 mm <sup>2</sup>
 Flexible with insulated ferrule	1 x or 2 x	2.5 ... 10 mm <sup>2</sup>
	1 x	2.5 ... 35 mm <sup>2</sup>
 Flexible	1 x or 2 x	2.5 ... 16 mm <sup>2</sup>
	1 x	2.5 ... 35 mm <sup>2</sup>
	Stranded acc. to UL/CSA	1 x AWG 12 ... 2
		2 x AWG 12 ... 6
	Flexible acc. to UL/CSA	1 x AWG 12 ... 2
		2 x AWG 12 ... 6
Stripping length	17 mm	
Tightening torque	4.0 - 4.5 Nm / 35 ... 40 lb.in	
Recommended screw driver	M6 (Pozi driv 2)	

#### Auxiliary circuit

Type	<b>TF65</b>	
Connecting capacity		
 Rigid	1 x or 2 x	0.75 ... 4 mm <sup>2</sup>
 Flexible with ferrule	1 x or 2 x	0.75 ... 4 mm <sup>2</sup>
 Flexible with insulated ferrule	1 x	0.75 ... 2.5 mm <sup>2</sup>
	2 x	0.75 ... 1.5 mm <sup>2</sup>
 Flexible	1 x or 2 x	0.75 ... 1 mm <sup>2</sup> or 1 ... 2.5 mm <sup>2</sup>
	Stranded acc. to UL/CSA	1 x or 2 x AWG 18 ... 12
	Flexible acc. to UL/CSA	1 x or 2 x AWG 18 ... 12
Stripping length	9 mm	
Tightening torque	1.1 ... 1.5 Nm / 9 ... 13 lb.in	
Recommended screw driver	M3 (Pozi driv 2)	

# TF96 thermal overload relays – 40.0 to 96.0 A

## Ordering details



TF96

2CDC231005F0013

The TF96 thermal overload relays are economic electromechanical protection devices for the main circuit. They offer reliable protection for motors in the event of overload or phase failure. The devices have trip class 10.

The thermal overload relays are three pole relays with bimetal tripping elements. The motor current flows through the bimetal tripping elements and heats them directly and indirectly. In case of an overload (over current), the bimetal elements bent as a result of the heating. This leads to a release of the relay and a change of the contacts switching position (95-96 / 97-98).

- Manual or automatic reset selectable
- Phase loss sensitive acc. to IEC/EN 60947-4-1
- TEST and STOP function – Trip indication on the front
- Temperature compensation
- Suitable for three- and single-phase applications
- With ATEX certification (1)



DB96

2CDC231001V0015

Setting range	Short-circuit protective device	Trip class	Type	Order code	Weight (1 pce) kg
A					

### Suitable for AF80, AF96 contactors

40.0 ... 51.0	125 A, gG Type Fuses	10	TF96-51	1SAZ911201R1001	0.620
48.0 ... 60.0	160 A, gG Type Fuses	10	TF96-60	1SAZ911201R1002	0.620
57.0 ... 68.0	160 A, gG Type Fuses	10	TF96-68	1SAZ911201R1003	0.620
65.0 ... 78.0	200 A, gG Type Fuses	10	TF96-78	1SAZ911201R1004	0.620
75.0 ... 87.0	200 A, gG Type Fuses	10	TF96-87	1SAZ911201R1005	0.620
84.0 ... 96.0	250 A, gG Type Fuses	10	TF96-96	1SAZ911201R1006	0.630

### Ordering details accessories

Description	Suitable for	Type	Order code	Weight (1 pce) kg
Single mounting kit	TF96, EF96	DB96	1SAZ901901R1001	0.190
Reset push button	E16, EF, TF, T16, TA200	KPR-101L	1SFA616162R1014	0.019
Remote reset coil 24-30 V AC/DC	TF42, TF65, TF96	DRS-F-01	1SAX101911R1001	0.077
Remote reset coil 48-60 V AC/DC		DRS-F-02	1SAX101911R1002	0.077
Remote reset coil 110-127 V AC/DC		DRS-F-03	1SAX101911R1003	0.077
Remote reset coil 220-240 V AC/DC		DRS-F-04	1SAX101911R1004	0.077

(1) ATEX is valid for products, produced from week 26, 2015.



DB96 + TF96

2CDC231005V0015



KPR-101L

1SFC151224F0002

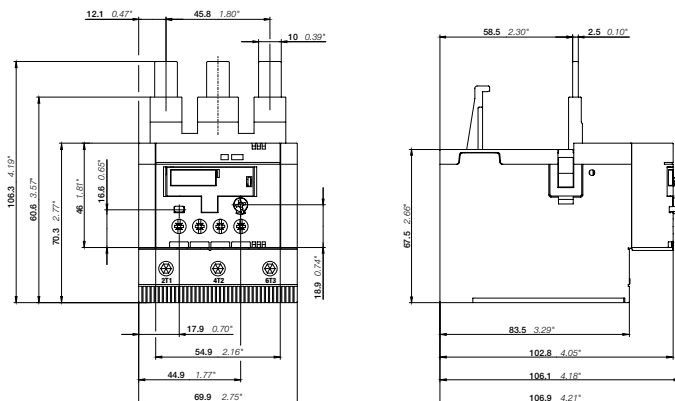

TF96

Main dimensions mm, inches

2CDC231005F0009

2CDC106064C0201

# TF96 thermal overload relays – 40.0 to 96.0 A

## Technical data

### Main circuit – Utilization characteristics according to IEC/EN

Type	<b>TF96</b>
Standards	IEC/EN 60947-1, IEC/EN 60947-4-1, IEC/EN 60947-5-1
Rated operational voltage Ue	690 V AC
Rated frequency	50/60 Hz
Trip class	10
Number of poles	3
Duty time	100%
Operating frequency without early tripping	Up to 15 operations/h, see "Technical diagram – Intermittent periodic duty"
Rated impulse withstand voltage Uimp	8 kV
Rated insulation voltage Ui	690 V

### Auxiliary circuit according to IEC/EN

Type	<b>TF96</b>
Rated operational voltage Ue	600 V
Conventional free air thermal current Ith	N.C., 95-96 6 A N.O., 97-98 4 A
Rated frequency	DC, 50/60 Hz
Number of poles	1 N.O. + 1 N.C.
Ie / Rated operational current AC-15 acc. to IEC/EN 60947-5-1 for utilization category	
110-120 V	N.C., 95-96 3.00 A N.O., 97-98 0.75 A
220-230-240 V	N.C., 95-96 3.00 A N.O., 97-98 0.75 A
440 V	N.C., 95-96 0.75 A N.O., 97-98 0.75 A
480-500 V	N.C., 95-96 0.75 A N.O., 97-98 0.75 A
Ie / Rated operational current DC-13 acc. to IEC/EN 60947-5-1 for utilization category	
24 V	N.C., 95-96 1.25 A N.O., 97-98 1.25 A
110-120-125 V	N.C., 95-96 0.55 A N.O., 97-98 0.55 A
250 V	N.C., 95-96 0.27 A N.O., 97-98 0.27 A
Minimum switching capacity	17 V / 3 mA
Short-circuit protective device	N.C., 95-96 6 A, fuse type gG N.O., 97-98 4 A, fuse type gG
Rated impulse withstand voltage Uimp	6 kV
Rated insulation voltage Ui	690 V

### Technical diagram – Intermittent periodic duty

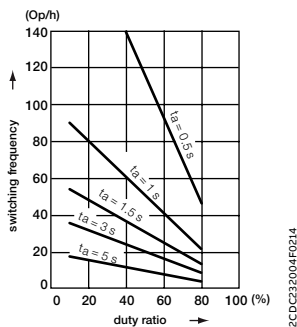

ta: Motor starting time

2CDC32004FD24

# TF96 thermal overload relays – 40.0 to 96.0 A

## Technical data

### Main circuit – Utilization characteristics according to UL/CSA

Type	<b>TF96</b>
Standards	UL 60947-1, UL 60947-4-1
Maximum operational voltage	600 V AC
Trip rating	125% of FLA
Full load amps (FLA)	See table "Full load amps and short-circuit protective device"
Short-circuit rating RMS symmetrical	See table "Full load amps and short-circuit protective device"
Short-circuit protective device	See table "Full load amps and short-circuit protective device"

### Auxiliary circuit according to UL/CSA

Type	<b>TF96</b>	
Contact rating	N.C., 95-96	B600, Q600
	N.O., 97-98	D300, Q600
Conventional thermal current	N.C., 95-96	6 A
	N.O., 97-98	4 A

### Full load amps and short-circuit protective device

Type	Full load amps (FLA)	Short-circuit protective device		Short-circuit protective device	
		480 / 600 V AC		480 / 600 V AC	
		Short circuit rating RMS symmetrical	Fuse type	Short circuit rating RMS symmetrical	Fuse type
TF96-51	51 A	5 kA	150 A, K5 / RK5	100 kA	125 A, Class J
TF96-60	60 A	10 kA	150 A, K5 / RK5	100 kA	150 A, Class J
TF96-68	68 A	10 kA	150 A, K5 / RK5	100 kA	150 A, Class J
TF96-78	78 A	10 kA	175 A, K5 / RK5	100 kA	175 A, Class J
TF96-87	87 A	10 kA	200 A, K5 / RK5	100 kA	200 A, Class J
TF96-96	96 A	10 kA	250 A, K5 / RK5	100 kA	200 A, Class J

# TF96 thermal overload relays – 40.0 to 96.0 A

## Technical data





### General technical data

Type		TF96
Pollution degree		3
Phase loss sensitive		Yes
Ambient air temperature		
Operation (1)	Open - compensated	-40 ... +70 °C
	Open	-40 ... +70 °C
Storage		-50 ... +80 °C
Ambient air temperature compensation		Acc. to IEC/EN60947-4-1
Maximum operating altitude permissible		2000 m
Resistance to shock acc. to IEC 60068-2-27		25g / 11 ms
Resistance to vibrations acc. to IEC 60068-2-6		5g / 3 ... 150 Hz
Mounting position		Position 1 to 6
Mounting		Mount on the contactor and tighten the screws of the main circuit terminals or with single mounting kit on DIN rail (35 mm)
Degree of protection	Housing	IP20
	Main circuit terminals	IP10

(1) Valid for TF96 produced from week 11, 2016. Otherwise, -25 ... +60 °C range is valid.  
Derating might be applicable for temperatures > 50°C. Data on request.





### Electrical connection

#### Main circuit

Type		TF96
Connecting capacity		
	Rigid	1 x or 2 x 6 ... 35 mm <sup>2</sup> 1 x 6 ... 50 mm <sup>2</sup>
	Flexible with ferrule	1 x or 2 x 6 ... 35 mm <sup>2</sup> 1 x 6 ... 50 mm <sup>2</sup>
	Flexible with insulated ferrule	1 x or 2 x 6 ... 16 mm <sup>2</sup> 1 x 6 ... 50 mm <sup>2</sup>
	Flexible	1 x or 2 x 6 ... 35 mm <sup>2</sup> 1 x 6 ... 50 mm <sup>2</sup>
	Stranded acc. to UL/CSA	1 x AWG 8 ... 1 2 x AWG 8 ... 3
	Flexible acc. to UL/CSA	1 x AWG 8 ... 1 2 x AWG 8 ... 3
Stripping length		20 mm (1)
Tightening torque		6 ... 9 Nm / 53 ... 80 lb.in (2)
Recommended screw driver		M8 (Hexagon)

(2) Valid for products, produced from week 27, 2015

#### Auxiliary circuit

Type		TF96
Connecting capacity		
	Rigid	1 x or 2 x 0.75 ... 4 mm <sup>2</sup>
	Flexible with ferrule	1 x or 2 x 0.75 ... 4 mm <sup>2</sup>
	Flexible with insulated ferrule	1 x 0.75 ... 2.5 mm <sup>2</sup> 2 x 0.75 ... 1.5 mm <sup>2</sup>
	Flexible	1 x or 2 x 0.75 ... 1 mm <sup>2</sup> or 1 ... 2.5 mm <sup>2</sup>
	Stranded acc. to UL/CSA	1 x or 2 x AWG 18 ... 12
	Flexible acc. to UL/CSA	1 x or 2 x AWG 18 ... 12
Stripping length		9 mm
Tightening torque		1.1 ... 1.5 Nm / 9 ... 13 lb.in
Recommended screw driver		M3 (Pozidriv 2)

# TF140DU thermal overload relays – 66 to 142 A

## Ordering details



TF140DU

2CDC310124F0012



KPR-101L

1SFA616162R1014

The TF140DU thermal overload relays are economic electromechanical protection devices for the main circuit. They offer reliable protection for motors in the event of overload or phase failure. The devices have trip class 10A.

The thermal overload relays are three pole relays with bimetal tripping elements. The motor current flows through the bimetal tripping elements and heats them directly and indirectly. In case of an overload (over current), the bimetal elements bent as a result of the heating. This leads to a release of the relay and a change of the contacts switching position (95-96 / 97-98).

- Manual or automatic reset selectable
- Phase loss sensitive acc. to IEC/EN 60947-4-1
- TEST and STOP function – Trip indication on the front
- Temperature compensation
- Suitable for three- and single-phase applications
- ATEX variants available

Setting range	Short-circuit protective device	Trip class	Type	Order code	Weight (1 pce) kg
A					

### Suitable for AF116...AF140 contactors

66 ... 90	200 A, fuse type gG	10A	TF140DU-90	1SAZ431201R1001	0.820
80 ... 110	224 A, fuse type gG	10A	TF140DU-110	1SAZ431201R1002	0.820
100 ... 135	224 A, fuse type gG	10A	TF140DU-135	1SAZ431201R1003	0.820
110 ... 142	250 A, fuse type gG	10A	TF140DU-142	1SAZ431201R1004	0.820
66 ... 90	200 A, fuse type gG	10A	TF140DU-90-V1000*	1SAZ431301R1001	0.820
80 ... 110	224 A, fuse type gG	10A	TF140DU-110-V1000*	1SAZ431301R1002	0.820
100 ... 135	224 A, fuse type gG	10A	TF140DU-135-V1000*	1SAZ431301R1003	0.820
110 ... 142	250 A, fuse type gG	10A	TF140DU-142-V1000*	1SAZ431301R1004	0.820

\*Note: ATEX variant

### Ordering details accessories

Description	Suitable for	Type	Order code	Weight (1 pce) kg
Reset push button	E16, EF, TF, T16, TA200	KPR-101L	1SFA616162R1014	0.027

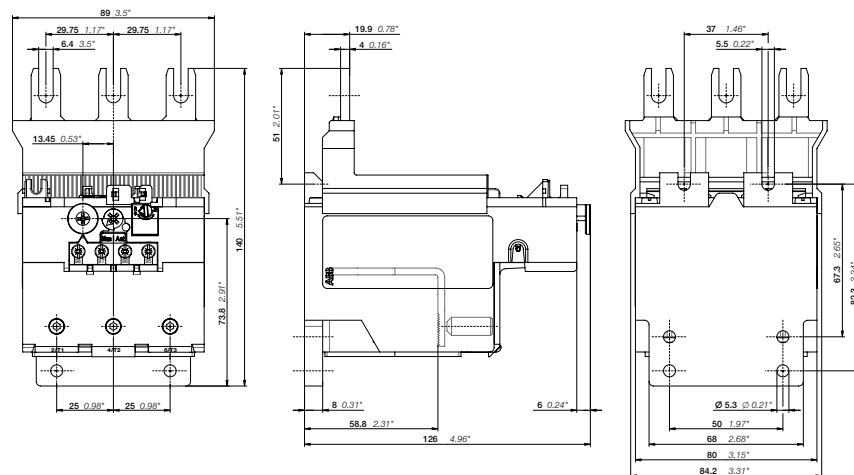

TF140DU

Main dimensions mm, inches

2CDC330808F0012

2CDC106054C0201



# TF140DU thermal overload relays – 66 to 142 A

## Technical data

### Main circuit – Utilization characteristics according to IEC/EN

Type	<b>TF140DU / TF140DU-V1000</b>
Standards	IEC/EN 60947-1, IEC/EN 60947-4-1, IEC/EN 60947-5-1
Rated operational voltage Ue	690 V AC
Rated frequency	DC, 50/60 Hz
Frequency range	0 ... 400 Hz
Trip class	10A
Number of poles	3
Duty time	100%
Operating frequency without early tripping	Up to 15 operations/h, see "Technical diagram – Intermittent periodic duty"
Rated impulse withstand voltage Uimp	8 kV
Rated insulation voltage Ui	690 V

### Auxiliary circuit according to IEC/EN

Type	<b>TF140DU / TF140DU-V1000</b>	
Rated operational voltage Ue	500 V AC, 440 V DC	
Conventional free air thermal current Ith	N.C., 95-96	10 A
	N.O., 97-98	6 A
Rated frequency	DC, 50/60 Hz	
Number of poles	1 N.O. + 1 N.C.	
Ie / Rated operational current AC-15 acc. to IEC/EN 60947-5-1 for utilization category		
110-120 V	N.C., 95-96	3.00 A
	N.O., 97-98	1.50 A
220-230-240 V	N.C., 95-96	1.50 A
	N.O., 97-98	1.50 A
440 V	N.C., 95-96	1.00 A
	N.O., 97-98	1.00 A
480-500 V	N.C., 95-96	1.00 A
	N.O., 97-98	1.00 A
Ie / Rated operational current DC-13 acc. to IEC/EN 60947-5-1 for utilization category		
24 V	N.C., 95-96	1.25 A
	N.O., 97-98	1.25 A
60 V	N.C., 95-96	0.25 A
	N.O., 97-98	0.25 A
110-120-125 V	N.C., 95-96	0.25 A
	N.O., 97-98	0.25 A
250 V	N.C., 95-96	0.12 A
	N.O., 97-98	0.04 A
Minimum switching capacity	17 V / 3 mA	
Short-circuit protective device	N.C., 95-96	10 A, fuse type gG
	N.O., 97-98	6 A, fuse type gG
Rated impulse withstand voltage Uimp	6 kV	
Rated insulation voltage Ui	690 V	

### Technical diagram – Intermittent periodic duty

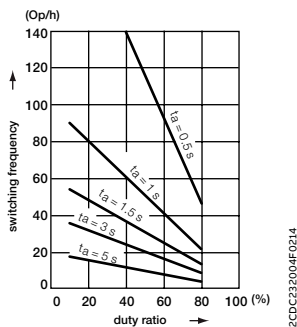

ta: Motor starting time

2CDC32004F0214

# TF140DU thermal overload relays – 66 to 142 A

## Technical data

### Main circuit – Utilization characteristics according to UL/CSA

Type	<b>TF140DU / TF140DU-V1000</b>
Standards	UL 508, CSA 22.2 No. 14, UL 60947-4-1A
Maximum operational voltage	600 V AC
Trip rating	125% of FLA
Full load amps (FLA)	See table "Full load amps and short-circuit protective device"
Short-circuit rating RMS symmetrical	See table "Full load amps and short-circuit protective device"
Short-circuit protective device	See table "Full load amps and short-circuit protective device"

### Auxiliary circuit according to UL/CSA

Type	<b>TF140DU / TF140DU-V1000</b>	
Contact rating	N.C., 95-96	B600
	N.O., 97-98	C300
Conventional thermal current	N.C./N.O.	10 A / 6 A

### Full load amps and short-circuit protective device

Type	Full load amps (FLA)	Short-circuit protective device					
		480 / 600 V AC		480 / 600 V AC		480 / 600 V AC	
		Short circuit rating RMS symmetrical	Fuse type	Short circuit rating RMS symmetrical	Fuse type	Short circuit rating RMS symmetrical	Listed circuit breaker
TF140DU-90 / TF140DU-90-V1000	90 A	10 kA	250 A, K5 / RK5	100 kA	250 A, Class J	100 kA	250 A
TF140DU-110 / TF140DU-110-V1000	110 A	10 kA	250 A, K5 / RK5	100 kA	250 A, Class J	100 kA	250 A
TF140DU-135 / TF140DU-135-V1000	135 A	10 kA	250 A, K5 / RK5	100 kA	250 A, Class J	100 kA	250 A
TF140DU-142 / TF140DU-142-V1000	142 A	10 kA	250 A, K5 / RK5	100 kA	250 A, Class J	100 kA	250 A

## TF140DU thermal overload relays – 66 to 142 A



### Technical data

#### General technical data





Type		TF140DU / TF140DU-V1000
Pollution degree		3
Phase loss sensitive		Yes
Ambient air temperature		
Operation	Open - compensated	-25 ... +55 °C
	Open	-25 ... +55 °C
Storage		-40 ... +70 °C
Ambient air temperature compensation		Acc. to IEC/EN 60947-4-1
Maximum operating altitude permissible		2000 m
Resistance to shock acc. to IEC 60068-2-27		12g / 11 ms
Mounting position		Position 1-5
Mounting		Mount on the contactor and tighten the screws of the main circuit terminals
Degree of protection	Housing	IP20
	Main circuit terminals	IP00

#### Electrical connection

##### Main circuit

Type		TF140DU / TF140DU-V1000
Connecting capacity		
	Rigid	1 x 16 ... 70 mm <sup>2</sup> 2 x -
	Flexible	1 x 16 ... 70 mm <sup>2</sup> 2 x -
	Stranded acc. to UL/CSA	1 x or 2 x AWG 6-2/0
	Flexible acc. to UL/CSA	1 x or 2 x AWG 6-2/0
Stripping length		25 mm
Tightening torque		8 ... 10 Nm / 77 ... 88 lb.in
Recommended screw driver		M8 (Hexagon)

##### Auxiliary circuit

Type		TF140DU / TF140DU-V1000
Connecting capacity		
	Rigid	1 x or 2 x 0.75 ... 4 mm <sup>2</sup>
	Flexible with ferrule	1 x or 2 x 0.75 ... 2.5 mm <sup>2</sup>
	Flexible with insulated ferrule	1 x or 2 x 0.75 ... 2.5 mm <sup>2</sup>
	Flexible	1 x or 2 x 0.75 ... 2.5 mm <sup>2</sup>
	Stranded acc. to UL/CSA	1 x or 2 x AWG 18-14
	Flexible acc. to UL/CSA	1 x or 2 x AWG 18-14
Stripping length		9 mm
Tightening torque		0.8 ... 1.3 Nm / 12 lb.in
Recommended screw driver		M3.5 (Poqidriv 2)

# TA200DU thermal overload relays – 66 to 200 A

## Ordering details

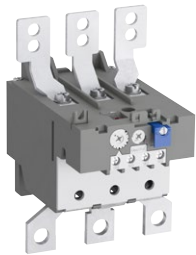

TA200DU

2CDC231016F0013



KPR-101L

1SFC151224F0002

The TA200DU thermal overload relays are economic electromechanical protection devices for the main circuit. They offer reliable protection for motors in the event of overload or phase failure. The devices have trip class 10A.

The thermal overload relays are three pole relays with bimetal tripping elements. The motor current flows through the bimetal tripping elements and heats them directly and indirectly. In case of an overload (over current), the bimetal elements bent as a result of the heating. This leads to a release of the relay and a change of the contacts switching position (95-96 / 97-98).

- Manual or automatic reset selectable
- Phase loss sensitive acc. to IEC/EN 60947-4-1
- TEST and STOP function – Trip indication on the front
- Temperature compensation
- Suitable for three- and single-phase applications
- ATEX variants available

Setting range	Short-circuit protective device	Trip class	Type	Order code	Weight (1 pce) kg
A					

### Suitable for AF145...AF2050 contactors

66 ... 90	200 A, fuse type gG / 125 A aM	10A	TA200DU-90	1SAZ421201R1001	0.755
80 ... 110	224 A, fuse type gG / 160 A aM	10A	TA200DU-110	1SAZ421201R1002	0.760
100 ... 135	224 A, fuse type gG / 200 A aM	10A	TA200DU-135	1SAZ421201R1003	0.760
110 ... 150	250 A, fuse type gG / 200 A aM	10A	TA200DU-150	1SAZ421201R1004	0.760
130 ... 175	315 A, fuse type gG / 250 A aM	10A	TA200DU-175	1SAZ421201R1005	0.770
150 ... 200	315 A, fuse type gG / 250 A aM	10A	TA200DU-200	1SAZ421201R1006	0.785
66 ... 90	200 A, fuse type gG / 125 A aM	10A	TA200DU-90-V1000 (1)	1SAZ421301R1001	0.755
80 ... 110	224 A, fuse type gG / 160 A aM	10A	TA200DU-110-V1000 (1)	1SAZ421301R1002	0.760
100 ... 135	224 A, fuse type gG / 200 A aM	10A	TA200DU-135-V1000 (1)	1SAZ421301R1003	0.760
110 ... 150	250 A, fuse type gG / 200 A aM	10A	TA200DU-150-V1000 (1)	1SAZ421301R1004	0.760
130 ... 175	315 A, fuse type gG / 250 A aM	10A	TA200DU-175-V1000 (1)	1SAZ421301R1005	0.770
150 ... 200	315 A, fuse type gG / 250 A aM	10A	TA200DU-200-V1000 (1)	1SAZ421301R1006	0.785

(1) ATEX variant

### Ordering details accessories

Description	Suitable for	Type	Order code	Weight (1 pce) kg
Terminal shroud	TA200DU	LT200/A	1SAZ401901R1001	0.090
Single mounting kit	TA200DU	DB200	1SAZ401110R0001	0.225
Reset push button	E16, EF, TF, T16, TA200	KPR-101L	1SFA616162R1014	0.027

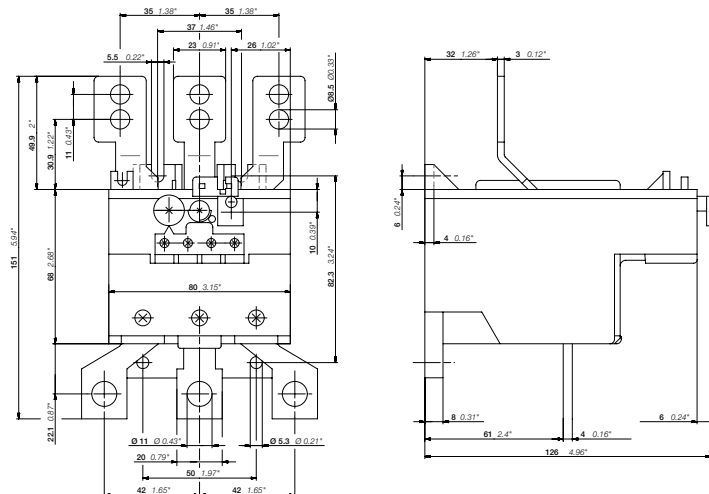

TA200DU

Main dimensions mm, inches

2CDC23202F0011

2CDC106038C0201

# TA200DU thermal overload relays – 66 to 200 A

## Technical data

### Main circuit – Utilization characteristics according to IEC/EN

Type	TA200DU / TA200DU-V1000
Standards	IEC/EN 60947-1, IEC/EN 60947-4-1
Rated operational voltage Ue	690 V AC
Rated frequency	DC, 50/60 Hz
Frequency range	0 ... 400 Hz
Trip class	10A
Number of poles	3
Duty time	100%
Operating frequency without early tripping	Up to 15 operations/h, see "Technical diagram – Intermittent periodic duty"
Rated impulse withstand voltage Uimp	6 kV
Rated insulation voltage Ui	690 V AC

### Auxiliary circuit according to IEC/EN

Type	TA200DU / TA200DU-V1000
Rated operational voltage Ue	500 V AC, 440 V DC
Conventional free air thermal current Ith	N.C., 95-96 10 A N.O., 97-98 6 A
Rated frequency	DC, 50/60 Hz
Number of poles	1 N.O. + 1 N.C.
Ie / Rated operational current AC-15 acc. to IEC/EN 60947-5-1 for utilization category	
110-120 V	N.C., 95-96 3.00 A N.O., 97-98 1.50 A
220-230-240 V	N.C., 95-96 3.00 A N.O., 97-98 1.50 A
440 V	N.C., 95-96 1.00 A N.O., 97-98 1.00 A
480-500 V	N.C., 95-96 1.00 A N.O., 97-98 1.00 A
Ie / Rated operational current DC-13 acc. to IEC/EN 60947-5-1 for utilization category	
24 V	N.C., 95-96 1.25 A N.O., 97-98 1.25 A
60 V	N.C., 95-96 0.25 A N.O., 97-98 0.25 A
110-120-125 V	N.C., 95-96 0.25 A N.O., 97-98 0.25 A
250 V	N.C., 95-96 0.12 A N.O., 97-98 0.04 A
Minimum switching capacity	17 V / 3 mA
Short-circuit protective device	N.C., 95-96 10 A, fuse type gG N.O., 97-98 6 A, fuse type gG
Rated impulse withstand voltage Uimp	6 kV
Rated insulation voltage Ui	690 V

### Technical diagram – Intermittent periodic duty

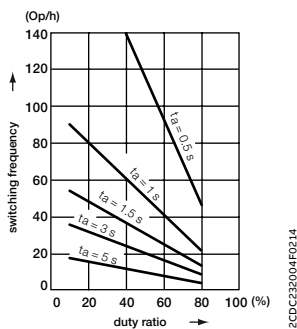

ta: Motor starting time

# TA200DU thermal overload relays – 66 to 200 A

## Technical data

### Main circuit – Utilization characteristics according to UL/CSA

Type	TA200DU / TA200DU-V1000
Standards	UL 508, CSA 22.2 No. 14
Maximum operational voltage	600 V AC
Trip rating	125% of FLA
Full load amps (FLA)	See table "Full load amps and short-circuit protective device"
Short-circuit rating RMS symmetrical	See table "Full load amps and short-circuit protective device"
Short-circuit protective device	See table "Full load amps and short-circuit protective device"

### Auxiliary circuit according to UL/CSA

Type	TA200DU / TA200DU-V1000	
Contact rating	N.C., 95-96	C600
	N.O., 97-98	B600
Conventional thermal current	5 A	

### Full load amps and short-circuit protective device

Type	Full load amps (FLA)	Short-circuit protective device 480 / 600 V AC						
		Short circuit rating RMS symmetrical	Fuse type	Listed circuit breaker	Short circuit rating RMS symmetrical	Fuse type	Short circuit rating RMS symmetrical	Listed circuit breaker
TA200DU-90 / TA200DU-90-V1000	90 A	10 kA	250 A, K5 / RK5	225 A	100 kA	250 A, Class J	100 kA	250 A
TA200DU-110 / TA200DU-110-V1000	110 A	10 kA	250 A, K5 / RK5	225 A	100 kA	250 A, Class J	100 kA	250 A
TA200DU-135 / TA200DU-135-V1000	135 A	10 kA	300 A, K5 / RK5	225 A	100 kA	250 A, Class J	100 kA	250 A
TA200DU-150 / TA200DU-150-V1000	150 A	10 kA	300 A, K5 / RK5	225 A	100 kA	250 A, Class J	100 kA	250 A
TA200DU-175 / TA200DU-175-V1000	175 A	10 kA	300 A, K5 / RK5	225 A	100 kA	300 A, Class J	100 kA	300 A
TA200DU-200 / TA200DU-200-V1000	200 A	10 kA	400 A, K5 / RK5	400 A	100 kA	400 A, Class J	100 kA	400 A

## TA200DU thermal overload relays – 66 to 200 A



### Technical data

#### General technical data





Type		TA200DU / TA200DU-V1000
Pollution degree		3
Phase loss sensitive		Yes
Ambient air temperature		
Operation	Open - compensated	-25 ... +55 °C
	Open	-25 ... +55 °C
Storage		-40 ... +70 °C
Ambient air temperature compensation		Acc. to IEC/EN60947-4-1
Maximum operating altitude permissible		2000 m
Resistance to shock acc. to IEC 60068-2-27		12g / 15 ms
Mounting position		Position 1-6
Mounting		Mount on the contactor and tighten the screws of the main circuit terminals or with single mounting kit
Degree of protection	Housing	IP20
	Main circuit terminals	IP00

#### Electrical connection

##### Main circuit

Type		TA200DU / TA200DU-V1000
Connecting capacity		
	Rigid	1 x 25 ... 120 mm <sup>2</sup>
	Flexible	1 x 25 ... 120 mm <sup>2</sup>
	Stranded acc. to UL/CSA	1 x AWG 4 ... 0000
	Flexible acc. to UL/CSA	1 x AWG 4 ... 0000
	Lugs	L > 10 mm
Tightening torque		25 Nm / 220 lb.in
Recommended screwdriver		Open bars

##### Auxiliary circuit

Type		TA200DU / TA200DU-V1000
Connecting capacity		
	Rigid	1 x or 2 x 0.75 ... 4 mm <sup>2</sup>
	Flexible with ferrule	1 x or 2 x 0.75 ... 2.5 mm <sup>2</sup>
	Flexible with insulated ferrule	1 x or 2 x 0.75 ... 2.5 mm <sup>2</sup>
	Flexible	1 x or 2 x 0.75 ... 2.5 mm <sup>2</sup>
	Stranded acc. to UL/CSA	1 x or 2 x AWG 18 ... 14
	Flexible acc. to UL/CSA	1 x or 2 x AWG 18 ... 14
Stripping length		9 mm
Tightening torque		0.8 ... 1.3 Nm / 12 lb.in
Recommended screwdriver		M3.5 (Poizidriv 2)

# E16DU, EF19, EF45 electronic overload relays – 0.10 to 45.0 A

## Ordering details



E16DU-1.0

2CDC231001F0007



EF19-18.9

1SBC101147F0010



EF45-30

1SBC101148F0010

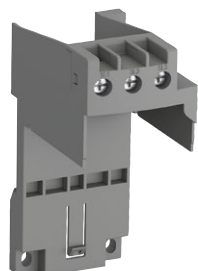

DB19EF

2CDC231024V0013



DB45EF

2CDC231002V0014



KPR-101L

1SFC151224F0002

The E16DU, EF19 and EF45 are self-supplied electronic overload relays, which means no extra external supply is needed. It offers reliable protection for motors in the event of overload or phase failure. Easy to use like a thermal overload relay and compatible with standard motor applications, the electronic overload relay is convincing, above all, due to its wide setting range, high accuracy, high operational temperature range and the possibility to select a trip class (10E, 20E, 30E). Further features are the temperature compensation, trip contact (N.C.), signal contact (N.O.), automatic or manual reset selectable, trip-free mechanism, STOP and TEST function and a trip indication. The overload relays are connected directly to the contactors. The EF19 and EF45 have ATEX and IECEx certification (1).

Setting range	Short-circuit protective device	Trip class	Type	Order code	Weight (1 pce) kg
A					

### E16DU electronic overload relays, suitable for B6 & B7

0.10 ... 0.32	1 A, fuse type gG	10E, 20E, 30E	E16DU-0.32	1SAX111001R1101	0.150
0.30 ... 1.00	4 A, fuse type gG	10E, 20E, 30E	E16DU-1.0	1SAX111001R1102	0.150
0.80 ... 2.70	10 A, fuse type gG	10E, 20E, 30E	E16DU-2.7	1SAX111001R1103	0.150
2.00 ... 6.30	20 A, fuse type gG	10E, 20E, 30E	E16DU-6.3	1SAX111001R1104	0.150
5.70 ... 18.9	50 A, fuse type gG	10E, 20E, 30E	E16DU-18.9	1SAX111001R1105	0.150

### EF19 electronic overload relays, suitable for AF09 ... AF26 (1)

0.10 ... 0.32	1 A, fuse type gG	10E, 20E, 30E	EF19-0.32	1SAX121001R1101	0.158
0.30 ... 1.00	4 A, fuse type gG	10E, 20E, 30E	EF19-1.0	1SAX121001R1102	0.158
0.80 ... 2.70	10 A, fuse type gG	10E, 20E, 30E	EF19-2.7	1SAX121001R1103	0.158
1.90 ... 6.30	20 A, fuse type gG	10E, 20E, 30E	EF19-6.3	1SAX121001R1104	0.158
5.70 ... 18.9	50 A, fuse type gG	10E, 20E, 30E	EF19-18.9	1SAX121001R1105	0.158

### EF45 electronic overload relays, suitable for AF26 ... AF38 (1)

9.00 ... 30.0	160 A, fuse type gG	10E, 20E, 30E	EF45-30	1SAX221001R1101	0.362
15.0 ... 45.0	160 A, fuse type gG	10E, 20E, 30E	EF45-45	1SAX221001R1102	0.362

(1) ATEX is valid for products produced from week 42, 2014. IECEx is valid for products produced from week 15, 2017.

## Ordering details accessories

Description	Suitable for	Type	Order code	Weight (1 pce) kg
Single mounting kit	E16DU	DB16E	1SAX101110R0001	0.035
Single mounting kit	EF19	DB19EF	1SAX101910R1001	0.046
Single mounting kit	EF45	DB45EF	1SAX201910R0001	0.100
Reset push button	E16, EF, TF, T16, TA200	KPR-101L	1SFA616162R1014	0.019

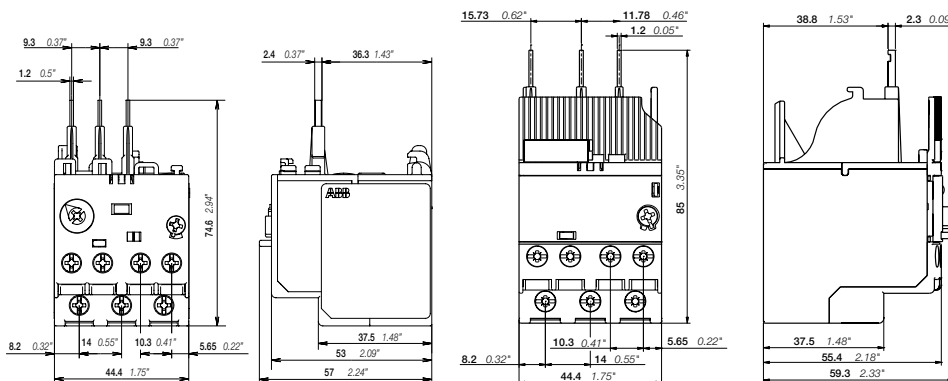

E16DU

EF19, EF45

Main dimensions mm, inches

2CDC107032C0201



# E16DU, EF19, EF45 electronic overload relays – 0.10 to 45.0 A

## Technical data

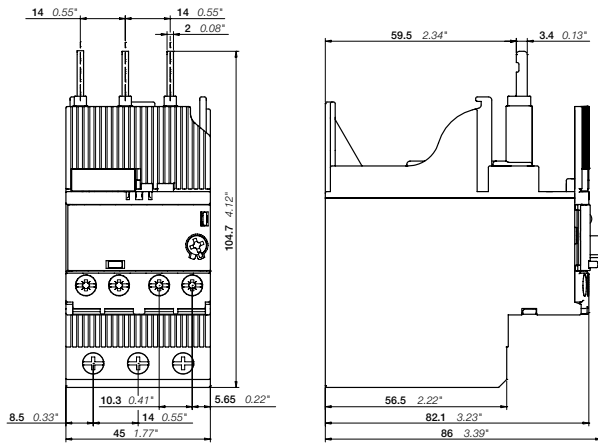

EF45

### Main circuit – Utilization characteristics according to IEC/EN

Type	E16DU	EF19	EF45
Standards	IEC/EN 60947-1, IEC/EN 60947-4-1, IEC/EN 60947-5-1		
Rated operational voltage Ue	690 V AC		
Rated frequency	50/60 Hz – not suitable for DC applications		
Trip class	10E, 20E, 30E, selectable		
Number of poles	3		
Duty time	100%		
Operating frequency without early tripping	Up to 15 operations/h, see "Technical diagram – Intermittent periodic duty"		
Rated impulse withstand voltage Uimp	6 kV		
Rated insulation voltage Ui	690 V AC		

### Auxiliary circuit according to IEC/EN

Type	E16DU	EF19	EF45
Rated operational voltage Ue	600 V AC / DC		
Conventional free air thermal current Ith	6 A		
Rated frequency	DC, 50/60 Hz		
Number of poles	1 N.C. + 1 N.O.		
Ie / Rated operational current AC-15 acc. to IEC/EN 60947-5-1 for utilization category			
110-120 V	50/60 Hz	3.00 A	
220-230-240 V	50/60 Hz	3.00 A	
440 V	50/60 Hz	1.10 A	
480-500 V	50/60 Hz	0.75 A	
Ie / Rated operational current DC-13 acc. to IEC/EN 60947-5-1 for utilization category			
24 V		1.50 A	
60 V		0.55 A	
110-120-125 V		0.55 A	
250 V		0.27 A	
Minimum switching capacity	12 V / 3 mA		
Short-circuit protective devices	6 A, fuse type gG		
Rated impulse withstand voltage Uimp	6 kV		
Rated insulation voltage Ui	690 V		

# E16DU, EF19, EF45 electronic overload relays – 0.10 to 45.0 A

## Technical data

### Technical diagram – Intermittent periodic duty

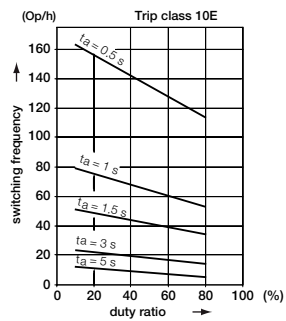

Trip class 10E

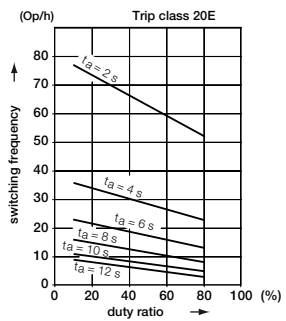

Trip class 20E

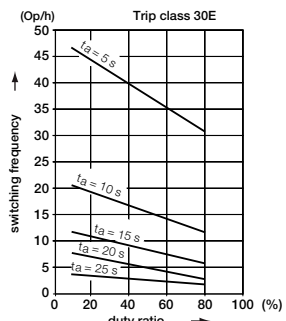

Trip class 30E

### Main circuit – Utilization characteristics according to UL/CSA

Type	E16DU	EF19	EF45
Standards	UL 508, CSA 22.2 No. 14		
Maximum operational voltage	600 V AC		
Trip rating	125% of FLA		
Full load amps (FLA)	See table "Full load amps and short-circuit protective device"		
Short-circuit rating RMS symmetrical	See table "Full load amps and short-circuit protective device"		
Short-circuit protective device	See table "Full load amps and short-circuit protective device"		

### Auxiliary circuit according to UL/CSA

Type	E16DU	EF19	EF45
Contact rating	N.C., 95-96 B600, Q300 N.O., 97-98 B600, Q300	B600, Q600	
Conventional free-air thermal current	6 A		

### Full load amps and short-circuit protective device

Type	Full load amps (FLA)	Short-circuit protective device					
		480 V AC		600 V AC			
		SCCR	Fuse type	SCCR	Fuse type	SCCR	Fuse type
E16DU-0.32	0.32 A	50 kA	2 A, Class J	5 kA	2 A, K5 / RK5	100 kA	2 A, Class J
E16DU-1.0	1.00 A	50 kA	2 A, K5 / RK5	5 kA	2 A, K5 / RK5	100 kA	2 A, Class J
E16DU-2.7	2.70 A	50 kA	4 A, K5 / RK5	5 kA	4 A, K5 / RK5	100 kA	4 A, Class J
E16DU-6.3	6.30 A	50 kA	15 A, K5 / RK5	5 kA	15 A, K5 / RK5	100 kA	15 A, Class J
E16DU-18.9	18.90 A	50 kA	30 A, K5 / RK5	5 kA	30 A, K5 / RK5	100 kA	30 A, Class J

Type	Full load amps (FLA)	Short-circuit protective device					
		480 V AC		600 V AC			
		SCCR	Fuse type	SCCR	Fuse type	SCCR	Fuse type
EF19-0.32	0.32 A	50 kA	2 A, Class J	5 kA	2 A, K5 / RK5	100 kA	2 A, Class J
EF19-1.0	1.00 A	50 kA	2 A, K5 / RK5	5 kA	2 A, K5 / RK5	100 kA	2 A, Class J
EF19-2.7	2.70 A	50 kA	4 A, K5 / RK5	5 kA	4 A, K5 / RK5	100 kA	4 A, Class J
EF19-6.3	6.30 A	50 kA	15 A, K5 / RK5	5 kA	15 A, K5 / RK5	100 kA	15 A, Class J
EF19-18.9	18.90 A	50 kA	30 A, K5 / RK5	5 kA	30 A, K5 / RK5	100 kA	30 A, Class J

Type	Full load amps (FLA)	Short-circuit protective device					
		480 V AC		600 V AC			
		SCCR	Fuse type	SCCR	Fuse type	SCCR	Fuse type
EF45-30	30 A	18 kA	150 A, K5 / RK5	18 kA	150 A, K5 / RK5	100 kA	150 A, Class J
EF45-45	45 A	18 kA	200 A, K5 / RK5	18 kA	200 A, K5 / RK5	100 kA	200 A, Class J

## E16DU, EF19, EF45 electronic overload relays – 0.10 to 45.0 A





### Technical data

#### General data







Type	E16DU	EF19	EF45
Pollution degree	3		
Phase loss sensitive	Yes		
Ambient air temperature			
Operation	Open - compensated		
Storage			
Ambient air temperature compensation	Acc. to IEC/EN60947-4-1		
Maximum operating altitude permissible	2000 m		
Resistance to shock acc. to IEC 60068-2-27	15g / 11 ms pulse	25g / 11 ms pulse	
Resistance to vibrations acc. to IEC 60068-2-6	5g / 3 ... 150 Hz	3g / 3 ... 150 Hz	
Mounting position	Position 1-6		
Mounting	Mount on the contactor and tighten the screws of the main circuit terminals		
Degree of protection	Housing	IP20	
	Main circuit terminals	IP20	

#### Electrical connection

##### Main circuit

Type	E16DU	EF19	EF45
Connecting capacity			
 Rigid	1 or 2 x 1 ... 4 mm <sup>2</sup>	1 ... 4 mm <sup>2</sup>	2.5 ... 16 mm <sup>2</sup>
 Flexible with insulated ferrule	1 or 2 x 0.75 ... 2.5 mm <sup>2</sup>	0.75 ... 2.5 mm <sup>2</sup>	2.5 ... 10 mm <sup>2</sup>
 Stranded acc. to UL/CSA	1 or 2 x AWG 16-10	AWG 16-10	AWG 14-6
 Flexible acc. to UL/CSA	1 or 2 x AWG 16-10	AWG 16-10	AWG 14-6
Stripping length	9 mm	9 mm	13 mm
Tightening torque	0.8 ... 1.5 Nm / 7 ... 13 lb.in	0.8 ... 1.5 Nm / 7 ... 13 lb.in	2.3 ... 2.6 Nm / 20 ... 22 lb.in
Recommended screw driver	M3.5 (Pozidriv 2)	M3.5 (Pozidriv 2)	M3.5 (Pozidriv 2)

##### Auxiliary circuit

Type	E16DU	EF19	EF45
Connecting capacity			
 Rigid	1 or 2 x 1 ... 4 mm <sup>2</sup>	1 ... 4 mm <sup>2</sup>	1 ... 4 mm <sup>2</sup>
 Flexible with ferrule	1 or 2 x 0.75 ... 2.5 mm <sup>2</sup>	0.75 ... 2.5 mm <sup>2</sup>	0.75 ... 2.5 mm <sup>2</sup>
 Flexible with insulated ferrule	1 or 2 x 0.75 ... 2.5 mm <sup>2</sup>	0.75 ... 2.5 mm <sup>2</sup>	0.75 ... 2.5 mm <sup>2</sup>
 Flexible	1 or 2 x 0.75 ... 2.5 mm <sup>2</sup>	0.75 ... 2.5 mm <sup>2</sup>	0.75 ... 2.5 mm <sup>2</sup>
 Stranded acc. to UL/CSA	1 or 2 x AWG 16-10	AWG 18-10	AWG 18-10
 Flexible acc. to UL/CSA	1 or 2 x AWG 16-10	AWG 18-10	AWG 18-10
Stripping length	9 mm	9 mm	9 mm
Tightening torque	0.8 ... 1.2 Nm / 7 ... 11 lb.in	0.8 ... 1.2 Nm / 7 ... 11 lb.in	0.8 ... 1.2 Nm / 7 ... 11 lb.in
Recommended screw driver	M3 (Pozidriv 2)	M3 (Pozidriv 2)	M3 (Pozidriv 2)

# EF65, EF96, EF146 electronic overload relays – 20 to 150 A

## Ordering details



EF65-70



EF96-100



EF146-150

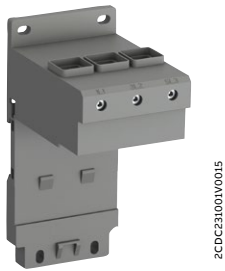

DB96



DB96 + EF96



KPR-101L

The EF65, EF96 and EF146 are self-supplied electronic overload relays, which means no extra external supply is needed. It offers reliable protection for motors in the event of overload or phase failure. Easy to use like a thermal overload relay and compatible with standard motor applications, the electronic overload relay is convincing, above all, due to its wide setting range, high accuracy, high operational temperature range and the possibility to select a trip class (10E, 20E, 30E). Further features are the temperature compensation, trip contact (N.C.), signal contact (N.O.), automatic or manual reset selectable, trip-free mechanism, STOP and TEST function and a trip indication. The overload relays are connected directly to the contactors. The EF65, EF96 and EF146 have ATEX and IECEx certification (1).

Setting range	Short-circuit protective device	Trip class	Type	Order code	Weight (1 pce) kg
A					

### Suitable for AF40, AF52, AF65

20 ... 56	160 A, fuse type gG	10E, 20E, 30E	EF65-56	1SAX331001R1102	0.821
25 ... 70	160 A, fuse type gG	10E, 20E, 30E	EF65-70	1SAX331001R1101	0.821

### Suitable for AF80, AF96

20 ... 56	160A, fuse type gG	10E, 20E, 30E	EF96-56	1SAX341001R1102	0.802
36 ... 100	200 A, fuse type gG	10E, 20E, 30E	EF96-100	1SAX341001R1101	0.802

### Suitable for AF116, AF140, AF146

54 ... 150	315 A, fuse type gG	10E, 20E, 30E	EF146-150	1SAX351001R1101	0.879
------------	---------------------	---------------	-----------	-----------------	-------

(1) ATEX is valid for products produced from week 42, 2014. ATEX certification is valid for EF65-56 produced from week 47, 2015. IECEx is valid for products produced from week 15, 2017.

## Ordering details accessories

Description	Suitable for	Type	Order code	Weight (1 pce) kg
Single mounting kit	EF96, TF96	DB96	1SAZ901901R1001	0.190
Reset push button	E16, EF, TF, T16, TA200	KPR-101L	1SFA616162R1014	0.019

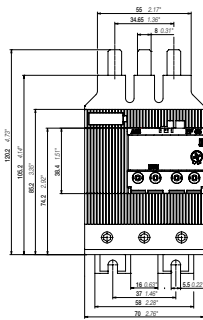

EF65-56 / EF65-70

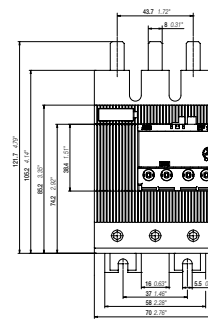
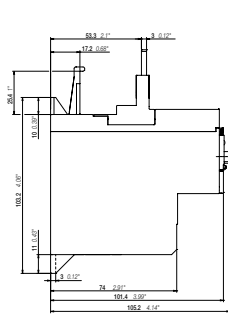

EF96-56 / EF96-100

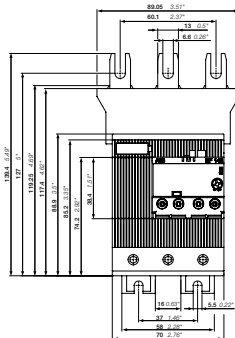
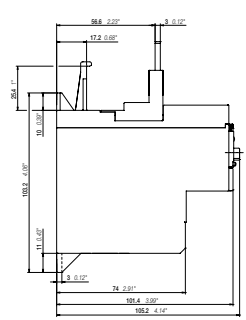

EF146-150

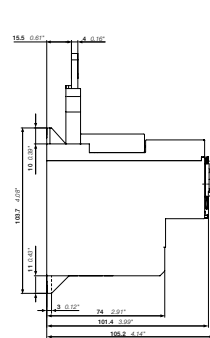

Main dimensions mm, inches

# EF65, EF96, EF146 electronic overload relays – 20 to 150 A

## Technical data

### Main circuit – Utilization characteristics according to IEC/EN

Type	<b>EF65, EF96, EF146</b>
Standards	IEC/EN 60947-1, IEC/EN 60947-4-1, IEC/EN 60947-5-1
Rated operational voltage Ue	1000 V AC
Rated frequency	50/60 Hz – not suitable for DC applications
Trip class	10E, 20E, 30E, selectable
Number of poles	3
Duty time	100%
Operating frequency without early tripping	Up to 15 operations/h, see "Technical diagram – Intermittent periodic duty"
Rated impulse withstand voltage Uimp	8 kV
Rated insulation voltage Ui	1000 V

### Auxiliary circuit according to IEC/EN

Type	<b>EF65, EF96, EF146</b>
Rated operational voltage Ue	600 V AC / DC
Conventional free air thermal current Ith	6 A
Rated frequency	DC, 50/60 Hz
Number of poles	1 N.C. + 1 N.O.
Ie / Rated operational current AC-15 acc. to IEC/EN 60947-5-1 for utilization category	
110-120 V	50/60 Hz 3.00 A
220-230-240 V	50/60 Hz 3.00 A
400 V	50/60 Hz 1.10 A
480-500 V	50/60 Hz 0.75 A
Ie / Rated operational current DC-13 acc. to IEC/EN 60947-5-1 for utilization category	
24 V	1.50 A
60 V	0.55 A
110-120-125 V	0.55 A
250 V	0.27 A
Minimum switching capacity	12 V / 3 mA
Short-circuit protective device	6 A, fuse type gG
Rated impulse withstand voltage Uimp	6 kV
Rated insulation voltage Ui	690 V

### Technical diagram – Intermittent periodic duty

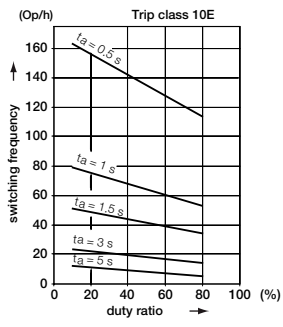

Trip class 10E

2CDC232002F0214

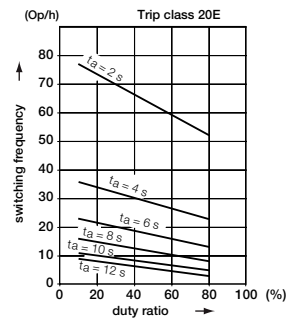

Trip class 20E

2CDC232002F0214

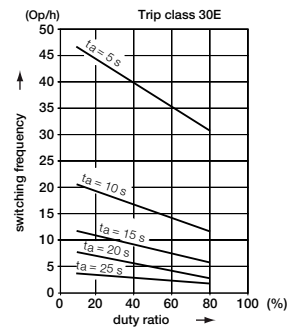

Trip class 30E

2CDC232003F0214

# EF65, EF96, EF146 electronic overload relays – 20 to 150 A

## Technical data

### Main circuit – Utilization characteristics according to UL/CSA

Type	<b>EF65, EF96, EF146</b>
Standards	UL 508, CSA 22.2 No. 14, UL 60947-4-1A
Maximum operational voltage	600 V AC
Trip rating	125% of FLA
Full load amps (FLA)	See table "Full load amps and short-circuit protective device"
Short-circuit rating RMS symmetrical	See table "Full load amps and short-circuit protective device"
Short-circuit protective device	See table "Full load amps and short-circuit protective device"

### Auxiliary circuit according to UL/CSA

Type	<b>EF65, EF96, EF146</b>	
Contact rating	N.C., 95-96	B600, Q600
	N.O., 97-98	B600, Q600
Conventional thermal current	6 A	

### Full load amps and short-circuit protective device

Type	Full load amps (FLA)	Short-circuit protective device					
		480 V AC		600 V AC			
		SCCR	Fuse type	SCCR	Fuse type	SCCR	Fuse type
EF65-56	56 A	10 kA	150 A, K5/RK5	10 kA	150 A, K5/RK5	100 kA	150 A, J
EF65-70	70 A	10 kA	150 A, K5/RK5	10 kA	150 A, K5/RK5	100 kA	150 A, J
EF96-65	56 A	10 kA	150 A, K5/RK5	10 kA	150 A, K5/RK5	100 kA	150 A, J
EF96-100	100 A	10 kA	200 A, K5/RK5	10 kA	200 A, K5/RK5	100 kA	225 A, J
EF146-150	150 A	10 kA	250 A, K5/RK5	10 kA	250 A, K5/RK5	100 kA	350 A, J

# EF65, EF96, EF146 electronic overload relays – 20 to 150 A



## Technical data

### General data

Type	<b>EF65, EF96, EF146</b>	
Pollution degree	3	
Phase loss sensitive	Yes	
Ambient air temperature		
Operation	Open - compensated	-25 ... +70 °C
Storage		-50 ... +85 °C
Ambient air temperature compensation	Acc. to IEC/EN 60947-4-1	
Maximum operating altitude permissible	2000 m	
Resistance to shock acc. to IEC 60068-2-27	15g / 11 ms	
Resistance to vibrations acc. to IEC 60068-2-6	5g / 3 ... 150 Hz	
Mounting position	Position 1-6	
Mounting	Mount on the contactor and tighten the screws of the main circuit terminals	
Degree of protection	Housing	IP20
	Main circuit terminals	IP10





### Electrical connection

#### Main circuit

Type		EF65	EF96	EF146
Connecting capacity				
 Rigid (1)	1 x	4 ... 35 mm <sup>2</sup>	4 ... 70 mm <sup>2</sup>	10 ... 95 mm <sup>2</sup>
	2 x	4 ... 35 mm <sup>2</sup>	4 ... 35 mm <sup>2</sup>	10 ... 35 mm <sup>2</sup>
 Flexible (1)	1 x	4 ... 35 mm <sup>2</sup>	4 ... 50 mm <sup>2</sup>	10 ... 70 mm <sup>2</sup>
	2 x	2.5 ... 35 mm <sup>2</sup>	4 ... 35 mm <sup>2</sup>	10 ... 35 mm <sup>2</sup>
Stranded acc. to UL/CSA	1 x	AWG 10-2	AWG 10-2	AWG 6-00
	2 x			AWG 6-2
Flexible acc. to UL/CSA	1 x	AWG 10-2	AWG 10-2	AWG 6-00
	2 x			AWG 6-2
Stripping length		20 mm	20 mm	20 mm
Tightening torque		4 Nm / 35 lb.in	6 Nm / 55 lb.in	10 Nm / 70 lb.in
Recommended screw driver		M8 (Pozi driv 2)	M8 (Hexagon 4)	M8 (Hexagon 4)

(1) Only one wire size allowed when using 2 wires

#### Auxiliary circuit

Type	EF65, EF96, EF146	
Connecting capacity		
 Rigid	1 or 2 x	1 ... 4 mm <sup>2</sup>
 Flexible with ferrule	1 or 2 x	0.75 ... 2.5 mm <sup>2</sup>
 Flexible with insulated ferrule	1 or 2 x	0.75 ... 2.5 mm <sup>2</sup>
 Flexible	1 or 2 x	0.75 ... 2.5 mm <sup>2</sup>
Stranded acc. to UL/CSA	1 or 2 x	AWG 18-10
Flexible acc. to UL/CSA	1 or 2 x	AWG 18-10
Stripping length		9 mm
Tightening torque		0.8 ... 1.2 Nm / 7 ... 11 lb.in
Recommended screw driver		M3.5 (Pozi driv 2)

# EF205, EF370 electronic overload relays – 63 to 380 A

## Ordering details



EF205-210

2CDC231010V0012



EF370-380

2CDC231013V0012



KPR-101L

1SFC151224F0002

The EF205 and EF370 are self-supplied electronic overload relays, which means no extra external supply is needed. It offers reliable protection for motors in the event of overload or phase failure. Easy to use like a thermal overload relay and compatible with standard motor applications, the electronic overload relay is convincing, above all, due to its wide setting range, high accuracy, high operational temperature range and the possibility to select a trip class (10E, 20E, 30E). Further features are the temperature compensation, trip contact (N.C.), signal contact (N.O.), automatic or manual reset selectable, trip-free mechanism, STOP and TEST function and a trip indication. The overload relays are connected directly to the contactors. The EF205 and EF370 have ATEX and IECEx certification (1).

Setting range	Short-circuit protective device	Trip class	Type	Order code	Weight (1 pce) kg
A					

### Suitable for AF145, AF185, AF190, AF205

63 ... 210	1250 A, fuse type gG	10E, 20E, 30E	EF205-210	1SAX531001R1101	1.210
------------	----------------------	---------------	-----------	-----------------	-------

### Suitable for AF210, AF260, AF265, AF300, AF305, AF370

115 ... 380	1600 A, fuse type gG	10E, 20E, 30E	EF370-380	1SAX611001R1101	1.430
-------------	----------------------	---------------	-----------	-----------------	-------

(1) ATEX is valid for products produced from week 42, 2015. IECEx is valid for products produced from week 15, 2017.

### Ordering details accessories

Description	Suitable for	Type	Order code	Weight (1 pce) kg
Reset push button	E16, EF, TF, T16, TA200	KPR-101L	1SFA616162R1014	0.027
Terminal shroud	EF205	LT200E	1SAX501904R0001	0.085
Terminal shroud	EF370	LT320E	1SAX601904R0001	0.105

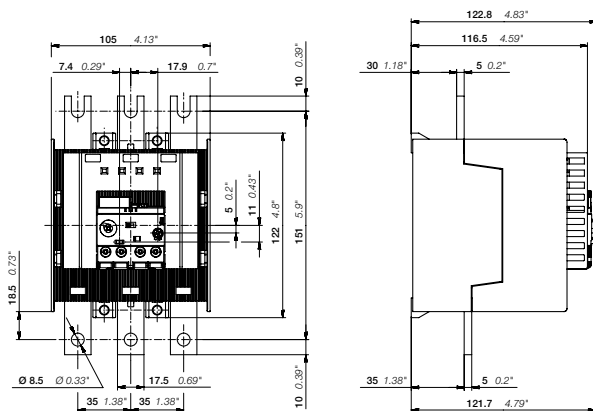

EF205-210

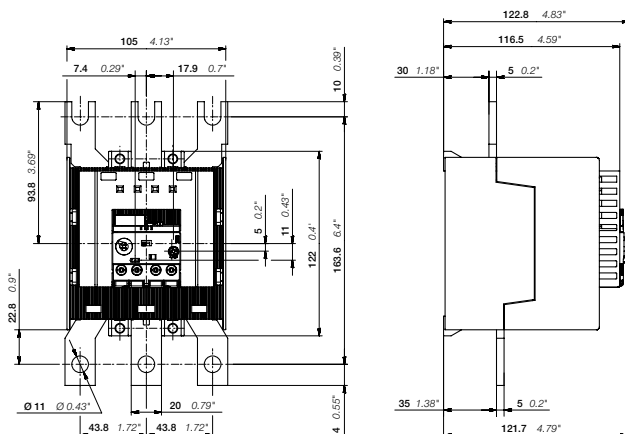

EF370-380

Main dimensions mm, inches



# EF205, EF370 electronic overload relays – 63 to 380 A

## Technical data

### Main circuit – Utilization characteristics according to IEC/EN

Type	<b>EF205, EF370</b>
Standards	IEC/EN 60947-1, IEC/EN 60947-4-1, IEC/EN 60947-5-1
Rated operational voltage Ue	1000 V AC
Rated frequency	50/60 Hz – not suitable for DC applications
Trip class	10E, 20E, 30E, selectable
Number of poles	3
Duty time	100%
Operating frequency without early tripping	Up to 15 operations/h, see "Technical diagram – Intermittent periodic duty"
Rated impulse withstand voltage Uimp	8 kV
Rated insulation voltage Ui	1000 V

### Auxiliary circuit according to IEC/EN

Type	<b>EF205, EF370</b>
Rated operational voltage Ue	600 V AC / DC
Conventional free air thermal current Ith	6 A
Rated frequency	DC, 50/60 Hz
Number of poles	1 N.C. + 1 N.O.
Ie / Rated operational current AC-15 acc. to IEC/EN 60947-5-1 for utilization category	
110-120 V	50/60 Hz 3.00 A
220-230-240 V	50/60 Hz 3.00 A
400 V	50/60 Hz 1.10 A
480-500 V	50/60 Hz 0.75 A
Ie / Rated operational current DC-13 acc. to IEC/EN 60947-5-1 for utilization category	
24 V	1.50 A
60 V	0.55 A
110-120-125 V	0.55 A
250 V	0.27 A
Minimum switching capacity	12 V / 3 mA
Short-circuit protective device	6 A, fuse type gG
Rated impulse withstand voltage Uimp	6 kV
Rated insulation voltage Ui	690 V

### Technical diagram – Intermittent periodic duty

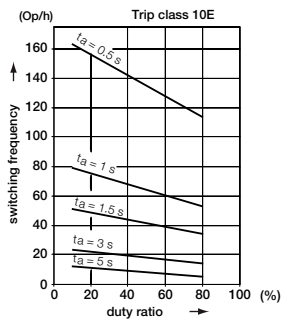

Trip class 10E

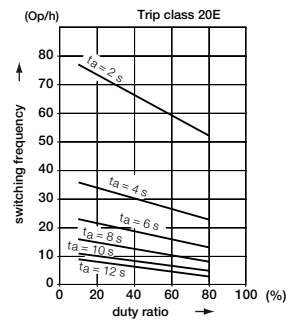

Trip class 20E

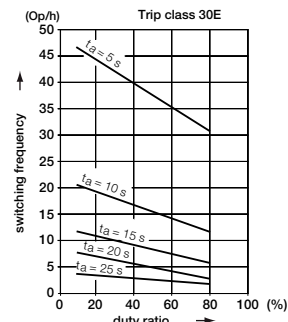

Trip class 30E

## EF205, EF370 electronic overload relays – 63 to 380 A

### Technical data

#### Main circuit – Utilization characteristics according to UL/CSA

Type	<b>EF205, EF370</b>
Standards	UL 508, CSA 22.2 No. 14, UL 60947-4-1A
Maximum operational voltage	600 V AC
Trip rating	125% of FLA
Full load amps (FLA)	See table "Full load amps and short-circuit protective device"
Short-circuit rating RMS symmetrical	See table "Full load amps and short-circuit protective device"
Short-circuit protective device	See table "Full load amps and short-circuit protective device"

#### Auxiliary circuit according to UL/CSA

Type	<b>EF205, EF370</b>	
Contact rating	N.C., 95-96	B600, Q600
	N.O., 97-98	B600, Q600
Conventional thermal current	6 A	

#### Full load amps and short-circuit protective device

Type	Full load amps (FLA)	Short-circuit protective device			
		480 V AC		600 V AC	
		SCCR	Fuse type	SCCR	Fuse type
EF205-210	210 A	10 kA	400 A, R5/RK5	10kA	400 A, R5/RK5
EF370-380	380 A	18 kA	800 A, L/T	18kA	800 A, L/T

# EF205, EF370 electronic overload relays – 63 to 380 A





## Technical data

### General data





Type	EF205	EF370
Pollution degree	3	
Phase loss sensitive	Yes	
Ambient air temperature		
Operation	Open - compensated	
Storage		
Operation	-25 ... +70 °C	
Storage	-50 ... +85 °C	
Ambient air temperature compensation	Acc. to IEC/EN 60947-4-1	
Maximum operating altitude permissible	2000 m	
Resistance to shock acc. to IEC 60068-2-27	25g / 11 ms	
Resistance to vibrations acc. to IEC 60068-2-6	5g / 3 ... 150 Hz	
Mounting position	Position 1-6	
Mounting	Mount on the contactor and tighten the screws of the main circuit terminals	
Degree of protection	Housing	IP20
	Main circuit terminals	IP20

### Electrical connection

#### Main circuit

Type	EF205	EF370
Connecting capacity		
 Rigid	1 x 16 ... 185 mm <sup>2</sup> 2 x 16 ... 120 mm <sup>2</sup>	50 ... 240 mm <sup>2</sup> 50 ... 150 mm <sup>2</sup>
 Flexible	1 x 16 ... 185 mm <sup>2</sup> 2 x 16 ... 120 mm <sup>2</sup>	50 ... 240 mm <sup>2</sup> 50 ... 150 mm <sup>2</sup>
 Lugs	L ≤ 24 mm	32 mm
 Bars	Ø > 8 mm	10 mm
Stranded acc. to UL/CSA	1 x AWG 6-0000 2 x AWG 6-0000	AWG 1-500 kcmil AWG 1-500 kcmil
Flexible acc. to UL/CSA	1 x AWG 6-0000 2 x AWG 6-0000	AWG 1-500 kcmil AWG 1-500 kcmil
Stripping length	-	-
Tightening torque	18 Nm / 160 lb.in	28 Nm / 247 lb.in
Recommended screw driver	M8	M10

#### Auxiliary circuit

Type	EF205, EF370
Connecting capacity	
 Rigid	1 or 2 x 1 ... 4 mm <sup>2</sup>
 Flexible with ferrule	1 or 2 x 0.75 ... 2.5 mm <sup>2</sup>
 Flexible with insulated ferrule	1 or 2 x 0.75 ... 2.5 mm <sup>2</sup>
 Flexible	1 or 2 x 0.75 ... 2.5 mm <sup>2</sup>
Stranded acc. to UL/CSA	1 or 2 x AWG 18-10
Flexible acc. to UL/CSA	1 or 2 x AWG 18-10
Stripping length	9 mm
Tightening torque	0.8 ... 1.2 Nm / 7 ... 11 lb.in
Recommended screw driver	M3.5 (Poqidriv 2)

# EF460, EF750, EF1250DU electronic overload relays – 150 to 1250 A

## Ordering details

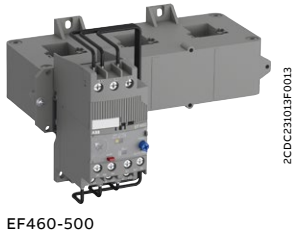

EF460-500

2CDC231033F0013

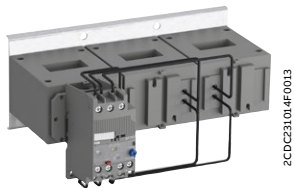

EF750-800

2CDC231014F0013



EF1250DU-1250

2CDC231014F0013



KPR-101L

1SFCL5224F0002

The EF460, EF750 and EF1250DU are self-supplied electronic overload relays, which means no extra external supply is needed. It offers reliable protection for motors in the event of overload or phase failure. Easy to use like a thermal overload relay and compatible with standard motor applications, the electronic overload relay is convincing, above all, due to its wide setting range, high accuracy, high operational temperature range and the possibility to select a trip class (10E, 20E, 30E). Further features are the temperature compensation, trip contact (N.C.), signal contact (N.O.), automatic or manual reset selectable, trip-free mechanism, STOP and TEST function and a trip indication. Busbar kits are available as accessory for contactor mounting. The EF460 and EF750 have ATEX and IECEx certification (1).

Setting range	Short-circuit protective device	Trip class	Type	Order code	Weight (1 pce) kg
A					

### EF460 electronic overload relay, suitable for AF400, AF460 (1)

150 ... 500	690 V: 630 A, Type gG 1000 V: 1600 A, Type gG	10E, 20E, 30E	EF460-500	1SAX721001R1101	1.170
-------------	--	---------------	-----------	-----------------	-------

### EF750 electronic overload relay, suitable for AF580, AF750 (1)

250 ... 800	690 V: 800 A, Type gG 1000 V: 1600 A, Type gG	10E, 20E, 30E	EF750-800	1SAX821001R1101	3.905
-------------	--	---------------	-----------	-----------------	-------

### EF1250DU electronic overload relay, suitable for AF1350, AF1650, AF2050

375 ... 1250	500 V: 1600 A, Type gG	10E, 20E, 30E	EF1250DU-1250	1SFA739001R1001	
--------------	------------------------	---------------	---------------	-----------------	--

(1) ATEX is valid for products produced from week 42, 2014. IECEx is valid for products produced from week 15, 2017.

## Ordering details accessories

Description	Suitable for	Type	Order code	Weight (1 pce) kg
Reset push button	E16, EF, TF, T16, TA200	KPR-101L	1SFA616162R1014	0.027
Terminal shroud	EF460	LT460EF	1SAX701904R0002	0.320
Terminal shroud	EF750	LT750EF	1SAX801904R0002	0.440
DT500/AF460-S Mounting Kit short for mounting of EF460DU on AF460	EF460	DT500/AF460-S	1SAX701902R1011	0.635
DT500/AF460-L Mounting Kit long for mounting of EF460DU on AF460	EF460	DT500/AF460-L	1SAX701902R1001	0.740
DT800/AF750-S Mounting Kit short for mounting of EF750DU on AF750	EF750	DT800/AF750-S	1SAX801902R1011	1.000
DT800/AF750-L Mounting Kit long for mounting of EF750DU on AF750	EF750	DT800/AF750-L	1SAX801902R1001	1.475

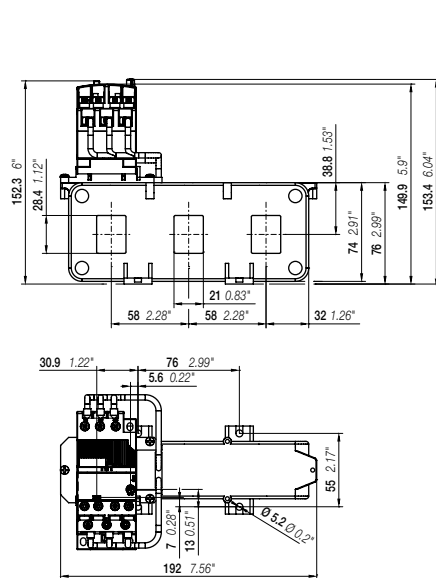

EF460-500 Dimensions mm, inches

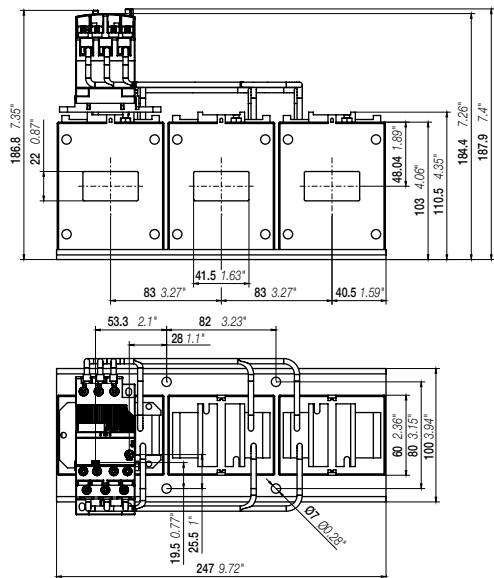

EF750-800

2CDC107045C0201

# EF460, EF750, EF1250DU electronic overload relays – 150 to 1250 A

## Technical data

### Main circuit – Utilization characteristics according to IEC/EN

Type	EF460	EF750	EF1250DU
Standards	IEC/EN 60947-1, IEC/EN 60947-4-1, IEC/EN 60947-5-1		
Rated operational voltage Ue	1000 V AC		
Rated frequency	50/60 Hz – not suitable for DC applications		
Trip class	10E, 20E, 30E, selectable		
Number of poles	3		
Duty time	100%		
Operating frequency without early tripping	Up to 15 operations/h, see "Technical diagram – Intermittent periodic duty"		
Rated impulse withstand voltage Uimp	8 kV		
Rated insulation voltage Ui	1000 V AC		

### Auxiliary circuit according to IEC/EN

Type	EF460	EF750	EF1250DU
Rated operational voltage Ue	600 V AC / DC		
Conventional free air thermal current Ith	6 A		
Rated frequency	DC, 50/60 Hz		
Number of poles	1 N.C. + 1 N.O.		
Ie / Rated operational current AC-15 acc. to IEC/EN 60947-5-1 for utilization category			
110-120 V	50/60 Hz	3.00 A	
220-230-240 V	50/60 Hz	3.00 A	
400 V	50/60 Hz	1.10 A	
480-500 V	50/60 Hz	0.75 A	
Ie / Rated operational current DC-13 acc. to IEC/EN 60947-5-1 for utilization category			
24 V		1.50 A	
60 V		0.55 A	
110-120-125 V		0.55 A	
250 V		0.27 A	
Minimum switching capacity	12 V / 3 mA		
Short-circuit protective device	6 A, fuse type gG		
Rated impulse withstand voltage Uimp	6 kV		
Rated insulation voltage Ui	690 V		

### Technical diagram – Intermittent periodic duty

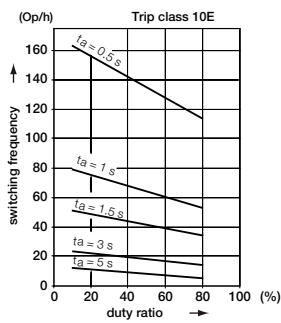

Trip class 10E

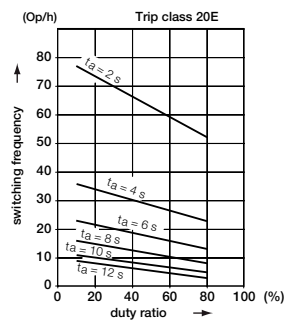

Trip class 20E

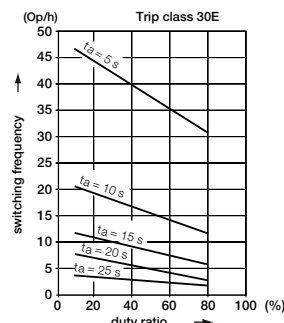

Trip class 30E

## EF460, EF750, EF1250DU electronic overload relays – 150 to 1250 A

### Technical data

#### Main circuit – Utilization characteristics according to UL/CSA

Type	EF460	EF750	EF1250DU
Standards	UL60947-1, UL60947-4-1		
Maximum operational voltage	600 V AC		
Trip rating	125% of FLA		

#### Auxiliary circuit according to UL/CSA





Type	EF460	EF750	EF1250DU
Contact rating	N.C., 95-96 N.O., 97-98	B600, Q300	
Conventional thermal current	5 A		

#### General data

Type	EF460	EF750	EF1250DU
Pollution degree	3		
Phase loss sensitive	Yes		
Ambient air temperature			
Operation	Open - compensated		
Storage	-25 ... +70 °C		
Ambient air temperature compensation	Acc. to IEC/EN60947-4-1		
Maximum operating altitude permissible	2000 m		
Resistance to shock acc. to IEC 60068-2-27	25g / 11 ms		
Resistance to vibrations acc. to IEC 60068-2-6	3g / 3 ... 150 Hz		
Degree of protection	Housing	IP20	
	Main circuit terminals	IP00	

#### Electrical connection

##### Auxiliary circuit

Type	EF460	EF750	EF1250DU
Connecting capacity			
 Rigid	1 or 2 x	1 ... 4 mm <sup>2</sup>	
 Flexible with ferrule	1 or 2 x	0.75 ... 2.5 mm <sup>2</sup>	
 Flexible with insulated ferrule	1 or 2 x	0.75 ... 2.5 mm <sup>2</sup>	
 Flexible	1 or 2 x	0.75 ... 2.5 mm <sup>2</sup>	
	Stranded acc. to UL/CSA	1 or 2 x AWG 18-10	
	Flexible acc. to UL/CSA	1 or 2 x AWG 18-10	
Stripping length	9 mm		
Tightening torque	0.8 ... 1.2 Nm / 7 ... 11 lb.in		
Recommended screw driver	M3.5 (Poqidriv 2)		

# Thermal and electronic overload relays

## General accessories

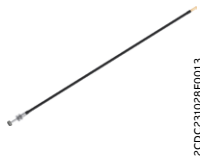

WRB-400

2CDC31028F0013



WRH-F

2CDC31027F0013

The wire reset is a general accessory for thermal and electronic overloads relays. In installations which are difficult to access, like a motor control centre or compact cubical, the accessory allows the user to remotely reset the overload relays.

The wire reset consists of two parts, the bowden wire with actuator and the holder. The actuator should be mounted into a door of a panel. The holder will be mounted on the overload relay. The actuator and holder are connected via the bowden wire.

Suitable for	Description	Length mm	Type	Order code	Weight (1 pce) kg
<b>Holder</b>					
TF42, TF65, TF96, EF19, EF45, EF65, EF96, EF146, EF205, EF370, EF460, EF750	Holder for tool less direct mounting		WRH-F	1SAZ701903R1001	0.006
<b>Bowden wire with actuator</b>					
WRH-F	Bowden wire with actuator, hole diameter: 7.3 mm, maximum panel thickness: 12 mm	400	WRB-400	1SAZ701903R1011	0.030
		600	WRB-600	1SAZ701903R1012	0.040
		1000	WRB-1000	1SAZ701903R1013	0.060
<b>IP54 gasket</b>					
WRB-400 WRB-600 WRB-1000	IP54 Panel seal gasket		WRBG	1SAZ701903R1030	0.037

### Overload relays with accessory wire reset (WRH, WRB)

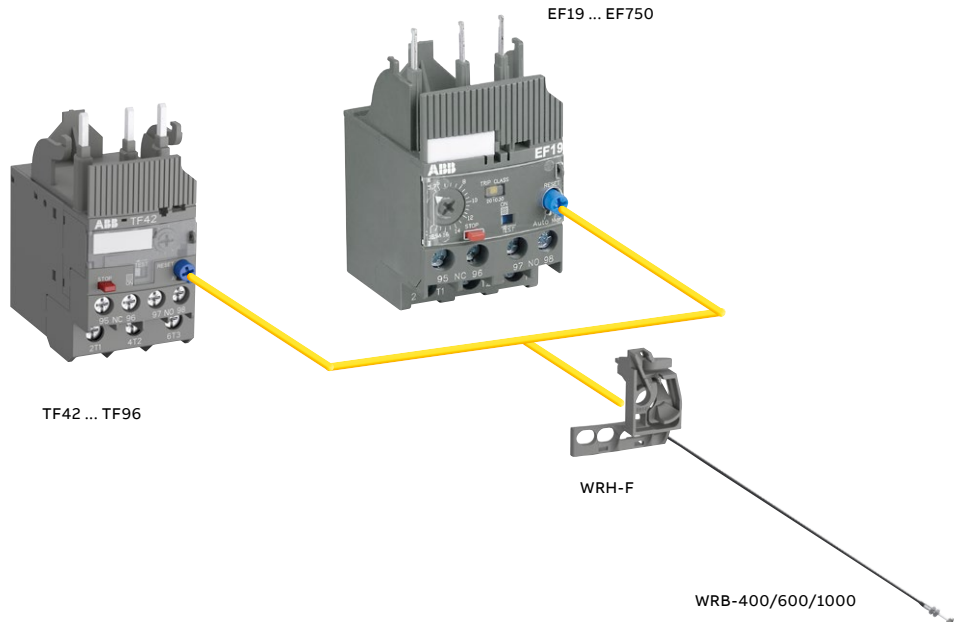

—  
**Notes**

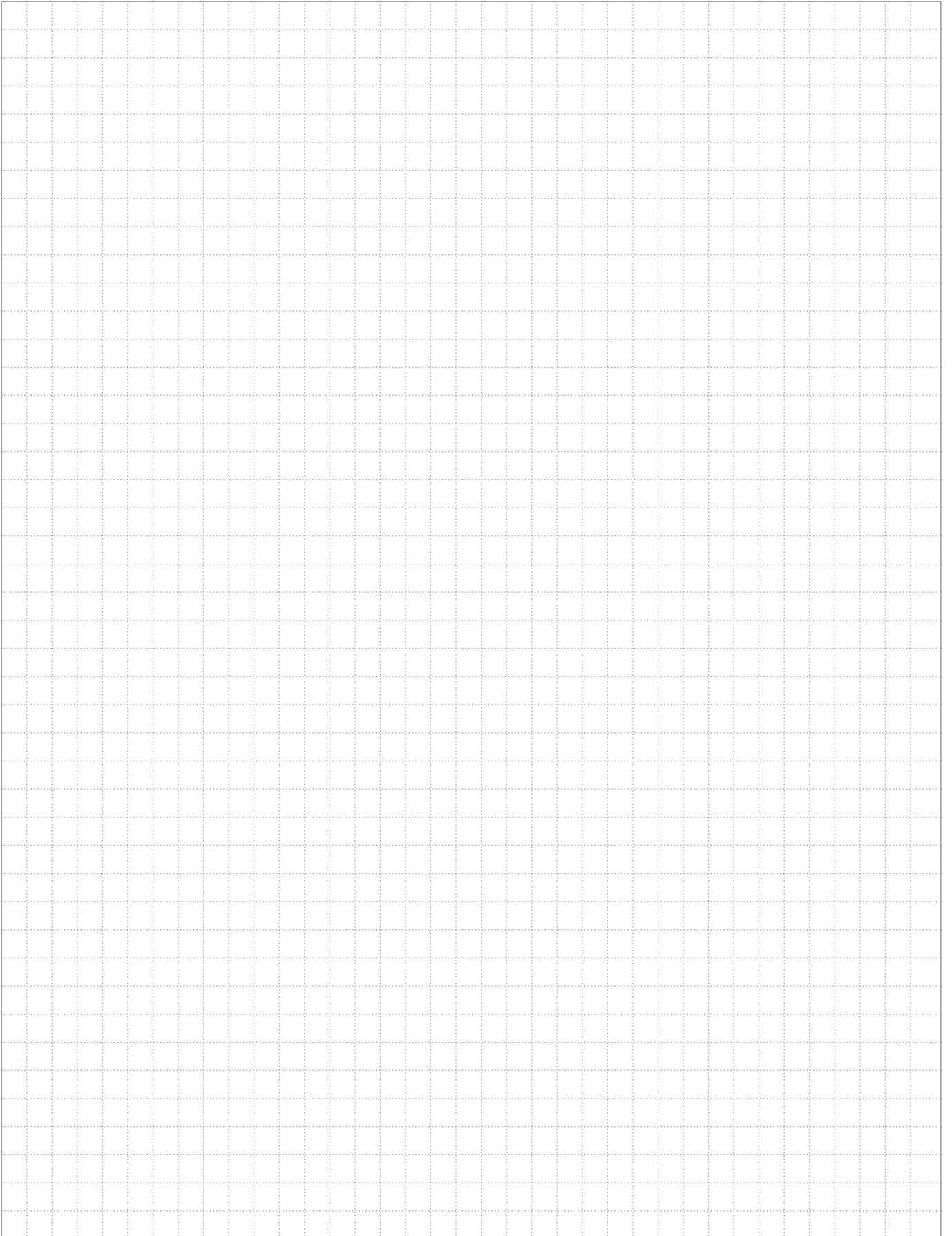





**For direct product details information, use product type or order code, ex:**

[www.abb.com/productdetails/CM-MSS.11P](http://www.abb.com/productdetails/CM-MSS.11P)

or

[www.abb.com/productdetails/1SVR740720R1400](http://www.abb.com/productdetails/1SVR740720R1400)

# Thermistor motor protection relays

- 7/2 Benefits and advantages, Applications**
- 7/3 Operating controls**
- 7/4 Selection table CM-MSx range**
- 7/5 Ordering details**
- 7/6 Ordering details - PTC temperature sensors C011**
- 7/7 Technical data - CM-MSS**
- 7/10 Technical data - CM-MSE**
- 7/12 Connection diagrams**
- 7/13 Circuit diagram**

## Thermistor motor protection relays

### Benefits and advantages, Applications

The thermistor motor protection relays of the CM-MSx range protect motors with PTC sensors against high temperature. These sensors are incorporated in the motor windings thus measuring the motor heat directly.

#### Direct temperature measuring

Generally, motor damages caused by overload or overheating situations can be prevented in different ways. Compared to the indirect temperature measuring which monitors the motor current, the temperature inside the motor can be measured by direct temperature measuring.

This enables direct control and evaluation of the following operating conditions like:







- Heavy duty starting
- Increased switching frequency
- Single phase operation
- Phase unbalance
- High ambient temperature
- Insufficient cooling
- Breaking operation

Therefore the consequences from overheating like abrasion as well as electrical failures can be prevented.

The direct measuring principle is carried out by a combination of the thermistor motor protection relay and 3 PTC sensors which are installed directly in the motor by the manufacturer. Those 3 PTC sensors are placed directly at the thermal hotspots, the motor windings.

#### Characteristics CM-MSS (1)

- Different types of contacts available
  - 1 x 2 c/o (SPDT) contacts
  - 2 x 1 c/o (SPDT) contact
  - 1 n/o and 1 n/c contact
- 1 or 2 measuring circuits
- Different types of reset functions
  - Automatic
  - Manual
  - Remote
- Rated control supply voltages
  - 24 V AC/DC
  - 24-240 V AC/DC
  - 110-130 V AC, 220-240 V AC
- Approvals / Marks

      (1) / CE 

#### Characteristics CM-MSE

- Auto reset
- Connection of several sensors (max. 6 sensors connected in series)
- Monitoring of bimetals
- 1 n/o contact
- Excellent cost / performance ratio

#### Monitoring the motor

The thermistor motor protection relay measures the resistance of the PTC sensors which reflects the internal motor temperature permanently.

If the temperature in the motor windings rises excessively and reaches the nominal response temperature (NRT), the thermistor motor protection relay detects this situation and the output relay switches off.

By doing so the motor contactor gets triggered and switches off the motor.

#### CM-MSS functionality video



#### Features (1)

- Additional functions:
  - Dynamic interrupted wire detection
  - Short-circuit monitoring of the sensor circuit
  - Non-volatile fault storage
  - Single or sum evaluation
- Easy configuration via DIP switches
- LEDs to distinguish between different failure causes
- Screw connection technology or Easy Connect Technology available
- Test/Reset button available

(1) Depending on device the characteristics vary, for detailed overview see "Selection table CM-MSx range" on page 4.

# Thermistor motor protection relays

## Operating controls

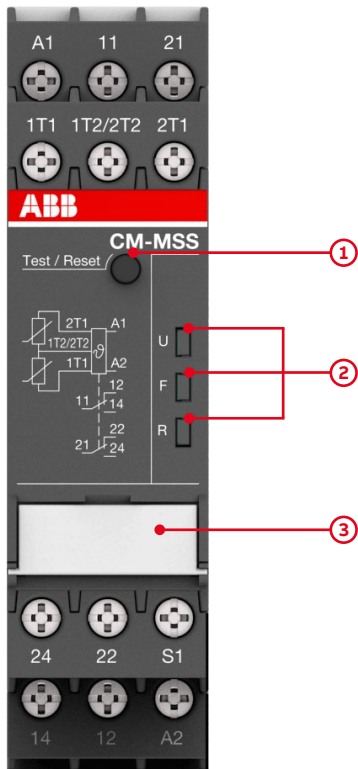

- 1 Test / Reset button**  
 Reset - only possible if measured value < switch-on resistance
- 2 Indication of operational states with LEDs**  
 U: green LED - Status indication of control supply voltage  
 Control supply voltage applied  
 F: red LED - Fault message  
 R: yellow LED - Status indication of the output relay
- 3 Marker label / DIP switches (depending on device) e.g.**

  - Single evaluation 2 x 1 c/o (SPDT) contact
  - Accumulative evaluation 1 x 2 c/o (SPDT) contacts
  - Short-circuit detection de-activated
  - Short-circuit detection activated
  - Non-volatile fault storage activated
  - Non-volatile fault storage de-activated
  - Remote Reset
  - Remote Test/Reset

### LEDs, status information and fault messages CM-MSS

Operational state	U: green LED	F: red LED	R: yellow LED
Absence of control supply voltage	OFF	OFF	OFF
Internal fault (2)	OFF		
Internal fault (2)			
Control supply voltage not within the tolerance range			OFF
Short circuit			OFF
Interrupted wire			OFF
Measuring circuit 2: Overtemperature			OFF
Measuring circuit 1: Overtemperature			OFF
Fault rectified but not confirmed		-- (1)	
Test function		OFF	OFF
Change of configuration not confirmed		OFF	
No fault		OFF	

(1) Depending on the fault with the highest priority  
 (2) Restart the device. If after restart the same fault is indicated, replace the device.

2CDC 253 001 F0015

07

# Thermistor motor protection relays

## Selection table CM-MSx range

Type	Order code
CM-MSE	1SVR55080SR9300
CM-MSE	1SVR55080OR9300
CM-MSE	1SVR55080IR9300
CM-MSS.11P	1SVR740720R1400
CM-MSS.11S	1SVR730720R1400
CM-MSS.12P	1SVR740700R0100
CM-MSS.12S	1SVR730700R0100
CM-MSS.13P	1SVR740700R2100
CM-MSS.13S	1SVR730700R2100
CM-MSS.21P	1SVR740722R1400
CM-MSS.21S	1SVR730722R1400
CM-MSS.22P	1SVR740700R0200
CM-MSS.22S	1SVR730700R0200
CM-MSS.23P	1SVR740700R2200
CM-MSS.23S	1SVR730700R2200
CM-MSS.31P	1SVR740712R1400
CM-MSS.31S	1SVR730712R1400
CM-MSS.32P	1SVR740712R0200
CM-MSS.32S	1SVR730712R0200
CM-MSS.33P	1SVR740712R2200
CM-MSS.33S	1SVR730712R2200
CM-MSS.41P	1SVR740712R1200
CM-MSS.41S	1SVR730712R1200
CM-MSS.51P	1SVR740712R1300
CM-MSS.51S	1SVR730712R1300

### Characteristics

ATEX approval				■	■						■	■						■	■	■	■	■	■	■	■	■	■	■	■	■	■	■	■	■	■		
Number of sensor circuits	1	1	1	1	1	1	1	1	1	1	1	1	1	1	1	1	1	1	1	1	1	1	1	1	1	1	1	1	1	2	2						
Single or accumulative evaluation																																		■	■		
Number of LEDs				3	3	2	2	2	2	2	3	3	2	2	2	2	2	3	3	3	3	3	3	3	3	3	3	3	3	3	3	3	3	3	3	3	

### Contacts

1 c/o (SPDT) contact						■	■	■	■																											
2 c/o (SPDT) contacts													■	■	■	■																				
1 n/o	■	■	■																																	
1 n/c and 1 n/o				■	■						■	■									■	■														
2 x 1 c/o or 1 x 2 c/o contacts, configurable																																		■	■	

### Reset

Manual													■	■	■	■	■	■	■	■	■	■	■	■	■	■	■	■	■	■	■	■	■	■	■	
Remote													■	■	■	■	■	■	■	■	■	■	■	■	■	■	■	■	■	■	■	■	■	■	■	■
Auto	■	■	■	■	■	■	■	■	■	■	■	■	■ <sup>(1)</sup>	■ <sup>(1)</sup>	■ <sup>(1)</sup>	■ <sup>(1)</sup>	■ <sup>(1)</sup>	■ <sup>(1)</sup>	■ <sup>(1)</sup>	■ <sup>(1)</sup>	■ <sup>(1)</sup>	■ <sup>(1)</sup>	■ <sup>(1)</sup>	■ <sup>(1)</sup>	■ <sup>(1)</sup>	■ <sup>(1)</sup>	■ <sup>(1)</sup>	■ <sup>(1)</sup>	■ <sup>(1)</sup>	■ <sup>(1)</sup>	■ <sup>(1)</sup>	■ <sup>(2)</sup>	■ <sup>(2)</sup>	■ <sup>(2)</sup>	■ <sup>(2)</sup>	
Test button																																				

### Functions

Short-circuit detection												■	■								■	■	■	■	■	■										
Short-circuit detection, configurable																																				
Dynamic interrupted wire detection				■	■						■	■									■	■	■	■	■	■	■	■	■	■	■	■	■	■	■	■
Non-volatile fault storage				■	■						■	■									■	■														
Non-volatile fault storage, configurable																																				

### Rated control supply voltage U<sub>c</sub>

24 V AC	■																																			
110-130 V AC		■																																		
220-240 V AC			■																																	
24-240 V AC/DC				■	■							■	■																							
24 V AC/DC						■	■																													
110-130 V AC, 220-240 V AC								■	■																											

### Connection type

Push-in terminals				■		■		■		■		■		■		■		■		■		■		■		■		■		■		■		■		
Double-chamber cage connection terminals					■		■		■		■		■		■		■		■		■		■		■		■		■		■		■		■	

(1) For automatic reset, connect terminals S1 to T2.  
 (2) For automatic reset, connect Terminals S1 to 1T2/2T2.

# Thermistor motor protection relays

## Ordering details



CM-MSS.12S

2CDC251.004.V0014



CM-MSS.41S

2CDC251.013.V0014



CM-MSS.51S

2CDC251.014.V0014

The thermistor motor protection relay CM-MSS monitors the winding temperature and thus protects the motor from overheating, overload and insufficient cooling in accordance to the product standard IEC 60947-8.

### CM-MSx

Characteristics	Type	Order code	Price 1 pce	Weight (1 pce) kg (lb)
	CM-MSE	1SVR550805R9300		0.11 (0.24)
	CM-MSE	1SVR550800R9300		0.11 (0.24)
	CM-MSE	1SVR550801R9300		0.11 (0.24)
	CM-MSS.11P	1SVR740720R1400		0.119 (0.263)
	CM-MSS.11S	1SVR730720R1400		0.127 (0.280)
	CM-MSS.12P	1SVR740700R0100		0.105 (0.231)
	CM-MSS.12S	1SVR730700R0100		0.113 (0.249)
	CM-MSS.13P	1SVR740700R2100		0.147 (0.324)
	CM-MSS.13S	1SVR730700R2100		0.155 (0.342)
	CM-MSS.21P	1SVR740722R1400		0.118 (0.260)
	CM-MSS.21S	1SVR730722R1400		0.126 (0.278)
	CM-MSS.22P	1SVR740700R0200		0.121 (0.267)
	CM-MSS.22S	1SVR730700R0200		0.132 (0.291)
	CM-MSS.23P	1SVR740700R2200		0.163 (0.359)
	CM-MSS.23S	1SVR730700R2200		0.174 (0.384)
	CM-MSS.31P	1SVR740712R1400		0.120 (0.265)
	CM-MSS.31S	1SVR730712R1400		0.128 (0.282)
	CM-MSS.32P	1SVR740712R0200		0.120 (0.265)
	CM-MSS.32S	1SVR730712R0200		0.130 (0.287)
	CM-MSS.33P	1SVR740712R2200		0.162 (0.357)
	CM-MSS.33S	1SVR730712R2200		0.172 (0.379)
	CM-MSS.41P	1SVR740712R1200		0.130 (0.287)
	CM-MSS.41S	1SVR730712R1200		0.141 (0.311)
	CM-MSS.51P	1SVR740712R1300		0.135 (0.298)
	CM-MSS.51S	1SVR730712R1300		0.145 (0.320)

See "Selection table CM-MSx range" on page 4.

S: screw connection  
P: push-in connection



Further documentation thermistor motor protection monitoring relays on [www.abb.com](http://www.abb.com)

# Thermistor motor protection relays

## Ordering details - PTC temperature sensors C011



15VC.110.000.F0631

Temperature sensor characteristics

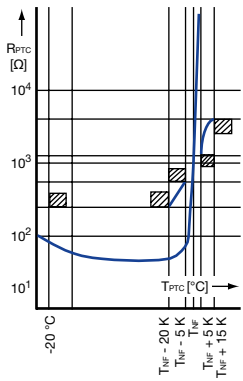

2CDC.252.068.F0208

The PTC temperature sensors (temperature-dependent with positive temperature coefficient) are selected by the manufacturer of the motor depending on:

- the motor insulation class according to IEC/EN 60034-11,
- the special characteristics of the motor, such as the conductor cross-section of the windings, the permissible overload factor etc.
- special conditions prescribed by the user, such as the permissible ambient temperature, risks resulting from locked rotor, extent of permitted overload etc.

One temperature sensor must be embedded in each phase winding. For instance, in case of three-phase squirrel cage motors, three sensors are embedded in the stator windings. For pole-changing motors with one winding (Dahlander connection), 3 sensors are also sufficient. Pole-changing motors with two windings, however, require The sensors are suitable for embedding in motor windings with rated operating voltages of up to 600 V AC. Conductor length: 500 mm per sensor. A 14 V varistor can be connected in parallel to protect the sensors from overvoltage. Due to their characteristics, the thermistor motor protection relays can also be used with PTC temperature sensors of other manufacturers which comply with DIN 44 081 and DIN 44 082 6 sensors.

If an additional warning is required before the motor is switched off, separate sensors for a correspondingly lower temperature must be embedded in the winding. They have to be connected to a second control unit.

### CM-MSS accessories

Rated response temperature TNF	Color coding	Type	Order code	Price 1 pce	Weight (1 pce) kg (lb)
70 °C	white-brown	C011-70 (1)	GHC0110003R0001		0.02 (0.044)
80 °C	white-white	C011-80 (1)	GHC0110003R0002		0.02 (0.044)
90 °C	green-green	C011-90 (1)	GHC0110003R0003		0.02 (0.044)
100 °C	red-red	C011-100 (1)	GHC0110003R0004		0.02 (0.044)
110 °C	brown-brown	C011-110 (1)	GHC0110003R0005		0.02 (0.044)
120 °C	gray-gray	C011-120 (1)	GHC0110003R0006		0.02 (0.044)
130 °C	blue-blue	C011-130 (1)	GHC0110003R0007		0.02 (0.044)
140 °C	white-blue	C011-140 (1)	GHC0110003R0011		0.02 (0.044)
150 °C	black-black	C011-150 (1)	GHC0110003R0008		0.02 (0.044)
160 °C	blue-red	C011-160 (1)	GHC0110003R0009		0.02 (0.044)
170 °C	white-green	C011-170 (1)	GHC0110003R0010		0.02 (0.044)
150 °C	black-black	C011-3-150 (2)	GHC0110033R0008		0.05 (0.11)

(1) Temperature sensor C011, standard version acc. to DIN 44081

(2) Triple temperature sensor C011-3

### Technical data

Characteristic data	Sensor type C011
Cold-state resistance	50 -100 Ω at 25 °C
Warm-state resistance ± 5 up to 6 K of rated response temperature TNF	10 000 Ω
Thermal time constant, sensor open (1)	< 5 s
Permitted ambient temperature	+180 °C

Rated response temperature ± tolerance TNF ± ΔTNF	PTC resistance R from -20 °C to TNF - 20 K	PTC resistance R2) at PTC temperatures of:		
		TNF - ΔTNF (UPTC ≤ 2.5 V)	TNF + ΔTNF (UPTC ≤ 2.5 V)	TNF + 15 K (UPTC ≤ 7.5 V)
70 ± 5 °C	≤ 100 Ω	≤ 570 Ω	≥ 570 Ω	-
80 ± 5 °C		≤ 550 Ω	≥ 1330 Ω	≥ 4000 Ω
90 ± 5 °C				
100 ± 5 °C				
110 ± 5 °C				
120 ± 5 °C				
130 ± 5 °C				
140 ± 5 °C				
150 ± 5 °C				
160 ± 5 °C		≤ 570 Ω	≥ 570 Ω	-
170 ± 7 °C				

(1) Not embedded in windings.

(2) For triple temperature sensor take values x 3.

## Thermistor motor protection relays

### Technical data - CM-MSS

Data at  $T_a = 25\text{ °C}$  and rated values, unless otherwise indicated

Supply circuit - Input circuit	CM-MSS.x1	CM-MSS.x2	CM-MSS.x3
Rated control supply voltage $U_s$	A1-A2	24-240 V AC/DC	24 V AC/DC
	A2-A3	-	-
Rated control supply voltage $U_s$ tolerance	-15...+10 %		
Rated frequency	15-400 Hz	50-60 Hz	
Electrical insulation between supply circuit and measuring circuit	yes	no	yes
Power failure buffering time	20 ms		

#### Supply circuit - Measuring circuit / Sensor circuit

Number of circuits	1 (CM-MSS.51: 2)		
Sensor type	PTC type A (DIN/EN 44081, DIN/EN 44082)		
Max. total resistance of sensors connected in series, cold state	< 750 $\Omega$		
Overtemperature monitoring	switch-off resistance (relay de-energizes)	2.83 k $\Omega$ $\pm$ 1% (CM-MSS.12 /13 /22 /23: 2.7 k $\Omega$ $\pm$ 5%)	
	switch-on resistance (relay energizes)	1.1 k $\Omega$ $\pm$ 1% (CM-MSS.12 /13 /22 /23: 1.2 k $\Omega$ $\pm$ 5%)	
Maximum voltage in sensor circuit	1.33 kW	2.5 V	
	4 kW	3.7 V	
	$\infty$ kW	5.5 V	
Maximum current in sensor circuit	3.7 mA		
Maximum sensor cable length	2 x 100 m at 0.75 mm <sup>2</sup> , 2 x 400 m at 2.5 mm <sup>2</sup>		
Accuracy within the rated control supply voltage tolerance	0.50 % (CM-MSS.12 /13 /22 /23: 5 %)		
Accuracy within the temperature range	0.01 %/K (CM-MSS.12 /13 /22 /23: 0.5 %/K)		
Repeat accuracy (constant parameters)	on request		
Reaction time of the safety function	< 100 ms		
Hardware fault tolerance (HFT)	0		

#### Control circuit

Control function	see "Selection table CM-MSx range" on page 4
Maximum no-load voltage	5.5 V
Max. current	0.6 mA (CM-MSS.12 /13 /22 /23: 1.2 mA)
Maximum cable length	2 x 100 m at 0.75 mm <sup>2</sup> , 2 x 400 m at 2.5 mm <sup>2</sup>

#### Indication of operational states

Control supply voltage	U	LED green
Relay status	R	LED yellow
Fault message	F	LED red

#### Output circuit

Kind of output	see "Selection table CM-MSx range" on page 4		
Operating principle	closed-circuit principle		
Contact material	AgNi alloy, Cd free		
Rated operational voltage $U_e$ (IEC/EN 60947-1)	250 V AC		
Minimum switching voltage / Minimum switching current	24 V / 10 mA		
Maximum switching voltage / Maximum switching current	see data sheet		
Rated operating current $I_e$ (IEC/EN 60947-5-1)	AC-12 (resistive) at 230 V	4 A	
	AC-15 (inductive) at 230 V	3 A	
	DC-12 (resistive) at 24 V	4 A	
	DC-13 (inductive) at 24 V	2 A	
AC Rating (UL 508)	utilization category (Control Circuit Rating Code)	B 300	
	maximum rated operational voltage	300 V AC	
	maximum continuous thermal current at B 300	5 A	
	maximum making/breaking apparent power at B 300	3600/360 VA	
	general purpose rating	250 V AC - 4 A	
Mechanical lifetime	30 x 10 <sup>6</sup> switching cycles		
Electrical lifetime	at AC12, 230 V AC, 4 A	0.1 x 10 <sup>6</sup> switching cycles	
Maximum fuse rating to achieve short-circuit protection	n/c contact	10 A fast-acting (CM-MSS.12, CM-MSS.13, CM-MSS.51: 6 A)	
	n/o contact	10 A fast-acting	



# Thermistor motor protection relays

## Technical data - CM-MSS

General data			
MTBF		on request	
Duty time		100 %	
Dimensions (W x H x D)	product dimensions	22.5 x 85.6 x 103.7 mm (0.89 x 3.37 x 4.08 in)	
	packaging dimensions	97 x 109 x 30 mm (3.82 x 4.29 x 1.18 in)	
Weight		see "Ordering details" on page 5	
Mounting		DIN rail (IEC/EN 60715), snap-on mounting without any tool	
Mounting position		any	
Minimum distance to other units	vertical	10 mm (0.394 in) if switching current > 2 A	
	horizontal	10 mm (0.394 in) if switching current > 2 A	
Material of housing		UL 94 V-0	
Degree of protection	housing	IP50	
	terminals	IP20	
Electrical connection			
Connection capacity	fine-strand with(out) wire end ferrule	Screw connection technology	Easy Connect Technology (push-in)
		1 x 0.5-2.5 mm <sup>2</sup> (1 x 18-14 AWG) 2 x 0.5-1.5 mm <sup>2</sup> (2 x 18-16 AWG)	2 x 0.5-1.5 mm <sup>2</sup> (2 x 18-16 AWG)
	rigid	1 x 0.5-4 mm <sup>2</sup> (1 x 20-12 AWG) 2 x 0.5-2.5 mm <sup>2</sup> (2 x 20-14 AWG)	2 x 0.5-1.5 mm <sup>2</sup> (2 x 20-16 AWG)
Stripping length		8 mm (0.32 in)	
Tightening torque		0.6-0.8 Nm (7.08 lb.in)	-
Wire end ferrule		according to DIN 46228-1-A, DIN 46228-4-E	-
Environmental data			
Ambient temperature ranges	operation	-25...+60 °C (-13...+140 °F)	
	storage	-40...+85 °C (-40...+185 °F)	
Damp heat, cyclic (IEC/EN 60068-2-30)		6 x 24 h cycle, 55 °C, 95 % RH	
Climatic class (IEC/EN 60721-3-3)		3K5 (no condensation, no ice formation)	
Vibration, sinusoidal (IEC/EN 60255-21-1)		Class 2	
Shock (IEC/EN 60255-21-2)		Class 2	
Isolation data			
Rated insulation voltage U <sub>i</sub> (IEC/EN 60947-1, IEC/EN 60664-1)	Supply circuit / Measuring circuit (1)	300 V AC (CM-MSS.x2: n/a)	
	Supply circuit / Output circuits	300 V AC	
	Measuring circuit (1) / Output circuits	300 V AC	
	Output circuit 1 / Output circuit 2	300 V AC	
Rated impulse withstand voltage U <sub>imp</sub> (IEC/EN 60947-1, IEC/EN 60664-1)	Supply circuit / Measuring circuit (1)	4 kV / 6 kV (CM-MSS.x2: n/a)	
	Supply circuit / Output circuits	4 kV / 6 kV	
	Measuring circuit (1) / Output circuits	4 kV / 6 kV	
	Output circuit 1 / Output circuit 2	4 kV	
Basic insulation (IEC/EN 60664-1)	Supply circuit / Measuring circuit (1)	600 V AC (CM-MSS.x2: n/a)	
	Supply circuit / Output circuits	600 V AC	
	Measuring circuit (1) / Output circuits	600 V AC	
	Output circuit 1 / Output circuit 2	300 V AC	
Test voltage, routine test (IEC/EN 60255-27)	Supply circuit / Measuring circuit (1)	2.5 kV, 50 Hz, 1 min. (CM-MSS.x2: n/a)	
	Supply circuit / Output circuits	2.5 kV, 50 Hz, 1 min.	
	Measuring circuit (1) / Output circuits	2.5 kV, 50 Hz, 1 min.	
	Output circuit 1 / Output circuit 2	2.5 kV, 50 Hz, 1 min.	
Test voltage, type test (IEC/EN 60255-27)	Supply circuit / Measuring circuit (1)	6 kV / 1.2 - 50 μs (CM-MSS.x2: n/a)	
	Supply circuit / Output circuits	6 kV / 1.2 - 50 μs	
	Measuring circuit (1) / Output circuits	6 kV / 1.2 - 50 μs	
	Output circuit 1 / Output circuit 2	6 kV / 1.2 - 50 μs	
Protective separation (IEC/EN 61140, EN 50178)	Supply circuit / Measuring circuit (1)	yes, up to 300 V	
	Supply circuit / Output circuits	yes (CM-MSS.x2: n/a)	
	Measuring circuit (1) / Output circuits	yes	
	Output circuit 1 / Output circuit 2	no	
Pollution degree (IEC/EN 60664-1)		3	
Overvoltage category (IEC/EN 60664-1)		III	

(1) Potential of measuring circuit = Potential of control circuit

## Thermistor motor protection relays

### Technical data - CM-MSS

#### Standards

Product standard	EN 60947-5-1, EN 60947-8
Low Voltage Directive	2014/35/EC
EMC directive	2014/30/EC
ATEX directive	2014/34/EC (only ATEX variants "Selection table CM-MSx range" on page 4)
RoHS directive	2011/65/EC

#### Electromagnetic compatibility

Interference immunity to		IEC/EN 61000-6-1, IEC/EN 61000-6-2
electrostatic discharge	IEC/EN 61000-4-2	Level 3, 6 kV contact discharge, 8 kV air discharge
radiated, radio-frequency, electromagnetic field	IEC/EN 61000-4-3	Level 3, 10 V/m (1 GHz), 3 V/m (2 GHz), 1 V/m (2.7 GHz)
electrical fast transient / burst	IEC/EN 61000-4-4	Level 3, 2 kV / 5 kHz
surge	IEC/EN 61000-4-5	Level 3, Installation class 3, supply circuit and measuring circuit 1 kV L-L, 2 kV L-N
conducted disturbances, induced by radio-frequency fields	IEC/EN 61000-4-6	Level 3, 0.15-80 MHz, 10 V, 80 % AM (1kHz)
voltage dips, short interruptions and voltage variations	IEC/EN 61000-4-11	Class 3
harmonics and interharmonics	IEC/EN 61000-4-13	Class 3
Additional interference immunity according to product standard EN 60255-1 (reference on EN 60255-26_2011)		
radiated, radio-frequency, electromagnetic field	IEC/EN 61000-4-3	10 V/m (80 MHz - 3 GHz)
conducted disturbances, induced by radio-frequency fields	IEC/EN 61000-4-6	10 V at stated frequencies
damped oscillatory waves	IEC/EN 61000-4-18	Signal lines, symmetric coupling: 1 kV peak voltage Power supply, asymmetric coupling: 2.5 kV peak voltage
Interference emissions		IEC/EN 61000-6-3, IEC/EN 61000-6-4
high-frequency radiated	IEC/CISPR 22, EN 55022	Class B
high-frequency conducted	IEC/CISPR 22, EN 55022	Class B
high-frequency radiated	Germanischer Lloyd	increased requirements in the emergency call frequency band

# Thermistor motor protection relays

## Technical data - CM-MSE

Data at  $T_a = 25\text{ °C}$  and rated values, unless otherwise indicated

Supply circuit - Input circuit		CM-MSE
Rated control supply voltage $U_c$ , power consumption	1SVR550805R9300	24 V AC approx. 1.5 A
	1SVR550800R9300	110-130 V AC approx. 1.5 A
	1SVR550801R9300	220-240 V AC approx. 1.5 A
Rated control supply voltage $U_c$ tolerance		-15...+10 %
Rated frequency		50-60 Hz
Measuring circuit		
Monitoring function	T1-T2	temperature monitoring by means of PTC sensors
Number of sensor circuits		1
Sensor circuit		
Temperature threshold (relay de-energizes)		2.7-3.7 k $\Omega$
Temperature hysteresis (relay energizes)		1.7-2.3 k $\Omega$
Short-circuit threshold (relay de-energizes)		<18 $\Omega$
Short-circuit hysteresis (relay energizes)		>45 $\Omega$
Maximum total resistance of sensors connected in series (cold state)		≤1.5 k $\Omega$
Maximum sensor cable length for short-circuit detection		2 x 100 m at 0.75 mm <sup>2</sup> , 2 x 400 m at 2.5 mm <sup>2</sup>
Response time		<100 ms
Output circuit		
Kind of output	13-14	1 n/o contact
Operational principle		closed-circuit principle (output relay de-energizes if the measured value exceeds/drops below the adjusted threshold)
Contact material		AgCdO
Rated voltage	VDE 0110, IEC 664-1, IEC 60947-1	250 V
Maximum switching voltage		250 V
Rated operating current $I_n$ (IEC/EN 60947-5-1)	AC-12 (resistive) at 230 V	4 A
	AC-15 (inductive) at 230 V	3 A
	DC-12 (resistive) at 24 V	4 A
	DC-13 (inductive) at 24 V	2 A
AC Rating (UL 508)	utilization category (Control Circuit Rating Code)	B 300
	maximum rated operational voltage	300 V AC
	maximum continuous thermal current at B 300	5 A
	maximum making/breaking apparent power at B 300 general purpose rating	3600/360 VA 250 V AC - 4 A
Mechanical lifetime		30 x 10 <sup>6</sup> switching cycles
Electrical lifetime	at AC12, 230 V AC, 4 A	0.1 x 10 <sup>6</sup> switching cycles
Maximum fuse rating to achieve short-circuit protection	n/c contact	10 A fast-acting
	n/o contact	10 A fast-acting
General data		
Dimensions (W x H x D)		22.5 x 78 x 78.5 mm (0.89 x 3.07 x 3.09 in)
Duty time		100 %
Weight		approx. 0.11 kg (0.24 lb)
Mounting position		any
Degree of protection	housing / terminals	IP50 / IP20
Ambient temperature range	operation	-20...+60 °C
	storage	-40...+85 °C
Mounting		DIN rail (IEC/EN 60715)
Electrical connection		
Wire size	fine strand with wire end ferrule	2 x 1.5 mm <sup>2</sup> (2 x 16 AWG)
	fine strand without wire end ferrule	2 x 0.75-1.5 mm <sup>2</sup> (2 x 18-16 AWG)
	rigid	2 x 1-1.5 mm <sup>2</sup> (2 x 18-16 AWG)
Stripping length		2 x 0.75-1.5 mm <sup>2</sup> (2 x 18-16 AWG)
Tightening torque		0.6-0.8 Nm (5.31-7.08 lb.in)
Standards		
Product standard		IEC 255-6, EN 60255-6
Low Voltage Directive		2006/95/EC
EMC Directive		2004/108/EC, 91/263/EEC, 92/31/EEC, 93/68/EEC, 93/67/EEC
Electromagnetic compatibility		
electrostatic discharge	IEC/EN 61000-4-2	Level 3 (6 kV / 8 kV)
radiated, radio-frequency, electromagnetic field	IEC/EN 61000-4-3	Level 3 (10 V/m)
electrical fast transient /burst	IEC/EN 61000-4-4	Level 3 (2 kV / 5 kHz)
surge	IEC/EN 61000-4-5	Level 3/4 (1/2 kV)
conducted disturbances, induced by radio-frequency fields	IEC/EN 61000-4-6	Level 3 (10 V)
Operational reliability (IEC 68-2-6)		6 g
Resistance to vibration (IEC 68-2-6)		10 g
Environmental testing (IEC 68-2-30)		24 h cycle time, 55 °C, 93 % rel., 96 h
Electromagnetic compatibility		
Rated voltage between supply, measuring and output circuit		250 V
Rated impulse withstand voltage between all isolated circuits		4 kV / 1.2 - 50 $\mu$ s
Test voltage between all isolated circuits		2.5 kV, 50 Hz, 1 min.
Pollution degree		3
Overvoltage category		III

—  
**Notes**

A large rectangular area filled with a grid of small, light gray dotted lines, intended for handwritten notes.

# Thermistor motor protection relays

## Connection diagrams

CM-MSS.11, CM-MSS.21

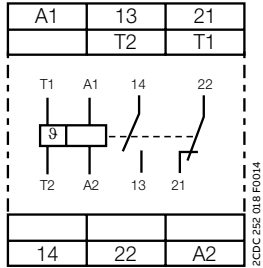

A1 – A2 Control supply voltage  
 13 – 14 n/o contact  
 21 – 22 n/c contact  
 T1 – T2 Measuring circuit

CM-MSS.12

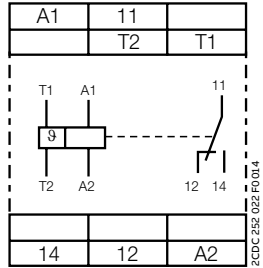

A1 – A2 Control supply voltage  
 11 – 12/14 c/o contact  
 T1 – T2 Measuring circuit

CM-MSS.13

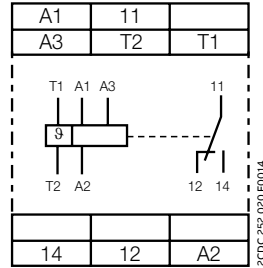

A1 – A2 Control supply voltage 220-240 V AC  
 A2 – A3 Control supply voltage 110-130 V AC  
 11 – 12/14 c/o contact  
 T1 – T2 Measuring circuit

CM-MSS.31

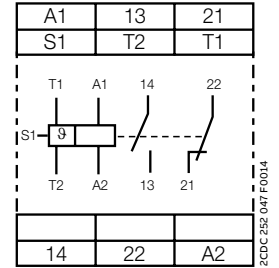

A1 – A2 Control supply voltage  
 13 – 14 n/o contact  
 21 – 22 n/c contact  
 S1 – T2 Automatic reset (jumpered)  
 T1 – T2 Measuring circuit

CM-MSS.22, CM-MSS.32, CM-MSS.41

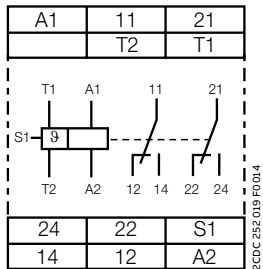

A1 – A2 Control supply voltage 24 V AC/DC  
 11 – 12/14 1st c/o (SPDT) contact  
 21 – 22/24 2nd c/o (SPDT) contact  
 S1 – T2 Automatic reset (jumpered)  
 T1 – T2 Measuring circuit

CM-MSS.23, CM-MSS.33

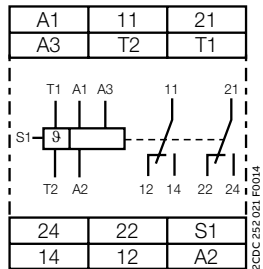

A1 – A2 Control supply voltage 220-240 V AC  
 A2 – A3 Control supply voltage 110-130 V AC  
 11 – 12/14 1st c/o (SPDT) contact  
 21 – 22/24 2nd c/o (SPDT) contact  
 S1 – T2 Automatic reset (jumpered)  
 T1 – T2 Measuring circuit

CM-MSS.51

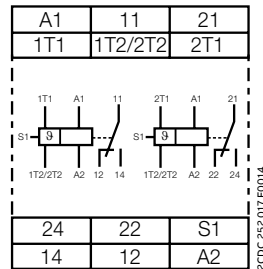

A1 – A2 Control supply voltage 220-240 V AC  
 11 – 12/14 1st c/o (SPDT) contact  
 21 – 22/24 2nd c/o (SPDT) contact  
 S1 – 1T2/2T2 Automatic reset (jumpered)  
 1T1 – 1T2/2T2 Measuring circuit 1  
 2T1 – 1T2/2T2 Measuring circuit 2

CM-MSE

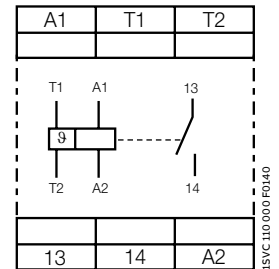

A1 – A2 Control supply voltage 24 V AC  
 T1-T2 Sensor circuit  
 13-14 Output contact - Closed circuit principle

07

# Thermistor motor protection relays

## Circuit diagram

CM-MSS.11, CM-MSS.21

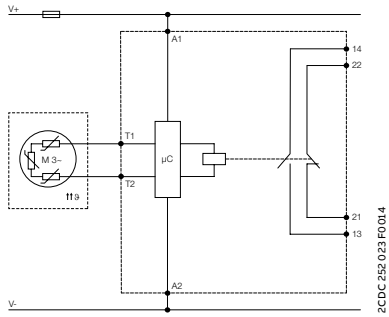

CM-MSS.12

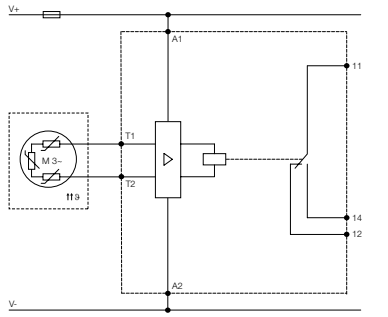

CM-MSS.13

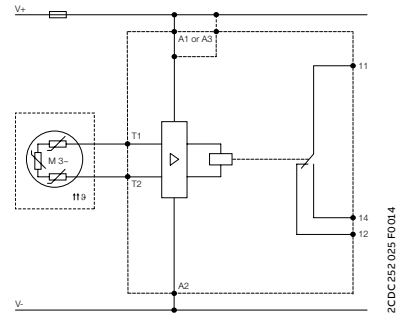

CM-MSS.22

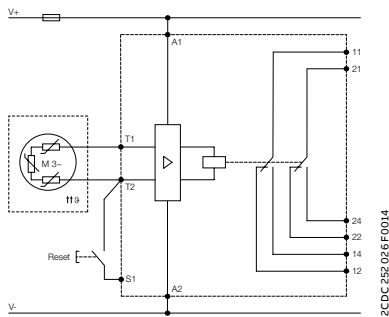

CM-MSS.23

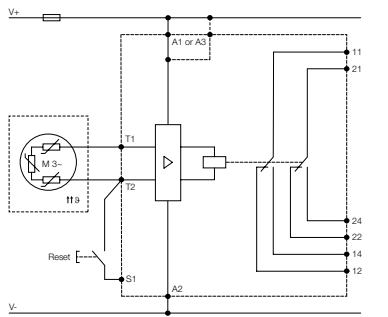

CM-MSS.31

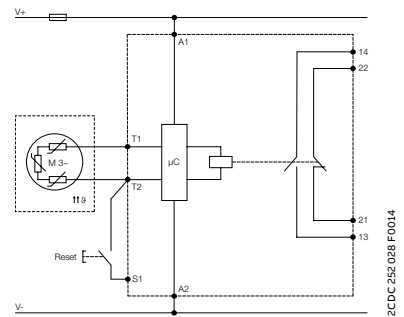

CM-MSS.32, CM-MSS.41

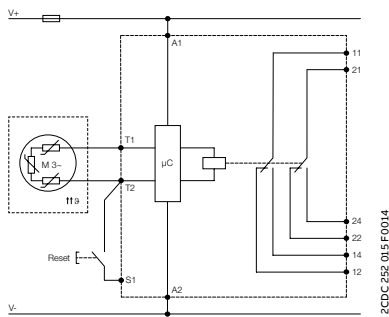

CM-MSS.33

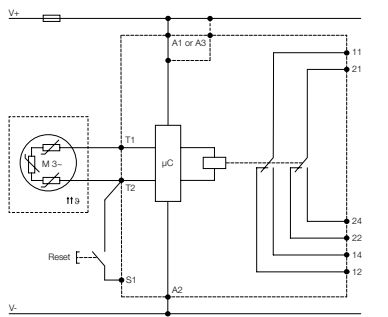

CM-MSS.51

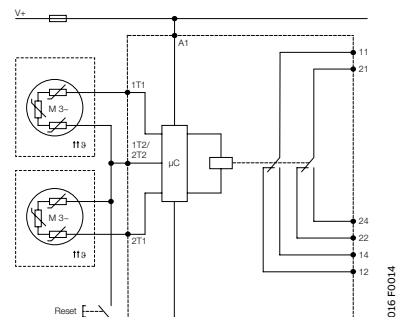

CM-MSE

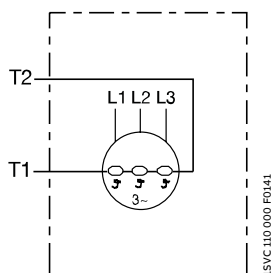



—

**For direct product details information, use product type or order code, ex:**

[www.abb.com/productdetails/S801S-SCL32-SR](http://www.abb.com/productdetails/S801S-SCL32-SR)

or

[www.abb.com/productdetails/2CCS801901R0539](http://www.abb.com/productdetails/2CCS801901R0539)

---

# Self resetting current limiting module

<b>8/2</b>	<b>S800-SCL-SR</b> Ordering details
<b>8/3</b>	Technical data



# S800-SCL-SR

## Self-resetting current limiting module

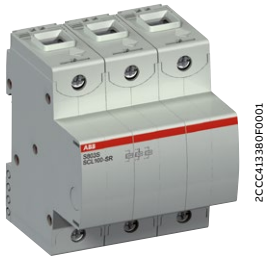

S800S-SCL-SR

2CCS41380P0001



S803W-SCL-SR

2CCS41383B0001

S800-SCL-SR is ABB's innovative self-resetting current limiting module which considerably increases the short-circuit breaking capacity of downstream manual motor starters and high performance MCBs. S800-SCL-SR is a self resetting current limiting module based on the S800 technology.

It limits the short-circuit current until the downstream means of protection trips. Its current continuity makes it as the ideal solution for group protection: All parallel branches remain operative. This leads to an Expanded application range of the low voltage switchgear whose short-circuit capabilities are usually limited. S800-SCL-SR can be combined with S800S high performance MCB or with manual motor starters. S800-SCL-SR can also back up a single circuit breaker or a group of circuit breakers or motor starters (group protection). Terminals and outside dimensions are identical to the S800 range.

Self-resetting short-circuit limiter IEC version	Type designation	Product number	EAN number	Weight	Pack.
A			7612271	kg	unit

### 1-pole

32	S801S-SCL32-SR	2CCS801901R0539	412012	0.25	1
63	S801S-SCL63-SR	2CCS801901R0599	412036	0.25	1
100	S801S-SCL100-SR	2CCS801901R0639	411992	0.25	1

### 2-pole

32	S802S-SCL32-SR	2CCS802901R0539	412074	0.5	1
63	S802S-SCL63-SR	2CCS802901R0599	412098	0.5	1
100	S802S-SCL100-SR	2CCS802901R0639	412050	0.5	1

### 3-pole

32	S803S-SCL32-SR	2CCS803901R0539	411930	0.75	1
63	S803S-SCL63-SR	2CCS803901R0599	411947	0.75	1
100	S803S-SCL100-SR	2CCS803901R0639	411954	0.75	1

Self-resetting short-circuit limiter IEC/UL version	Type designation	Product number	EAN number	Weight	Pack.
A			7612271	kg	unit

### 3-pole

32	S803W-SCL32-SR	2CCS803917R0539	412319	0.75	1
63	S803W-SCL63-SR	2CCS803917R0599	412326	0.75	1
100	S803W-SCL100-SR	2CCS803917R0639	412302	0.75	1

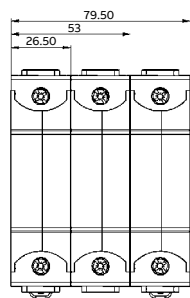

S800S-SCL-SR/S803S-SCL

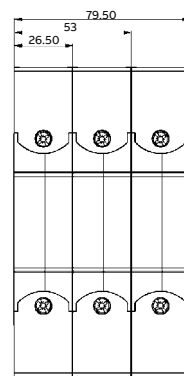
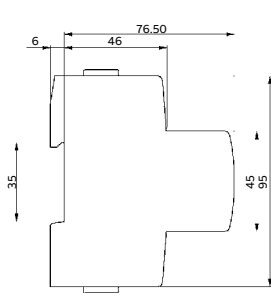

S803W-SCL-SR

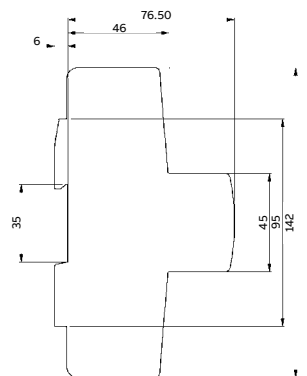

Main dimensions mm, inches

2CCS41302B0201

# S800S-SCL-SR/S803W-SCL-SR

## Technical data

		S800S-SCL-SR	S803W-SCL-SR
Rated operational current Ie	[A]	32, 63, 100	32, 63, 100
Pole		1, 2, 3	3
Rated operational voltage Ue	50/60Hz [V]	400/690	690
(AC) according to IEC 60947-2			
(AC) according to UL 508	50/60Hz [V]		600
Rated insulation voltage Ui	[V]	690	690
Rated impulse withstand voltage Uimp	[kV]	8	8
Rated ultimate short-circuit breaking capacity			

### Icu = Ics according to IEC 60947-2\*

(AC) 50/60Hz 240/415V	[kA]	100	100
(AC) 50/60Hz 254/440V	[kA]	100	100
(AC) 50/60Hz 277/480V	[kA]	65	65
(AC) 50/60Hz 289/500V	[kA]	65	65
(AC) 50/60Hz 346/600V	[kA]	65	65
(AC) 50/60Hz 400/690V	[kA]	50	50

### Short-circuit rating according to UL 508, CSA 22.2\*

(AC) 50/60Hz 480V	[kA]	65	65
(AC) 50/60Hz 600V	[kA]	65	65

\* Valid only for approved combinations

Rated frequency	[Hz]	50/60	50/60
Mounting position		any	any
Connections Cu			
	[mm <sup>2</sup> ]	1 ... 50 rigid (solid/stranded)	1 ... 50 rigid (solid/stranded)
	[mm <sup>2</sup> ]	1 ... 70 flexible	1 ... 70 flexible
			14-1 AWG
Tightening torque			
	[Nm]	min. 3 / max. 4	min. 3 / max. 4
	[in. lbs.]		min. 26.5 / max. 25
Feeding		optional	optional
Mouting on DIN top hat rail		EN 60715	EN 60715
Ambient air temperature	[°C]	-40 ... +70	-40 ... +70
Storage temperature	[°C]	-40 ... +85	-40 ... +85
Degree of protection		IP20	IP20
Classification acc. to NF F 16-101, NF F 16-102		I3, F2	I3, F2
Damp Heat		IEC 60068-2-30, 55°C / 95% r.h.	IEC 60068-2-30, 55°C / 95% r.h.
Vibration		IEC 60068-2-6, 5-10Hz / 3 mm and 10-500Hz / 2g at 0.5 x Ie	IEC 60068-2-6, 5-10Hz / 3 mm and 10-500Hz / 2g at 0.5 x Ie
Random Vibration		IEC 60068-2-64, 5-500Hz / 2g at 0.5 x Ie	IEC 60068-2-64, 5-500Hz / 2g at 0.5 x Ie
Resistance to climatic conditions		IEC 60068-2-1 /-2-2 /-2-30	IEC 60068-2-1 /-2-2 /-2-30
Standard		IEC 60947-2 IEC 60947-4-1	IEC 60947-2 IEC 60947-4-1 UL 508, CSA 22.2 No. 14

### Internal resistance at 25°C ambient temperature and nominal power losses

Rated current In	Internal resistance Ri	Power losses Pvn
A	mΩ/pole	W/pole
32	2.8	3.6
63	1.3	5.7
100	0.7	7.8

### Influence of ambient temperature – single mounted devices

Rated current In	10°C	15°C	20°C	25°C	30°C	35°C	40°C	45°C	50°C	55°C	60°C	65°C	70°C
A													
32	38.2	37.2	35.8	35.2	34.2	33.3	32	30.7	29.8	28.8	27.8	26.5	25.1
63	75.3	73.2	70.6	69.3	67.4	65.5	63	60.5	58.6	56.7	54.8	52.3	49.8
100	119.5	116.2	112	110	107	104	100	96	93	90	87	84	80

08

2CCC413012B0201

# S800-SCL-SR

## Technical data

### Short circuit breaking capacity

	S800S-SCL-SR	S803W-SCL-SR
Rated ultimate short-circuit breaking capacity		

### I<sub>cu</sub> = I<sub>cs</sub> according to IEC 60947-2

(AC) 50/60Hz 240/415V	[kA]	100	100
(AC) 50/60Hz 254/440V	[kA]	100	100
(AC) 50/60Hz 277/480V	[kA]	65	65
(AC) 50/60Hz 289/500V	[kA]	65	65
(AC) 50/60Hz 346/600V	[kA]	65	65
(AC) 50/60Hz 400/690V	[kA]	50	50

### Short-circuit rating according to UL 508, CSA 22.2

(AC) 50/60Hz 480V	[kA]	65
(AC) 50/60Hz 600V	[kA]	65

### Coordination

Type	230 V AC						400 V AC						440 V AC					
			Fuse		Current Limiter				Fuse		Current Limiter				Fuse		Current Limiter	
	I <sub>cs</sub> kA	I <sub>cu</sub> kA	gG, kA	aM A	S803x-SCL-SR kA A		I <sub>cs</sub> kA	I <sub>cu</sub> kA	gG, kA	aM A	S803x-SCL-SR kA A		I <sub>cs</sub> kA	I <sub>cu</sub> kA	gG, kA	aM A	S803x-SCL-SR kA A	
MS132-0.16																		
MS132-0.25																		
MS132-0.4																		
MS132-0.63																		
MS132-1.0	No back-up required						No back-up required						No back-up required					
MS132-1.6																		
MS132-2.5																		
MS132-4.0													20	20	100	63	100	32,63,100
MS132-6.3													20	20	100	100	100	32,63,100
MS132-10													20	20	100	100	100	32,63,100
MS132-12													20	20	100	125	100	32,63,100
MS132-16													20	20	100	125	100	32,63,100
MS132-20													20	20	100	125	100	32,63,100
MS132-25	50	50	100	125	100	63,100	50	50	100	125	100	63,100	20	20	100	125	100	63,100
MS132-32	25	50	100	125	100	63,100	25	50	100	125	100	63,100	20	20	100	125	100	63,100

Type	500 V AC						600 V AC					
			Fuse		Current Limiter				Fuse		Current Limiter	
	I <sub>cs</sub> kA	I <sub>cu</sub> kA	gG, kA	aM A	S803x-SCL-SR kA A		I <sub>cs</sub> kA	I <sub>cu</sub> kA	gG, kA	aM A	S803x-SCL-SR kA A	
MS132-0.16												
MS132-0.25												
MS132-0.4												
MS132-0.63												
MS132-1.0	No back-up required						No back-up required					
MS132-1.6												
MS132-2.5	20	20	100	35	65*	32, 63,100	3	3	80	35	50**	32, 63,100
MS132-4.0	20	20	100	63	65*	32, 63,100	3	3	80	63	50**	32, 63,100
MS132-6.3	20	20	100	100	65*	32, 63,100	3	3	80	100	50**	32, 63,100
MS132-10	20	20	100	100	65*	32, 63,100	3	3	80	100	50**	32, 63,100
MS132-12	20	20	100	125	65*	32, 63,100	3	3	80	125	50**	32, 63,100
MS132-16	20	20	100	125	65*	32, 63,100	3	3	80	125	50**	32, 63,100
MS132-20	20	20	100	125	65*	32, 63,100	3	3	80	125	50**	32, 63,100
MS132-25	10	10	100	125	65*	63,100	3	3	80	125	50**	63,100
MS132-32	10	10	100	125	65*	63,100	3	3	80	125	50**	63,100

\* 100 kA when two current limiters are used in series.  
 \*\* 80 kA when two current limiters are used in series.

# S800-SCL-SR and S803S-SCL

## Technical data

### Installation requirements

The total sum of the rated currents of all downstream motor starters or circuit breakers shall not exceed the rated current of the S800-SCL-SR. Furthermore the sum of all load currents including inrush currents shall not exceed the maximum permissible load of the S800-SCL-SR.

### Maximum load

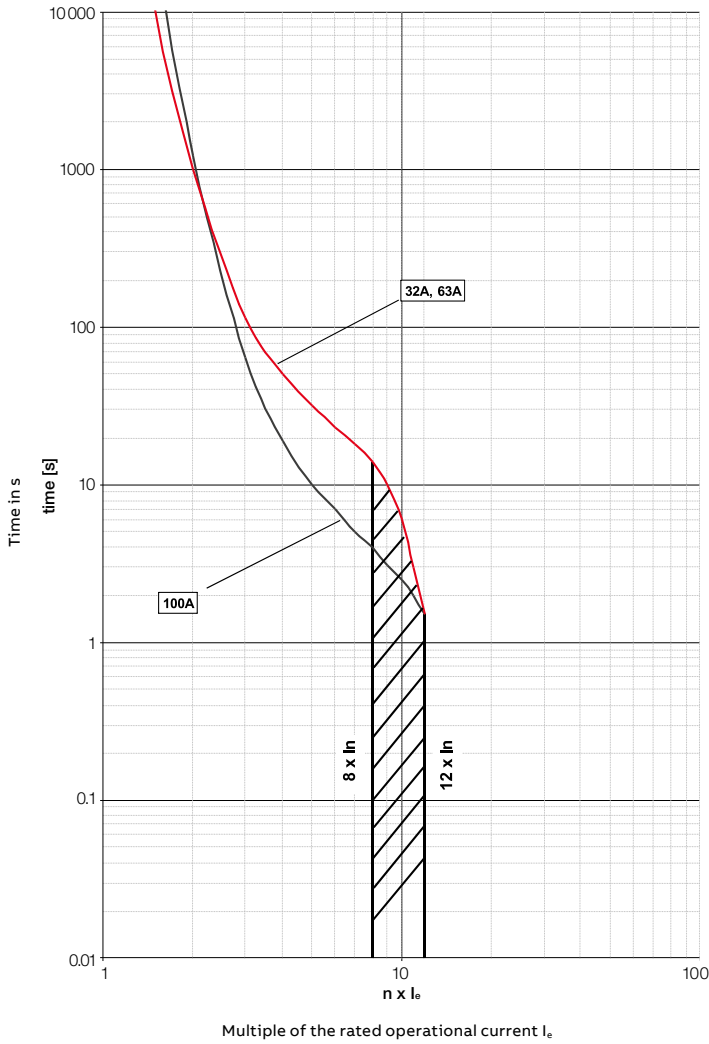



**For direct product details information, use product type or order code, ex:**

[www.abb.com/productdetails/DRAS09-20S](http://www.abb.com/productdetails/DRAS09-20S)  
or  
[www.abb.com/productdetails/1SBK104235R2000](http://www.abb.com/productdetails/1SBK104235R2000)

---

# DRAS and DRAF enclosed starters

## **DRAS enclosed starter**

- 9/2** Ordering details
- 9/3** Control supply wiring versions
- 9/3** Wiring diagram
- 9/3** Main dimensions
- 9/4** Voltage code table

## **DRAF enclosed starter**

- 9/6** Experience reliable and easy to install motor starting
- 9/8** Ordering details
- 9/10** Control supply wiring versions
- 9/10** Wiring diagram
- 9/10** Main dimensions

# DRAS09 ... DRAS16 enclosed direct-on-line starters

4 to 7.5 kW, protected by thermal overload relays  
AC or DC operated



DRAS  
+ T16 to be ordered separately

Enclosed direct-on-line (DOL) starters are used for controlling 3-phase asynchronous motors up to 690 V AC.

Each starter is delivered assembled and wired. It contains:

- IP65 compact plastic enclosure with double insulation, equipped with:
  - 1 green flush "I" ON button and 1 red protruding "O" OFF/RESET button
  - 2 quarter-turn, quick fastening screws and a base with 6 cable inlets and outlets via knockouts.
- 1 AS or ASL 3-pole contactor with holding contact
- 1 PE and 1 neutral terminal.

3 versions of control supply wiring are available: phase-to-phase, separate supply or phase-to-neutral.

T16 thermal overload relay has to be ordered separately and chosen according to motor's nominal current (see table below).

### DRAS, DRASL enclosed DOL starters

IEC - AC-3				Rated control circuit voltage Uc Other control voltages see AS voltage code table V 50/60 Hz V DC	Control supply wiring	Type	Order code	Weight Pkg (1 pce) kg
Rated operational power	220 V	400 V	500 V					
max. current θ ≤ 40 °C Ue=400 V								
220 V	400 V	500 V						
230 V								
240 V								
kW	kW	kW	A					

### AC operated with AS 3-pole contactors

2.2	4	4	9	24	-	Separate supply	DRAS09-20S	1SBK104235R2000	0.650
				230	-	Phase-to-neutral	DRAS09-26N	1SBK104135R2600	0.650
				240	-	Phase-to-neutral	DRAS09-27N	1SBK104135R2700	0.650
				400	-	Phase-to-phase	DRAS09-28P	1SBK104035R2800	0.650
				415	-	Phase-to-phase	DRAS09-29P	1SBK104035R2900	0.650
3	5.5	5.5	12	24	-	Separate supply	DRAS12-20S	1SBK114235R2000	0.650
				230	-	Phase-to-neutral	DRAS12-26N	1SBK114135R2600	0.650
				240	-	Phase-to-neutral	DRAS12-27N	1SBK114135R2700	0.650
				400	-	Phase-to-phase	DRAS12-28P	1SBK114035R2800	0.650
				415	-	Phase-to-phase	DRAS12-29P	1SBK114035R2900	0.650
4	7.5	7.5	15.5	24	-	Separate supply	DRAS16-20S	1SBK124235R2000	0.650
				230	-	Phase-to-neutral	DRAS16-26N	1SBK124135R2600	0.650
				240	-	Phase-to-neutral	DRAS16-27N	1SBK124135R2700	0.650
				400	-	Phase-to-phase	DRAS16-28P	1SBK124035R2800	0.650
				415	-	Phase-to-phase	DRAS16-29P	1SBK124035R2900	0.650

### DC operated with ASL 3-pole contactors

2.2	4	4	9	-	24	Separate supply	DRASL09-81S	1SBK104335R8100	0.700
				-	48		DRASL09-83S	1SBK104335R8300	0.700
3	5.5	5.5	12	-	24	Separate supply	DRASL12-81S	1SBK114335R8100	0.700
				-	48		DRASL12-83S	1SBK114335R8300	0.700
4	7.5	7.5	15.5	-	24	Separate supply	DRASL16-81S	1SBK124335R8100	0.700
				-	48		DRASL16-83S	1SBK124335R8300	0.700

### T16 thermal overload relays to be ordered separately

Setting range	Short-circuit protective device	Trip class	Type	Order code	Weight (1 pce) kg
A					
0.10...0.13	0.5 A, Fuse type T	10	T16-0.13	1SAZ711201R1005	0.100
0.13...0.17	1.0 A, Fuse type T		T16-0.17	1SAZ711201R1008	0.100
0.17...0.23			T16-0.23	1SAZ711201R1009	0.100
0.23...0.31			T16-0.31	1SAZ711201R1013	0.100
0.31...0.41	2.0 A, Fuse type gG		T16-0.41	1SAZ711201R1014	0.100
0.41...0.55			T16-0.55	1SAZ711201R1017	0.100
0.55...0.74	4.0 A, Fuse type gG		T16-0.74	1SAZ711201R1021	0.100
0.74...1.00	6.0 A, Fuse type gG		T16-1.0	1SAZ711201R1023	0.100
1.00...1.30			T16-1.3	1SAZ711201R1025	0.100
1.30...1.70	10.0 A, Fuse type gG		T16-1.7	1SAZ711201R1028	0.100
1.70...2.30			T16-2.3	1SAZ711201R1031	0.100
2.30...3.10			T16-3.1	1SAZ711201R1033	0.100
3.10...4.20	20.0 A, Fuse type gG	T16-4.2	1SAZ711201R1035	0.100	
4.20...5.70		T16-5.7	1SAZ711201R1038	0.100	
5.70...7.60	35.0 A, Fuse type gG	T16-7.6	1SAZ711201R1040	0.100	
7.60...10.0		T16-10	1SAZ711201R1043	0.104	
10.0...13.0	40.0 A, Fuse type gG	T16-13	1SAZ711201R1045	0.104	
13.0...16.0		T16-16	1SAZ711201R1047	0.104	

### Empty enclosure with push-button

-	-	-	FR16AS-12VARS	1SBN101035R1000	0.394
---	---	---	---------------	-----------------	-------

To be completed with AS or ASL contactor, T16 thermal overload relay and MCB-10B (1SFA611610R2001) contact block.



T16



Empty enclosure with push-button

# DRAS09 ... DRAS16 and DRASL09 ... DRASL16 enclosed direct-on-line starters

## Control supply wiring versions

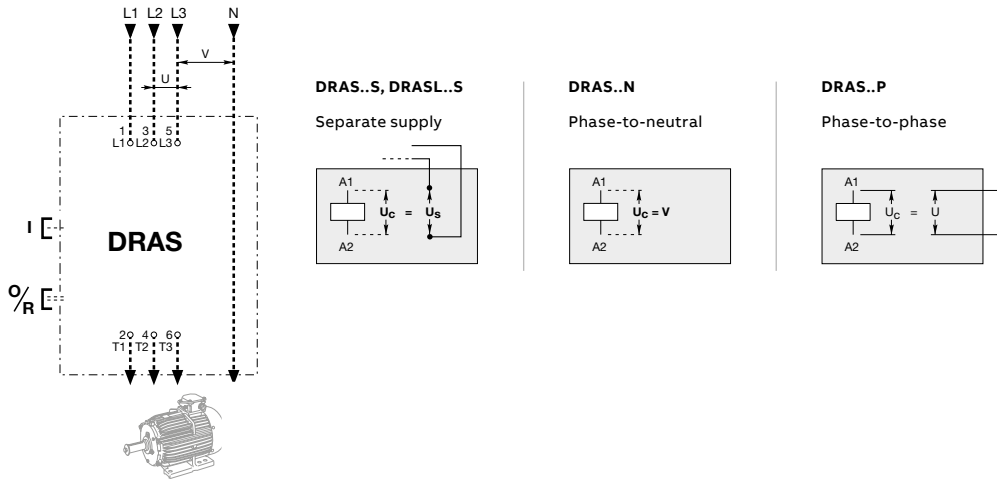

## Wiring diagram

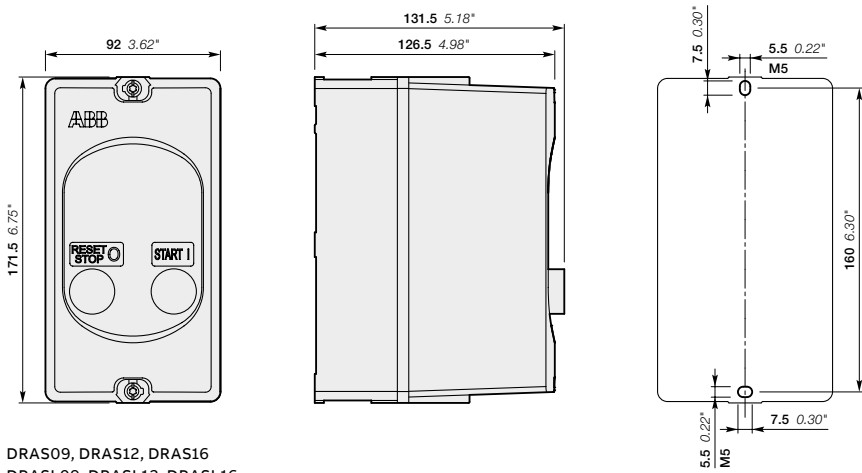
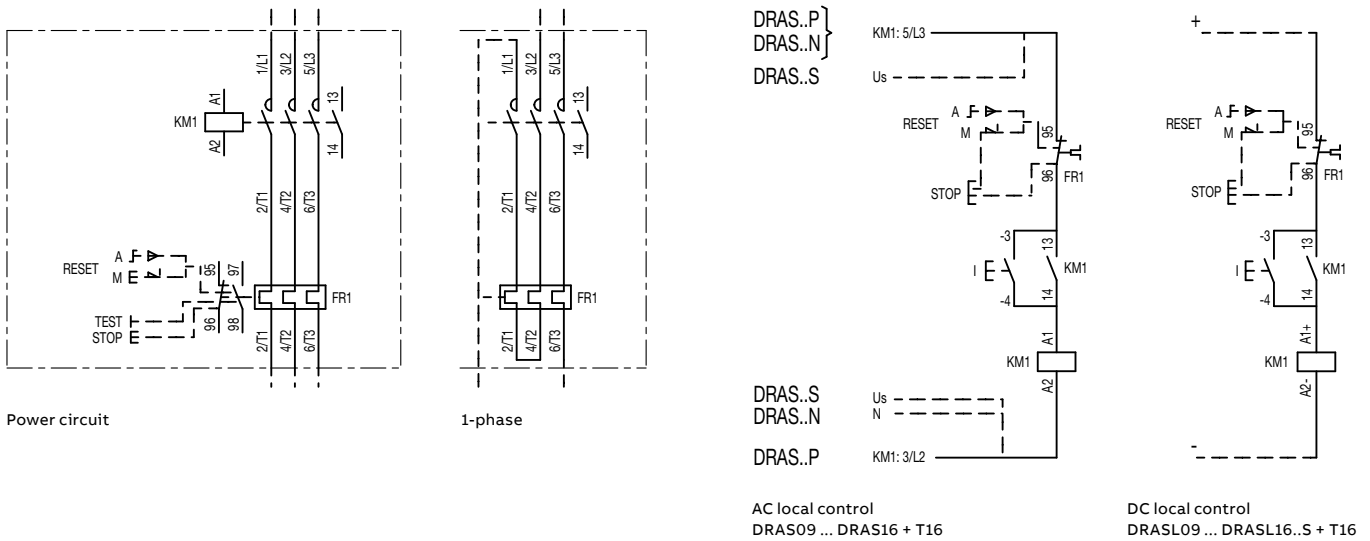

DRAS09, DRAS12, DRAS16  
DRASL09, DRASL12, DRASL16

Main dimensions mm, inches

Cable inlets		Cable outlet
Enclosure top	Enclosure back	Enclosure bottom
2 x $\varnothing$ 20.5/25.5 mm	2 x $\varnothing$ 20.5 mm	2 x $\varnothing$ 20.5/25.5 mm
2 x $\varnothing$ 0.81/1.00"	2 x $\varnothing$ 0.81"	2 x $\varnothing$ 0.81/1.00"

$\varnothing$  20.5mm -  $\varnothing$  0.81" for ISO M20  
 $\varnothing$  25.5mm -  $\varnothing$  1.00" for ISO M25



## Voltage code table

DRAS09 ... DRAS16 and  
DRASL09 ... DRASL16 enclosed DOL starters

Type

DR **AS16** - **26N**

ASL  
ASL  
ASL

**Contactor type**  
AC operated  
DC operated

**AS contactors**  
**AC coil code**

	50 Hz	60 Hz
20 S	24 V	24 V
21 S	42 V	42 V
22 S	48 V	48 V

16 N	-	120 V
23 N	110 V	110 V
24 N	115 V	115 V
25 N	220 V	220 V
<b>26 N</b>	<b>230 V</b>	<b>230 V</b>
27 N	240 V	240 V

13 P	380 V	380 V
17 P	-	277 V
28 P	400 V	400 V
29 P	415 V	415 V

**ASL contactors**  
**DC coil code**

81 S	24 V
83 S	48 V

**Control supply wiring**

S Separate supply

N Phase-to-neutral

P Phase-to-phase

—  
**Notes**

A large rectangular area filled with a grid of small, light gray dotted lines, intended for handwritten notes.

## DRAF enclosed direct-on-line starters

Experience reliable and easy to install motor starting



### Improve installation efficiency

- Easy to connect and to operate
- Pre-wired control circuit and easy to follow wiring instructions
- Coil energy consumption down by 80%.



### Reliable in harsh condition

- High number of electrical and mechanical operations
- Robust IP66 and type 4X enclosure
- Double electrical insulation.



### Continuous operation

- AF contactors manage voltage fluctuation, chattering free
- Protected motor with thermal overload relay
- Safety through coordinated product.



## For machine or wall mounting

### Main applications

Control of stand alone motors like for heat pumps, air conditioning units, small machine tools, compressors, pumping, irrigation...



# Motor starting solutions up to 7.5 kW and 10 hp

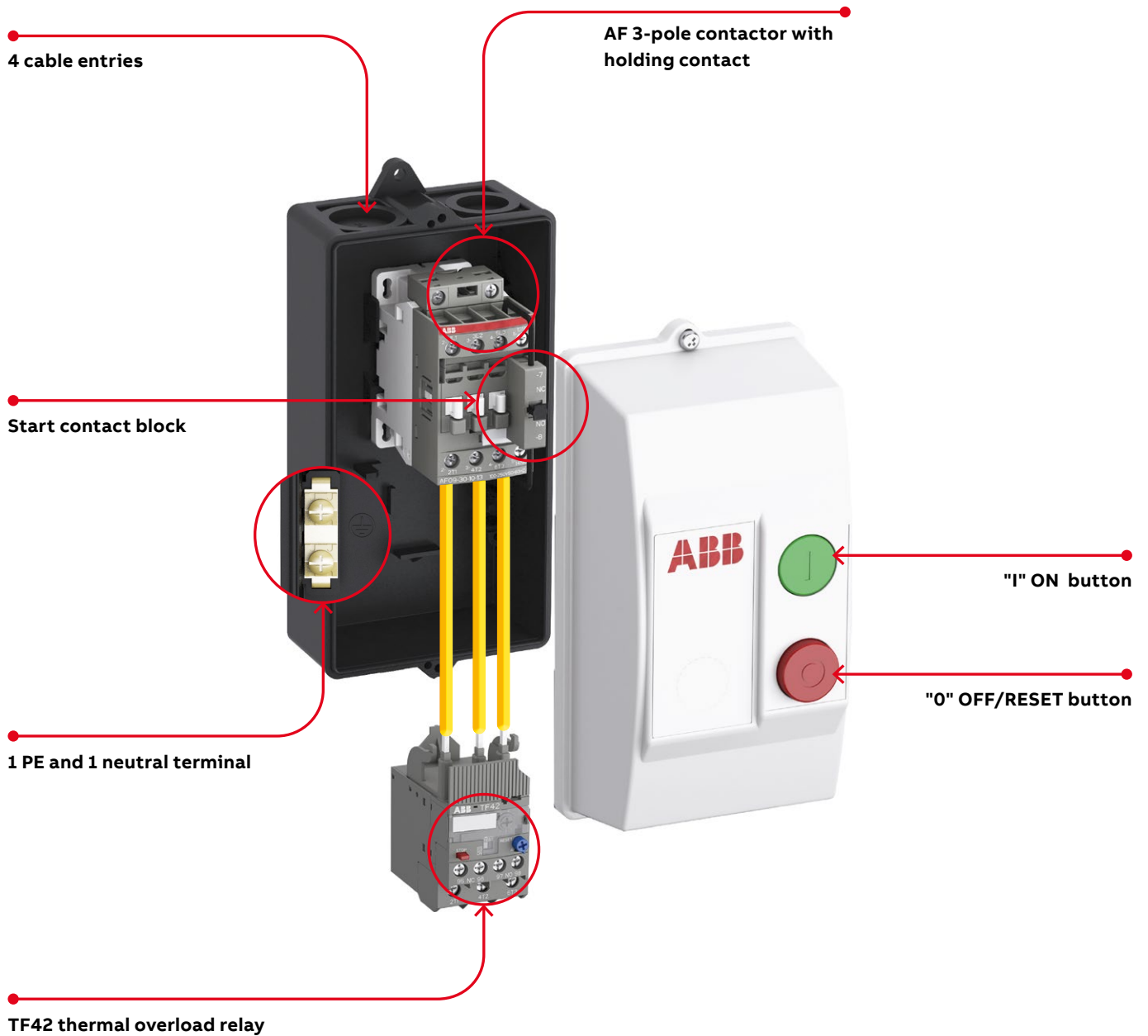

# DRAF09 ... DRAF16 enclosed direct-on-line starters

Up to 7.5 kW and 10 hp, protected by thermal overload relays  
AC operated



1SBK133005W0014

DRAF  
+ TF42 to be ordered separately

Enclosed direct-on-line (DOL) starters are used for controlling 3-phase asynchronous motors up to 690 V AC.

Each starter is delivered assembled and wired. It contains:

- IP66 and type 4X plastic enclosure with double insulation, equipped with:
  - 1 green flush "I" ON button and 1 red protruding "O" OFF/RESET button
  - 4 cable inlets and outlets via knockouts.
- 1 AF 3-pole contactor with holding contact
- 1 CB5-10 start contact block
- 1 PE and 1 neutral terminal.

**Control supply wiring:**

IEC starters type: phase-to-phase, separate supply or phase-to-neutral.  
UL starters type: separate supply.

TF42 thermal overload relay to be ordered separately and chosen according to motor's nominal current (see table in the next page).

**DRAF enclosed DOL starters**

IEC - AC-3					Control supply wiring	Rated control circuit voltage Uc min ... Uc max (1)	Type	Order code	Weight  Pkg (1 pce)  kg
Rated operational power		max. current θ ≤ 40 °C Ue=400 V							
220 V	380 V		500 V	690 V					
230 V	400 V								
240 V									
kW	kW	kW	kW	A					
					V 50/60 Hz				

**IEC starters type**

2.2	4	5.5	5.5	9	Control supply wiring	Rated control circuit voltage	Type	Order code	Weight
					Separate supply	24...60	DRAF09-11S	1SBK134237R1100	0.820
					Phase-to-neutral	100...250	DRAF09-13N	1SBK134137R1300	0.820
					Phase-to-phase	250...500	DRAF09-14P	1SBK134037R1400	0.820
3	5.5	7.5	7.5	12	Separate supply	24...60	DRAF12-11S	1SBK154237R1100	0.820
					Phase-to-neutral	100...250	DRAF12-13N	1SBK154137R1300	0.820
					Phase-to-phase	250...500	DRAF12-14P	1SBK154037R1400	0.820
4	7.5	9	9	18	Separate supply	24...60	DRAF16-11S	1SBK174237R1100	0.820
					Phase-to-neutral	100...250	DRAF16-13N	1SBK174137R1300	0.820
					Phase-to-phase	250...500	DRAF16-14P	1SBK174037R1400	0.820

(1) Select DRAF..S with separate supply for 24...60 V DC control circuit voltage (change A2 - Us wire to blue color acc. to IEC 60947-4-1).

**UL starter type with separate control supply wiring**

UL / CSA						Rated control circuit voltage Uc min ... Uc max	Type	Order code	Weight  Pkg (1 pce)  kg
Horse power ratings Single phase motor		Three phase motor							
120 V	240 V	200 V	220 V	440 V	550 V	V 50/60 Hz			
hp	hp	208 V	240 V	480 V	600 V				
						24...60	DRAF09-11U	1SBK134238R1100	0.820
						100...250	DRAF09-13U	1SBK134238R1300	0.820
						250...500	DRAF09-14U	1SBK134238R1400	0.820
1	2	3	3	7.5	10	24...60	DRAF12-11U	1SBK154238R1100	0.820
						100...250	DRAF12-13U	1SBK154238R1300	0.820
						250...500	DRAF12-14U	1SBK154238R1400	0.820
1.5	3	5	5	10	15	24...60	DRAF16-11U	1SBK174238R1100	0.820
						100...250	DRAF16-13U	1SBK174238R1300	0.820
						250...500	DRAF16-14U	1SBK174238R1400	0.820

**UL starters type**

0.75	1.5	2	2	5	7.5	Rated control circuit voltage	Type	Order code	Weight
						24...60	DRAF09-11U	1SBK134238R1100	0.820
						100...250	DRAF09-13U	1SBK134238R1300	0.820
						250...500	DRAF09-14U	1SBK134238R1400	0.820
1	2	3	3	7.5	10	24...60	DRAF12-11U	1SBK154238R1100	0.820
						100...250	DRAF12-13U	1SBK154238R1300	0.820
						250...500	DRAF12-14U	1SBK154238R1400	0.820
1.5	3	5	5	10	15	24...60	DRAF16-11U	1SBK174238R1100	0.820
						100...250	DRAF16-13U	1SBK174238R1300	0.820
						250...500	DRAF16-14U	1SBK174238R1400	0.820

1SBK133006S0201

## DRAF09 ... DRAF16 enclosed direct-on-line starters

Up to 7.5 kW and 10 hp, protected by thermal overload relays  
AC operated



TF42

### TF42 thermal overload relays to be ordered separately

Setting range	Short-circuit protective device	Trip class	Type	Order code	Weight (1 pce) kg
A					
0.10 ... 0.13	0.5 A, Fuse type T	10	TF42-0.13	1SAZ721201R1005	0.130
0.13 ... 0.17	1.0 A, Fuse type T	10	TF42-0.17	1SAZ721201R1008	0.130
0.17 ... 0.23	1.0 A, Fuse type T	10	TF42-0.23	1SAZ721201R1009	0.130
0.23 ... 0.31	1.0 A, Fuse type T	10	TF42-0.31	1SAZ721201R1013	0.130
0.31 ... 0.41	2.0 A, Fuse type gG	10	TF42-0.41	1SAZ721201R1014	0.130
0.41 ... 0.55	2.0 A, Fuse type gG	10	TF42-0.55	1SAZ721201R1017	0.130
0.55 ... 0.74	4.0 A, Fuse type gG	10	TF42-0.74	1SAZ721201R1021	0.130
0.74 ... 1.00	6.0 A, Fuse type gG	10	TF42-1.0	1SAZ721201R1023	0.130
1.00 ... 1.30	6.0 A, Fuse type gG	10	TF42-1.3	1SAZ721201R1025	0.130
1.30 ... 1.70	10.0 A, Fuse type gG	10	TF42-1.7	1SAZ721201R1028	0.130
1.70 ... 2.30	10.0 A, Fuse type gG	10	TF42-2.3	1SAZ721201R1031	0.130
2.30 ... 3.10	10.0 A, Fuse type gG	10	TF42-3.1	1SAZ721201R1033	0.130
3.10 ... 4.20	20.0 A, Fuse type gG	10	TF42-4.2	1SAZ721201R1035	0.130
4.20 ... 5.70	20.0 A, Fuse type gG	10	TF42-5.7	1SAZ721201R1038	0.130
5.70 ... 7.60	35.0 A, Fuse type gG	10	TF42-7.6	1SAZ721201R1040	0.130
7.60 ... 10.0	35.0 A, Fuse type gG	10	TF42-10	1SAZ721201R1043	0.130
10.0 ... 13.0	40.0 A, Fuse type gG	10	TF42-13	1SAZ721201R1045	0.130
13.0 ... 16.0	40.0 A, Fuse type gG	10	TF42-16	1SAZ721201R1047	0.130
16.0 ... 20.0	63.0 A, Fuse type gG	10	TF42-20	1SAZ721201R1049	0.145

### Empty enclosure with push-button

mm cable inlet/outlet suitable for IEC starter types	-	FR16AF-12	1SBN101337R1000	0.53
Inch cable inlet/outlet suitable for UL starter types	-	FR16AF-12U	1SBN101338R1000	0.53

To be completed with AF contactor, TF42 thermal overload relay and CBS-10 (1SBN010013R1010) start contact block.



Empty enclosure with push-button

# DRAF09 ... DRAF16 enclosed direct-on-line starters

## Control supply wiring versions

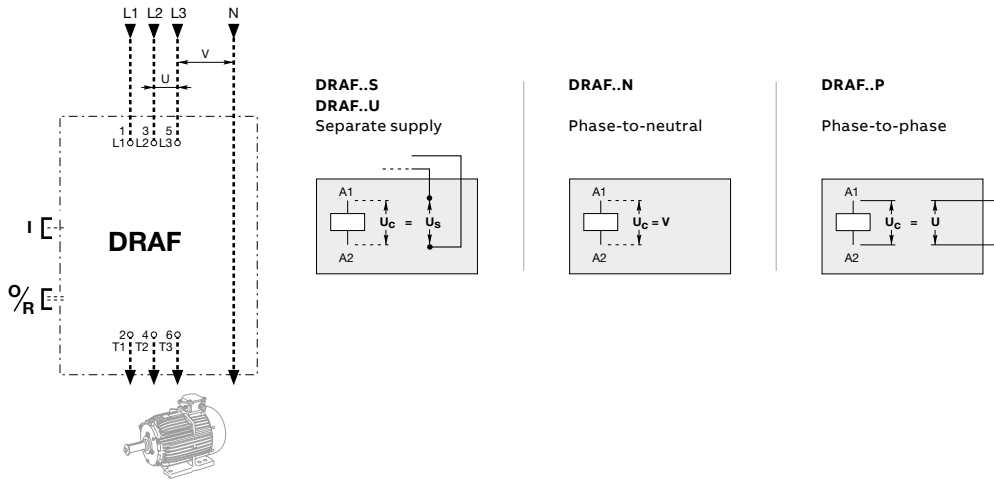

## Wiring diagram

### Power circuit

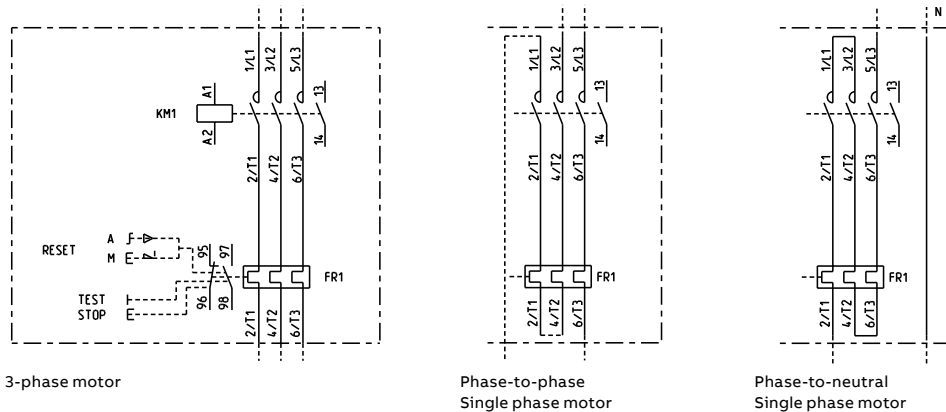

### AC local control

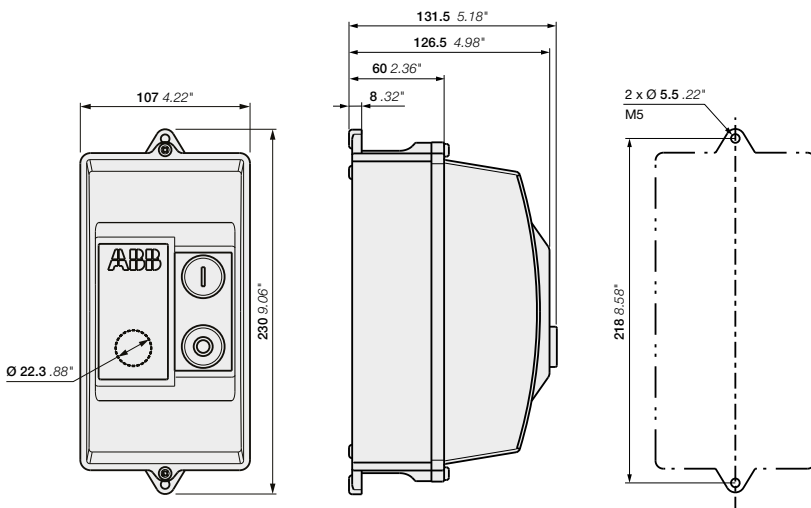
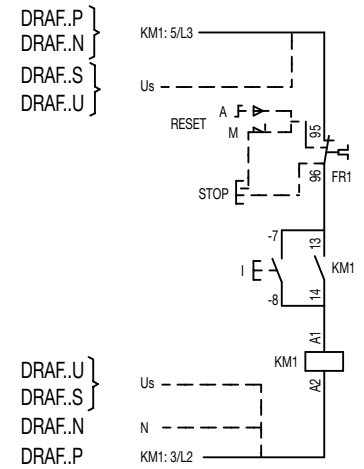

DRAF09, DRAF12, DRAF16  
Main dimensions mm, inches

### IEC starter types - ISO M20

Cable inlet	Cable outlet
Enclosure top	Enclosure bottom
2 x Ø 20 mm	2 x Ø 20 mm
2 x Ø 0.79"	2 x Ø 0.79"

### UL starter types - NPT

Cable inlet	Cable outlet
Enclosure top	Enclosure bottom
1 x 3/4"	1 x 3/4"
1 x 1/2"	1 x 1/2"

—  
**Notes**

A large rectangular area filled with a grid of small, evenly spaced dotted lines, intended for handwritten notes.





**For direct product details information, use product type or order code, ex:**

[www.abb.com/productdetails/HF2.4-ROL-24VDC](http://www.abb.com/productdetails/HF2.4-ROL-24VDC)  
or  
[Courtesy of Steven Engineering, Inc - \(800\) 258-9200 - \[sales@steveneng.com\]\(mailto:sales@steveneng.com\) - \[www.stevenengineering.com\]\(http://www.stevenengineering.com\)](http://www.abb.com/productdetails/<u>1SAT25000R1011</u></a></p></div><div data-bbox=)

# Electronic compact starters: HF range

<b>10/3</b>	<b>Overview</b>
	<b>HF0.6, HF2.4, HF9 electronic compact starters</b>
<b>10/8</b>	Direct-on-line starter
<b>10/8</b>	Direct-on-line starter with emergency stop
<b>10/9</b>	Reversing starter
<b>10/9</b>	Reversing starter with emergency stop
<b>10/10</b>	<b>Technical data</b>
<b>10/14</b>	<b>Technical diagrams</b>



## Electronic compact starters: HF range

### A compact solution with great functionality

ABB's electronic compact starter packs more functions into less space. The compact unit is just 22.5 mm wide and is suitable for three-phase motor loads up to 3 kW - 400 V AC. Direct-on-line and reversed starter with overload protection and emergency stop versions are available, making the range a perfect fit for high frequent and reliable long life switching of e.g. paper machines, conveyors, pumps, compressors and machine tools.



#### Saving space

##### Up to 90% less space required

ABB's electronic compact starter saves cabinet space, and is especially effective for group mounting. The starter is just 22.5 mm wide and yet still provides motor starting functionalities with motor protection and safety embedded.



#### Safety and protection

##### Integrated safety function

Protect your people with an emergency stop version that complies with SIL 3, PL e safety standards. Extend the life of your equipment and reduce maintenance costs with service lives that are ten times higher than electromechanical solutions.



#### Easy to install

##### Up to 75% reduced time in wiring

Wiring time during installation is cut to a minimum with motor protection, reversing function and emergency stop already integrated in the product. With just one component to install, the risk of wiring errors is lower. Separate overload protection is no longer needed.

# Electronic compact starters

## All-in-one: four functions in one starter

### Direct-on-line

ABB's direct-on-line starter comes with a function that runs the motor in a forward direction. An integrated electronic overload relay also helps protect the motor.

### Reversing capability

Reversing functionality is already integrated in our hybrid starter. This results in avoiding wiring faults and additionally saving time and space.

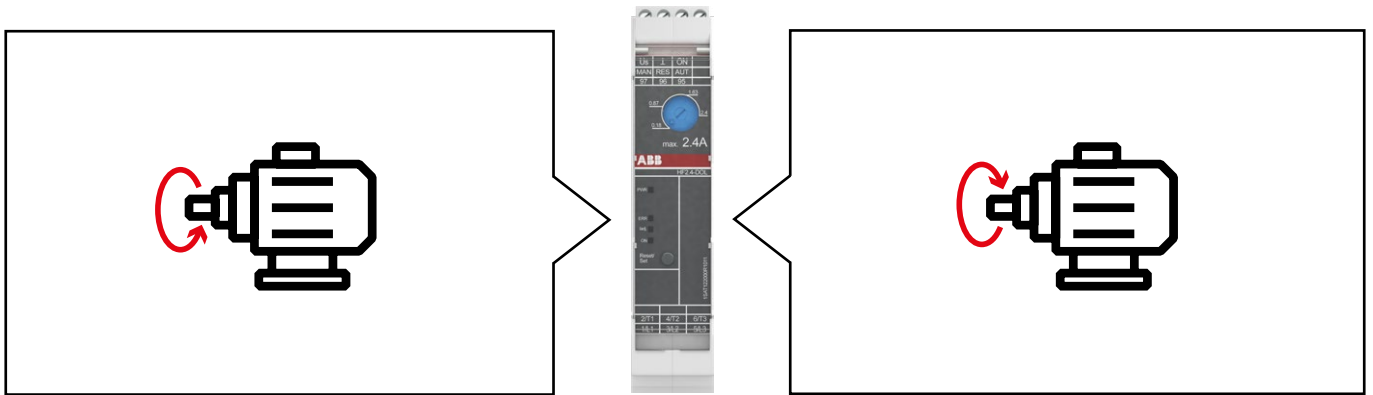

Direct-on-line and reversing function in only one product

### Emergency stop

ABB's HF safety range supports safety applications complying to SIL3 and PL e safety level in combination with modular safety relays such as ABB's Sentry SSR10.

### Overload protection

ABB offers three variants with wide setting ranges, using an electronic relay to protect the motor from overload. Protection against phase asymmetry and phase failure is also integrated.

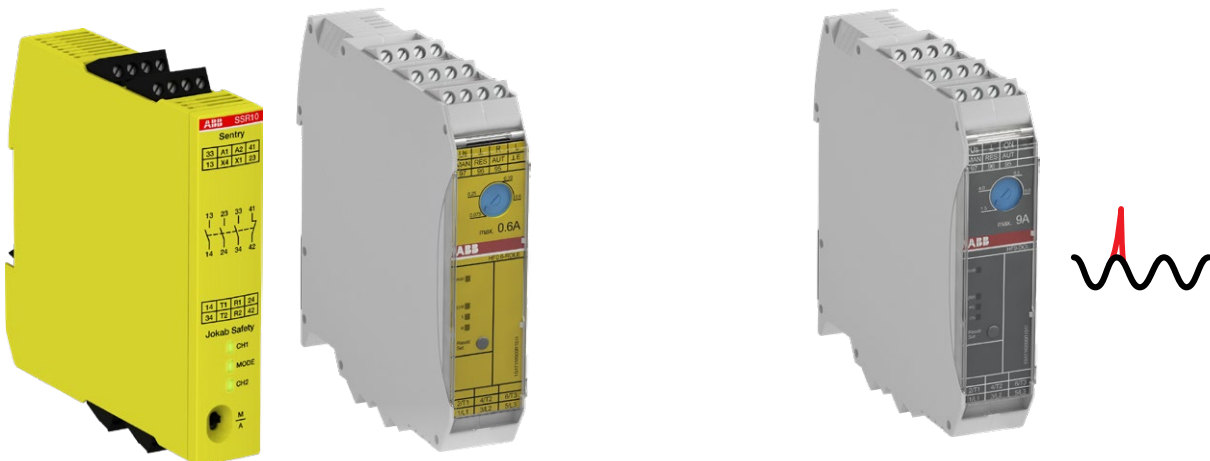

# Electronic compact starters

## Features and benefits

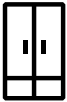

### Space-saving

Using an HF electronic compact starter saves space, especially when group-mounting units. With a width of just 22.5 mm and high function density, the unit fits any control cabinet. Smaller footprints for more compact systems are also possible.

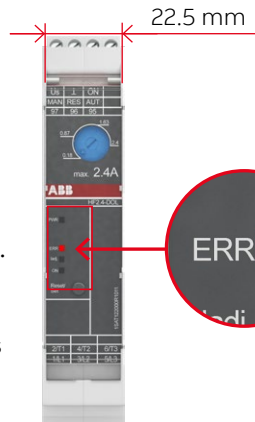

### Reset function

After the overload function has tripped, the electronic compact starter can be reset automatically, manually or remotely. The LEDs on the device are visualizing that an error has occurred. Additionally, a feedback relay will be activated.

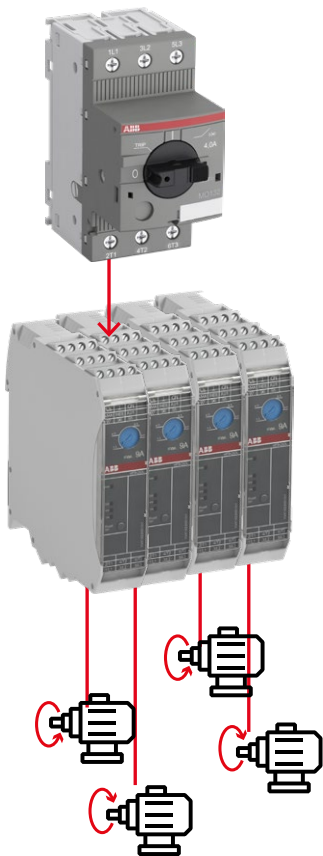

### Group mounting and protection ability

Combine the HF-Starter with a MO132 up to 10 A. Protection against overload is realized with the HF-Starter and the MO132 protects against short circuits. Maximum space saving for group mounting is guaranteed.



### Less wiring

The control circuit is connected on the upper side of the device with the main circuit on the underside. The all-in-one functionality reduces wiring, saving time and money – and reducing faults.

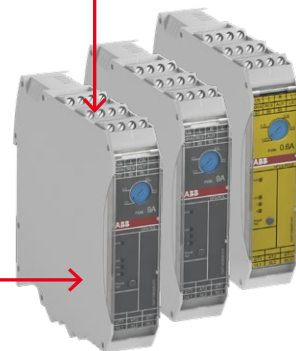

### Longer working life

ABB's hybrid technology improves durability and reduces power losses. Semiconductors switch on and off the unit and the relays remain active while the motor is running. With a lifespan of 30 million cycles now achievable, maintenance costs are reduced.

# Electronic compact starters

Hybrid technology

Hybrid technology – efficient, durable and compact – is the key feature of this range. Smart use of semiconductors with a relay bypass eliminates the wearing of contact materials. A microcontroller ensures the precise interaction of the components, providing the smoother switching that helps extend its long lifespan.

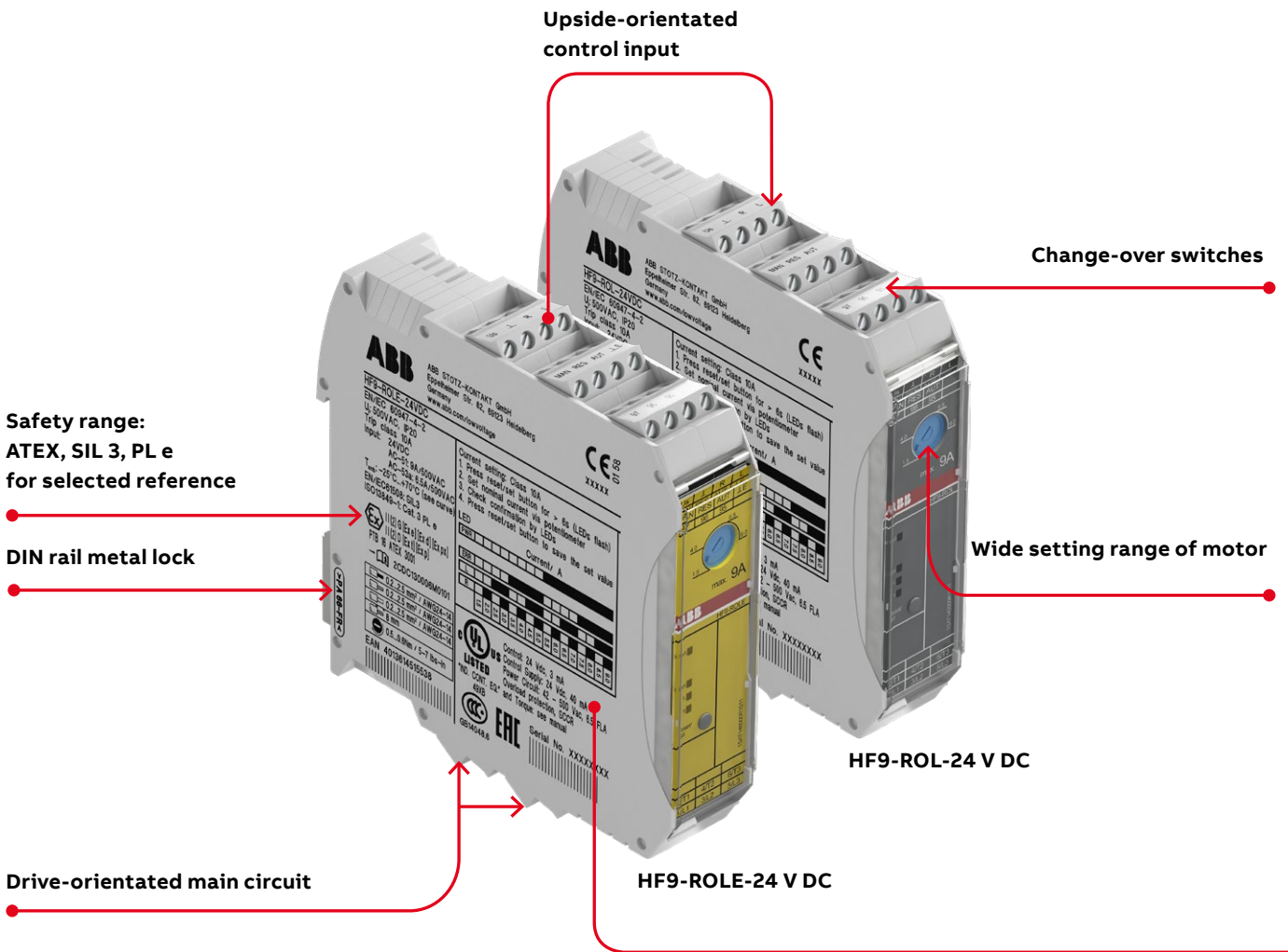

10

## Electronic compact starters - HF range

Hybrid technology

Thanks to laser labeling and fewer connection points compared to conventional solutions, hybrid technology makes wiring easy. The screw connections for both the control and the main circuit have an optimized angle to provide access.

**Only one component for up to four functions leads to shorter wiring time**

**Easy-to-read starter status with LED indicators: Precise current setting with LED confirmation Users can easily adjust the current and get visual feedback via the LEDs.**

**For example, if 6.5 A is set, the lights confirm the selection:**

LED	Current A
PWR	<input type="checkbox"/> 1.5 <input type="checkbox"/> 2.2 <input type="checkbox"/> 2.5 <input type="checkbox"/> 3.0 <input type="checkbox"/> 3.5 <input type="checkbox"/> 4.0 <input type="checkbox"/> 4.5 <input type="checkbox"/> 5.0 <input type="checkbox"/> 5.5 <input checked="" type="checkbox"/> 6.0 <input checked="" type="checkbox"/> 6.5 <input checked="" type="checkbox"/> 7.0 <input checked="" type="checkbox"/> 7.5 <input checked="" type="checkbox"/> 8.0 <input checked="" type="checkbox"/> 8.5 <input checked="" type="checkbox"/> 9.0
ERR	<input type="checkbox"/> 1.5 <input type="checkbox"/> 2.2 <input type="checkbox"/> 2.5 <input type="checkbox"/> 3.0 <input checked="" type="checkbox"/> 3.5 <input checked="" type="checkbox"/> 4.0 <input checked="" type="checkbox"/> 4.5 <input checked="" type="checkbox"/> 5.0 <input checked="" type="checkbox"/> 5.5 <input type="checkbox"/> 6.0 <input type="checkbox"/> 6.5 <input type="checkbox"/> 7.0 <input checked="" type="checkbox"/> 7.5 <input checked="" type="checkbox"/> 8.0 <input checked="" type="checkbox"/> 8.5 <input checked="" type="checkbox"/> 9.0
ladj.	<input checked="" type="checkbox"/> 1.5 <input type="checkbox"/> 2.2 <input type="checkbox"/> 2.5 <input type="checkbox"/> 3.0 <input type="checkbox"/> 3.5 <input checked="" type="checkbox"/> 4.0 <input type="checkbox"/> 4.5 <input type="checkbox"/> 5.0 <input type="checkbox"/> 5.5 <input type="checkbox"/> 6.0 <input type="checkbox"/> 6.5 <input checked="" type="checkbox"/> 7.0 <input type="checkbox"/> 7.5 <input type="checkbox"/> 8.0 <input type="checkbox"/> 8.5 <input type="checkbox"/> 9.0
ON	<input type="checkbox"/> 1.5 <input type="checkbox"/> 2.2 <input type="checkbox"/> 2.5 <input type="checkbox"/> 3.0 <input type="checkbox"/> 3.5 <input type="checkbox"/> 4.0 <input type="checkbox"/> 4.5 <input type="checkbox"/> 5.0 <input type="checkbox"/> 5.5 <input type="checkbox"/> 6.0 <input type="checkbox"/> 6.5 <input type="checkbox"/> 7.0 <input type="checkbox"/> 7.5 <input type="checkbox"/> 8.0 <input type="checkbox"/> 8.5 <input type="checkbox"/> 9.0

**22.5 mm** **Group mounting in confined spaces is no problem**

**Reset: direct manual reset of device with button, convenient remote or automatic reset after thermal trip**

Note: PWR: Control supply voltage, ERR : Error/Message, ladj.: Current setting, ON: Motor is running



# HF0.6, HF2.4, HF9 electronic compact starters

## Direct-on-line starter



2CDC24009V0016

HF9-DOL-24VDC



2CDC24012V0016

HF9-DOLE-24VDC

The HF-DOL-range is used for the direct-on-line start of motors and the switching of non-resistive loads. With contactor and overload relay functionalities integrated into one device, the results are faster wiring times and fewer faults. The range covers 0.6 A, 2.4 A and up to 9 A - for motors up to 3 kW – 400 V AC. The integrated electronic overload protection with tripping class 10A has a wide setting range that enables just three models to cover all requirements. The control supply voltage is 24 V DC. For the control and main connection points ABB offers screw connections.

ABB also offers a HF-DOLE safety range with emergency stop function. This offers Safety Integrity Level 3, in accordance with functional safety standard IEC 61508-1 and Performance Level 'e' in accordance with ISO 13849-1 all in combination with a safety relay like ABB's Sentry SSR10. The safety range is ATEX-certified.

Rated operational current AC-53a	Rated operational power AC-53a	Rated operational current AC-51	Setting range	Full load amps motor use	Type	Order code	Weight (1 pce)
A	kW	A	A	A			kg

### Direct-on-line starter with overload protection

0.6	0.18 (400V)	0.6	0.075 ... 0.6	0.6	HF0.6-DOL-24VDC	1SAT112000R1011	0.205
2.4	0.75 (400V)	2.4	0.18 ... 2.4	2.4	HF2.4-DOL-24VDC	1SAT122000R1011	0.218
6.5	3.00 (400V)	9.0	1.5 ... 9.0	6.5	HF9-DOL-24VDC	1SAT142000R1011	0.206

### Direct-on-line starter with overload protection and emergency stop

0.6	0.18 (400V)	0.6	0.075 ... 0.6	0.6	HF0.6-DOLE-24VDC	1SAT113000R1011	0.205
2.4	0.75 (400V)	2.4	0.18 ... 2.4	2.4	HF2.4-DOLE-24VDC	1SAT123000R1011	0.218
6.5	3.00 (400V)	9.0	1.5 ... 9.0	6.5	HF9-DOLE-24VDC	1SAT143000R1011	0.206

### Main dimensions mm, inches

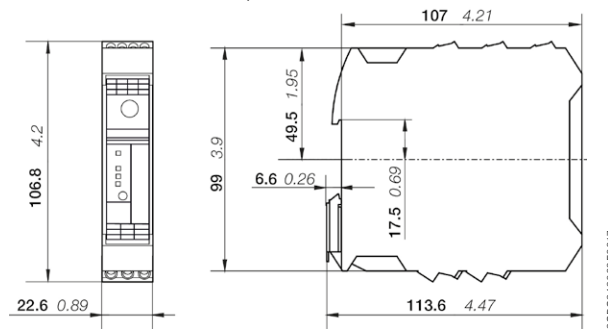

HF0.6, HF2.4, HF9

2CDC240103F0017

# HF0.6, HF2.4, HF9 electronic compact starters

## Reversing starter



HF9-R-24VDC

2CDC241003V0016



HF9-ROL-24VDC

2CDC241006V0016



HF9-ROLE-24VDC

2CDC241003V0016

The HF-ROL-range is used for forward and reverse running motors, as well as for switching non resistive loads. With contactor and overload relay functionalities integrated into one device, the results are faster wiring times and fewer faults. The range covers 0.6 A, 2.4 A and up to 9 A - for motors up to 3 kW – 400 V AC. The integrated electronic overload protection with tripping class 10A has a wide setting range that enables just three models to cover all requirements. The control supply voltage is 24 V DC. For the control and main connection points ABB offers screw connections.

ABB also offers a HF-ROLE safety range with emergency stop function. This offers Safety Integrity Level 3, in accordance with functional safety standard IEC 61508-1 and Performance Level 'e' in accordance with ISO 13849-1 all in combination with a safety relay like ABB's Sentry SSR10. The safety range is ATEX-certified.

Rated operational current AC-53a	Rated operational power AC-53a	Rated operational current AC-51	Setting range	Full load amps motor use	Type	Order code	Weight (1 pce)
A	kW	A	A	A			kg

**Reversing starter with no monitoring and no overload functionality**

6.5	3.00 (400V)	9.0	-	6.5	HF9-R-24VDC	1SAT144000R1011	0.174
-----	-------------	-----	---	-----	-------------	-----------------	-------

**Reversing starter with overload protection**

0.6	0.18 (400V)	0.6	0.075 ... 0.6	0.6	HF0.6-ROL-24VDC	1SAT115000R1011	0.217
2.4	0.75 (400V)	2.4	0.18 ... 2.4	2.4	HF2.4-ROL-24VDC	1SAT125000R1011	0.219
6.5	3.00 (400V)	9.0	1.5 ... 9.0	6.5	HF9-ROL-24VDC	1SAT145000R1011	0.218

**Reversing starter with overload protection and emergency stop**

0.6	0.18 (400V)	0.6	0.075 ... 0.6	0.6	HF0.6-ROLE-24VDC	1SAT116000R1011	0.218
2.4	0.75 (400V)	2.4	0.18 ... 2.4	2.4	HF2.4-ROLE-24VDC	1SAT126000R1011	0.270
6.5	3.00 (400V)	9.0	1.5 ... 9.0	6.5	HF9-ROLE-24VDC	1SAT146000R1011	0.289

**Main dimensions mm, inches**

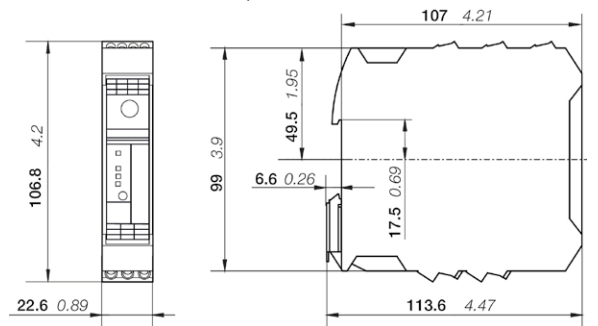

HF0.6, HF2.4, HF9

2CDC242003F0017

## HF0.6, HF2.4, HF9 electronic compact starters

### Technical data

#### Main circuit – Utilization characteristics according to IEC/EN

Type	HF-DOL/ROL	HF-DOLE/ROLE	HF-R
Standards	IEC/EN 60947-1, IEC/EN 60947-4-2	IEC/EN 60947-1, IEC/EN 60947-4-2, IEC/EN 61508, ISO 13849	IEC/EN 60947-1, IEC/EN 60947-4-2
Rated operational voltage U <sub>e</sub>	500 V AC		
Operational voltage	42 V AC, 550 V AC		
Setting range	see ordering details		
Rated frequency	50/60 Hz		
Trip class	10A		
Number of poles	3		
Number of protected poles	3		
Mechanical durability	10000 cycles		
Electrical durability	30 Mio. cycles		
Rated impulse withstand voltage U <sub>imp</sub>	6 kV		
Rated insulation voltage U <sub>i</sub>	500 V		
Rated operational current I <sub>e</sub> AC-51	see ordering details		
Rated operational current I <sub>e</sub> AC-53a	see ordering details		
Rated uninterrupted current I <sub>u</sub>	see ordering details, Rated operational current I <sub>e</sub>		
Overvoltage category	III		
Delay time	Off, minimum, switched off with pushbutton	1 s	-
	Off, maximum, switched off with pushbutton	3 s	-
	Off, typical, switched off via control input voltage	30 ms	30 ms
	Off, maximum, switched off via control input voltage	-	HF0.6, HF2.4: 60 ms HF9: 80 ms
	Off, typical, switched off via supply voltage	25 ms	25 ms
	Off, maximum, switched off via supply voltage	-	500 ms
Switch off time	By phase failure	1.8 s	-
	By phase asymmetry at 33%	120 s	-
	By phase asymmetry at 67%	1.8 s	-
Overspeed tripping	Operating threshold	HF9-DOL/ROL/DOLE/ROLE: >45 A	
	Response time	HF9-DOL/ROL/DOLE/ROLE: 2 s	
Power loss	Minimum	1.1 W	
	Maximum	HF0.6: 1.5 W HF2.4: 3.3 W HF9: 14.6 W	
Switching frequency	≤ 2 Hz; 120 starts/min; 7200 starts/h		
Overvoltage category	III		

#### Short circuit protection with fuses and miniature circuit breakers according to IEC/EN 60947-4-2

Order code	Rated current AC-53a	I <sub>q</sub>	Protection type	Rated current	Maximum voltage	Type of coordination
	A	kA		A	V	
1SAT...	0.6/2.4/6.5	50	Fuse gG	25	415	1
1SAT...	0.6/2.4/6.5	35	Fuse gG	25	500	1
1SAT...	0.6/2.4/6.5	1	S203-16B	16	500	1

#### For single and group mounting protection with manual motor starters according to IEC/EN 60947-4-2

I <sub>q</sub>	Number of HF starter			Manual motor starter	Rated current	Maximum voltage	Type of coordination
	HF0.6	HF2.4	HF09				
70	9	2	1	MO132-6.3	6.3	415	1
50	9	2	1	MO132-6.3	6.3	415	1
50	9	2	1	MO132-10	10	415	1
35	9	2	1	MO132-6.3	6.3	500	1
35	16	4	1	MO132-10	10	500	1

# HF0.6, HF2.4, HF9 electronic compact starters

## Technical data

### Main circuit – Utilization characteristics according to UL/CSA

Type	<b>HF</b>	
Standards	UL 60947-1; UL 60947-4-2	
Rated operational voltage	500 V AC	
Operational voltage	Minimum	42 V AC
	Maximum	550 V AC
Ampere Rating UL/CSA	see ordering details, Full load amps motor use	
Horse power rating	Nominal switching performance full load (power factor = 0.4)	HF0.6: 0.4 hp HF2.4: 1.2 hp HF9: 3.0 hp
	Nominal switching performance full load (power factor = 0.8)	HF0.6: 0.6 hp HF2.4: 2.2 hp HF9: 6.1 hp
Full loads Amps (FLA)	see ordering details	
Short-circuit current rating (SCCR) (500 V AC, 30 A Class J or CC)	100 kA	

### General technical data

Type	<b>HF</b>	
Utilization category	AC51, AC53a	
Pollution degree	2	
Phase loss sensitive	Yes	
Ambient air temperature	Operation	-25 ... + 70 °C
	Operation compensated	-40 ... + 80 °C
Mounting position	Position 1, load side bottom	
Mounting in DIN Rail	TH35-15 (35 x 15 mm Mounting Rail) acc. to IEC 60715, TH35-7.5 (35 x 7.5 mm Mounting Rail) acc. to IEC 60715	
Degree of protection	Housing	IP20
	Main circuit terminals	IP20

### Control circuit

Type	<b>HF</b>	
Rated control circuit voltage U <sub>c</sub>	24 V DC	
Input voltage U <sub>in</sub>	Switching Threshold at Signal <0>	-3 ... 9.6 V
	Switching Threshold at Signal <1>	19.2 ... 30 V
Input current I <sub>c</sub>	3 mA	

### Supply circuit

Type	<b>HF</b>	
Rated control supply voltage U <sub>s</sub>	24 V DC	
Control supply voltage	19.2 ... 30 V DC	
Rated control supply current I <sub>s</sub>	0.04 A	

### For single or group protection following fuses can be used for UL application according to UL 60947-1/ -4-1

Order code	Rated current A	I <sub>q</sub> kA	Protection type	Rated current A	Maximum voltage V	Type of coordination
1SAT...	0.6/2.4/6.5	100	Fuses class J or CC	30	500	1
1SAT...	0.6/2.4/6.5	5	Fuse RK5	20	500	1

## HF0.6, HF2.4, HF9 electronic compact starters

### Technical data

#### Safety related data



Type	HF-DOLE/ROLE
Standards	IEC/EN 60947-1, IEC/EN 60947-4-2, IEC/EN 61508, ISO 13849
Safe shut down for ambient temperature 40°C ... 60°C	
Safety integrity level acc. to IEC 61508-1	SIL 3
Performance level	Up to e
Mean time to failure (MTTF) acc. to IEC60050-191-12-07	DOLE: 43 years ROLE: 39.3 years
Mean time to dangerous failure, motor protection	447 years
Mean time to dangerous failure, safe shutdown	DOLE: 518 years ROLE: 517 years
Failure in time	
Safe, detectable $\lambda_{sd}$	DOLE: 543 FIT ROLE: 664 FIT
Safe, undetectable $\lambda_{su}$	DOLE: 852 FIT ROLE: 968 FIT
Dangerous, detectable $\lambda_{dd}$	218 FIT
Dangerous, undetectable $\lambda_{du}$	DOLE: 2.4 FIT ROLE: 2.67 FIT
Safe failure fraction (SFF)	DOLE: 99.85% ROLE: 99.86%
Diagnostic coverage (DC)	DOLE: 98.91% ROLE: 98.79%
Probability of dangerous failure per hour (PFH)	DOLE: 2.4 ROLE: 2.67
Motor overload protection for ambient temperature 40°C ... 60°C	
Safety integrity level acc. to IEC 61508-1	SIL 3
Performance level	Up to e
Mean time to failure (MTTF) acc. to IEC60050-191-12-07	DOLE: 43 years ROLE: 39.3 years
Mean time to dangerous failure, safe shutdown	DOLE: 518 years ROLE: 517 years
Failure in time	
Safe, detectable	DOLE: 517 FIT ROLE: 637 FIT
Safe, undetectable	DOLE: 809 FIT ROLE: 870 FIT
Dangerous, detectable	239 FIT
Dangerous, undetectable	17 FIT
Safe failure fraction (SFF)	DOLE: 98.92% ROLE: 99.03%
Diagnostic coverage	DOLE: 98.91% ROLE: 98.79%

## HF0.6, HF2.4, HF9 electronic compact starters



### Technical data

#### Connecting characteristics

##### Main circuit

Type	HF
Connecting capacity	
 Rigid 1 x	2 ... 2.5 mm <sup>2</sup>
 Flexible 1 x	2 ... 2.5 mm <sup>2</sup>
 Flexible with ferrule 1 x	2 ... 2.5 mm <sup>2</sup>
Connecting capacity acc. to UL/CSA	
Rigid 1 x	24 ... 14 AWG
Flexible 1 x	24 ... 14 AWG
Flexible with ferrule 1 x	24 ... 14 AWG
Stripping length	8 mm
Tightening torque	0.5 ... 0.6 N·m
Tightening torque UL/CSA	5 ... 7 in·lb
Terminal type	Screw terminals
Recommended screw driver	M3

##### Control circuit

Type	HF
Connecting capacity	
 Rigid 1 x	2 ... 2.5 mm <sup>2</sup>
 Flexible 1 x	2 ... 2.5 mm <sup>2</sup>
 Flexible with ferrule 1 x	2 ... 2.5 mm <sup>2</sup>
Connecting capacity acc. to UL/CSA	
Rigid 1 x	24 ... 14 AWG
Flexible 1 x	24 ... 14 AWG
Flexible with ferrule 1 x	24 ... 14 AWG
Stripping length	8 mm
Tightening torque	0.5 ... 0.6 Nm
Tightening torque UL/CSA	5 ... 7 in·lb
Terminal type	Screw terminals
Recommended screw driver	M3

# HF0.6, HF2.4, HF9 electronic compact starters

## Technical diagrams

### Derating curve

Please consider the derating curves for group mounting with and without  $\geq 22.5$  mm distance and the overload protection for tripping class 10A.

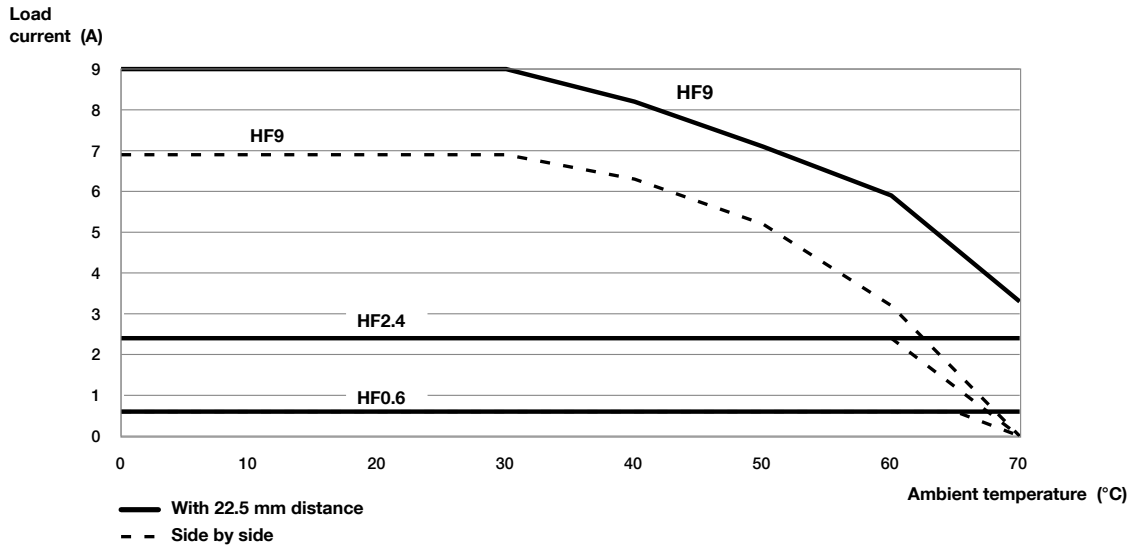

Derating curve HF range - electronic compact starters

### Tripping characteristics

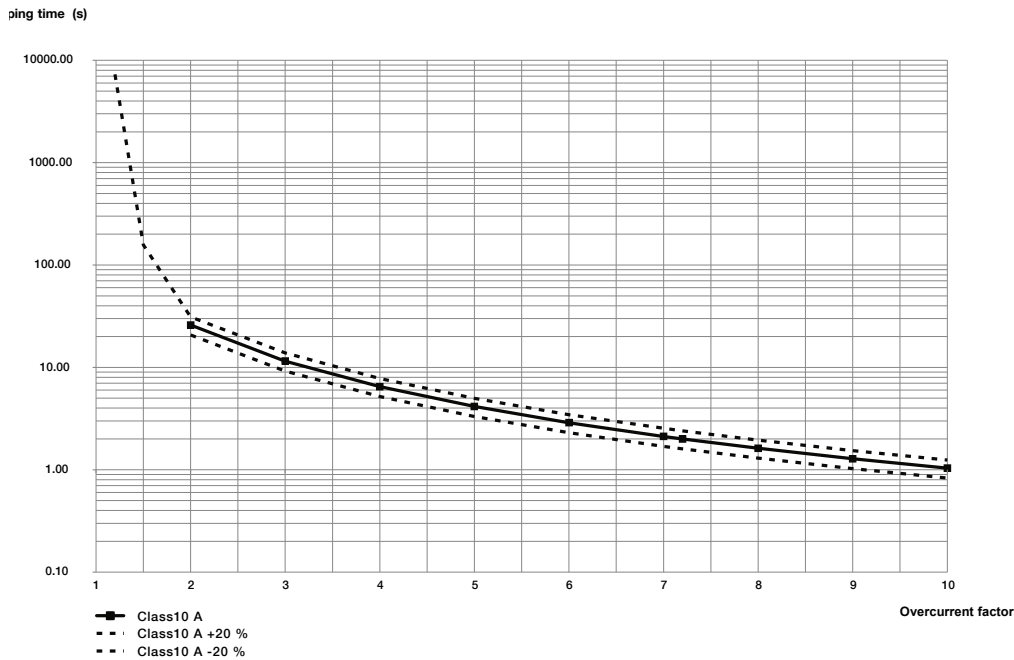

Tripping characteristics class 10A HF range - electronic compact starters

—

# Notes

A large rectangular area filled with a grid of small, light gray dotted lines, intended for handwritten notes.





**For direct product details information, use product type or order code, ex:**

[www.abb.com/productdetails/UMC100.3 DC](http://www.abb.com/productdetails/UMC100.3 DC)  
or  
[www.abb.com/productdetails/1SAJ530000R0100](http://www.abb.com/productdetails/1SAJ530000R0100)

---

# Universal Motor Controller

<b>11/2</b>	<b>Overview</b>
<b>11/4</b>	<b>Functions</b>
<b>11/5</b>	<b>Applications</b>
<b>11/6</b>	<b>Components</b>
<b>11/8</b>	<b>Ordering details</b>
<b>11/17</b>	<b>Technical data</b>
<b>11/26</b>	<b>Dimensional drawings</b>

# Keep motors running 24 hours a day

## Secure uptime for your application

ABB's control products protect, control and automate critical business processes to make any application more productive. Rely on ABB as the partner to provide flexible, universal products. The Universal Motor Controller is an easy-to-use device that keeps your application running.

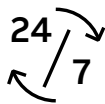

### Continuous operation

The Universal Motor Controller (UMC) provides comprehensive, electronic motor protection. It ensures the motor is protected at all times, even if the control system or fieldbus breaks down. The precise electronic measurement system enables optimal utilization of the motors. Continuous trip behavior is supported by the long-term, high stability of the tripping characteristics. A comprehensive diagnostic system facilitates fault localization and rectification to help keep the system running and reduce downtime.



### Speed up your projects

The system's modular approach means it can expand and adapt to provide the optimal solution for any situation, with an entry-level device that fulfills requirements for most applications. All of the control functions required in the field are integrated and easy to configure via parameters. Application-specific control functions can be readily achieved using the programmable logic system.



### Easy to install

The universal and modular structure of the UMC benefits the entire planning, design and maintenance process. It significantly reduces the amount of wiring required, as all the necessary protection, monitoring and control functions are integrated into a single device. The complete range of currents and communication: fieldbuses and Ethernet is covered in a single version, simplifying planning, inventory and servicing.

# Flexible motor management system

## Proven in use around the world

Unplanned or sudden motor stops can lead to costly faults in process sequences. ABB's Universal Motor Controllers stand for reliable motor protection, motor control, fieldbus and Ethernet communication and fault diagnosis. The UMC is used and trusted in countless applications with thousands of devices installed worldwide.



### Optimal solution for motor control center applications

ABB's UMC is a flexible, modular and expandable motor management system for constant-speed, low-voltage range motors. Its most important tasks include motor protection, prevention of plant standstills and the reduction of down time. Early information relating to potential motor problems and swift diagnosis ensure continuous operation. The UMC is proven in a wide range of segments and in large projects using several thousand motor controllers.



### Open communication

The UMC is equipped with an interface for mounting a communication adapter. Selecting the relevant adapter enables the Universal Motor Controller to communicate using the popular fieldbuses, Profibus DP, DeviceNet or Modbus RTU. Communication via Ethernet networks is possible using the EtherNet/IP™, Modbus TCP or Profinet protocol. The device can also be used without a communication interface as a stand-alone motor controller, such as in simple pump stations.



### High plant availability

The UMC continuously transmits comprehensive operational, service and diagnostic data from the motor to the control system. This means faults are detected early on and their effects limited or even avoided entirely by timely countermeasures, increasing plant availability.



### Made in Germany, approved worldwide

ABB's Universal Motor Controller is engineered and manufactured in Germany. Approvals and certificates ensure the worldwide use of the product and with our long experience of project management, ABB gives you the best possible support.



### The highlights

- Compact design with integrated measuring system
- Suitable for three-phase and single-phase motors
- Standard device meets most feature requirements
- Easy to extend for more advanced functionalities
- Perfect solution for motor control centers (MCCs)
- Worldwide approvals, including ATEX explosive atmosphere certification
- Fieldbus systems:
  - Profibus DP, DeviceNet and Modbus RTU
- Ethernet systems:
  - Modbus TCP, Profinet IO, EtherNet/IP™

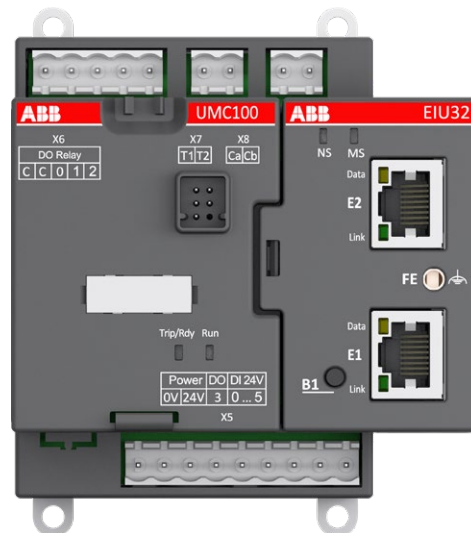

Universal Motor Controller UMC100.3 with EtherNet/IP™ interface EIU32.0

# The functions in detail

## Universal Motor Controller UMC100.3



### Motor protection

- The UMC provides comprehensive motor protection
- Overload protection for single and three-phase AC motors according to EN/IEC 60947-4-1
- Rated motor currents from 0.24 to 63 A with an integrated measuring system in a single version
- Rated motor currents up to 850 A with external current transformer CT4L/CT5L
- Selectable tripping classes 5E, 10E, 20E, 30E or 40E
- Locked rotor protection
- Phase failure, asymmetry and sequence protection
- Under-/ overcurrent protection
- Thermistor motor protection
- Ground leakage detection – internally or using CEM11-FBP.xxx sensors
- Limitation of motor starts per time
- Motor protection independent from bus communication

### In combination with voltage module VI150/VI155-FBP.0

- Undervoltage/overvoltage protection
- Power supervision
- Power factor supervision ( $\cos \varphi$ )
- Voltage-based detection of phase failure, asymmetry and sequence



### Motor control

- Integration of the most important motor control functions as ready, easily parameterizable blocks
- Direct, reversing, star-delta starters
- Pole changing/Dahlander Actuator mode
- Inching/jog mode
- Adjustable restart strategy (load shedding)

### Extended motor control

- Freely programmable for special, application-specific control functions
- Simple adaptation to specified control functions
- Comprehensive library
- Blocks for logic, counters, timing
- Access to all I/Os and internal signals



### Service data

- Counter for motor operating and standstill hours
- Number of starts
- Number of overload trips
- Energy

### Diagnostic data

- Comprehensive and detailed error messages and warnings
- Log for previous 16 errors
- Plain text display on the control panel

### Open communication

The UMC is a basic device that can use various communication methods; the communication protocol is selected by plugging-on the right fieldbus communication interface or connecting an Ethernet communication interface.



### Control stations and operation modes

- Individual and flexible configuration
- Remote operation via DCS or PLC
- Local control via pushbuttons
- Local control via operations panel UMC100-PAN
- Force local via input signal

### Motor status/communication

Quick and comprehensive access to all data via control station, fieldbus, Ethernet and/or laptop

### Operating data

- Motor status
- Motor current
- Thermal load
- Maximum starting current
- Run-up time
- Time to trip
- Remaining cool-down time

### Operating data with voltage module VI150/VI155-FBP.0

- Phase voltages
- Active power
- Apparent power
- Power factor
- Energy



# Main areas of application

Benefit from ABB's Universal Motor Controller functionality in a wide variety of segments. Its flexibility, global recognition and comprehensive certification make it the top choice, no matter where you are.

—  
01 Water supply and treatment plants

—  
02 Mining facilities

—  
03 Cement plants

## Cement factories

- Robust and compact design
- Several inputs, e.g. for querying the position of the damper limit switches

## Oil & gas, chemicals

- Programmability
- Ground fault monitoring
- Undervoltage detection and configurable restart following voltage restart
- Protection of motors in hazardous environments (ATEX)
- Use in IT networks

## Pulp and paper

- Conformal coating
- Modular design
- Flexible communication

## Mining

- Rated motor voltage of up to 1000 V
- Can be used at altitudes of up to 5000 m
- Ground fault monitoring

## Water supply and treatment

- Pump controls as required
- Underload detection with Cos φ measuring
- Pump cleaning application

## Others

- Steel plants
- Ships



01



02



03

# Components

The basic device can be expanded with several modules: digital expansion modules, analog and temperature modules, voltage modules and a range of communication interfaces, guaranteeing full flexibility and covering a wide range of applications.

## MAIN COMPONENTS

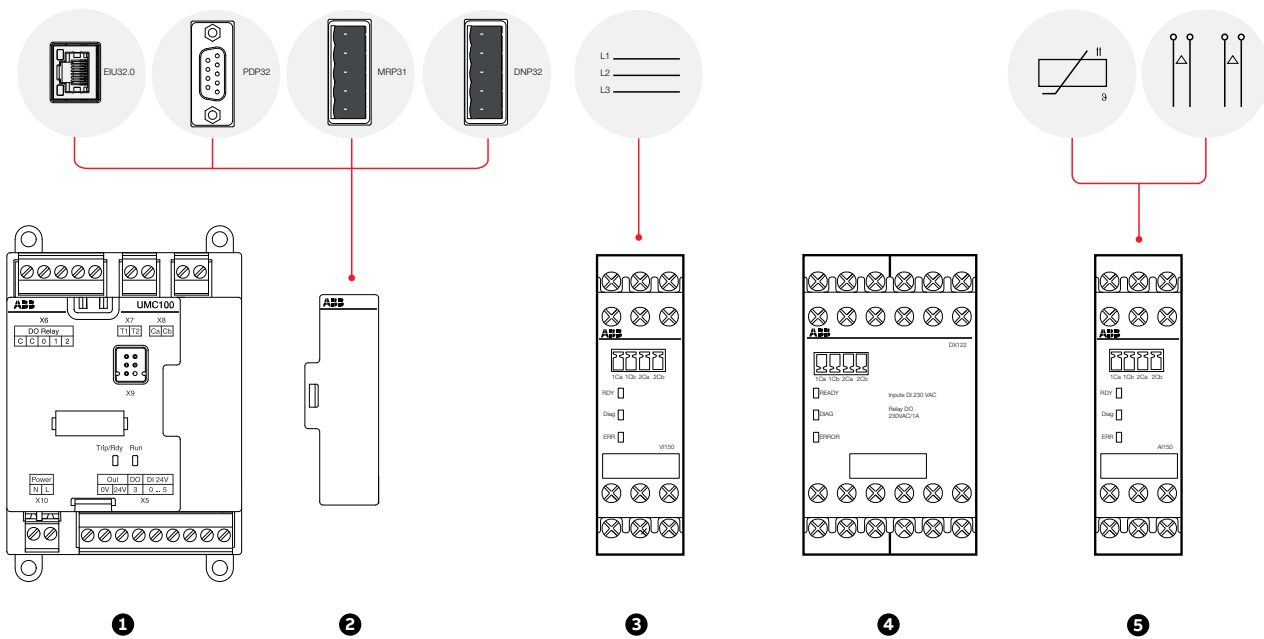

1

### UNIVERSAL MOTOR CONTROLLER UMC100.3

Basic device, expandable with different modules

- Voltage: max. 1000 V AC
- Tripping classes: 5E, 10E, 20E, 30E, 40E in accordance with IEC/EN 60947-4-1
- Built-in wide range measuring system, up to 63 A with one single version
- Supply voltages: 24 V DC, 110-240 V AC/DC
- Inputs: six digital inputs 24 V DC, one PTC input
- Outputs: four digital outputs



2

### COMMUNICATION INTERFACES

Directly connect a variety of communication interfaces to the UMC

- Fieldbus interfaces:
  - PDP32.0: Profibus DP, DNP31.0: DeviceNet, MRP31.0: Modbus RTU
- Ethernet Interfaces:
  - MTQ22-FBP.0: Modbus TCP, PNQ22-FBP.0: Profinet IO, EIU32.0: EtherNet/IP™



3

### VOLTAGE MODULES VI150/VI155-FBP.0

Voltage modules for determining phase voltages, power factor (cos φ), active power, apparent power, energy, harmonic content (THD)

- Supply voltage: 24 V DC
- 3-phase voltage measurement, up to 690 V in grounded and ungrounded networks
- Voltage dependent protection functions

A control panel with a backlit LDC display and a choice of nine different languages ensures easy operation of the UMC, wherever you are. Sensors detect earth leakages; current transformers increase the current measuring range.



#### DIGITAL MODULES DX111/DX122-FBP.0

Compact modules that increase the number of digital inputs and outputs

- Supply voltage 24 V DC
- Inputs: DX111 eight digital inputs 24 V DC, DX122 eight digital inputs 110/230 V AC
- Outputs: four digital relay outputs, one configurable analog output

4



#### ANALOG/TEMPERATURE MODULE AI111.0

Expand the UMC with analog and temperature inputs

- Supply voltage: 24 V DC
- Three analog inputs
- Configurable for temperature sensors and standard signals
- Two modules AI111 can be connected to one UMC

5

## ACCESSORIES



#### OPERATING PANEL UMC100-PAN

Installation on the UMC or on the control cabinet door

- Graphics-enabled, backlit display with three LEDs for status indication
- Monitors all values, shows the status and diagnostic data
- Speaks your language - choice of nine menu languages
- USB-port for connection to a PC
- Up/download of parameters and custom application logic

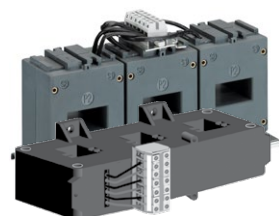

#### CURRENT TRANSFORMERS CT4L/CT5L

Extend the integrated measuring system for larger motors

- For nominal motor currents > 63 A up to 850 A
- Linear transformer, 3-phase with terminal block, designed for connecting leads Cu 2.5 mm<sup>2</sup>



#### EARTH LEAKAGE SENSORS CEM11-FBP.XXX

Summation current transformer for connecting to a digital input. Mounting with bracket on DIN busbar or wall

- Four versions available with diameters from 20 mm to 120 mm
- Simple residual current adjustment with rotary switch, including test position
- Direct connected to a digital input of the motor controller
- Flexible mounting



## Universal Motor Controller UMC100.3

### Ordering details



UMC100.3

#### Description

Intelligent motor management system for single and three-phase motors with  $I_e = 0.24 - 63 \text{ A}$  in a single device. Compact housing with integrated current transformer for cable cross sections up to  $25 \text{ mm}^2$  (max.  $\varnothing$  with insulation  $11 \text{ mm}$ ). Higher currents with additional external current transformer. Thermal overload protection according to EN/IEC 60947-4-1, selectable trip classes 5E, 10E, 20E, 30E, 40E. Some functions require an additional expansion module.

- Motor protection functions:
  - Over-/underload, over-/undercurrent, over-/undervoltage, rotor blocking, phase failure/imbalance/sequence
  - Earth fault detection integrated or with external sensor CEM11-FBP.0
  - Hot motor protection with thermistor or temperature measurement
- Motor control functions:
  - Easily configurable motor control functions: direct, reverse, star-delta starter, pole-changing, overload relay, actuator mode, softstarter mode. Additionally free programmable application specific logic with function blocks
- Service and diagnostic data:
  - Operating hours, number of motor starts and overload trips, energy, standstill and operation hours supervision, motor status, faults and warnings, fault history (16 events)
  - Motor current, phase voltages, thermal load, power factor ( $\cos \varphi$ ), active power, apparent power, energy, total harmonic distortion (THD).
- Integrated I/Os: six digital inputs, one PTC input, four digital outputs. Maximum number of I/Os with expansion modules: 14 digital inputs, one PTC input, nine digital outputs, six analog inputs, one analog output
- Communication interfaces for fieldbuses and Ethernet networks, Interface for operator panel UMC100-PAN, bus interface for connection of expansion modules
- Versions for supply voltage 24 V DC and 110 – 240 V AC/DC, with ATEX approval and with ATEX plus conformal coating for applications in aggressive atmosphere

Description	Supply voltage	Type	Order code	Pkg qty	Weight (1 pce) kg
Universal Motor Controller	24 V DC	UMC100.3 DC	<a href="#">1SAJ530000R0100</a>	1	0.275
Universal Motor Controller	110-240 V AC/DC	UMC100.3 UC	<a href="#">1SAJ530000R1100</a>	1	0.315
Universal Motor Controller, ATEX	24 V DC	UMC100.3 DC EX	<a href="#">1SAJ530000R0200</a>	1	0.275
Universal Motor Controller, ATEX	110-240 V AC/DC	UMC100.3 UC EX	<a href="#">1SAJ530000R1200</a>	1	0.315
Universal Motor Controller, ATEX conformal coating	24 V DC	UMC100.3 DC EX Coated	<a href="#">1SAJ530000R0210</a>	1	0.275
Universal Motor Controller, ATEX conformal coating	110-240 V AC/DC	UMC100.3 UC EX Coated	<a href="#">1SAJ530000R1210</a>	1	0.315

## Operating panel and cables

### Ordering details



UMC100-PAN

2CDC341008W0014

#### Description

Operating panel for Universal Motor Controller UMC100.3. Backlit graphical and multilingual full-text display, LEDs for status display. Assembly directly on UMC100.3 or on the control cabinet door via door mounting set (includes the connection cable).

#### Functions

- Monitor: Shows motor status, diagnostics and maintenance data
- Operate: Start, stop, fault reset
- Parametrize: Setting and changing of all motor and fieldbus parameters (password protection possible); all settings are performed in the selected language
- Memory: Copy settings from one UMC100.3 to another
- USB port for up/download of parameters and logic from PC with PBDM software

Supports nine languages: English, Finnish, French, German, Italian, Polish, Portuguese, Russian, Spanish

The protection cap UMC100-PAN increases the degree of protection for the operator panel from IP52 to IP54. It consists of transparent and flexible silicone material making it easy to read text messages, checking the LED status and use the buttons. It is removable to access the micro-USB port for parameter up/download.



UMC100-PAN CAP

2CDC341001V0017

Description	Type	Order code	Pkg qty	Weight (1 pce) kg
Operating panel	UMC100-PAN	<a href="#">1SAJ590000R0103</a>	1	0.047
0.7 m ext. cable with door mounting set	UMCPAN-CAB.070	<a href="#">1SAJ510003R0002</a>	1	0.070
1.5 m ext. cable with door mounting set	UMCPAN-CAB.150	<a href="#">1SAJ510004R0002</a>	1	0.088
3 m ext. cable with door mounting set	UMCPAN-CAB.300	<a href="#">1SAJ510002R0002</a>	1	0.176
Protection cap for operating panel	UMC100-PAN CAP	<a href="#">1SAJ510005R0001</a>	10	0.013

## Expansion modules

### Ordering details



DX111-FBP.0

2CDC34100550009



DX122-FBP.0

2CDC34100450009



VI150-FBP.0

2CDC34100150011



AI111.0

2CDC34100150015

#### Description

Up to four expansion modules can be connected to one UMC100.3:

- One digital expansion module DX111-FBP.0 or DX122-FBP.0
- One voltage expansion module VI150-FBP.0 or VI155-FBP.0
- Two analog/temperature expansion modules AI111.0

The supply voltage is 24 V DC; the 110-240 V AC/DC version of the UMC100.3 provides the 24 V DC supply for expansion modules

#### DX111-FBP.0

I/O-expansion module with eight digital inputs 24 V DC, four relay outputs, one analog output 0/4-20 mA or 0...10 V

#### DX122-FBP.0

I/O-expansion module with eight digital inputs 110/230 V AC, four relay outputs, one analog output 0/4-0 mA or 0-10 V.

#### VI15x-FBP.0

Voltage modules for the determination of phase voltages, power factor ( $\cos \varphi$ ), apparent power, energy, total harmonic distortion (THD). For use in grounded networks (VI150-FBP.0) or in all networks (VI155-FBP.0), 150-690 V AC.

#### AI111.0

Analog/temperature expansion module, three inputs PT100, PT1000, KTY83, KTY84, NTC, 0-10 V, 0/4-20 mA one or two modules AI111.0 can be connected to an UMC100.3.

Description	Type	Order code	Pkg qty	Weight (1 pce) kg
I/O module for UMC100, 24 V DC digital input	DX111-FBP.0	<a href="#">1SAJ611000R0101</a>	1	0.220
I/O module for UMC100, 110 - 230 V AC digital input	DX122-FBP.0	<a href="#">1SAJ622000R0101</a>	1	0.220
3-phase voltage module for grounded networks	VI150-FBP.0	<a href="#">1SAJ650000R0100</a>	1	0.110
3-phase voltage module for all networks	VI155-FBP.0	<a href="#">1SAJ655000R0100</a>	1	0.110
Analog/temperature module 3 analog inputs	AI111.0	<a href="#">1SAJ613000R0101</a>	1	0.116
Connection cable UMC100 - I/O module, length 0.3 m	UMCIO-CAB.030	<a href="#">1SAJ691000R0001</a>	1	0.011
Connection cable IO-module - IO-module, length 0.3 m	IOIO-CAB.030	<a href="#">1SAJ692000R0001</a>	1	0.011
Terminal set for UMC100.3 DC (spare parts)	UMCTB-FBP.0	<a href="#">1SAJ929160R0001</a>	1	0.043
Terminal set for UMC100.3 UC (spare parts)	UMCTB.1	<a href="#">1SAJ929160R0002</a>	1	0.045

# Fieldbus interfaces

## Ordering details



PDP32.0



MRP31.0



DNP31.0



PDR31.0

### Description

Fieldbus communication interfaces enable the UMC100.3 to communicate via fieldbus. The interfaces can be used in two ways:

- Mounted directly on an UMC100.3 – the interface is supplied from the UMC100.3 and no additional accessory is required
- Mounted separately on a SMK3.0 adapter in the cable chamber of an MCC, the interface plugged on SMK3.0 requires a 24 V DC supply. Ready-made cables for applications in withdrawable systems are available, as well as terminal blocks for other cables:  
 CDP18.150: Cable for use inside the drawer CDP24.150: Cable from SMK3.0 to drawer outside

### PDP32.0

- Communication interface for PROFIBUS DP; supports the protocols PROFIBUS DP/V0 and V1
- PNO-certified PROFIBUS slave
- Data transfer rate up to 12 Mbit/s
- Diagnostic LEDs
- Fieldbus connection via nine-pole Sub-D connector or terminal blocks
- GSD download from UMC100.3 webpage

### MRP31.0

- Communication interface for Modbus RTU
- Data transfer rate up to 57.6 kbit/s
- Diagnostic LEDs
- Fieldbus connection via terminal blocks

### DNP31.0

- Communication interface for DeviceNet
- ODVA-certified DeviceNet slave
- Data transfer rate up to 500 kbit/s
- Diagnostic LEDs
- Fieldbus connection via terminal blocks
- EDS download from UMC100.3 webpage

### PDR31.0

- External active fieldbus termination for Profibus DP; the PDR31.0 needs to be mounted on a SMK3.0 adapter and supplied by 24 V DC

Description	Type	Order code	Pkg qty	Weight (1 pce) kg
Profibus DP communication interface	PDP32.0	<a href="#">1SAJ242000R0001</a>	1	0.050
Modbus RTU communication interface; terminal block for fieldbus connection included	MRP31.0	<a href="#">1SAJ251000R0001</a>	1	0.039
DeviceNet communication interface; terminal block for fieldbus connection included	DNP31.0	<a href="#">1SAJ231000R0001</a>	1	0.039
Profibus DP active bus termination	PDR31.0	<a href="#">1SAJ243000R0001</a>	1	0.030

# Adapter and accessories

## Ordering details

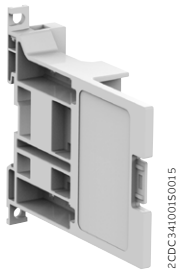

SMK3.0



CDP18.150



PDP32.0 on SMK3.0



EIU32.0 on SMK3.0

### Adapter and ready-made cables

Adapter SMK3.0 for external mounting of a fieldbus or EtherNet/IP™ interface EIU32.0 outside a drawer. SMK3.0 can be mounted on a DIN-rail or fixed by screws. 24 V DC supply is required. Ready-made cables for inside and outside the drawer, including a terminal block on one side and open end on the other. Terminal blocks are also separately available for making own cables.

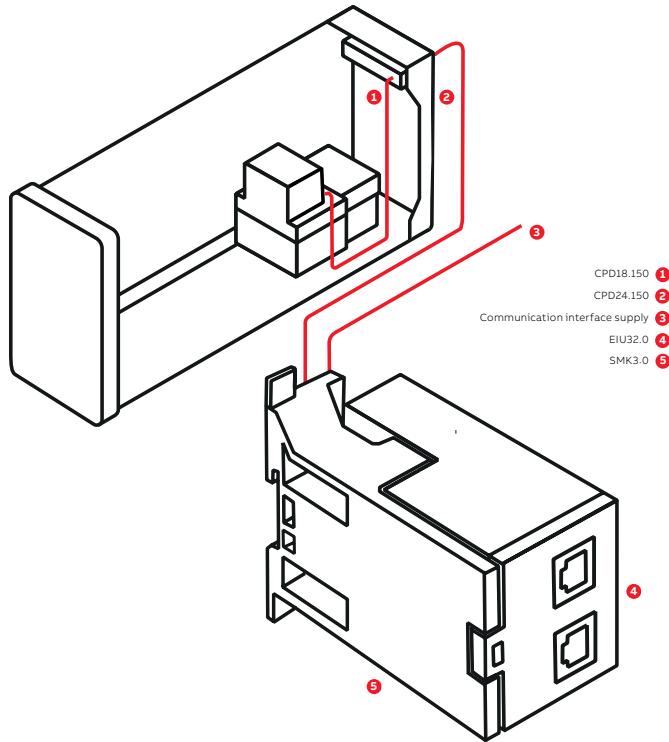

Separate wiring of the EtherNet/IP™ communication interface EIU32.0

Description	Type	Order code	Pkg qty	Weight (1 pce) kg
Adapter for separate mounting of a communication interface; terminal block for 24 V DC supply included	SMK3.0	<a href="#">1SAJ929600R0001</a>	1	0.038
Cable for use inside drawer, length 1.5 m	CDP18.150	<a href="#">1SAJ929180R0015</a>	1	0.060
Cable from SMK3.0 to drawer's outside, length 1.5 m	CDP24.150	<a href="#">1SAJ929240R0015</a>	1	0.060
Terminal block 2-pole for SMK3.0 supply (spare parts)	SMK3-X2.10	<a href="#">1SAJ929610R0001</a>	10	0.017
Terminal block 5-pole for SMK3.0 comm. (spare parts)	SMK3-X1.10	<a href="#">1SAJ929620R0001</a>	10	0.041

# Ethernet interfaces

## Ordering details



MTQ22-FBP.0

2CDC34100950012



PNQ22-FBP.0

2CDC34100150014



EIU32.0

2CDC34100990018

### Description

Ethernet communication interfaces enable the UMC100.3 to communicate via an Ethernet network. There are two types of interfaces:

Interfaces for the connection of one to four Universal Motor Controllers UMC100.3:

- MTQ22-FBP.0 for Modbus TCP
- PNQ22-FBP.0 for Profinet IO

Interface for a single universal motor controller UMC100.3:

- EIU32.0 for EtherNet/IP™

### MTQ22-FBP.0

- Protocol Modbus TCP
- For one to four UMC100.3
- Master supervision with timeout control for up to four masters
- Micro USB-port for configuration via PC (configuration software downloaded from UMC100.3 webpage)
- Integrated Ethernet switch
- Supports all network topologies
- Ring topology with redundancy (MRP protocol)
- Easy to use in withdrawable applications
- No special Ethernet connectors required in MCCs
- 24 V DC supply voltage
- DIN-rail mounting

### PNQ22-FBP.0

- Protocol Profinet IO
- PNO-certified
- For one to four UMC100.3 devices
- Integrated Ethernet switch
- Supports all network topologies
- Ring topology with redundancy (MRP protocol)
- Easy to use in withdrawable applications
- No special Ethernet connectors required in MCCs
- Fully integrated into ABB 800xA
- Time-stamped events with ABB 800xA
- 24 V DC supply voltage
- DIN-rail mounting
- GSDML downloaded from UMC100.3 webpage

### EIU32.0

- Protocol EtherNet/IP™
- ODVA-certified
- For one motor controller UMC100.3
- Mounting directly on an UMC100.3 (supplied by UMC100.3) or remotely on a SMK3.0 adapter (24 V DC supply required)
- Integrated Ethernet switch
- Supports all network topologies
- DLR (Device Level Ring) function for redundancy
- Easy to use in withdrawable applications
- No special Ethernet connectors required in MCCs
- EDS download from UMC100.3 webpage

Description	Type	Order code	Pkg qty	Weight (1 pce) kg
Ethernet Modbus TCP interface	MTQ22-FBP.0	<a href="#">1SAJ260000R0100</a>	1	0.172
Ethernet Profinet IO interface	PNQ22-FBP.0	<a href="#">1SAJ261000R0100</a>	1	0.172
EtherNet/IP™ interface	EIU32.0	<a href="#">1SAJ262000R0100</a>	1	0.110

# Ready-made cables, terminal blocks

## Ordering details



CDP18.150

2CDC341007F0018



Terminal blocks ETHTB-FBP.xx

2CDC341008F0018

### Ready-made cables

Ready-made cables are available for application in withdrawable systems as well as for fixed installations. Cables include ready-mounted terminal blocks. All connectors are also available as spare parts for creating individual cable connections.

Terminal blocks for making own cables are also available:

### MTQ22-FBP.0, PNQ22-FBP.0

- CDP18.150 cable for use inside and outside a drawer
- CDP23.150, CDP23.300 cables from Ethernet interface to UMC100.3

### EIU32.0

- CDP18.150 cable for use inside a drawer
- CDP24.150 cable for use outside a drawer and connection to a SMK3.0 adapter

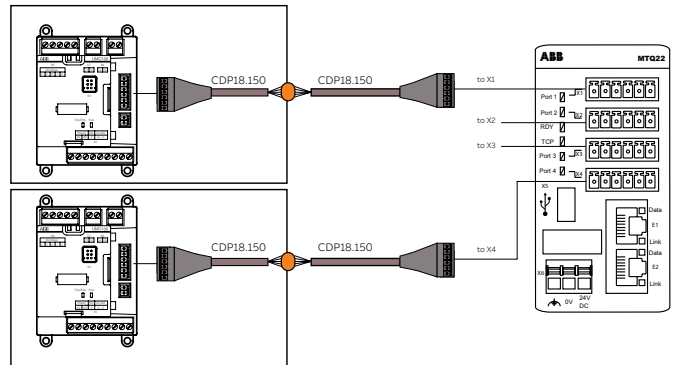

UMC100.3, withdrawable application with MTQ22-FBP.0/PNQ22-FBP.0

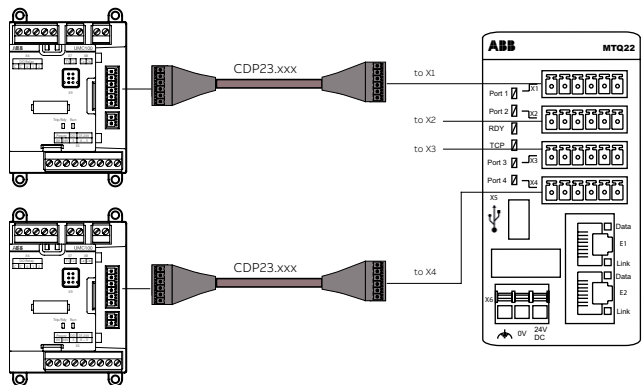

UMC100.3, fix mounted application with solution MTQ22-FBP.0/PNQ22-FBP.0

Description	Type	Order code	Pkg qty	Weight (1 pce) kg
Cable for inside and outside drawer, length 1.5 m	CDP18.150	<a href="#">1SAJ929180R0015</a>	1	0.060
Cable Ethernet interface - UMC100.3, length 1.5 m	CDP23.150	<a href="#">1SAJ929230R0015</a>	1	0.100
Cable Ethernet interface - UMC100.3, length 3 m	CDP23.300	<a href="#">1SAJ929230R0030</a>	1	0.160
Cable from SMK3.0 to drawer's outside, length 1.5 m	CDP24.150	<a href="#">1SAJ929240R0015</a>	1	0.060
Terminal blocks for MTQ22/PNQ22 X1...X4	ETHTB-FBP.4	<a href="#">1SAJ929200R0001</a>	4	0.015
Terminal blocks for MTQ22/PNQ22 X1...X4	ETHTB-FBP.50	<a href="#">1SAJ929200R0002</a>	50	0.015

## Configuration software

### Ordering details

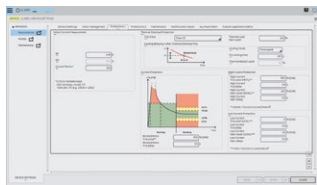

Configuration software example

#### FIM UMC EDITION configuration software for the UMC100.3 motor management system

The FIM UMC Edition is based on the Field Device Integration (FDI) standard. This latest standard combines the benefits of both major former technologies, EDD and FDT/DTM. It is the perfect tool for configuration of the UMC100.3 universal motor controller in large applications in the process industry and also in smaller projects such as the water industry. The FIM UMC Edition is equipped with a high-performance graphical user interface which is quick to install. It scans, identifies and enables access to devices within three minutes. It provides effective basic functionality for configuration, diagnosis and maintenance, during commissioning, in the workshop or as second master in a Profibus network of a process control system.



#### Overview of features

- Online/offline configuration and parameterization of UMC100.3
- Maximum number of tags is 2500
- Reading parameterization and configuration information from the device
- Online display of measuring, status and diagnostics data
- Online operation and error acknowledgment
- Creation of custom application logics
- Archiving



UTP22-FBP.0

2CDC341004F0011

#### Supported languages

FIM basic package	Chinese, English, German
UMC100.3 Device Package	Chinese, English, Spanish, German, Italian, Polish, Portuguese, Russian
UMC100.3 Custom Application Editor	English

#### System requirements

- Windows 7 (64 bit)/Windows 8.1, Windows 10, admin rights
- 10 GB storage space
- Minimum of 1 GB RAM

Connection to UMC100.3 can be done either via PROFIBUS DP or as a point-to-point connection

Connection to Profibus DP network: UTP22-FBP.0

Connection to UMC100.3: With micro-USB cable via control panel UMC100-PAN

A trial version with limited functionality can be downloaded from <https://new.abb.com/control-systems/fieldbus-solutions/fim>

The single user license in the FIM UMC Edition package upgrades the trial version to a full version

Description	Type	Order code	Pkg qty	Weight (1 pce) kg
USB interface for Profibus networks	UTP22-FBP.0	<a href="#">1SAJ924013R0001</a>	1	0.261
FIM UMC Edition, Single user license	PBDTM-FBP.0	<a href="#">1SAJ925000R0001</a>	1	n.a.



## Earth fault monitors, current transformers

### Ordering details

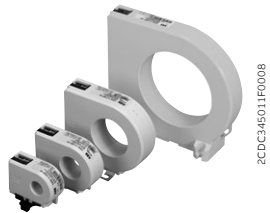

CEM11-FBP.xxx

2CDC34501F0006

#### Earth fault monitors CEM11-FBP.xxx for use with the Universal Motor Controller UMC100.3

The CEM11-FBP.xxx device monitors if the sum of the currents flowing through it is zero (factorial addition). If the sum is zero, no residual current is present. If the residual current is above an adjusted threshold value, the output signal of the CEM11-FBP.xxx changes. It can be used in motor feeders to detect leakage currents, as well as ground faults, caused for example by insulation breakdowns.

- CEM11-FBP.xxx is connected to a digital input of the UMC100.3
- Earth fault current threshold can be set in eight steps with a screwdriver
- Test position for easy control of the wiring

CEM11-FBP.xxx is delivered with adapters for DIN-rail or wall mounting.  
CEM-11.FBP.120 is for wall-mounting only.



CT4L185R/4, CT4L310R/4

2CDC34001S0012



CT5L500R/4, CT5L850R/4

2CDC34100250012

Earth fault currents [mA]	Through-hole diameter	Type	Order code	Pkg qty	Weight (1 pce) kg
80 <sup>1)</sup> , 300, 550, 750, 1000, 1200, 1500, 1700	20 mm	CEM11-FBP.20	<a href="#">1SAJ929200R0020</a>	1	0.130
100 <sup>1)</sup> , 500, 1000, 1400, 2000, 2400, 3000, 3400	35 mm	CEM11-FBP.35	<a href="#">1SAJ929200R0035</a>	1	0.200
120 <sup>1)</sup> , 1000, 2000, 2800, 4000, 4800, 6000, 6800	60 mm	CEM11-FBP.60	<a href="#">1SAJ929200R0060</a>	1	0.330
300 <sup>1)</sup> , 2000, 4000, 5600, 8000, 9600, 12000, 13600	120 mm	CEM11-FBP.120	<a href="#">1SAJ929200R0120</a>	1	0.940

<sup>1)</sup> Lower values have higher inaccuracy

#### Current transformers for use with the Universal Motor Controller UMC100.3

Linear type three-phase transformers, for use with the UMC100.3 and nominal motor currents >63 A. Terminal blocks for conductors Cu 2.5 mm<sup>2</sup> for wiring on the UMC100.3 side.

Description	Recommended current range	Type	Order code	Pkg qty	Weight (1 pce) kg
Current transformer	60...185 A AC	CT4L185R/4	<a href="#">1SAJ929500R0185</a>	1	1.600
Current transformer	180...310 A AC	CT4L310R/4	<a href="#">1SAJ929500R0310</a>	1	1.500
Current transformer	300...500 A AC	CT5L500R/4	<a href="#">1SAJ929501R0500</a>	1	1.700
Current transformer	500...850 A AC	CT5L850R/4	<a href="#">1SAJ929501R0850</a>	1	1.900

UMC100-FBP.0 and FBP system accessories are being phased out. Please contact your local ABB contact for spare parts or retrofit solutions.

# Universal Motor Controller UMC100.3

## Technical data

### Control voltage circuit

Type	UMC100.3 DC	UMC100.3UC
Supply voltage	24 V DC (+30 % ... -20 %) (19,2 ... 31,2 V DC) including ripple	110V - 240V AC/DC -15% / +10%
Total power dissipation Conditions: all digital inputs high, all relay outputs activated*	min. 3 W	min P: 3.5 W / S: 8 W
Reverse polarity protection	yes	not relevant

### Controller unit

LEDs	Red: Motor has been tripped due to a thermal overload condition or another fault Yellow: Motor is running Green: Ready for operation
------	--

### Digital inputs

Number of digital inputs	6 (DI0 ... DI5) Type 1 accord. to EN 61131-2
Supply for digital inputs	24 V DC
Isolation	No
Input signal bounce suppression	Typ. 2 ms
Signal 0 range including ripple	-31.2 ... +5 V
Signal 1 range including ripple	+15 ... +31.2 V
Input current per channel (24 V DC)	Typ. 6.0 mA
Input resistor to 0 V	3.9 k $\Omega$
Cable length	Unshielded max. 600 m Shielded max. 1000 m

### Relay outputs

Number of relay outputs	3 x monostable with one common root
Voltage range of contacts	12-250 V AC/DC
Lowest switched power for correct signals	1 W or 1 VA
Switching capacity per relay contact according to EN 60947-5-1 (electromagnetic load)	AC-15 240 V AC max. 1.5 A AC-15 120 V AC max. 3 A DC-13 250 V DC max. 0.11 A DC-13 25 V DC max. 0.22 A DC-13 24 V DC max. 1 A
Short circuit protection	6 A gG
Rated impulse withstand voltage $U_{imp}$	4 kV
Switching of inductive power	Inductive loads need additional measures for spark suppression Diodes for DC voltage and varistors / RC elements for AC voltage are suitable Some DC coil contactors contain rectifiers which suppress sparks perfectly
Relay contact service life	Mechanical 500 000 switching cycles Electrical (250 V AC): 0.5 A; 100 000 cycles 1.5 A 50 000 switching
Internal clearance and creepage distances relay contacts to 24 V circuits	> 5.5 mm (safety insulation up to 250 V AC) (EN 60947-1, Pollution degree 2)
Pollution degree terminals	3
Supply power down/up, behaviour: Valid for all motor control functions, except transparent and overload relay	Whenever the supply voltage of the UMC is switched off and on, the starting of the motor needs a new RUN signal

\*Please refer to the product manual for more detailed information.

# Universal Motor Controller UMC100.3

## Technical data

### Transistor output

Type	UMC100.3 DC	UMC100.3 UC
Max. output current	200 mA	50 mA
Short circuit protected	Yes	Yes
Output voltage if high	UMC100.3 supply voltage, nominal 24 V DC	nominal 24 V DC
Isolation	No	Yes, to AC mains

### Thermistor motor protection (PTC - binary) type A

Broken wire resistance	> 4.8 k $\Omega$
Voltage at broken wires between terminals T1/T2	12 V DC (typ.)
Response resistance	3.4-3.8 k $\Omega$
Reset resistance	1.5-1.65 k $\Omega$
Short circuit resistance	< 21 $\Omega$
Current at short circuit conditions	1.5 mA (typ.)
Response time	800 ms
Max. cold resistance of PTC sensor chain	< 1.5 k $\Omega$
Line length	2.5 mm <sup>2</sup> : 2 x 250 m 1.5 mm <sup>2</sup> : 2 x 150 m 0.5 mm <sup>2</sup> : 2 x 50 m
Isolation	No

### Environmental and mechanical data

Type	UMC100.3 DC	UMC100.3 UC
Mounting	On DIN-rail (EN 50022-35) or with four screws M4	
Mounting position	Any	
Dimensions (W x H x D)	70 x 105 x 106 mm	
Net weight	0.3 kg	0.35 kg
Tightening torque	$\varnothing$ 3.5 mm / 0.138 in ; 0.5 Nm, 4.5 in.lb	
Wire size with wire end ferrule	1 x 0.2-2.5mm <sup>2</sup> (1 x 28 ... 12 AWG)	
Wire size with rigid	1 x 0.2-2.5mm <sup>2</sup> (1 x 28 ... 12 AWG)	
Tightening torque for screw mounting	0.8 Nm	
Degree of protection	IP20	
Temperature range storage	-25 ... +70 °C	
Temperature range operation	0 ... +60 °C with two output relays activated	0 ... +60°C with two relay outputs activated and 24 V DC supply output loaded with 200 mA 0 ... +50°C with two relay outputs activated and 24 V DC supply output loaded with 400 mA

### Performance data

Reaction time UMC100 DI to UMC100 Relay Output (incl. hardware delays)	typ. 10 ms (Transparent Control Function)
Reaction time UMC100 DI to DX111 Relay Output (incl. hardware delays)	typ. 10 ms (Transparent Control Function)
Reaction time from DX111 DI to UMC100 Relay Output (incl. hardware delays)	typ. 14 ms (Transparent Control Function)
Number of supported function blocks	See 2CDC135014D02xx

## Digital expansion modules DX111-FBP.0, DX122-FBP.0

### Technical data

#### Digital inputs

Type	DX111-FBP.0	DX122-FBP.0
Number of inputs	Eight inputs in two groups of common reference potential (One group with five inputs, one group with three inputs) Insulation: Type 1 acc. to EN 61131-1	Eight inputs in two groups of common reference potential (One group with five inputs, one group with three inputs) Insulation: Type 2 acc. to EN 61131-1
Input voltage	24 V DC	110 V AC ... 240 V AC
Input delay	6 ms typ.	20 ms typ.
Signal levels	0 state - 31.2 ... + 5 V 1 state + 15 ... + 31.2 V	0 ... 40 V AC 74 ... 265 V AC
ON current per channel	6.0 mA typ. (24 V DC)	10.0 mA typ. (230 V AC)
Input resistance against 0 V	3.9 k $\Omega$	
Frequency range		45 ... 65 Hz

#### Digital output

Number of digital outputs	4 relay outputs with 2 common supplies (1DO0 & 1DO1 by 1DOC; 2DO2 & 2DO3 by 2DOC)
Voltage switching capacity	12 ... 250 V AC/DC
Load current via common	$I_{max} = 6 \text{ A gL} / \text{gG}$ per common supply (1DOC, 2DOC)
Minimum load for proper switching	1 W or 1 VA
Contact wiring for inductive load	Free-wheeling diode for direct current, varistors/VDRs for alternating current
Current switching capacity per relay	EN 60947-5-1
	240 V AC (AC-15) max. 1.5 A
	120 V AC (AC-15) max. 3 A
	250 V DC (DC-13) max. 0.11 A
	125 V DC (DC-13) max. 0.22 A
	24 V DC (DC-13) max. 1 A
Relay contact lifetime	> 500.000 switching cycles – mechanical, > 100.000 switching cycles – at 250 V AC, 0.5 A > 50.000 switching cycles – at 250 V AC, 1.5 A

#### Analog output

Number of analog outputs	1
Connection type	2-wire, for motor current indication on an external analog instrument
Output ranges	Configurable: 0/4 ... 20 mA or 0 ... 10 V
Cable specification	< 30 m outside the control cabinet; >30 m if shielded
Max. output voltage	10 V
Accuracy	< 5%
Output load	500 $\Omega$ max. if configured for 0/4 ... 20 mA output; 1 k $\Omega$ min. if configured for 0 ... 10 V output
Resolution	8 bits
Short-circuit detection	Yes, if configured for 0 ... 10 V output
Wire break detection	Yes, if configured for 4 ... 20 mA output
Insulation	none

#### Interfaces

Interface for I/O expansion	1 for connection to UMC100 and/or other expansion modules
Integrated diagnostic functions	Green LED: Device ready for operation, Yellow LED: Wire break or short circuit indication Red LED: Error (loss of communication, failure, ...)

## Digital expansion modules DX111-FBP.0, DX122-FBP.0

### Technical data

#### General data

Type	DX111-FBP.0	DX122-FBP.0
Supply voltage	24 V DC (+ 30%, – 20%) (19.2 ... 31.2 V DC incl. residual ripple)	
Conductor cross section	max. 2 x 0.75 - 2.5 mm <sup>2</sup>	
Mounting	Snap-on mounting on DIN rail, any mounting position	
Dimensions	45 x 77 x 100 mm (without communication plug)	
Weight	0.220 kg	
Degree of protection	IP20	
Temperature range	Storage: -25 ... +70 °C	Storage: -25 ... +70 °C
	Operation: 0 ... +60 °C	Operation: 0 ... +55 °C
Approvals	ATEX, CCC, CE, cUL, EAC (other approvals on request) Shipping ABS, DNV, GL	

## Voltage expansion modules VI150-FBP.0, VI155-FBP.0

### Technical data

Type	VI150-FBP.0	VI155-FBP.0
Application	only in grounded networks	in grounded and ungrounded networks

#### Electrical data

Type	VI150-FBP.0	VI155-FBP.0
Supply voltage	24 V DC (+ 30 %, - 20 %) (19.2 ... 31.2 V DC including ripple)	
Current consumption relay energized	max. 40 mA	max. 55 mA
Voltage input	L1, L2, L3	L1, L2, L3
Overvoltage category	III in grounded networks	
		II in ungrounded networks
Nominal voltage input range (phase to phase)	90 - 690 V AC	
$U_{imp}$	8 kV	
Accuracy voltage	+/- 2% in nominal input range	
Accuracy power factor	+/- 3.5 % in range 0.4 ... 0.95, I > 0.75 A	
Accuracy real power kW	+/- 5 % typ.	
Accuracy energy kWh	+/- 5 % typ.	
Total Harmonic Distortion THD	in %	
Rated operational voltage $U_e$	690 V AC	
Voltage supply cables	connection cables for voltage measurement may require additional cable protection	

#### Digital output

Number	1 relay output
Voltage switching capacity	12 ... 250 V AC/DC
Current switching capacity	EN 60947-5-1
	240 V AC (AC-15) max. 1.5 A
	120 V AC (AC-15) max. 3 A
	250 V DC (DC-13) max. 0.11 A
	125 V DC (DC-13) max. 0.22 A
	24 V DC (DC-13) max. 1 A
Minimum load for proper switching	1 W or 1 VA
Contact wiring for inductive load	Free-wheeling diode for DC, Varistors/VDRs for AC
Relay contact lifetime	> 500.000 switching cycles – mechanical > 100.000 switching cycles – at 250 V AC, 0.5 A > 50.000 switching cycles – at 250 V AC, 1.5 A

#### Interfaces

Interface for I/O expansion	1 for connection to UMC100.3 and/or other expansion modules
Integrated diagnostic functions	Green LED: Device ready Yellow LED: Diagnostics Red LED: Fault

#### General data

Type	VI150-FBP.0	VI155-FBP.0
Conductor cross section	2 x 0.75 - 2.5 mm <sup>2</sup> max.	
Mounting	Snap-on mounting on DIN-rail, any mounting position Min. 10 mm distance left and right to the L1 and L3 terminals required for voltages > 230 / 400 V	
Dimensions (W x H x D)	22.5 x 77 x 100 mm (excl. communication connector)	
Weight	0.110 kg	
Degree of protection	IP20	
Temperature range	Storage: - 25 ... + 70 °C, operation:: 0 ... + 60 °C	
Operation altitude above sea level	Max. 2000 m	Max. 4000 m without derating
Approvals	ATEX, CCC, CE, cUL,EAC (other approvals on request) Shipping: ABS, DNV, GL	

## Analog/temperature expansion module AI111.0

### Technical data

#### General

Type	AI111.0
Mounting	On DIN rail (EN 50022-35)
Mounting position	Any
Dimensions (W x H x D)	See dimensions of expansion modules
LEDs: Red/yellow/green	Red: Hardware error of module Yellow: Diagnosis available Green: Ready for operation
Supply voltage	24 V DC (+30 % ... -20 %) (19.2 ... 31.2 V DC) including ripple
Supply current	Max. 40 mA (at 19.2 ... 31.2 V DC)
Tightening torque for the communication terminals	See section DX1xx
Tightening torque for the input, output and supply terminals	See section DX1xx
Net weight	0.118 kg (0.260 lb)
Degree of protection	IP20
Temperature range	Storage -25 ... +70 °C Operation 0 ... +60 °C
Marks, Approvals	CE, cUL Further in preparation. Ask your local sales representative for other marks/approvals.
Functional isolation between analog inputs and 24 V DC supply / communication interface	Yes
Individual configuration of each analog input	Yes
U <sub>imp</sub> sensor analog inputs	0.5 kV
Pollution degree terminals	3
Operation altitude above sea level	Up to 5000 m

#### Temperature inputs

Type	AI111.0
Type of connection	2 or 3 wire
Number of input channels	3 (one AI111.0) / 6 (two AI111.0)
Type of temperature inputs (adjustable per channel)	PT100 -50 °C...+400 °C PT100 -50 °C...+70 °C PT1000 -50 °C...+400 °C KTY83-110 -50 °C...+175 °C KTY84-130 -40 °C...+300 °C NTC +80...+160 °C [B75227-K333-A1]
Accuracy at 20 °C (T20)	≤ ± 2 K
Temperature coefficient	0.1 K per K deviation from T20
Out of range detection	Yes
Max. cable length	Max. cable resistance: 50R (single wire) [e.g. with copper wire 1.5 mm <sup>2</sup> : 1900 m cable length]
Cable shielding	Recommended for up to 30 m and outside the switchgear cabinet; shielding mandatory for cables over 30 m
Update rate	Typ. 600 ms
Sensor current (typ.)	PT100 1 mA PT1000/KTY83/KTY84/NTC 0.2 mA

## Analog/temperature expansion module AI111.0

### Technical data

#### Analog inputs

Type	AI111.0
Number of inputs	3 (one AI111.0) / 6 (two AI111.0)
Type of analog inputs (adjustable)	0/4 mA - 20 mA / 0-10 V
Resolution	15 Bit

#### Measuring ranges

Type	AI111.0
0...20 mA and 0...10 V	0 .... 27648 dec (6C00 hex)
4...20 mA	0 .... 27648 dec (6C00 hex)
Max. input current for 0/4-20 mA	60 mA (destruction limit)
Accuracy at 20 °C (T20)	±1 % from full scale value
Temperature coefficient	0.05 / K deviation from T20
Input resistance	≤ 300 Ohm at 0/4 -20 mA ≥ 10 k Ohm at 0-10 V
Wire break detection	In operation mode: 4 mA - 20 mA
Cable shielding	Recommended for up to 30 m and outside the switchgear cabinet; shielding mandatory for cables over 30 m



## Fieldbus communication interfaces PDP32.0, MRP31.0, DNP31.0, PDR31.0

### Technical data

#### General data

Type	PDP32.0	MRP31.0	DNP31.0	PDR31.0
Supply voltage	24 V DC -20 ... +30% (19.2 ... 31.2 V DC) incl. ripple	24 V DC -20% / - 20% (19.2 ... 31.2 V DC) incl. ripple	24 V DC (11 ... 24,7 V DC) according to DeviceNet specification	24 V DC -20 ... +30% (19.2 ... 31.2 V DC) incl. ripple
Current consumption	55 mA (excl. load on 5 V supply for termination resistors)	Typ. 30 mA	Typ. 18.5 mA (from DeviceNet)	28 mA
Communication protocol	Profibus DP-V0/DP-V1	Modbus RTU	DeviceNet	Active Profibus DP termination
Certificate	Yes, PNO	-	Yes, ODVA	-
Fieldbus connection	9-pole Sub-D connector or terminal blocks	Removable 5-pole terminal blocks	Removable 5-pole terminal blocks	9-pole Sub-D connector or terminal blocks
Integrated termination resistors	No	No	No	Yes
Possible bus addresses (set via UMC100.3)	1 ... 125	1 ... 125	0 ... 63	-
Max. baud rate	12 MBit/s	57.6 kbaud	500 kbaud	-
Isolated +5 V supply available for bus termination circuitry (X3 pins 5 and 6)	30 mA max. -	-	-	-

#### Standards / directives

Type	PDP32.0	MRP31.0	DNP31.0	PDR31.0
EMC Directive	2014/30/EC	2014/30/EC	2014/30/EC	2014/30/EC
RoHS Directive	2011/65/EU	2011/65/EU	2011/65/EU	2011/65/EU

#### Environmental and mechanical data

Type	PDP32.0	MRP31.0	DNP31.0	PDR31.0
Mounting	On UMC100.3 or SMK3.0 adapter	On UMC100.3 or SMK3.0 adapter	On UMC100.3 or SMK3.0 adapter	On SMK3.0 adapter
Mounting position	Any	Any	Any	Any
Ambient air temperature	Operation	0 ... +60 °C	0 ... +60 °C	0 ... +60 °C
	Storage	-25 ... +70 °C	-25 ... +70 °C	-25 ... +70 °C
Vibration (sinusoidal) acc. to IEC/EN 60068-2-6 (Fc)	0.7 g / 10 .... 150 Hz	0.7 g / 10 .... 150 Hz	0.7 g / 10 .... 150 Hz	0.7 g / 10 .... 150 Hz
Shock (half-sine) acc. to IEC/EN 60068-2-27 (Ea)	15 g / 11 ms	15 g / 11 ms	15 g / 11 ms	15 g / 11 ms
Degree of protection	IP20	IP20	IP20	IP20
Pollution degree	3	3	3	3
Operation altitude above sea level	4000 m	4000 m	4000 m	4000 m
Duty cycle	100 %	100 %	100 %	100 %
Weight	0.051 kg	0.039 kg	0.042 kg	0.047 kg

## Ethernet communication interfaces MTQ22-FBP.0, PNQ22-FBP.0, EIU32.0

### Technical data

#### General data

Type	MTQ22-FBP.0	PNQ22-FBP.0	EIU32.0
Supply voltage	24 V DC -20 ... +30% (19.2 ... 31.2 V DC) incl. ripple	24 V DC -20 ... +30% (19.2 ... 31.2 V DC) incl. ripple	24 V DC -20 ... +30% (19.2 ... 31.2 V DC) incl. ripple
Current consumption	Max. 180 mA	Max. 180 mA	Typ 90 mA, max. 130 mA
Total power dissipation	Max. 3.5 W	Max. 3.5 W	Typ. 2.2 W, max. 2.5 W
Short circuit protection at port 1 ... 4	PTC resistor	Yes, PTC resistor	-
Connection between Ethernet interface and UMC100.3	Max. 3 m	Max. 3 m	Max. 3 m
Communication protocol	Modbus TCP	Profinet IO	EtherNet/IP™
Certificate	-	Yes, PNO	Yes, ODVA
Integrated Ethernet switch	Yes	Yes	-
Supported bit rates	10 / 100 Mbit/s	100 Mbit/s	10 / 100 Mbit/s
Network redundancy protocol	MRP client acc. to EN/IEC 62439-2	MRP client acc. to EN/IEC 62439-2	DLR (Device Level Ring)
USB port	For configuration via PC and software tool	Reserved	Reserved

#### Standards / directives

Type	MTQ22-FBP.0	PNQ22-FBP.0	EIU32.0
EMC Directive	2014/30/EC	2014/30/EC	2014/30/EU
RoHS Directive	2011/65/EU	2011/65/EU	2011/65/EU

#### Environmental and mechanical data

Type	MTQ22-FBP.0	PNQ22-FBP.0	EIU32.0
Mounting	DIN-rail	DIN-rail	Directly on the UMC100.3 or remotely on SMK3.0 adapter
Mounting position	Any	Any	Any
Ambient air temperature	Operation 0 ... +60 °C Storage -25 ... +70 °C	Operation 0 ... +60 °C Storage -25 ... +70 °C	Operation 0 ... +60 °C Storage -25 ... +70 °C
Dimensions (W x H x D)	45 mm x 90 mm x 96 mm	45 mm x 90 mm x 96 mm	42.5 mm x 64 mm x 96 mm
Vibration (sinusoidal) acc. to IEC/EN 60068-2-6 (Fc)	0.7 g / 10 ... 150 Hz	0.7 g / 10 ... 150 Hz	0.7 g / 10 ... 150 Hz (mounted on UMC100.3/SMK3.0)
Shock (half-sine) acc. to IEC/EN 60068-2-27 (Ea)	15 g / 11 ms	15 g / 11 ms	15 g / 11 ms
Degree of protection	IP20	IP20	IP20
Pollution degree	3	3	3
Operation altitude above sea level	2000 m	2000 m	2000 m
Duty cycle	100 %	100 %	100 %
Weight	0.172 kg	0.172 kg	0.110 kg

# Dimensional drawings

## Universal Motor Controller UMC100.3

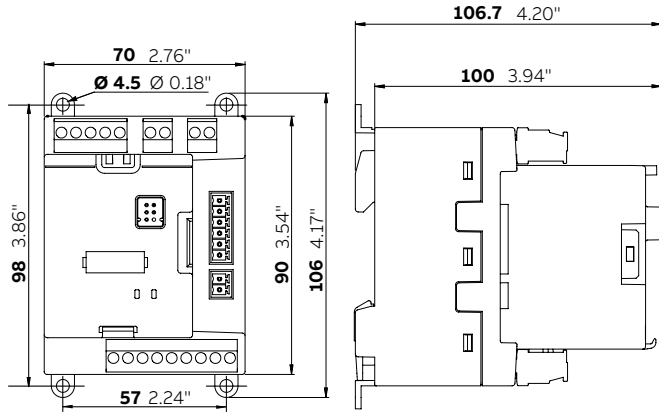

UMC100.3

## Expansion modules

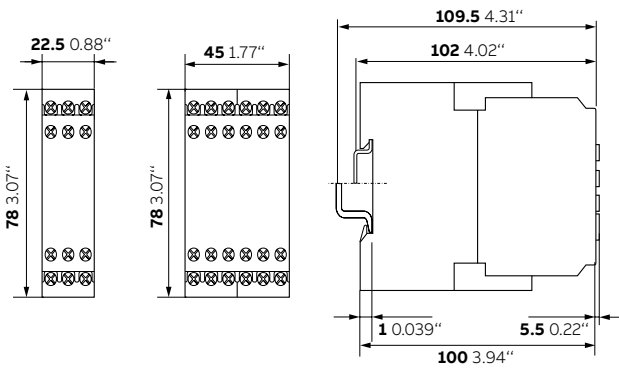

VI150-FBP.0  
VI155-FBP.0  
AI111.0

DX111-FBP.0,  
DX122-FBP.0

DX111-FBP.0, DX122-FBP.0  
VI150-FBP.0, VI155-FBP.0  
AI111.0

## Operating panel

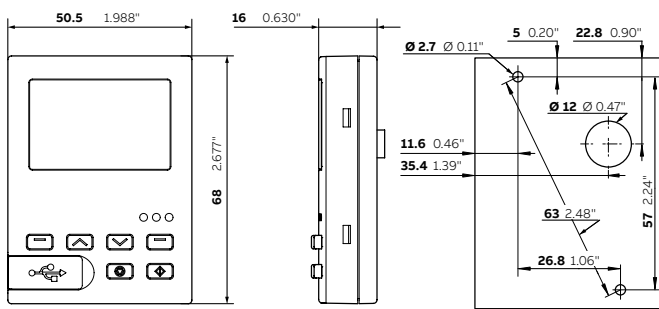

UMC100.3-PAN

UMC100.3-PAN  
drilling instruction

## Operating panel protection cap

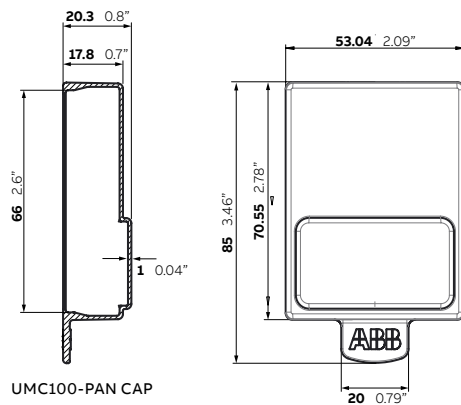

UMC100-PAN CAP

# Dimensional drawings

## Ethernet communication interfaces

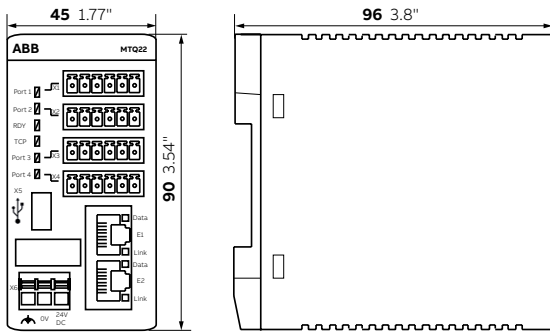

MTQ22-FBP.0  
 PNQ22-FBP.0

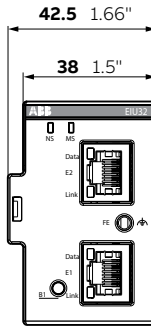

EIU32.0

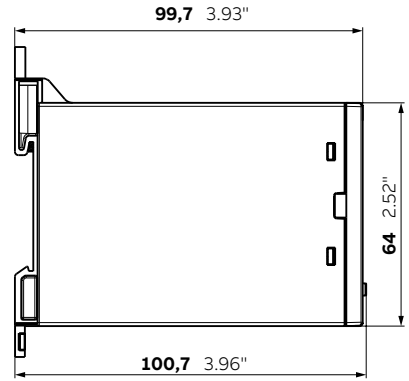

## Fieldbus communication interfaces

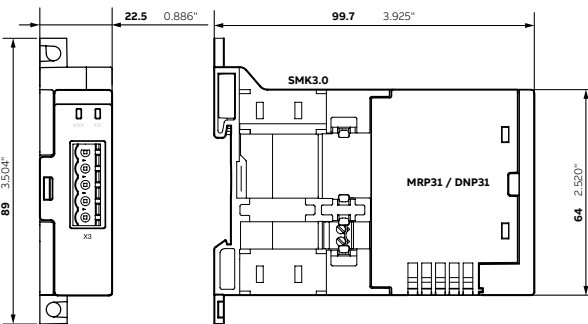

DNP31.0, MRP31.0, SMK3.0

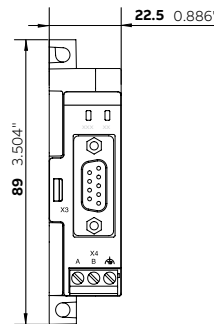

PDP32.0, PDR31.0

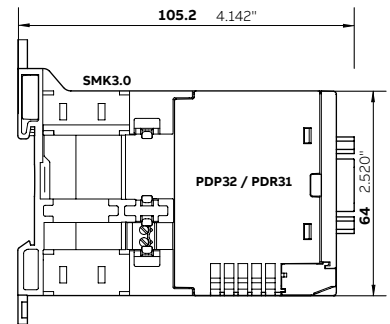

# Dimensional drawings

## Earth fault monitor

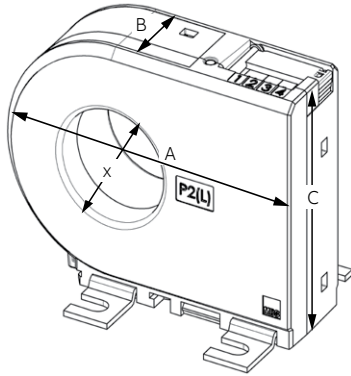

CEM11-FBP.xx

Type	Width (A)	Depth (B)	Height (C)	Ø
CEM11-FBP.20	76.4 (3.01)	30 (1.18)	56 (2.20)	20 (0.79)
CEM11-FBP.35	99.5 (1.38)	30 (1.18)	79 (3.11)	35 (1.38)
CEM11-FBP.60	135 (5.31)	38 (1.46)	116 (4.57)	60 (2.36)
CEM11-FBP.120	210 (8.27)	38 (1.46)	190 (7.48)	120 (4.72)

## Current transformer

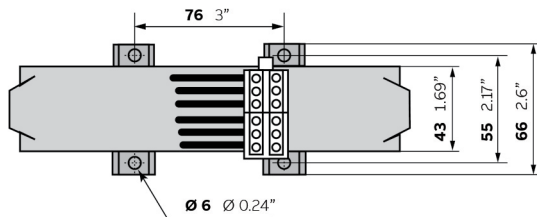
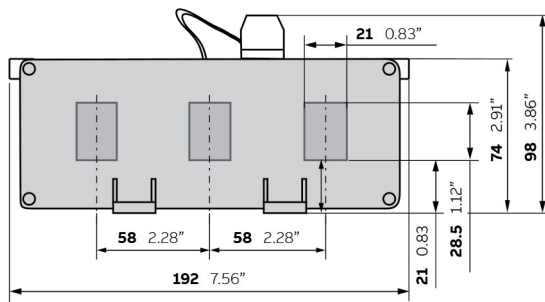

CT4L185R/4, CT4L310R/4

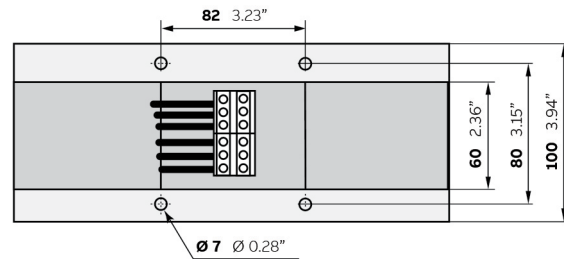
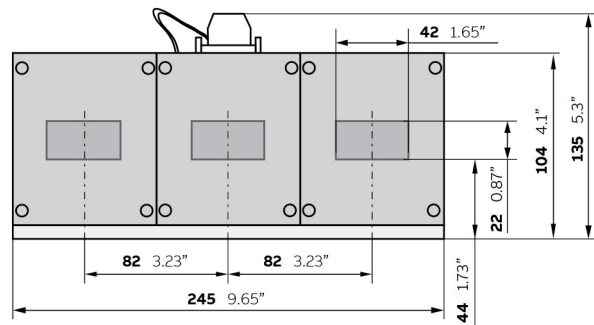

CT5L500R/4, CT5L850R/4

—  
**Notes**

A large rectangular area filled with a grid of small, light gray dotted lines, intended for handwritten notes.



**For direct product details information, use product type or order code, ex:**

[www.abb.com/productdetails/AF09-30-10-13](http://www.abb.com/productdetails/AF09-30-10-13)  
or  
[www.abb.com/productdetails/1SBL137001R1310](http://www.abb.com/productdetails/1SBL137001R1310)

---

# Customer made Motor starting solution

- 12/2 Motor rated operational powers and currents**
- 12/3 Customer assembled motor starting solutions**
  - DOL and reversing starters protected by manual motor starters**
  - 12/4 General
  - 12/6 Selection tables
  - 12/10 Wiring diagrams
  - 12/11 Main dimensions
  - DOL starters protected by moulded-case circuit-breakers and overload relays**
  - 12/18 General
  - 12/20 Selection tables
  - 12/24 Wiring diagrams
  - Main dimensions, starter protected by**
  - 12/25 MCCB including motor protection
  - 12/27 MCCB (magnetic only) and thermal overload relays
  - 12/30 MCCB (magnetic only) and electronic overload relays
  - DOL and reversing starters protected by overload relays**
  - 12/34 General
  - 12/36 Selection tables
  - 12/40 Switching frequency diagrams for overload relays
  - 12/41 Wiring diagrams
  - Main dimensions, starter protected by**
  - 12/42 Thermal overload relays



# Motor rated operational powers and currents

The currents given below concern standard three-phase four-pole cage motors (1500 r.p.m. at 50 Hz 1800 r.p.m. at 60 Hz). These values are given for guidance and may vary according to the motor manufacturer and depending on the number of poles.

IEC Motor power	Motor nominal current: standardized values in grey (according to IEC 60947-4-1 Annex G)									
	220 V	230 V	240 V	380 V	400 V	415 V	440 V	500 V	660 V	690 V
kW	A	A	A	A	A	A	A	A	A	A
0.06	0.37	0.35	0.34	0.21	0.2	0.19	0.18	0.16	0.13	0.12
0.09	0.54	0.52	0.50	0.32	0.3	0.29	0.26	0.24	0.18	0.17
0.12	0.73	0.7	0.67	0.46	0.44	0.42	0.39	0.32	0.24	0.23
0.18	1	1	1	0.63	0.6	0.58	0.53	0.48	0.37	0.35
0.25	1.6	1.5	1.4	0.9	0.85	0.82	0.74	0.68	0.51	0.49
0.37	2.0	1.9	1.8	1.2	1.1	1.1	1	0.88	0.67	0.64
0.55	2.7	2.6	2.5	1.6	1.5	1.4	1.3	1.2	0.91	0.87
0.75	3.5	3.3	3.2	2.0	1.9	1.8	1.7	1.5	1.15	1.1
1.1	4.9	4.7	4.5	2.8	2.7	2.6	2.4	2.2	1.7	1.6
1.5	6.6	6.3	6	3.8	3.6	3.5	3.2	2.9	2.2	2.1
2.2	8.9	8.5	8.1	5.2	4.9	4.7	4.3	3.9	2.9	2.8
3	11.8	11.3	10.8	6.8	6.5	6.3	5.7	5.2	4	3.8
4	15.7	15	14.4	8.9	8.5	8.2	7.4	6.8	5.1	4.9
5.5	20.9	20	19.2	12.1	11.5	11.1	10.1	9.2	7	6.7
7.5	28.2	27	25.9	16.3	15.5	14.9	13.6	12.4	9.3	8.9
11	39.7	38	36.4	23.2	22	21.2	19.3	17.6	13.4	12.8
15	53.3	51	48.9	30.5	29	28	25.4	23	17.8	17
18.5	63.8	61	58.5	36.8	35	33.7	30.7	28	22	21
22	75.3	72	69	43.2	41	39.5	35.9	33	25.1	24
30	100	96	92	57.9	55	53	48.2	44	33.5	32
37	120	115	110	69	66	64	58	53	40.8	39
45	146	140	134	84	80	77	70	64	49.1	47
55	177	169	162	102	97	93	85	78	59.6	57
75	240	230	220	139	132	127	116	106	81	77
90	291	278	266	168	160	154	140	128	97	93
110	355	340	326	205	195	188	171	156	118	113
132	418	400	383	242	230	222	202	184	140	134
160	509	487	467	295	280	270	245	224	169	162
200	637	609	584	368	350	337	307	280	212	203
250	782	748	717	453	430	414	377	344	261	250
315	983	940	901	568	540	520	473	432	327	313
355	1109	1061	1017	642	610	588	535	488	370	354
400	1255	1200	1150	726	690	665	605	552	418	400
500	1545	1478	1416	895	850	819	745	680	515	493
560	1727	1652	1583	1000	950	916	832	760	576	551
630	1928	1844	1767	1116	1060	1022	929	848	643	615
710	2164	2070	1984	1253	1190	1147	1043	952	721	690
800	2446	2340	2243	1417	1346	1297	1179	1076	815	780
900	2760	2640	2530	1598	1518	1463	1330	1214	920	880
1000	3042	2910	2789	1761	1673	1613	1466	1339	1014	970

UL/CSA Motor power	Motor nominal current: single and three phase (according to UL 60947-4-1A)									
	120 V 1-ph	200 V 1-ph	200 V 3-ph	208 V 1-ph	208 V 3-ph	220- 240 V 1-ph	220- 240 V 3-ph	380- 415 V 3-ph	440- 480 V 3-ph	550- 600 V 3-ph
hp	A	A	A	A	A	A	A	A	A	A
1/10	3	-	-	-	-	1.5	-	-	-	-
1/8	3.8	-	-	-	-	1.9	-	-	-	-
1/6	4.4	2.5	-	2.4	-	2.2	-	-	-	-
1/4	5.8	3.3	-	3.2	-	2.9	-	-	-	-
1/3	7.2	4.1	-	4	-	3.6	-	-	-	-
1/2	9.8	5.6	2.5	5.4	2.4	4.9	2.2	1.3	1.1	0.9
3/4	13.8	7.9	3.7	7.6	3.5	6.9	3.2	1.8	1.6	1.3
1	16	9.2	4.8	8.8	4.6	8	4.2	2.3	2.1	1.7
1-1/2	20	11.5	6.9	11	6.6	10	6	3.3	3	2.4
2	24	13.8	7.8	13.2	7.5	12	6.8	4.3	3.4	2.7
3	34	19.6	11	18.7	10.6	17	9.6	6.1	4.8	3.9
5	56	32.2	17.5	30.8	16.7	28	15.2	9.7	7.6	6.1
7-1/2	80	46	25.3	44	24.2	40	22	14	11	9
10	100	57.5	32.2	55	30.8	50	28	18	14	11
15	135	-	48.3	-	46.2	68	42	27	21	17
20	-	-	62.1	-	59.4	88	54	34	27	22
25	-	-	78.2	-	74.8	110	68	44	34	27
30	-	-	92	-	88	136	80	51	40	32
40	-	-	120	-	114	176	104	66	52	41
50	-	-	150	-	143	216	130	83	65	52
60	-	-	177	-	169	-	154	103	77	62
75	-	-	221	-	211	-	192	128	96	77
100	-	-	285	-	273	-	248	165	124	99
125	-	-	359	-	343	-	312	208	156	125
150	-	-	414	-	396	-	360	240	180	144
200	-	-	552	-	528	-	480	320	240	192
250	-	-	-	-	-	-	604	403	302	242
300	-	-	-	-	-	-	722	482	361	289
350	-	-	-	-	-	-	828	560	414	336
400	-	-	-	-	-	-	954	636	477	382
450	-	-	-	-	-	-	1030	-	515	412
500	-	-	-	-	-	-	1180	786	590	472

## Customer assembled motor starting solutions

### ABB Expertise

ABB has acquired years of experience with respect to problems of coordination and is able to make a complete offer based on tests performed in its qualified laboratories. This offer covers 400 V AC, 500 V AC, 690 V AC networks.

A complete database of coordination tables, according to IEC 60947-4-1 (EN 60947-4-1), and UL 60947-4-1 between the branch circuit protective device and the motor starter is available on the ABB Website.

In the coordination tables the following short-circuit protection devices are recommended:

- Case circuit-breakers (MCCBs)
- Miniature circuit-breakers (MCBs)
- Switch-disconnector-fuses (aM, gG and BS)
- Manual motor starters (MMS).

### Select Optimized Coordination tool (SOC)

Selected Optimized Coordination is a web tool for the selection of ABB products to be used in the following applications:

- Motor starting and protection
- Selectivity between protection devices
- Back-up protection
- Other devices protection.

In order to guarantee the best performance and the longest lifetime, devices involved into the applications mentioned above (short-circuit protection devices, contactors, overload relays, softstarters, ...) need to be coordinated.

- The coordination among devices cannot be determined directly: tests in power laboratories shall be carried out to qualify the coordination type at low fault and high fault currents, according to IEC or UL standards.
- ABB coordination tables are the results of such tests and represent the ABB offerings in terms of motor starting and protection, selectivity, back-up and switch-disconnector protection.
- In Selected Optimized Coordination all available ABB coordination tables are stored and easily accessible.

### Website access:

<http://applications.it.abb.com/SOC/Page/Selection.aspx>

### How to combine assemble and wire starter components

The section "customer assembled motor starting solutions" in this catalog gives the components lists and wiring diagrams to assemble the most typical motor starting solutions.

It covers direct-on-line Starters, reversing starters or star-delta starters protected with manual motor starters or with thermal overload relays for Type I or type II coordination for normal starting time.

Note:

In order to confirm your starter combination ratings according to ABB's latest coordination test results, or to see other coordination of components please refer to the above mentioned SOC tool. SOC tool get constant updates and additions

### General remarks applicable to all tables

- Each table is defined for a maximum ambient temperature of 40 °C. For higher temperatures, apply a derating factor according to the following rules:
- Fuses: factor of 0.8 applied to In for an ambient temperature of 70 °C
- MCCBs and MCBs: factor of 0.8 applied to In for an ambient temperature of 60 °C
- The starter derating factor depends on the operating conditions of thermal overload relays:
- Factor of 0.9 applied to In for an ambient temperature of 70 °C.
- Each table is defined for motor currents: 3-phase motors, 4-pole
- Normal starting means a starting time < 2 s. - Difficult starting means an accelerating time 10 s < ts < 30 s
- Tripping classes of thermal overload relays according to IEC 60947-4-1 (EN 60947-4-1): 10A and 10
- Tripping classes of electronic overload relays according to IEC 60947-4-1 (EN 60947-4-1): 10E, 20E, 30E selectable
- In the tables with MCCBs, these are fitted with the magnetic relay alone. Setting is always carried out at > 12.3 le AC-3 so that the transient current peak occurring during starting does not lead to tripping.

# DOL and reversing starters protected by manual motor starters

With AF contactors - open type version in kit form

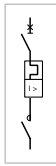

DOL starter  
MS132-10 + BEA16-4 + AF09-30-10

### Application

Full voltage direct-on-line (DOL) starting and reversing starting for controlling three-phase asynchronous motors is a simple and economic solution characterised by a high starting torque (1.9 to 2.1 times full-speed torque) and a starting current 5.5 to 7 times nominal current.

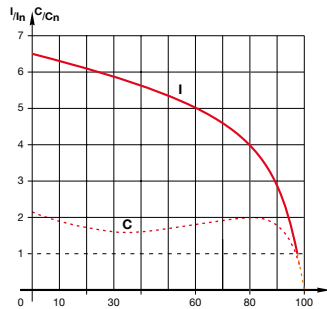

I = current  
C = torque  
In = nominal current  
Cn = nominal torque

### Coordination types

The contactor and the manual motor starter control and protect motors against overload and short-circuits according to coordination types 1 and 2 (IEC 60947-4-1 / EN 60947-4-1) defining the anticipated level of service continuity as follow:

**Type 1:** In short-circuit conditions, the contactor or starter does not endanger persons or installations and will not be able to then operate without being repaired or having parts replaced.

**Type 2:** In short-circuit conditions, the contactor or starter does not endanger persons or installations and will be able to operate afterwards. The risk of contacts light welding is acceptable.

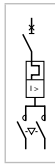

Reversing starter  
MS132-10 + BEA16-4 + BER16-4  
+ VEM4 + AF09-30-10

### Main Technical Data

Standards	IEC 60947-4-1 / EN 60947-4-1	
Rated operational voltage Ue max.	690 V - 50/60 Hz	
Rated insulation voltage Ui	690 V	
acc. to IEC 60947-4-1	690 V	
acc. to UL / CSA	600 V	
Switching frequency	≤ 15 starts/hour - 80 % max. load factor - with max. 1.5 s starting time	
	≤ 30 starts/hour - 50 % max. load factor - with max. 1.5 s starting time	
Ambient air temperature		
Close to the device	use with MS116	≤ 55 °C
	use with MS132, MS165, MS495	≤ 60 °C
Degree of protection	IP20	

### Mounting positions

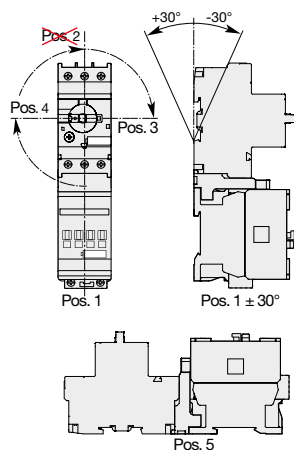

DOL starters

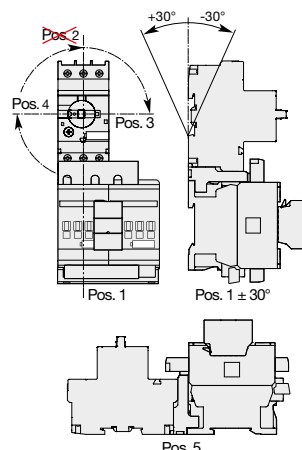

Reversing starters

## DOL and reversing starters protected by manual motor starters

With AF contactors - open type version in kit form

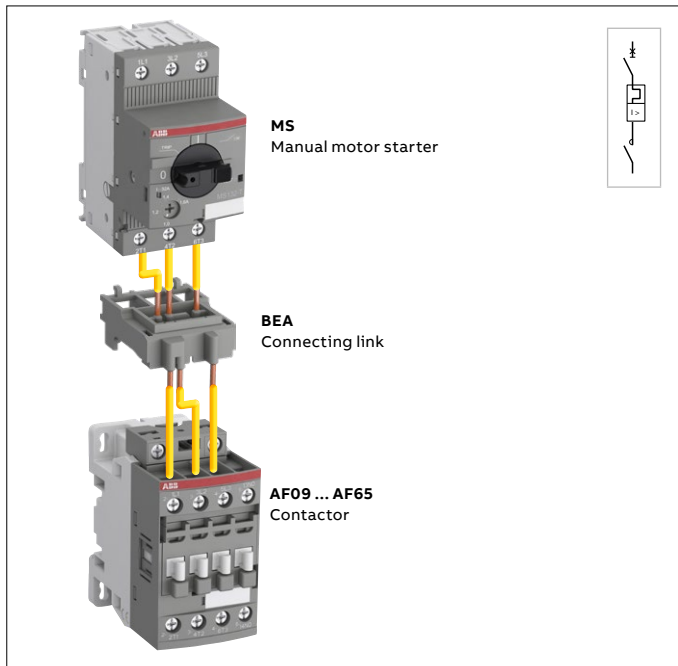

### Direct-on-line starters

You can easily assemble a direct-on-line starter by using the BEA...-4 connecting link 3-pole insulated. It is used to electrically and mechanically connect MS116, MS132 or MS165 manual motor starter and AF09 ... AF65 contactor, AC or DC operated.

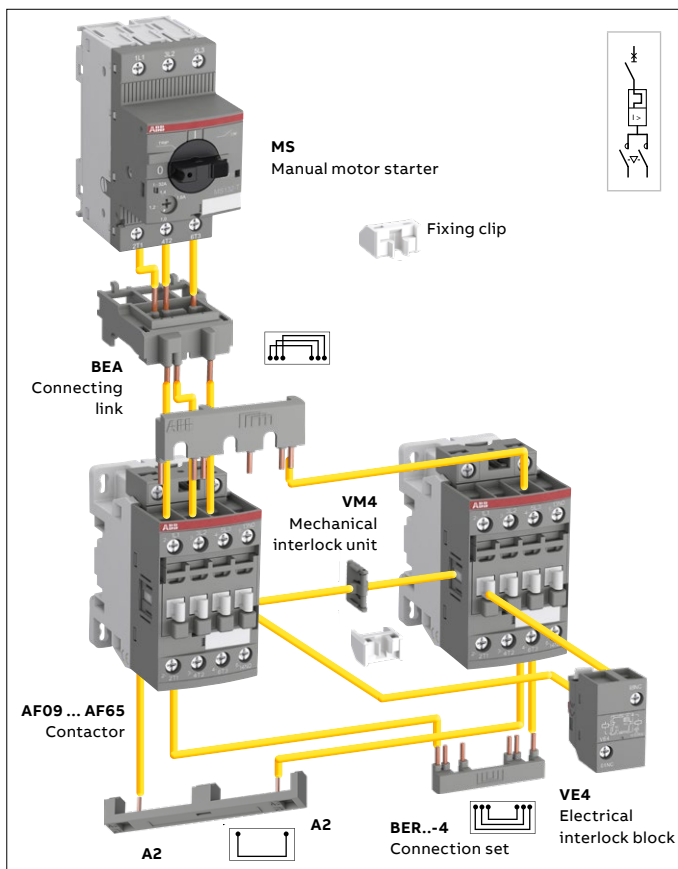

### Reversing starters

You can easily assemble reversing starter thanks to our complete range of accessories:

- BEA...-4 connecting link 3-pole insulated: it is used to electrically and mechanically connect MS116, MS132 or MS165 manual motor starter and AF09 ... AF65 contactor, AC or DC operated
- For AF09 ... AF38, use VEM4 mechanical and electrical interlock set for reversing starter in 90 mm width. It includes:
  - VM4 mechanical interlock unit including 2 fixing clips
  - VE4 electrical interlock block with A2-A2 connection.
- For AF40 ... AF96, use VM96-4 mechanical interlock unit and additional auxiliary contact blocks for electrical interlocking
- BER...-4 connection set: it assures a safe and simple reversing connection between both contactor main terminals.

Note: for direct mounting on 2 rails 35 mm of MS165 manual motor starter with AF40 ... AF65 contactors, BEA65-4 connecting link must be associated with BPR65-4 35 mm rail hook fixed on each contactor base. Starter combination using BPR65-4 are applicable for MS165 manufactured after week 31, 2016 (date code > 16214).



Select now easily and quickly your starter in the following pages for coordination type 1 or 2 at 400 V, 50/60 Hz, Iq = 16 kA up to 18.5 kW and Iq = 50 kA up to 45 kW.

For the full coordination tables, please visit our SOC tool : <https://applications.it.abb.com/SOC/Selectivity>

# DOL starters protected by MS manual motor starters

## Coordination type 1

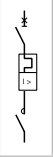
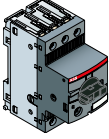
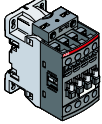
### Coordination type 1, AC-3, 16 kA or 50 kA, 400 V, 50/60 Hz



		Manual motor starters				Contactors				Accessories	
										 	
IEC AC-3, 400 V Rated operational power kW	Type (1)	Order code	Current setting range A	Magnetic tripping current A	Rated control circuit voltage Uc min. ... Uc max. (2)		Type (3)	Order code	Allowed setting current A	Type	Order code
					V 50/60 Hz	V DC					
0.06	0.2	MS132-0.25 1SAM350000R1002	0.16...0.25	2.44	24...60	20...60 (5)	AF09Z-30-10-11	1SBL136001R1110	0.25	BEA16-4	1SBN081306T1000
					100...250	100...250	AF09-30-10-13	1SBL137001R1310			
0.09	0.3	MS132-0.4 1SAM350000R1003	0.25...0.40	3.9	24...60	20...60 (5)	AF09Z-30-10-11	1SBL136001R1110	0.4		
					100...250	100...250	AF09-30-10-13	1SBL137001R1310			
0.12	0.44	MS132-0.63 1SAM350000R1004	0.40...0.63	6.14	24...60	20...60	AF09Z-30-10-11	1SBL136001R1110	0.63		
					100...250	100...250	AF09-30-10-13	1SBL137001R1310			
0.18	0.6	MS132-0.63 1SAM350000R1004	0.40...0.63	6.14	24...60	20...60	AF09Z-30-10-11	1SBL136001R1110	0.63		
					100...250	100...250	AF09-30-10-13	1SBL137001R1310			
0.25	0.85	MS132-1.0 1SAM350000R1005	0.63...1.00	11.5	24...60	20...60	AF09Z-30-10-11	1SBL136001R1110	1		
					100...250	100...250	AF09-30-10-13	1SBL137001R1310			
0.37	1.1	MS132-1.6 1SAM350000R1006	1.00...1.60	18.4	24...60	20...60	AF09Z-30-10-11	1SBL136001R1110	1.6		
					100...250	100...250	AF09-30-10-13	1SBL137001R1310			
0.55	1.5	MS132-1.6 1SAM350000R1006	1.00...1.60	18.4	24...60	20...60	AF09Z-30-10-11	1SBL136001R1110	1.6		
					100...250	100...250	AF09-30-10-13	1SBL137001R1310			
0.75	1.9	MS132-2.5 1SAM350000R1007	1.60...2.50	28.75	24...60	20...60	AF09Z-30-10-11	1SBL136001R1110	2.5		
					100...250	100...250	AF09-30-10-13	1SBL137001R1310			
1.1	2.7	MS132-4.0 1SAM350000R1008	2.50...4.00	50	24...60	20...60	AF09Z-30-10-11	1SBL136001R1110	4		
					100...250	100...250	AF09-30-10-13	1SBL137001R1310			
1.5	3.6	MS132-4.0 1SAM350000R1008	2.50...4.00	50	24...60	20...60	AF09Z-30-10-11	1SBL136001R1110	4		
					100...250	100...250	AF09-30-10-13	1SBL137001R1310			
2.2	4.9	MS132-6.3 1SAM350000R1009	4.00...6.30	78.75	24...60	20...60	AF09Z-30-10-11	1SBL136001R1110	6.3		
					100...250	100...250	AF09-30-10-13	1SBL137001R1310			
3	6.5	MS132-10 1SAM350000R1010	6.30...10.0	150	24...60	20...60	AF09Z-30-10-11	1SBL136001R1110	9		
					100...250	100...250	AF09-30-10-13	1SBL137001R1310			
4	8.5	MS132-10 1SAM350000R1010	6.30...10.0	150	24...60	20...60	AF09Z-30-10-11	1SBL136001R1110	9		
					100...250	100...250	AF09-30-10-13	1SBL137001R1310			
5.5	11.5	MS132-12 1SAM350000R1012	8.00...12.0	180	24...60	20...60	AF12Z-30-10-11	1SBL156001R1110	12		
					100...250	100...250	AF12-30-10-13	1SBL157001R1310			
7.5	15.5	MS132-16 1SAM350000R1011	10.0...16.0	240	24...60	20...60	AF16Z-30-10-11	1SBL176001R1110	16		
					100...250	100...250	AF16-30-10-13	1SBL177001R1310			
11	22	MS132-25 1SAM350000R1014	20.0...25.0	375	24...60	20...60	AF26Z-30-00-11	1SBL236001R1100	25		
					100...250	100...250	AF26-30-00-13	1SBL237001R1300			
15	29	MS132-32 1SAM350000R1015	25.0...32.0	480	24...60	20...60	AF30Z-30-00-11	1SBL276001R1100	32		
					100...250	100...250	AF30-30-00-13	1SBL277001R1300			
18.5	35	MS165-42 1SAM451000R1015	30.0...42.0	630	24...60	20...60	AF40-30-00-11	1SBL347001R1100	40		
					100...250	100...250	AF40-30-00-13	1SBL347001R1300			
22	41	MS165-54 1SAM451000R1016	40.0...54.0	810	24...60	20...60	AF52-30-00-11	1SBL367001R1100	53		
					100...250	100...250	AF52-30-00-13	1SBL367001R1300			
30	55	MS165-65 1SAM451000R1017	52.0...65.0	975	24...60	20...60	AF65-30-00-11	1SBL387001R1100	65		
					100...250	100...250	AF65-30-00-13	1SBL387001R1300			
37	66	MS495-75 1SAM550000R1008	57.0...75.0	975	24...60	20...60	AF80-30-00-11	1SBL397001R1100	75		
					100...250	100...250	AF80-30-00-13	1SBL397001R1300			
45	80	MS495-90 1SAM550000R1009	70.0...90.0	1170	24...60	20...60	AF96-30-00-11	1SBL407001R1100	90		
					100...250	100...250	AF96-30-00-13	1SBL407001R1300			

(1) MS116 manual motor starter can be selected according to the current setting range indicated on the coordination line, up to:  
 - 15 kW, 400 V - AC-3 at 16 kA  
 - 4 kW, 400 V - AC-3 at 50 kA.  
 (2) For other control voltages, see "Voltage code table".  
 (3) AF38 3-pole contactor can be selected for coordination type 1, 16 kA and 50 kA, 18.5 kW, 400 V - AC-3 (BEA65-4 available for AF40 ... AF65 only).  
 (4) For direct mounting on 2 rails 35 mm of MS165 with AF40 ... AF65: BEA65-4 must be associated with BPR65-4 fixed on contactor base. Applicable for MS165 manufactured after week 31, 2016 (date code > 16114).  
 (5) AF ... -11 not suitable for direct control by PLC-output.

# DOL starters protected by MS manual motor starters

## Coordination type 2

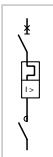
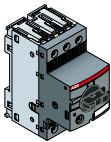
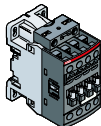
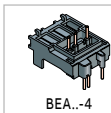
### Coordination type 2, AC-3, 16 kA or 50 kA, 400 V, 50/60 Hz

		Manual motor starters				Contactors				Accessories	
										 	
IEC AC-3, 400 V Rated operational power current	Type (1)	Order code	Current setting range	Magnetic tripping current	Rated control circuit voltage		Type (3)	Order code	Allowed setting current	Type	Order code
					Uc min. ... Uc max. (2)						
kW	A		A	A	V 50/60 Hz	V DC (6)			A		
0.06	0.2	MS132-0.25 1SAM350000R1002	0.16...0.25	2.44	24...60	20...60	AF09Z-30-10-11	1SBL136001R1110	0.25	BEA16-4	1SBN081306T1000
					100...250	100...250	AF09-30-10-13	1SBL137001R1310			
0.09	0.3	MS132-0.4 1SAM350000R1003	0.25...0.40	3.9	24...60	20...60	AF09Z-30-10-11	1SBL136001R1110	0.4		
					100...250	100...250	AF09-30-10-13	1SBL137001R1310			
0.12	0.44	MS132-0.63 1SAM350000R1004	0.40...0.63	6.14	24...60	20...60	AF09Z-30-10-11	1SBL136001R1110	0.63		
					100...250	100...250	AF09-30-10-13	1SBL137001R1310			
0.18	0.6	MS132-0.63 1SAM350000R1004	0.40...0.63	6.14	24...60	20...60	AF09Z-30-10-11	1SBL136001R1110	0.63		
					100...250	100...250	AF09-30-10-13	1SBL137001R1310			
0.25	0.85	MS132-1.0 1SAM350000R1005	0.63...1.00	11.5	24...60	20...60	AF09Z-30-10-11	1SBL136001R1110	1		
					100...250	100...250	AF09-30-10-13	1SBL137001R1310			
0.37	1.1	MS132-1.6 1SAM350000R1006	1.00...1.60	18.4	24...60	20...60	AF09Z-30-10-11	1SBL136001R1110	1.6		
					100...250	100...250	AF09-30-10-13	1SBL137001R1310			
0.55	1.5	MS132-1.6 1SAM350000R1006	1.00...1.60	18.4	24...60	20...60	AF09Z-30-10-11	1SBL136001R1110	1.6		
					100...250	100...250	AF09-30-10-13	1SBL137001R1310			
0.75	1.9	MS132-2.5 1SAM350000R1007	1.60...2.50	28.75	24...60	20...60	AF09Z-30-10-11	1SBL136001R1110	2.5		
					100...250	100...250	AF09-30-10-13	1SBL137001R1310			
1.1	2.7	MS132-4.0 1SAM350000R1008	2.50...4.00	50	24...60	20...60	AF26Z-30-00-11	1SBL236001R1100	4	BEA26-4 + CA4-10	1SBN082306T1000 1SBN010110R1010
					100...250	100...250	AF26-30-00-13	1SBL237001R1300			
1.5	3.6	MS132-4.0 1SAM350000R1008	2.50...4.00	50	24...60	20...60	AF26Z-30-00-11	1SBL236001R1100	4		
					100...250	100...250	AF26-30-00-13	1SBL237001R1300			
2.2	4.9	MS132-6.3 1SAM350000R1009	4.00...6.30	78.75	24...60	20...60	AF26Z-30-00-11	1SBL236001R1100	6.3		
					100...250	100...250	AF26-30-00-13	1SBL237001R1300			
3	6.5	MS132-10 1SAM350000R1010	6.30...10.0	150	24...60	20...60	AF26Z-30-00-11	1SBL236001R1100	10		
					100...250	100...250	AF26-30-00-13	1SBL237001R1300			
4	8.5	MS132-10 1SAM350000R1010	6.30...10.0	150	24...60	20...60	AF26Z-30-00-11	1SBL236001R1100	10		
					100...250	100...250	AF26-30-00-13	1SBL237001R1300			
5.5	11.5	MS132-12 1SAM350000R1012	8.00...12.0	180	24...60	20...60	AF26Z-30-00-11	1SBL236001R1100	12	BEA38-4 + CA4-10	1SBN082306T2000 1SBN010110R1010
					100...250	100...250	AF26-30-00-13	1SBL237001R1300			
7.5	15.5	MS132-16 1SAM350000R1011	10.0...16.0	240	24...60	20...60	AF30Z-30-00-11	1SBL276001R1100	16		
					100...250	100...250	AF30-30-00-13	1SBL277001R1300			
11	22	MS132-25 1SAM350000R1014	20.0...25.0	375	24...60	20...60	AF30Z-30-00-11	1SBL276001R1100	25		
					100...250	100...250	AF30-30-00-13	1SBL277001R1300			
15	29	MS132-32 1SAM350000R1015	25.0...32.0	480	24...60	20...60	AF30Z-30-00-11	1SBL276001R1100	32		
					100...250	100...250	AF30-30-00-13	1SBL277001R1300			
18.5	35	MS165-42 1SAM451000R1015	30.0...42.0	630	24...60	20...60	AF40-30-00-11	1SBL347001R1100	40	BEA65-4 BPR65-4 (5) CA4-10	1SBN083406R1000 1SBN113405R1000 1SBN010110R1010
					100...250	100...250	AF40-30-00-13	1SBL347001R1300			
22	41	MS165-54 1SAM451000R1016	40.0...54.0	810	24...60	20...60	AF52-30-00-11	1SBL367001R1100	53		
					100...250	100...250	AF52-30-00-13	1SBL367001R1300			
30	55	MS165-65 1SAM451000R1017	52.0...65.0	975	24...60	20...60	AF65-30-00-11	1SBL387001R1100	65		
					100...250	100...250	AF65-30-00-13	1SBL387001R1300			
37	66	MS495-75 1SAM550000R1008	57.0...75.0	975	24...60	20...60	AF80-30-00-11	1SBL397001R1100	75		
					100...250	100...250	AF80-30-00-13	1SBL397001R1300			
45	80	MS495-90 1SAM550000R1009	70.0...90.0	1170	24...60	20...60	AF96-30-00-11	1SBL407001R1100	90		
					100...250	100...250	AF96-30-00-13	1SBL407001R1300			

- (1) MS116 manual motor starter can be selected according to the current setting range indicated on the coordination line, up to
  - 15 kW 400V - AC-3 at 16 kA
  - 4 kW, 400 V - AC-3 at 50 kA.
- (2) For other control voltages, see "Voltage code table".
- (3) AF26 3-pole contactor can be selected for coordination type 2, 16 kA, 7.5 kW, 400 V - AC-3.  
AF38 3-pole contactor can be selected for coordination type 2, 16 kA and 50 kA, 18.5 kW, 400 V - AC-3 (BEA65-4 available for AF40 ... AF65 only).
- (4) BEA26-4 should be selected with MS116-12 ... MS116-16 and AF26 ... AF38.  
BEA38-4 can only be selected with MS116-20 ... MS116-32.
- (5) For direct mounting on 2 rails 35 mm of MS165 with AF40 ... AF65: BEA65-4 must be associated with BPR65-4 fixed on contactor base. Applicable for MS165 manufactured after week 31, 2016 (date code > 16114).
- (6) AF ... -11 not suitable for direct control by PLC-output.



# Reversing starters protected by MS manual motor starters

## Coordination type 1

### Coordination type 1, AC-3, 16 kA or 50 kA, 400 V, 50/60 Hz

		Manual motor starters				Contactors				Accessories	
IEC AC-3, 400 V Rated operational power current kW	Type (1)	Order code	Current setting range A	Magnetic tripping current A	Rated control circuit voltage Uc min. ... Uc max. (2)		Type (3)	Order code	Allowed setting current A	Type	Order code
					V 50/60 Hz	V DC					
0.06	0.2	MS132-0.25	1SAM350000R1002	0.16...0.25	2.44	24...60	20...60	AF09Z-30-10-11	ISBL136001R1110	0.25	
						100...250	100...250	AF09-30-10-13	ISBL137001R1310		
0.09	0.3	MS132-0.4	1SAM350000R1003	0.25...0.40	3.9	24...60	20...60	AF09Z-30-10-11	ISBL136001R1110	0.4	
						100...250	100...250	AF09-30-10-13	ISBL137001R1310		
0.12	0.44	MS132-0.63	1SAM350000R1004	0.40...0.63	6.14	24...60	20...60	AF09Z-30-10-11	ISBL136001R1110	0.63	
						100...250	100...250	AF09-30-10-13	ISBL137001R1310		
0.18	0.6	MS132-0.63	1SAM350000R1004	0.40...0.63	6.14	24...60	20...60	AF09Z-30-10-11	ISBL136001R1110	0.63	
						100...250	100...250	AF09-30-10-13	ISBL137001R1310		
0.25	0.85	MS132-1.0	1SAM350000R1005	0.63...1.00	11.5	24...60	20...60	AF09Z-30-10-11	ISBL136001R1110	1	
						100...250	100...250	AF09-30-10-13	ISBL137001R1310		
0.37	1.1	MS132-1.6	1SAM350000R1006	1.00...1.60	18.4	24...60	20...60	AF09Z-30-10-11	ISBL136001R1110	1.6	
						100...250	100...250	AF09-30-10-13	ISBL137001R1310		
0.55	1.5	MS132-1.6	1SAM350000R1006	1.00...1.60	18.4	24...60	20...60	AF09Z-30-10-11	ISBL136001R1110	1.6	
						100...250	100...250	AF09-30-10-13	ISBL137001R1310		
0.75	1.9	MS132-2.5	1SAM350000R1007	1.60...2.50	28.75	24...60	20...60	AF09Z-30-10-11	ISBL136001R1110	2.5	
						100...250	100...250	AF09-30-10-13	ISBL137001R1310		
1.1	2.7	MS132-4.0	1SAM350000R1008	2.50...4.00	50	24...60	20...60	AF09Z-30-10-11	ISBL136001R1110	4	
						100...250	100...250	AF09-30-10-13	ISBL137001R1310		
1.5	3.6	MS132-4.0	1SAM350000R1008	2.50...4.00	50	24...60	20...60	AF09Z-30-10-11	ISBL136001R1110	4	
						100...250	100...250	AF09-30-10-13	ISBL137001R1310		
2.2	4.9	MS132-6.3	1SAM350000R1009	4.00...6.30	78.75	24...60	20...60	AF09Z-30-10-11	ISBL136001R1110	6.3	
						100...250	100...250	AF09-30-10-13	ISBL137001R1310		
3	6.5	MS132-10	1SAM350000R1010	6.30...10.0	150	24...60	20...60	AF09Z-30-10-11	ISBL136001R1110	9	
						100...250	100...250	AF09-30-10-13	ISBL137001R1310		
4	8.5	MS132-10	1SAM350000R1010	6.30...10.0	150	24...60	20...60	AF09Z-30-10-11	ISBL136001R1110	9	
						100...250	100...250	AF09-30-10-13	ISBL137001R1310		
5.5	11.5	MS132-12	1SAM350000R1012	8.00...12.0	180	24...60	20...60	AF12Z-30-10-11	ISBL156001R1110	12	
						100...250	100...250	AF12-30-10-13	ISBL157001R1310		
7.5	15.5	MS132-16	1SAM350000R1011	10.0...16.0	240	24...60	20...60	AF16Z-30-10-11	ISBL176001R1110	16	
						100...250	100...250	AF16-30-10-13	ISBL177001R1310		
11	22	MS132-25	1SAM350000R1014	20.0...25.0	375	24...60	20...60	AF26Z-30-00-11	ISBL236001R1100	25	
						100...250	100...250	AF26-30-00-13	ISBL237001R1300		
15	29	MS132-32	1SAM350000R1015	25.0...32.0	480	24...60	20...60	AF30Z-30-00-11	ISBL276001R1100	32	
						100...250	100...250	AF30-30-00-13	ISBL277001R1300		
18.5	35	MS165-42	1SAM451000R1015	30.0...42.0	630	24...60	20...60	AF40-30-00-11	ISBL347001R1100	40	
						100...250	100...250	AF40-30-00-13	ISBL347001R1300		
22	41	MS165-54	1SAM451000R1016	40.0...54.0	810	24...60	20...60	AF52-30-00-11	ISBL367001R1100	53	
						100...250	100...250	AF52-30-00-13	ISBL367001R1300		
30	55	MS165-65	1SAM451000R1017	52.0...65.0	975	24...60	20...60	AF65-30-00-11	ISBL387001R1100	65	
						100...250	100...250	AF65-30-00-13	ISBL387001R1300		
37	66	MS495-75	1SAM550000R1008	57.0...75.0	975	24...60	20...60	AF80-30-00-11	ISBL397001R1100	75	
						100...250	100...250	AF80-30-00-13	ISBL397001R1300		
45	80	MS495-90	1SAM550000R1009	70.0...90.0	1170	24...60	20...60	AF96-30-00-11	ISBL407001R1100	90	
						100...250	100...250	AF96-30-00-13	ISBL407001R1300		

(1) MS116 manual motor starter can be selected according to the current setting range indicated on the coordination line, up to:  
 - 15 kW, 400 V - AC-3 at 16 kA  
 - 4 kW, 400 V - AC-3 at 50 kA.

(2) For other control voltages, see "Voltage code table".

(3) AF38 3-pole contactor can be selected for coordination type 1, 16 kA and 50 kA, 18.5 kW, 400 V - AC-3 (BEA65-4 available for AF40 ... AF65 only).

(4) For direct mounting on 2 rails 35 mm of MS165 with AF40 ... AF65: BEA65-4 must be associated with BPR65-4 fixed on each contactor base. Applicable for MS165 manufactured after week 31, 2016 (date code > 16114).

(5) AF ... -11 not suitable for direct control by PLC-output.

# Reversing starters protected by MS manual motor starters

## Coordination type 2

### Coordination type 2, AC-3, 16 kA or 50 kA, 400 V, 50/60 Hz

		Manual motor starters				Contactors				Accessories	
IEC AC-3, 400 V Rated operational power current kW A	Type (1)	Order code	Current setting range A	Magnetic tripping current A	Rated control circuit voltage Uc min. ... Uc max. (2)		Type (3)	Order code	Allowed setting current A	Type (4)	Order code
					V 50/60 Hz	V DC					
0.06	0.2	MS132-0.25 1SAM350000R1002	0.16...0.25	2.44	24...60	20...60	AF09Z-30-10-11	1SBL136001R1110	0.25		
0.09	0.3	MS132-0.4 1SAM350000R1003	0.25...0.40	3.9	100...250	100...250	AF09-30-10-13	1SBL137001R1310	0.4	+ BEA16-4	1SBN081306T1000
0.12	0.44	MS132-0.63 1SAM350000R1004	0.40...0.63	6.14	24...60	20...60	AF09Z-30-10-11	1SBL136001R1110	0.63	+ BER16-4	1SBN081311R1000
0.18	0.6	MS132-0.63 1SAM350000R1004	0.40...0.63	6.14	100...250	100...250	AF09-30-10-13	1SBL137001R1310	0.63	+ VEM4	1SBN030111R1000
0.25	0.85	MS132-1.0 1SAM350000R1005	0.63...1.00	11.5	24...60	20...60	AF09Z-30-10-11	1SBL136001R1110	1		
0.37	1.1	MS132-1.6 1SAM350000R1006	1.00...1.60	18.4	100...250	100...250	AF09-30-10-13	1SBL137001R1310	1.6		
0.55	1.5	MS132-1.6 1SAM350000R1006	1.00...1.60	18.4	24...60	20...60	AF09Z-30-10-11	1SBL136001R1110	1.6		
0.75	1.9	MS132-2.5 1SAM350000R1007	1.60...2.50	28.75	100...250	100...250	AF09-30-10-13	1SBL137001R1310	2.5		
1.1	2.7	MS132-4.0 1SAM350000R1008	2.50...4.00	50	24...60	20...60	AF09Z-30-10-11	1SBL136001R1110	4	+ BEA26-4	1SBN082306T1000
1.5	3.6	MS132-4.0 1SAM350000R1008	2.50...4.00	50	100...250	100...250	AF09-30-10-13	1SBL137001R1310	4	+ BER38-4	1SBN082311R1000
2.2	4.9	MS132-6.3 1SAM350000R1009	4.00...6.30	78.75	24...60	20...60	AF26Z-30-00-11	1SBL236001R1100	6.3	+ VEM4	1SBN030111R1000
3	6.5	MS132-10 1SAM350000R1010	6.30...10.0	150	100...250	100...250	AF26-30-00-13	1SBL237001R1300	10	+ 2x CA4-10	1SBN010110R1010
4	8.5	MS132-10 1SAM350000R1010	6.30...10.0	150	24...60	20...60	AF26Z-30-00-11	1SBL236001R1100	10		
5.5	11.5	MS132-12 1SAM350000R1012	8.00...12.0	180	100...250	100...250	AF26-30-00-13	1SBL237001R1300	12	+ BEA38-4	1SBN082306T2000
7.5	15.5	MS132-16 1SAM350000R1011	10.0...16.0	240	24...60	20...60	AF26Z-30-00-11	1SBL236001R1100	16	+ BER38-4	1SBN082311R1000
11	22	MS132-25 1SAM350000R1014	20.0...25.0	375	100...250	100...250	AF26-30-00-13	1SBL237001R1300	25	+ VEM4	1SBN030111R1000
15	29	MS132-32 1SAM350000R1015	25.0...32.0	480	24...60	20...60	AF30Z-30-00-11	1SBL276001R1100	32	+ 2x CA4-10	1SBN010110R1010
18.5	35	MS165-42 1SAM451000R1015	30.0...42.0	630	100...250	100...250	AF30-30-00-13	1SBL277001R1300	40	+ BEA65-4	1SBN083406R1000
22	41	MS165-54 1SAM451000R1016	40.0...54.0	810	24...60	20...60	AF40-30-00-11	1SBL347001R1100	53	+ 2x BPR65-4 (5)	1SBN113405R1000
30	55	MS165-65 1SAM451000R1017	52.0...65.0	975	100...250	100...250	AF40-30-00-13	1SBL347001R1300	65	+ BER65-4	1SBN083411R1000
37	66	MS495-75 1SAM550000R1008	57.0...75.0	975	24...60	20...60	AF52-30-00-11	1SBL367001R1100	75	+ VM96-4	1SBN033405T1000
45	80	MS495-90 1SAM550000R1009	70.0...90.0	1170	100...250	100...250	AF52-30-00-13	1SBL367001R1300	90	+ 2x CA4-10	1SBN010110R1010
					24...60	20...60	AF65-30-00-11	1SBL387001R1100		+ 2x CA4-01	1SBN010110R1001
					100...250	100...250	AF65-30-00-13	1SBL387001R1300			
					24...60	20...60	AF80-30-00-11	1SBL397001R1100		+ BEA38-4	1SBN083911R1000
					100...250	100...250	AF80-30-00-13	1SBL397001R1300		+ VM96-4	1SBN033405T1000
					24...60	20...60	AF96-30-00-11	1SBL407001R1100		+ 2x CA4-10	1SBN010110R1010
					100...250	100...250	AF96-30-00-13	1SBL407001R1300		+ 2x CA4-01	1SBN010110R1001

(1) MS116 manual motor starter can be selected according to the current setting range indicated on the coordination line, up to  
 - 15 kW 400V - AC-3 at 16 kA  
 - 4 kW, 400 V - AC-3 at 50 kA.

(2) For other control voltages, see "Voltage code table".

(3) AF26 3-pole contactor can be selected for coordination type 2, 16 kA, 7.5 kW, 400 V - AC-3.

AF38 3-pole contactor can be selected for coordination type 2, 16 kA and 50 kA, 18.5 kW, 400 V - AC-3 (BEA65-4 available for AF40 ... AF65 only).

(4) BEA26-4 should be selected with MS116-12 ... MS116-16 and AF26 ... AF38.

BEA38-4 can only be selected with MS116-20 ... MS116-32.

(5) For direct mounting on 2 rails 35 mm of MS165 with AF40 ... AF65: BEA65-4 must be associated with BPR65-4 fixed on each contactor base. Applicable for MS165 manufactured after week 31, 2016 (date code > 16114).

(6) AF ... -11 not suitable for direct control by PLC-output.



# DOL and reversing starters protected by manual motor starters

With AF contactors - open type version in kit form

Wiring diagrams

## Direct-on-line starters

### Power circuit

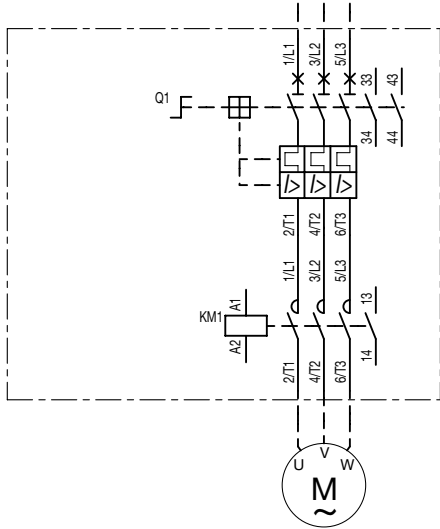

### 1-phase

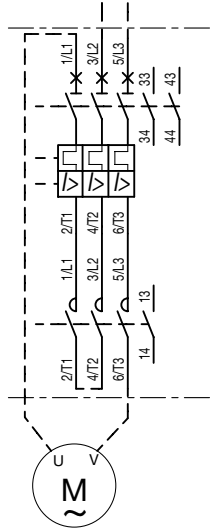

### AC or DC local control

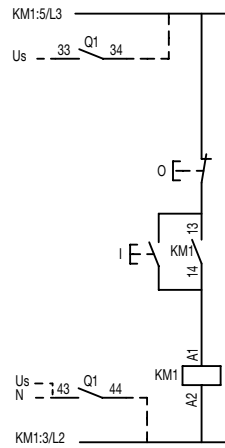

### AC or DC remote control

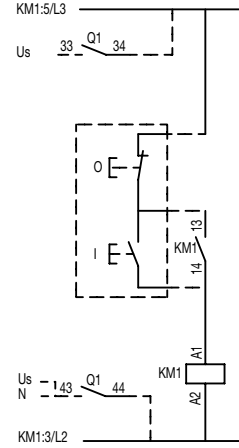

Note: coil Uc 12-20 V DC : A1+, A2-

## Reversing starters

### Power circuit

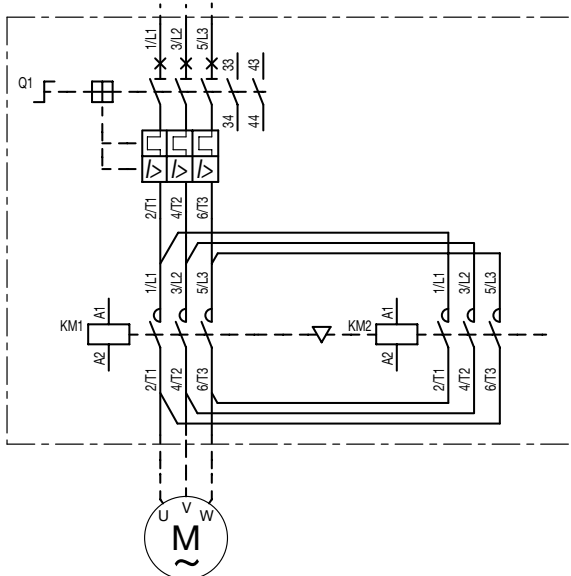

### AC or DC local control

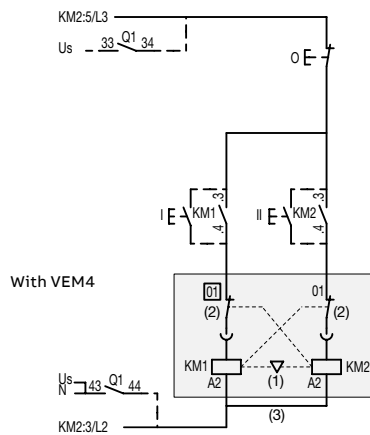

With VM

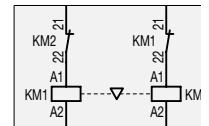

### AC or DC remote control

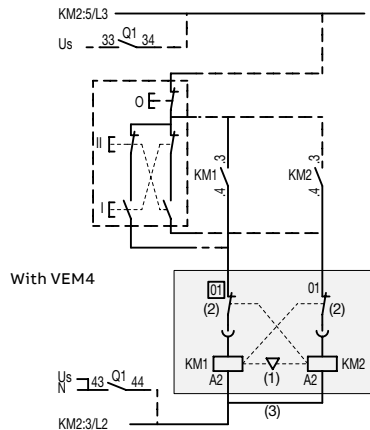

With VM

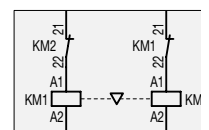

Note: - VEM4 = VM4 (1) + VE4 (2) with A2-A2 (3) connection  
 (Except for coil Uc 12-20 V DC : use VM4 with CA4).  
 - coil Uc 12-20 V DC : A1+, A2-

## DOL starters protected by MS16 manual motor starters

With AF contactors - open type version in kit form

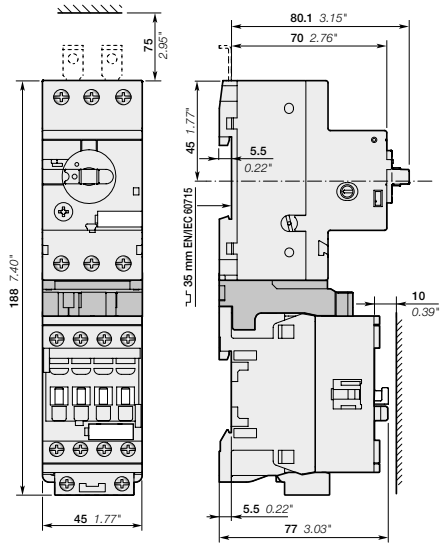

MS116-0.16 ... MS116-16  
+ BEA16-4  
+ AF09, AF12, AF16

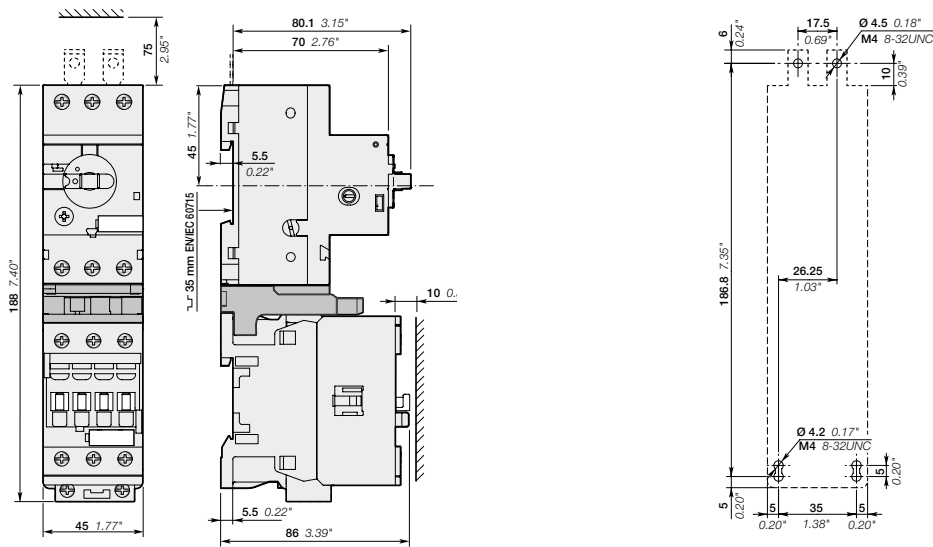

MS116-0.16 ... MS116-16  
+ BEA26-4  
+ AF26, AF30, AF38

Note: contactor lateral distance to grounded component 2 mm 0.08" min.

Coordination tables for MS166 available is our SOC tool :

<https://applications.it.abb.com/SOC/Selectivity>

Main dimensions mm, inches

# DOL starters protected by MS132 manual motor starters

With AF contactors - open type version in kit form

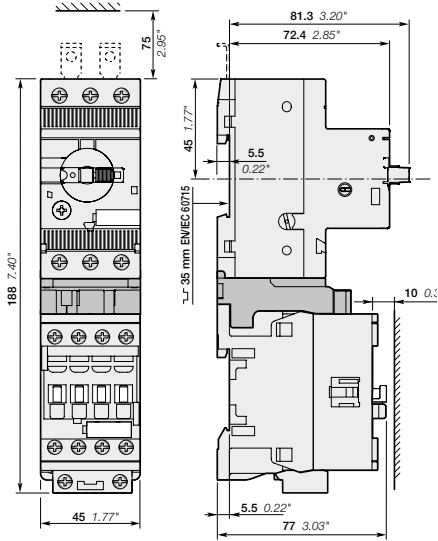

MS132-0.16 ... MS132-10  
+ BEA16-4  
+ AF09, AF12, AF16

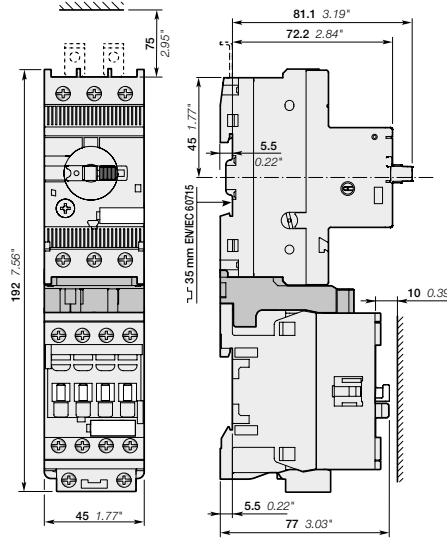

MS132-12 ... MS132-25  
+ BEA16-4  
+ AF09, AF12, AF16

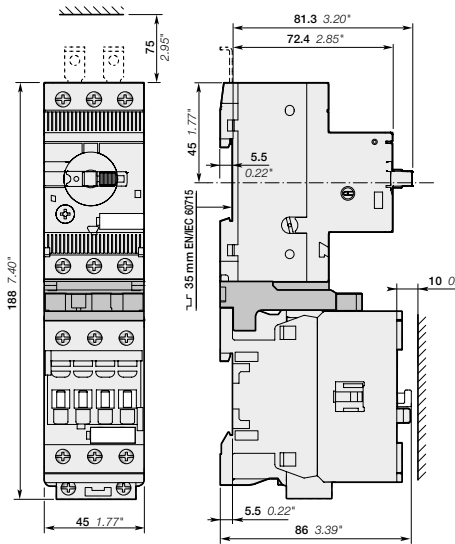

MS132-0.16 ... MS132-10  
+ BEA26-4  
+ AF26, AF30, AF38

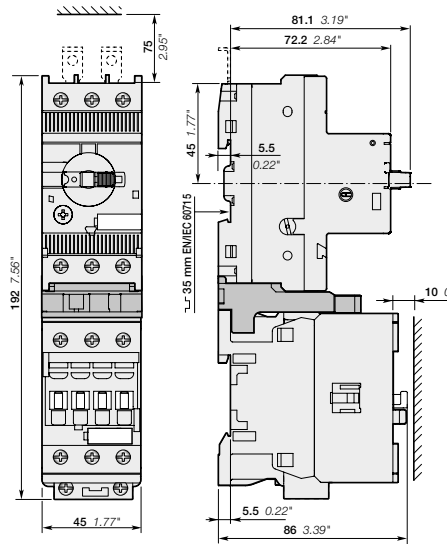

MS132-12 ... MS132-32  
+ BEA38-4  
+ AF26, AF30, AF38

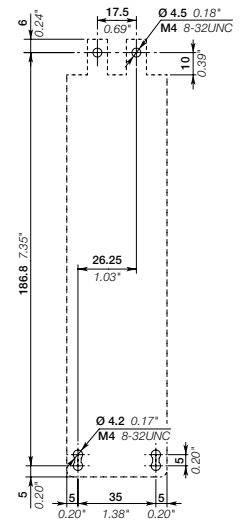

Note: contactor lateral distance to grounded component 2 mm 0.08" min.

Main dimensions mm, inches

# DOL starters protected by MS165 manual motor starters

With AF contactors - open type version in kit form

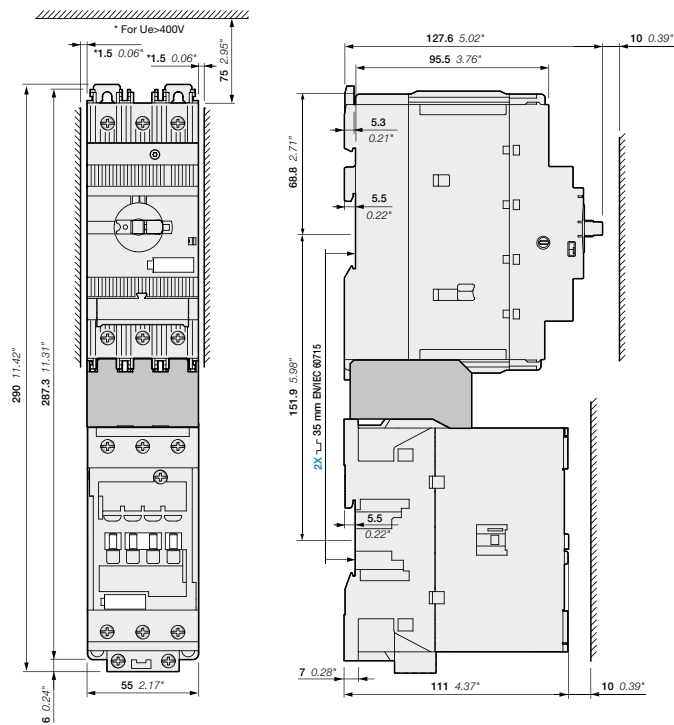

MS165  
+ BEA65-4  
+ AF40, AF52, AF65

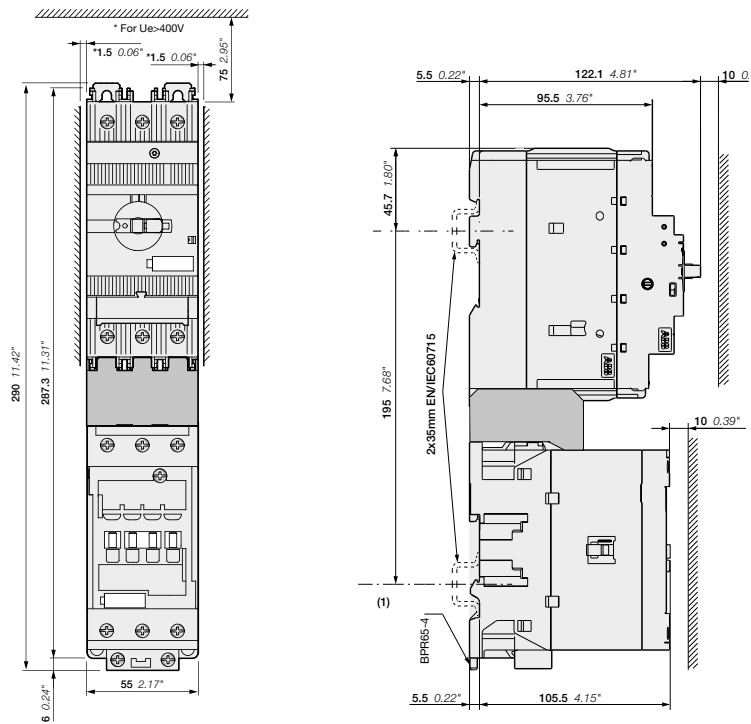
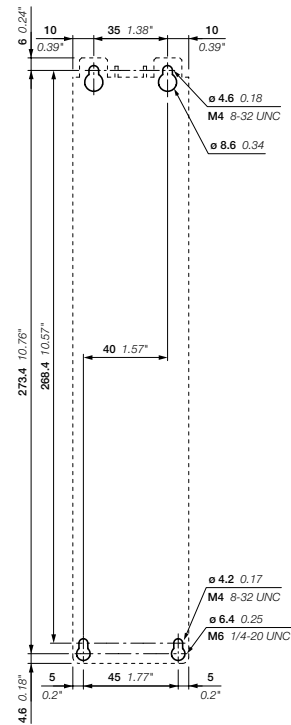

MS165  
+ BEA65-4  
+ AF40, AF52, AF65 + BPR65-4

Note: for Ue > 400 V, contactor lateral distance to grounded component 1.5 mm 0.06" min.  
(1) Assembly on fixed DIN Rails for DOL starter with BPR65-4 rail hook

Main dimensions mm, inches

# Reversing starters protected by MS116 manual motor starters

With AF contactors - open type in kit form

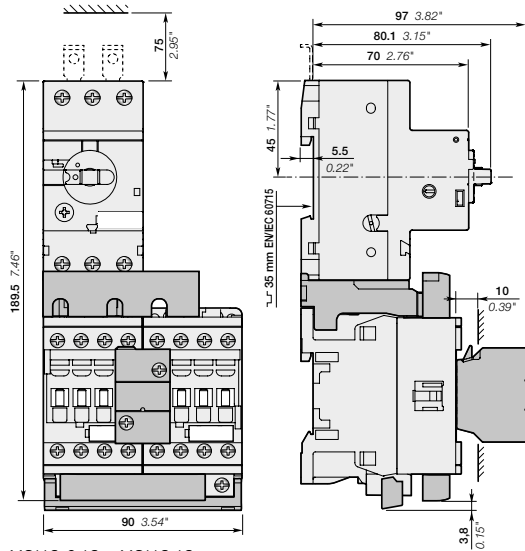

MS116-0.16 ... MS116-16  
 + BEA16-4, BER16-4, VEM4  
 + AF09, AF12, AF16

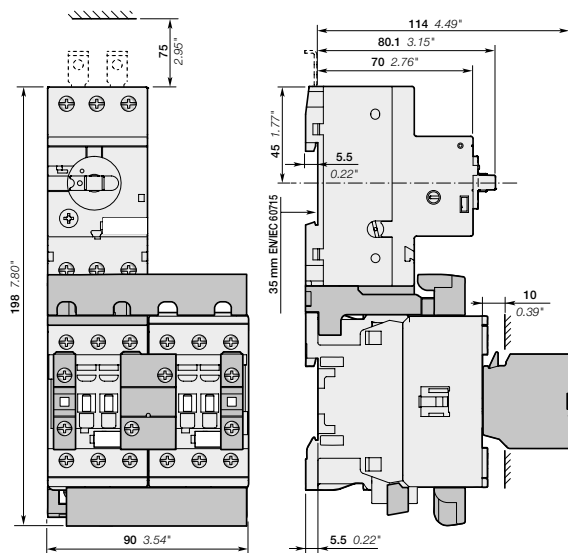

MS116-0.16 ... MS116-16  
 + BEA26-4, BER38-4, VEM4, CA4-10  
 + AF26, AF30, AF38

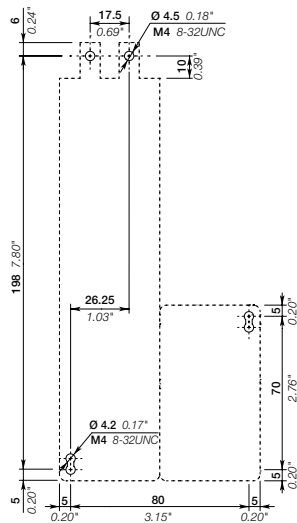

Note: contactor lateral distance to grounded component 2 mm 0.08" min.

Coordination tables for MS166 available is our SOC tool :

<https://applications.it.abb.com/SOC/Selectivity>

Main dimensions mm, inches

# Reversing starters protected by MS132 manual motor starters

With AF contactors - open type version in kit form

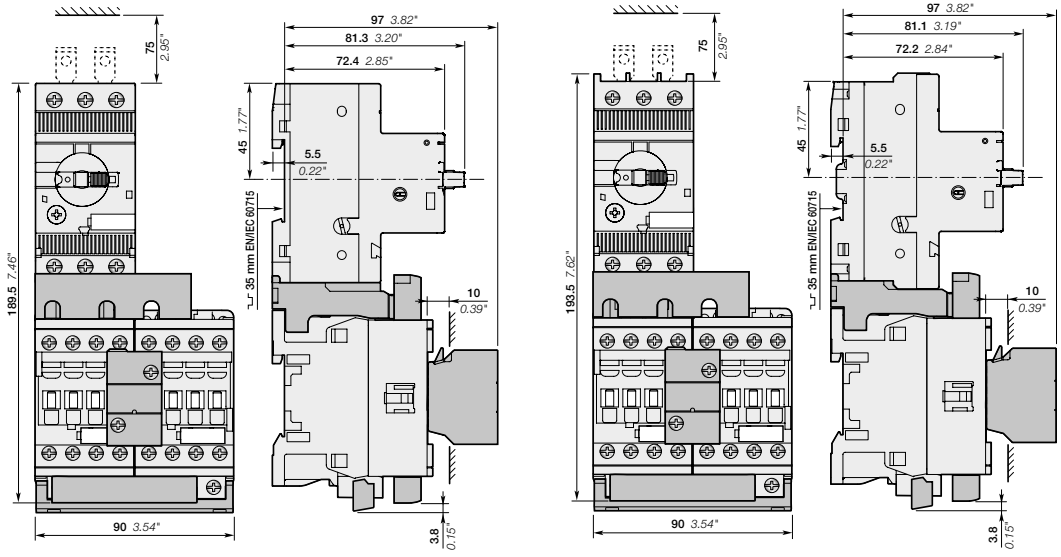

MS132-0.16 ... MS132-10  
+ BEA16-4, BER16-4, VEM4  
+ AF09, AF12, AF16

MS132-12 ... MS132-25  
+ BEA16-4, BER16-4, VEM4  
+ AF09, AF12, AF16

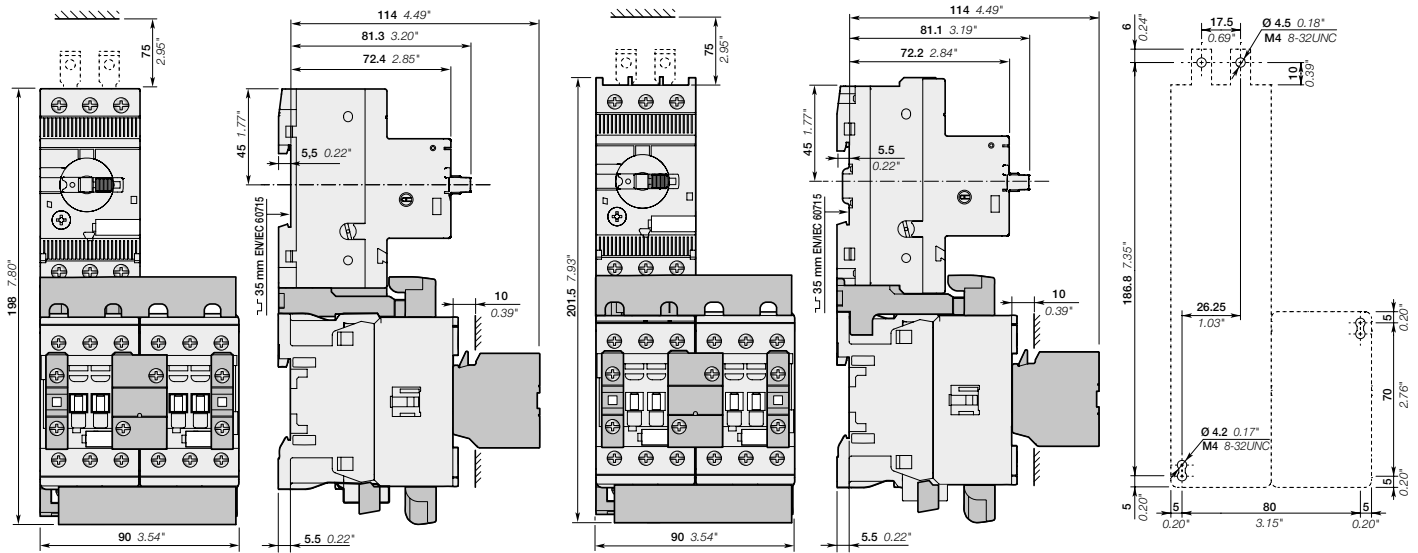

MS132-0.16 ... MS132-10  
+ BEA26-4, BER38-4, VEM4, CA4-10  
+ AF26, AF30, AF38

MS132-12 ... MS132-32  
+ BEA38-4, BER38-4, VEM4, CA4-10  
+ AF26, AF30, AF38

Note: contactor lateral distance to grounded component 2 mm 0.08" min.

Main dimensions mm, inches

# Reversing starters protected by MS165 manual motor starters

With AF contactors - open version in kit form

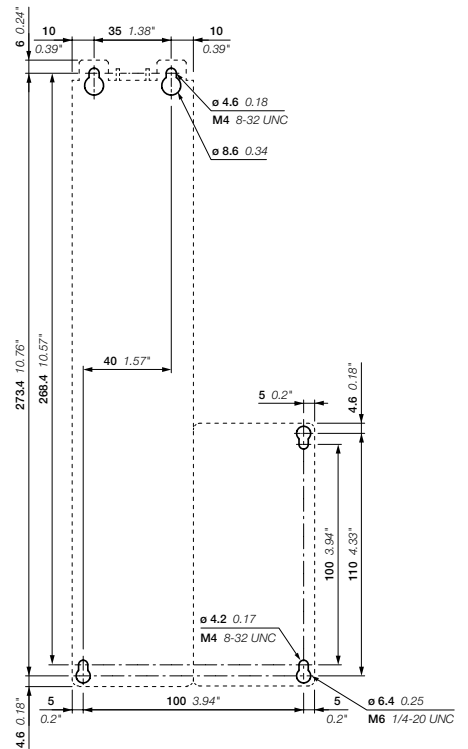
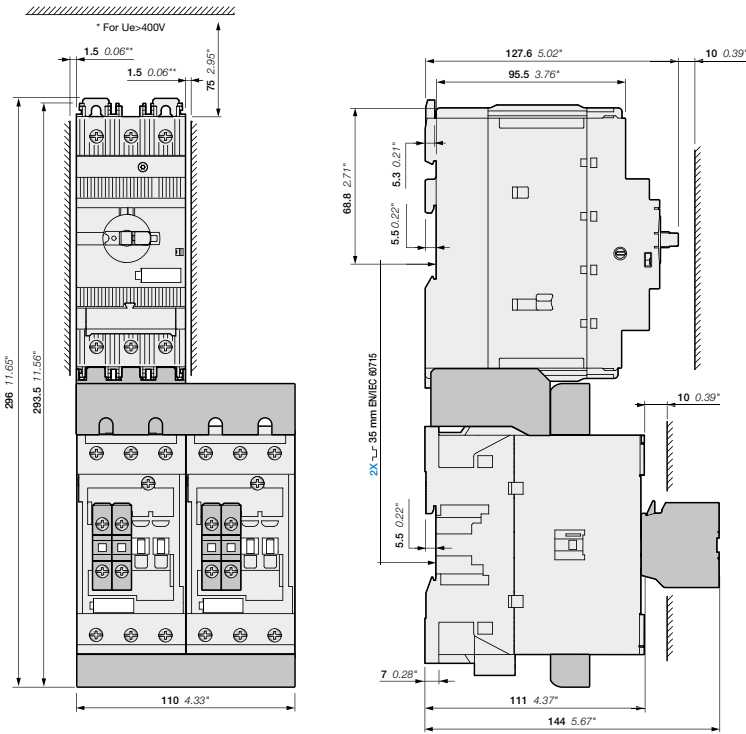

MS165  
 + BEA65-4, BER65-4, VM96-4  
 + AF40, AF52, AF65

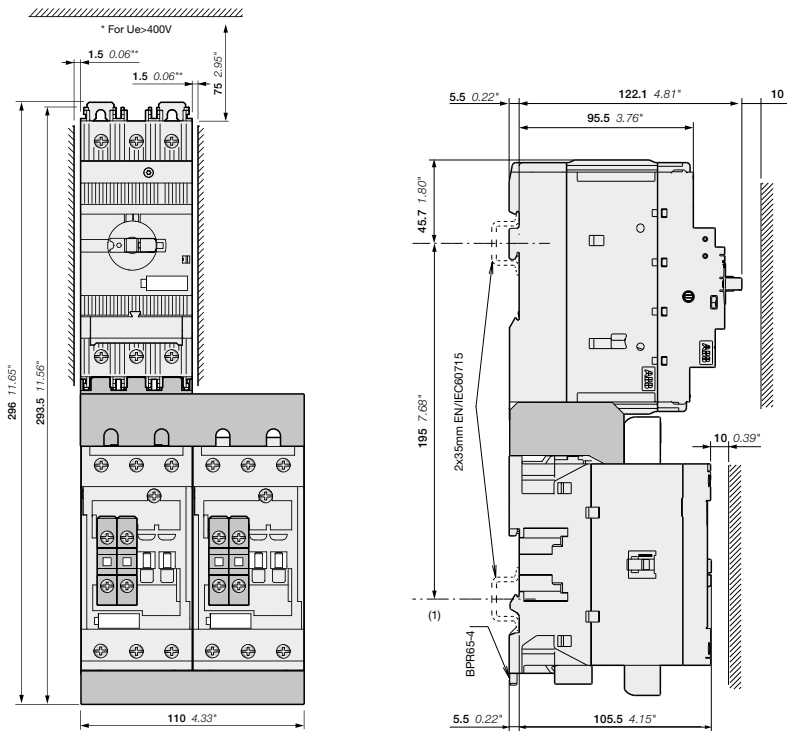

MS165  
 + BEA65-4,  
 + AF40, AF52, AF65 + 2x BPR65-4

Note: for Ue > 400 V, contactor lateral distance to grounded component 1.5 mm 0.06" min.  
 (1): Assembly on fixed DIN Rails for reverser starter with BPR65-4 rail hook

Main dimensions mm, inches

—  
**Notes**

A large rectangular area filled with a grid of small, light gray dotted lines, intended for handwritten notes.



# DOL starters protected by moulded-case circuit-breakers and overload relays

With AF contactors - open type version in kit form



XT2S 160 + BEA140/XT2 + AF140-30-11

### Application

Full voltage direct-on-line (DOL) starting for controlling three-phase asynchronous motors is a simple and economic solution characterised by a high starting torque (1.9 to 2.1 times full-speed torque) and a starting current 5.5 to 7 times nominal current.

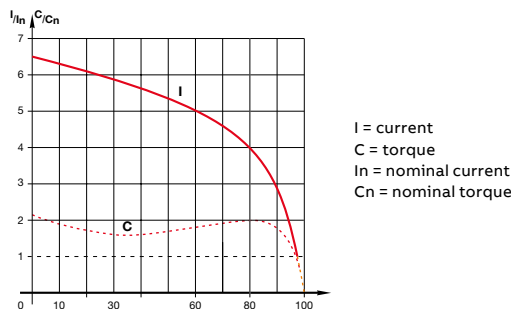

### Coordination types

The contactor and the moulded-case circuit-breaker control and protect motors against overload and short-circuits according to coordination types 1 and 2 (IEC 60947-4-1/ EN 60947-4-1) defining the anticipated level of service continuity as follow:

**Type 1:** In short-circuit conditions, the contactor or starter does not endanger persons or installations and will not be able to then operate without being repaired or having parts replaced.

**Type 2:** In short-circuit conditions, the contactor or starter does not endanger persons or installations and will be able to operate afterwards. The risk of contacts light welding is acceptable.

### Main Technical Data

Standards	IEC 60947-4-1 / EN 60947-4-1
Rated operational voltage Ue max.	400 V - 50/60 Hz
Rated insulation voltage Ui	
acc. to IEC 60947-4-1	690 V
acc. to UL / CSA	600 V
Switching frequency	≤ 15 starts/hour - 80 % max. load factor - with max. 1.5 s starting time ≤ 30 starts/hour - 50 % max. load factor - with max. 1.5 s starting time
Ambient air temperature	
Close to the device	< 55 °C
Degree of protection	IP20



XT2S 160 + BEA140/XT2 + AF140-30-11 + EF146

### Mounting positions

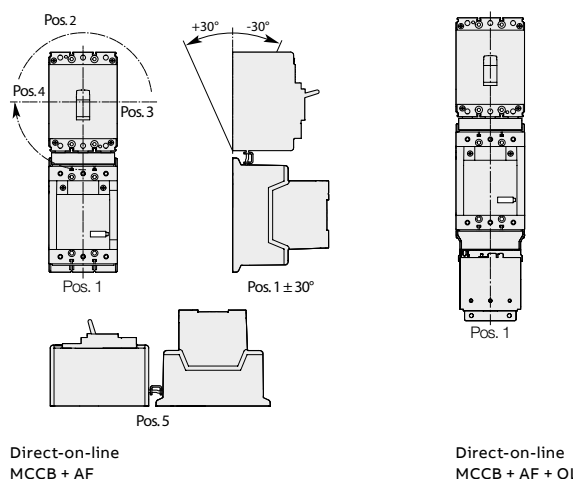

## DOL starters protected by moulded-case circuit-breakers and overload relays

With AF contactors - open type version in kit form

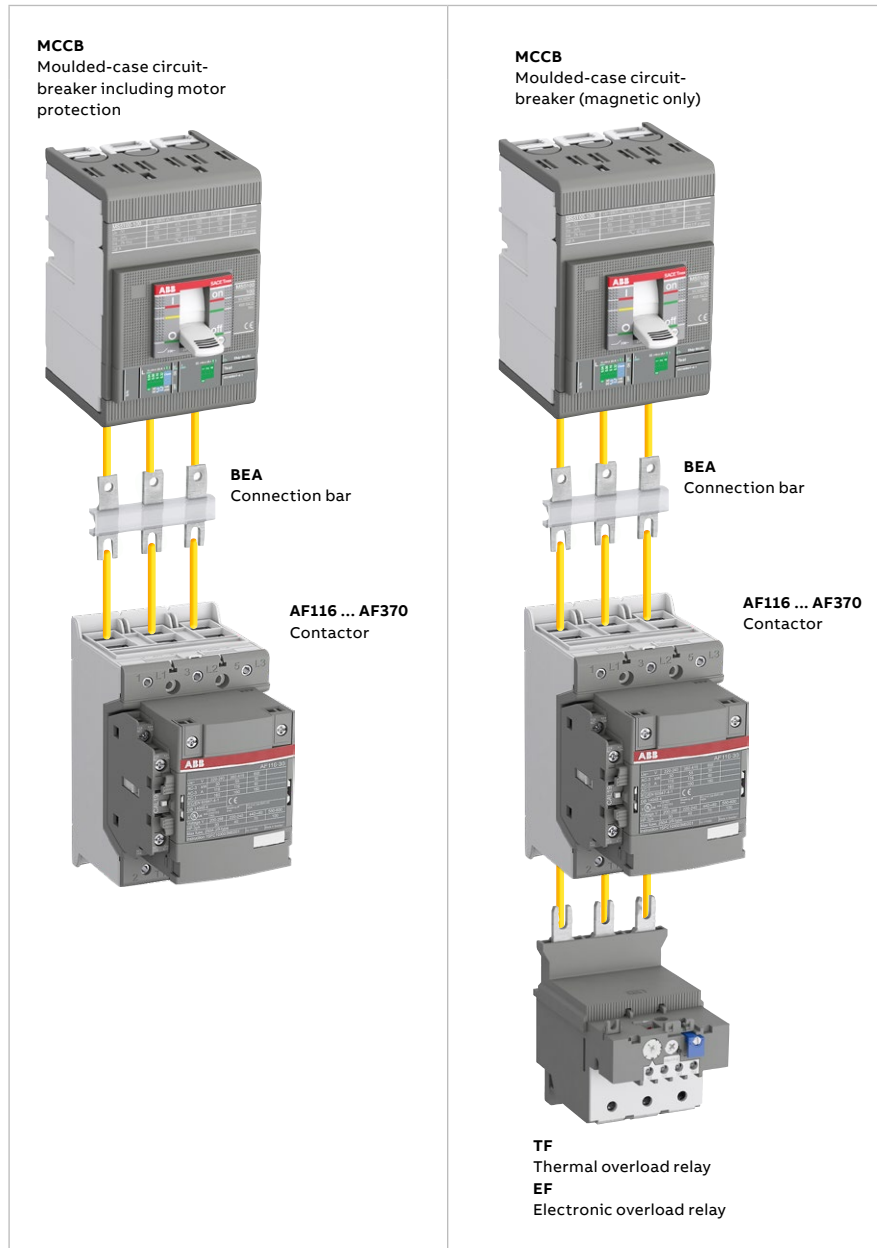

You can easily assemble a direct-on-line starter by using the BEA connection bars. It is used to electrically connect MCCB moulded-case circuit-breaker and AF116 ... AF370 contactor, AC or DC operated.

**Select now easily and quickly your starter in the following pages for coordination type 1 or 2 at 400 V, 50/60 Hz, I<sub>q</sub> = 50 kA up to 200 kW.**

For the full coordination tables, please visit our SOC tool : <https://applications.it.abb.com/SOC/Selectivity>

## DOL starters protected by MCCB including motor protection

Coordination type 1 or 2

Coordination type 1 or 2, AC-3, 50 kA, 400 V, 50/60 Hz

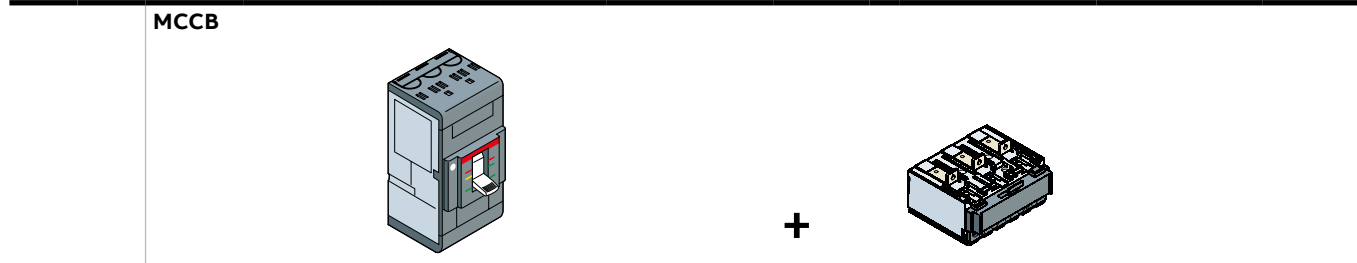

IEC AC-3, 400 V		Magnetic tripping current setting A	Max. allowed thermal setting	Base		Trip unit		
Rated power kW	Rated current A			Type	Order code	Type	Order code	
55	97	1440	116	XT2S 160	1SDA068164R1	+	Ekip M-LIU In160	1SDA067355R1
75	132	1920	140	XT2S 160	1SDA068164R1	+	Ekip M-LIU In160	1SDA067355R1
90	160	2400	190	T4S 250 PR222MP In200	1SDA054527R1		Included	-
110	195	2880	205	T5S 400 PR222MP In320	1SDA054553R1		Included	-
132	230	3600	265	T5S 400 PR222MP In400	1SDA054554R1		Included	-
160	280	4400	305	T5S 400 PR222MP In400	1SDA054554R1		Included	-

**Contactors**

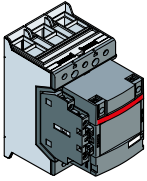

**Connection bars**

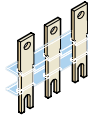

Control voltage Uc min. ... Uc max.		Type	Order code	Type	Order code
V 50/60 Hz	V DC				
24...60	20...60	AF116-30-11-11	1SFL427001R1111	BEA140/XT2	1SFN084206R1000
100...250	100...250	AF116-30-11-13	1SFL427001R1311		
24...60	20...60	AF140-30-11-11	1SFL447001R1111	BEA205/T4	1SFN084806R1001
100...250	100...250	AF140-30-11-13	1SFL447001R1311		
24...60	20...60	AF190-30-11-11	1SFL487002R1111	BEA370/T5	1SFN085406R1000
100...250	100...250	AF190-30-11-13	1SFL487002R1311		
24...60	20...60	AF205-30-11-11	1SFL527002R1111	BEA370/T5	1SFN085406R1000
100...250	100...250	AF205-30-11-13	1SFL527002R1311		
24...60	20...60	AF265-30-11-11	1SFL547002R1111	BEA370/T5	1SFN085406R1000
100...250	100...250	AF265-30-11-13	1SFL547002R1311		
24...60	20...60	AF305-30-11-11	1SFL587002R1111	BEA370/T5	1SFN085406R1000
100...250	100...250	AF305-30-11-13	1SFL587002R1311		

## DOL starters protected by MCCB (magnetic only) and overload relays

Coordination type 1 or 2

### Coordination type 1 or 2, AC-3, 50 kA, 400 V, 50/60 Hz

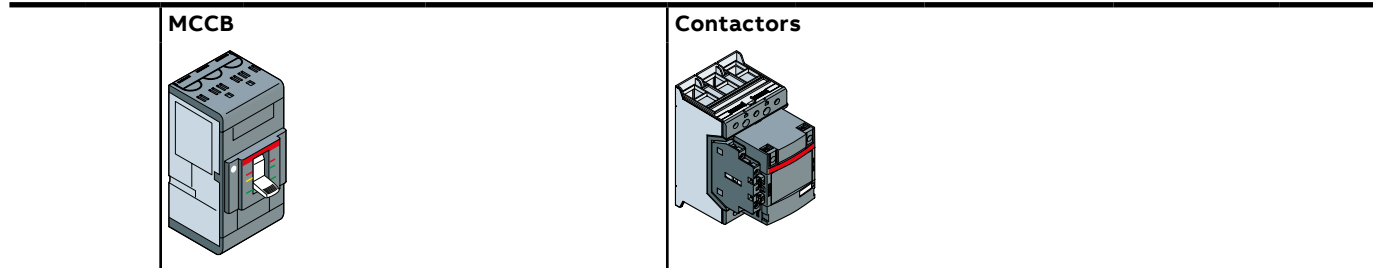

### Thermal overload relays

IEC AC-3, 400 V Rated power kW	Rated current A	Magnetic tripping current A	Type	Order code	Control voltage Uc min. ... Uc max.		Type	Order code
					V 50/60 Hz	V DC		
55	97	1600	XT2S 160 MA 160	1SDA076530R1	24...60	20...60	AF116-30-11-11	1SFL427001R1111
					100...250	100...250	AF116-30-11-13	1SFL427001R1311
75	132	1920	XT2S 160 MA 160	1SDA076530R1	24...60	20...60	AF140-30-11-11	1SFL447001R1111
					100...250	100...250	AF140-30-11-13	1SFL447001R1311
90	160	2250	XT4S 250 Ekip I In250	1SDA068480R1	24...60	20...60	AF190-30-11-11	1SFL487002R1111
					100...250	100...250	AF190-30-11-13	1SFL487002R1311
110	195	2720	T4S 320 PR221-I In320	1SDA054126R1	24...60	20...60	AF205-30-11-11	1SFL527002R1111
					100...250	100...250	AF205-30-11-13	1SFL527002R1311

### Electronic overload relays

55	97	1600	XT2S 160 MA 160	1SDA076530R1	24...60	20...60	AF116-30-11-11	1SFL427001R1111
					100...250	100...250	AF116-30-11-13	1SFL427001R1311
75	132	1920	XT2S 160 MA 160	1SDA076530R1	24...60	20...60	AF140-30-11-11	1SFL447001R1111
					100...250	100...250	AF140-30-11-13	1SFL447001R1311
90	160	2250	XT4S 250 Ekip I In250	1SDA068480R1	24...60	20...60	AF190-30-11-11	1SFL487002R1111
					100...250	100...250	AF190-30-11-13	1SFL487002R1311
110	195	2720	T4S 320 PR221-I In320	1SDA054126R1	24...60	20...60	AF205-30-11-11	1SFL527002R1111
					100...250	100...250	AF205-30-11-13	1SFL527002R1311
132	230	3200	T5S 400 PR221-I In400	1SDA054335R1	24...60	20...60	AF265-30-11-11	1SFL547002R1111
					100...250	100...250	AF265-30-11-13	1SFL547002R1311
160	280	4000	T5S 400 PR221-I In400	1SDA054335R1	24...60	20...60	AF305-30-11-11	1SFL587002R1111
					100...250	100...250	AF305-30-11-13	1SFL587002R1311
200	350	5040	T5S 630 PR221-I In630	1SDA054405R1	24...60	20...60	AF370-30-11-11	1SFL607002R1111
					100...250	100...250	AF370-30-11-13	1SFL607002R1311



	Setting ranges	Max. allowed setting current	Type	Order code	Type	Order code
	A	A				
	80...110	110	TF140DU-110	1SAZ431201R1002	BEA140/XT2	1SFN084206R1000
	110...142	140	TF140DU-142	1SAZ431201R1004		
	130...175	175	TA200DU-175	1SAZ421201R1005	BEA205/XT4	1SFN084806R1000
	155...200	200	TA200DU-200	1SAZ421201R1006	BEA205/T4	1SFN084806R1001
	54...150	116	EF146-150	1SAX351001R1101	BEA140/XT2	1SFN084206R1000
	54...150	140	EF146-150	1SAX351001R1101		
	63...210	190	EF205-210	1SAX531001R1101	BEA205/XT4	1SFN084806R1000
	63...210	205	EF205-210	1SAX531001R1101	BEA205/T4	1SFN084806R1001
	115...380	265	EF370-380	1SAX611001R1101	BEA370/T5	1SFN085406R1000
	115...380	305	EF370-380	1SAX611001R1101		
	115...380	350	EF370-380	1SAX611001R1101		

# DOL starters protected by moulded-case circuit-breakers and overload relays

With AF contactors - Open type version in kit form

## Direct-on-line starters

### Protected by MCCB including motor protection

### Protected by MCCB (magnetic only) and overload relays

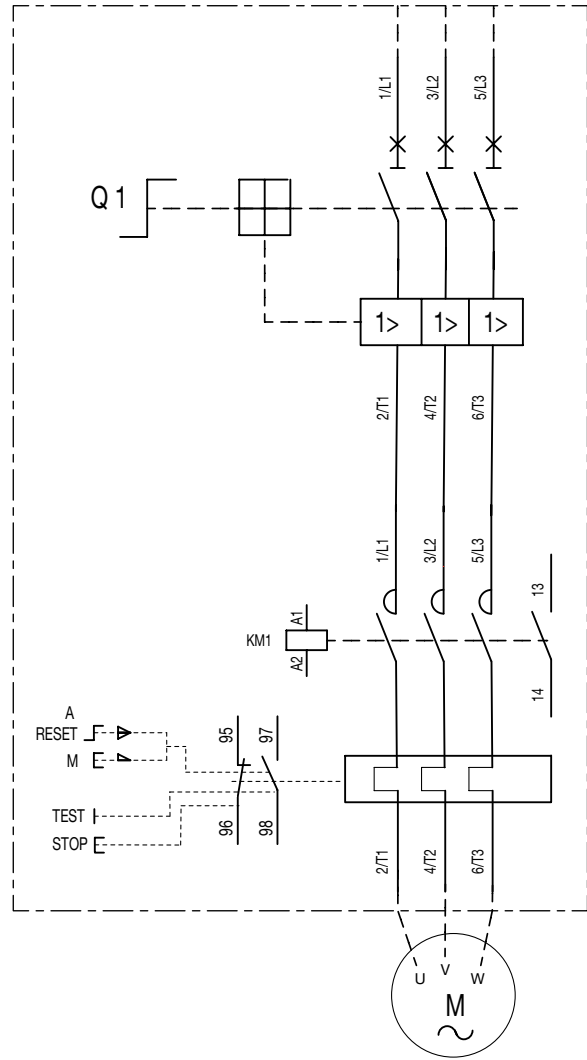
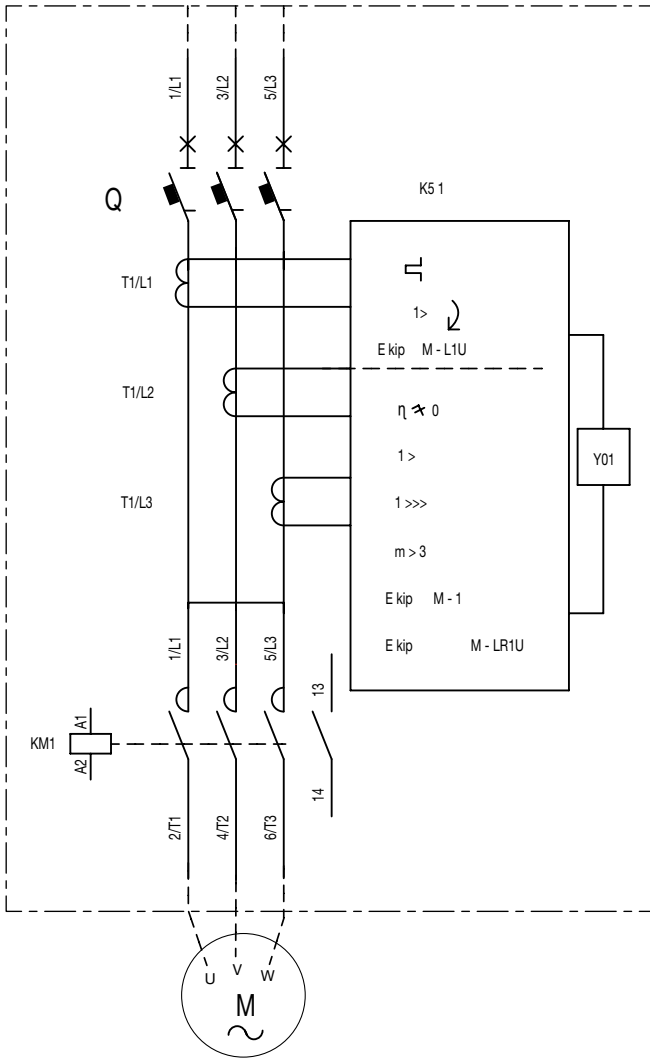

## DOL starters protected by MCCB, including motor protection

With AF contactors - Open type version in kit form

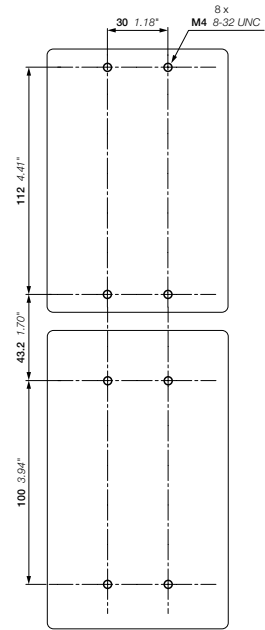
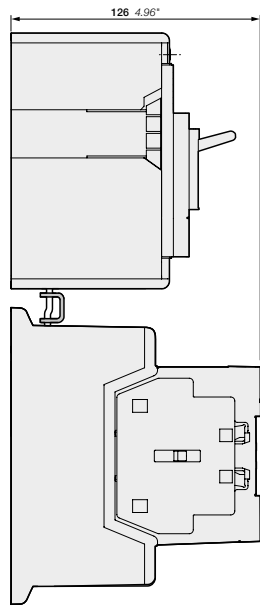
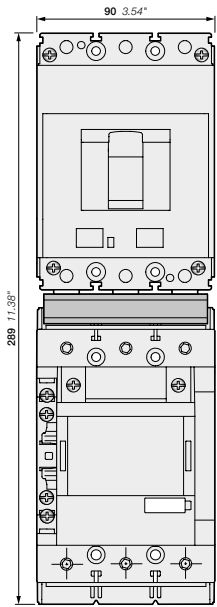

XT2S 160 + Ekip M-LIU In160  
+ BEA140/XT2  
+ AF116, AF140, AF146

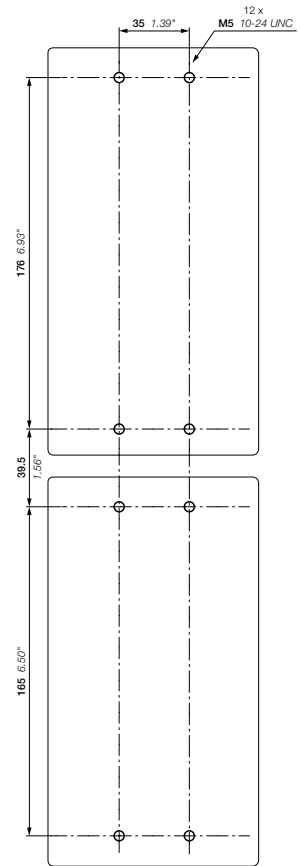
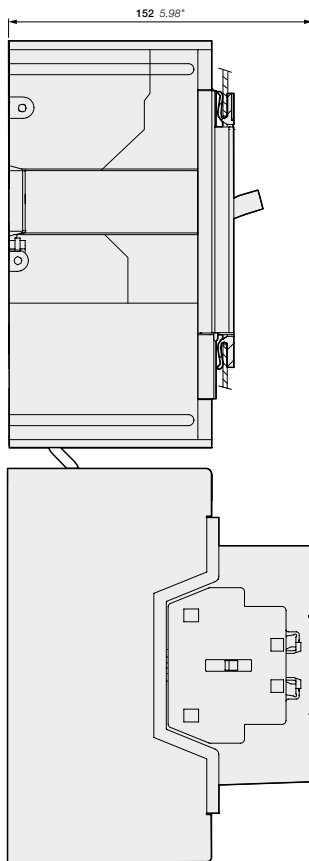
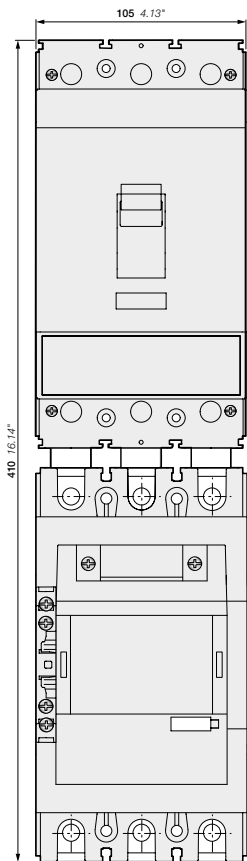

T4S  
+ BEA205/T4  
+ AF190, AF205

Main dimensions mm, inches



# DOL starters protected by MCCB, including motor protection

With AF contactors - Open type version in kit form

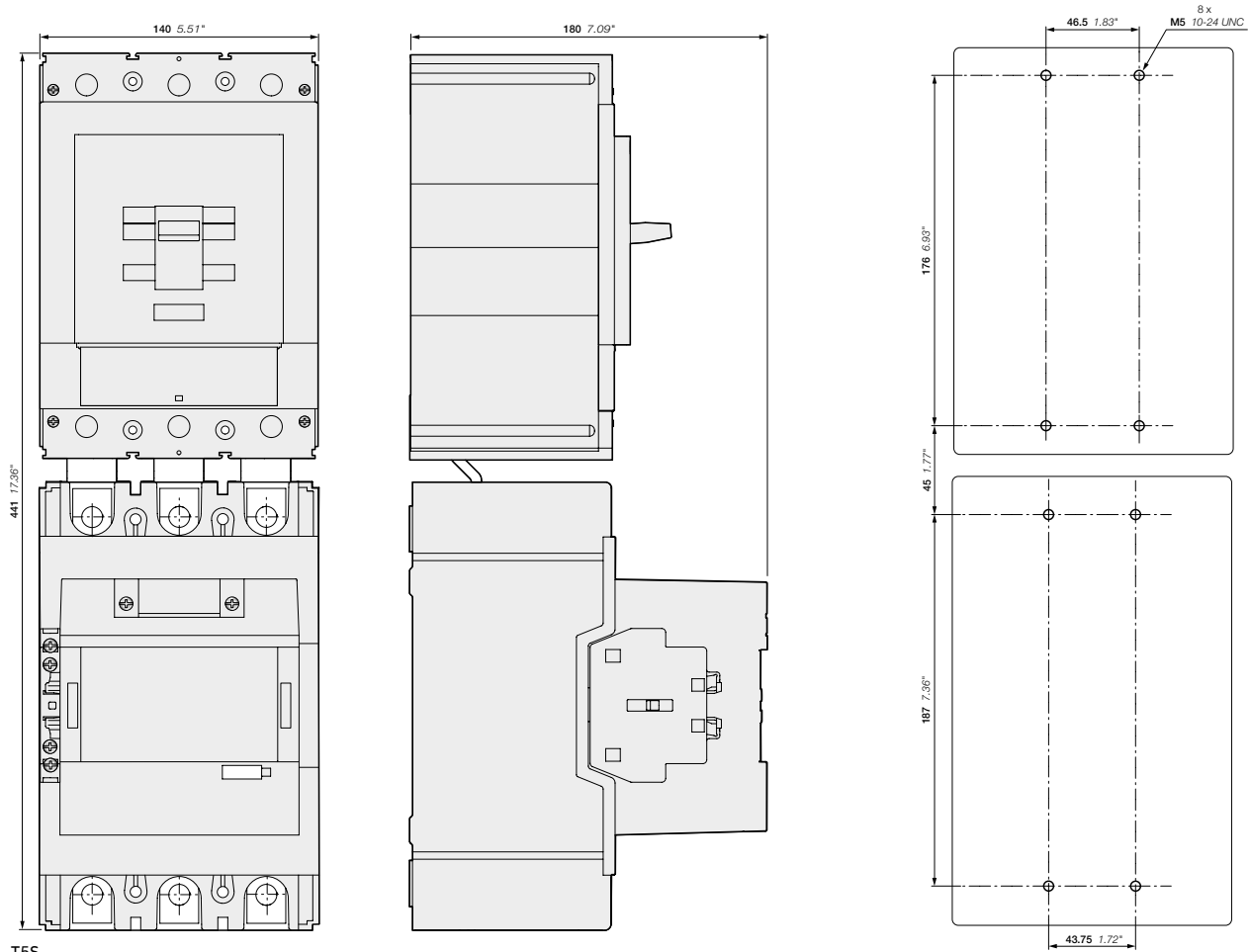

T5S  
 + BEA370/T5  
 + AF265, AF305, AF370

Main dimensions mm, inches

# DOL starters protected by MCCB (magnetic only) and thermal overload relays

With AF contactors - Open type version in kit form

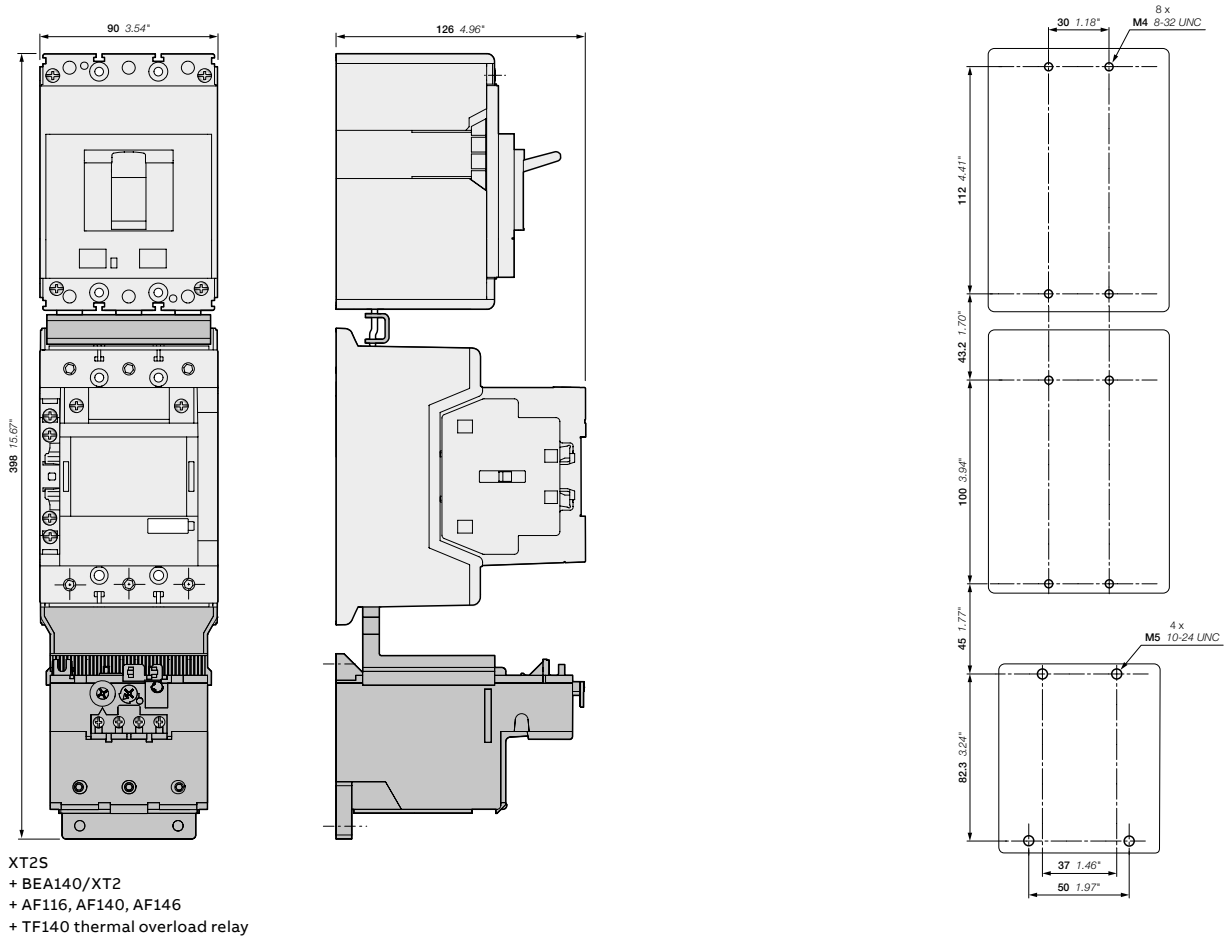

Main dimensions mm, inches

# DOL starters protected by MCCB (magnetic only) and thermal overload relays

With AF contactors - Open type version in kit form

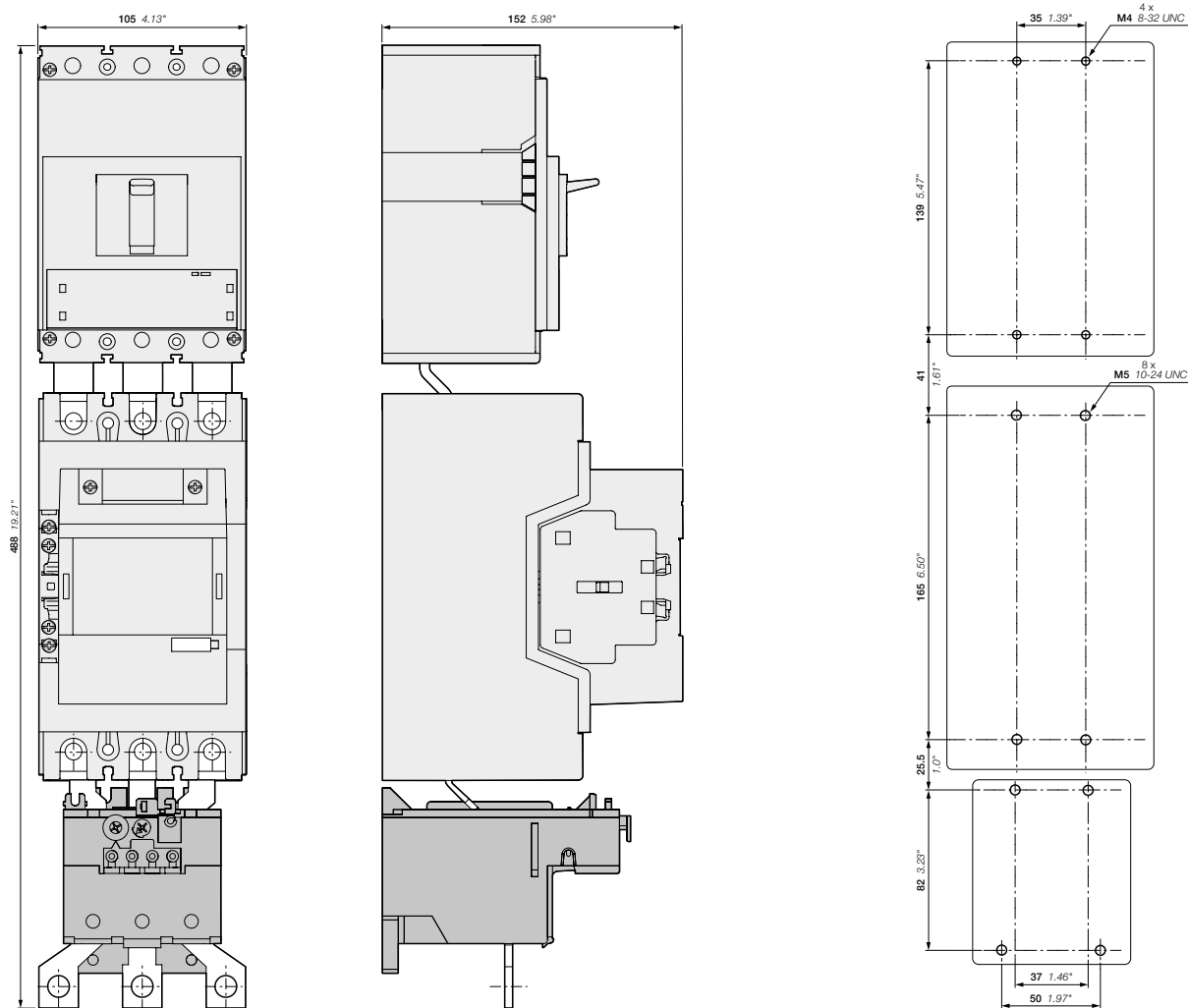

- XT4S
- + BEA205/XT4
- + AF190, AF205
- + TA200DU thermal overload relay

Main dimensions mm, inches

# DOL starters protected by MCCB (magnetic only) and thermal overload relays

With AF contactors - Open type version in kit form

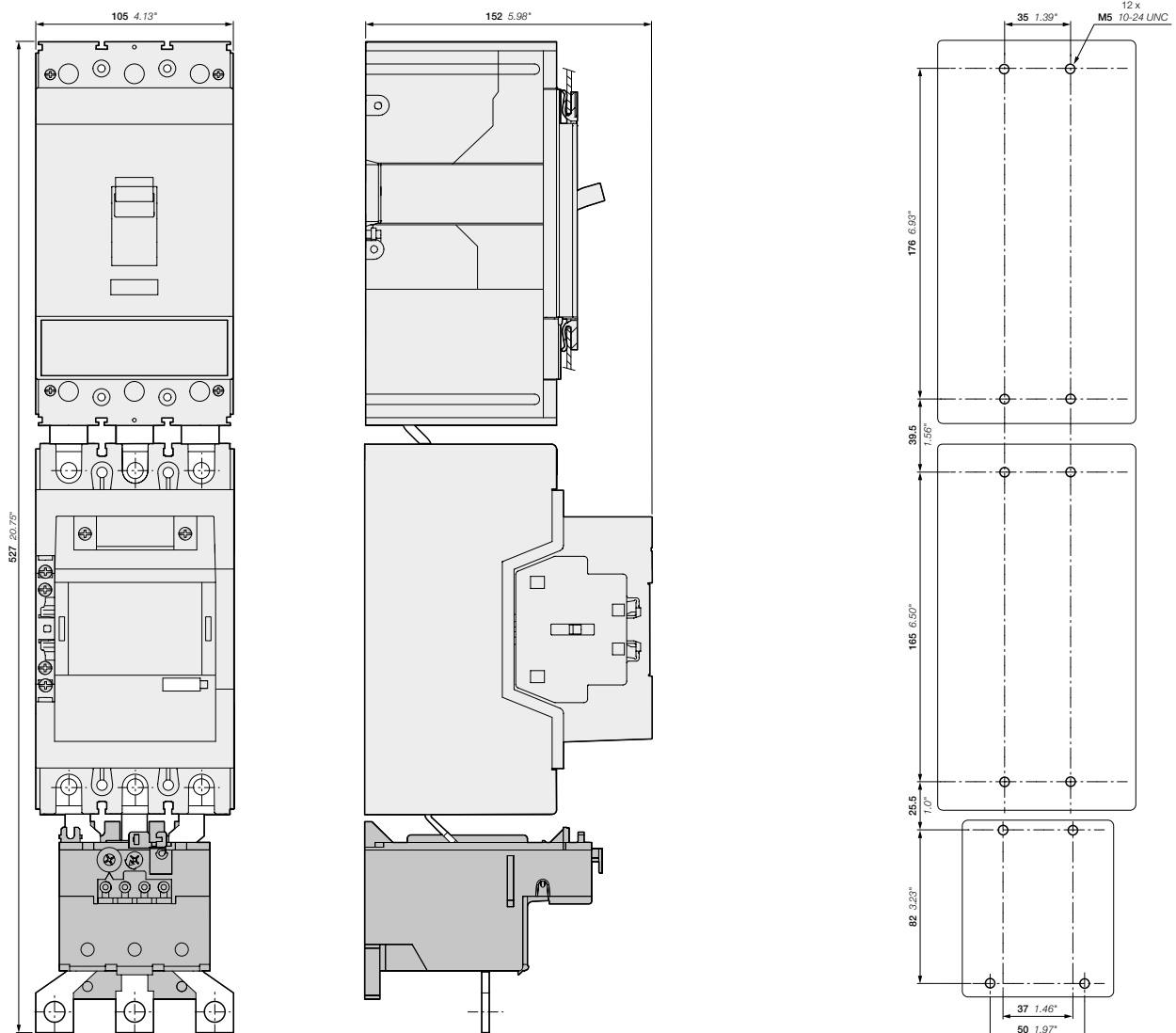

- T4S
- + BEA205/T4
- + AF190, AF205
- + TA200DU thermal overload relay

Main dimensions mm, inches

# DOL starters protected by MCCB (magnetic only) and electronic overload relays

With AF contactors - Open type version in kit form

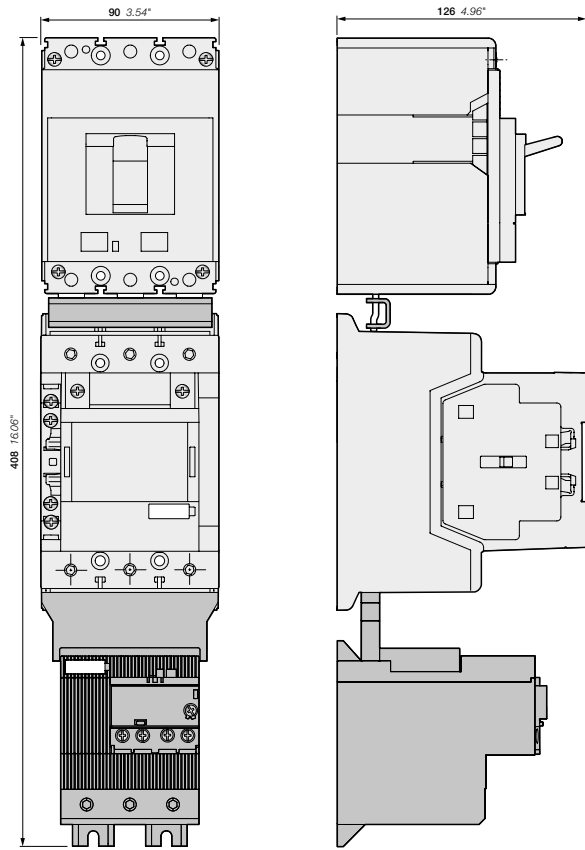

- XT2S
- + BEA140/XT2
- + AF116, AF140, AF146
- + EF146 electronic overload relay

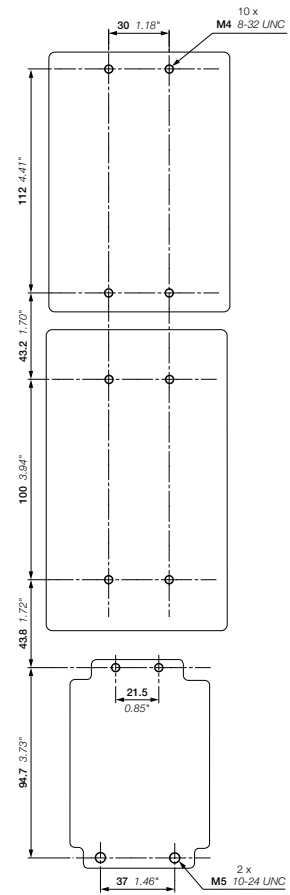

Main dimensions mm, inches

# DOL starters protected by MCCB (magnetic only) and electronic overload relays

With AF contactors - Open type version in kit form

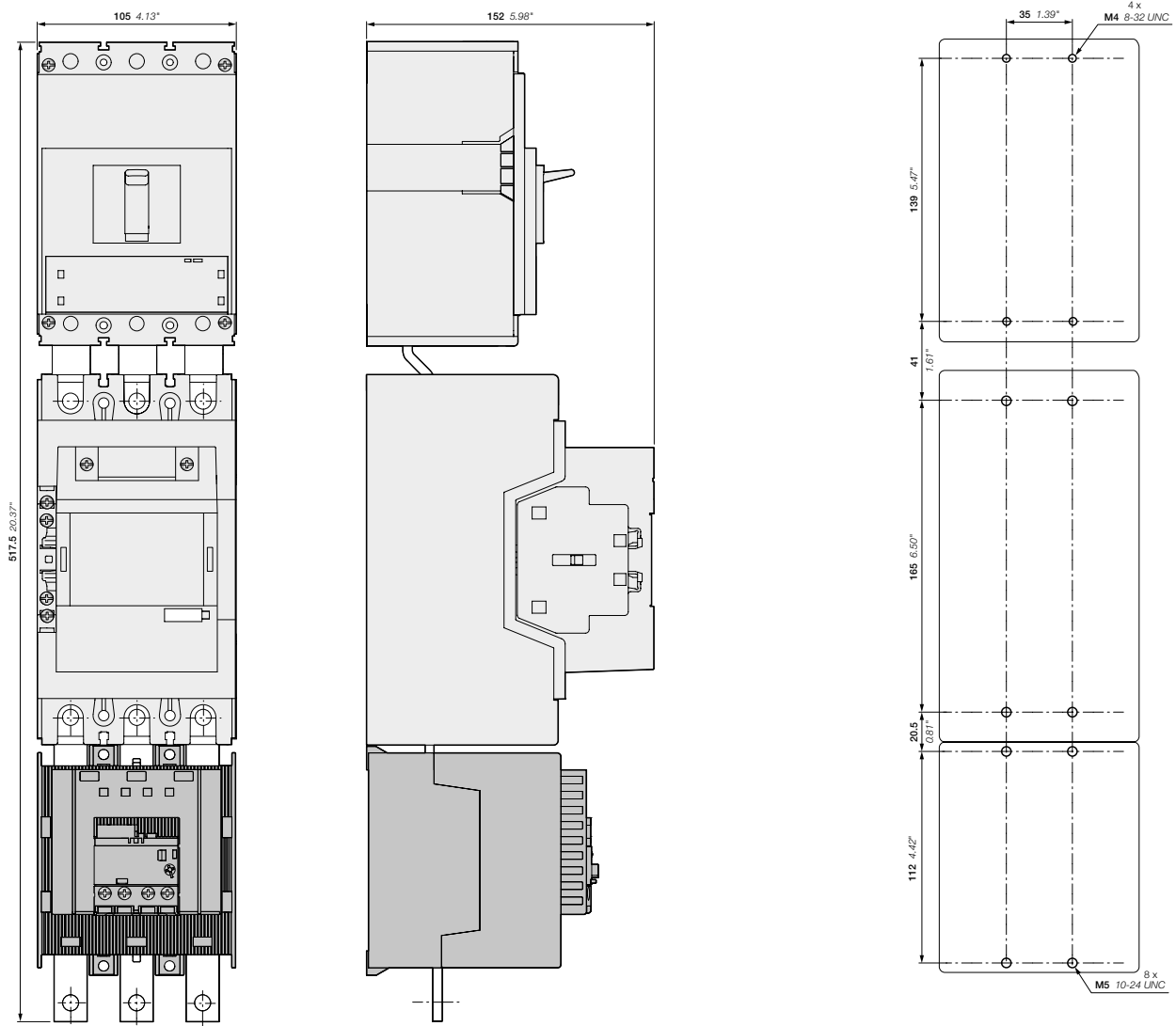

- XT4S
- + BEA205/XT4
- + AF190, AF205
- + EF205 electronic overload relay

Main dimensions mm, inches

# DOL starters protected by MCCB (magnetic only) and electronic overload relays

With AF contactors - Open type version in kit form

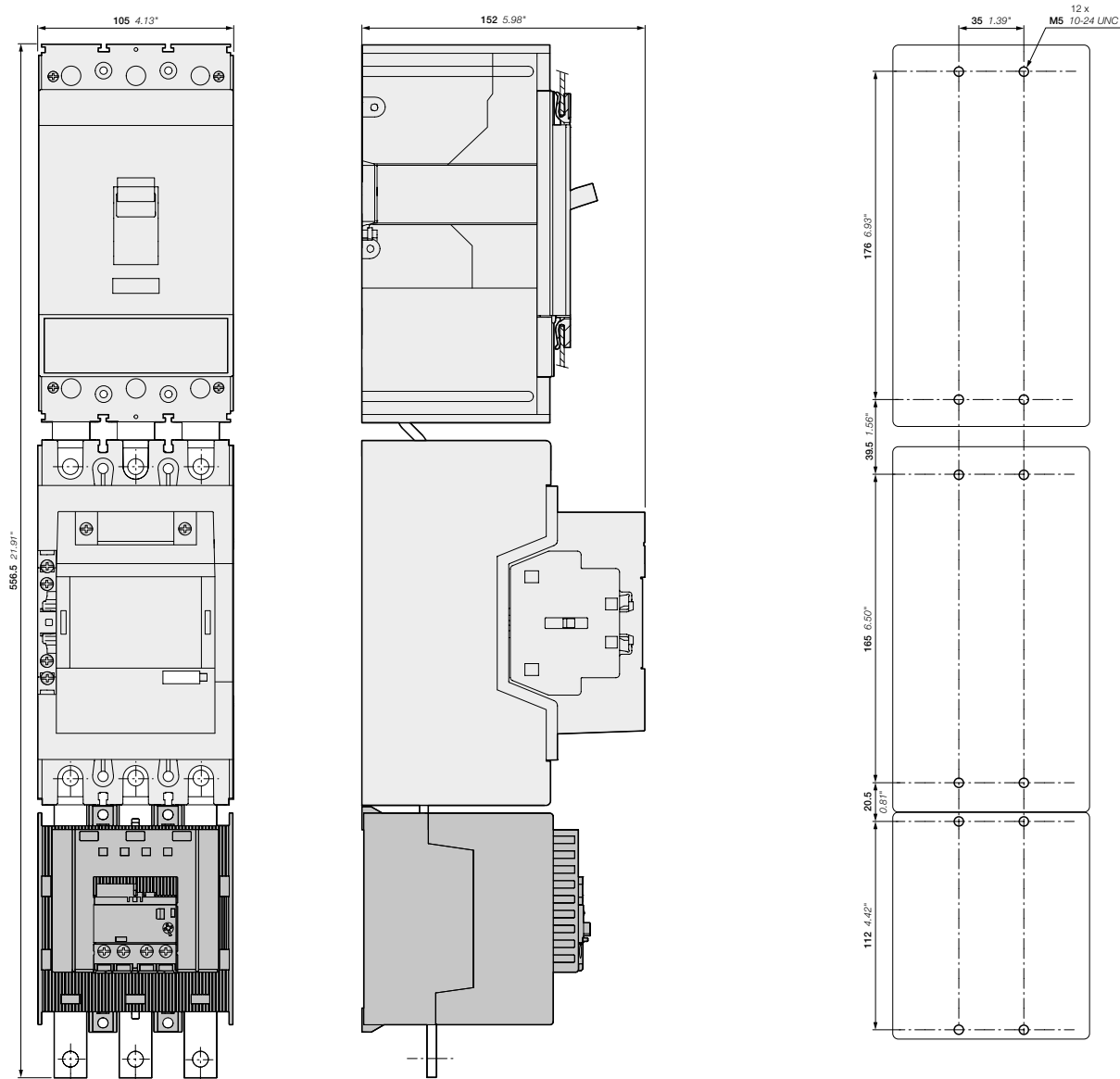

- T4S
- + BEA205/T4
- + AF190, AF205
- + EF205 electronic overload relay

# DOL starters protected by MCCB (magnetic only) and electronic overload relays

With AF contactors - Open type version in kit form

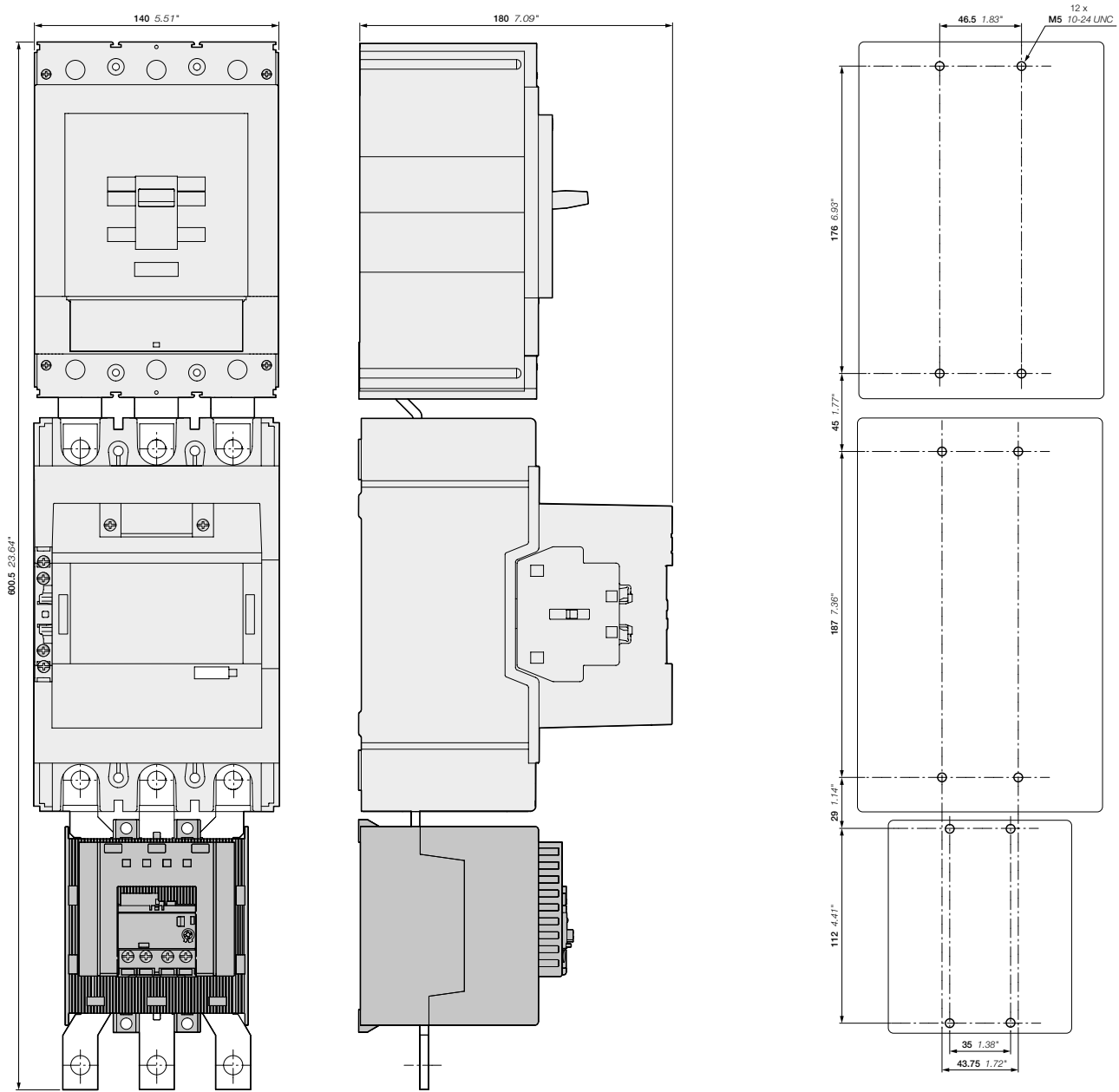

- T55
- + BEA370/T5
- + AF265, AF305, AF370
- + EF370 electronic overload relay

Main dimensions mm, inches



# DOL and reversing starters protected by overload relays

With AF contactors - Open type version in kit form



AF09-30-10 + TF42

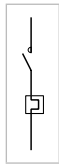

### Application

Full voltage direct-on-line and reversing starting for controlling three-phase asynchronous motors is a simple and economic solution characterised by a high starting torque (1.9 to 2.1 times full-speed torque) and a starting current 5.5 to 7 times nominal current.

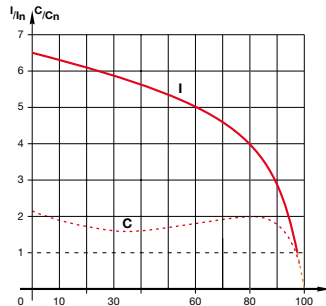

I = current  
C = torque  
In = nominal current  
Cn = nominal torque



AF140-30-11 + TF140DU

### Coordination Types

The contactor, the short-circuit protection device and the thermal overload relay control and protect motors against overload and short-circuits according to coordination types 1 and 2 (IEC 60947-4-1 / EN 60947-4-1) defining the anticipated level of service continuity as follow:

**Type 1:** In short-circuit conditions, the contactor or starter does not endanger persons or installations and will not be able to then operate without being repaired or having parts replaced.

**Type 2:** In short-circuit conditions, the contactor or starter does not endanger persons or installations and will be able to operate afterwards. The risk of contacts light welding is acceptable.

### Main Technical Data

Standards	IEC 60947-4-1 / EN 60947-4-1
Rated operational voltage Ue max.	690 V - 50/60 Hz
Rated insulation voltage Ui	
acc. to IEC 60947-4-1	690 V
acc. to UL / CSA	600 V
Ambient air temperature	
Close to the device	≤ 60 °C (TF42: 38 A above ≤ 50 °C)
Degree of protection	IP20
Switching frequency	Refer to "Switching frequency diagrams" page

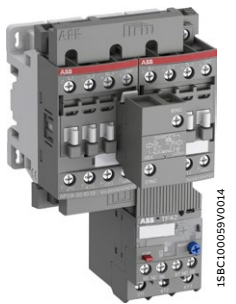

AF09-30-10 + BER16-4 + VEM4 + TF42



AF140-30-11 + BER140-4 + VM19 + TF140DU

### Mounting positions

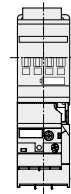

Pos. 1  
Direct-on-line

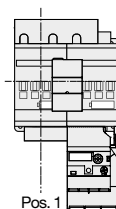

Pos. 1  
Reversing

## DOL and reversing starters protected by overload relays

With AF contactors - Open type version in kit form

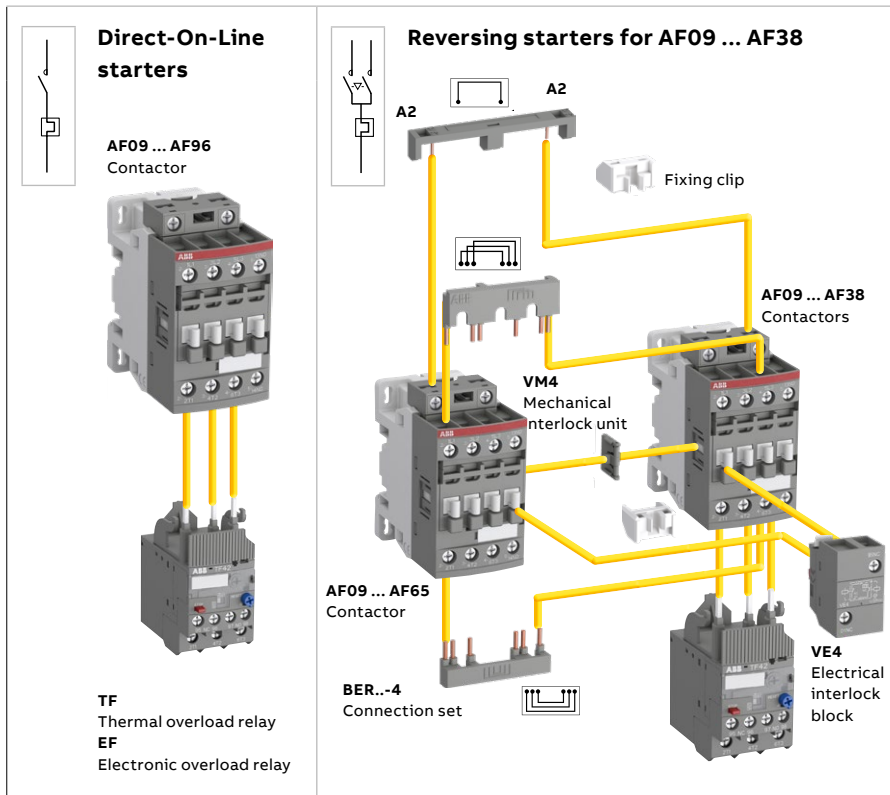

You can easily assemble a direct-on-line starter by connecting AF contactor and TF thermal overload relay or EF electronic overload relay.

You can also easily assemble reversing starter thanks to our complete range of accessories:

- For AF09 ... AF38, use VEM4 mechanical and electrical interlock set for reversing starter in 90 mm width.
- It includes:
  - VM4 mechanical interlock unit including 2 fixing clips
  - VE4 electrical interlock block with A2-A2 connection.
- For AF40 ... AF370, use VM mechanical interlock unit and additional auxiliary contact blocks for electrical interlocking.
- BER...-4 connection set: it assures a safe and simple reversing connection between both contactor main terminals.

Select now easily and quickly your starter in the following pages at 400 V, up to 200 kW.

For the full coordination tables, please visit our SOC tool : <https://applications.it.abb.com/SOC/Selectivity>

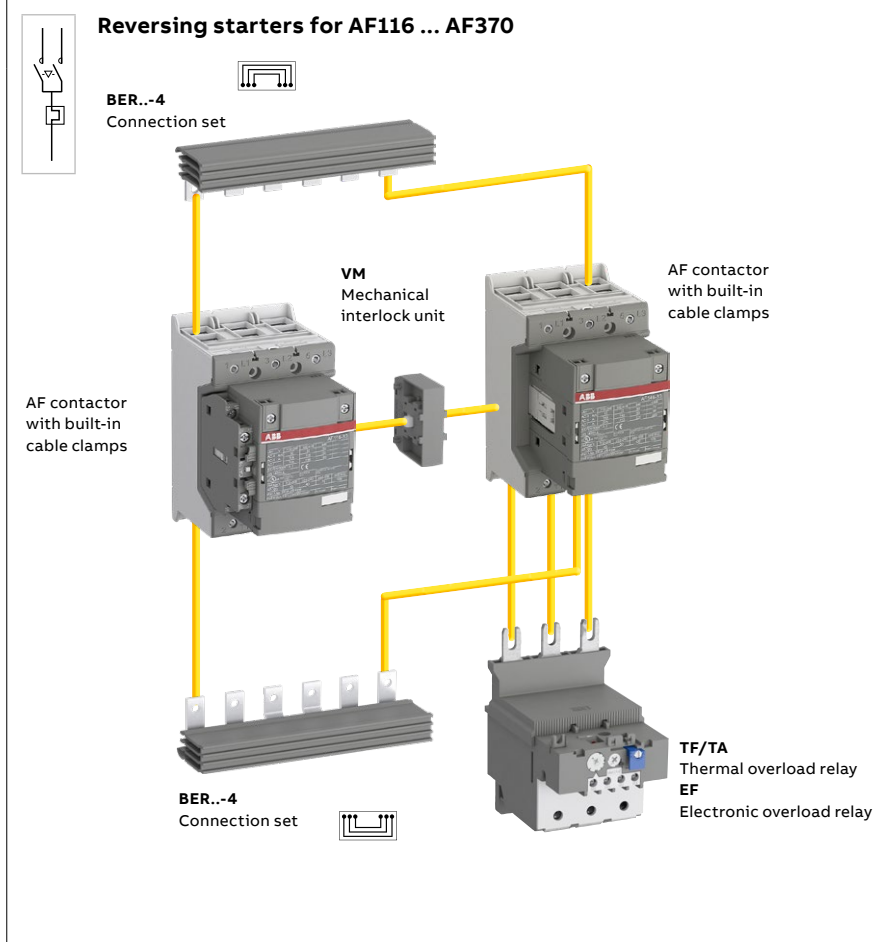

## Direct-on-line starters protected by thermal overload relays

With AF contactors - Open type version in kit form

IEC AC-3, 400 V Rated power kW		Rated current A		Control voltage Uc min. ... Uc max. (1)				Type			Order code			Setting ranges			Type			Order code		
				V 50/60 Hz		V DC (2)								A								
4	8.5	24...60	20...60	AF09Z-30-10-11	1SBL136001R1110	7.60...10.0	TF42-10	1SAZ711201R1043														
		100...250	100...250	AF09-30-10-13	1SBL137001R1310																	
5.5	11.5	24...60	20...60	AF12Z-30-10-11	1SBL156001R1110	10.0...13.0	TF42-13	1SAZ711201R1045														
		100...250	100...250	AF12-30-10-13	1SBL157001R1310																	
7.5	15.5	24...60	20...60	AF16Z-30-10-11	1SBL176001R1110	13.0...16.0	TF42-16	1SAZ711201R1047														
		100...250	100...250	AF16-30-10-13	1SBL177001R1310																	
11	22	24...60	20...60	AF26Z-30-00-11	1SBL236001R1100	20.0...24.0	TF42-24	1SAZ711201R1051														
		100...250	100...250	AF26-30-00-13	1SBL237001R1300																	
15	29	24...60	20...60	AF30Z-30-00-11	1SBL276001R1100	29.0...35.0	TF42-35	1SAZ711201R1053														
		100...250	100...250	AF30-30-00-13	1SBL277001R1300																	
18.5	35	24...60	20...60	AF38Z-30-00-11	1SBL296001R1100	35.0...38.0/40.0	TF42-38	1SAZ711201R1055														
		100...250	100...250	AF38-30-00-13	1SBL297001R1300																	
18.5	35	24...60	20...60	AF40-30-00-11	1SBL347001R1100	30.0...40.0	TF65-40	1SAZ811201R1003														
		100...250	100...250	AF40-30-00-13	1SBL347001R1300																	
22	41	24...60	20...60	AF52-30-00-11	1SBL367001R1100	36.00...47.0	TF65-47	1SAZ811201R1004														
		100-250	100-250	AF52-30-00-13	1SBL367001R1300																	
30	55	24...60	20...60	AF65-30-00-11	1SBL387001R1100	50.0...60.0	TF65-60	1SAZ811201R1006														
		100-250	100-250	AF65-30-00-13	1SBL387001R1300																	
37	66	24...60	20...60	AF80-30-00-11	1SBL397001R1100	57.0...68.0	TF96-68	1SAZ911201R1003														
		100-250	100-250	AF80-30-00-13	1SBL397001R1300																	
45	80	24...60	20...60	AF96-30-00-11	1SBL407001R1100	75.0...87.0	TF96-87	1SAZ911201R1005														
		100-250	100-250	AF96-30-00-13	1SBL407001R1300																	
55	97	24...60	20...60	AF116-30-11-11	1SFL427001R1111	80...110	TF140DU-110	1SAZ431201R1002														
		100-250	100-250	AF116-30-11-13	1SFL427001R1311																	
75	132	24...60	20...60	AF140-30-11-11	1SFL447001R1111	100...135	TF140DU-135	1SAZ431201R1003														
		100-250	100-250	AF140-30-11-13	1SFL447001R1311																	
90	160	24...60	20...60	AF190-30-11-11	1SFL487002R1111	130...175	TA200DU-175	1SAZ411201R1005														
		100-250	100-250	AF190-30-11-13	1SFL487002R1311																	
110	195	24...60	20...60	AF205-30-11-11	1SFL527002R1111	150...200	TA200DU-200	1SAZ411201R1006														
		100-250	100-250	AF205-30-11-13	1SFL527002R1311																	

(1) For other control voltages, see "Voltage code table".  
 Note : for rated power above 110 kW, refer to "Starters protected by electronic overload relays".  
 (2) AF ... -11 not suitable for direct control by PLC-output.

# Reversing starters protected by thermal overload relays

With AF contactors - Open type version in kit form

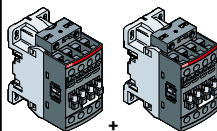
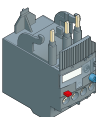
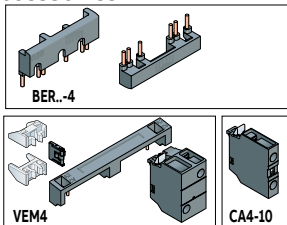
		 <b>Contactors</b> 				 <b>Thermal overload relays</b>			 <b>Accessories</b>		
IEC AC-3, 400 V	Rated power kW	Rated current A	Control voltage Uc min. ... Uc max. (1)		Type	Order code	Setting ranges  A	Type	Order code	Type	Order code
			V 50/60 Hz	V DC							
4	8.5		24...60	20...60	AF09Z-30-10-11	1SBL136001R1110	7.60...10.0	TF42-10	1SAZ711201R1043	+ BER16-4 + VEM4	1SBN081311R1000 1SBN030111R1000
			100...250	100...250	AF09-30-10-13	1SBL137001R1310					
5.5	11.5		24...60	20...60	AF12Z-30-10-11	1SBL156001R1110	10.0...13.0	TF42-13	1SAZ711201R1045		
			100...250	100...250	AF12-30-10-13	1SBL157001R1310					
7.5	15.5		24...60	20...60	AF16Z-30-10-11	1SBL176001R1110	13.0...16.0	TF42-16	1SAZ711201R1047		
			100...250	100...250	AF16-30-10-13	1SBL177001R1310					
11	22		24...60	20...60	AF26Z-30-00-11	1SBL236001R1100	20.0...24.0	TF42-24	1SAZ711201R1051	+ BER38-4 + VEM4	1SBN082311R1000 1SBN030111R1000
			100...250	100...250	AF26-30-00-13	1SBL237001R1300					
15	29		24...60	20...60	AF30Z-30-00-11	1SBL276001R1100	29.0...35.0	TF42-35	1SAZ711201R1053	+ 2x CA4-10	1SBN010110R1010
			100...250	100...250	AF30-30-00-13	1SBL277001R1300					
18.5	35		24...60	20...60	AF38Z-30-00-11	1SBL296001R1100	35.0...38.0/40.0	TF42-38	1SAZ711201R1055		
			100...250	100...250	AF38-30-00-13	1SBL297001R1300					
18.5	35		24...60	20...60	AF40-30-00-11	1SBL347001R1100	30.0...40.0	TF65-40	1SAZ811201R1003	+ BER65-4 + VM96-4	1SBN083411R1000 1SBN033405T1000
			100...250	100...250	AF40-30-00-13	1SBL347001R1300					
22	41		24...60	20...60	AF52-30-00-11	1SBL367001R1100	36.00...47.0	TF65-47	1SAZ811201R1004	+ 2x CA4-10 + 2x CA4-01	1SBN010110R1010 1SBN010110R1001
			100...250	100...250	AF52-30-00-13	1SBL367001R1300					
30	55		24...60	20...60	AF65-30-00-11	1SBL387001R1100	50.0...60.0	TF65-60	1SAZ811201R1006		
			100...250	100...250	AF65-30-00-13	1SBL387001R1300					
37	66		24...60	20...60	AF80-30-00-11	1SBL397001R1100	57.0...68.0	TF96-68	1SAZ911201R1003	+ BER96-4 + VM96-4	1SBN083911R1000 1SBN033405T1000
			100...250	100...250	AF80-30-00-13	1SBL397001R1300					
45	80		24...60	20...60	AF96-30-00-11	1SBL407001R1100	75.0...87.0	TF96-87	1SAZ911201R1005	+ 2x CA4-10 + 2x CA4-01	1SBN010110R1010 1SBN010110R1001
			100...250	100...250	AF96-30-00-13	1SBL407001R1300					
55	97		24...60	20...60	AF116-30-11-11	1SFL427001R1111	80...110	TF140DU-110	1SAZ431201R1002	+ BER140-4 + VM19	1SFN084111R1000 1SFN030300R1000
			100...250	100...250	AF116-30-11-13	1SFL427001R1311					
75	132		24...60	20...60	AF140-30-11-11	1SFL447001R1111	100...135	TF140DU-135	1SAZ431201R1003		
			100...250	100...250	AF140-30-11-13	1SFL447001R1311					
90	160		24...60	20...60	AF190-30-11-11	1SFL487002R1111	130...175	TA200DU-175	1SAZ411201R1005	+ BER205-4 + VM19	1SFN084811R1000 1SFN030300R1000
			100...250	100...250	AF190-30-11-13	1SFL487002R1311					
110	195		24...60	20...60	AF205-30-11-11	1SFL527002R1111	150...200	TA200DU-200	1SAZ411201R1006		
			100...250	100...250	AF205-30-11-13	1SFL527002R1311					

(1) For other control voltages, see "Voltage code table".  
 Note : for rated power above 110 kW, refer to "Starters protected by electronic overload relays".  
 (2) AF ... -11 not suitable for direct control by PLC-output.

## Direct-on-line starters protected by electronic overload relays

With AF contactors - Open type version in kit form

IEC AC-3, 400 V Rated power kW		Control voltage		Type	Order code	Setting ranges		Type	Order code
		Uc min. ... Uc max. (1)				A			
4	8.5	24...60	20...60	AF09Z-30-10-11	1SBL136001R1110	5.70...18.9	EF19-18.9	1SAX111001R1105	
		100...250	100...250	AF09-30-10-13	1SBL137001R1310				
5.5	11.5	24...60	20...60	AF12Z-30-10-11	1SBL156001R1110	5.70...18.9	EF19-18.9	1SAX111001R1105	
		100...250	100...250	AF12-30-10-13	1SBL157001R1310				
7.5	15.5	24...60	20...60	AF16Z-30-10-11	1SBL176001R1110	5.70...18.9	EF19-18.9	1SAX111001R1105	
		100...250	100...250	AF16-30-10-13	1SBL177001R1310				
11	22	24...60	20...60	AF26Z-30-00-11	1SBL236001R1100	9.00...30.0	EF45-30	1SAX211001R1101	
		100...250	100...250	AF26-30-00-13	1SBL237001R1300				
15	29	24...60	20...60	AF30Z-30-00-11	1SBL276001R1100	9.00...30.0	EF45-30	1SAX211001R1101	
		100...250	100...250	AF30-30-00-13	1SBL277001R1300				
18.5	35	24...60	20...60	AF38Z-30-00-11	1SBL296001R1100	15.0...45.0	EF45-45	1SAX211001R1102	
		100...250	100...250	AF38-30-00-13	1SBL297001R1300				
18.5	35	24...60	20...60	AF40-30-00-11	1SBL347001R1100	25.0...70.0	EF65-70	1SAX331001R1101	
		100...250	100...250	AF40-30-00-13	1SBL347001R1300				
22	41	24...60	20...60	AF52-30-00-11	1SBL367001R1100	25.0...70.0	EF65-70	1SAX331001R1101	
		100-250	100-250	AF52-30-00-13	1SBL367001R1300				
30	55	24...60	20...60	AF65-30-00-11	1SBL387001R1100	25.0...70.0	EF65-70	1SAX331001R1101	
		100-250	100-250	AF65-30-00-13	1SBL387001R1300				
37	66	24...60	20...60	AF80-30-00-11	1SBL397001R1100	36...100	EF96-100	1SAX341001R1101	
		100-250	100-250	AF80-30-00-13	1SBL397001R1300				
45	80	24...60	20...60	AF96-30-00-11	1SBL407001R1100	36...100	EF96-100	1SAX341001R1101	
		100-250	100-250	AF96-30-00-13	1SBL407001R1300				
55	97	24...60	20...60	AF116-30-11-11	1SFL427001R1111	54...150	EF146-150	1SAX351001R1101	
		100-250	100-250	AF116-30-11-13	1SFL427001R1311				
75	132	24...60	20...60	AF140-30-11-11	1SFL447001R1111	54...150	EF146-150	1SAX351001R1101	
		100-250	100-250	AF140-30-11-13	1SFL447001R1311				
90	160	24...60	20...60	AF190-30-11-11	1SFL487002R1111	63...110	EF205-110	1SAX531001R1101	
		100-250	100-250	AF190-30-11-13	1SFL487002R1311				
110	195	24...60	20...60	AF205-30-11-11	1SFL527002R1111	63...110	EF205-110	1SAX531001R1101	
		100-250	100-250	AF205-30-11-13	1SFL527002R1311				
132	230	24...60	20...60	AF265-30-11-11	1SFL547002R1111	115...380	EF370-380	1SAX611001R1101	
		100-250	100-250	AF265-30-11-13	1SFL547002R1311				
160	280	24...60	20...60	AF305-30-11-11	1SFL587002R1111	115...380	EF370-380	1SAX611001R1101	
		100-250	100-250	AF305-30-11-13	1SFL587002R1311				
200	350	24...60	20...60	AF370-30-11-11	1SFL607002R1111	115...380	EF370-380	1SAX611001R1101	
		100-250	100-250	AF370-30-11-13	1SFL607002R1311				

(1) For other control voltages, see "Voltage code table".  
 (2) AF ... -11 not suitable for direct control by PLC-output.

# Reversing starters protected by electronic overload relays

With AF contactors - Open type version in kit form

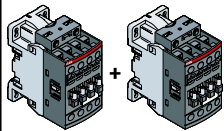
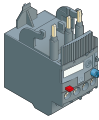
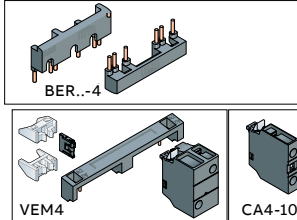
		 <b>Contactors</b> 			 <b>Electronic overload relays</b>			 <b>Accessories</b>		
IEC	Control voltage		Type	Order code	Setting ranges	Type	Order code	Type	Order code	
	AC-3, 400 V	Rated power kW								Rated current A
		V 50/60 Hz	V DC							
4	8.5	24...60	20...60	AF09Z-30-10-11	1SBL136001R1110	5.70...18.9	EF19-18.9	1SAX111001R1105	BER16-4 + VEM4	1SBN081311R1000 1SBN030111R1000
		100...250	100...250	AF09-30-10-13	1SBL137001R1310					
5.5	11.5	24...60	20...60	AF12Z-30-10-11	1SBL156001R1110	5.70...18.9	EF19-18.9	1SAX111001R1105		
		100...250	100...250	AF12-30-10-13	1SBL157001R1310					
7.5	15.5	24...60	20...60	AF16Z-30-10-11	1SBL176001R1110	5.70...18.9	EF19-18.9	1SAX111001R1105		
		100...250	100...250	AF16-30-10-13	1SBL177001R1310					
11	22	24...60	20...60	AF26Z-30-00-11	1SBL236001R1100	9.00...30.0	EF45-30	1SAX211001R1101	BER38-4 + VEM4	1SBN082311R1000 1SBN030111R1000
		100...250	100...250	AF26-30-00-13	1SBL237001R1300				+ 2x CA4-10	1SBN010110R1010
15	29	24...60	20...60	AF30Z-30-00-11	1SBL276001R1100	9.00...30.0	EF45-30	1SAX211001R1101		
		100...250	100...250	AF30-30-00-13	1SBL277001R1300					
18.5	35	24...60	20...60	AF38Z-30-00-11	1SBL296001R1100	15.0...45.0	EF45-45	1SAX211001R1102		
		100...250	100...250	AF38-30-00-13	1SBL297001R1300					
18.5	35	24...60	20...60	AF40-30-00-11	1SBL347001R1100	25.0...70.0	EF65-70	1SAX331001R1101	BER65-4 + VM96-4	1SBN083411R1000 1SBN033405T1000
		100...250	100...250	AF40-30-00-13	1SBL347001R1300				+ 2x CA4-10	1SBN010110R1010
22	41	24...60	20...60	AF52-30-00-11	1SBL367001R1100	25.0...70.0	EF65-70	1SAX331001R1101	+ 2x CA4-01	1SBN010110R1001
		100...250	100...250	AF52-30-00-13	1SBL367001R1300					
30	55	24...60	20...60	AF65-30-00-11	1SBL387001R1100	25.0...70.0	EF65-70	1SAX331001R1101		
		100...250	100...250	AF65-30-00-13	1SBL387001R1300					
37	66	24...60	20...60	AF80-30-00-11	1SBL397001R1100	36...100	EF96-100	1SAX341001R1101	BER96-4 + VM96-4	1SBN083911R1000 1SBN033405T1000
		100...250	100...250	AF80-30-00-13	1SBL397001R1300				+ 2x CA4-10	1SBN010110R1010
45	80	24...60	20...60	AF96-30-00-11	1SBL407001R1100	36...100	EF96-100	1SAX341001R1101	+ 2x CA4-01	1SBN010110R1001
		100...250	100...250	AF96-30-00-13	1SBL407001R1300					
55	97	24...60	20...60	AF116-30-11-11	1SFL427001R1111	54...150	EF146-150	1SAX351001R1101	BER140-4 + VM19	1SFN084111R1000 1SFN030300R1000
		100...250	100...250	AF116-30-11-13	1SFL427001R1311					
75	132	24...60	20...60	AF140-30-11-11	1SFL447001R1111	54...150	EF146-150	1SAX351001R1101		
		100...250	100...250	AF140-30-11-13	1SFL447001R1311					
90	160	24...60	20...60	AF190-30-11-11	1SFL487002R1111	63...110	EF205-110	1SAX531001R1101	BER205-4 + VM19	1SFN084811R1000 1SFN030300R1000
		100...250	100...250	AF190-30-11-13	1SFL487002R1311					
110	195	24...60	20...60	AF205-30-11-11	1SFL527002R1111	63...110	EF205-110	1SAX531001R1101		
		100...250	100...250	AF205-30-11-13	1SFL527002R1311					
132	230	24...60	20...60	AF265-30-11-11	1SFL547002R1111	115...380	EF370-380	1SAX611001R1101	BER370-4 + VM19	1SFN085411R1000 1SFN030300R1000
		100...250	100...250	AF265-30-11-13	1SFL547002R1311					
160	280	24...60	20...60	AF305-30-11-11	1SFL587002R1111	115...380	EF370-380	1SAX611001R1101		
		100...250	100...250	AF305-30-11-13	1SFL587002R1311					
200	350	24...60	20...60	AF370-30-11-11	1SFL607002R1111	115...380	EF370-380	1SAX611001R1101		
		100...250	100...250	AF370-30-11-13	1SFL607002R1311					

(1) For other control voltages, see "Voltage code table".  
 (2) AF ... -11 not suitable for direct control by PLC-output.

## DOL and reversing starters protected by overload relays

With AF contactors - Open type version in kit form  
Switching frequency diagrams

### General

Overload relays cannot be operated at any arbitrary switching frequency in order to avoid tripping. Applications involving up to 15 operations per hour are acceptable. Higher switching frequencies are permitted if the duty ratio and the motor starting time are allowed for and if the motor's making current does not appreciably exceed 6 times the rated operating current. Please refer to the adjacent diagram for guideline values for the permitted switching frequency.

### Thermal overload relay

Intermittent periodic duty

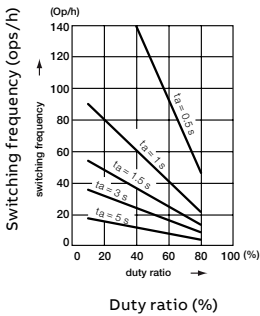

#### Example:

Starting time of the motor: 1 second - Duty ratio: 40 % means a permitted switching frequency of max. 60 operating cycles per hour.

ta: motor starting time

### Electronic overload relay

Intermittent periodic duty

Trip class 10E

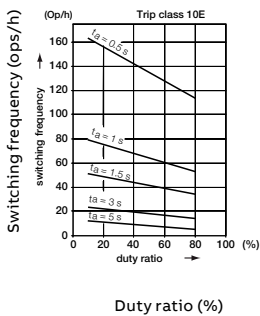

Duty ratio (%)

ta: motor starting time

Trip class 20E

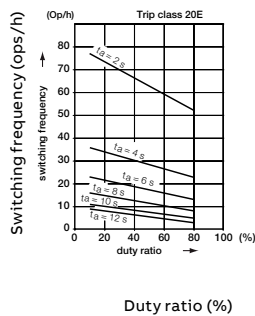

Duty ratio (%)

Trip class 30E

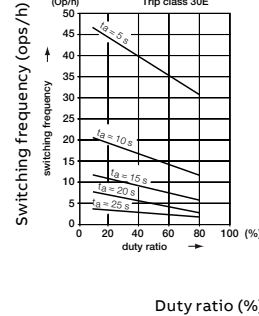

Duty ratio (%)

### Example for trip class 10E:

Starting time of the motor: 1 second. Duty ratio: 60 % means a permitted switching frequency of max. 60 operating cycles per hour, for a motor breaking current not exceeding 6 x In.

# DOL and reversing starters protected by overload relays

With AF contactors - Open type version in kit form  
Wiring diagrams

## Direct-on-line starters

Power circuit

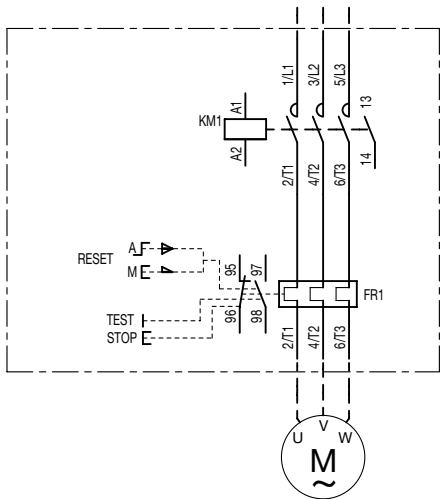

1-phase

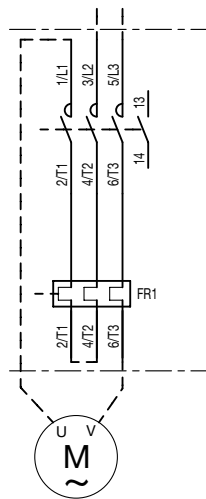

AC or DC local control

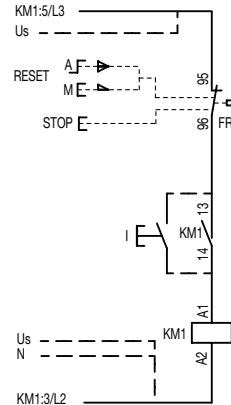

AC or DC remote control

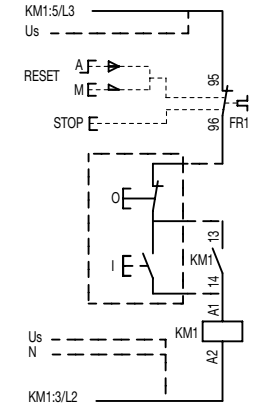

Note: coil Uc 12-20 V DC : A1+, A2-

## Reversing starters

Power circuit

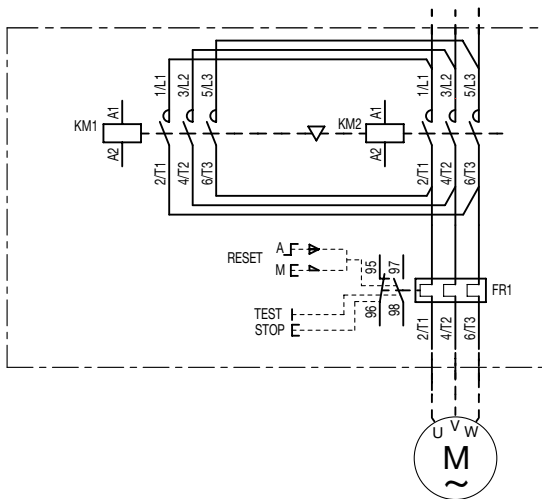

AC or DC local control

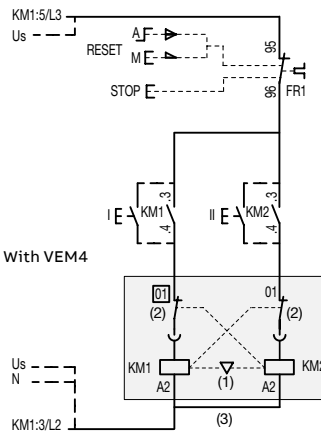

With VM

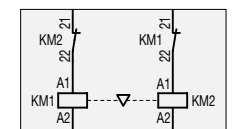

AC or DC remote control

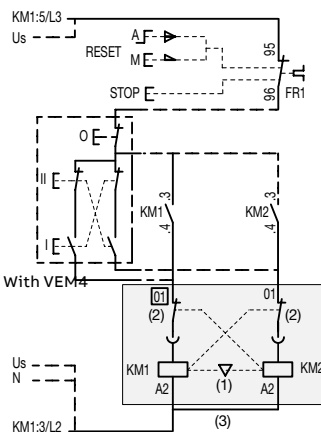

With VM

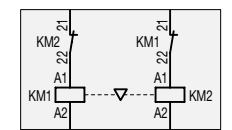

Note: - VEM4 = VM4 (1) + VE4 (2) with A2-A2 (3) connection  
(Except for coil Uc 12-20 V DC : use VM4 with CA4).  
- coil Uc 12-20 V DC : A1+, A2-



# DOL starters protected by thermal overload relays

With AF contactors - open type version in kit form

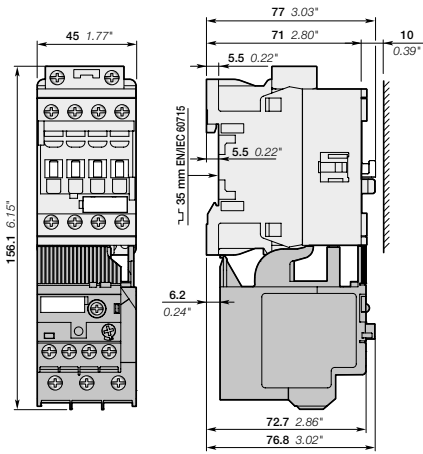

AF09, AF12, AF16 + TF42 thermal overload relay

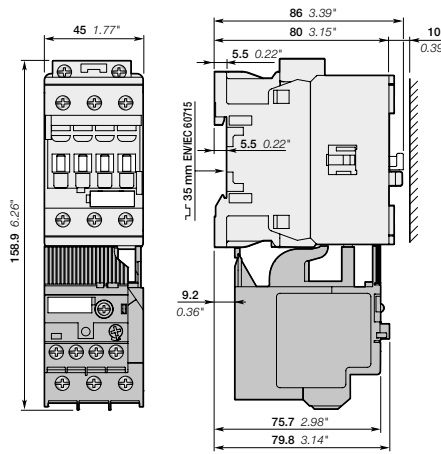

AF26, AF30, AF38 + TF42 thermal overload relay

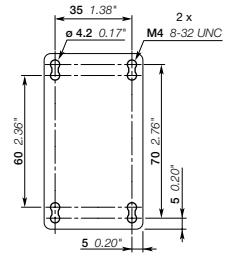

Note: contactor lateral distance to grounded component 2 mm 0.08" min.

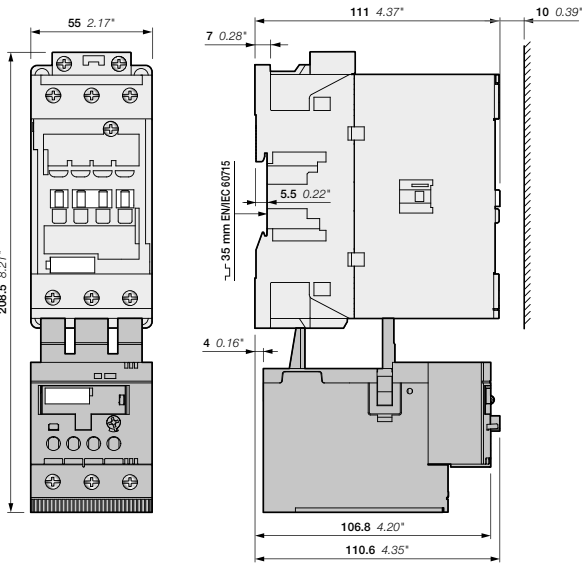

AF40, AF52, AF65 + TF65 thermal overload relay

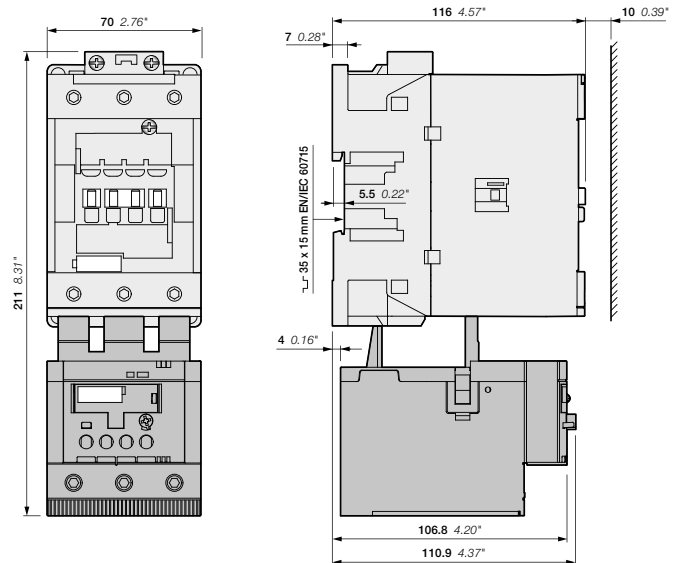

AF80, AF96 + TF96 thermal overload relay

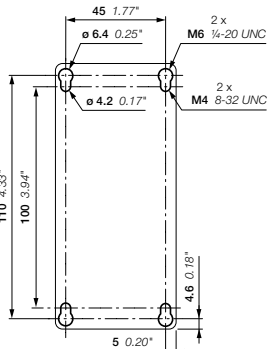

AF40, AF52, AF65 + TF65 thermal overload relay

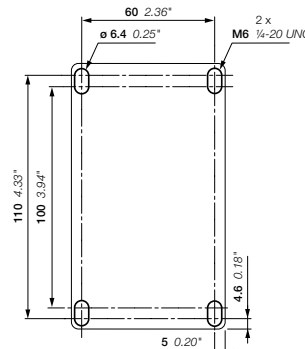

AF80, AF96 + TF96 thermal overload relay

Main dimensions mm, inches

# DOL starters protected by thermal overload relays

With AF contactors - open type version in kit form

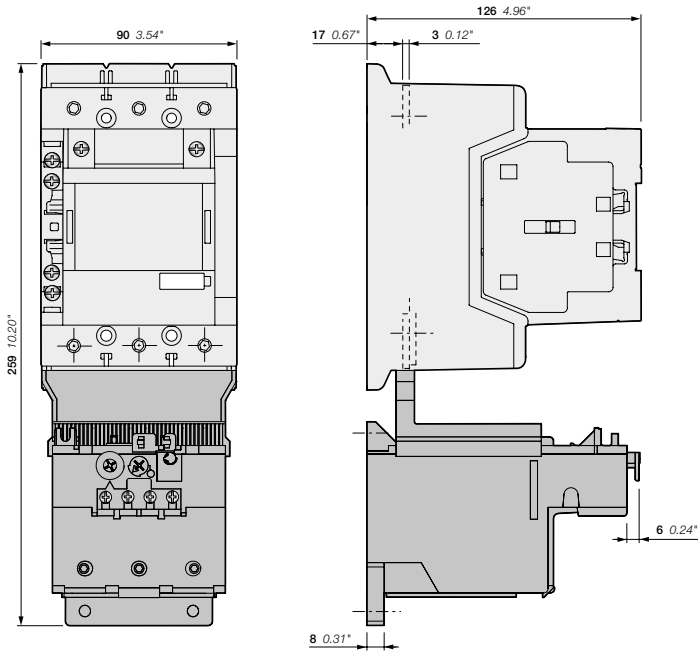

AF116, AF140-30-11(B)  
+ TF140 thermal overload relay

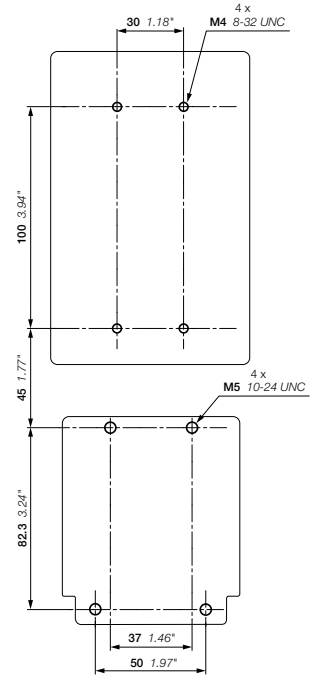

AF116, AF140-30-11(B)  
+ TF140 thermal overload relay

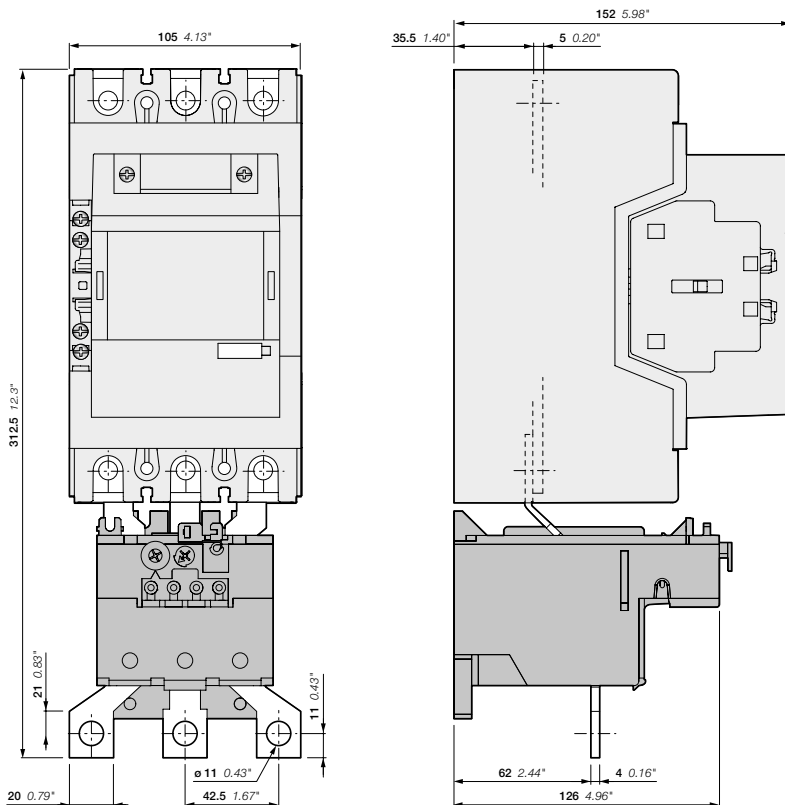

AF190, AF205-30-11  
+ TA200DU thermal overload relay

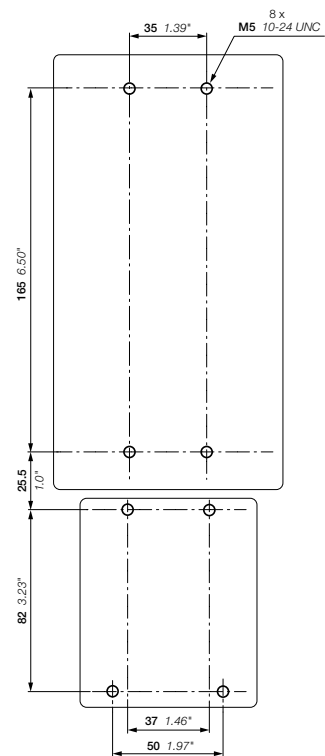

AF190, AF205  
+ TA200DU thermal overload relay

Main dimensions mm, inches

## Reversing starters protected by thermal overload relays

With AF contactors - open type version in kit form

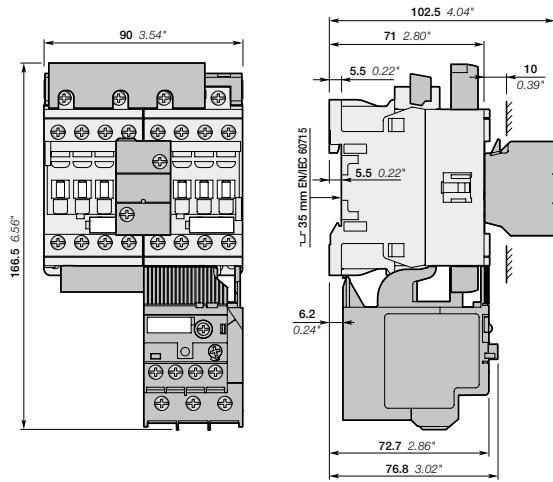

AF09, AF12, AF16  
+ BER16-4, VEM4  
+ TF42 thermal overload relay

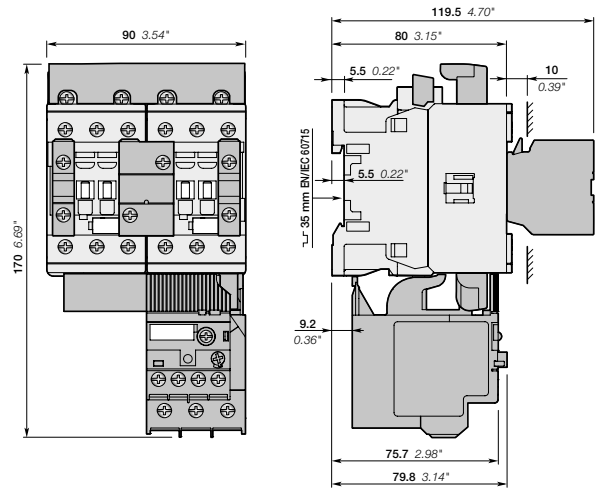

AF26, AF30, AF38  
+ BER38-4, VEM4, CA4-10  
+ TF42 thermal overload relay

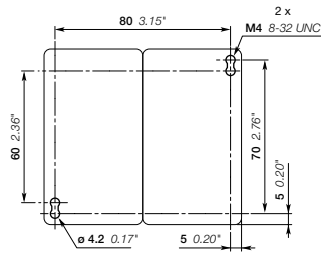

AF09, AF12, AF16, AF26, AF30, AF38

Note: contactor lateral distance to grounded component 2 mm 0.08" min.

# Reversing starters protected by thermal overload relays

With AF contactors - open type version in kit form

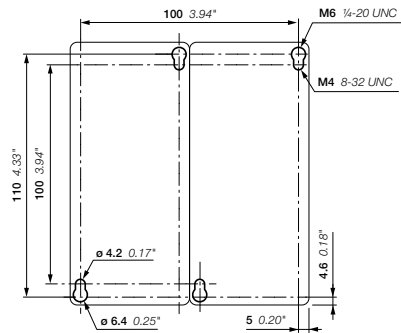
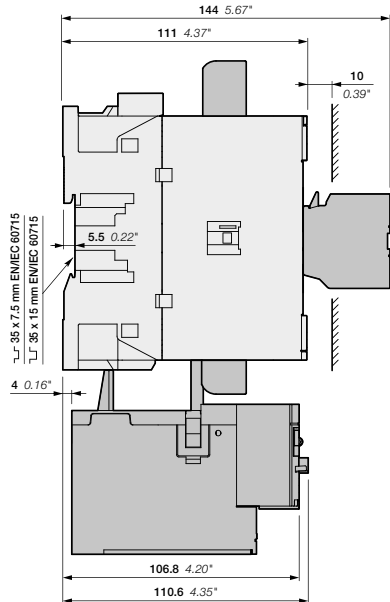
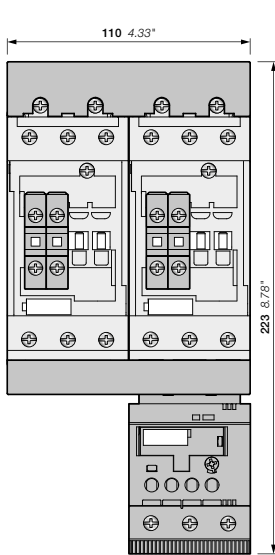

AF40, AF52, AF65  
 + BER65-4, VM96-4  
 + TF65 thermal overload relay

AF40, AF52, AF65  
 + BER65-4, VM96-4  
 + TF65 thermal overload relay

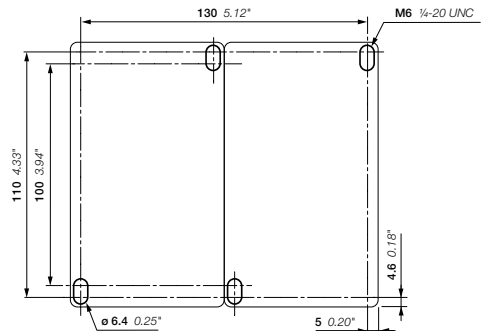
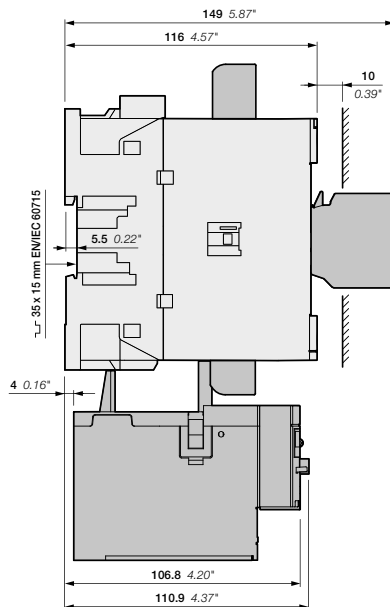
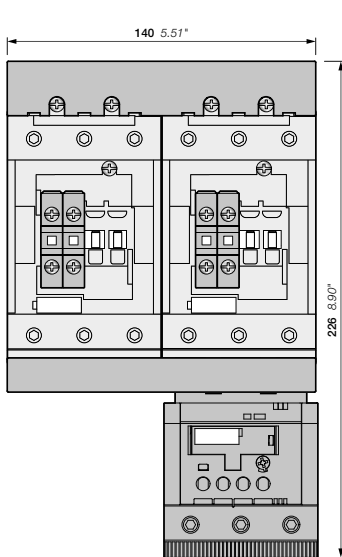

AF80, AF96  
 + BER96-4, VM96-4  
 + TF96 thermal overload relay

AF80, AF96  
 + BER96-4, VM96-4  
 + TF96 thermal overload relay

Main dimensions mm, inches

# Reversing starters protected by thermal overload relays

With AF contactors - open type version in kit form

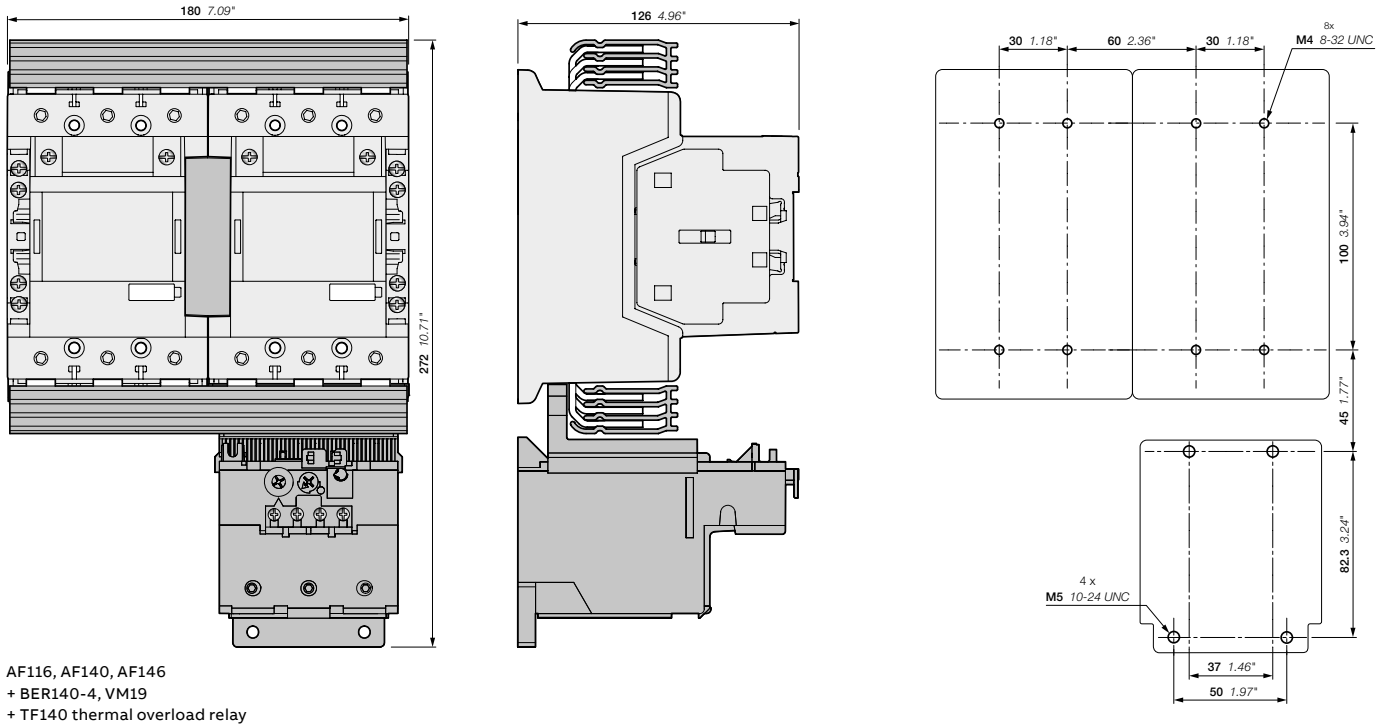

Main dimensions mm, inches





---

# Motor starting solutions

## Open type version, in kit form with screw terminals

### **Starters protected by manual motor starters**

- 12/50** Overview
- 12/52** Direct-on-line starters
- 12/56** Reversing starters
- 12/60** Dimensions

### **Starters protected by thermal overload relays**

- 12/62** Direct-on-line and reversing starters
- 12/66** Star-delta starters
- 12/70** Dimensions

### **Star-delta starters protected by overload relays**

- 12/82** Overview
- 12/84** Selection tables
- 12/88** Switching frequency diagrams
- 12/91** Main dimensions



# Motor starting solutions

Open type version, in kit form

## Starters protected by manual motor starters

### Direct-on-line starters

### Reversing starters

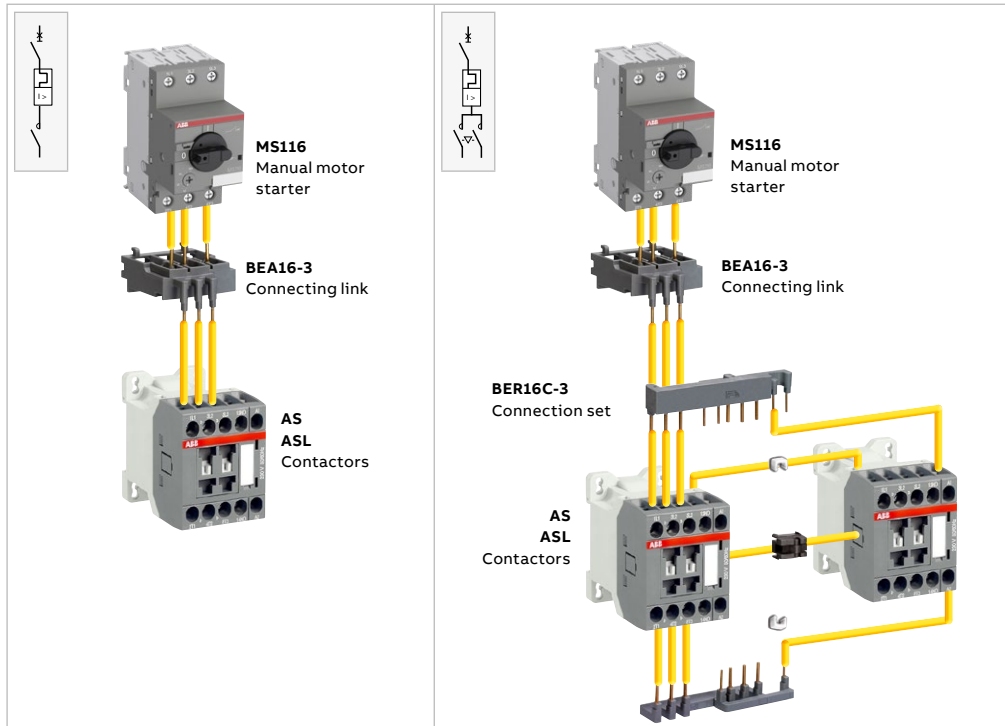

## Starters protected by thermal overload relays

### Direct-on-line starters

### Reversing starters

### Star-delta starters

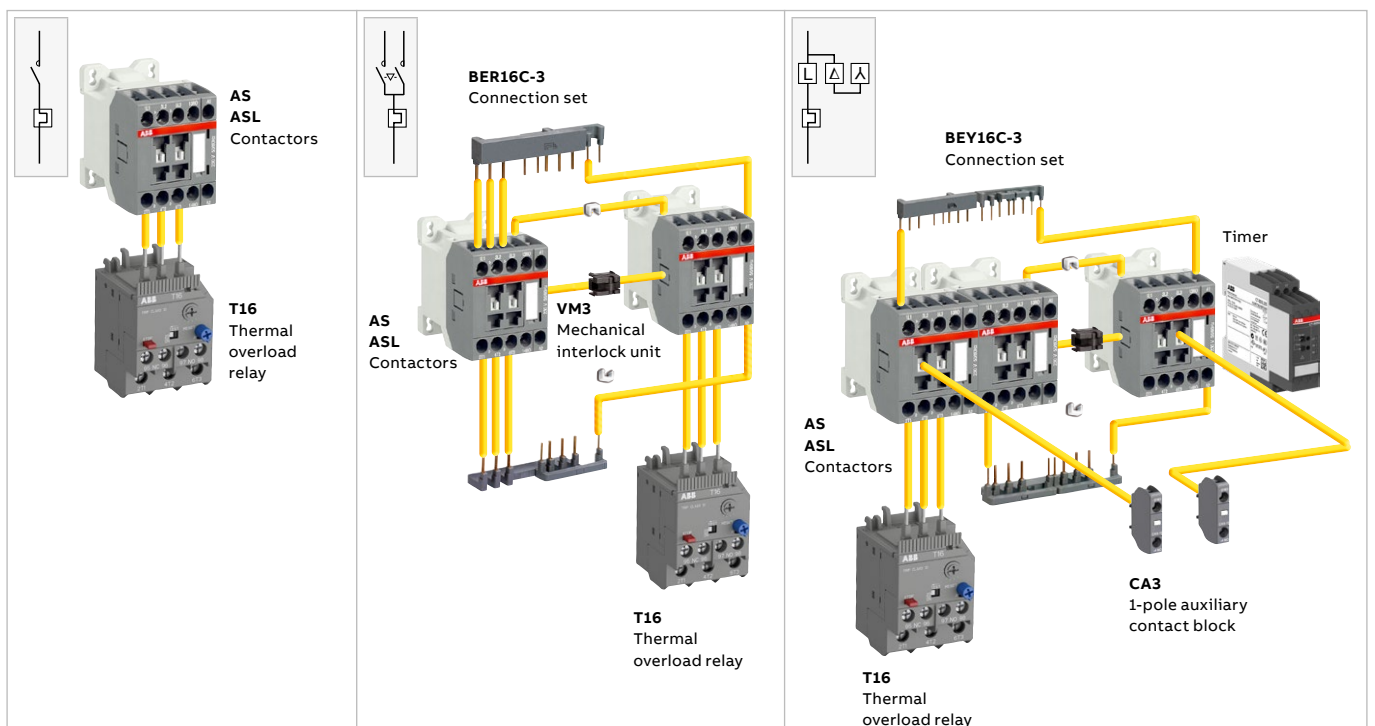

## Starters protected by manual motor starters



### Switching of 3-phase cage motors

		Direct-on-line starters	Reversing starters
Rated power - AC-3, 400 V		0.06...7.5 kW	0.06...7.5 kW
Short-circuit current I <sub>q</sub>		16 kA - 50 kA	16 kA - 50 kA
Coordination type		Type 1 & type 2	Type 1 & type 2
Manual motor starters		<b>MS116</b>	<b>MS116</b>
Contactors	AC operated	<b>AS09 ... AS16</b>	<b>AS09 ... AS16</b>
	DC operated	<b>ASL09 ... ASL16</b>	<b>ASL09 ... ASL16</b>

## Starters protected by thermal overload relays

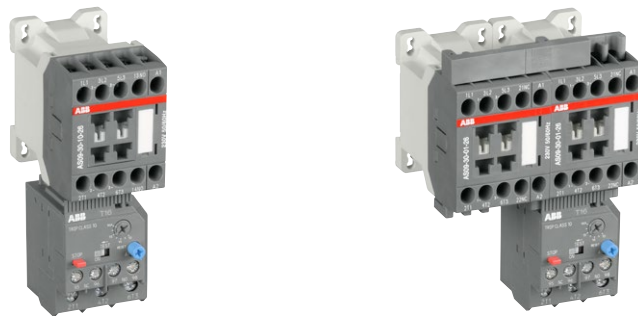

### Switching of 3-phase cage motors

		Direct-on-line starters	Reversing starters
Rated power - AC-3, 400 V		4...7.5 kW	4...7.5 kW
Contactors	AC operated	<b>AS09 ... AS16</b>	<b>AS09 ... AS16</b>
	DC operated	<b>ASL09 ... ASL16</b>	<b>ASL09 ... ASL16</b>
Thermal overload relays		<b>T16</b>	<b>T16</b>

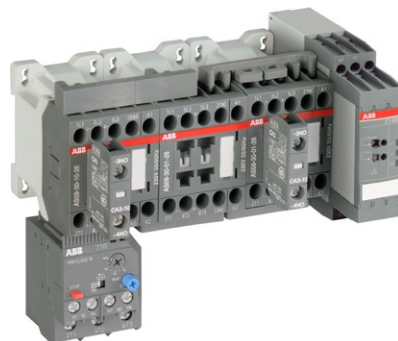

### Switching of 3-phase cage motors

		Star-delta starters
Rated power - AC-3, 400 V		7.5...11 kW
Contactors	AC operated	<b>AS09 ... AS16</b>
	DC operated	<b>ASL09 ... ASL16</b>
Thermal overload relays		<b>T16</b>

## Direct-on-line starters protected by manual motor starters

With AS, ASL contactors - open type version in kit form

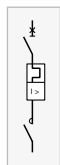
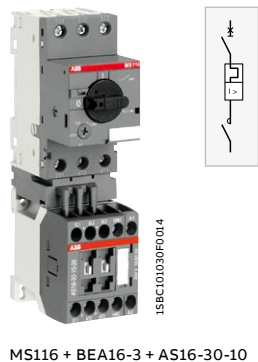

### Application

Full voltage direct-on-line starting for controlling three-phase asynchronous motors is a simple and economic solution characterised by a high starting torque (1.9 to 2.1 times full-speed torque) and a starting current 5.5 to 7 times nominal current.

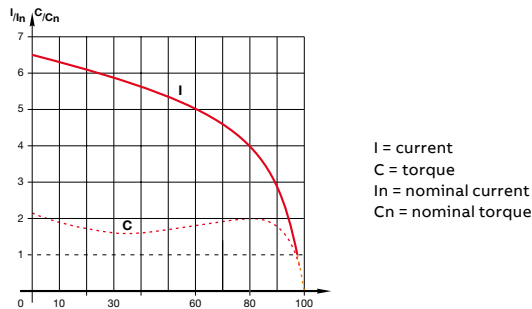

### Coordination types

The contactor and the manual motor starter control and protect motors against overload and short-circuits according to coordination types 1 and 2 (IEC 60947-4-1 / EN 60947-4-1) defining the anticipated level of service continuity as follow:

Type 1: In short-circuit conditions, the contactor or starter does not endanger persons or installations and will not be able to then operate without being repaired or having parts replaced.

Type 2: In short-circuit conditions, the contactor or starter does not endanger persons or installations and will be able to operate afterwards. The risk of contacts light welding is acceptable.

### Main technical data

Standards	IEC 60947-4-1 / EN 60947-4-1
Rated operational voltage $U_e$ max.	690 V - 50/60 Hz
Rated insulation voltage $U_i$ according to IEC 60947-4-1	690 V
Switching frequency	$\leq 15$ starts/hour - 80 % max. load factor - with max. 1.5 s starting time $\leq 30$ starts/hour - 50 % max. load factor - with max. 1.5 s starting time
Ambient air temperature close to the device	$\leq 55$ °C
Degree of protection	IP20

### Mounting positions

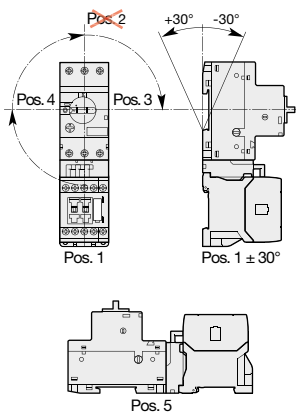

## Direct-on-line starters protected by manual motor starters

With AS, ASL contactors - open type version in kit form

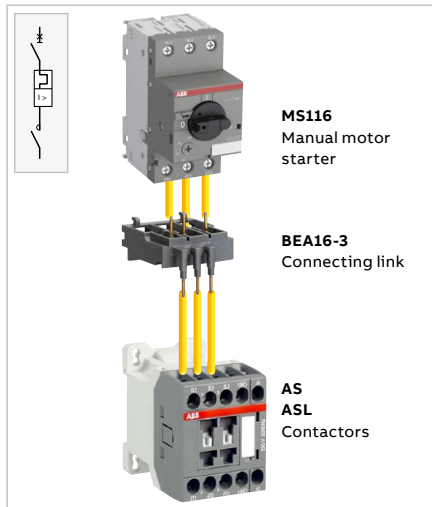

You can easily assemble a direct-on-line starter by using the BEA16-3 connecting link 3-pole insulated. It is used to electrically and mechanically connect MS116 manual motor starter and AS or ASL contactors.

Select now easily and quickly your starter in the following pages for coordination type 1 or 2 at 400 V, 50 / 60 Hz, I<sub>q</sub> = 16 kA or I<sub>q</sub> = 50 kA up to 7.5 kW.

For complete coordination tables with MS116 or MS132, please contact your ABB local sales organization.

### Wiring diagrams

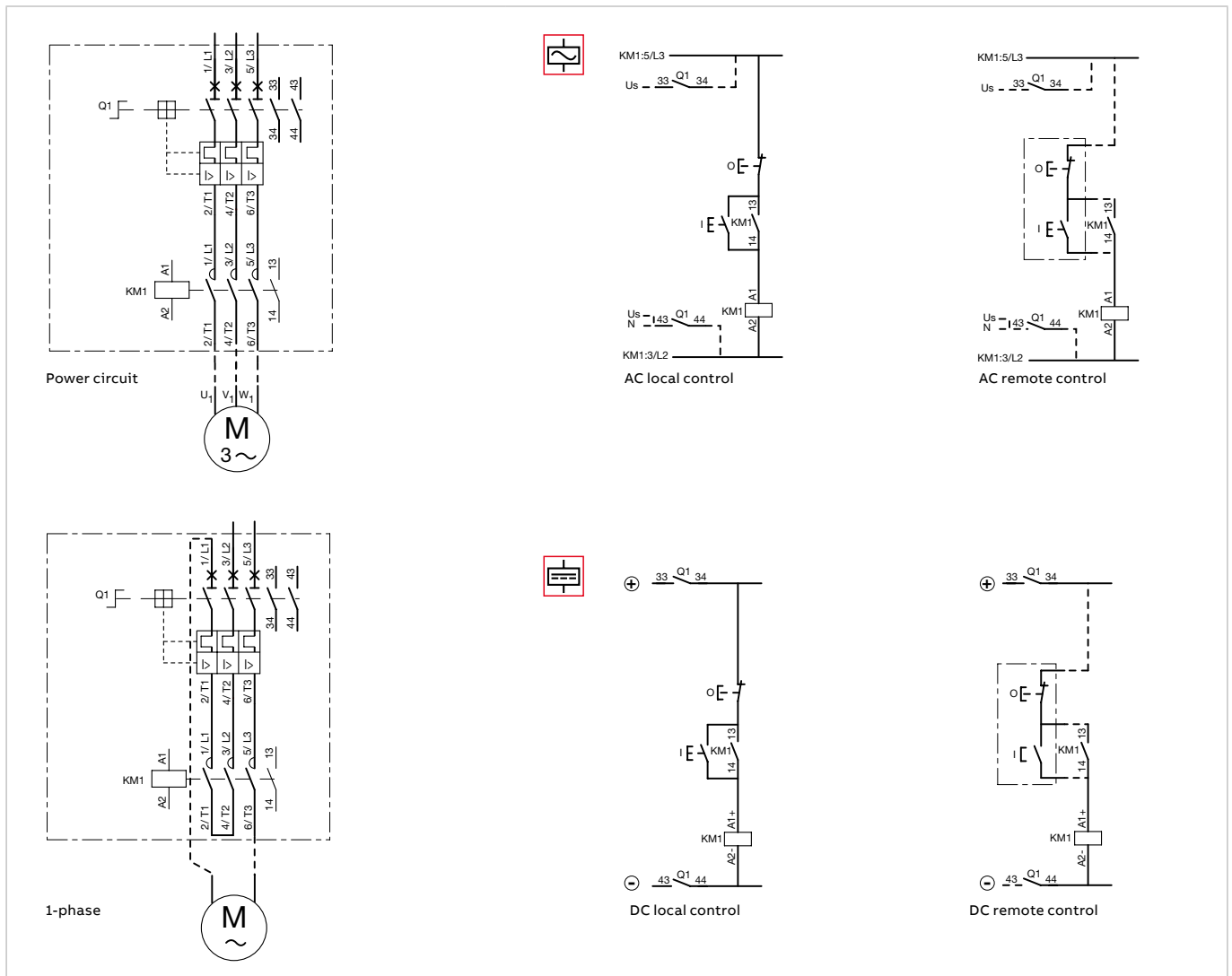

# DOL starters protected by MS116 manual motor starters

With AS contactors - open type version in kit form

## Coordination type 1 or type 2, AC-3, 16 kA or 50 kA, 400 V, 50/60 Hz

	IEC		Manual motor starters				Contactors				Allowed setting current
	AC-3, 400 V	Rated operational power kW	Type	Order code	Current setting range	Magnetic tripping current	Rated control circuit voltage Uc (1)		Type	Order code	
							V 50 Hz	V 60 Hz			
		A			A	A					A

Coordination type 1

Coordination type 2

Iq = 16 kA		Iq = 50 kA												
0.06	0.2	MS116-0.25	1SAM25000R1002	0.16...0.25	2.44	24	24	AS09-30-10-20	1SBL101001R2010	230	230	AS09-30-10-26	1SBL101001R2610	0.25
0.09	0.3	MS116-0.4	1SAM25000R1003	0.25...0.40	3.9	24	24	AS09-30-10-20	1SBL101001R2010	230	230	AS09-30-10-26	1SBL101001R2610	0.4
0.12	0.44	MS116-0.63	1SAM25000R1004	0.40...0.63	6.14	24	24	AS09-30-10-20	1SBL101001R2010	230	230	AS09-30-10-26	1SBL101001R2610	0.63
0.18	0.6	MS116-1.0	1SAM25000R1005	0.63...1.00	11.5	24	24	AS09-30-10-20	1SBL101001R2010	230	230	AS09-30-10-26	1SBL101001R2610	1
0.25	0.85	MS116-1.0	1SAM25000R1005	0.63...1.00	11.5	24	24	AS09-30-10-20	1SBL101001R2010	230	230	AS09-30-10-26	1SBL101001R2610	1
0.37	1.1	MS116-1.6	1SAM25000R1006	1.00...1.60	18.4	24	24	AS09-30-10-20	1SBL101001R2010	230	230	AS09-30-10-26	1SBL101001R2610	1.6
0.55	1.5	MS116-1.6	1SAM25000R1006	1.00...1.60	18.4	24	24	AS09-30-10-20	1SBL101001R2010	230	230	AS09-30-10-26	1SBL101001R2610	1.6
0.75	1.9	MS116-2.5	1SAM25000R1007	1.60...2.50	28.75	24	24	AS09-30-10-20	1SBL101001R2010	230	230	AS09-30-10-26	1SBL101001R2610	2.5
1.1	2.7	MS116-4.0	1SAM25000R1008	2.50...4.00	50	24	24	AS09-30-10-20	1SBL101001R2010	230	230	AS09-30-10-26	1SBL101001R2610	4
1.5	3.6	MS116-4.0	1SAM25000R1008	2.50...4.00	50	24	24	AS09-30-10-20	1SBL101001R2010	230	230	AS09-30-10-26	1SBL101001R2610	4
2.2	4.9	MS116-6.3	1SAM25000R1009	4.00...6.30	78.75	24	24	AS09-30-10-20	1SBL101001R2010	230	230	AS09-30-10-26	1SBL101001R2610	6.3
3	6.5	MS116-10	1SAM25000R1010	6.30...10.0	150	24	24	AS12-30-10-20	1SBL111001R2010	230	230	AS12-30-10-26	1SBL111001R2610	10
4	8.5	MS116-10	1SAM25000R1010	6.30...10.0	150	24	24	AS12-30-10-20	1SBL111001R2010	230	230	AS12-30-10-26	1SBL111001R2610	10
5.5	11.5	MS116-12	1SAM25000R1012	8.00...12.0	180	24	24	AS12-30-10-20	1SBL111001R2010	230	230	AS12-30-10-26	1SBL111001R2610	12
7.5	15.5	MS116-16	1SAM25000R1011	10.0...16.0	240	24	24	AS16-30-10-20	1SBL121001R2010	230	230	AS16-30-10-26	1SBL121001R2610	15.5

Note: for multiple packaging, please contact your ABB local sales organization.

(1) Other control voltages see voltage code table.



Main accessories

	Type	Order code
Connecting link for manual motor starter	BEA16-3	1SBN081006T1000

# DOL starters protected by MS116 manual motor starters

With ASL contactors - open type version in kit form

## Coordination type 1 or type 2, AC-3, 16 or 50 kA, 400 V, 50/60 Hz

	Manual motor starters		Contactors						
	IEC AC-3, 400 V Rated operational power kW	Type current A	Order code	Current setting range A	Magnetic tripping current A	Rated control circuit voltage Uc (1) V DC	Type	Order code	Allowed setting current A

Coordination type 1

Coordination type 2

Iq = 16 kA		Iq = 50 kA								
0.06	0.2	MS116-0.25	1SAM250000R1002	0.16...0.25	2.44	24	ASL09-30-10-81	1SBL103001R8110	0.25	
0.09	0.3	MS116-0.4	1SAM250000R1003	0.25...0.40	3.9	24	ASL09-30-10-81	1SBL103001R8110	0.4	
0.12	0.44	MS116-0.63	1SAM250000R1004	0.40...0.63	6.14	24	ASL09-30-10-81	1SBL103001R8110	0.63	
0.18	0.6	MS116-1.0	1SAM250000R1005	0.63...1.00	11.5	24	ASL09-30-10-81	1SBL103001R8110	1	
0.25	0.85	MS116-1.0	1SAM250000R1005	0.63...1.00	11.5	24	ASL09-30-10-81	1SBL103001R8110	1	
0.37	1.1	MS116-1.6	1SAM250000R1006	1.00...1.60	18.4	24	ASL09-30-10-81	1SBL103001R8110	1.6	
0.55	1.5	MS116-1.6	1SAM250000R1006	1.00...1.60	18.4	24	ASL09-30-10-81	1SBL103001R8110	1.6	
0.75	1.9	MS116-2.5	1SAM250000R1007	1.60...2.50	28.75	24	ASL09-30-10-81	1SBL103001R8110	2.5	
1.1	2.7	MS116-4.0	1SAM250000R1008	2.50...4.00	50	24	ASL09-30-10-81	1SBL103001R8110	4	
1.5	3.6	MS116-4.0	1SAM250000R1008	2.50...4.00	50	24	ASL09-30-10-81	1SBL103001R8110	4	
2.2	4.9	MS116-6.3	1SAM250000R1009	4.00...6.30	78.75	24	ASL09-30-10-81	1SBL103001R8110	6.3	
3	6.5	MS116-10	1SAM250000R1010	6.30...10.0	150	24	ASL12-30-10-81	1SBL113001R8110	10	
4	8.5	MS116-10	1SAM250000R1010	6.30...10.0	150	24	ASL12-30-10-81	1SBL113001R8110	10	
5.5	11.5	MS116-12	1SAM250000R1012	8.00...12.0	180	24	ASL12-30-10-81	1SBL113001R8110	12	
7.5	15.5	MS116-16	1SAM250000R1011	10.0...16.0	240	24	ASL16-30-10-81	1SBL123001R8110	15.5	

Note: for multiple packaging, please contact your ABB local sales organization.

(1) Other control voltages see voltage code table.



Main accessories

	Type	Order code
Connecting link for manual motor starter	BEA16-3	1SBN081006T1000

# Reversing starters protected by manual motor starters

With AS, ASL contactors - open type version in kit form

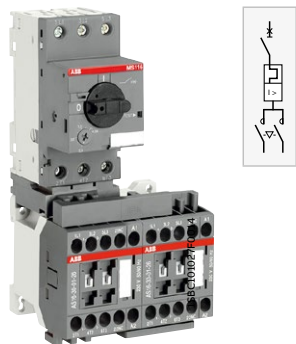

MS116 + BEA16-3 + VM3 + BER16C-3 + AS16-30-01

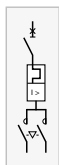

### Application

Full voltage reversing starting for controlling three-phase asynchronous motors is a simple and economic solution characterised by a high starting torque (1.9 to 2.1 times full-speed torque) and a starting current 5.5 to 7 times nominal current.

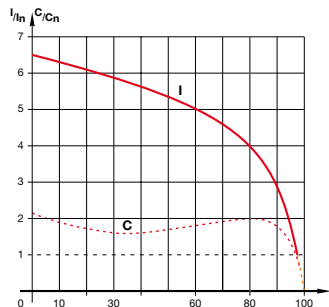

I = current  
C = torque  
In = nominal current  
Cn = nominal torque

### Coordination types

The contactor and the manual motor starter control and protect motors against overload and short-circuits according to coordination types 1 and 2 (IEC 60947-4-1 / EN 60947-4-1) defining the anticipated level of service continuity as follow:

Type 1: In short-circuit conditions, the contactor or starter does not endanger persons or installations and will not be able to then operate without being repaired or having parts replaced.

Type 2: In short-circuit conditions, the contactor or starter does not endanger persons or installations and will be able to operate afterwards. The risk of contacts light welding is acceptable.

### Main technical data

Standards	IEC 60947-4-1 / EN 60947-4-1
Rated operational voltage Ue max.	690 V - 50/60 Hz
Rated insulation voltage Ui according to IEC 60947-4-1	690 V
Switching frequency	≤ 15 starts/hour - 80 % max. load factor - with max. 1.5 s starting time ≤ 30 starts/hour - 50 % max. load factor - with max. 1.5 s starting time
Ambient air temperature close to the device	≤ 55 °C
Degree of protection	IP20

Note: Minimum switchover delay of 50 ms must be introduced between respective opening and closing of AC operated reversing contactors

### Mounting positions

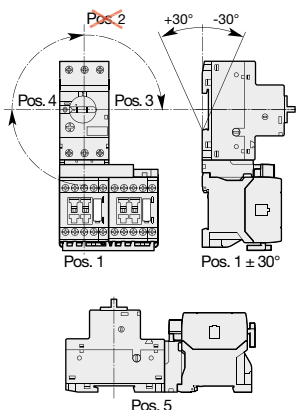

# Reversing starters protected by manual motor starters

With AS, ASL contactors - open type version in kit form

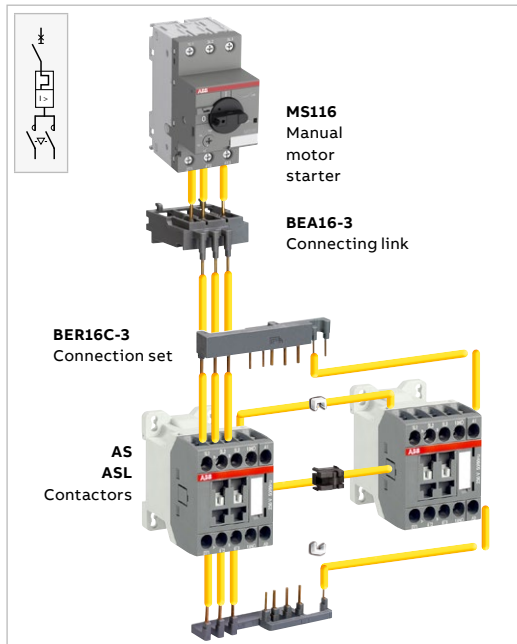

You can easily assemble reversing starter thanks to our complete range of accessories:

- BEA16-3 connecting link 3-pole insulated: it is used to electrically and mechanically connect MS116 manual motor starter and AS or ASL contactors.
- VM3 mechanical interlock unit: just clip it between the 2 contactors without increasing starter width.
- BER16C-3 connection set: it assures a safe and simple connection between both contactor main terminals and an electrical interlocking between coil and N.C. built-in auxiliary contact terminals of both contactors.

Select now easily and quickly your starter in the following pages for coordination type 1 or 2 at 400 V, 50 / 60 Hz, I<sub>q</sub> = 16 kA or I<sub>q</sub> = 50 kA up to 7.5 kW.

For complete coordination tables with MS116 or MS132, please contact your ABB local sales organization.

## Wiring diagrams

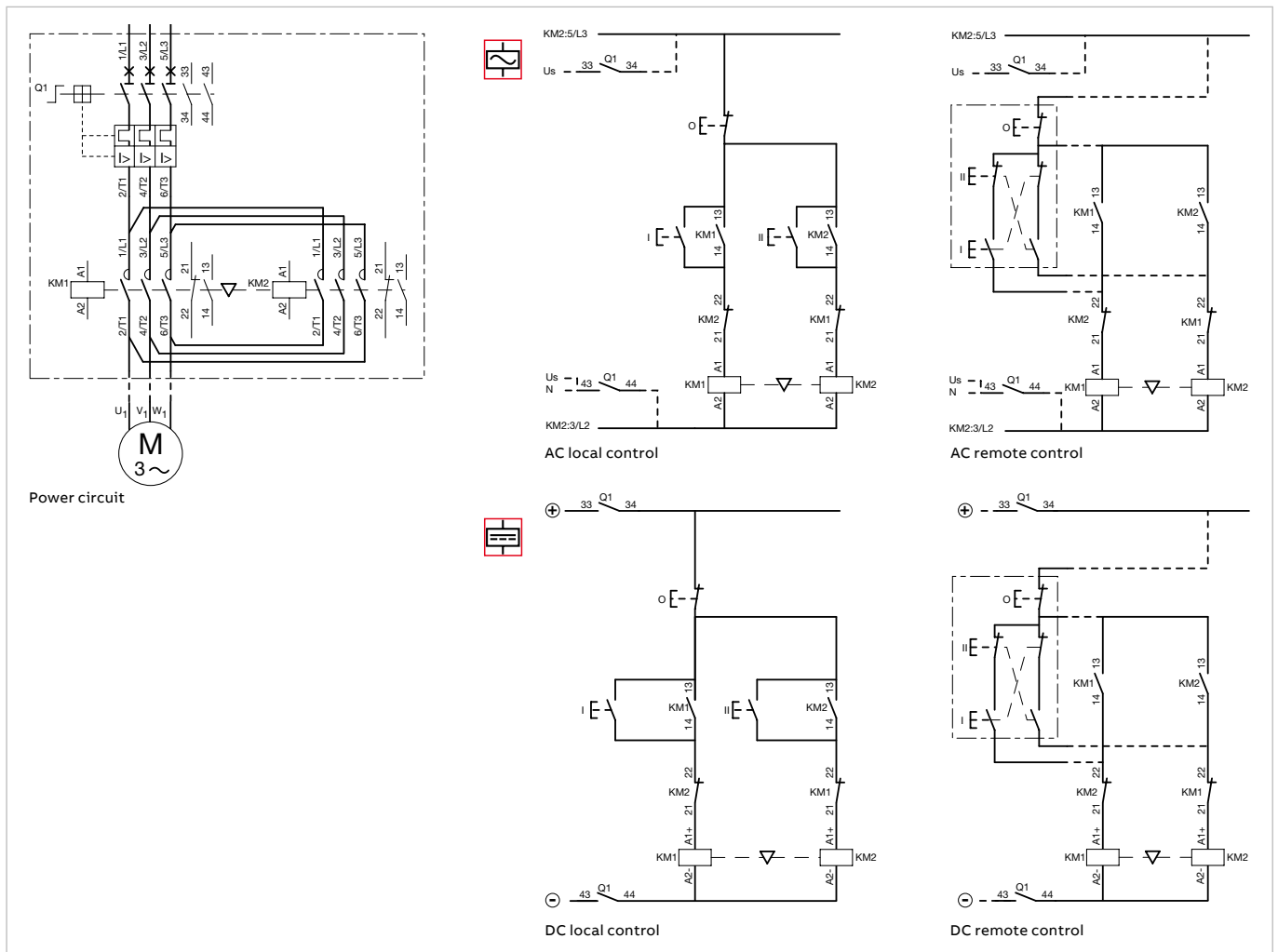



# Reversing starters protected by MS116 manual motor starters

With AS contactors - open type version in kit form

## Coordination type 1 or type 2, AC-3, 16 kA or 50 kA, 400 V, 50/60 Hz

	Manual motor starters					Contactors					
	IEC		Type	Order code	Current setting range	Magnetic tripping current	Rated control circuit voltage U <sub>c</sub> (1)		Type	Order code	Allowed setting current
	AC-3, 400 V	Rated operational power kW	Rated operational current A		A	A	V 50 Hz	V 60 Hz			A

### Coordination type 1

### Coordination type 2

I <sub>q</sub> = 16 kA	I <sub>q</sub> = 50 kA	0.06	0.2	MS116-0.25	1SAM250000R1002	0.16...0.25	2.44	24	24	AS09-30-01-20	1SBL101001R2001	0.25
				0.09	0.3	MS116-0.4	1SAM250000R1003	0.25...0.40	3.9	24	24	AS09-30-01-26
		0.12	0.44	MS116-0.63	1SAM250000R1004	0.40...0.63	6.14	24	24	AS09-30-01-20	1SBL101001R2001	0.63
		0.18	0.6	MS116-1.0	1SAM250000R1005	0.63...1.00	11.5	24	24	AS09-30-01-20	1SBL101001R2001	1
		0.25	0.85	MS116-1.0	1SAM250000R1005	0.63...1.00	11.5	24	24	AS09-30-01-20	1SBL101001R2001	1
		0.37	1.1	MS116-1.6	1SAM250000R1006	1.00...1.60	18.4	24	24	AS09-30-01-20	1SBL101001R2001	1.6
		0.55	1.5	MS116-1.6	1SAM250000R1006	1.00...1.60	18.4	24	24	AS09-30-01-20	1SBL101001R2001	1.6
		0.75	1.9	MS116-2.5	1SAM250000R1007	1.60...2.50	28.75	24	24	AS09-30-01-20	1SBL101001R2001	2.5
		1.1	2.7	MS116-4.0	1SAM250000R1008	2.50...4.00	50	24	24	AS09-30-01-20	1SBL101001R2001	4
		1.5	3.6	MS116-4.0	1SAM250000R1008	2.50...4.00	50	24	24	AS09-30-01-20	1SBL101001R2001	4
		2.2	4.9	MS116-6.3	1SAM250000R1009	4.00...6.30	78.75	24	24	AS09-30-01-20	1SBL101001R2001	6.3
		3	6.5	MS116-10	1SAM250000R1010	6.30...10.0	150	24	24	AS12-30-01-20	1SBL111001R2001	10
		4	8.5	MS116-10	1SAM250000R1010	6.30...10.0	150	24	24	AS12-30-01-20	1SBL111001R2001	10
		5.5	11.5	MS116-12	1SAM250000R1012	8.00...12.0	180	24	24	AS12-30-01-20	1SBL111001R2001	12
		7.5	15.5	MS116-16	1SAM250000R1011	10.0...16.0	240	24	24	AS16-30-01-20	1SBL121001R2001	15.5

Note: for multiple packaging, please contact your ABB local sales organization.

(1) Other control voltages see voltage code table.

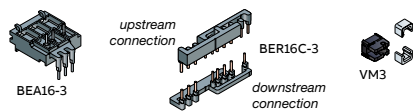

### Main accessories

	Type	Order code
Connecting link for manual motor starter	BEA16-3	1SBN081006T1000
Connection set for reversing starter	BER16C-3	1SBN081012R1000
Mechanical interlock unit	VM3	1SBN031005T1000

# Reversing starters protected by MS116 manual motor starters

With ASL contactors - open type version in kit form

## Coordination type 1 or type 2, AC-3, 16 or 50 kA, 400 V, 50/60 Hz

	Manual motor starters				Contactors			
	IEC AC-3, 400 V Rated operational power kW	Type	Order code	Current setting range A	Magnetic tripping current A	Rated control circuit voltage Uc (1) V DC	Type	Order code

Coordination type 1

Coordination type 2

		Iq = 16 kA		Iq = 50 kA						
0.06	0.2	MS116-0.25	1SAM250000R1002	0.16...0.25	2.44	24	ASL09-30-01-81	1SBL103001R8101	0.25	
0.09	0.3	MS116-0.4	1SAM250000R1003	0.25...0.40	3.9	24	ASL09-30-01-81	1SBL103001R8101	0.4	
0.12	0.44	MS116-0.63	1SAM250000R1004	0.40...0.63	6.14	24	ASL09-30-01-81	1SBL103001R8101	0.63	
0.18	0.6	MS116-1.0	1SAM250000R1005	0.63...1.00	11.5	24	ASL09-30-01-81	1SBL103001R8101	1	
0.25	0.85	MS116-1.0	1SAM250000R1005	0.63...1.00	11.5	24	ASL09-30-01-81	1SBL103001R8101	1	
0.37	1.1	MS116-1.6	1SAM250000R1006	1.00...1.60	18.4	24	ASL09-30-01-81	1SBL103001R8101	1.6	
0.55	1.5	MS116-1.6	1SAM250000R1006	1.00...1.60	18.4	24	ASL09-30-01-81	1SBL103001R8101	1.6	
0.75	1.9	MS116-2.5	1SAM250000R1007	1.60...2.50	28.75	24	ASL09-30-01-81	1SBL103001R8101	2.5	
1.1	2.7	MS116-4.0	1SAM250000R1008	2.50...4.00	50	24	ASL09-30-01-81	1SBL103001R8101	4	
1.5	3.6	MS116-4.0	1SAM250000R1008	2.50...4.00	50	24	ASL09-30-01-81	1SBL103001R8101	4	
2.2	4.9	MS116-6.3	1SAM250000R1009	4.00...6.30	78.75	24	ASL09-30-01-81	1SBL103001R8101	6.3	
3	6.5	MS116-10	1SAM250000R1010	6.30...10.0	150	24	ASL12-30-01-81	1SBL113001R8101	10	
4	8.5	MS116-10	1SAM250000R1010	6.30...10.0	150	24	ASL12-30-01-81	1SBL113001R8101	10	
5.5	11.5	MS116-12	1SAM250000R1012	8.00...12.0	180	24	ASL12-30-01-81	1SBL113001R8101	12	
7.5	15.5	MS116-16	1SAM250000R1011	10.0...16.0	240	24	ASL16-30-01-81	1SBL123001R8101	15.5	

Note: for multiple packaging, please contact your ABB local sales organization.

(1) Other control voltages see voltage code table.

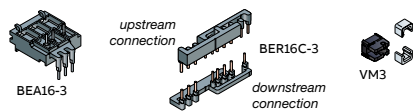

Main accessories

	Type	Order code
Connecting link for manual motor starter	BEA16-3	1SBN081006T1000
Connection set for reversing starter	BER16C-3	1SBN081012R1000
Mechanical interlock unit	VM3	1SBN031005T1000

# DOL starters protected by MS116 manual motor starters

With AS, ASL contactors - open type version in kit form

## Direct-on-line starters

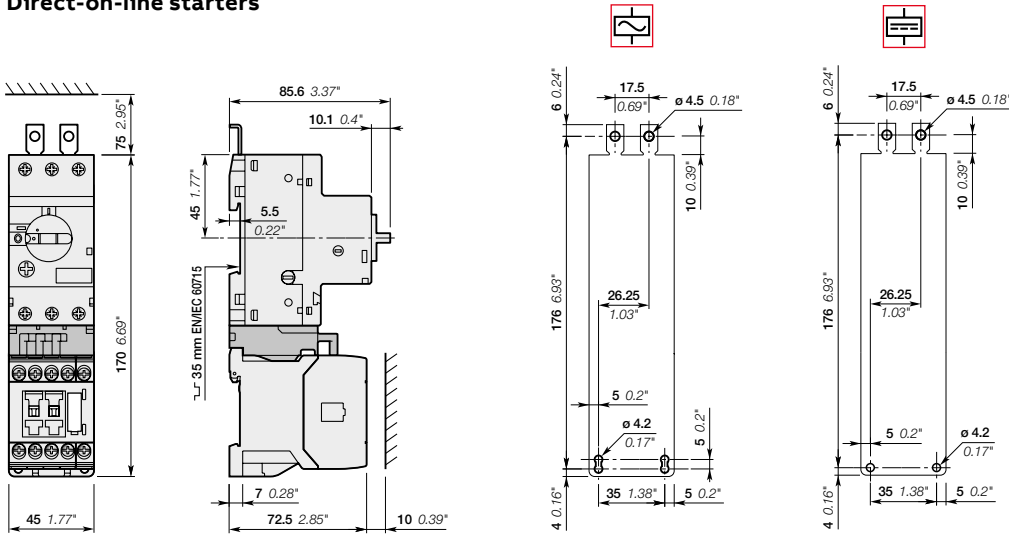

- MS116
- + BEA16-3
- + AS09, ASL09, AS12, ASL12, AS16, ASL16

Main dimensions mm, inches

# Reversing starters protected by MS116 manual motor starters

With AS, ASL contactors - open type version in kit form

## Reversing starters

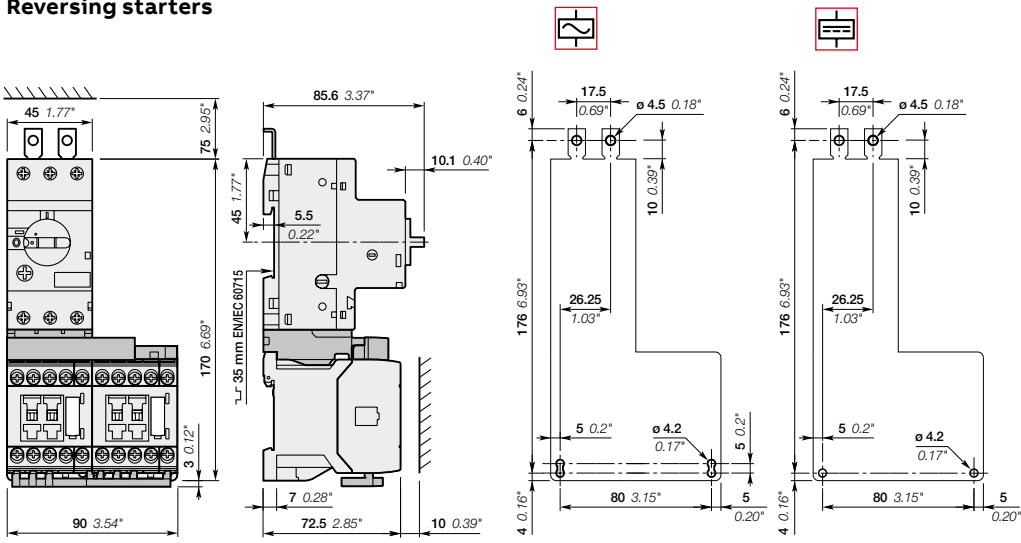

- MS116
- + BEA16-3 + BER16C-3 + VM3
- + AS09, ASL09, AS12, ASL12, AS16, ASL16

Main dimensions mm, inches

# DOL & reversing starters protected by thermal overload relays

With AS, ASL contactors - open type version in kit form



AS09-30-10 + T16

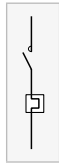

### Application

Full voltage direct-on-line and reversing starting for controlling three-phase asynchronous motors is a simple and economic solution characterised by a high starting torque (1.9 to 2.1 times full-speed torque) and a starting current 5.5 to 7 times nominal current.

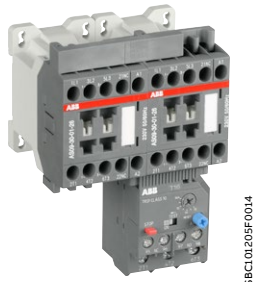
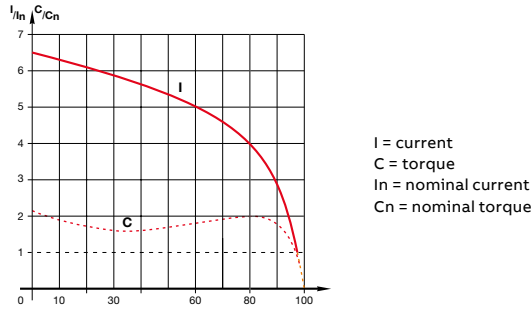

AS09-30-01 + BER16C + VM3 + T16



### Coordination types

The contactor, the short-circuit protection device and the thermal overload relay control and protect motors against overload and short-circuits according to coordination types 1 and 2 (IEC 60947-4-1 / EN 60947-4-1) defining the anticipated level of service continuity as follow:  
 Type 1: In short-circuit conditions, the contactor or starter does not endanger persons or installations and will not be able to then operate without being repaired or having parts replaced.

Type 2: In short-circuit conditions, the contactor or starter does not endanger persons or installations and will be able to operate afterwards. The risk of contacts light welding is acceptable.

### Main technical data

Standards	IEC 60947-4-1 / EN 60947-4-1
Rated operational voltage $U_e$ max.	690 V - 50/60 Hz
Rated insulation voltage $U_i$ according to IEC 60947-4-1	690 V
Air temperature close to the device	$\leq 60$ °C
Degree of protection	IP20
Switching frequency	
Thermal overload relays cannot be operated at any arbitrary switching frequency in order to avoid tripping. Applications involving up to 15 operations per hour are acceptable. Higher switching frequencies are permitted if the duty ratio and the motor starting time are allowed for and if the motor's making current does not appreciably exceed 6 times the rated operating current. Please refer to the adjacent diagram for guideline values for the permitted switching frequency. Example: Starting time of the motor: 1 second Duty ratio: 40 % means a permitted switching frequency of max. 60 operating cycles per hour.	

Note: Minimum switchover delay of 50 ms must be introduced between respective opening and closing of AC operated reversing contactors

### Mounting positions

Direct-on-line

Reversing

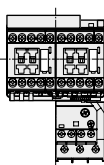
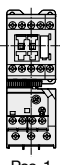

# DOL & reversing starters protected by thermal overload relays

With AS, ASL contactors - open type version in kit form

## Direct-on-line starters

## Reversing starters

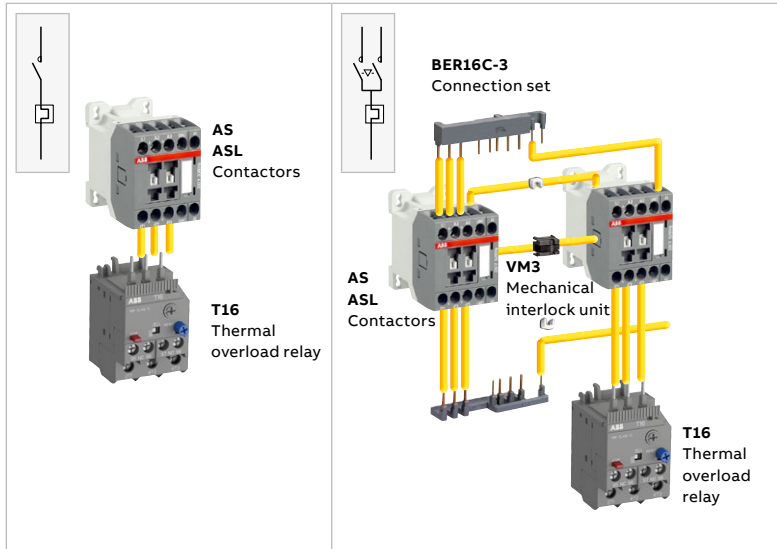

You can easily assemble a direct-on-line starter by connecting AS or ASL contactors and T16 thermal overload relay.

You can easily assemble reversing starter thanks to our complete range of accessories:

- VM3 mechanical interlock unit: just clip it between the 2 contactors without increasing starter length.
- BER16C-3 connection set: it assures a safe and simple reversing connection between both contactor main terminals and an electrical interlocking between coil and N.C. built-in auxiliary contact terminals of both contactors.

Select now easily and quickly your starter in the following pages at 400 V, up to 7.5 kW.

For complete coordination tables, please contact your ABB local sales organization.

## Wiring diagrams

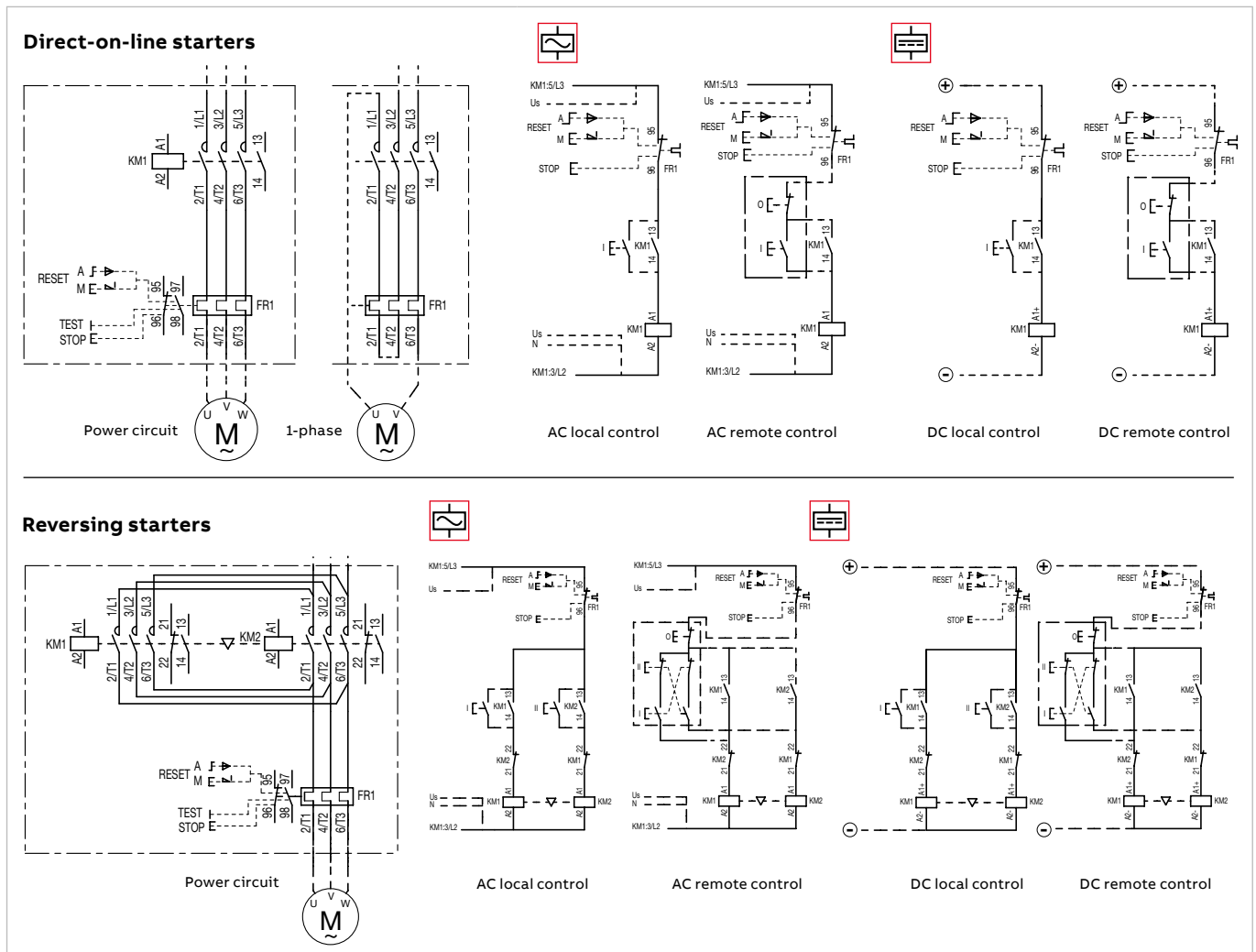

# DOL starters protected by thermal overload relays

With AS, ASL contactors - open type version in kit form

## Contactors - AC operated

IEC		Rated control circuit voltage U <sub>c</sub> (1)				Type	Order code	Thermal overload relays			Accessories
power kW	current A	V 50 Hz	V 60 Hz	Setting ranges	Type			Order code			
4	8.5	24	24	AS09-30-10-20	1SBL101001R2010	7.60...10.0	T16-10	1SAZ711201R1043	-		
		230	230	AS09-30-10-26	1SBL101001R2610						
5.5	11.5	24	24	AS12-30-10-20	1SBL111001R2010	10.0...13.0	T16-13	1SAZ711201R1045	-		
		230	230	AS12-30-10-26	1SBL111001R2610						
7.5	15.5	24	24	AS16-30-10-20	1SBL121001R2010	13.0...16.0	T16-16	1SAZ711201R1047	-		
		230	230	AS16-30-10-26	1SBL121001R2610						

## Contactors - DC operated

IEC		Rated control circuit voltage U <sub>c</sub> (1)		Type	Order code	Setting ranges	Type	Order code	Accessories
power kW	current A	DC	DC						
4	8.5	24		ASL09-30-10-81	1SBL103001R8110	7.60...10.0	T16-10	1SAZ711201R1043	-
5.5	11.5	24		ASL12-30-10-81	1SBL113001R8110	10.0...13.0	T16-13	1SAZ711201R1045	-
7.5	15.5	24		ASL16-30-10-81	1SBL123001R8110	13.0...16.0	T16-16	1SAZ711201R1047	-

Note: for multiple packaging, please contact your ABB local sales organization.  
 (1) Other control voltages see voltage code table.

see table below for all setting ranges

Setting ranges	Type	Order code
A ... A		
0.10...0.13	T16-0.13	1SAZ711201R1005
0.13...0.17	T16-0.17	1SAZ711201R1008
0.17...0.23	T16-0.23	1SAZ711201R1009
0.23...0.31	T16-0.31	1SAZ711201R1013
0.31...0.41	T16-0.41	1SAZ711201R1014
0.41...0.55	T16-0.55	1SAZ711201R1017
0.55...0.74	T16-0.74	1SAZ711201R1021
0.74...1.00	T16-1.0	1SAZ711201R1023
1.00...1.30	T16-1.3	1SAZ711201R1025
1.30...1.70	T16-1.7	1SAZ711201R1028
1.70...2.30	T16-2.3	1SAZ711201R1031
2.30...3.10	T16-3.1	1SAZ711201R1033
3.10...4.20	T16-4.2	1SAZ711201R1035
4.20...5.70	T16-5.7	1SAZ711201R1038
5.70...7.60	T16-7.6	1SAZ711201R1040
7.60...10.0	T16-10	1SAZ711201R1043
10.0...13.0	T16-13	1SAZ711201R1045
13.0...16.0	T16-16	1SAZ711201R1047

# Reversing starters protected by thermal overload relays

With AS, ASL contactors - open type version in kit form

## Contactors - AC operated

IEC		Rated control circuit voltage Uc (1)		Type	Order code	Setting ranges	Type	Order code	Type	Order code
AC-3, 400 V	Rated operational power kW	current A	V 50 Hz			A ... A			BER16C-3	
			V 60 Hz							
4	8.5	24	24	AS09-30-01-20	1SBL101001R2001	7.60...10.0	T16-10	1SAZ711201R1043	BER16C-3 + VM3 + 2x CA3-10	1SBN081012R1000 + 1SBN031005T1000 + 1SBN011010T1010
			230	AS09-30-01-26	1SBL101001R2601					
5.5	11.5	24	24	AS12-30-01-20	1SBL111001R2001	10.0...13.0	T16-13	1SAZ711201R1045	BER16C-3 + VM3 + 2x CA3-10	1SBN081012R1000 + 1SBN031005T1000 + 1SBN011010T1010
			230	AS12-30-01-26	1SBL111001R2601					
7.5	15.5	24	24	AS16-30-01-20	1SBL121001R2001	13.0...16.0	T16-16	1SAZ711201R1047	BER16C-3 + VM3 + 2x CA3-10	1SBN081012R1000 + 1SBN031005T1000 + 1SBN011010T1010
			230	AS16-30-01-26	1SBL121001R2601					

## Contactors - DC operated

IEC		Rated control circuit voltage Uc (1)		Type	Order code	Setting ranges	Type	Order code	Type	Order code
AC-3, 400 V	Rated operational power kW	current A	DC			A ... A			BER16C-3	
4	8.5	24	ASL09-30-10-81		1SBL103001R8110	7.60...10.0	T16-10	1SAZ711201R1043	BER16C-3 + VM3 + 2x CA3-10	1SBN081012R1000 + 1SBN031005T1000 + 1SBN011010T1010
			ASL12-30-10-81		1SBL113001R8110					
5.5	11.5	24	ASL12-30-10-81		1SBL113001R8110	10.0...13.0	T16-13	1SAZ711201R1045	BER16C-3 + VM3 + 2x CA3-10	1SBN081012R1000 + 1SBN031005T1000 + 1SBN011010T1010
			ASL16-30-10-81		1SBL123001R8110					
7.5	15.5	24	ASL16-30-10-81		1SBL123001R8110	13.0...16.0	T16-16	1SAZ711201R1047	BER16C-3 + VM3 + 2x CA3-10	1SBN081012R1000 + 1SBN031005T1000 + 1SBN011010T1010

Note: for multiple packaging, please contact your ABB local sales organization. see table below for all setting ranges  
 (1) Other control voltages see voltage code table.

Setting ranges	Type	Order code
A ... A		
0.10...0.13	T16-0.13	1SAZ711201R1005
0.13...0.17	T16-0.17	1SAZ711201R1008
0.17...0.23	T16-0.23	1SAZ711201R1009
0.23...0.31	T16-0.31	1SAZ711201R1013
0.31...0.41	T16-0.41	1SAZ711201R1014
0.41...0.55	T16-0.55	1SAZ711201R1017
0.55...0.74	T16-0.74	1SAZ711201R1021
0.74...1.00	T16-1.0	1SAZ711201R1023
1.00...1.30	T16-1.3	1SAZ711201R1025
1.30...1.70	T16-1.7	1SAZ711201R1028
1.70...2.30	T16-2.3	1SAZ711201R1031
2.30...3.10	T16-3.1	1SAZ711201R1033
3.10...4.20	T16-4.2	1SAZ711201R1035
4.20...5.70	T16-5.7	1SAZ711201R1038
5.70...7.60	T16-7.6	1SAZ711201R1040
7.60...10.0	T16-10	1SAZ711201R1043
10.0...13.0	T16-13	1SAZ711201R1045
13.0...16.0	T16-16	1SAZ711201R1047



# Star-delta starters protected by thermal overload relays

With AS, ASL contactors - open type version in kit form

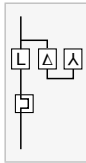

AS09-30-10 + AS09-30-01  
 + AS09-30-01 + BEY16C-3 + VM3  
 + CT-SDS + CA3-10 + T16

### Application

Star-delta starting is the most common method to reduce the starting current of a motor. This system can be used on all the squirrel cage motors, which are normally used in delta connection. In this type of starting, it is recommended to choose motors having high starting torque i.e. much higher than the resistive torque in order to reach sufficient high speed when the motor is connected in star.

### When starting:

- Inrush current is reduced to a third of direct starting current
- Motor torque is reduced to a third or even less of direct starting torque.

Transient current is generated when switching from star to delta connection. During the initial starting phase ("star" connection), the resistive torque of the driven load must remain, irrespective of speed, less than the "star" motor torque until "star-delta" switching occurs. This starting mode is therefore ideal for machines having low starting torque such as pumps, centrifugal compressors, wood-working machines...

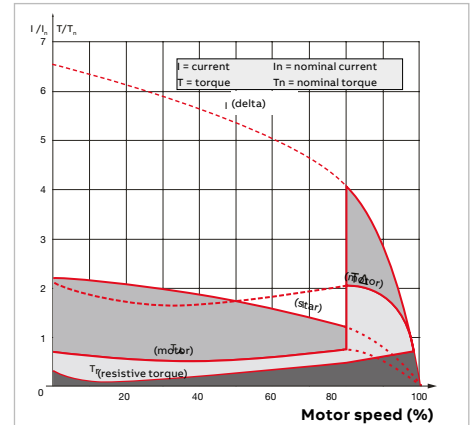

### Precaution

- Motor nominal voltage in delta connection must be equal to that of the mains.  
 Example: a motor for 400 V star-delta starting must be designed for 400 V in "delta" connection. Its usual designation is "400 V / 690 V motor". The motor must be constructed with 6 terminal windings
- In order to prevent a high current peak, at least 85 % of nominal speed must be reached before switching from star to delta

### Sequence

#### Starting is a three-stage process:

- 1st stage: "Star" connection - Press the "On" button on the control circuit to close the KM2 "Star" contactor. The KM1 "line" contactor then closes and the motor starts. Countdown of programmed starting time (6 to 10 s) then begins.
- 2nd stage: "Star" to "Delta" switching - when programmed starting time is over, the KM2 "Star" contactor opens.
- 3rd stage: "Delta" connection - A transition time (or dwelling time) of 50 ms is fixed between opening of the "star" contactor and closing of the "delta" contactor by the use of CT-SDS timer. This prevent short-circuit between "star" and "delta".

### Main technical data

Standards	IEC 60947-4-1 / EN 60947-4-1
Rated operational voltage U <sub>e</sub> max.	690 V - 50/60 Hz
Rated insulation voltage U <sub>i</sub> according to IEC 60947-4-1	690 V
Air temperature close to the device	≤ 60 °C
Degree of protection	IP20

Switching frequency  
 Switching frequency/hour, according to acceleration time and load factor. Respect of the following conditions enables utilization of the starter without excessive overheating of the connections or nuisance tripping of the thermal overload relay.  
 Example:  
 - Switching frequency = 15 starts/hr  
 - Motor starting time "Ta" = 7 s (use 8 s curve)  
 - Maximum load factor = 63 %  
 This corresponds to a 4-minute operating cycle (15 starts/hr) with 7 seconds acceleration, 2.5 minutes operation and 1.5 minutes rest.

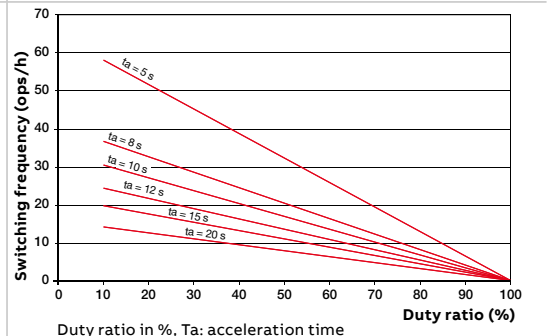

### Mounting positions

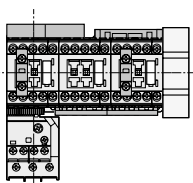

# Star-delta starters protected by thermal overload relays

With AS, ASL contactors - open type version in kit form

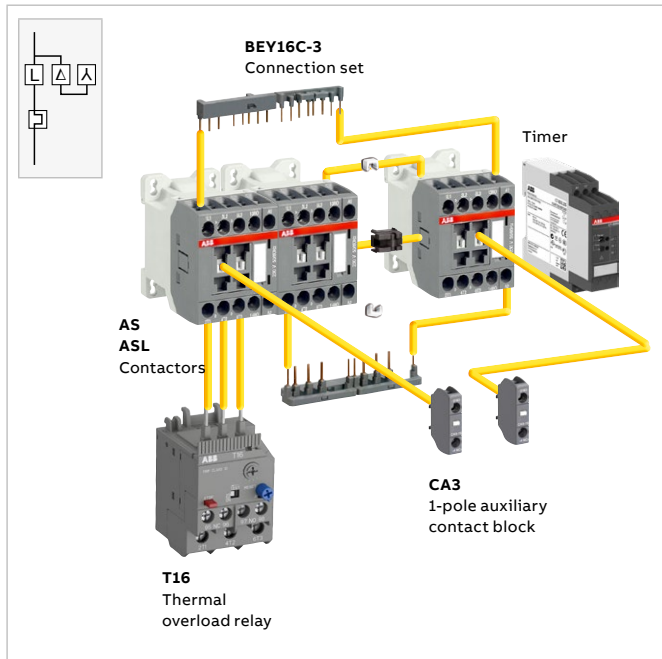

You can easily assemble a star-delta starter thanks to our complete range of accessories:

- VM3 mechanical interlock unit: just clip it between the 2 contactors without increasing starter length.
- BEY16C-3 connection set: it assures a safe and simple connection between contactors main terminals and an electrical interlocking between coil and N.C. built-in auxiliary contact terminals of star and delta contactors.

Select now easily and quickly your starter in the following pages at 400 V, up to 11 kW.

For complete coordination tables, please contact your ABB local sales organization.

## Wiring diagrams

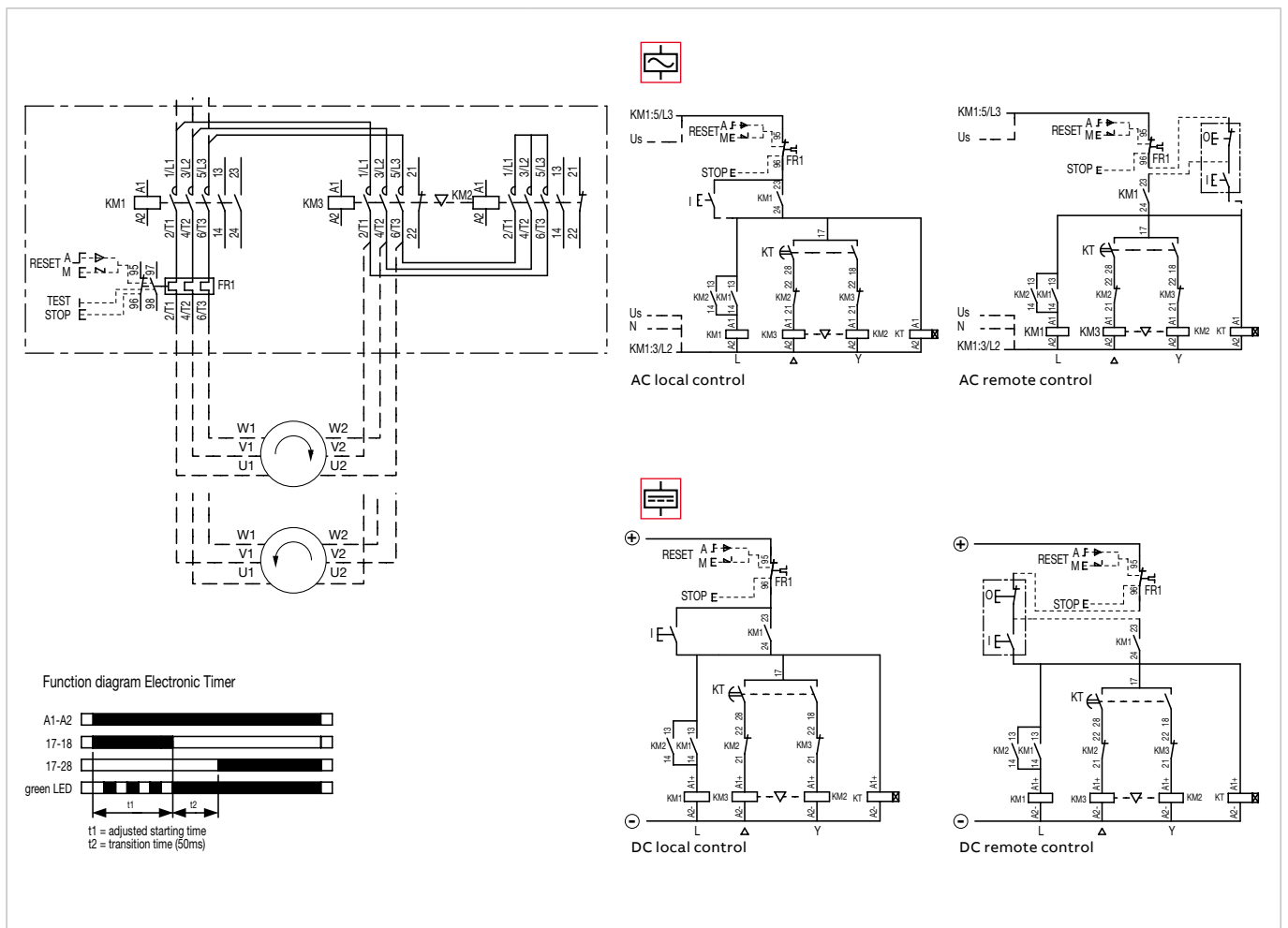

## Star-delta starters protected by thermal overload relays

With AS, ASL contactors - open type version in kit form

### Contactors - AC operated

IEC		Rated control circuit voltage U <sub>c</sub> (1)		Line contactor KM1		Delta contactor KM3		Star contactor KM2		
AC-3, 400 V	Rated operational power kW	current A	U <sub>c</sub> (1)		Type	Order code	Type	Order code	Type	Order code
			V 50 Hz	V 60 Hz						
7.5	15.5	15.5	24	24	AS09-30-10-20	1SBL101001R2010	AS09-30-01-20	1SBL101001R2001	AS09-30-01-20	1SBL101001R2001
			230	230	AS09-30-10-26	1SBL101001R2610	AS09-30-01-26	1SBL101001R2601	AS09-30-01-26	1SBL101001R2601
11	22	22	24	24	AS12-30-10-20	1SBL111001R2010	AS12-30-01-20	1SBL111001R2001	AS09-30-01-20	1SBL101001R2001
			230	230	AS12-30-10-26	1SBL111001R2610	AS12-30-01-26	1SBL111001R2601	AS09-30-01-26	1SBL101001R2601



### Contactors - DC operated

IEC		Rated control circuit voltage U <sub>c</sub> (1)		Type	Order code	Type	Order code	Type	Order code	
AC-3, 400 V	Rated operational power kW	current A	U <sub>c</sub> (1)		Type	Order code	Type	Order code	Type	Order code
			DC	DC						
7.5	15.5	15.5	24	ASL09-30-10-81	1SBL103001R8110	ASL09-30-01-81	1SBL103001R8101	ASL09-30-01-81	1SBL103001R8101	
11	22	22	24	ASL12-30-10-81	1SBL113001R8110	ASL12-30-01-81	1SBL113001R8101	ASL09-30-01-81	1SBL103001R8101	

Note: for multiple packaging, please contact your ABB local sales organization.  
 (1) Other control voltages see voltage code table.

# Star-delta starters protected by thermal overload relays

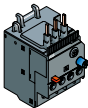
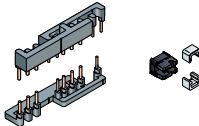
With AS, ASL contactors - open type version in kit form

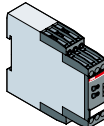
	Thermal overload relays		Connection sets Mechanical interlock unit		Auxiliary contact block		Electronic timer	
								
	The setting current value is: nominal motor current x 0.58							
Setting ranges	Type	Order code	Type	Order code	Type	Order code	Type	Order code
A ... A								
7.60...10.0	T16-10	1SAZ711201R1043	BEY16C-3 + VM3	1SBN081018R2000 + 1SBN031005T1000	KM1: 1 x CA3-10 KM2: 1 x CA3-10	1SBN011010T1010 1SBN011010T1010	CT-SDS...	see "Ordering Details"
10.0...13.0	T16-13	1SAZ711201R1045	BEY16C-3 + VM3	1SBN081018R2000 + 1SBN031005T1000	KM1: 1 x CA3-10 KM2: 1 x CA3-10	1SBN011010T1010 1SBN011010T1010	CT-SDS...	see "Ordering Details"

Setting ranges	Type	Order code	Type	Order code	Type	Order code	Type	Order code
A ... A								
7.60...10.0	T16-10	1SAZ711201R1043	BEY16C-3 + VM3	1SBN081018R2000 + 1SBN031005T1000	KM1: 1 x CA3-10 KM2: 1 x CA3-10	1SBN011010T1010 1SBN011010T1010	CT-SDS...	see "Ordering Details"
10.0...13.0	T16-13	1SAZ711201R1045	BEY16C-3 + VM3	1SBN081018R2000 + 1SBN031005T1000	KM1: 1 x CA3-10 KM2: 1 x CA3-10	1SBN011010T1010 1SBN011010T1010	CT-SDS...	see "Ordering Details"

see table below for all setting ranges

Setting ranges	Type	Order code
A ... A		
0.10...0.13	T16-0.13	1SAZ711201R1005
0.13...0.17	T16-0.17	1SAZ711201R1008
0.17...0.23	T16-0.23	1SAZ711201R1009
0.23...0.31	T16-0.31	1SAZ711201R1013
0.31...0.41	T16-0.41	1SAZ711201R1014
0.41...0.55	T16-0.55	1SAZ711201R1017
0.55...0.74	T16-0.74	1SAZ711201R1021
0.74...1.00	T16-1.0	1SAZ711201R1023
1.00...1.30	T16-1.3	1SAZ711201R1025
1.30...1.70	T16-1.7	1SAZ711201R1028
1.70...2.30	T16-2.3	1SAZ711201R1031
2.30...3.10	T16-3.1	1SAZ711201R1033
3.10...4.20	T16-4.2	1SAZ711201R1035
4.20...5.70	T16-5.7	1SAZ711201R1038
5.70...7.60	T16-7.6	1SAZ711201R1040
7.60...10.0	T16-10	1SAZ711201R1043
10.0...13.0	T16-13	1SAZ711201R1045
13.0...16.0	T16-16	1SAZ711201R1047

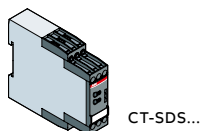

### Ordering details - Main accessories

	Type	Order code	Pkg qty	Weight (1 pce) kg
Electronic timer*	28-48 V DC 24-240 V AC	CT-SDS.22S 1SVR730210R3300	1	0.114
	380-440 V AC	CT-SDS.23S 1SVR730211R2300	1	0.118

\* 7 time ranges (0.05 s - 10 min), 50 ms transition time, 2 n/o contacts, 3 LEDs

# Protected by thermal overload relays

With AS, ASL contactors - open type in kit form

## Direct-on-line starters

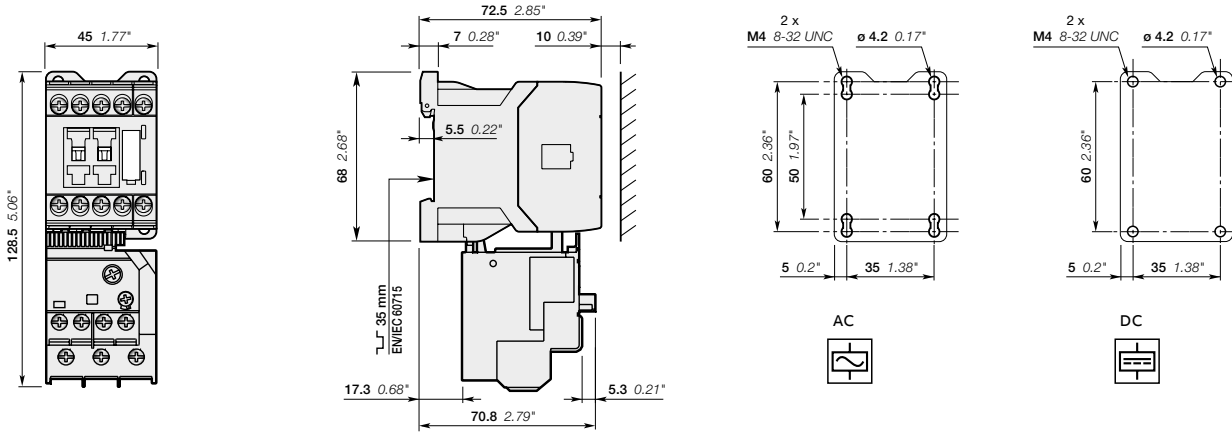

## Reversing starters

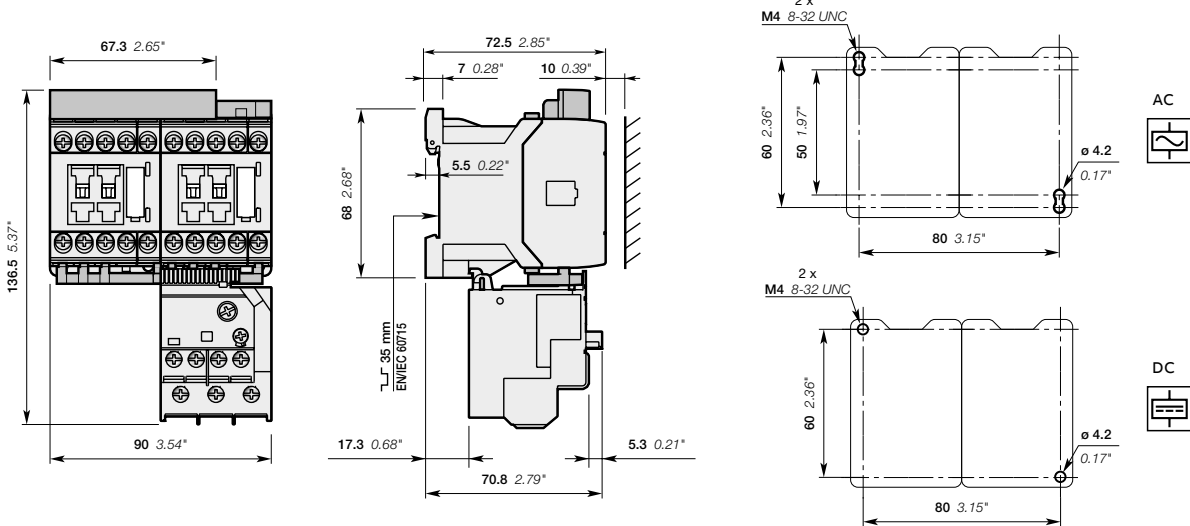

## Star-delta starters

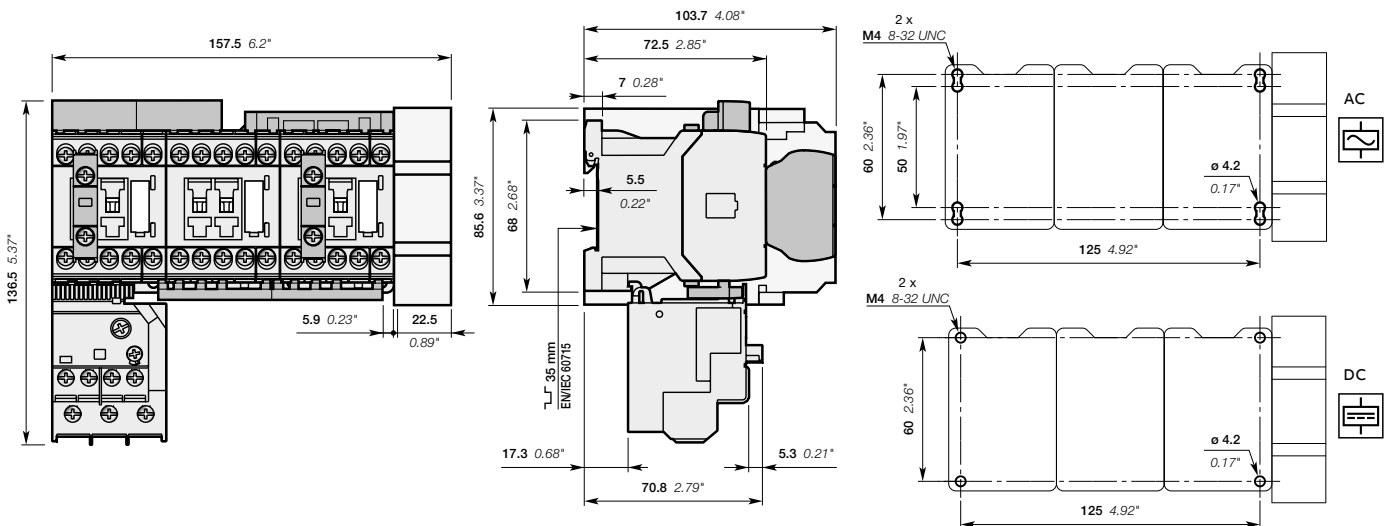

Main dimensions mm, inches

# Reversing starters protected by thermal overload relays

With AF contactors - open type version in kit form

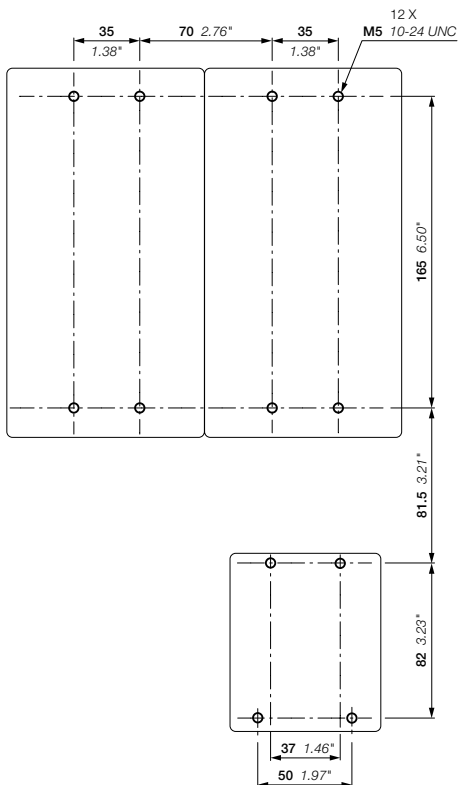
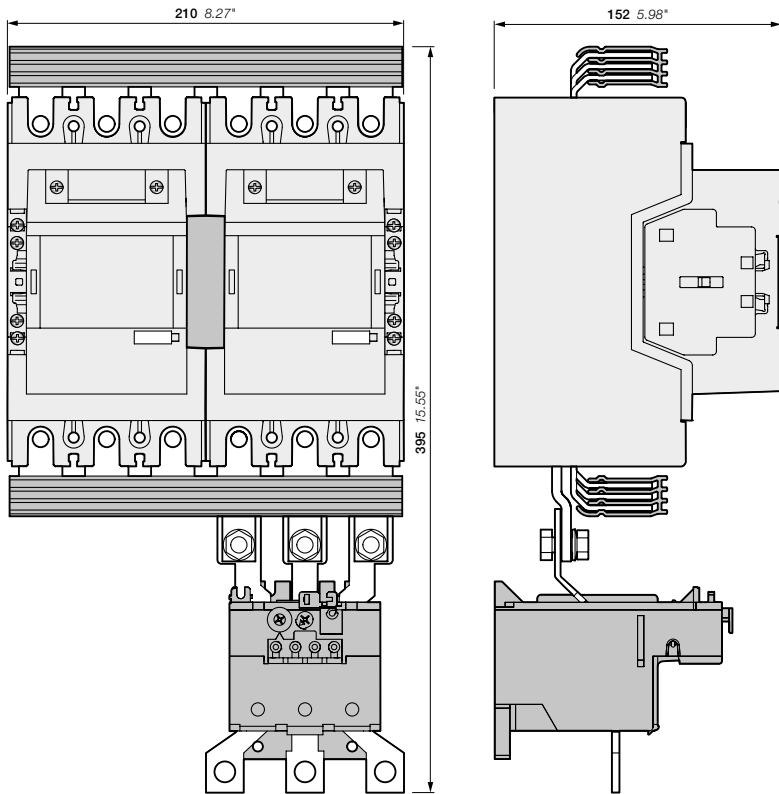

- AF190, AF205
- + BER205-4, VM19
- + TA200DU thermal overload relay

Main dimensions mm, inches

# DOL starters protected by electronic overload relays

With AF contactors - open type version in kit form

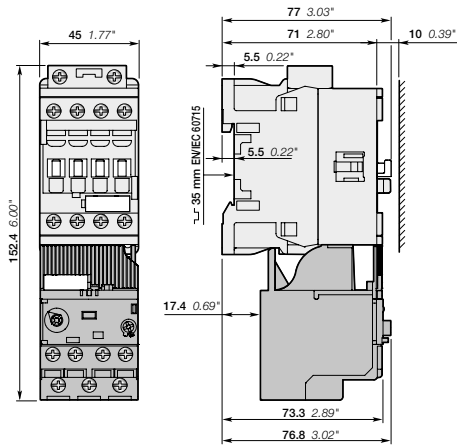

AF09, AF12, AF16  
+ EF19 electronic overload relay

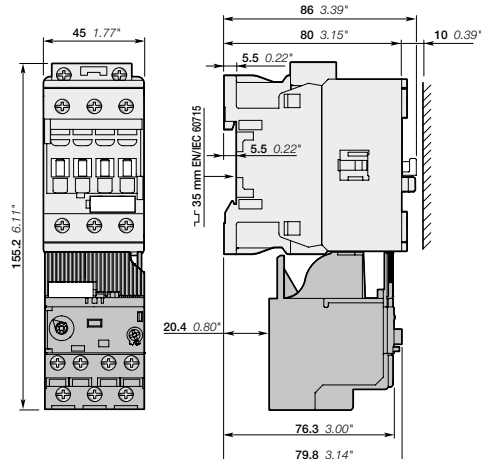

AF26, AF30, AF38  
+ EF19 electronic overload relay

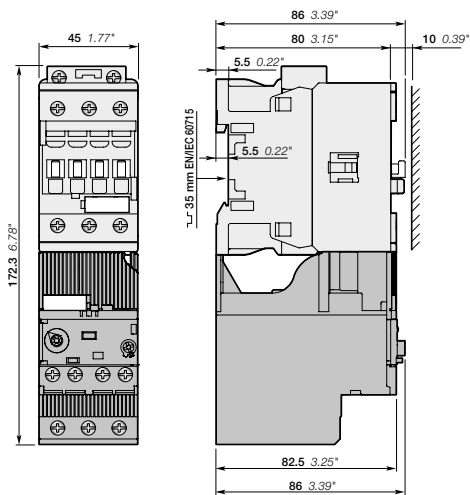

AF26, AF30, AF38  
+ EF45 electronic overload relay

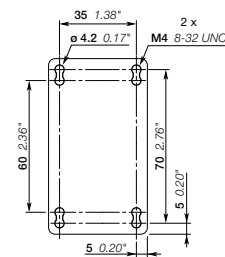

AF09, AF12, AF16, AF26, AF30, AF38  
+ EF electronic overload relay

Note: contactor lateral distance to grounded component 2 mm 0.08" min.

Main dimensions mm, inches

# DOL starters protected by electronic overload relays

With AF contactors - open type version in kit form

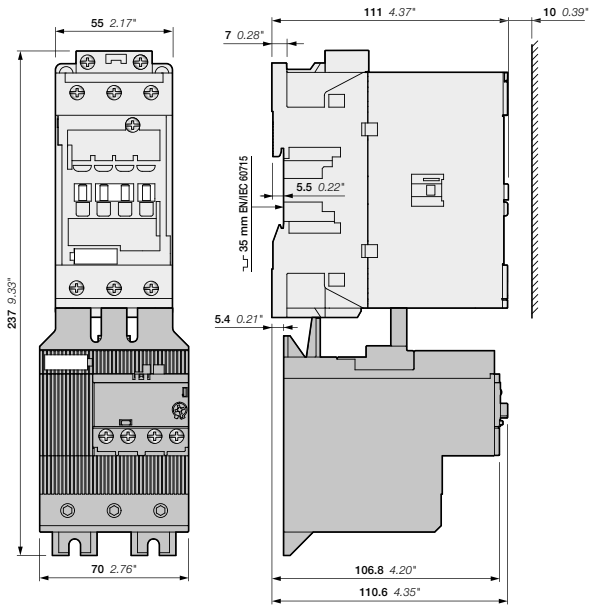

AF40, AF52, AF65  
+ EF65 electronic overload relay

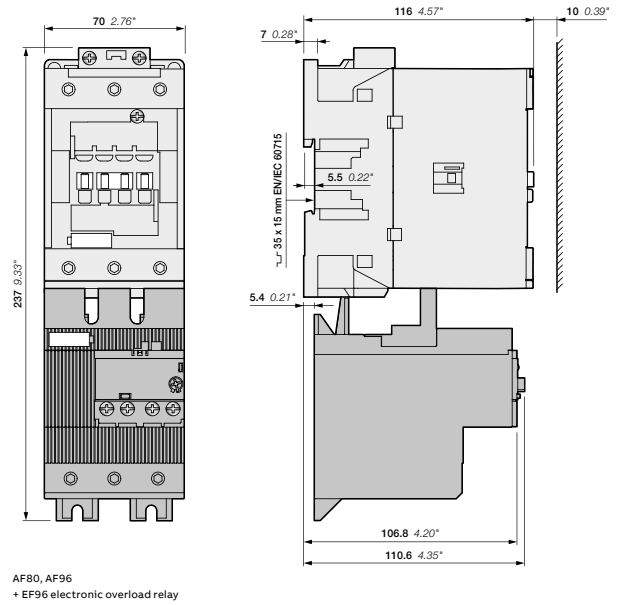

AF80, AF96  
+ EF96 electronic overload relay

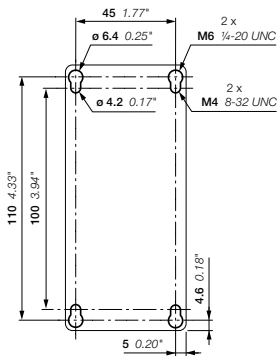

AF40, AF52, AF65  
+ EF65 electronic overload relay

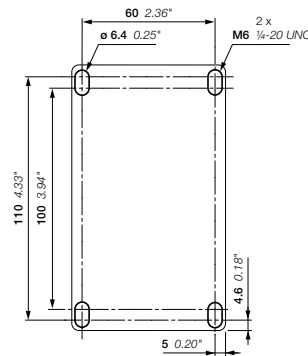

AF80, AF96  
+ EF96 electronic overload relay

Main dimensions mm, inches



# DOL starters protected by electronic overload relays

With AF contactors - open type version in kit form

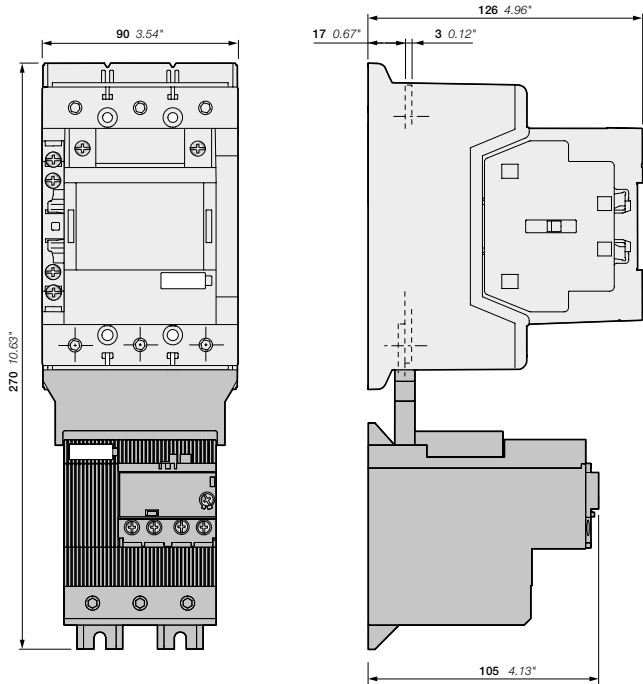

AF116, AF140, AF146-30-11(B)  
+ EF146 electronic overload relay

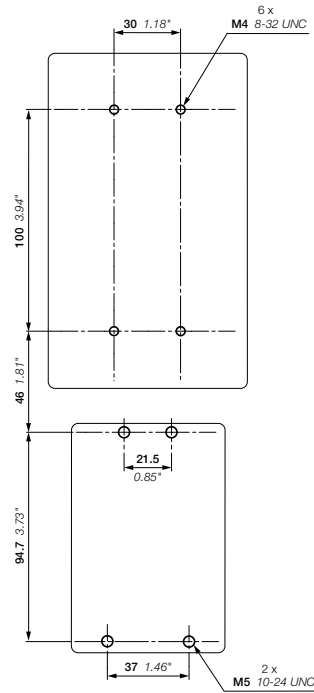

AF116, AF140, AF146-30-11(B)  
+ EF146 electronic overload relay

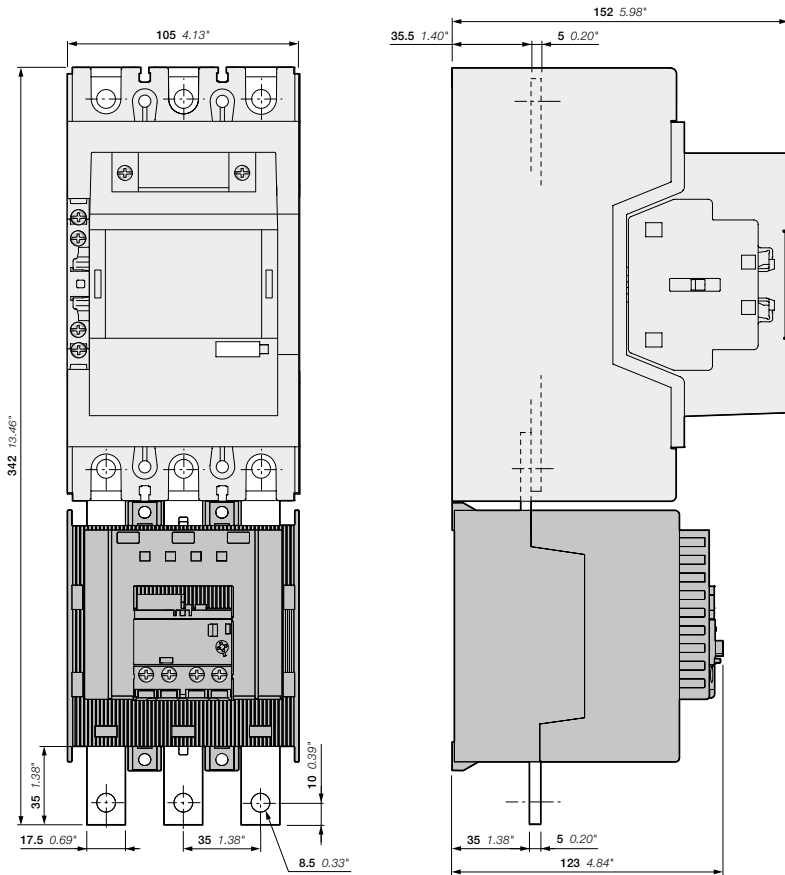

AF190, AF205-30-11  
+ EF205 electronic overload relay

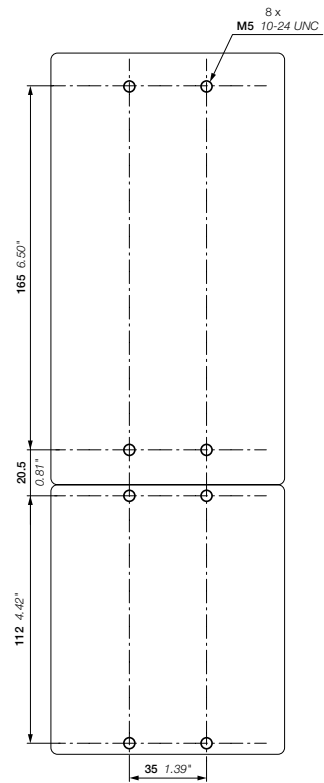

AF190, AF205  
+ EF205 electronic overload relay

Main dimensions mm, inches

## DOL starters protected by electronic overload relays

With AF contactors - open type version in kit form

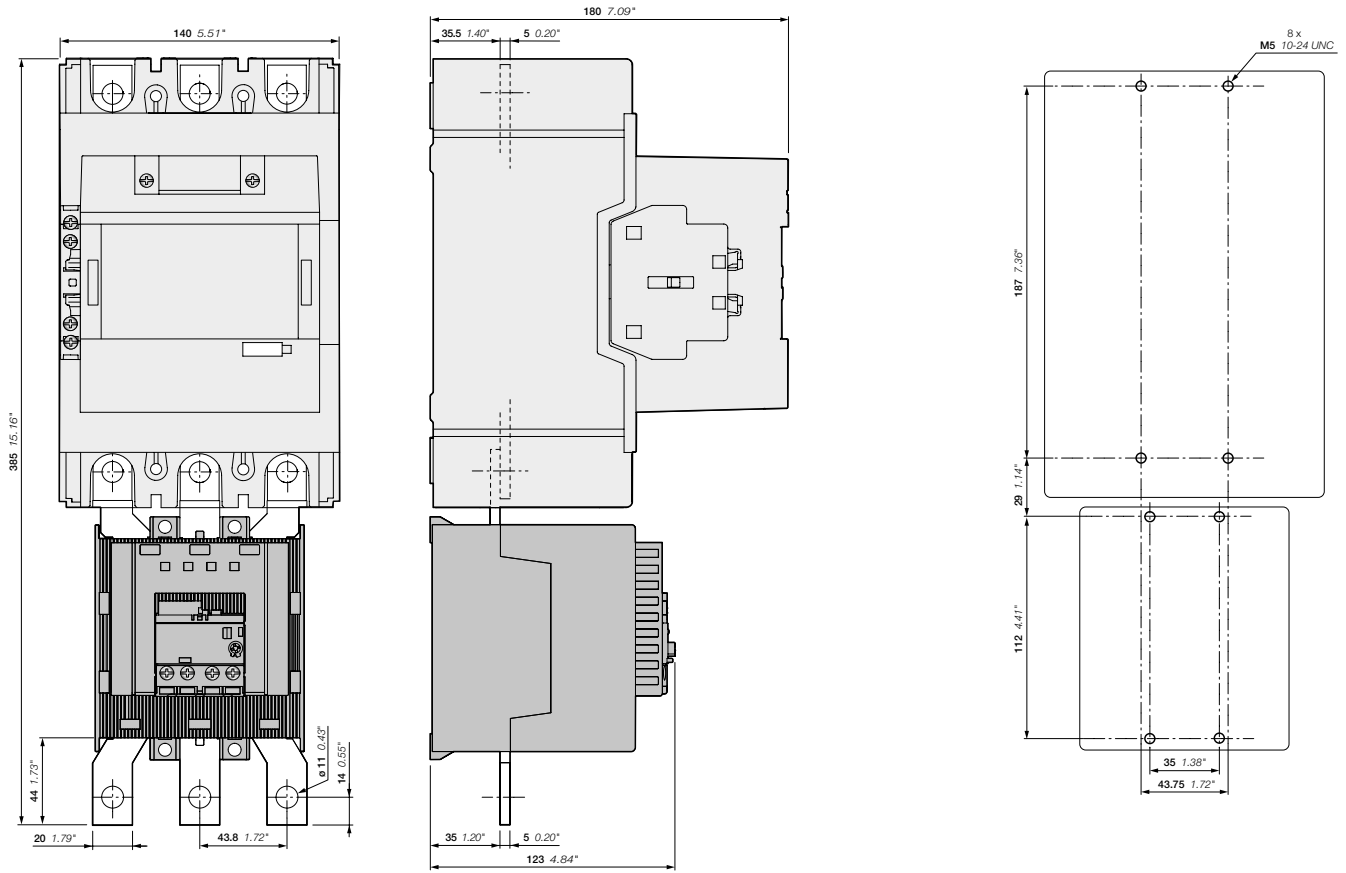

AF265, AF305, AF370-30-11  
+ EF370 electronic overload relay

Main dimensions mm, inches

# Reversing starters protected by electronic overload relays

With AF contactors - open type version in kit form

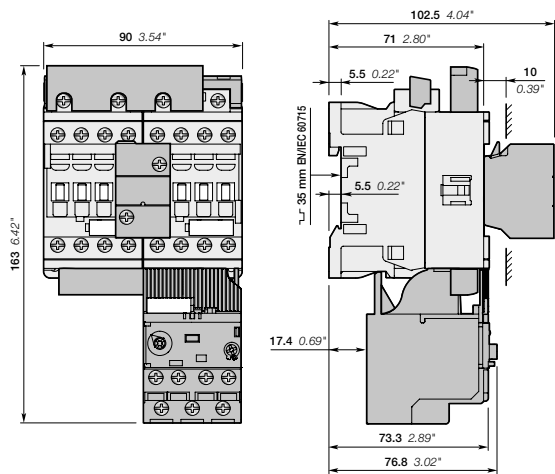

AF09, AF12, AF16  
+ BER16-4, VEM4  
+ EF19 electronic overload relay

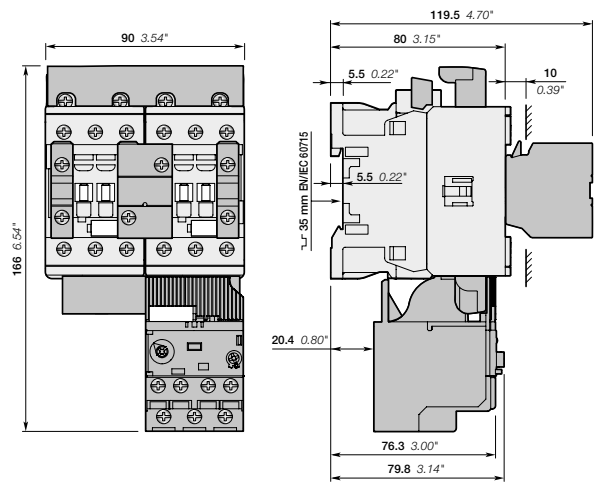

AF26, AF30, AF38  
+ BER38-4, VEM4, CA4-10  
+ EF19 electronic overload relay

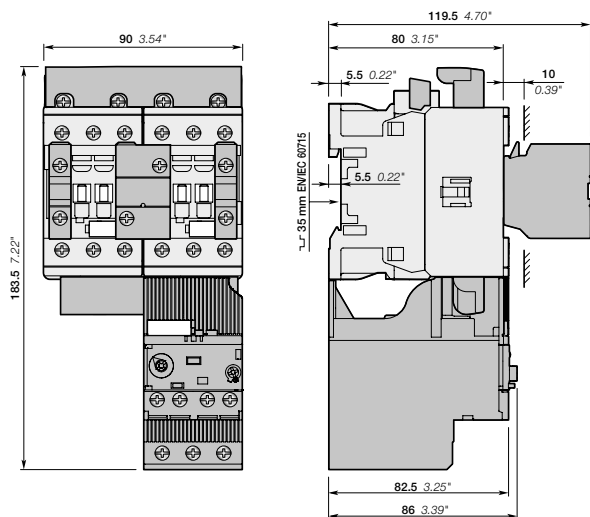

AF26, AF30, AF38  
+ BER38-4, VEM4, CA4-10  
+ EF45 electronic overload relay

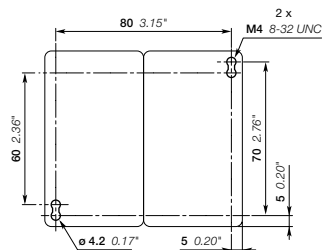

AF09, AF12, AF16, AF26, AF30, AF38

Note: contactor lateral distance to grounded component 2 mm 0.08" min.

Main dimensions mm, inches

## Reversing starters protected by electronic overload relays

With AF contactors - open type version in kit form

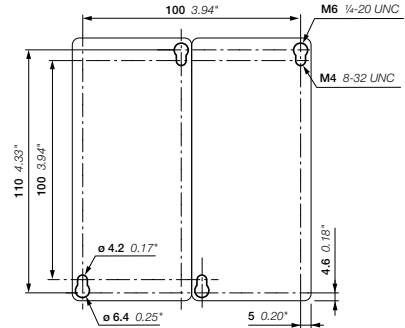
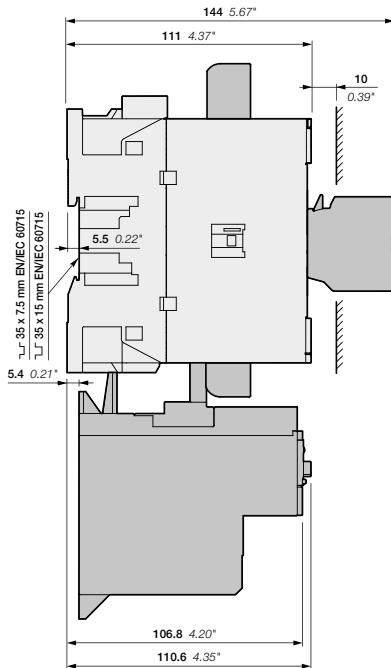
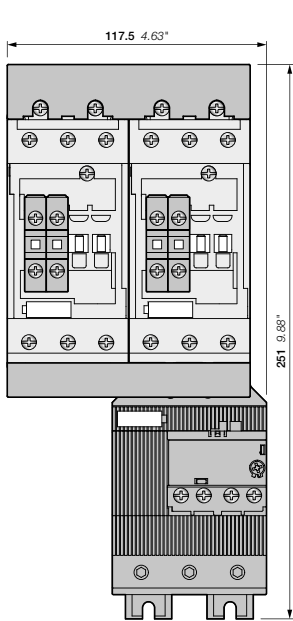

AF40, AF52, AF65  
+ BER65-4, VM96-4  
+ EF65 electronic overload relay

AF40, AF52, AF65  
+ BER65-4, VM96-4  
+ EF65 electronic overload relay

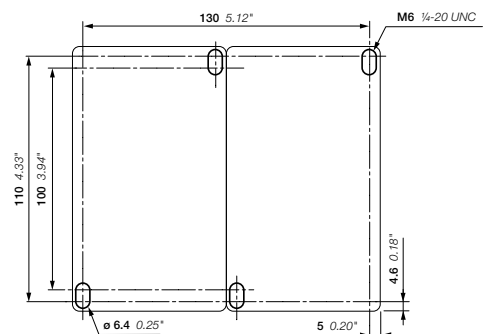
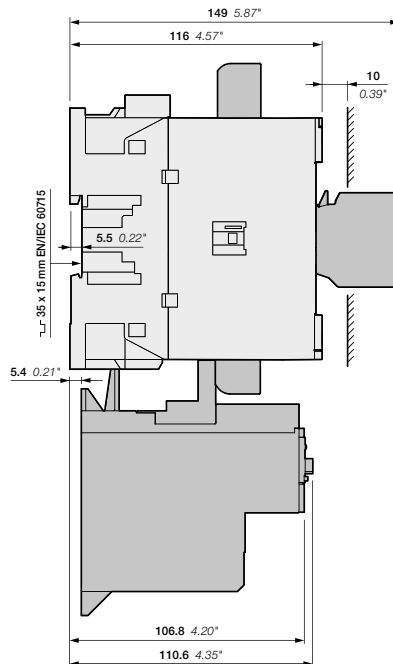
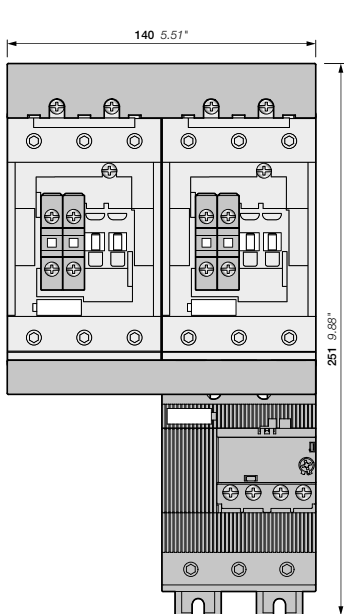

AF80, AF96  
+ BER96-4, VM96-4  
+ EF96 electronic overload relay

AF80, AF96  
+ BER96-4, VM96-4  
+ EF96 electronic overload relay

Main dimensions mm, inches

## Reversing starters protected by electronic overload relays

With AF contactors - open type version in kit form

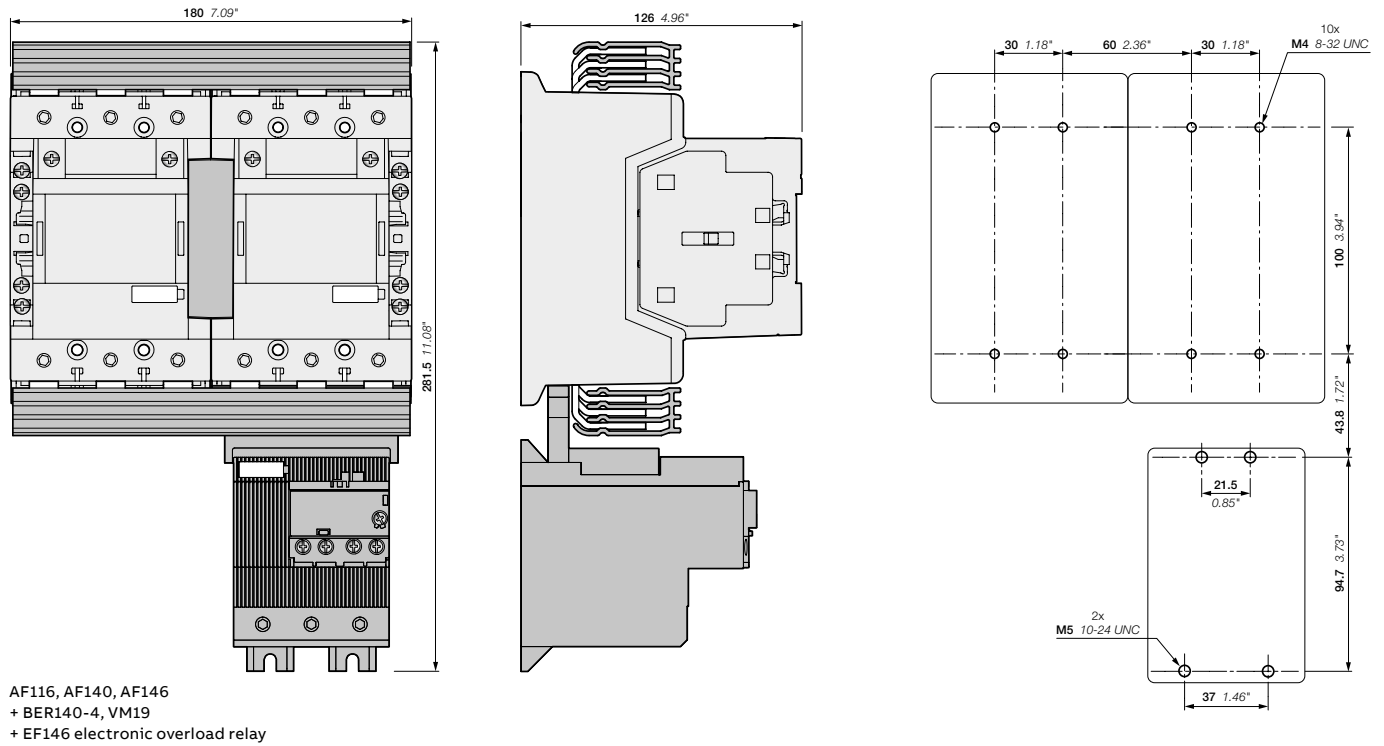

Main dimensions mm, inches

## Reversing starters protected by electronic overload relays

With AF contactors - open type version in kit form

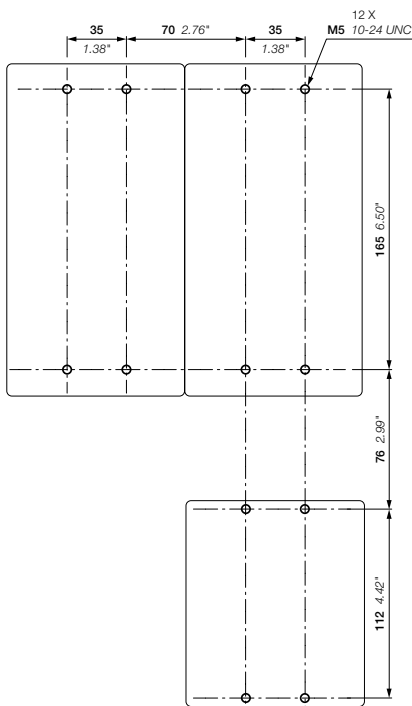
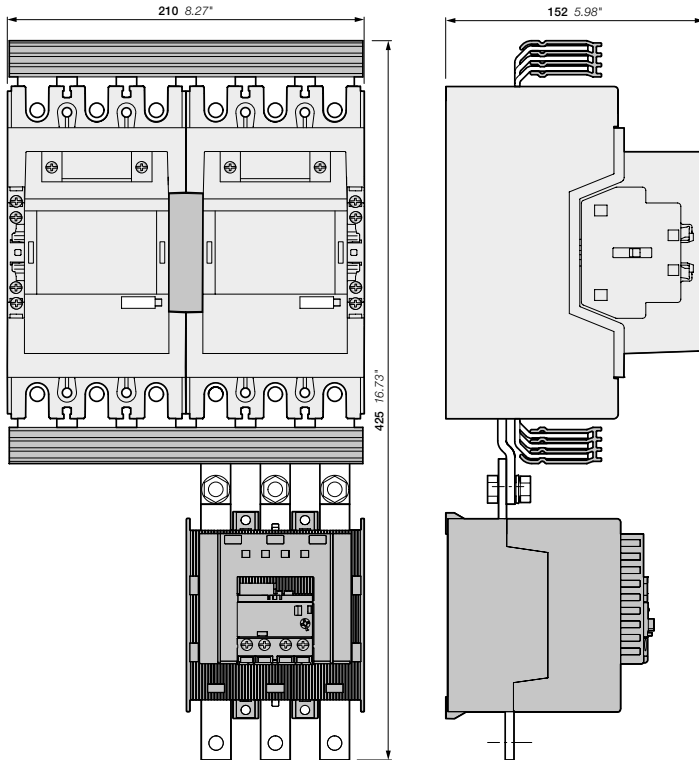

- AF190, AF205
- + BER205-4, VM19
- + EF205 electronic overload relay

Main dimensions mm, inches

## Reversing starters protected by electronic overload relays

With AF contactors - open type version in kit form

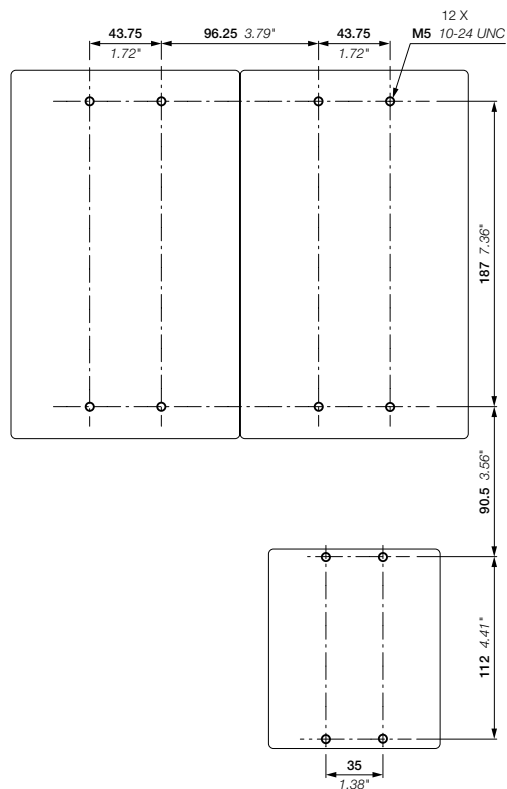
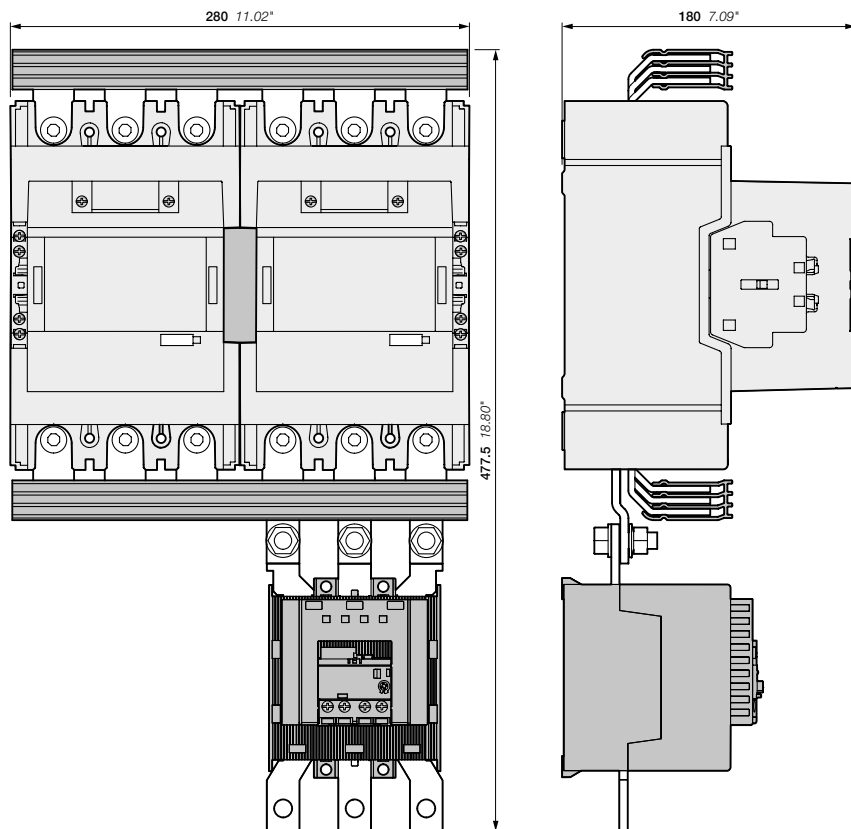

- AF265, AF305, AF370
- + BER370-4, VM19
- + EF370 electronic overload relay

Main dimensions mm, inches

—  
**Notes**

A large rectangular area filled with a grid of small, light gray dotted lines, intended for handwritten notes.



# Star-delta starters protected by overload relays

With AF contactors - Open type version in kit form

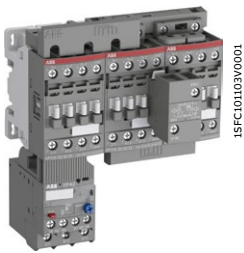
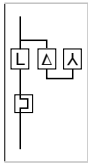

AF16-30-10 + AF16-30-10 + AF09-30-10 + BEY16-4 + VEM4 + TF42

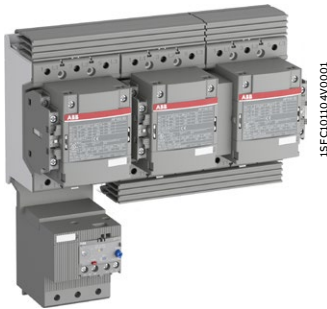

AF140-30-11 + AF140-30-11 + AF140-30-11 + BEY140-4 + VM19 + EF146

### Application

Star-delta starting is the most common method to reduce the starting current of a motor. This system can be used on all the squirrel cage motors, which are normally used in delta connection. In this type of starting, it is recommended to choose motors having high starting torque i.e. much higher than the resistive torque in order to reach sufficient high speed when the motor is connected in star.

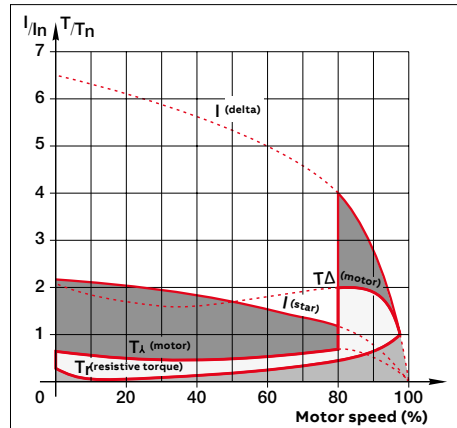

I = current  
T = torque  
In = nominal current  
Tn = nominal torque

### When starting:

- Inrush current is reduced to a third of direct starting current
  - Motor torque is reduced to a third or even less of direct starting torque.
- Transient current is generated when switching from star to delta connection. During the initial starting phase ("star" connection), the resistive torque of the driven load must remain, irrespective of speed, less than the "star" motor torque until "star-delta" switching occurs. This starting mode is therefore ideal for machines having low starting torque such as pumps, centrifugal compressors, wood-working machines...

### Precaution

- Motor nominal voltage in delta connection must be equal to that of the mains. Example: a motor for 400 V star-delta starting must be designed for 400 V in "delta" connection. Its usual designation is "400 V / 690 V motor". The motor must be constructed with 6 terminal windings
- In order to prevent a high current peak, at least 85 % of nominal speed must be reached before switching from star to delta

### Sequence

#### Starting is a three-stage process:

- 1st stage:** "Star" connection - Press the "On" button on the control circuit to close the KM2 "Star" contactor. The KM1 "line" contactor then closes and the motor starts. Countdown of programmed starting time (6 to 10 s) then begins.
- 2nd stage:** "Star" to "Delta" switching - when programmed starting time is over, the KM2 "Star" contactor opens.
- 3rd stage:** "Delta" connection - Thanks to AF contactors, a transition time (or dwelling time) of 50 ms is already integrated between the opening of the "star" contactor and closing of the "delta" contactor.

**Conclusion:** An on-delay timer without dwelling time (e.g.: CT-ERS.21S or TEF4-ON) is enough to countdown the programmed starting time (6 to 10 s) during "Star connection". The use of a star-delta timer including a dwelling time is not permitted.

### Main Technical Data

Standards	IEC 60947-4-1 / EN 60947-4-1
Rated operational voltage Ue max.	690 V - 50/60 Hz
Rated insulation voltage Ui	
acc. to IEC 60947-4-1	690 V
acc. to UL / CSA	600 V
Ambient air temperature	
Close to the device	≤ 60 °C (TF42: 38 A above ≤ 50 °C)
Degree of protection	IP20
Switching frequency	Refer to "Switching frequency diagrams" page

### Mounting positions

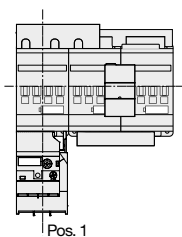

## Star-delta starters protected by overload relays

With AF contactors - Open type version in kit form

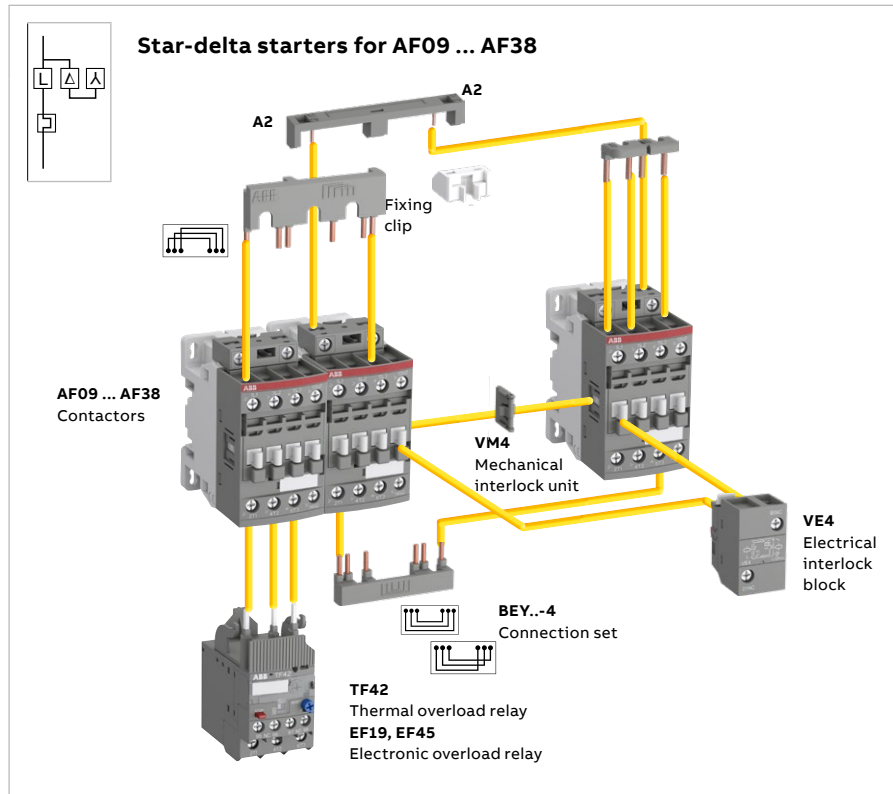

You can easily assemble star-delta starter thanks to our complete range of accessories:

- For AF09 ... AF38, use VEM4 mechanical and electrical interlock set without increasing starter width. It includes:
  - VM4 mechanical interlock unit and 2 fixing clips
  - VE4 electrical interlock block with A2-A2 connection.
- For AF40 ... AF370, use VM mechanical interlock unit and additional auxiliary contact blocks for electrical interlocking.
- BEY..-4 connection set: it assures a safe and simple connection between both contactor main terminals.

Select now easily and quickly your starter in the following pages at 400 V, up to 200 kW.

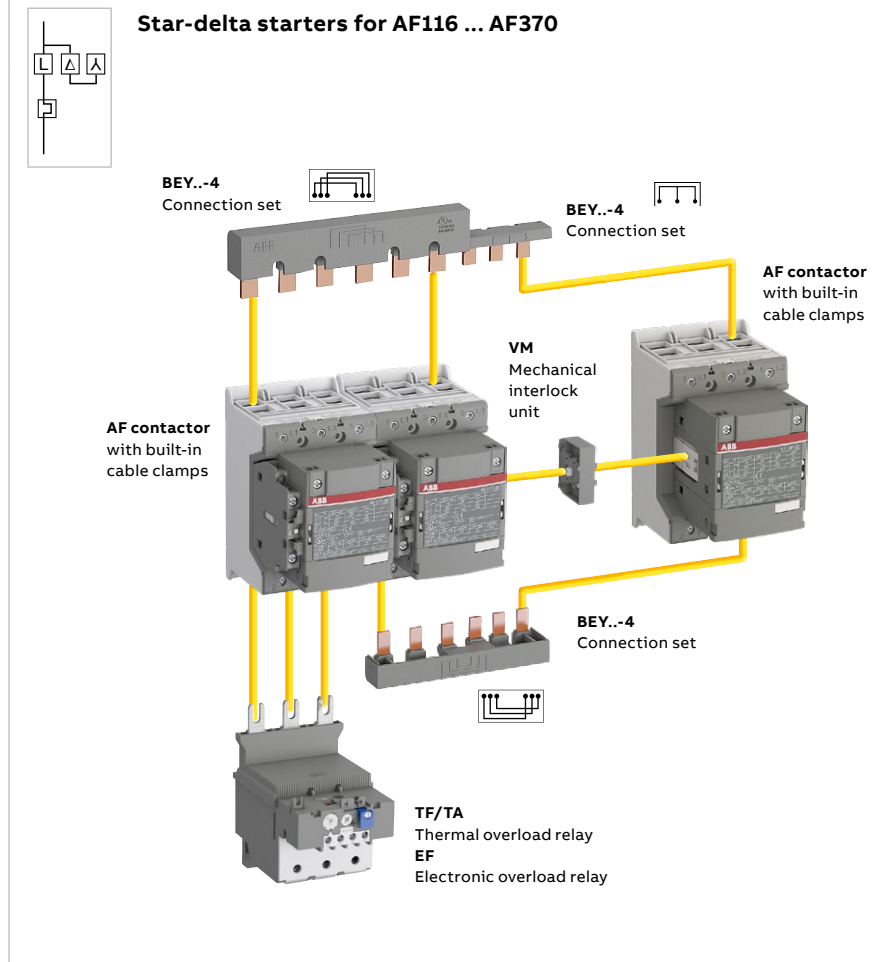

For the full coordination tables: [www.abb.com/lowvoltage](http://www.abb.com/lowvoltage) then go to the right menu: "Support", select: "Online Product Selection Tools" then select "Coordination Tables for motor protection"

# Star-delta starters protected by thermal overload relays

With AF contactors - Open type version in kit form

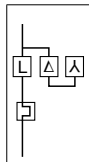

Line contactor KM1

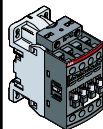

Delta contactor KM3

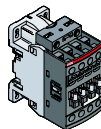

Star contactor KM2

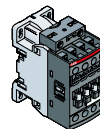

IEC AC-3	Rated power 400 V kW	Rated current 400 V A	Control voltage Uc min. ... Uc max. (1)		Line contactor KM1		Delta contactor KM3		Star contactor KM2	
			V 50/60 Hz	V DC	Type	Order code	Type	Order code	Type	Order code
7.5	15.5		24...60	20...60	AF09Z-30-10-21	1SBL136001R2110	AF09Z-30-10-21	1SBL136001R2110	AF09Z-30-10-21	1SBL136001R2110
			100...250	100...250	AF09-30-10-13	1SBL137001R1310	AF09-30-10-13	1SBL137001R1310	AF09-30-10-13	1SBL137001R1310
11	22		24...60	20...60	AF12Z-30-10-21	1SBL156001R2110	AF12Z-30-10-21	1SBL156001R2110	AF09Z-30-10-21	1SBL136001R2110
			100...250	100...250	AF12-30-10-13	1SBL157001R1310	AF12-30-10-13	1SBL157001R1310	AF09-30-10-13	1SBL137001R1310
15	29		24...60	20...60	AF16Z-30-10-21	1SBL176001R2110	AF16Z-30-10-21	1SBL176001R2110	AF09Z-30-10-21	1SBL136001R2110
			100...250	100...250	AF16-30-10-13	1SBL177001R1310	AF16-30-10-13	1SBL177001R1310	AF09-30-10-13	1SBL137001R1310
18.5	35		24...60	20...60	AF26Z-30-00-21	1SBL236001R2100	AF26Z-30-00-21	1SBL236001R2100	AF26Z-30-00-21	1SBL236001R2100
			100...250	100...250	AF26-30-00-13	1SBL237001R1300	AF26-30-00-13	1SBL237001R1300	AF26-30-00-13	1SBL237001R1300
22	41		24...60	20...60	AF26Z-30-00-21	1SBL236001R2100	AF26Z-30-00-21	1SBL236001R2100	AF26Z-30-00-21	1SBL236001R2100
			100...250	100...250	AF26-30-00-13	1SBL237001R1300	AF26-30-00-13	1SBL237001R1300	AF26-30-00-13	1SBL237001R1300
25	47		24...60	20...60	AF30Z-30-00-21	1SBL276001R2100	AF30Z-30-00-21	1SBL276001R2100	AF26Z-30-00-21	1SBL236001R2100
			100...250	100...250	AF30-30-00-13	1SBL277001R1300	AF30-30-00-13	1SBL277001R1300	AF26-30-00-13	1SBL237001R1300
37	66		24...60	20...60	AF40-30-00-11	1SBL347001R1100	AF40-30-00-11	1SBL347001R1100	AF40-30-00-11	1SBL347001R1100
			100...250	100...250	AF40-30-00-13	1SBL347001R1300	AF40-30-00-13	1SBL347001R1300	AF40-30-00-13	1SBL347001R1300
45	80		24...60	20...60	AF52-30-00-11	1SBL367001R1100	AF52-30-00-11	1SBL367001R1100	AF40-30-00-11	1SBL347001R1100
			100...250	100...250	AF52-30-00-13	1SBL367001R1300	AF52-30-00-13	1SBL367001R1300	AF40-30-00-13	1SBL347001R1300
55	97		24...60	20...60	AF65-30-00-11	1SBL387001R1100	AF65-30-00-11	1SBL387001R1100	AF40-30-00-11	1SBL347001R1100
			100...250	100...250	AF65-30-00-13	1SBL387001R1300	AF65-30-00-13	1SBL387001R1300	AF40-30-00-13	1SBL347001R1300
75	132		24...60	20...60	AF80-30-00-11	1SBL397001R1100	AF80-30-00-11	1SBL397001R1100	AF52-30-00-11	1SBL367001R1100
			100...250	100...250	AF80-30-00-13	1SBL397001R1300	AF80-30-00-13	1SBL397001R1300	AF52-30-00-13	1SBL367001R1300
90	160		24...60	20...60	AF96-30-00-11	1SBL407001R1100	AF96-30-00-11	1SBL407001R1100	AF65-30-00-11	1SBL387001R1100
			100...250	100...250	AF96-30-00-13	1SBL407001R1300	AF96-30-00-13	1SBL407001R1300	AF65-30-00-13	1SBL387001R1300
110	195		24...60	20...60	AF116-30-11-11	1SFL427001R1111	AF116-30-11-11	1SFL427001R1111	AF116-30-11-11 (4)	1SFL427001R1111
			100...250	100...250	AF116-30-11-13	1SFL427001R1311	AF116-30-11-13	1SFL427001R1311	AF116-30-11-13	1SFL427001R1311
132	230		24...60	20...60	AF140-30-11-11	1SFL447001R1111	AF140-30-11-11	1SFL447001R1111	AF116-30-11-11	1SFL427001R1111
			100...250	100...250	AF140-30-11-13	1SFL447001R1311	AF140-30-11-13	1SFL447001R1311	AF116-30-11-13	1SFL427001R1311
160	280		24...60	20...60	AF190-30-11-11	1SFL487002R1111	AF190-30-11-11	1SFL487002R1111	AF140-30-11-11	1SFL447001R1111
			100...250	100...250	AF190-30-11-13	1SFL487002R1311	AF190-30-11-13	1SFL487002R1311	AF140-30-11-13	1SFL447001R1311

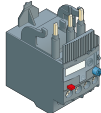
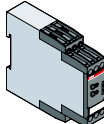
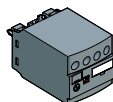
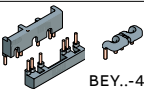
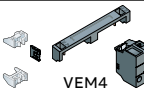
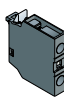
Thermal overload relays (2)			Electronic timers (3)		Accessories		Auxiliary contact blocks	
			  CT-ERS      TEF4-ON Uc = 24...240 V 50/60 Hz or DC		 BEY..-4  VEM4		 CA4	
Setting ranges	Type	Order code	Type	Order code	Type	Order code	Type	Order code
A								
7.60...10.0	TF42-10	1SAZ721201R1043	CT-ERS.21S or TEF4-ON	1SVR730100R0300 1SBN020112R1000	BEY16-4 + VEM4	1SBN081313R2000 1SBN030111R1000	-	-
10.0...13.0	TF42-13	1SAZ721201R1045	CT-ERS.21S or TEF4-ON	1SVR730100R0300 1SBN020112R1000	BEY16-4 + VEM4	1SBN081313R2000 1SBN030111R1000	-	-
16.0...20.0	TF42-20	1SAZ721201R1049	CT-ERS.21S or TEF4-ON	1SVR730100R0300 1SBN020112R1000	BEY16-4 + VEM4	1SBN081313R2000 1SBN030111R1000	-	-
20.0...24.0	TF42-24	1SAZ721201R1051	CT-ERS.21S or TEF4-ON	1SVR730100R0300 1SBN020112R1000	BEY38-4 + VEM4	1SBN082713R2000 1SBN030111R1000	KM1 : 1 x CA4-10 KM2 : 1 x CA4-10	1SBN010110R1010 1SBN010110R1010
20.0...24.0	TF42-24	1SAZ721201R1051	CT-ERS.21S or TEF4-ON	1SVR730100R0300 1SBN020112R1000	BEY38-4 + VEM4	1SBN082713R2000 1SBN030111R1000	KM1 : 1 x CA4-10 KM2 : 1 x CA4-10	1SBN010110R1010 1SBN010110R1010
24.0...29.0	TF42-29	1SAZ721201R1052	CT-ERS.21S or TEF4-ON	1SVR730100R0300 1SBN020112R1000	BEY38-4 + VEM4	1SBN082713R2000 1SBN030111R1000	KM1 : 1 x CA4-10 KM2 : 1 x CA4-10	1SBN010110R1010 1SBN010110R1010
30.0...40.0	TF65-40	1SAZ811201R1003	CT-ERS.21S or TEF4-ON	1SVR730100R0300 1SBN020112R1000	BEY65-4 + VM96-4	1SBN083413R2000 1SBN033405T1000	KM1 : 1 x CA4-10 (3) KM2 : 1 x CA4-10 1 x CA4-01 KM3 : 1 x CA4-01	1SBN010110R1010 1SBN010110R1010 1SBN010110R1001 1SBN010110R1001
36.0...47.0	TF65-47	1SAZ811201R1004	CT-ERS.21S or TEF4-ON	1SVR730100R0300 1SBN020112R1000	BEY65-4 + VM96-4	1SBN083413R2000 1SBN033405T1000	KM1 : 1 x CA4-10 (3) KM2 : 1 x CA4-10 1 x CA4-01 KM3 : 1 x CA4-01	1SBN010110R1010 1SBN010110R1010 1SBN010110R1001 1SBN010110R1001
50.0...60.0	TF65-60	1SAZ811201R1006	CT-ERS.21S or TEF4-ON	1SVR730100R0300 1SBN020112R1000	BEY65-4 + VM96-4	1SBN083413R2000 1SBN033405T1000	KM1 : 1 x CA4-10 (3) KM2 : 1 x CA4-10 1 x CA4-01 KM3 : 1 x CA4-01	1SBN010110R1010 1SBN010110R1010 1SBN010110R1001 1SBN010110R1001
65.0...78.0	TF96-78	1SAZ911201R1004	CT-ERS.21S or TEF4-ON	1SVR730100R0300 1SBN020112R1000	BEY96-4 + VM96-4	1SBN083913R2000 1SBN033405T1000	KM1 : 1 x CA4-10 (3) KM2 : 1 x CA4-10 1 x CA4-01 KM3 : 1 x CA4-01	1SBN010110R1010 1SBN010110R1010 1SBN010110R1001 1SBN010110R1001
84.0...96.0	TF96-96	1SAZ911201R1006	CT-ERS.21S or TEF4-ON	1SVR730100R0300 1SBN020112R1000	BEY96-4 + VM96-4	1SBN083913R2000 1SBN033405T1000	KM1 : 1 x CA4-10 (3) KM2 : 1 x CA4-10 1 x CA4-01 KM3 : 1 x CA4-01	1SBN010110R1010 1SBN010110R1010 1SBN010110R1001 1SBN010110R1001
100...135	TF140DU-135	1SAZ431201R1003	CT-ERS.21S	1SVR730100R0300	BEY140-4 + VM19	1SFN084413R1000 1SFN030300R1000	-	-
100...135	TF140DU-135	1SAZ431201R1003	CT-ERS.21S	1SVR730100R0300	BEY140-4 + VM19	1SFN084413R1000 1SFN030300R1000	-	-
130...175	TA200DU-175	1SAZ421201R1005	CT-ERS.21S	1SVR730100R0300	BEY190-4 + VM140/190	1SFN084813R1000 1SFN034403R1000	-	-

# Star-delta starters protected by electronic overload relays

With AF contactors - Open type version in kit form

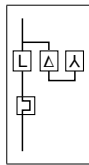

Line contactor KM1

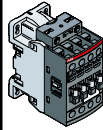

Delta contactor KM3

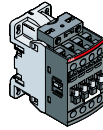

Star contactor KM2

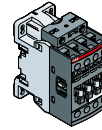

IEC AC-3	Rated power 400 V kW	Rated current 400 V A	Control voltage Uc min. ... Uc max. (1)		Line contactor KM1		Delta contactor KM3		Star contactor KM2	
			V 50/60 Hz	V DC	Type	Order code	Type	Order code	Type	Order code
7.5	15.5		24...60	20...60	AF09Z-30-10-21	1SBL136001R2110	AF09Z-30-10-21	1SBL136001R2110	AF09Z-30-10-21	1SBL136001R2110
			100...250	100...250	AF09-30-10-13	1SBL137001R1310	AF09-30-10-13	1SBL137001R1310	AF09-30-10-13	1SBL137001R1310
11	22		24...60	20...60	AF12Z-30-10-21	1SBL156001R2110	AF12Z-30-10-21	1SBL156001R2110	AF09Z-30-10-21	1SBL136001R2110
			100...250	100...250	AF12-30-10-13	1SBL157001R1310	AF12-30-10-13	1SBL157001R1310	AF09-30-10-13	1SBL137001R1310
15	29		24...60	20...60	AF16Z-30-10-21	1SBL176001R2110	AF16Z-30-10-21	1SBL176001R2110	AF09Z-30-10-21	1SBL136001R2110
			100...250	100...250	AF16-30-10-13	1SBL177001R1310	AF16-30-10-13	1SBL177001R1310	AF09-30-10-13	1SBL137001R1310
18.5	35		24...60	20...60	AF26Z-30-00-21	1SBL236001R2100	AF26Z-30-00-21	1SBL236001R2100	AF26Z-30-00-21	1SBL236001R2100
			100...250	100...250	AF26-30-00-13	1SBL237001R1300	AF26-30-00-13	1SBL237001R1300	AF26-30-00-13	1SBL237001R1300
22	41		24...60	20...60	AF26Z-30-00-21	1SBL236001R2100	AF26Z-30-00-21	1SBL236001R2100	AF26Z-30-00-21	1SBL236001R2100
			100...250	100...250	AF26-30-00-13	1SBL237001R1300	AF26-30-00-13	1SBL237001R1300	AF26-30-00-13	1SBL237001R1300
25	47		24...60	20...60	AF30Z-30-00-21	1SBL276001R2100	AF30Z-30-00-21	1SBL276001R2100	AF26Z-30-00-21	1SBL236001R2100
			100...250	100...250	AF30-30-00-13	1SBL277001R1300	AF30-30-00-13	1SBL277001R1300	AF26-30-00-13	1SBL237001R1300
37	66		24...60	20...60	AF40-30-00-11	1SBL347001R1100	AF40-30-00-11	1SBL347001R1100	AF40-30-00-11	1SBL347001R1100
			100...250	100...250	AF40-30-00-13	1SBL347001R1300	AF40-30-00-13	1SBL347001R1300	AF40-30-00-13	1SBL347001R1300
45	80		24...60	20...60	AF52-30-00-11	1SBL367001R1100	AF52-30-00-11	1SBL367001R1100	AF40-30-00-11	1SBL347001R1100
			100...250	100...250	AF52-30-00-13	1SBL367001R1300	AF52-30-00-13	1SBL367001R1300	AF40-30-00-13	1SBL347001R1300
55	97		24...60	20...60	AF65-30-00-11	1SBL387001R1100	AF65-30-00-11	1SBL387001R1100	AF40-30-00-11	1SBL347001R1100
			100...250	100...250	AF65-30-00-13	1SBL387001R1300	AF65-30-00-13	1SBL387001R1300	AF40-30-00-13	1SBL347001R1300
75	132		24...60	20...60	AF80-30-00-11	1SBL397001R1100	AF80-30-00-11	1SBL397001R1100	AF52-30-00-11	1SBL367001R1100
			100...250	100...250	AF80-30-00-13	1SBL397001R1300	AF80-30-00-13	1SBL397001R1300	AF52-30-00-13	1SBL367001R1300
90	160		24...60	20...60	AF96-30-00-11	1SBL407001R1100	AF96-30-00-11	1SBL407001R1100	AF65-30-00-11	1SBL387001R1100
			100...250	100...250	AF96-30-00-13	1SBL407001R1300	AF96-30-00-13	1SBL407001R1300	AF65-30-00-13	1SBL387001R1300
110	195		24...60	20...60	AF116-30-11-11	1SFL427001R1111	AF116-30-11-11	1SFL427001R1111	AF116-30-11-11 (4)	1SFL427001R1111
			100...250	100...250	AF116-30-11-13	1SFL427001R1311	AF116-30-11-13	1SFL427001R1311	AF116-30-11-13	1SFL427001R1311
132	230		24...60	20...60	AF140-30-11-11	1SFL447001R1111	AF140-30-11-11	1SFL447001R1111	AF116-30-11-11	1SFL427001R1111
			100...250	100...250	AF140-30-11-13	1SFL447001R1311	AF140-30-11-13	1SFL447001R1311	AF116-30-11-13	1SFL427001R1311
160	280		24...60	20...60	AF190-30-11-11	1SFL487002R1111	AF190-30-11-11	1SFL487002R1111	AF140-30-11-11	1SFL447001R1111
			100...250	100...250	AF190-30-11-13	1SFL487002R1311	AF190-30-11-13	1SFL487002R1311	AF140-30-11-13	1SFL447001R1311
200	350		24...60	20...60	AF205-30-11-11	1SFL527002R1111	AF205-30-11-11	1SFL527002R1111	AF190-30-11-11	1SFL487002R1111
			100...250	100...250	AF205-30-11-13	1SFL527002R1311	AF205-30-11-13	1SFL527002R1311	AF190-30-11-13	1SFL487002R1311
250	430		24...60	20...60	AF265-30-11-11	1SFL547002R1111	AF265-30-11-11	1SFL547002R1111	AF205-30-11-11	1SFL527002R1111
			100...250	100...250	AF265-30-11-13	1SFL547002R1311	AF265-30-11-13	1SFL547002R1311	AF205-30-11-13	1SFL527002R1311
315	540		24...60	20...60	AF370-30-11-11	1SFL607002R1111	AF370-30-11-11	1SFL607002R1111	AF265-30-11-11	1SFL547002R1111
			100...250	100...250	AF370-30-11-13	1SFL607002R1311	AF370-30-11-13	1SFL607002R1311	AF265-30-11-13	1SFL547002R1311
355	610		24...60	20...60	AF370-30-11-11	1SFL607002R1111	AF370-30-11-11	1SFL607002R1111	AF305-30-11-11	1SFL587002R1111
			100...250	100...250	AF370-30-11-13	1SFL607002R1311	AF370-30-11-13	1SFL607002R1311	AF305-30-11-13	1SFL587002R1311

(1) AF09 ... AF370: ambient temperature ≤ 60 °C.  
 (2) The setting current value is: nominal motor current x 0.58. Overload relay type given for 400 V - AC-3.  
 For other voltage, select overload relay type according to required nominal motor current x 0.58.  
 (3) On-delay timer without dwelling-time (e.g.: side-mounted CT-ERS.21S or front-mounted TEF4-ON) is enough to countdown the programmed starting time during "Star connection". In case of use of front-mounted TEF4-ON on-delay timer, mount on KM1 contactor AF26 ... AF96 a side-mounted CAL4-11 auxiliary contact block instead of CA4-10 auxiliary contact block.  
 (4) AF80 can also be used, but no connection set and mechanical interlock is available for this combination.

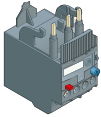
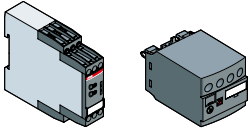
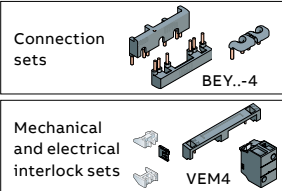
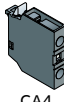
Electronic overload relays (2)			Electronic timers (3)		Accessories		Auxiliary contact blocks	
								
Setting ranges	Type	Order code	Type	Order code	Type	Order code	Type	Order code
A				UC = 24...240 V 50/60 Hz or DC				
5.70...18.9	EF19-18.9	1SAX121001R1105	CT-ERS.21S or TEF4-ON	1SVR730100R0300 1SBN020112R1000	BEY16-4 + VEM4	1SBN081313R2000 1SBN030111R1000	-	-
5.70...18.9	EF19-18.9	1SAX121001R1105	CT-ERS.21S or TEF4-ON	1SVR730100R0300 1SBN020112R1000	BEY16-4 + VEM4	1SBN081313R2000 1SBN030111R1000	-	-
5.70...18.9	EF19-18.9	1SAX121001R1105	CT-ERS.21S or TEF4-ON	1SVR730100R0300 1SBN020112R1000	BEY16-4 + VEM4	1SBN081313R2000 1SBN030111R1000	-	-
9.00...30.0	EF45-30	1SAX221001R1101	CT-ERS.21S or TEF4-ON	1SVR730100R0300 1SBN020112R1000	BEY38-4 + VEM4	1SBN082713R2000 1SBN030111R1000	KM1 : 1 x CA4-10 KM2 : 1 x CA4-10	1SBN010110R1010 1SBN010110R1010
9.00...30.0	EF45-30	1SAX221001R1101	CT-ERS.21S or TEF4-ON	1SVR730100R0300 1SBN020112R1000	BEY38-4 + VEM4	1SBN082713R2000 1SBN030111R1000	KM1 : 1 x CA4-10 KM2 : 1 x CA4-10	1SBN010110R1010 1SBN010110R1010
9.00...30.0	EF45-30	1SAX221001R1101	CT-ERS.21S or TEF4-ON	1SVR730100R0300 1SBN020112R1000	BEY38-4 + VEM4	1SBN082713R2000 1SBN030111R1000	KM1 : 1 x CA4-10 KM2 : 1 x CA4-10	1SBN010110R1010 1SBN010110R1010
25...70	EF65-70	1SAX331001R1101	CT-ERS.21S or TEF4-ON	1SVR730100R0300 1SBN020112R1000	BEY65-4 + VM96-4	1SBN083413R2000 1SBN033405T1000	KM1 : 1 x CA4-10 (3) KM2 : 1 x CA4-10 1 x CA4-01 KM3 : 1 x CA4-01	1SBN010110R1010 1SBN010110R1010 1SBN010110R1001 1SBN010110R1001
25...70	EF65-70	1SAX331001R1101	CT-ERS.21S or TEF4-ON	1SVR730100R0300 1SBN020112R1000	BEY65-4 + VM96-4	1SBN083413R2000 1SBN033405T1000	KM1 : 1 x CA4-10 (3) KM2 : 1 x CA4-10 1 x CA4-01 KM3 : 1 x CA4-01	1SBN010110R1010 1SBN010110R1010 1SBN010110R1001 1SBN010110R1001
25...70	EF65-70	1SAX331001R1101	CT-ERS.21S or TEF4-ON	1SVR730100R0300 1SBN020112R1000	BEY65-4 + VM96-4	1SBN083413R2000 1SBN033405T1000	KM1 : 1 x CA4-10 (3) KM2 : 1 x CA4-10 1 x CA4-01 KM3 : 1 x CA4-01	1SBN010110R1010 1SBN010110R1010 1SBN010110R1001 1SBN010110R1001
36...100	EF96-100	1SAX341001R1101	CT-ERS.21S or TEF4-ON	1SVR730100R0300 1SBN020112R1000	BEY96-4 + VM96-4	1SBN083913R2000 1SBN033405T1000	KM1 : 1 x CA4-10 (3) KM2 : 1 x CA4-10 1 x CA4-01 KM3 : 1 x CA4-01	1SBN010110R1010 1SBN010110R1010 1SBN010110R1001 1SBN010110R1001
36...100	EF96-100	1SAX341001R1101	CT-ERS.21S or TEF4-ON	1SVR730100R0300 1SBN020112R1000	BEY96-4 + VM96-4	1SBN083913R2000 1SBN033405T1000	KM1 : 1 x CA4-10 (3) KM2 : 1 x CA4-10 1 x CA4-01 KM3 : 1 x CA4-01	1SBN010110R1010 1SBN010110R1010 1SBN010110R1001 1SBN010110R1001
54...150	EF146-150	1SAX351001R1101	CT-ERS.21S	1SVR730100R0300	BEY140-4 + VM19	1SBN084413R1000 1SBN030300R1000	-	-
54...150	EF146-150	1SAX351001R1101	CT-ERS.21S	1SVR730100R0300	BEY140-4 + VM19	1SBN084413R1000 1SBN030300R1000	-	-
63...210	EF205-210	1SAX531001R1101	CT-ERS.21S	1SVR730100R0300	BEY190-4 + VM140/190	1SBN084813R1000 1SBN034403R1000	-	-
63...210	EF205-210	1SAX531001R1101	CT-ERS.21S	1SVR730100R0300	BEY205-4 + VM19	1SBN085213R1000 1SBN030300R1000	-	-
115...380	EF370-380	1SAX611001R1101	CT-ERS.21S	1SVR730100R0300	BEY265-4 + VM205/265	1SBN085413R1000 1SBN035203R1000	-	-
115...380	EF370-380	1SAX611001R1101	CT-ERS.21S	1SVR730100R0300	BEY370-4 + VM19	1SBN085813R1000 1SBN030300R1000	-	-
115...380	EF370-380	1SAX611001R1101	CT-ERS.21S	1SVR730100R0300	BEY370-4 + VM19	1SBN085813R1000 1SBN030300R1000	-	-

## Star-delta starters protected by overload relays

With AF contactors - Open type version in kit form  
Switching frequency diagrams

### General

Switching frequency/hour, according to acceleration time and load factor. Respect of the following conditions enables utilization of the starter without excessive overheating of the connections or nuisance tripping of the thermal overload relay.

### Thermal overload relay

Intermittent periodic duty

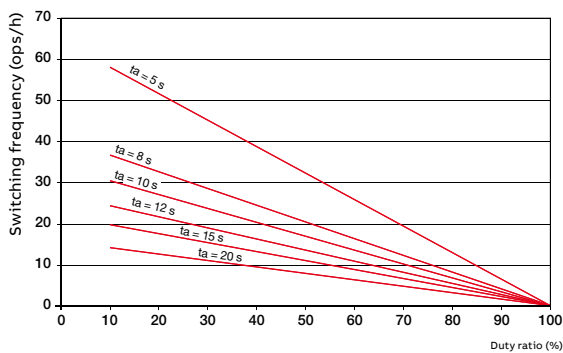

ta: motor starting time

### Example:

Starting time of the motor: 7 second (use 8s curve) - Duty ratio: 63 % means a permitted switching frequency of max. 15 operating cycles per hour.

This corresponds to a 4 minute operating cycle (15 starts/hr) with 7 seconds acceleration, 2.5 minutes operation and 1.5 minutes rest.

**Electronic overload relay** : please consult us

# Star-delta starters protected by overload relays

With AF contactors - Open type version in kit form

Wiring diagrams with CT-ERS.21S timer

## Star-delta starters

Power circuit

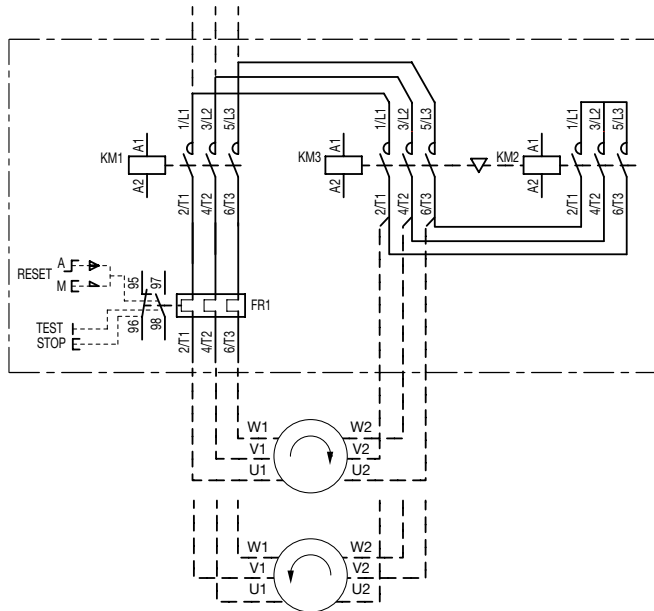

AC or DC local control with CT-ERS.21S timer

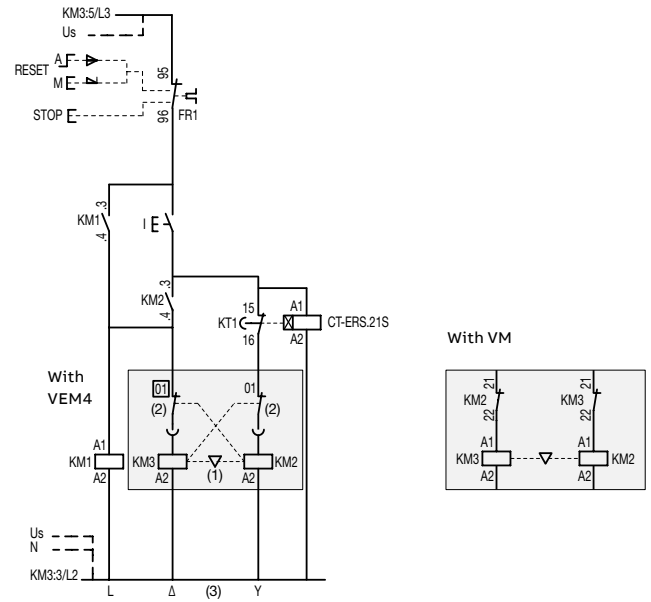

AC or DC remote control with CT-ERS.21S timer

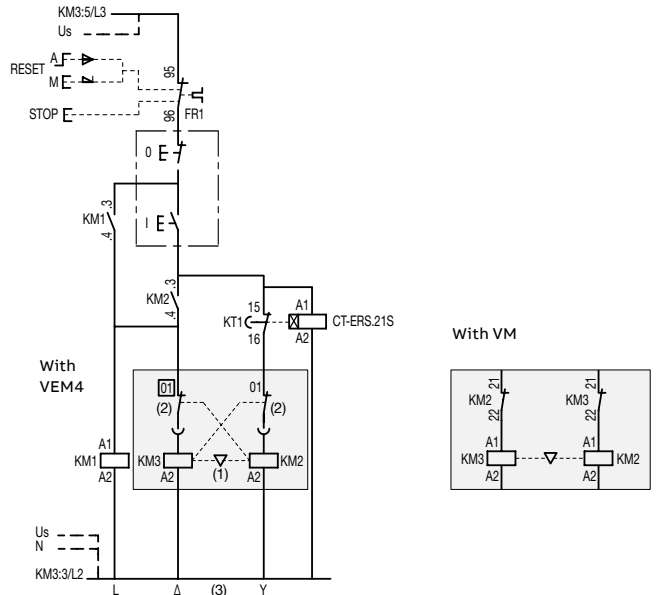

Note: - VEM4 = VM4 (1) + VE4 (2) with A2-A2 (3) connection  
 (Except for coil Uc 12-20 V DC : use VM4 with CA4).  
 - coil Uc 12-20 V DC : A1+, A2-



# Star-delta starters protected by overload relays

With AF contactors - Open type version in kit form

Wiring diagrams with TEF4-ON timer

## Star-delta starters

Power circuit

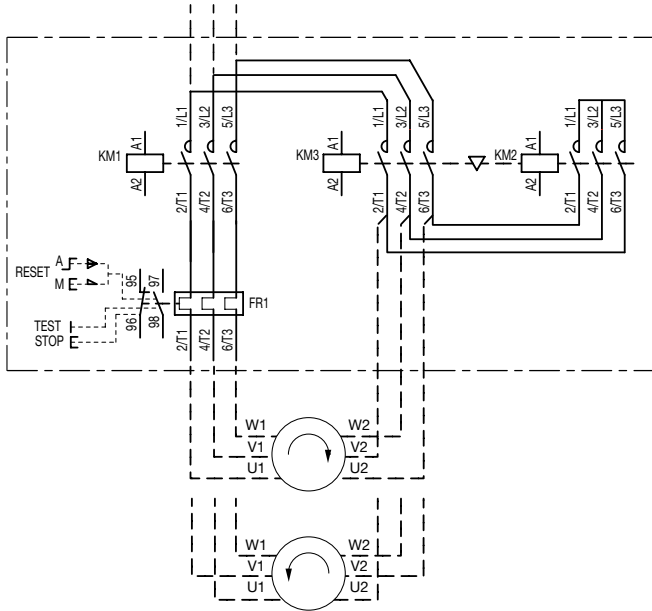

AC or DC local control with TEF4-ON timer  
 Uc = 24...240 V 50/60 Hz or DC

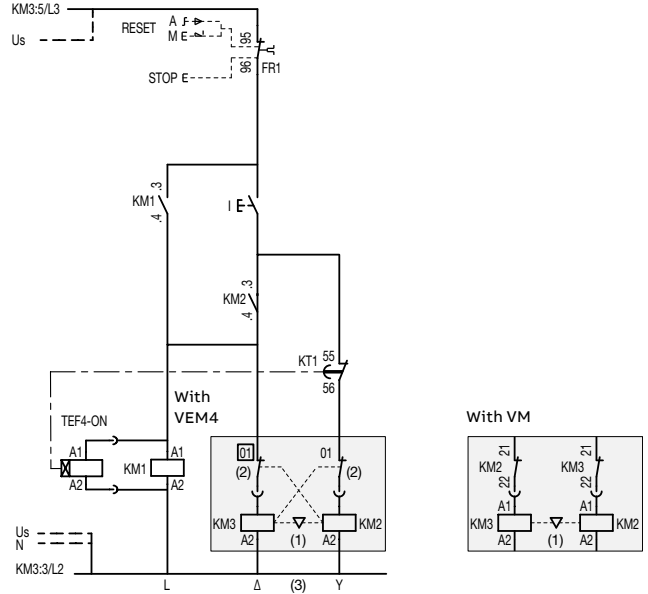

AC or DC remote control with TEF4-ON timer  
 Uc = 24...240 V 50/60 Hz or DC

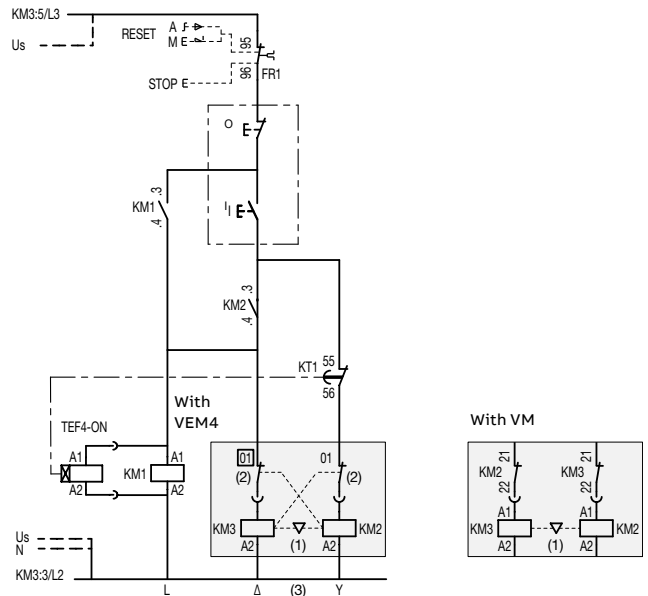

Note: VEM4 = VM4 (1) + VE4 (2) with A2-A2 (3) connection

## Star-delta starters protected by thermal overload relays

With AF contactors - Open type version in kit form

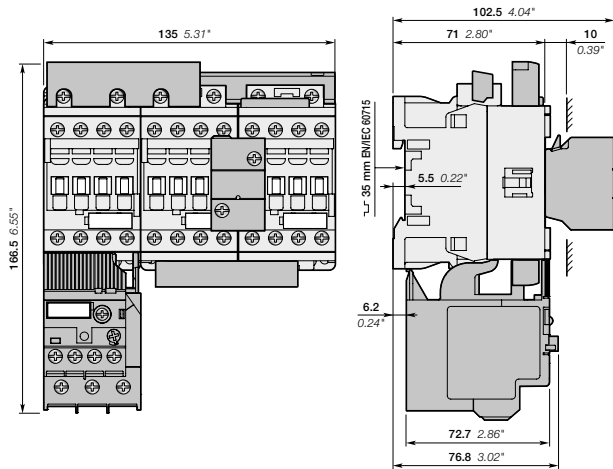

AF09, AF12, AF16  
 + BEY16-4, VEM4  
 + TF42 thermal overload relay

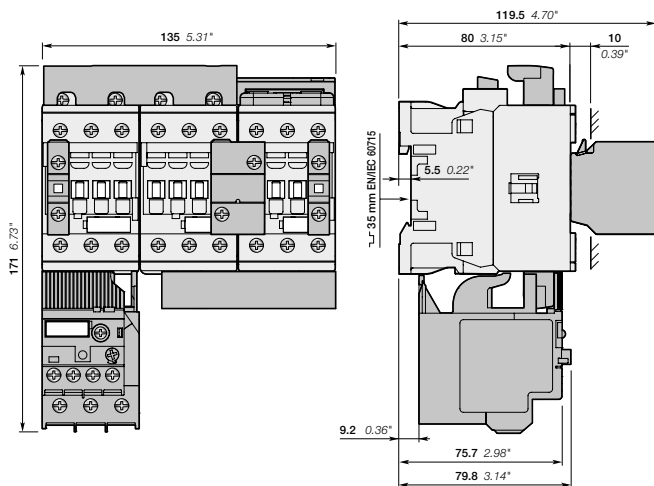

AF26, AF30, AF38  
 + BEY38-4, VEM4, CA4-10  
 + TF42 thermal overload relay

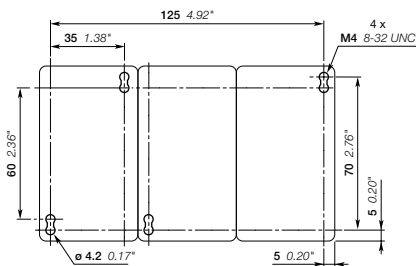

Note: contactor lateral distance to grounded component 2 mm 0.08" min.

Main dimensions mm, inches

# Star-delta starters protected by thermal overload relays

With AF contactors - Open type version in kit form

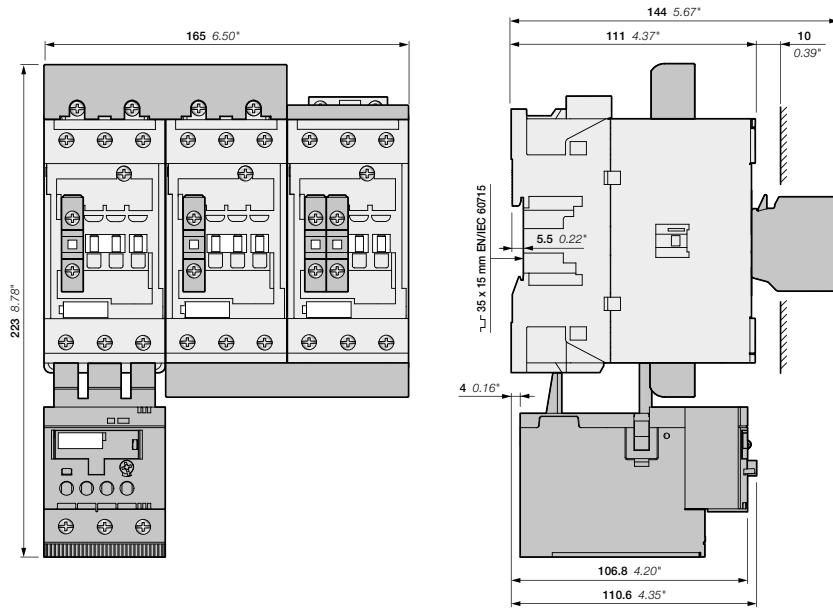

AF40, AF52, AF65  
 + BEY65-4, VM96-4, CA4-10, CA4-01  
 + TF65 thermal overload relay

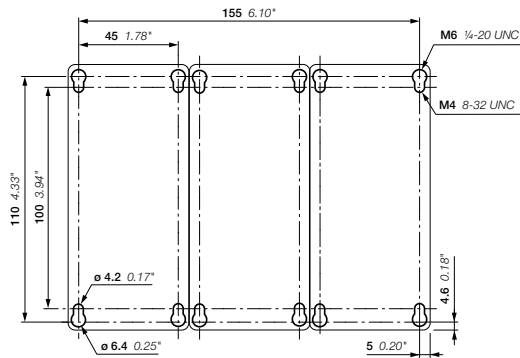

Main dimensions mm, inches

## Star-delta starters protected by thermal overload relays

With AF contactors - Open type version in kit form

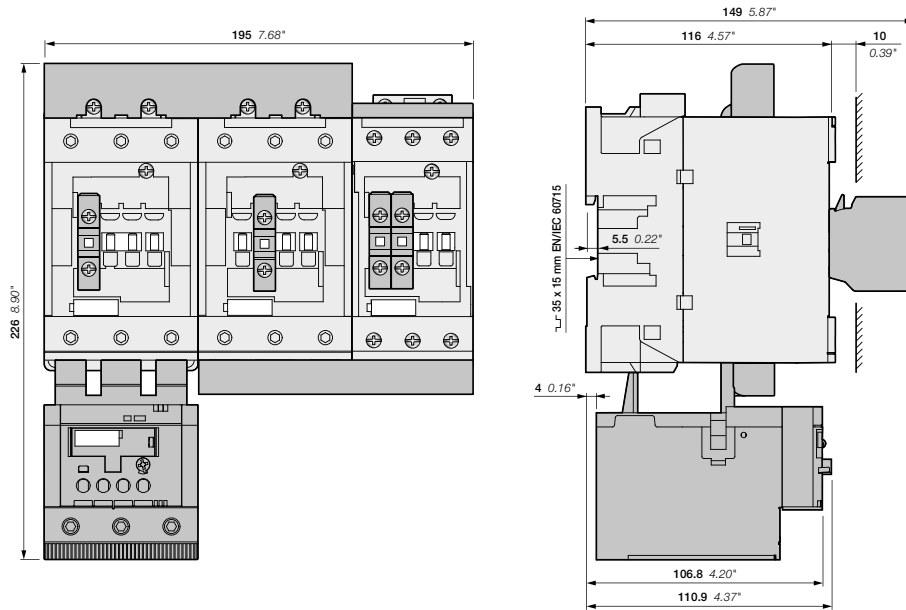

- Line, Delta: AF80, AF96
- + Star: AF52, AF65
- + BEY96-4, VM96-4, CA4-10, CA4-01
- + TF96 thermal overload relay

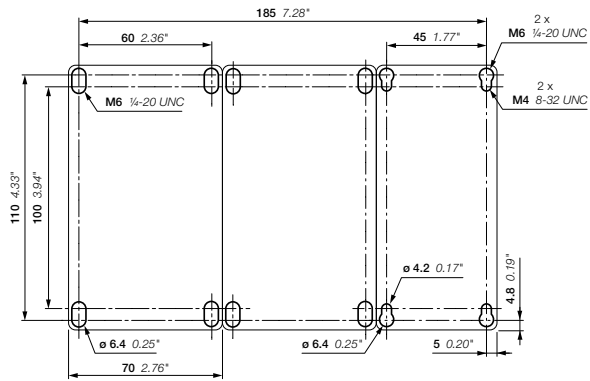

Main dimensions mm, inches

# Star-delta starters protected by thermal overload relays

With AF contactors - Open type version in kit form

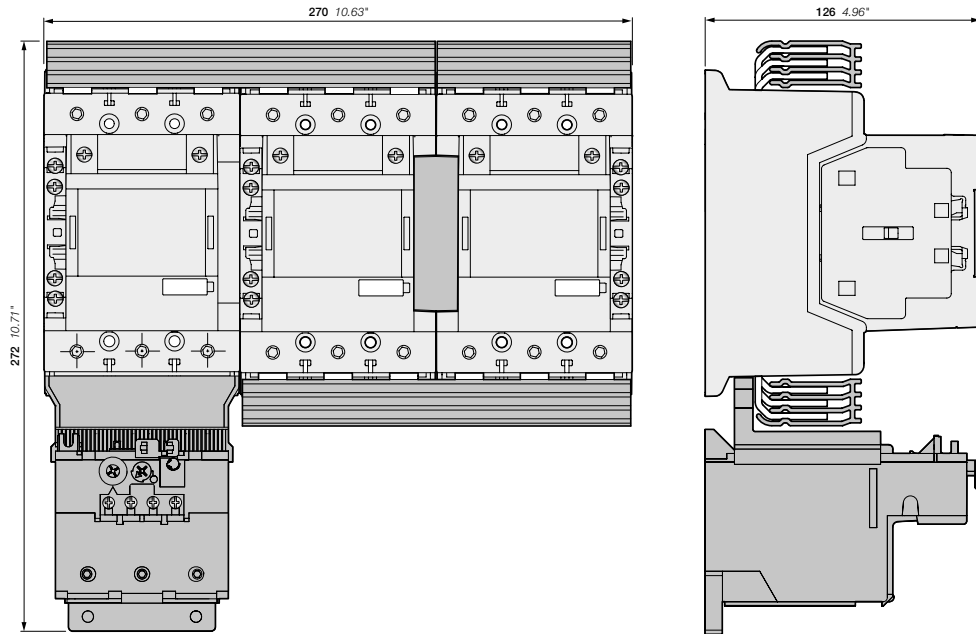

AF116, AF140, AF146  
 + BEY140-4, VM19  
 + TF140 thermal overload relay

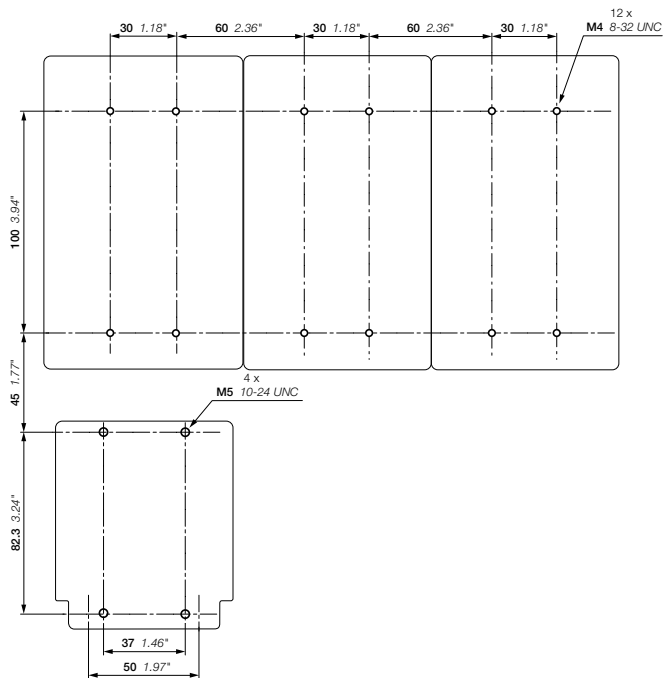

Main dimensions mm, inches

# Star-delta starters protected by thermal overload relays

With AF contactors - Open type version in kit form

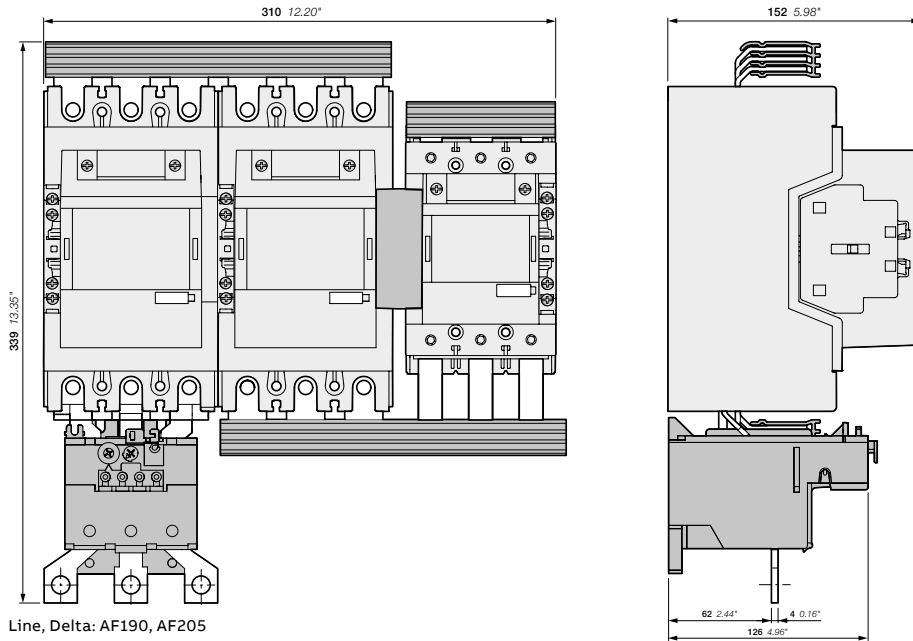

- Line, Delta: AF190, AF205
- + Star: AF116, AF140, AF146
- + BEY190-4, VM140/190
- + TA200 thermal overload relay

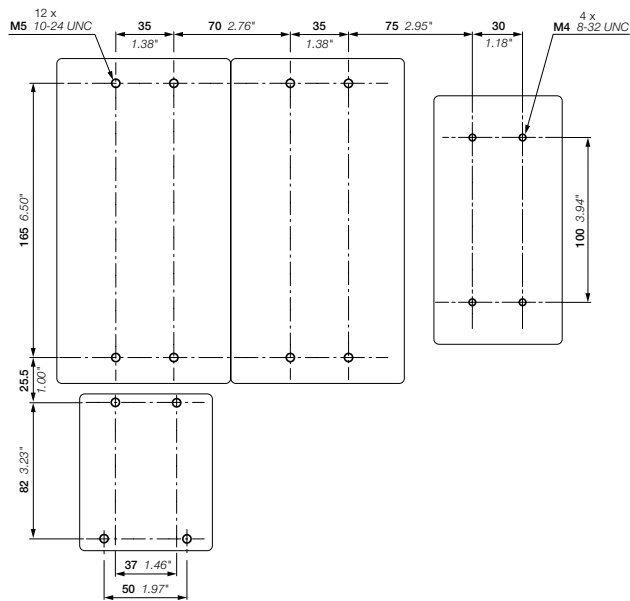

Main dimensions mm, inches

# Star-delta starters protected by electronic overload relays

With AF contactors - Open type version in kit form

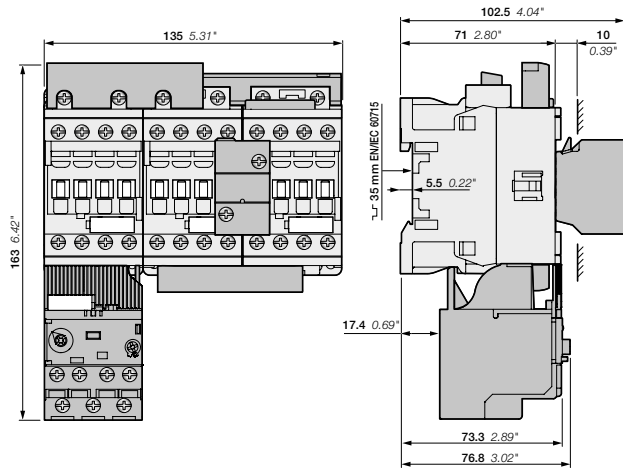

AF09, AF12, AF16  
 + BEY16-4, VEM4  
 + EF19 electronic overload relay

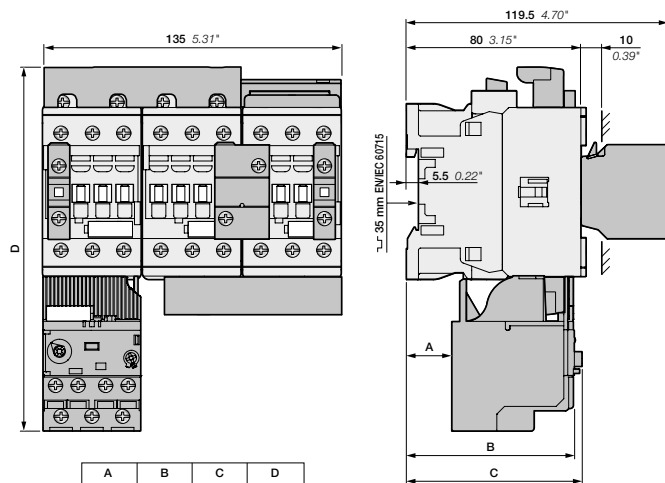

AF26, AF30, AF38  
 + BEY38-4, VEM4, CA4-10  
 + EF19/EF45 electronic overload relay

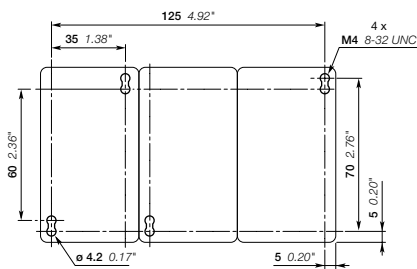

Note: contactor lateral distance to grounded component 2 mm 0.08" min.

Main dimensions mm, inches

# Star-delta starters protected by electronic overload relays

With AF contactors - Open type version in kit form

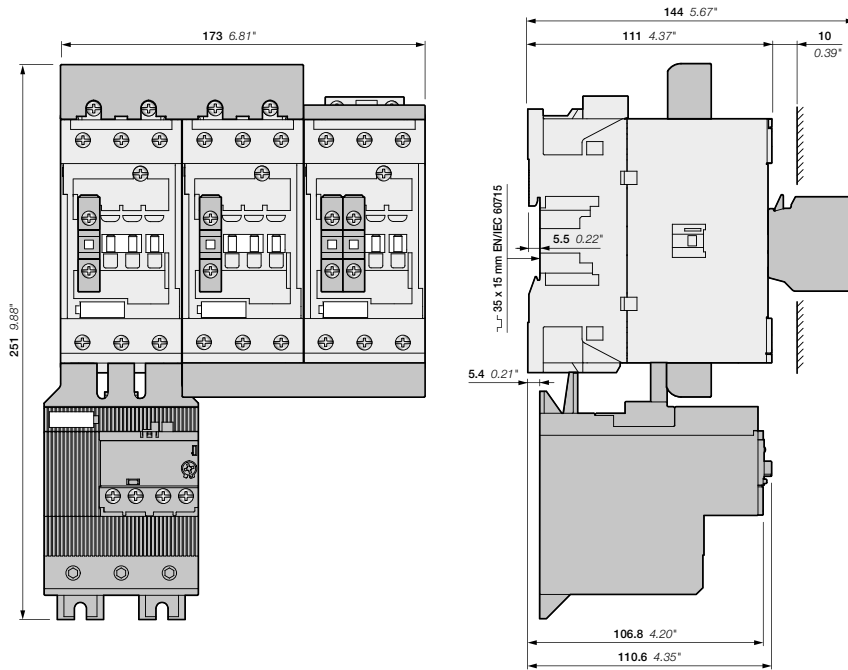

AF40, AF52, AF65  
 + BEY65-4, VM96-4, CA4-10, CA4-01  
 + EF65 electronic overload relay

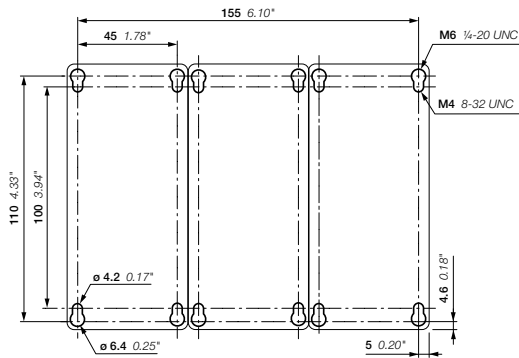

Main dimensions mm, inches



# Star-delta starters protected by electronic overload relays

With AF contactors - Open type version in kit form

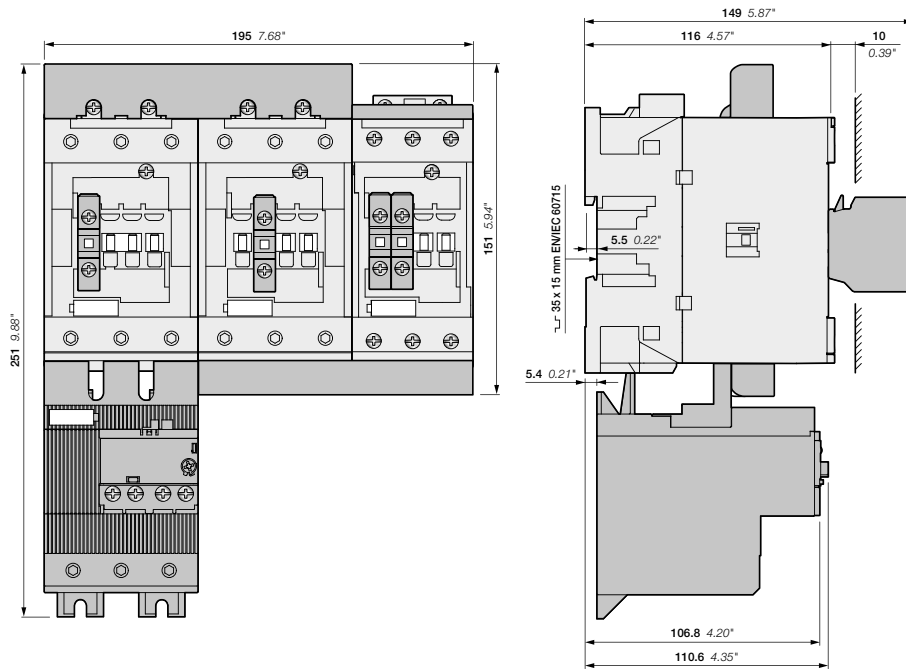

- Line, Delta: AF80, AF96
- + Star: AF52, AF65
- + BEY96-4, VM96-4, CA4-10, CA4-01
- + EF96 electronic overload relay

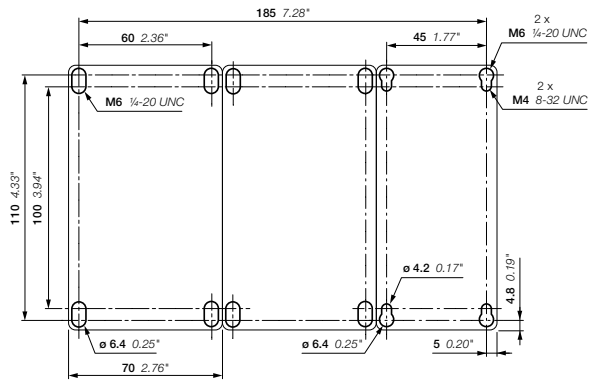

Main dimensions mm, inches

# Star-delta starters protected by electronic overload relays

With AF contactors - Open type version in kit form

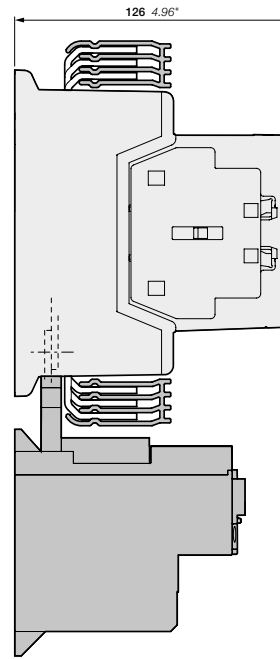
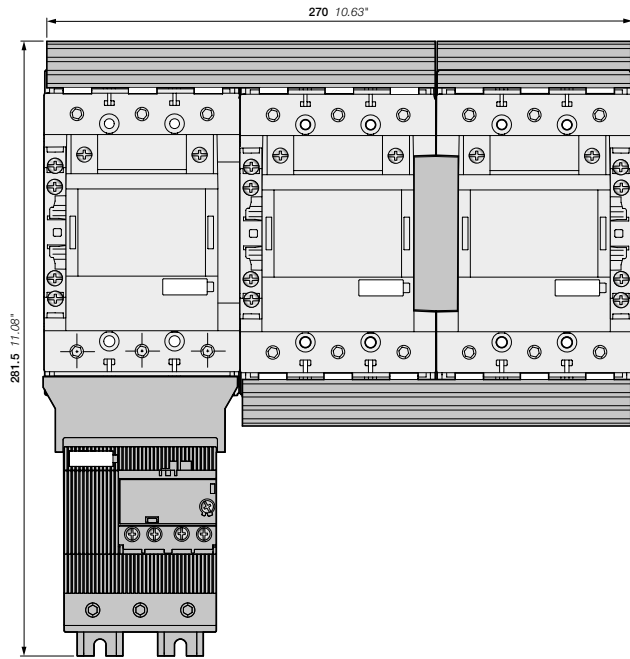

AF116, AF140, AF146  
 + BEY140-4, VM19  
 + EF146 electronic overload relay

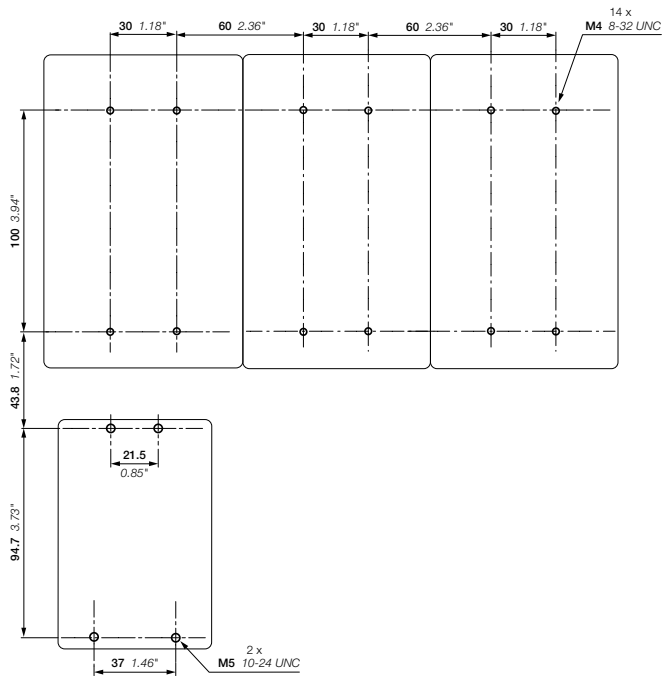

Main dimensions mm, inches

# Star-delta starters protected by electronic overload relays

With AF contactors - Open type version in kit form

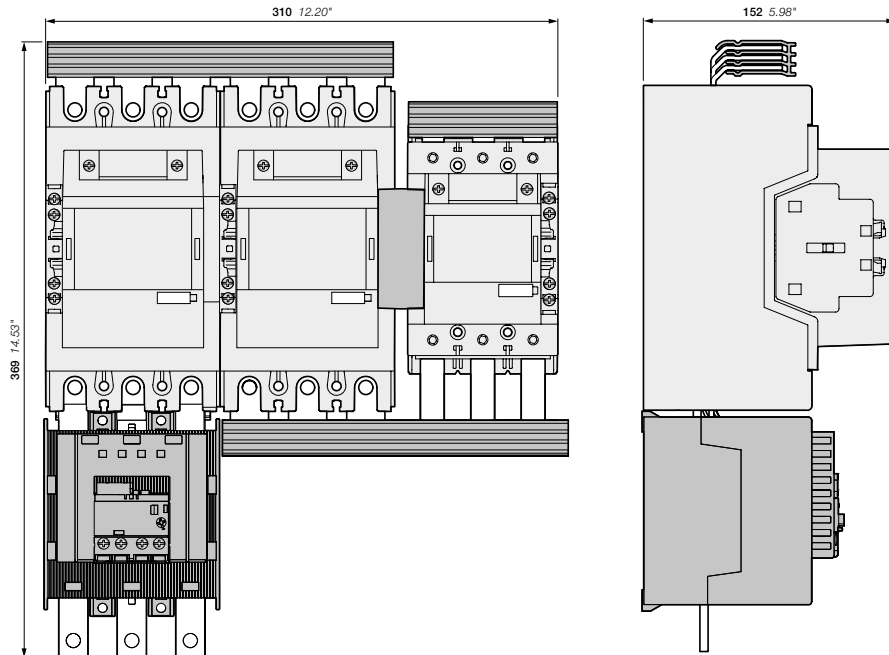

- Line, Delta: AF190, AF205
- + Star: AF116, AF140, AF146
- + BEY190-4, VM140/190
- + EF205 electronic overload relay

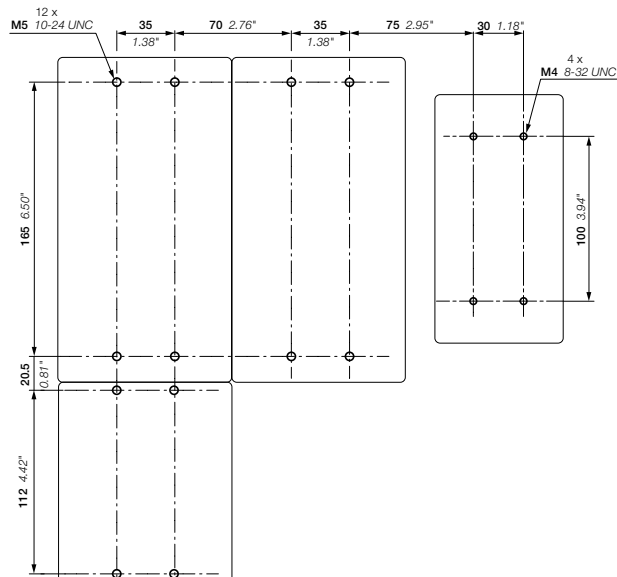

Main dimensions mm, inches

## Star-delta starters protected by electronic overload relays

With AF contactors - Open type version in kit form

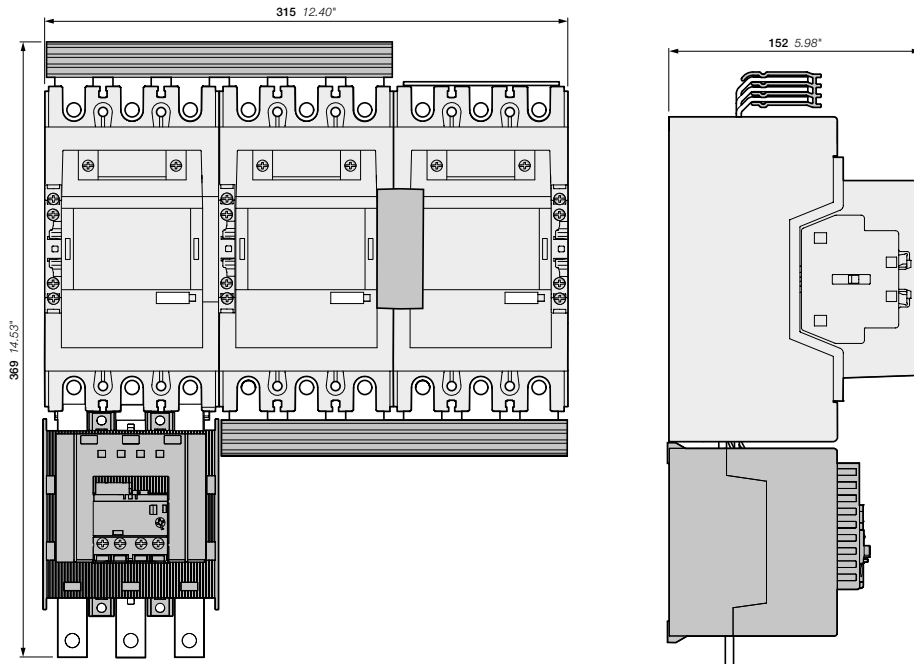

AF190, AF205  
 + BEY205-4, VM19  
 + EF205 electronic overload relay

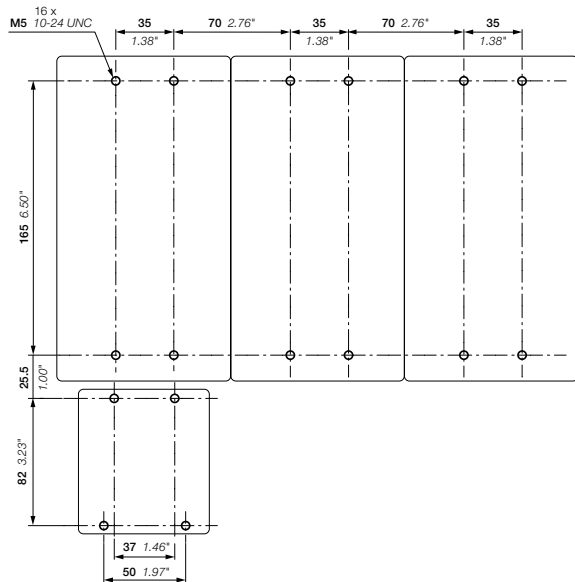

Main dimensions mm, inches

# Star-delta starters protected by electronic overload relays

With AF contactors - Open type version in kit form

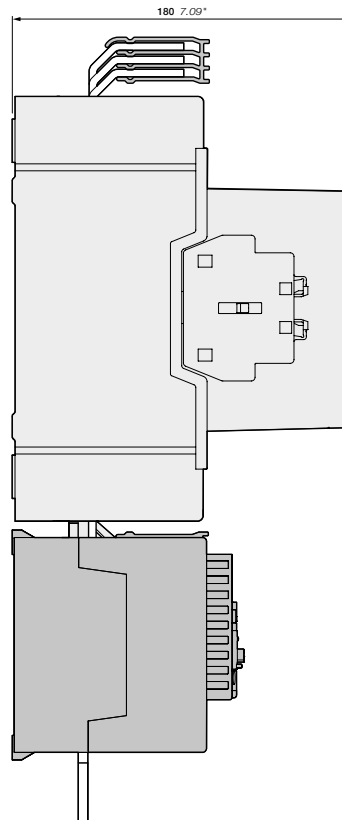
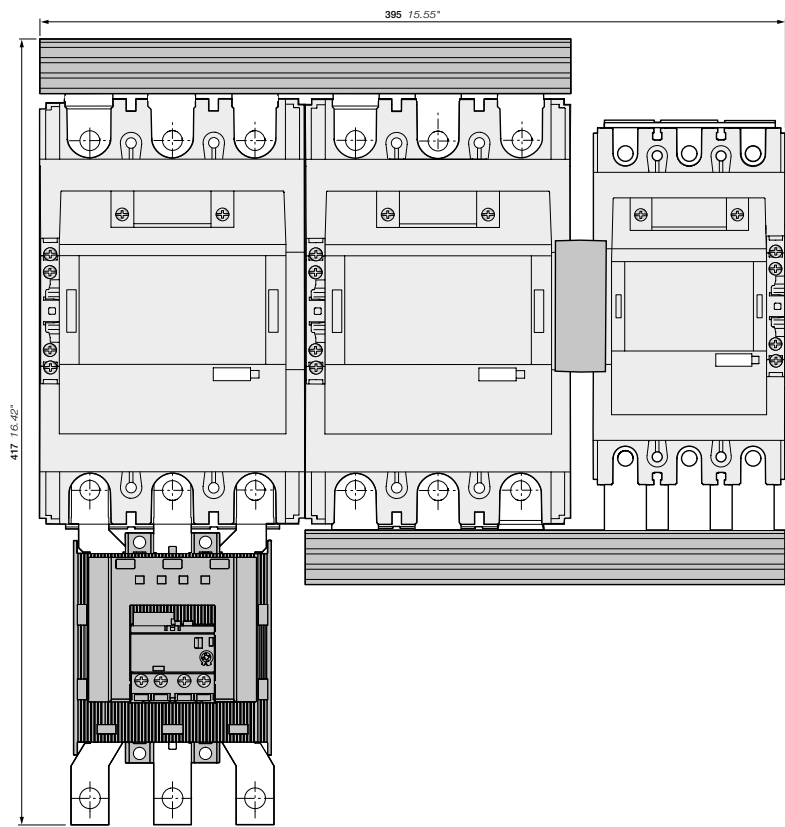

- Line, Delta: AF265, AF305, AF370
- + Star: AF190, AF205
- + BEY265-4, VM205/265
- + EF370 electronic overload relay

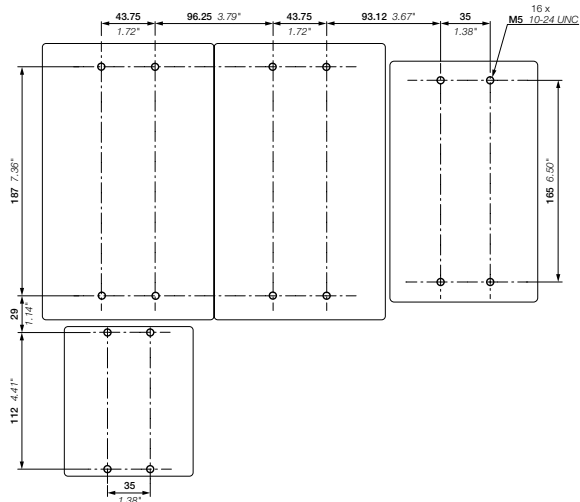

Main dimensions mm, inches

## Star-delta starters protected by electronic overload relays

With AF contactors - Open type version in kit form

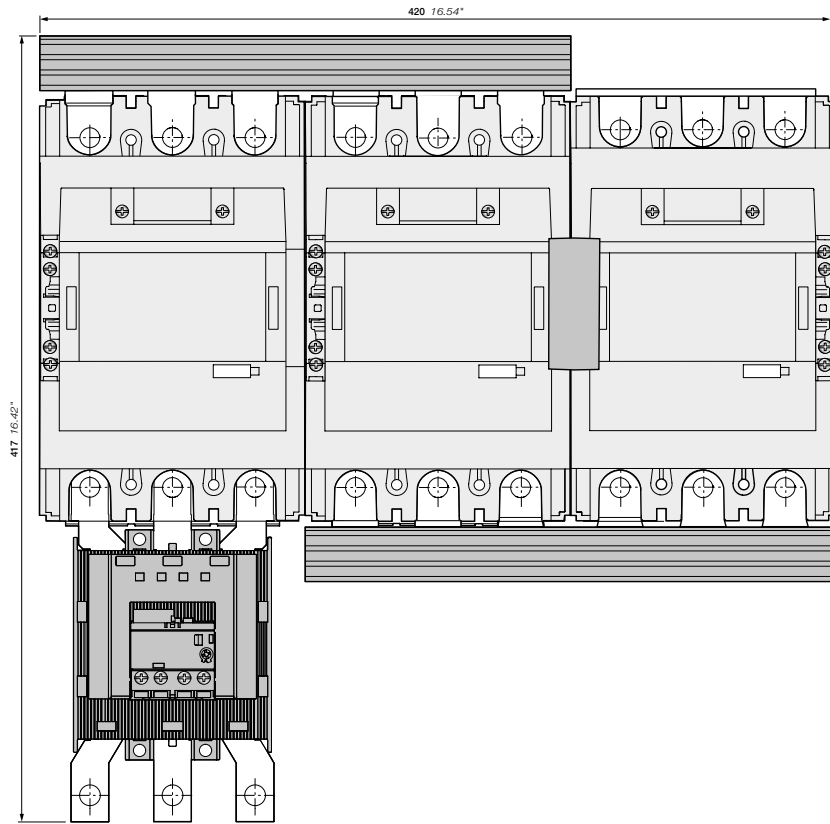

AF265, AF305, AF370  
 + BEY370-4, VM19  
 + EF370 electronic overload relay

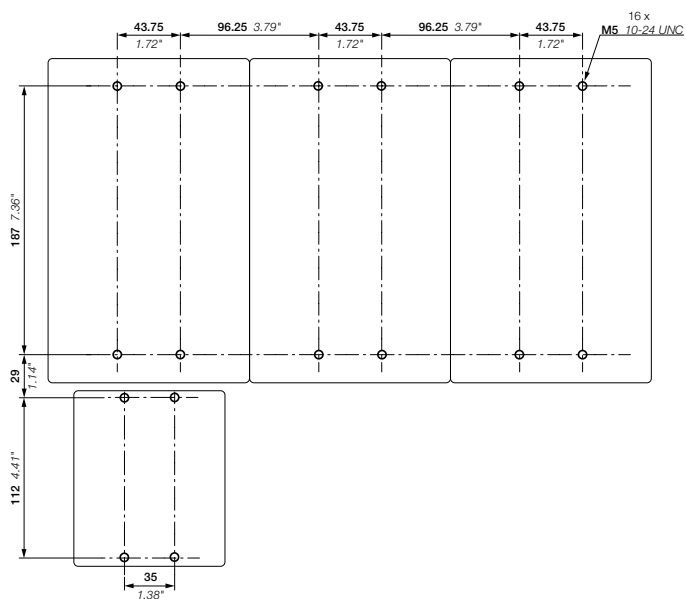
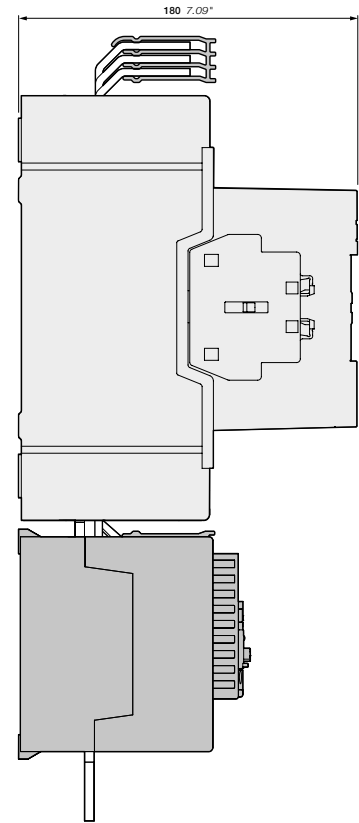

Main dimensions mm, inches



**For direct product details information, use product type or order code, ex:**

[www.abb.com/productdetails/AF09-30-10-13](http://www.abb.com/productdetails/AF09-30-10-13)  
or  
[www.abb.com/productdetails/1SBL137001R1310](http://www.abb.com/productdetails/1SBL137001R1310)

---

# Certifications and approvals

## General technical data

### **13/2 Certifications and approvals**

#### **General technical data**

- 13/8** Coordination with short-circuit protection devices
- 13/10** Standards, specifications and certifying organizations
- 13/12** Terms and technical definitions
- 13/14** Standards and utilization categories
- 13/16** North American standards and utilization categories
- 13/17** Degrees of protection
- 13/18** Climatic withstand of devices



## Certifications and approvals

Designed according to the appropriate specifications, the devices in this catalogue have been built and tested. They can be used in most countries without any further certifications.

Some countries, however, require certification according to their own national standards. In other cases, the Marine for example, approvals ratifying that particular specifications have been met are necessary.

The table below shows the approvals and certifications for different devices.















The following documents may be obtained on request:

- Certificates of conformity
- Certificates of certification or approval.

The use of certified devices does not exonerate the equipment supplier from complying with the legal specifications of the country concerned.















### Explanation of symbols:

■ **Standard design approved**, the company labels bear the certification mark when this is required.













Mark	Certifications						Approvals: ship classification societies							
	 CSA Canada	 UL USA	 cULus North America	 CCC China	 GOST or EAC Russia	 KC Korea	 BV France	 DNV-GL	 LR Gr.Britain	 RINA Italy	 ABS USA	 RMRS Russia	 CCS China shipping	 ClassNK Japan
<b>3-pole contactors with screw terminals</b>														
<b>4 to 7.5 kW</b>														
AC operated			■	■										
AS09, AS12, AS16			E312527											
DC operated			■	■										
ASL09, ASL12, ASL16			E312527											
<b>4 to 45 kW</b>														
AC / DC operated			■	■	■	■	■	■	■	■	■	■	■	■
AF09, AF12, AF16, AF26, AF30, AF38			E312527											
AC / DC operated			■	■	■	■	■	■	■	■	■	■	■	■
AF40, AF52, AF65, AF80, AF96			E312527											
<b>55 to 200 kW</b>														
AC / DC operated (2)			■	■	■	■	■	■	■	■	■	■	■	■
AF116, AF140, AF146t			E36588											
AC / DC operated (2)			■	■	■	■	■	■	■	■	■	■	■	■
AF190, AF205, AF265, AF305, AF370			E36588											
<b>200 to 560 kW</b>														
AC / DC operated			■	■	■	■	■	■	■	■	■	■	■	■
AF400, AF460, AF580, AF750			E36588											
AC / DC operated			■	■	■	■	■	■	■	■	■	■	■	■
AF1250			E73397											
AC / DC operated			■	■	■	■	■	■	■	■	■	■	■	■
AF1350, AF1650			E36588											
AC / DC operated			■	■	■	■	■	■	■	■	■	■	■	■
AF2050			E73397											
AC / DC operated			■	■	■	■	■	■	■	■	■	■	■	■
AF2650, AF2850			E73397						(1)				(1)	
(1) For 2650 only.														
<b>4-pole contactors with screw terminals</b>														
<b>25 to 125 A, AC-1</b>														
AC / DC operated			■	■	■	■	■	■	■	■	■	■	■	■
AF09, AF16, AF26, AF38			E319322											
AC / DC operated			■	■	■	■	■	■	■	■	■	■	■	■
AF40, AF52, AF80			E312527											
<b>160 to 525 A, AC-1</b>														
AC / DC operated			■	■	■	■	■	■	■	■	■	■	■	■
AF116, AF140, AF190, AF205, AF265, AF305, AF370			E73397				(1)							
<b>800 to 1000 A AC-1</b>														
AC operated			■	■	■	■	■	■	■	■	■	■	■	■
EK550			E36588											
AC operated			■	■	■	■	■	■	■	■	■	■	■	■
EK1000														
DC operated			■	■	■	■	■	■	■	■	■	■	■	■
EK550			E36588											
DC operated			■	■	■	■	■	■	■	■	■	■	■	■
EK1000														

(1) AF116 ... AF265 only. KC only applicable to devices up to 300 A. (2) Marine approvals for AF116 ... AF370 with built-in PLC interface: only DNV is available. All AF contactors are  (RCM) marked.

# Certifications and approvals













Mark	Certifications						Approvals: ship classification societies							
	 CSA Canada	 UL USA	 cULus North America	 CCC China	 GOST or EAC Russia	 KC Korea	 BV France	 DNV-GL	 LR Gr.Britain	 RINa Italy	 ABS USA	 RMRS Russia	 CCS China shipping	 ClassNK Japan
<b>DC switching contactors</b>														
AC operated GA75	■	■		■										
DC operated GAE75	■	■		■										
AC / DC operated GAF185 ... GAF300			■	■										
AC / DC operated GAF460, GAF750, GAF1250, GAF1650, GAF2050			■	■										
<b>Capacitor switching contactors</b>														
AC operated UA16		■		■	■									
AC operated UA26 ... UA75	■	■		■	■									
AC operated UA95, UA110			■	■	■									
AC operated UA16..RA		■		■	■									
AC operated UA26..RA ... UA75..RA	■	■		■	■									
AC operated UA95..RA, UA110..RA			■	■	■									
<b>Contactor relays with screw terminals</b>														
AC operated 4-pole, 8-pole - NS..			■	■										
DC operated 4-pole, 8- pole - NSL..			■	■										
AC / DC operated 4-pole, 8-pole - NF..			■	■	■		■	■	■	■	■			
All GAF and NF contactors are  (RCM) marked.														
<b>3-pole contactors with spring terminals</b>														
<b>4 to 7.5 KW</b>														
AC operated AS09..S, AS12..S, AS16..S			■	■										
DC operated ASL09..S, ASL12..S, ASL16..S			■	■										
<b>4 to 11 KW</b>														
AC / DC operated AF09..S AF12..S, AF16..S			■	■	■		■	■	■	■	■			■
AF26..S				■	■		■	■	■	■	■			■
<b>Contactor relays with spring terminals</b>														
AC operated 4-pole, 8-pole - NS..			■	■										
DC operated 4-pole, 8- pole - NSL..			■	■										
AC / DC operated 4-pole, 8-pole - NFS..			■	■	■		■	■	■	■	■			

# Certifications and approvals

Mark	Certifications					Approvals: ship classification societies							
	 CSA Canada	 UL USA	 cULus North America	 CCC China	 PGT EAC GOST or EAC Russia	 BV France	 DNV-GL	 Lloyd's Register LR Gr.Britain	 RINa Italy	 ABS USA	 RMRS Russia	 CCS China shipping	 ClassNK Japan
<b>Accessories for AS09 ... AS16 contactors</b>													
<b>Auxiliary contacts</b>													
CA3			<input checked="" type="checkbox"/>	<input checked="" type="checkbox"/>	<input checked="" type="checkbox"/>								
CA3..S			<input checked="" type="checkbox"/> E252354	<input checked="" type="checkbox"/>									
<b>Mechanical interlock unit</b>													
VM3			<input checked="" type="checkbox"/> E312527		<input checked="" type="checkbox"/>	<input type="checkbox"/>	<input type="checkbox"/>	<input type="checkbox"/>	<input type="checkbox"/>	<input type="checkbox"/>	<input type="checkbox"/>	<input type="checkbox"/>	<input type="checkbox"/>
<b>Connecting links</b>													
BEA16-3			<input checked="" type="checkbox"/> E312527		<input checked="" type="checkbox"/>	<input type="checkbox"/>	<input type="checkbox"/>	<input type="checkbox"/>	<input type="checkbox"/>	<input type="checkbox"/>	<input type="checkbox"/>	<input type="checkbox"/>	<input type="checkbox"/>
BEA16-3U			<input checked="" type="checkbox"/> E312527		<input checked="" type="checkbox"/>	<input type="checkbox"/>	<input type="checkbox"/>	<input type="checkbox"/>	<input type="checkbox"/>	<input type="checkbox"/>	<input type="checkbox"/>	<input type="checkbox"/>	<input type="checkbox"/>
BER16C-3			<input checked="" type="checkbox"/> E312527		<input checked="" type="checkbox"/>	<input type="checkbox"/>	<input type="checkbox"/>	<input type="checkbox"/>	<input type="checkbox"/>	<input type="checkbox"/>	<input type="checkbox"/>	<input type="checkbox"/>	<input type="checkbox"/>
BEY16C-3			<input checked="" type="checkbox"/> E312527		<input checked="" type="checkbox"/>	<input type="checkbox"/>	<input type="checkbox"/>	<input type="checkbox"/>	<input type="checkbox"/>	<input type="checkbox"/>	<input type="checkbox"/>	<input type="checkbox"/>	<input type="checkbox"/>
<b>Electronic timer</b>													
TEF3			<input checked="" type="checkbox"/> E252354		<input checked="" type="checkbox"/>								
<b>Surge suppressors</b>													
RT5, RC5-1, RV5			<input checked="" type="checkbox"/> E312527		<input checked="" type="checkbox"/>								
<b>Accessories for AF09 ... AF2650 and EK contactors and NF contactor relays</b>													
<b>Auxiliary contacts</b>													
CA4, CC4			<input checked="" type="checkbox"/> E252354	<input checked="" type="checkbox"/>	<input checked="" type="checkbox"/>	<input checked="" type="checkbox"/> (CA4)	<input checked="" type="checkbox"/> (CA4)	<input checked="" type="checkbox"/>	<input checked="" type="checkbox"/>	<input checked="" type="checkbox"/>	<input checked="" type="checkbox"/>		<input type="checkbox"/>
CAT4			<input checked="" type="checkbox"/> E252354	<input checked="" type="checkbox"/>	<input checked="" type="checkbox"/>	<input checked="" type="checkbox"/>	<input checked="" type="checkbox"/>	<input checked="" type="checkbox"/>	<input checked="" type="checkbox"/>	<input checked="" type="checkbox"/>	<input checked="" type="checkbox"/>		<input type="checkbox"/>
CAL4			<input checked="" type="checkbox"/> E252354	<input checked="" type="checkbox"/>	<input checked="" type="checkbox"/>	<input checked="" type="checkbox"/>	<input checked="" type="checkbox"/>	<input checked="" type="checkbox"/>	<input checked="" type="checkbox"/>	<input checked="" type="checkbox"/>	<input checked="" type="checkbox"/>		<input type="checkbox"/>
CAL19			<input checked="" type="checkbox"/> E76003	<input checked="" type="checkbox"/>	<input checked="" type="checkbox"/>	<input checked="" type="checkbox"/>	<input checked="" type="checkbox"/>	<input checked="" type="checkbox"/>	<input checked="" type="checkbox"/>	<input checked="" type="checkbox"/>		<input checked="" type="checkbox"/>	<input type="checkbox"/>
CAL18			<input checked="" type="checkbox"/> E76003	<input checked="" type="checkbox"/>	<input checked="" type="checkbox"/>	<input checked="" type="checkbox"/>	<input checked="" type="checkbox"/>	<input checked="" type="checkbox"/>	<input checked="" type="checkbox"/>	<input checked="" type="checkbox"/>		<input checked="" type="checkbox"/>	<input type="checkbox"/>
CAL16			<input checked="" type="checkbox"/> E76003	<input checked="" type="checkbox"/>	<input checked="" type="checkbox"/>								
CE5...D0.1			<input checked="" type="checkbox"/> E319322	<input checked="" type="checkbox"/>	<input checked="" type="checkbox"/>								
CE5...D2			<input checked="" type="checkbox"/> E319322	<input checked="" type="checkbox"/>	<input checked="" type="checkbox"/>								
CE5...W0.1			<input checked="" type="checkbox"/> E319322	<input checked="" type="checkbox"/>	<input checked="" type="checkbox"/>								
CE5...W2			<input checked="" type="checkbox"/> E319322	<input checked="" type="checkbox"/>	<input checked="" type="checkbox"/>								
CEL18			<input checked="" type="checkbox"/> E76003	<input checked="" type="checkbox"/>	<input checked="" type="checkbox"/>								
CA4..S, CAL4..S, CAT4..S			<input checked="" type="checkbox"/> E252354	<input checked="" type="checkbox"/>	<input checked="" type="checkbox"/>	<input checked="" type="checkbox"/>	<input checked="" type="checkbox"/>	<input checked="" type="checkbox"/>	<input checked="" type="checkbox"/>	<input checked="" type="checkbox"/>	<input checked="" type="checkbox"/>		
<b>Electronic timer</b>													
TEF4, TEF45			<input checked="" type="checkbox"/> E252354		<input checked="" type="checkbox"/>								
<b>Mechanical / electrical interlock unit</b>													
VEM4			<input checked="" type="checkbox"/> E312527	<input checked="" type="checkbox"/>	<input checked="" type="checkbox"/>								
<b>Mechanical interlock units</b>													
VM4, VM96-4			<input checked="" type="checkbox"/> E312527		<input checked="" type="checkbox"/>	<input type="checkbox"/>	<input type="checkbox"/>	<input type="checkbox"/>	<input type="checkbox"/>	<input type="checkbox"/>	<input type="checkbox"/>	<input type="checkbox"/>	<input type="checkbox"/>
VM19			<input checked="" type="checkbox"/> E36588		<input checked="" type="checkbox"/>	<input type="checkbox"/>	<input type="checkbox"/>	<input type="checkbox"/>	<input type="checkbox"/>	<input type="checkbox"/>	<input type="checkbox"/>	<input type="checkbox"/>	<input type="checkbox"/>
VM140/190			<input checked="" type="checkbox"/> E36588		<input checked="" type="checkbox"/>	<input type="checkbox"/>	<input type="checkbox"/>	<input type="checkbox"/>	<input type="checkbox"/>	<input type="checkbox"/>	<input type="checkbox"/>	<input type="checkbox"/>	<input type="checkbox"/>
VM205/265			<input checked="" type="checkbox"/> E36588		<input checked="" type="checkbox"/>	<input type="checkbox"/>	<input type="checkbox"/>	<input type="checkbox"/>	<input type="checkbox"/>	<input type="checkbox"/>	<input type="checkbox"/>	<input type="checkbox"/>	<input type="checkbox"/>
VM 750			<input checked="" type="checkbox"/> E36588		<input checked="" type="checkbox"/>	<input type="checkbox"/>	<input type="checkbox"/>	<input type="checkbox"/>	<input type="checkbox"/>	<input type="checkbox"/>	<input type="checkbox"/>	<input type="checkbox"/>	<input type="checkbox"/>
VM1650H			<input checked="" type="checkbox"/> E36588		<input checked="" type="checkbox"/>	<input type="checkbox"/>	<input type="checkbox"/>	<input type="checkbox"/>	<input type="checkbox"/>	<input type="checkbox"/>	<input type="checkbox"/>	<input type="checkbox"/>	<input type="checkbox"/>
<b>Interface relay</b>													
RA4			<input checked="" type="checkbox"/> E252354		<input checked="" type="checkbox"/>								















Marine approvals not needed for this accessory.

# Certifications and approvals

Mark	Certifications					Approvals: ship classification societies							
	 CSA Canada	 UL USA	 cUL <sup>us</sup> North America	 CCC China	 PG EAC Russia	 BV France	 DNV-GL	 Lloyd's Register Gr.Britain	 RINA Italy	 ABS USA	 RMRS Russia	 CCS China shipping	 ClassNK Japan
<b>Latching unit</b>													
WB75-A		■ E252354			■								
WA4			■ E312527										
<b>Connecting links with manual motor starters</b>													
BEA16-4, BEA26-4, BEA38-4, BEA65-4			■ E312527		■					□	□	□	□
<b>Connection sets for reversing contactors</b>													
BER16-4, BER38-4			■ E312527		■					□	□	□	□
BER65-4, BER96-4			■ E312527		■					□	□	□	□
BER140-4, BER205-4, BER370-4			■ E36588		■					□	□	□	□
BEM460-30, BEM750-30			■ E36588		■					□	□	□	□
<b>Connection sets for star-delta starters</b>													
BEY16-4, BEY38-4			■ E312527		■					□	□	□	□
BEY65-4, BEY96-4			■ E312527		■					□	□	□	□
BEY190-4, BEY205-4, BEY265-4, BEY370-4			■ E36588		■					□	□	□	□
BED460, BED580, BED750			■ E36588		■					□	□	□	□
<b>Phase to phase connections</b>													
BEP140-30, BEP205-30, BEP370-30			■ E36588		■					□	□	□	□
BEP140-40, BEP205-40, BEP370-40					■					□	□	□	□
BES460, BES750			■ E36588		■					□	□	□	□
<b>Connection bars between contactors and MCCB</b>													
BEA140/XT2, BEA140/XT3			■ E36588		■					□	□	□	□
BEA205/XT4			■ E36588		■					□	□	□	□
BEA370/T5			■ E36588		■					□	□	□	□
<b>Terminal connecting strips and shorting bars</b>													
LY16-4, LY38-4			■ E312527		■					□	□	□	□
LY110, LY185, LY300, LY460, LY750			■ E36588		■					□	□	□	□
LP185, LP300, LP460, LP750			■ E36588		■					□	□	□	□
LH38-4			■ E312527		■					□	□	□	□
LF16-4, LF38-4			■ E312527		■					□	□	□	□
LG16-4			■ E312527		■					□	□	□	□
LK96-4B, LK96-4F, LK96-4L			■ E312527		■					□	□	□	□
<b>Additional coil terminal blocks</b>													
LD38-4			■ E312527		■					□	□	□	□
<b>Additional terminal blocks</b>													
LDC4			■ E312527		■					□	□	□	□
<b>Protective covers</b>													
BX4, BX4-CA			■ E252354		■					□	□	□	□
<b>Terminal shrouds</b>													
LT65-30 ... LT96-30			-							□	□	□	□
LT52-40 ... LT80-40			-							□	□	□	□
LT140 ... LT750			■ E36588		■					□	□	□	□
LT140-40 ... LT370-40			■ E73397		■					□	□	□	□
<b>Terminal enlargement</b>													
LW			■ E36588		■					□	□	□	□















(1) In progress. □ Marine approvals not needed for this accessory.

# Certifications and approvals

Mark	Certifications							Approvals: ship classification societies							
	 CSA Canada	 UL USA	 cULus North America	 CCC China	 GOST or EAC Russia	 ATEX	 IEC Ex	 KC Korea	 BV France	 DNV-GL	 LR Gr.Britain	 RINA Italy	 ABS USA	 RMRS Russia	 ClassNK Japan
<b>Terminal extension</b>															
LX			<input checked="" type="checkbox"/>		<input checked="" type="checkbox"/>	<input type="checkbox"/>			<input type="checkbox"/>	<input type="checkbox"/>	<input type="checkbox"/>	<input type="checkbox"/>	<input type="checkbox"/>	<input type="checkbox"/>	<input type="checkbox"/>
			E36588												
<b>Connection socket</b>															
LL			<input checked="" type="checkbox"/>		<input checked="" type="checkbox"/>	<input type="checkbox"/>			<input type="checkbox"/>	<input type="checkbox"/>	<input type="checkbox"/>	<input type="checkbox"/>	<input type="checkbox"/>	<input type="checkbox"/>	<input type="checkbox"/>
			E36588												
<b>Connection modules</b>															
LD146-30, LD146-40			<input checked="" type="checkbox"/>		<input checked="" type="checkbox"/>	<input type="checkbox"/>			<input type="checkbox"/>	<input type="checkbox"/>	<input type="checkbox"/>	<input type="checkbox"/>	<input type="checkbox"/>	<input type="checkbox"/>	<input type="checkbox"/>
			E36588												
<b>Function marker</b>															
BA4			<input checked="" type="checkbox"/>			<input type="checkbox"/>			<input type="checkbox"/>	<input type="checkbox"/>	<input type="checkbox"/>	<input type="checkbox"/>	<input type="checkbox"/>	<input type="checkbox"/>	<input type="checkbox"/>
			E252354												
<b>Fixing clip</b>															
BB4			<input checked="" type="checkbox"/>			<input type="checkbox"/>			<input type="checkbox"/>	<input type="checkbox"/>	<input type="checkbox"/>	<input type="checkbox"/>	<input type="checkbox"/>	<input type="checkbox"/>	<input type="checkbox"/>
			E312527												
<b>Manual motor starters</b>															
MS116			<input checked="" type="checkbox"/>	<input checked="" type="checkbox"/>	<input checked="" type="checkbox"/>				<input checked="" type="checkbox"/>	<input checked="" type="checkbox"/>	<input checked="" type="checkbox"/>	<input checked="" type="checkbox"/>	<input checked="" type="checkbox"/>	<input checked="" type="checkbox"/>	<input checked="" type="checkbox"/>
			E137861												
MS132			<input checked="" type="checkbox"/>	<input checked="" type="checkbox"/>	<input checked="" type="checkbox"/>		<input checked="" type="checkbox"/>	<input checked="" type="checkbox"/>	<input checked="" type="checkbox"/>	<input checked="" type="checkbox"/>	<input checked="" type="checkbox"/>	<input checked="" type="checkbox"/>	<input checked="" type="checkbox"/>	<input checked="" type="checkbox"/>	<input checked="" type="checkbox"/>
			E137861 E345003				(1)								
MS165			<input checked="" type="checkbox"/>	<input checked="" type="checkbox"/>	<input checked="" type="checkbox"/>		<input checked="" type="checkbox"/>	<input checked="" type="checkbox"/>	<input checked="" type="checkbox"/>	<input checked="" type="checkbox"/>	<input checked="" type="checkbox"/>	<input checked="" type="checkbox"/>	<input checked="" type="checkbox"/>	<input checked="" type="checkbox"/>	<input checked="" type="checkbox"/>
			E137861 E345003												
MS132-K			<input checked="" type="checkbox"/>	<input checked="" type="checkbox"/>	<input checked="" type="checkbox"/>		<input checked="" type="checkbox"/>	<input checked="" type="checkbox"/>	<input checked="" type="checkbox"/>	<input checked="" type="checkbox"/>	<input checked="" type="checkbox"/>	<input checked="" type="checkbox"/>	<input checked="" type="checkbox"/>	<input checked="" type="checkbox"/>	<input checked="" type="checkbox"/>
			E137861 E345003												
<b>Manual motor starters magnetic only</b>															
MO132			<input checked="" type="checkbox"/>	<input checked="" type="checkbox"/>	<input checked="" type="checkbox"/>				<input checked="" type="checkbox"/>	<input checked="" type="checkbox"/>	<input checked="" type="checkbox"/>	<input checked="" type="checkbox"/>	<input checked="" type="checkbox"/>	<input checked="" type="checkbox"/>	<input checked="" type="checkbox"/>
			E137861 E345003												
MO165			<input checked="" type="checkbox"/>	<input checked="" type="checkbox"/>	<input checked="" type="checkbox"/>				<input checked="" type="checkbox"/>	<input checked="" type="checkbox"/>	<input checked="" type="checkbox"/>	<input checked="" type="checkbox"/>	<input checked="" type="checkbox"/>	<input checked="" type="checkbox"/>	<input checked="" type="checkbox"/>
			E137861 E345003												
<b>Circuit breaker for transformer protection</b>															
MS132-T			<input checked="" type="checkbox"/>	<input checked="" type="checkbox"/>	<input checked="" type="checkbox"/>				<input checked="" type="checkbox"/>	<input checked="" type="checkbox"/>	<input checked="" type="checkbox"/>	<input checked="" type="checkbox"/>	<input checked="" type="checkbox"/>	<input checked="" type="checkbox"/>	<input checked="" type="checkbox"/>
			E137861												
MS132-KT			<input checked="" type="checkbox"/>	<input checked="" type="checkbox"/>	<input checked="" type="checkbox"/>				<input checked="" type="checkbox"/>	<input checked="" type="checkbox"/>	<input checked="" type="checkbox"/>	<input checked="" type="checkbox"/>	<input checked="" type="checkbox"/>	<input checked="" type="checkbox"/>	<input checked="" type="checkbox"/>
			E137864												
<b>Mini contactors</b>															
<b>3-pole contactors</b>															
AC operated B6, B7			<input checked="" type="checkbox"/>	<input checked="" type="checkbox"/>	<input checked="" type="checkbox"/>				<input checked="" type="checkbox"/>	<input checked="" type="checkbox"/>	<input checked="" type="checkbox"/>	<input checked="" type="checkbox"/>	<input checked="" type="checkbox"/>	<input checked="" type="checkbox"/>	<input checked="" type="checkbox"/>
			E191658												
DC operated BC6, BC7, B7D			<input checked="" type="checkbox"/>	<input checked="" type="checkbox"/>	<input checked="" type="checkbox"/>				<input checked="" type="checkbox"/>	<input checked="" type="checkbox"/>	<input checked="" type="checkbox"/>	<input checked="" type="checkbox"/>	<input checked="" type="checkbox"/>	<input checked="" type="checkbox"/>	<input checked="" type="checkbox"/>
			E191658												
DC operated B6S, B7S			<input checked="" type="checkbox"/>	<input checked="" type="checkbox"/>	<input checked="" type="checkbox"/>				<input checked="" type="checkbox"/>	<input checked="" type="checkbox"/>	<input checked="" type="checkbox"/>	<input checked="" type="checkbox"/>	<input checked="" type="checkbox"/>	<input checked="" type="checkbox"/>	<input checked="" type="checkbox"/>
			E191658												
<b>3-pole reversing contactors</b>															
AC operated VB6, VB7			<input checked="" type="checkbox"/>	<input checked="" type="checkbox"/>	<input checked="" type="checkbox"/>				<input checked="" type="checkbox"/>	<input checked="" type="checkbox"/>	<input checked="" type="checkbox"/>	<input checked="" type="checkbox"/>	<input checked="" type="checkbox"/>	<input checked="" type="checkbox"/>	<input checked="" type="checkbox"/>
			E191658												
DC operated VBC6, VBC7			<input checked="" type="checkbox"/>	<input checked="" type="checkbox"/>	<input checked="" type="checkbox"/>				<input checked="" type="checkbox"/>	<input checked="" type="checkbox"/>	<input checked="" type="checkbox"/>	<input checked="" type="checkbox"/>	<input checked="" type="checkbox"/>	<input checked="" type="checkbox"/>	<input checked="" type="checkbox"/>
			E191658												
AC operated VB6A, VB7A			<input checked="" type="checkbox"/>	<input checked="" type="checkbox"/>	<input checked="" type="checkbox"/>				<input checked="" type="checkbox"/>	<input checked="" type="checkbox"/>	<input checked="" type="checkbox"/>	<input checked="" type="checkbox"/>	<input checked="" type="checkbox"/>	<input checked="" type="checkbox"/>	<input checked="" type="checkbox"/>
			E191658												
DC operated VBC6A, VBC7A			<input checked="" type="checkbox"/>	<input checked="" type="checkbox"/>	<input checked="" type="checkbox"/>				<input checked="" type="checkbox"/>	<input checked="" type="checkbox"/>	<input checked="" type="checkbox"/>	<input checked="" type="checkbox"/>	<input checked="" type="checkbox"/>	<input checked="" type="checkbox"/>	<input checked="" type="checkbox"/>
			E191658												
<b>3-pole interface contactors</b>															
DC operated BC6, BC7			<input checked="" type="checkbox"/>	<input checked="" type="checkbox"/>	<input checked="" type="checkbox"/>				<input checked="" type="checkbox"/>	<input checked="" type="checkbox"/>	<input checked="" type="checkbox"/>	<input checked="" type="checkbox"/>	<input checked="" type="checkbox"/>	<input checked="" type="checkbox"/>	<input checked="" type="checkbox"/>
			E191658												
<b>3-pole contactor - large coil voltage range</b>															
DC operated TBC7			<input checked="" type="checkbox"/>	<input checked="" type="checkbox"/>	<input checked="" type="checkbox"/>				<input checked="" type="checkbox"/>	<input checked="" type="checkbox"/>	<input checked="" type="checkbox"/>	<input checked="" type="checkbox"/>	<input checked="" type="checkbox"/>	<input checked="" type="checkbox"/>	<input checked="" type="checkbox"/>

(1) Valid for production date week 47, 2018.  Marine approvals not needed for this accessory.

## Certifications and approvals

Mark	Certifications							Approvals: ship classification societies							
	 CSA Canada	 UL USA	 cULus North America	 CCC China	 GOST or EAC Russia	 ATEX	 IEC Ex	 KC Korea	 BV France	 DNV-GL	 LR Gr.Britain	 RINa Italy	 ABS USA	 RMRS Russia	 ClassNK Japan
<b>4-pole contactors</b>															
AC operated			■	■	■		■	■	■	■				■	
B6, B7			E191658												
DC operated			■	■	■		■	■	■	■				■	
BC6, B7D			E191658												
<b>4-pole contactor - large coil voltage range</b>															
DC operated				■	■		■								
TBC7															
<b>Contactors relays</b>															
AC operated			■	■	■									■	
K6			E48139												
DC operated			■	■	■									■	
KC6			E48139												
<b>Interface contactor relays</b>															
DC operated			■	■	■									■	
KC6			E48139												
DC operated			■	■	■									■	
K6S			E48139												
<b>Contactors relays - large coil voltage range</b>															
DC operated				■	■										
TKC6															
<b>Thermal overload relays</b>															
T16			■	■	■				■	■	■	■	■	■	■
TF42			E48139				■		■	■	■	■	■	■	■
TF65			■	■	■			■	■	■	■	■	■	■	■
TF96			E48139					(3)	■	■	■	■	■	■	■
TF140DU			■	■	■			(3)	■	■	■	■	■	■	■
TF140DU-V1000			E48139						■	■	■	■	■	■	■
TA200DU			■	■	■				■	■	■	■	■	■	■
TA200DU-V1000			E48139							(4)	■	■	■	■	■
			E48139							(4)	■	■	■	■	■
<b>Electronic overload relays</b>															
<b>0.10...45 A</b>															
E16DU			■	■	■									■	
EF19			E48139						■	■	■	■	■	■	■
EF45			■	■	■				■	■	■	■	■	■	■
			E48139											(1)	
<b>20...150 A</b>															
EF65			■	■	■			■	■	■	■	■	■	■	■
EF96			E48139					(2)	■	■	(2)	■	■	■	■
EF146			■	■	■				■	■	■	■	■	■	■
			E48139											(1)	
<b>63...380 A</b>															
EF205			■	■	■			■	■	■	■	■	■	■	■
EF370			E48139						■	■	■	■	■	■	■
			E48139											(1)	
<b>150...1250 A</b>															
EF460			■	■	■			■	■	■	■	■	■	■	■
EF750			E48139						■	■	■	■	■	■	■
EF1250			■	■	■				■	■	■	■	■	■	■
			E76003											(1)	
<b>Electronic compact starter</b>															
HF range			■	■	■			■							
			E191658												

(1) IECEx is valid for product produced from week15, 2017. (2) EF65-56 has no RINa approval and ATEX certification is valid for EF65-56 produced from week 47, 2015. (3) ATEX is valid for products produced from week 26, 2015. All electronic overload relays are  (RCM) marked : EF produced from week 47, 2015; E produced from week 14, 2016. (4) 2 separate certificate available: 1 for DNV and 1 for GL.

## Coordination with short-circuit protection devices

### Definition

The coordination of control and protection devices in compliance with IEC 60947-4-1, EN 60947-4-1 and UL 60947-4-1 between the branch circuit protective device and the motor starter standards defines for the contactors and starters the type rating and characteristics of the short-circuit protection devices SCPD which allow selective protection against overloads and ensure protection against short circuits.

### Basic functions

Any starter is designed to:

- start motors,
- ensure continuous functioning of motors,
- disconnect motors from the supply line,
- guarantee protection of motors against overloads.

The starter is typically made up of a switching device (contactor) and an overload protection device (thermal overload relay or electronic overload relay).

These two devices MUST be coordinated with equipment capable of providing protection against short circuit (SCPD: short circuit protective device): typically a circuit breaker with magnetic release only or a switch fuse. These are not necessarily part of the starter.

### Applicable standards

IEC 60947-4-1 (EN 60947-4-1) and UL 60947-4-1 between the branch circuit protective device and the motor starter precisely defines the different points to be considered in order to carry out correct coordination.

Complete coordination for a combination includes the following points:

- Selectivity test between the overload relay and the short-circuit protection device SCPD.
- Short-circuit condition tests:
  - at prospective "r" currents - These currents depend on the rated operational current of the starter ( $I_e$  AC-3) and are given by the standard (Table 13). For example:
    - $r = 1\text{ kA}$  for  $I_e$  AC-3 < 16 A
    - $r = 3\text{ kA}$  for  $16\text{ A} < I_e$  AC-3 < 63 A
    - $r = 5\text{ kA}$  for  $63\text{ A} < I_e$  AC-3 < 125 A etc.
  - at the rated conditional short-circuit current "Iq" - This is the maximum prospective current that the combination can withstand, for example 50 kA.

### Types of coordination

IEC 60947-4-1 (EN 60947-4-1) UL 60947-4-1 between the branch circuit protective device and the motor starter defines two types of coordination according to the expected level of service continuity. Acceptable extreme damage for the switchgear is divided into two types.

- Type 1: In short-circuit conditions, the contactor or starter does not endanger persons or installations and will not be able to then operate without being repaired or having parts replaced.
- Type 2: In short-circuit conditions, the contactor or starter does not endanger persons or installations and will be able to operate afterwards. The risk of contacts light welding is acceptable. In this case, the manufacturer must stipulate the measures to be taken with respect to maintenance of the equipment.

# Coordination with short-circuit protection devices

A complete data base of coordination tables, according to IEC 60947-4-1 (EN 60947-4-1) or UL 508 / UL 60947-4-1, is available on the ABB Website: see below.

## Selection

Simple or multiple selections all from the same screen.

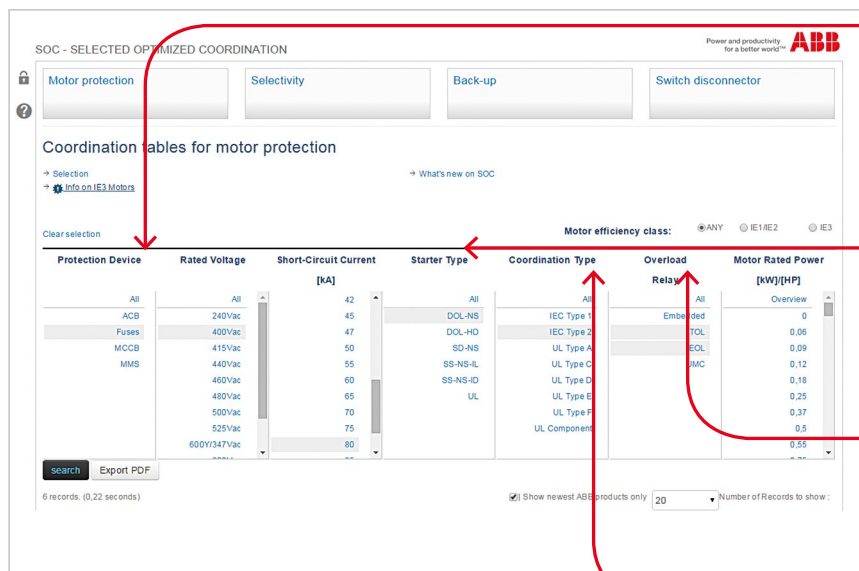

### Short-circuit protection devices

- Air circuit breakers
- Fuses "gG" or "aM"
- Miniature circuit breaker
- Moulded case circuit breaker
- Manual motor starter

### Starter type

- Direct-on-line normal start
- Direct-on-line heavy duty
- Star-delta normal start
- Soft starter normal start

### Overload relay

- TOL : thermal overload relay
- EOL : electronic overload relay
- UMC : Universal motor controller

### Coordination

- IEC type 1 or type 2
- UL type A to Type F

## Results

- Search results displayed at the bottom of the selection page.
- Only the most appropriate solutions to your application, will be displayed at the bottom of the page. "Enable Smart Current Search" function featured for the short-circuit current where "near to" selected values also are included in the result.
- Possible to print the page to a pdf file or from your printer.
- "Clear selection" function to deselect all selected.

Fuses, 400 Vac, 100 kA, DOL-NS, Coordination Type IEC Type 2, Overload Relay TOL, Motor efficiency class IE1 + IE2							
Motor		Fuses IEC			Contactor	Overload Relay	
Rated Power [kW]	Rated Current [A]	Switch-Fuse Type	Rating gG/aM [A]	Type and Size	Type	Current range [A]	Max allowed load current [A]
0,25	0,85	OS32GD_	2	OFAF 00daM	AF09	TF42-1,0	1,00
0,12	0,44	OS32GD_	2	OFAF 00DH	AF09	TF42-0,55	0,55

Fuses, 400 Vac, 100 kA, DOL-NS, Coordination Type IEC Type 2, Overload Relay EOL, Motor efficiency class IE3							
Motor		Fuses IEC			Contactor	Overload Relay	
Rated Power [kW]	Rated Current [A]	Switch-Fuse Type	Rating gG/aM [A]	Type and Size	Type	Current range [A]	Max allowed load current [A]
0,18	0,80	OS32GD_	2	OFAF 00daM	AF09	EF19-1,0 10 *	1,00
0,12	0,44	OS32GD_	2	OFAF 00DH	AF09	EF19-1,0 10 *	0,54
0,18	0,80	OS32GD_	2	OFAF 00daM	AF09	EF19-1,0 10 *	1,00



### Access

To find the coordination tables for motor protection, please see:  
<http://applications.it.abb.com/SOC/Page/Selection.aspx>



## Standards, specifications and certifying organizations

### Definitions

ABB low voltage devices are developed and manufactured in accordance with the applicable regulations as stated in the international IEC standards, the European EN standards and the national ones such as NF, DIN, GB and BS. For devices installed in ships, an approval issued by independent classification societies is demanded by the maritime insurance companies.

### CB scheme

Certification Body certificates (CB certificates) are available to prove the complete conformity to standards

The IEC CB (Certification Body) scheme is multilateral agreement between the National Certification Bodies to allow international certification of electrical and electronic products so that a single certification allows worldwide market access.

The CB Scheme was established by the International Electrotechnical Committee for conformity testing to standards for electrical equipment (IECEE).

### Certified products

In some cases, products are validated and tested according to a standard by a certification body and the manufacturer is regularly visited by this body in order to check the respect of the design and the materials used. This process creates a certified product. This is the case of UL (Underwriters Laboratories) and CSA (Canadian Standard Association) for instance (see below).

### Specifications

#### International Specifications

The International Electrotechnical Commission, IEC, which is part of the International Standards Organization, ISO, publishes IEC publications which act as a basis for the world market.

#### European Specifications and National Specifications

The European committee for electrotechnical standardization (CENELEC), which groups together European countries, publishes EN standards.

These European standards may differ very little from IEC international standards and have similar numbering.

The same applies for national standards which use, without exception, the same numbering and reproduce the texts of these unified standards in their entirety. Contradicting national standards are withdrawn.

#### European Directives

The guarantee of the free movement of goods within the European Community means that any regulatory differences between member states have been eliminated. The European directives set up common rules that are included in the legislation of each state while contradictory regulations are cancelled.

Three directives are essential:

- **Low Voltage Directive** 2006/95/EC (until April 2016, 19th) and 2014/35/EC (from April 2016, 20th) concerns electrical equipment from 0 to 1000 V AC and from 0 to 1500 V DC.

This specifies that compliance with the requirements that it sets out is acquired if the equipment conforms to the standards harmonized on an European level. EN 60947-1 and EN 60947-4-1 for contactors.

- **Machinery Directive** 2006/42/EC for safety specifications of machines and equipment on complete machines.

- **Electromagnetic Compatibility Directive** 2004/108/EC (until April 2016, 19th) and 2014/30/EC (from April 2016, 20th) which concerns all devices able to create electromagnetic disturbance.

#### CE Marking:

CE marking indicates that the marked equipment conforms to the relevant EU directive.

CE marking is part of an administrative procedure and guarantees free movement of the product within the European Community.

#### Standards in Canada and the USA

Canadian and American specifications are more or less equivalent but differ greatly from IEC standards.

**UL** Underwriters Laboratories USA

**CSA** Canadian Standard Association Canada

**UL (USA)** specifications make the following distinction between devices:



#### Listed Product

A product that has been produced under UL's listing and follow-up service program in accordance with the terms of UL's service agreement and that bears the UL listing mark as the manufacturer's declaration that the product complies with UL's requirements.



#### Recognized Component

A part or subassembly covered under UL's recognition service and intended for factory installation in listed (or other) products. Recognized components are incomplete in certain construction features or restricted in performance capabilities and not intended for separate installation in the field, rather they are intended for use as components of incomplete equipment submitted for investigation by UL. Final acceptance of the component in the complete equipment is dependent upon its installation and use in accordance with all applicable use conditions and ratings noted in the component report issued by UL, in the guide information and in the individual client's Recognized Component information page.

The combined UL signs for the USA and Canada are recognized by the authorities of both countries.

**Compulsory China Certification (CCC):** The CCC mark is a compulsory certification mark in the field of safety for products sold on the Chinese market.

**GOST / EAC:** Russia (please consult your local ABB sales office)

**C-Tick:** The C-Tick mark certifies compliance with the Australian EMC requirements. The mark is also recognized in New Zealand

**ANCE:** Mexico

#### Marine Approvals

The following specifications must be respected when these devices are used on ships:

**BV** Bureau Veritas France

**DNV** Det Norske Veritas Norway

**GL** Germanischer Lloyd Germany

## Standards, specifications and certifying organizations

<b>LRS</b>	Lloyd's Register of Shipping Great Britain
<b>ABS</b>	America Bureau of Shipping
<b>RMRS</b>	Russian Maritime Register of Shipping RMRS
<b>RRR</b>	Russian River Register
<b>MRS</b>	Maritime Register of Shipping Russia
<b>PRS</b>	Polski Rejestr Statkow Poland
<b>RINA</b>	Registro Italiano Navale Italy

### Specifications (cont.)

#### International Standards

IEC 60947-1 Low-voltage switchgear and controlgear – Part 1: General rules

IEC 60947-4-1 Low-voltage switchgear and controlgear – Part 4: Contactors and motor starters – Section 1: Electromechanical contactors and motor starters

IEC 60947-5-1 Low-voltage switchgear and controlgear – Part 5: Control circuit devices and switching elements – Section 1: Electromechanical control circuit devices

IEC 60947-5-4 Low-voltage switchgear and controlgear – Part 5-4: Control circuit devices and switching elements. Method of assessing the performance of low-energy contacts. Special tests

IEC 60947-6-1 Low-voltage switchgear and controlgear – Part 6: Multiple function equipment – Section 1: Automatic transfer switching equipment

IEC 60204-1 Electrical equipment of industrial machines – Part 1: General requirements

IEC 60715 Dimensions of low-voltage switchgear and controlgear. Standardized mounting on rails for mechanical support of electrical devices in switchgear and controlgear installations

#### European Standards

EN 50 005 Low-voltage switchgear and controlgear for industrial use – Terminal marking and distinctive number: General rules

(Annex L of IEC 60947-1).

EN 50 011 Low-voltage switchgear and controlgear for industrial use – Terminal marking, distinctive number and distinctive letter for particular contactor relays (Annex M of IEC 60947-5-1)

EN 60947-1 Low-voltage switchgear and controlgear – Part 1: General rules.

EN 60947-4-1 Low-voltage switchgear and controlgear – Part 4: Contactors and motor starters – Section 1: Electromechanical contactors and motor starters.

EN 60947-5-1 Low-voltage switchgear and controlgear – Part 5: Control circuit devices and switching elements – Section 1: Electromechanical control circuit devices.

EN 60947-5-4 Low-voltage switchgear and controlgear – Part 5-4: Control circuit devices and switching elements. Method of assessing the performance of low-energy contacts. Special tests.

EN 60947-6-1 Low-voltage switchgear and controlgear – Part 6: Multiple function equipment – Section 1: Automatic transfer switching equipment.

EN 60204-1 Electrical equipment of industrial machines – Part 1: General requirements.

EN 60 715 Dimensions of low-voltage switchgear and controlgear. Standardized mounting on rails for mechanical support of electrical devices in switchgear and controlgear installations.

#### National Standards

European countries national standards reproduce the corresponding EN... standards. Codification is built by addition of a prefix to EN numbering.

For instance:

- France **NF** EN...
- Germany **DIN** EN...
- Great Britain **BS** EN...
- Italy **CEI** EN...
- Sweden **SS** EN...

## Terms and technical definitions

### Circuits

- auxiliary circuit: All the conductive parts of a contactor designed to be inserted in a different circuit from the main circuit and the contactor control circuits.
- control circuit: All the conductive parts of a contactor (other than the main circuit and the auxiliary circuit) used to control the contactor's closing operation or opening operation or both.
- main circuit: All the conductive parts of a contactor designed to be inserted in the circuit that it controls.

### Thermal overload relay tripping classes

IEC 60947-4-1 defines tripping classes 10 A, 10, 20 and 30. Types 10 A, 10, etc. correspond to the maximum tripping time for a making current at 7.2 times the setting current.

Furthermore, for each class the standard specifies the tripping time for 1.5 times the setting current and sets the non tripping condition at 1.05 times the setting current.

All these data are summarized in the table below.

#### Extract from IEC 60947-4-1:

Tripping class	10 A	10	20	30
Max. tripping time for 1.5 times the setting current (warm state)	s 120	240	480	720
Tripping time for 7.2 times the setting current (cold state)	s 2 - 10	4 - 10	6 - 20	9 - 30
For 1.05 times the setting current	No tripping			

### Electromagnetic compatibility

AF... contactors comply with IEC 60947-1, 60947-4-1 and EN 60947-1, 60947-4-1 standards.

Definitions:

Environment A: "Mainly relates to low-voltage non public or industrial networks/locations/installations (EN 50082-2 article 4) including highly disturbing sources".

Environment B: "Mainly relates to low-voltage public networks (EN 50082-1 article 5) such as residential, commercial and light industrial locations/installations. Highly disturbing sources such as arc welders are not covered by this environment".

Notice for AF09...AF2650 contactors:

- AF09 ... AF38 contactors and NF contactor relays (produced since week 08-2013), AF40 ... AF96 contactors have been designed for environment B.
- AF09 ... AF38-...-12 contactors and NF..E-12 contactor relays (48...130 V 50/60 Hz-DC), AF116 ... AF2650 contactors: these products have been designed for environment A. Use of this product in environment B may cause unwanted electromagnetic disturbances in which case the user may be required to take adequate mitigation measures.

Note: for 48...130 V 50/60 Hz-DC in environment B, AF09Z ... AF38Z-...-22 contactor or NFZ...E-22 contactor relays can be selected.

### Definitions according to SEMI F47-0706

SEMI F47-0706 defines the voltage sag immunity required for semiconductor processing, metrology and automated test equipment, and on subsystems and components which are used in the construction of semiconductor processing equipment including but not limited to:

- Power supplies
- Generators
- Robots and factory interface
- Chillers, pumps, blowers

- AC operated contactors and contactor relays...

**voltage sag:** an rms reduction in the AC voltage, at the power frequency, for durations from a half cycle to a few seconds.

The IEC terminology for this phenomenon is voltage dip.

**voltage sag immunity:** the ability of equipment to withstand momentary electrical power interruptions or sags.

### Coordination of protections against short circuit

The goal here is to protect electromechanical starters and soft-starters.

Any starter is designed to:

- start motors,
- ensure continuous functioning of motors,
- disconnect motors from the supply line,
- guarantee protection of motors against overloads.

The starter is typically made up of a switching device (contactor) and an overload protection device (thermal overload relay or electronic overload relay). These two devices MUST be coordinated with equipment capable of providing protection against short circuit (SCPD: short circuit protective device): typically a circuit breaker with magnetic release only or a switch fuse. These are not necessarily part of the starter.

The characteristics of the starter must comply with the international standard IEC 60947-4-1 which defines the above items as follows:

**contactor:** a mechanical switching device having only one position of rest, operated otherwise than by hand, capable of making, carrying and breaking currents under normal circuit conditions including overload conditions.

**overload release:** overload relay or release which operates in the case of overload and also in case of loss of phase.

**circuit-breaker:** defined by IEC 60947-2 as a mechanical switching device, capable of making, carrying and breaking currents under normal circuit conditions and also making, carrying for a specified time and breaking currents under specified abnormal circuit conditions.

IEC publication 60947-4-1 defines coordination types "1" and "2":

- Type "1" coordination requires that, in the event of a short-circuit, the contactor or starter does not endanger persons or installations and will not then be able to operate without being repaired or parts being replaced.
- Type "2" coordination requires that, in short-circuit conditions, the contactor or starter does not endanger persons or installations and will be able to operate afterwards. The risk of contacts being light welded is acceptable. In this case, the manufacturer must stipulate the measures to be taken with respect to maintenance of the equipment.

### Rated operational current I<sub>e</sub>.

Current rated by the manufacturer. It is mainly based on the rated operational voltage U<sub>e</sub>, the rated frequency, the utilization category, the rated duty and the type of protective enclosure, if necessary.

### Conventional free air thermal current I<sub>th</sub>

Current that the contactor can withstand in free air for a duty time of 8 hours without the temperature rise of its various parts exceeding the maximum values given by the standard.

### Operating cycle or cycle

Includes one making operation and one breaking operation.

## Terms and technical definitions

### Cycle time

This is the sum of the current flow time and the no-current time for given cycle.

### Electrical durability

Number of on-load operating cycles that the contactor is able to carry out. It depends on the operational current, the operational voltage and the utilization category.

### Mechanical durability

Number of no-current operating cycles that a contactor is able to carry out.

### Assessed failure rate

Defined according to IEC 60947-5-4. This rate is given in standard industrial environments for the contactor relays and for the built-in auxiliary contact of contactors.

### Load factor

Ratio of the on-load operating time to the total cycle time x 100.

### Switching frequency

Number of switching cycles per hour.

### Plugging

Stopping or fast reversal in rotation direction of a motor by two supply leads being interchanged while the motor is running.

### Inching

Energization of a motor's circuit repeatedly or for short periods with the aim of obtaining small movements of the driven mechanism.

### Coil operating limits

Expressed in multiples of the nominal control circuit voltage  $U_c$  for the upper and lower limits.

### Mounting position

Comply with the manufacturer's instructions. Restrictions are to be taken into account for certain mounting positions.

### Rated breaking or making capacity

Root mean square (r.m.s.) value of the current that the contactor is able to break or make at a given voltage according to the conditions specified by standards and for a given utilization category.

### Intermittent duty

Duty during which the contactor is successively closed or open for periods which are too short to enable the contactor to achieve thermal balance.

### Ambient temperature

Air temperature close to the contactor.

### Time

- Time constant: Ratio of the inductance to the resistance ( $L/R = \text{mH}/\Omega = \text{ms}$ ).
- Short-time withstand current: Current that the contactor is

able to withstand in closed position for a short time interval and in specified conditions.

- Closing time: Time interval between the coil energization and the instant the contacts touch on all the poles.
- Opening time: Time interval between the coil de-energization and the instant the contacts separate on all the poles.

### Rated control voltage $U_c$

Control voltage value for which the control circuit is sized.

### Rated operational voltage $U_e$

Voltage to which the contactor's utilization characteristics refer. In three-phase it is the phase-to-phase voltage.

### Rated insulation voltage $U_i$

Reference voltage for dielectric tests and creepage distances.

### Rated impulse withstand voltage $U_{imp}$

Peak value of an impulse voltage, having a specified form and polarity, which does not cause breakdown in specific test conditions.

### Shock withstand

Requirement for vehicles, crane drives, installations on board ships and plug-in equipment. For the acceptable "g" values, the contacts must not change position and the thermal overload relays must not trip.

### Resistance to vibrations

Requirements for vehicles, boats and other means of transport. For the specified vibration amplitude and frequency values the device must remain able to operate.

### Mirror contacts



Definitions of mirror contact acc. to IEC 60947-4-1, Annex F 2.1. Normally closed auxiliary contact (N.C.) which cannot be in the closed position simultaneously with the normally open (N.O.) main contact.

### Mechanically linked contact



Definitions of mechanically linked elements acc. to IEC 60947-5-1, Annex L.

Combination of "n" Make auxiliary contact element(s) and "m" Break auxiliary contact element(s) are designed in such a way that they cannot be in the closed position simultaneously. One control circuit device may have more than one group of mechanically linked contact elements.

## Standards and utilization categories

### Utilization categories:

A contactor's duty is characterised by the utilization category together with the rated operational voltage and current indicated.

#### Utilization categories for contactors according to IEC 60947-4-1:

Alternating current:	AC-1	Non-inductive or slightly inductive loads, resistance furnaces.
	AC-2	Slip-ring motors: starting, switching off.
	AC-3	Cage motors: starting, switching off running motors.
	AC-4	Cage motors: starting, plugging, inching.
	AC-5a	Discharge lamp switching.
	AC-5b	Incandescent lamp switching.
	AC-6a	Transformer switching.
	AC-6b	Capacitor bank switching.
	AC-8a	Hermetic refrigeration compressor motor control with manual resetting of overload releases.
AC-8b	Hermetic refrigeration compressor motor control with automatic resetting of overload releases.	
Direct current:	DC-1	Non inductive or slightly inductive loads, resistance furnaces.
	DC-3	Shunt motors: starting, plugging, inching, dynamic breaking of DC motors.
	DC-5	Series motors: starting, plugging, inching, dynamic breaking of DC motors.
	DC-6	Incandescent lamp switching.

#### Utilization categories for contactor relays according to IEC 60947-5-1:

Alternating current:	AC-12	Control of resistive loads and static loads with opto-coupler isolation.
	AC-13	Control of static loads with transformer isolation.
	AC-14	Control of weak electromagnetic loads ( $\leq 72$ VA).
	AC-15	Control of electromagnetic loads ( $> 72$ VA).
Direct current:	DC-12	Control of resistive loads and static loads with opto-coupler isolation.
	DC-13	Control of DC electromagnets.
	DC-14	Control of DC electromagnets having economy resistors.

In fact some applications, and the specific criteria characterizing the various loads controlled by contactors, may modify the utilization characteristics of the contactors. The main applications concerned are:

#### Capacitor bank switching

Account must be taken of high peaks when the current is made and of harmonic currents during continuous duty. For this application, IEC publication 60947-4-1 stipulates utilization category AC-6b. The operational currents or powers acceptable for the contactors are determined by our electrical tests; IEC publication 60947-4-1 gives the calculating formula for determining the operational current (Table 9).

#### Transformer switching

Account must be taken of the peaks due to magnetization phenomena when the current is made.

For this application, IEC publication 60947-4-1 stipulates utilization category AC-6a. The operational currents or powers acceptable for the contactors are determined using the values obtained for AC-3 or AC-4 category tests and the calculating formula given in IEC 60947-4-1 (Table 9).

#### Lighting circuit switching

The current peaks occurring on energization of the circuit and the power factor depend on the type of lamps, the connection mode and whether or not there is compensation.

For this application, IEC publication 60947-4-1 stipulates two standard utilization categories:

AC-5a for discharge lamp switching.

AC-5b for incandescent lamp switching.

#### Slip-ring motor switching

The contactors used for short-circuiting rotor resistors can be used for rotor voltages up to 2 times the rated operational voltage.

The conditions of use of rotor contactors depend on the connection mode of the main poles. IEC 60947-4-1 stipulates AC-2 utilization category for startor contactor.

## Standards and utilization categories

### Utilization categories (cont.)

#### DC power circuit switching

Arc suppression is more difficult in direct current than in alternating current. Higher the time constant and voltage, heavier the breaking conditions: consequently several poles have to be connected in series.

#### AC high current circuit switching

Possibility of increasing performances by connecting poles in parallel.

#### Circuit switching during temporary and intermittent duty

In these cases higher operational currents are acceptable.

#### Influence of the length of the conductors used in the contactor control circuit

According to the operational voltages, the cross-sectional areas, the coil consumption and the control layout, difficulties due to line resistances and capacitances may appear during contactor closing and opening orders.

### Making and breaking conditions for utilization categories

Utilization category	Durability test conditions						Occasional operation					
	Making conditions			Breaking conditions			Making and breaking capacities - 50 operating cycles					
	I/le	U/Ur	Cos. $\phi$ or L/R (ms)	I/le	U/Ur	Cos. $\phi$ or L/R (ms)	Making conditions			Breaking conditions		
						Ic/le	Ur/Ur	Cos. $\phi$ or L/R (ms)	Ic/le	Ur/Ur	Cos. $\phi$ or L/R (ms)	

#### Contactors for AC circuit switching

AC-1		1	1	0.95	1	1	0.95	1.5	1.05	0.8	1.5	1.05	0.8
AC-2		2.5	1	0.65	2.5	1	0.65	4	1.05	0.65	4	1.05	0.65
AC-3	le < 17 A	6	1	0.65	1	0.17	0.65	10	1.05	0.45	8	1.05	0.45
	17 < le < 100 A	6	1	0.35	1	0.17	0.35	10	1.05	0.45	8	1.05	0.45
	le > 100 A	6	1	0.35	1	0.17	0.35	10	1.05	0.35	8	1.05	0.35
AC-4	le < 17 A	6	1	0.65	6	1	0.65	12	1.05	0.45	10	1.05	0.45
	17 < le < 100 A	6	1	0.35	6	1	0.35	12	1.05	0.45	10	1.05	0.45
	le > 100 A	6	1	0.35	6	1	0.35	12	1.05	0.35	10	1.05	0.35

#### Contactors for DC circuit switching

DC-1		1	1	1	1	1	1	1.5	1.05	1	1.5	1.05	1
DC-3		2.5	1	2	2.5	1	2	4	1.05	2.5	4	1.05	2.5
DC-5		2.5	1	7.5	2.5	1	7.5	4	1.05	15	4	1.05	15

#### Contactor relays for AC circuit switching

AC-14	( $\leq 72$ VA)	-	-	-	-	-	-	6	1.1	0.7	6	1.1	0.7
AC-15	(> 72 VA)	10	1	0.7	1	1	0.4	10	1.1	0.3	10	1.1	0.3

#### Contactor relays for DC circuit switching

Utilization category	Standard operation						Occasional operation						
	Making conditions			Breaking conditions			Making and breaking capacities - 50 operating cycles						
	I/le	U/Ur	T0.95	I/le	U/Ur	T0.95	Making conditions			Breaking conditions			
						Ic/le	Ur/Ur	T0.95	Ic/le	Ur/Ur	T0.95		
DC-13		1	1	6 P(1)	1	1	6 P(1)	1.1	1.1	6 P(1)	1.1	1.1	6 P(1)
DC-14		-	-	-	-	-	-	10	1.1	15 ms	10	1.1	15 ms

(1) The value "6 x P" is the result of an empirical relation which is estimated to represent most DC magnetic loads up to the highest limit of P = 50 W (6 x P = 300 ms). It is accepted that loads having drawn energy above 50 W are made up of weaker loads in parallel. As a consequence, the 300 ms value must form the highest limit whatever the value of the power drawn.

#### Key:

**U (I)** = applied voltage (current)

**Ur** = recovery voltage

**L/R** = test circuit time constant

**Ue (Ie)** = rated operational voltage (current)

**Ic** = making and breaking current expressed in DC or in AC like the r.m.s. value of the symmetrical components

**T0.95** = time required to reach 95 % of the current in steady-state conditions, expressed in milliseconds



## North American standards and utilization categories

Depending on the utilization category or intended rating for a contactor, North American standards require two main tests: an endurance test to simulate conventional device making and breaking capacity over its lifetime, and an overload test to simulate periodic conditions demanding higher making and breaking capacity than is conventional for the application. The test setups differ in regards to current, power factor, and number of electrical operating cycles.

The tables below provide a comparison of the types of load testing for contactors rated up to 100 A.

### AC load testing for contactors rated up to 100 A

Harmonized test			Rating designation	Endurance (conventional) test			Overload (conditional) test			Required load marking
IEC	UL	CSA		Multiple of current	Power factor	Number of cycles	Multiple of current	Power factor	Number of cycles	

#### General use, non-inductive or slighting inductive loads, resistance furnaces and heaters

■	■	■	AC-1: general use	1	0.8	6000	1.5	0.8	50	-
	■	■	AC resistance	1	1	6000	1.5	1	50	"Resistive"
		■	AC resistance air heating	1	1	100000	1.5	1	50	"Resistance"
		■	AC electrical heating control	1	1	250000	1.5	1	50	-

#### Motor loads

■	■	■	AC-2: slip-ring motors	2	0.65	6000	4	0.65	50	-
■			AC-3: squirrel cage motors	2	0.45	6000	10 for make 8 for make break	0.45	50 make + 50 make break	-
	■	■	AC motor (across-the-line switching)	2	0.40 – 0.50	1000	LRA (~6)	0.40 – 0.50	50	-
		■	Elevator control, AC motor	2	0.50	500000	n/a	n/a	n/a	"Elevator duty"
■	■	■	AC-4: plugging, inching, jogging	6	0.45	6000	12 for make 10 for make break	0.45	50 make + 50 make break	-

#### Lamps and lighting loads

■	■	■	AC-5a: electric discharge lamps	2	0.45	6000	3	0.45	50	"Ballast"
■	■	■	AC-5b: incandescent lamps	1	Lamp	6000	1.5	Lamp	50	"Tungsten"

#### Transformers and capacitors

■			AC-6a: transformers	The manufacturer shall verify the AC-6a rating by testing with a transformer, or may derive the rating from the values for AC-3.						
■			AC-6b: capacitors	Capacitive ratings may be derived by capacitor switching tests or assigned on the basis of established practice and experience.						
	■	■	Capacitive switching (kVar)	1	Capacitor	6000	1.5	Capacitor	50	-

#### Hermetic refrigerant compressor motors

■	■	■	AC-8a: hermetic refrigerant compressor	1	0.8	30000	6	0.45	50	"Hermetic refrigeration compressor"
■	■	■	AC-8b: hermetic refrigerant compressor (recycle rating)	6	0.45	6000	6	0.45	50	-

Note: the information above is an overview of UL 60947-4-1 tables 1, 7, 10, 5.4.1DV.1.1, 8.2.4.1DV.1.1, and 8.2.4.2DV.1.1 and is intended for comparison purposes only.

### DC load testing for contactors rated up to 100 A

Harmonized test			Rating designation	Endurance test			Overload test			Required load marking
IEC	UL	CSA		Multiple of current	L/R ms	Number of cycles	Multiple of current	L/R ms	Number of cycles	

#### General use, non-inductive or slighting inductive loads, resistance furnaces and heaters

■	■	■	DC-1: general use	1	1	6000	1.5	1	50	-
	■	■	DC resistance	1	1	6000	1.5	1	50	"Resistive"
		■	DC resistance air heating	1	1	100000	1.5	1	50	"Resistance"

#### Motor loads

■			DC-3: shunt motors	2.5	2	6000	4	2.5	50	-
	■	■	DC motor (across-the-line switching)	2	n/a	1000	10	n/a	50	-
		■	Elevator control, DC motor	2	n/a	500000	Not applicable			"Elevator duty"
■			DC-5: series motors	2.5	7.5	6000	4	15	50	-

#### Lamps and lighting loads

■	■	■	DC-6: incandescent lamps	1	Lamp	6000	1.5	Lamp	50	"Tungsten"
---	---	---	--------------------------	---	------	------	-----	------	----	------------

Note: the information above is an overview of UL 60947-4-1 tables 1, 7, 10, 5.4.1DV.1.1, 8.2.4.1DV.1.1, and 8.2.4.2DV.1.1 and is intended for comparison purposes only.

## Degrees of protection

### General

In an installation, the degree of protection required for electrical equipment depends on the environmental characteristics. The degree of protection, ensured by the enclosure of equipment or by the cubicle containing the equipment is expressed by the IP code which gives the level of protection against access to hazardous parts, the ingress of foreign bodies and/or the ingress of water, in compliance with IEC 60529, IEC 60947-1.

Besides the IP symbol, the complete code has two figures followed (optionally) by two additional letters. A short description of the elements used in IP coding is given below.

IP... code	Figures or letters	Specifications for installation protection	Protection of persons
<b>First figure</b>		<b>Against ingress of foreign bodies</b>	<b>Against access to hazardous parts with:</b>
	0	No protection	No protection
	1	Diameter > 50 mm	Back of hand
	2	Diameter > 12.5 mm	Finger
	3	Diameter > 2.5 mm	Tool
	4	Diameter > 1 mm	Wire
	5	Limited protection against dust	Wire
	6	Total protection against dust	Wire
<b>Second figure</b>		<b>Against entrance of water having a harmful effect</b>	
	0	No protection	
	1	Vertical dripping	
	2	Dripping at a vertical angle of < 15°	
	3	Rain at a vertical angle of < 60°	
	4	Splashing	
	5	Low pressure water jet	
	6	Powerful water jets	
	7	Temporary immersion	
	8	Permanent immersion	
<b>Additional letter (optional) for use with:</b>		<b>Against ingress of foreign bodies</b>	<b>Against access to hazardous parts with:</b>
First figure 0	A	Stopped by a barrier with a 50 mm Ø sphere	Back of hand
First figure 0 or 1	B	Entrance of test finger limited to 80 mm	Finger
First figure 1 or 2	C	Wire with 2.5 mm Ø and length of 100 mm	Tool
First figure 2 or 3	D	Wire with 1 mm Ø and length of 100 mm	Wire
<b>Additional letter (optional)</b>		<b>Specific additional information</b>	
	H	High voltage apparatus	-
	M	Moving parts which are moving during water test	
	S	Moving parts which are stationary during water test	
	W	Specified atmospheric conditions	

Note: The type of enclosure or cubicle in which the equipment must be installed prevails with respect to the degree of protection.



## Climatic withstand of devices

The life time of devices are mainly influenced by series of climatic factors which cause their corrosion.

In practice, besides climatic conditions, there are other factors which may damage equipment such as fungi, insects (termites), dust, work site dirt and aggressive environment (salty or sulphurous atmosphere, etc.) which can often only be identified at the place of installation.

Climatic stress, definitions and test conditions are dealt with in national publications such as the DIN 50 series and UTE 63-100 publication which are attached to international publications such as IEC 60068.

### The test conditions are:

Description	Symbolization	Time of one cycle	Cycle phase time	Temperature in test chamber	Relative humidity
Humidity and variable temperature	IEC 60068-2-30 Test Db	24 hours	12 hours including rise in temperature	40 °C	95 %
			12 hours including cooling (open device)	25 °C	95 %

ABB contactors have been used for many years in the most countries, with hot and humid climates for example: Brazil, Indonesia, India or on ships. Experience has shown that ABB devices can be used in most countries throughout the world.

The climate of the country in which the apparatus is installed is not the determining choice factor.

### Account must be taken of:

- the immediate environment of the devices (sheltered, ventilated, temperature),
- the aggressivity of the immediate atmosphere at the place of installation,
- the length and frequency of non operating periods.

In the case of frequent condensation (i.e. the formation of condensation caused by rapid changes in temperature), heating resistors must be installed in cubicles (100 to 250 W per m<sup>3</sup> of enclosure).

### The table below gives the cases where heating is necessary.

Environment		Operating conditions	Climate	Internal heating of enclosure
Inside premises	No running water no condensation	Continuous or not	All climates	Without
	With running water	Continuous	All climates	Without
		Frequent or long stops	Temperate Tropical	Without With
Outside, sheltered	No running water no condensation	Continuous or not	Temperate	Without
			Tropical	With
Outside or by the seaside	With running water	Continuous Frequent or long stops	All climates	Without
			Temperate	Without
			Tropical	With

The entrance of dust, insects, dirt, etc. in devices may be prevented if the appropriate degree of protection according to IEC 60529 is chosen (See "Degree of protection" table).

—  
**Notes**

A large rectangular area filled with a grid of small, light gray dotted lines, intended for handwritten notes.

# Index

## Order code classification

Order code	Type	Page	Order code	Type	Page	Order code	Type	Page
1SAJ231000R0001	DNP31.0	11/11	1SAM201903R1202	SK1-20K	2/37	1SAM250000R1015	MS116-32	2/10
1SAJ242000R0001	PDP32.0	11/11	1SAM201903R1203	SK1-02K	2/37	1SAM250005R1001	MS116-0.16-HKF1-11	2/10
1SAJ243000R0001	PDR31.0	11/11	1SAM201904R1001	UA1-24	2/36	1SAM250005R1002	MS116-0.25-HKF1-11	2/10
1SAJ251000R0001	MRP31.0	11/11	1SAM201904R1002	UA1-48	2/36	1SAM250005R1003	MS116-0.4-HKF1-11	2/10
1SAJ260000R0100	MTQ22-FBP.0	11/13	1SAM201904R1003	UA1-60	2/36	1SAM250005R1004	MS116-0.63-HKF1-11	2/10
1SAJ261000R0100	PNQ22-FBP.0	11/13	1SAM201904R1004	UA1-110	2/36	1SAM250005R1005	MS116-1.0-HKF1-11	2/10
1SAJ262000R0100	EIU32.0	11/13	1SAM201904R1005	UA1-230	2/36	1SAM250005R1006	MS116-1.6-HKF1-11	2/10
1SAJ510002R0002	UMCPAN-CAB.300	11/9	1SAM201904R1006	UA1-400	2/36	1SAM250005R1007	MS116-2.5-HKF1-11	2/10
1SAJ510003R0002	UMCPAN-CAB.070	11/9	1SAM201904R1007	UA1-415	2/36	1SAM250005R1008	MS116-4.0-HKF1-11	2/10
1SAJ510004R0002	UMCPAN-CAB.150	11/9	1SAM201904R1008	UA1-208	2/36	1SAM250005R1009	MS116-6.3-HKF1-11	2/10
1SAJ510005R0001	UMC100-PAN CAP	11/9	1SAM201904R1009	UA1-575	2/36	1SAM250005R1010	MS116-10.0-HKF1-11	2/10
1SAJ530000R0100	UMC100.3 DC	11/8	1SAM201904R1010	UA1-20	2/36	1SAM250005R1011	MS116-16.0-HKF1-11	2/10
1SAJ530000R0200	UMC100.3 DC EX	11/8	1SAM201906R1102	PS1-2-0-65	2/41	1SAM250005R1012	MS116-12.0-HKF1-11	2/10
1SAJ530000R0210	UMC100.3 DC EX Coated	11/8	1SAM201906R1103	PS1-3-0-65	2/41	1SAM250005R1013	MS116-2.0-HKF1-11	2/10
1SAJ530000R1100	UMC100.3 UC	11/8	1SAM201906R1104	PS1-4-0-65	2/41	1SAM250005R1014	MS116-25-HKF1-11	2/10
1SAJ530000R1200	UMC100.3 UC EX	11/8	1SAM201906R1105	PS1-5-0-65	2/41	1SAM250005R1015	MS116-32-HKF1-11	2/10
1SAJ530000R1210	UMC100.3 UC EX Coated	11/8	1SAM201906R1112	PS1-2-1-65	2/41	1SAM301901R1001	CK1-11	2/35
1SAJ590000R0103	UMC100-PAN	11/9	1SAM201906R1113	PS1-3-1-65	2/41	1SAM301901R1002	CK1-20	2/35
1SAJ611000R0101	DX111-FBP.0	11/10	1SAM201906R1114	PS1-4-1-65	2/41	1SAM301901R1003	CK1-02	2/35
1SAJ613000R0101	AI111.0	11/10	1SAM201906R1115	PS1-5-1-65	2/41	1SAM340000R1001	MS132-0.16T	2/29
1SAJ622000R0101	DX122-FBP.0	11/10	1SAM201906R1122	PS1-2-2-65	2/41	1SAM340000R1002	MS132-0.25T	2/29
1SAJ650000R0100	VI150-FBP.0	11/10	1SAM201906R1123	PS1-3-2-65	2/41	1SAM340000R1003	MS132-0.4T	2/29
1SAJ655000R0100	VI155-FBP.0	11/10	1SAM201906R1124	PS1-4-2-65	2/41	1SAM340000R1004	MS132-0.63T	2/29
1SAJ691000R0001	UMCI0-CAB.030	11/10	1SAM201906R1125	PS1-5-2-65	2/41	1SAM340000R1005	MS132-1.0T	2/29
1SAJ692000R0001	IOIO-CAB.030	11/10	1SAM201907R1101	S1-M1-25	2/41	1SAM340000R1006	MS132-1.6T	2/29
1SAJ924012R0006	PBDTM-FBP.0	11/15	1SAM201907R1102	S1-M2-25	2/41	1SAM340000R1007	MS132-2.5T	2/29
1SAJ924013R0001	UTP22-FBP.0	11/15	1SAM201907R1103	S1-M3-25	2/41	1SAM340000R1008	MS132-4.0T	2/29
1SAJ929160R0001	UMCTB-FBP.0	11/10	1SAM201908R1001	BS1-3	2/41	1SAM340000R1009	MS132-6.3T	2/29
1SAJ929160R0002	UMCTB.1	11/10	1SAM201909R1001	FS116	2/41	1SAM340000R1010	MS132-10T	2/29
1SAJ929180R0015	CDP18.150	11/12	1SAM201909R1021	MSAH1	2/45	1SAM340000R1011	MS132-16T	2/29
1SAJ929200R0001	ETHTB-FBP.4	11/14	1SAM201910R1001	AA1-24	2/36	1SAM340000R1012	MS132-12T	2/29
1SAJ929200R0002	ETHTB-FBP.50	11/14	1SAM201910R1002	AA1-110	2/36	1SAM340000R1013	MS132-20T	2/29
1SAJ929200R0020	CEM11-FBP.20	11/16	1SAM201910R1003	AA1-230	2/36	1SAM340000R1014	MS132-25T	2/29
1SAJ929200R0035	CEM11-FBP.35	11/16	1SAM201910R1004	AA1-400	2/36	1SAM340010R1001	MS132-0.16KT	2/30
1SAJ929200R0060	CEM11-FBP.60	11/16	1SAM201911R1010	IB132-G	2/44	1SAM340010R1002	MS132-0.25KT	2/30
1SAJ929200R0120	CEM11-FBP.120	11/16	1SAM201911R1011	IB132-Y	2/44	1SAM340010R1003	MS132-0.4KT	2/30
1SAJ929230R0015	CDP23.150	11/14	1SAM201912R1010	DMS132-G	2/44	1SAM340010R1004	MS132-0.63KT	2/30
1SAJ929230R0030	CDP23.300	11/14	1SAM201912R1011	DMS132-Y	2/44	1SAM340010R1005	MS132-1.0KT	2/30
1SAJ929240R0015	CDP24.150	11/12	1SAM201913R1103	S1-M3-35	2/41	1SAM340010R1006	MS132-1.6KT	2/30
1SAJ929400R0002	UTF21-FBP.0	11/15	1SAM201914R1001	PB1-1-32	2/41	1SAM340010R1007	MS132-2.5KT	2/30
1SAJ929500R0185	CT4L185R/4	11/16	1SAM201914R1002	S1-PB1-25	2/41	1SAM340010R1008	MS132-4.0KT	2/30
1SAJ929500R0310	CT4L310R/4	11/16	1SAM201916R1103	PS1-3-0-100	2/41	1SAM340010R1009	MS132-6.3KT	2/30
1SAJ929501R0500	CT5L500R/4	11/16	1SAM201916R1104	PS1-4-0-100	2/41	1SAM340010R1010	MS132-10KT	2/30
1SAJ929501R0850	CT5L850R/4	11/16	1SAM201916R1105	PS1-5-0-100	2/41	1SAM340010R1011	MS132-16KT	2/30
1SAJ929600R0001	SMK3.0	11/12	1SAM201916R1113	PS1-3-1-100	2/41	1SAM340010R1012	MS132-20KT	2/30
1SAJ929610R0001	SMK3-X2.10	11/12	1SAM201916R1114	PS1-4-1-100	2/41	1SAM340010R1014	MS132-25KT	2/30
1SAJ929620R0001	SMK3-X1.10	11/12	1SAM201916R1115	PS1-5-1-100	2/41	1SAM350000R1001	MS132-0.16	2/11
1SAM101923R0002	MSMN	2/45	1SAM201916R1123	PS1-3-2-100	2/41	1SAM350000R1002	MS132-0.25	2/11
1SAM101923R0012	MSMNO	2/45	1SAM201920R1000	MSH-AR	2/45	1SAM350000R1003	MS132-0.4	2/11
1SAM201901R1001	HKF1-11	2/35	1SAM201920R1001	MSHD-LB	2/45	1SAM350000R1004	MS132-0.63	2/11
1SAM201901R1002	HKF1-20	2/35	1SAM201920R1002	MSHD-LY	2/45	1SAM350000R1005	MS132-1.0	2/11
1SAM201901R1003	HKF1-10	2/35	1SAM201920R1011	MSHD-LTB	2/45	1SAM350000R1006	MS132-1.6	2/11
1SAM201901R1004	HKF1-01	2/35	1SAM201920R1012	MSHD-LTY	2/45	1SAM350000R1007	MS132-2.5	2/11
1SAM201901R1201	HKF1-11K	2/37	1SAM250000R1001	MS116-0.16	2/10	1SAM350000R1008	MS132-4.0	2/11
1SAM201901R1202	HKF1-20K	2/37	1SAM250000R1002	MS116-0.25	2/10	1SAM350000R1009	MS132-6.3	2/11
1SAM201902R1001	HK1-11	2/35	1SAM250000R1003	MS116-0.4	2/10	1SAM350000R1010	MS132-10	2/11
1SAM201902R1002	HK1-20	2/35	1SAM250000R1004	MS116-0.63	2/10	1SAM350000R1011	MS132-16	2/11
1SAM201902R1003	HK1-02	2/35	1SAM250000R1005	MS116-1.0	2/10	1SAM350000R1012	MS132-12	2/11
1SAM201902R1004	HK1-20L	2/35	1SAM250000R1006	MS116-1.6	2/10	1SAM350000R1013	MS132-20	2/11
1SAM201902R1201	HK1-11K	2/37	1SAM250000R1007	MS116-2.5	2/10	1SAM350000R1014	MS132-25	2/11
1SAM201902R1202	HK1-20K	2/37	1SAM250000R1008	MS116-4.0	2/10	1SAM350000R1015	MS132-32	2/11
1SAM201902R1203	HK1-02K	2/37	1SAM250000R1009	MS116-6.3	2/10	1SAM350005R1001	MS132-0.16-HKF1-11	2/11
1SAM201902R1204	HK1-20LK	2/37	1SAM250000R1010	MS116-10	2/10	1SAM350005R1002	MS132-0.25-HKF1-11	2/11
1SAM201903R1001	SK1-11	2/35	1SAM250000R1011	MS116-16	2/10	1SAM350005R1003	MS132-0.4-HKF1-11	2/11
1SAM201903R1002	SK1-20	2/35	1SAM250000R1012	MS116-12	2/10	1SAM350005R1004	MS132-0.63-HKF1-11	2/11
1SAM201903R1003	SK1-02	2/35	1SAM250000R1013	MS116-20	2/10	1SAM350005R1005	MS132-1.0-HKF1-11	2/11
1SAM201903R1201	SK1-11K	2/37	1SAM250000R1014	MS116-25	2/10	1SAM350005R1006	MS132-1.6-HKF1-11	2/11

# Index

## Order code classification

Order code	Type	Page	Order code	Type	Page	Order code	Type	Page
1SAM350005R1007	MS132-2.5-HKF1-11	2/11	1SAT112000R1011	HF0.6-DOL-24VDC	10/8	1SAZ421301R1005	TA200DU-175-V1000	6/25
1SAM350005R1008	MS132-4.0-HKF1-11	2/11	1SAT113000R1011	HF0.6-DOLE-24VDC	10/8	1SAZ421301R1006	TA200DU-200-V1000	6/25
1SAM350005R1009	MS132-6.3-HKF1-11	2/11	1SAT115000R1011	HF0.6-ROL-24VDC	10/9	1SAZ431201R1001	TF140DU-90	6/21
1SAM350005R1010	MS132-10.0-HKF1-11	2/11	1SAT116000R1011	HF0.6-ROLE-24VDC	10/9	1SAZ431201R1002	TF140DU-110	6/21
1SAM350005R1011	MS132-16.0-HKF1-11	2/11	1SAT122000R1011	HF2.4-DOL-24VDC	10/8	1SAZ431201R1003	TF140DU-135	6/21
1SAM350005R1012	MS132-12.0-HKF1-11	2/11	1SAT123000R1011	HF2.4-DOLE-24VDC	10/8	1SAZ431201R1004	TF140DU-142	6/21
1SAM350005R1013	MS132-20-HKF1-11	2/11	1SAT125000R1011	HF2.4-ROL-24VDC	10/9	1SAZ431301R1001	TF140DU-90-V1000	6/21
1SAM350005R1014	MS132-25-HKF1-11	2/11	1SAT126000R1011	HF2.4-ROLE-24VDC	10/9	1SAZ431301R1002	TF140DU-110-V1000	6/21
1SAM350005R1015	MS132-32-HKF1-11	2/11	1SAT142000R1011	HF9-DOL-24VDC	10/8	1SAZ431301R1003	TF140DU-135-V1000	6/21
1SAM350006R1011	MS132-16-HKF1-20	2/11	1SAT143000R1011	HF9-DOLE-24VDC	10/8	1SAZ431301R1004	TF140DU-142-V1000	6/21
1SAM350010R1001	MS132-0.16K	2/12	1SAT144000R1011	HF9-R-24VDC	10/9	1SAZ701901R0001	DB16	6/4
1SAM350010R1002	MS132-0.25K	2/12	1SAT145000R1011	HF9-ROL-24VDC	10/9	1SAZ701902R0001	DB42	6/9
1SAM350010R1003	MS132-0.4K	2/12	1SAT146000R1011	HF9-ROLE-24VDC	10/9	1SAZ701903R1001	WRH-F	6/44
1SAM350010R1004	MS132-0.63K	2/12	1SAX101110R0001	DB16E	6/29	1SAZ701903R1011	WRB-400	6/44
1SAM350010R1005	MS132-1.0K	2/12	1SAX101910R1001	DB19EF	6/29	1SAZ701903R1012	WRB-600	6/44
1SAM350010R1006	MS132-1.6K	2/12	1SAX101911R1001	DRS-F-01	6/9	1SAZ701903R1013	WRB-1000	6/44
1SAM350010R1007	MS132-2.5K	2/12	1SAX101911R1002	DRS-F-02	6/9	1SAZ701903R1030	WRBG	6/44
1SAM350010R1008	MS132-4.0K	2/12	1SAX101911R1003	DRS-F-03	6/9	1SAZ711201R1005	T16-0.13	6/4
1SAM350010R1009	MS132-6.3K	2/12	1SAX101911R1004	DRS-F-04	6/9	1SAZ711201R1008	T16-0.17	6/4
1SAM350010R1010	MS132-10K	2/12	1SAX111001R1101	E16DU-0.32	6/29	1SAZ711201R1009	T16-0.23	6/4
1SAM350010R1011	MS132-16K	2/12	1SAX111001R1102	E16DU-1.0	6/29	1SAZ711201R1013	T16-0.31	6/4
1SAM350010R1013	MS132-20K	2/12	1SAX111001R1103	E16DU-2.7	6/29	1SAZ711201R1014	T16-0.41	6/4
1SAM350010R1014	MS132-25K	2/12	1SAX111001R1104	E16DU-6.3	6/29	1SAZ711201R1017	T16-0.55	6/4
1SAM350010R1015	MS132-32K	2/12	1SAX111001R1105	E16DU-18.9	6/29	1SAZ711201R1021	T16-0.74	6/4
1SAM360000R1001	MO132-0.16	2/14		EF19-18.9	12/38	1SAZ711201R1023	T16-1.0	6/4
1SAM360000R1002	MO132-0.25	2/14	1SAX121001R1101	EF19-0.32	6/29	1SAZ711201R1025	T16-1.3	6/4
1SAM360000R1003	MO132-0.4	2/14	1SAX121001R1102	EF19-1.0	6/29	1SAZ711201R1028	T16-1.7	6/4
1SAM360000R1004	MO132-0.63	2/14	1SAX121001R1103	EF19-2.7	6/29	1SAZ711201R1031	T16-2.3	6/4
1SAM360000R1005	MO132-1.0	2/14	1SAX121001R1104	EF19-6.3	6/29	1SAZ711201R1033	T16-3.1	6/4
1SAM360000R1006	MO132-1.6	2/14	1SAX121001R1105	EF19-18.9	6/29	1SAZ711201R1035	T16-4.2	6/4
1SAM360000R1007	MO132-2.5	2/14	1SAX201910R0001	DB45EF	6/29	1SAZ711201R1038	T16-5.7	6/4
1SAM360000R1008	MO132-4.0	2/14	1SAX211001R1101	EF45-30	12/38	1SAZ711201R1040	T16-7.6	6/4
1SAM360000R1009	MO132-6.3	2/14	1SAX211001R1102	EF45-45	12/38	1SAZ711201R1043	T16-10	6/4
1SAM360000R1010	MO132-10	2/14	1SAX221001R1101	EF45-30	6/29		TF42-10	12/36
1SAM360000R1011	MO132-16	2/14	1SAX221001R1102	EF45-45	6/29	1SAZ711201R1045	T16-13	6/4
1SAM360000R1012	MO132-12	2/14	1SAX331001R1101	EF65-70	6/33		TF42-13	12/36
1SAM360000R1013	MO132-20	2/14	1SAX331001R1102	EF65-56	6/33	1SAZ711201R1047	T16-16	6/4
1SAM360000R1014	MO132-25	2/14	1SAX341001R1101	EF96-100	6/33		TF42-16	12/36
1SAM360000R1015	MO132-32	2/14	1SAX341001R1102	EF96-56	6/33	1SAZ711201R1051	TF42-24	12/36
1SAM401920R1002	PS2-2-0-125	2/42	1SAX351001R1101	EF146-150	6/33	1SAZ711201R1053	TF42-35	12/36
1SAM401920R1003	PS2-3-0-125	2/42	1SAX501904R0001	LT200E	6/37	1SAZ711201R1055	TF42-38	12/36
1SAM401920R1004	PS2-4-0-125	2/42	1SAX531001R1101	EF205-210	6/37	1SAZ721201R1005	TF42-0.13	6/8
1SAM401920R1022	PS2-2-2-125	2/42		EF205-110	12/38	1SAZ721201R1008	TF42-0.17	6/8
1SAM401920R1023	PS2-3-2-125	2/42	1SAX601904R0001	LT320E	6/37	1SAZ721201R1009	TF42-0.23	6/8
1SAM401920R1024	PS2-4-2-125	2/42	1SAX611001R1101	EF370-380	6/37	1SAZ721201R1013	TF42-0.31	6/8
1SAM401921R1001	BS2-3	2/42	1SAX701902R1001	DT500/AF460-L	6/41	1SAZ721201R1014	TF42-0.41	6/8
1SAM401922R1001	KA165	2/42	1SAX701902R1011	DT500/AF460-S	6/41	1SAZ721201R1017	TF42-0.55	6/8
1SAM451000R1011	MS165-16	2/13	1SAX701904R0002	LT460EF	6/41	1SAZ721201R1021	TF42-0.74	6/8
1SAM451000R1012	MS165-20	2/13	1SAX721001R1101	EF460-500	6/41	1SAZ721201R1023	TF42-1.0	6/8
1SAM451000R1013	MS165-25	2/13	1SAX801902R1001	DT800/AF750-L	6/41	1SAZ721201R1025	TF42-1.3	6/8
1SAM451000R1014	MS165-32	2/13	1SAX801902R1011	DT800/AF750-S	6/41	1SAZ721201R1028	TF42-1.7	6/8
1SAM451000R1015	MS165-42	2/13	1SAX801904R0002	LT750EF	6/41	1SAZ721201R1031	TF42-2.3	6/8
1SAM451000R1016	MS165-54	2/13	1SAX821001R1101	EF750-800	6/41	1SAZ721201R1033	TF42-3.1	6/8
1SAM451000R1017	MS165-65	2/13	1SAZ401110R0001	DB200	6/25	1SAZ721201R1035	TF42-4.2	6/8
1SAM451000R1018	MS165-73	2/13	1SAZ401901R1001	LT200/A	6/25	1SAZ721201R1038	TF42-5.7	6/8
1SAM451000R1019	MS165-80	2/13	1SAZ411201R1005	TA200DU-175	12/36	1SAZ721201R1040	TF42-7.6	6/8
1SAM461000R1011	MO165-16	2/15	1SAZ411201R1006	TA200DU-200	12/36	1SAZ721201R1043	TF42-10	6/8
1SAM461000R1012	MO165-20	2/15	1SAZ421201R1001	TA200DU-90	6/25	1SAZ721201R1045	TF42-13	6/8
1SAM461000R1013	MO165-25	2/15	1SAZ421201R1002	TA200DU-110	6/25	1SAZ721201R1047	TF42-16	6/8
1SAM461000R1014	MO165-32	2/15	1SAZ421201R1003	TA200DU-135	6/25	1SAZ721201R1049	TF42-20	6/8
1SAM461000R1015	MO165-42	2/15	1SAZ421201R1004	TA200DU-150	6/25	1SAZ721201R1051	TF42-24	6/8
1SAM461000R1016	MO165-54	2/15	1SAZ421201R1005	TA200DU-175	6/25	1SAZ721201R1052	TF42-29	6/8
1SAM461000R1017	MO165-65	2/15	1SAZ421201R1006	TA200DU-200	6/25	1SAZ721201R1053	TF42-35	6/8
1SAM461000R1018	MO165-73	2/15	1SAZ421301R1001	TA200DU-90-V1000	6/25	1SAZ721201R1055	TF42-38	6/8
1SAM461000R1019	MO165-80	2/15	1SAZ421301R1002	TA200DU-110-V1000	6/25	1SAZ801901R1001	DB65	6/13
1SAM550000R1008	MS495-75	12/6	1SAZ421301R1003	TA200DU-135-V1000	6/25	1SAZ811201R1001	TF65-28	6/13
1SAM550000R1009	MS495-90	12/6	1SAZ421301R1004	TA200DU-150-V1000	6/25	1SAZ811201R1002	TF65-33	6/13

# Index

## Order code classification

Order code	Type	Page
1SAZ811201R1003	TF65-40	6/13
1SAZ811201R1004	TF65-47	6/13
1SAZ811201R1005	TF65-53	6/13
1SAZ811201R1006	TF65-60	6/13
1SAZ811201R1007	TF65-67	6/13
1SAZ901901R1001	DB96	6/17
1SAZ911201R1001	TF96-51	6/17
1SAZ911201R1002	TF96-60	6/17
1SAZ911201R1003	TF96-68	6/17
1SAZ911201R1004	TF96-78	6/17
1SAZ911201R1005	TF96-87	6/17
1SAZ911201R1006	TF96-96	6/17
1SBH101001R2022	NS22E-20	5/30
1SBH101001R2031	NS31E-20	5/30
1SBH101001R2040	NS40E-20	5/30
1SBH101001R2044	NS44E-20	5/30
1SBH101001R2053	NS53E-20	5/30
1SBH101001R2062	NS62E-20	5/30
1SBH101001R2071	NS71E-20	5/30
1SBH101001R2080	NS80E-20	5/30
1SBH101001R2622	NS22E-26	5/30
1SBH101001R2631	NS31E-26	5/30
1SBH101001R2640	NS40E-26	5/30
1SBH101001R2644	NS44E-26	5/30
1SBH101001R2653	NS53E-26	5/30
1SBH101001R2662	NS62E-26	5/30
1SBH101001R2671	NS71E-26	5/30
1SBH101001R2680	NS80E-26	5/30
1SBH101004R2022	NS22ES-20	5/73
1SBH101004R2031	NS31ES-20	5/73
1SBH101004R2040	NS40ES-20	5/73
1SBH101004R2044	NS44ES-20	5/73
1SBH101004R2053	NS53ES-20	5/73
1SBH101004R2062	NS62ES-20	5/73
1SBH101004R2071	NS71ES-20	5/73
1SBH101004R2080	NS80ES-20	5/73
1SBH101004R2622	NS22ES-26	5/73
1SBH101004R2631	NS31ES-26	5/73
1SBH101004R2640	NS40ES-26	5/73
1SBH101004R2644	NS44ES-26	5/73
1SBH101004R2653	NS53ES-26	5/73
1SBH101004R2662	NS62ES-26	5/73
1SBH101004R2671	NS71ES-26	5/73
1SBH101004R2680	NS80ES-26	5/73
1SBH103001R8122	NSL22E-81	5/31
1SBH103001R8131	NSL31E-81	5/31
1SBH103001R8140	NSL40E-81	5/31
1SBH103001R8144	NSL44E-81	5/31
1SBH103001R8153	NSL53E-81	5/31
1SBH103001R8162	NSL62E-81	5/31
1SBH103001R8171	NSL71E-81	5/31
1SBH103001R8180	NSL80E-81	5/31
1SBH103004R8122	NSL22ES-81	5/74
1SBH103004R8131	NSL31ES-81	5/74
1SBH103004R8140	NSL40ES-81	5/74
1SBH103004R8144	NSL44ES-81	5/74
1SBH103004R8153	NSL53ES-81	5/74
1SBH103004R8162	NSL62ES-81	5/74
1SBH103004R8171	NSL71ES-81	5/74
1SBH103004R8180	NSL80ES-81	5/74
1SBH136001R2022	NFZ22E-20	3/210
1SBH136001R2031	NFZ31E-20	3/210
1SBH136001R2039	NFZ33/11-20	3/214
1SBH136001R2040	NFZ40E-20	3/210
1SBH136001R2044	NFZ44E-20	3/214
1SBH136001R2053	NFZ53E-20	3/214
1SBH136001R2059	NFZ51/11-20	3/214
1SBH136001R2062	NFZ22E-20	3/214
1SBH136001R2071	NFZ271E-20	3/214
1SBH136001R2080	NFZ280E-20	3/214
1SBH136001R2122	NFZ22E-21	3/210
1SBH136001R2131	NFZ31E-21	3/210
1SBH136001R2139	NFZ33/11-21	3/214
1SBH136001R2140	NFZ40E-21	3/210
1SBH136001R2144	NFZ44E-21	3/214
1SBH136001R2153	NFZ53E-21	3/214
1SBH136001R2159	NFZ51/11-21	3/214
1SBH136001R2162	NFZ22E-21	3/214
1SBH136001R2171	NFZ271E-21	3/214
1SBH136001R2180	NFZ280E-21	3/214
1SBH136001R2222	NFZ22E-22	3/210
1SBH136001R2231	NFZ31E-22	3/210
1SBH136001R2239	NFZ33/11-22	3/214
1SBH136001R2240	NFZ40E-22	3/210
1SBH136001R2244	NFZ44E-22	3/214
1SBH136001R2253	NFZ53E-22	3/214
1SBH136001R2259	NFZ51/11-22	3/214
1SBH136001R2262	NFZ22E-22	3/214
1SBH136001R2271	NFZ271E-22	3/214
1SBH136001R2280	NFZ280E-22	3/214
1SBH136001R2322	NFZ22E-23	3/210
1SBH136001R2331	NFZ31E-23	3/210
1SBH136001R2339	NFZ33/11-23	3/214
1SBH136001R2340	NFZ40E-23	3/210
1SBH136001R2344	NFZ44E-23	3/214
1SBH136001R2353	NFZ53E-23	3/214
1SBH136001R2359	NFZ51/11-23	3/214
1SBH136001R2362	NFZ22E-23	3/214
1SBH136001R2371	NFZ271E-23	3/214
1SBH136001R2380	NFZ280E-23	3/214
1SBH136001R3022	NFZ22E-30	3/209
1SBH136001R3031	NFZ31E-30	3/209
1SBH136001R3040	NFZ40E-30	3/209
1SBH136001R3044	NFZ44E-30	3/213
1SBH136001R3053	NFZ53E-30	3/213
1SBH136001R3062	NFZ22E-30	3/213
1SBH136001R3071	NFZ271E-30	3/213
1SBH136001R3080	NFZ280E-30	3/213
1SBH136005R2022	NFZ22EK-20	3/221
1SBH136005R2031	NFZ31EK-20	3/221
1SBH136005R2040	NFZ40EK-20	3/221
1SBH136005R2044	NFZ44EK-20	3/221
1SBH136005R2053	NFZ53EK-20	3/221
1SBH136005R2062	NFZ22EK-20	3/221
1SBH136005R2071	NFZ271EK-20	3/221
1SBH136005R2080	NFZ280EK-20	3/221
1SBH136005R2122	NFZ22EK-21	3/221
1SBH136005R2131	NFZ31EK-21	3/221
1SBH136005R2140	NFZ40EK-21	3/221
1SBH136005R2144	NFZ44EK-21	3/221
1SBH136005R2153	NFZ53EK-21	3/221
1SBH136005R2162	NFZ22EK-21	3/221
1SBH136005R2171	NFZ271EK-21	3/221
1SBH136005R2180	NFZ280EK-21	3/221
1SBH136005R2222	NFZ22EK-22	3/221
1SBH136005R2231	NFZ31EK-22	3/221
1SBH136005R2240	NFZ40EK-22	3/221
1SBH136005R2244	NFZ44EK-22	3/221
1SBH136005R2253	NFZ53EK-22	3/221
1SBH136005R2262	NFZ22EK-22	3/221
1SBH136005R2271	NFZ271EK-22	3/221
1SBH136005R2280	NFZ280EK-22	3/221
1SBH136005R2322	NFZ22EK-23	3/221
1SBH136005R2331	NFZ31EK-23	3/221

Order code	Type	Page
1SBH136001R2062	NFZ262E-20	3/214
1SBH136001R2071	NFZ271E-20	3/214
1SBH136001R2080	NFZ280E-20	3/214
1SBH136001R2122	NFZ22E-21	3/210
1SBH136001R2131	NFZ31E-21	3/210
1SBH136001R2139	NFZ33/11-21	3/214
1SBH136001R2140	NFZ40E-21	3/210
1SBH136001R2144	NFZ44E-21	3/214
1SBH136001R2153	NFZ53E-21	3/214
1SBH136001R2159	NFZ51/11-21	3/214
1SBH136001R2162	NFZ22E-21	3/214
1SBH136001R2171	NFZ271E-21	3/214
1SBH136001R2180	NFZ280E-21	3/214
1SBH136001R2222	NFZ22E-22	3/210
1SBH136001R2231	NFZ31E-22	3/210
1SBH136001R2239	NFZ33/11-22	3/214
1SBH136001R2240	NFZ40E-22	3/210
1SBH136001R2244	NFZ44E-22	3/214
1SBH136001R2253	NFZ53E-22	3/214
1SBH136001R2259	NFZ51/11-22	3/214
1SBH136001R2262	NFZ22E-22	3/214
1SBH136001R2271	NFZ271E-22	3/214
1SBH136001R2280	NFZ280E-22	3/214
1SBH136001R2322	NFZ22E-23	3/210
1SBH136001R2331	NFZ31E-23	3/210
1SBH136001R2339	NFZ33/11-23	3/214
1SBH136001R2340	NFZ40E-23	3/210
1SBH136001R2344	NFZ44E-23	3/214
1SBH136001R2353	NFZ53E-23	3/214
1SBH136001R2359	NFZ51/11-23	3/214
1SBH136001R2362	NFZ22E-23	3/214
1SBH136001R2371	NFZ271E-23	3/214
1SBH136001R2380	NFZ280E-23	3/214
1SBH136001R3022	NFZ22E-30	3/209
1SBH136001R3031	NFZ31E-30	3/209
1SBH136001R3040	NFZ40E-30	3/209
1SBH136001R3044	NFZ44E-30	3/213
1SBH136001R3053	NFZ53E-30	3/213
1SBH136001R3062	NFZ22E-30	3/213
1SBH136001R3071	NFZ271E-30	3/213
1SBH136001R3080	NFZ280E-30	3/213
1SBH136005R2022	NFZ22EK-20	3/221
1SBH136005R2031	NFZ31EK-20	3/221
1SBH136005R2040	NFZ40EK-20	3/221
1SBH136005R2044	NFZ44EK-20	3/221
1SBH136005R2053	NFZ53EK-20	3/221
1SBH136005R2062	NFZ22EK-20	3/221
1SBH136005R2071	NFZ271EK-20	3/221
1SBH136005R2080	NFZ280EK-20	3/221
1SBH136005R2122	NFZ22EK-21	3/221
1SBH136005R2131	NFZ31EK-21	3/221
1SBH136005R2140	NFZ40EK-21	3/221
1SBH136005R2144	NFZ44EK-21	3/221
1SBH136005R2153	NFZ53EK-21	3/221
1SBH136005R2162	NFZ22EK-21	3/221
1SBH136005R2171	NFZ271EK-21	3/221
1SBH136005R2180	NFZ280EK-21	3/221
1SBH136005R2222	NFZ22EK-22	3/221
1SBH136005R2231	NFZ31EK-22	3/221
1SBH136005R2240	NFZ40EK-22	3/221
1SBH136005R2244	NFZ44EK-22	3/221
1SBH136005R2253	NFZ53EK-22	3/221
1SBH136005R2262	NFZ22EK-22	3/221
1SBH136005R2271	NFZ271EK-22	3/221
1SBH136005R2280	NFZ280EK-22	3/221
1SBH136005R2322	NFZ22EK-23	3/221
1SBH136005R2331	NFZ31EK-23	3/221

Order code	Type	Page
1SBH136005R2340	NFZ40EK-23	3/221
1SBH136005R2344	NFZ44EK-23	3/221
1SBH136005R2353	NFZ53EK-23	3/221
1SBH136005R2362	NFZ22EK-23	3/221
1SBH136005R2371	NFZ271EK-23	3/221
1SBH136005R2380	NFZ280EK-23	3/221
1SBH136005R3022	NFZ22EK-30	3/220
1SBH136005R3031	NFZ31EK-30	3/220
1SBH136005R3040	NFZ40EK-30	3/220
1SBH136005R3044	NFZ44EK-30	3/220
1SBH136005R3053	NFZ53EK-30	3/220
1SBH136005R3062	NFZ22EK-30	3/220
1SBH136005R3071	NFZ271EK-30	3/220
1SBH136005R3080	NFZ280EK-30	3/220
1SBH137001R1122	NF22E-11	3/208
1SBH137001R1131	NF31E-11	3/208
1SBH137001R1139	NF 1-11	3/212
1SBH137001R1140	NF40E-11	3/208
1SBH137001R1144	NF44E-11	3/212
1SBH137001R1153	NF53E-11	3/212
1SBH137001R1159	NF51/11-11	3/212
1SBH137001R1162	NF62E-11	3/212
1SBH137001R1171	NF71E-11	3/212
1SBH137001R1180	NF80E-11	3/212
1SBH137001R1222	NF22E-12	3/208
1SBH137001R1231	NF31E-12	3/208
1SBH137001R1239	NF33/11-12	3/212
1SBH137001R1240	NF40E-12	3/208
1SBH137001R1244	NF44E-12	3/212
1SBH137001R1253	NF53E-12	3/212
1SBH137001R1259	NF51/11-12	3/212
1SBH137001R1262	NF62E-12	3/212
1SBH137001R1271	NF71E-12	3/212
1SBH137001R1280	NF80E-12	3/212
1SBH137001R1322	NF22E-13	3/208
1SBH137001R1331	NF31E-13	3/208
1SBH137001R1339	NF33/11-13	3/212
1SBH137001R1340	NF40E-13	3/208
1SBH137001R1344	NF44E-13	3/212
1SBH137001R1353	NF53E-13	3/212
1SBH137001R1359	NF51/11-13	3/212
1SBH137001R1362	NF62E-13	3/212
1SBH137001R1371	NF71E-13	3/212
1SBH137001R1380	NF80E-13	3/212
1SBH137001R1422	NF22E-14	3/208
1SBH137001R1431	NF31E-14	3/208
1SBH137001R1439	NF33/11-14	3/212
1SBH137001R1440	NF40E-14	3/208
1SBH137001R1444	NF44E-14	3/212
1SBH137001R1453	NF53E-14	3/212
1SBH137001R1459	NF51/11-14	3/212
1SBH137001R1462	NF62E-14	3/212
1SBH137001R1471	NF71E-14	3/212
1SBH137001R1480	NF80E-14	3/212
1SBH137005R1122	NF22EK-11	3/219
1SBH137005R1131	NF31EK-11	3/219

# Index

## Order code classification

Order code	Type	Page	Order code	Type	Page	Order code	Type	Page
1SBH137005R1262	NF62EK-12	3/219	1SBL101004R2601	AS09-30-01S-26	5/56	1SBL136005R2310	AF09Z-30-10K-23	3/92
1SBH137005R1271	NF71EK-12	3/219	1SBL101004R2610	AS09-30-10S-26	5/56	1SBL136005R3001	AF09Z-30-01K-30	3/91
1SBH137005R1280	NF80EK-12	3/219	1SBL101004R2632	AS09-30-32S-26	5/58	1SBL136005R3010	AF09Z-30-10K-30	3/91
1SBH137005R1322	NF22EK-13	3/219	1SBL103001R8101	ASL09-30-01-81	5/9	1SBL136082R3022	AFS09Z-30-22-30	3/114
1SBH137005R1331	NF31EK-13	3/219	1SBL103001R8110	ASL09-30-10-81	5/9	1SBL136201R2000	AF09Z-40-00-20	3/136
1SBH137005R1340	NF40EK-13	3/219	1SBL103001R8132	ASL09-30-32-81	5/11	1SBL136201R2100	AF09Z-40-00-21	3/136
1SBH137005R1344	NF44EK-13	3/219	1SBL103004R8101	ASL09-30-01S-81	5/57	1SBL136201R2200	AF09Z-40-00-22	3/136
1SBH137005R1353	NF53EK-13	3/219	1SBL103004R8110	ASL09-30-10S-81	5/57	1SBL136201R2300	AF09Z-40-00-23	3/136
1SBH137005R1362	NF62EK-13	3/219	1SBL103004R8132	ASL09-30-32S-81	5/59	1SBL136201R3000	AF09Z-40-00-30	3/135
1SBH137005R1371	NF71EK-13	3/219	1SBL111001R2001	AS12-30-01-20	5/8	1SBL136501R2000	AF09Z-22-00-20	3/136
1SBH137005R1380	NF80EK-13	3/219	1SBL111001R2010	AS12-30-10-20	5/8	1SBL136501R2100	AF09Z-22-00-21	3/136
1SBH137005R1422	NF22EK-14	3/219	1SBL111001R2032	AS12-30-32-20	5/10	1SBL136501R2200	AF09Z-22-00-22	3/136
1SBH137005R1431	NF31EK-14	3/219	1SBL111001R2601	AS12-30-01-26	5/8	1SBL136501R2300	AF09Z-22-00-23	3/136
1SBH137005R1440	NF40EK-14	3/219	1SBL111001R2610	AS12-30-10-26	5/8	1SBL136501R3000	AF09Z-22-00-30	3/135
1SBH137005R1444	NF44EK-14	3/219	1SBL111001R2632	AS12-30-32-26	5/10	1SBL137001R1101	AF09-30-01-11	3/14
1SBH137005R1453	NF53EK-14	3/219	1SBL111004R2001	AS12-30-01S-20	5/56	1SBL137001R1110	AF09-30-10-11	3/14
1SBH137005R1462	NF62EK-14	3/219	1SBL111004R2010	AS12-30-10S-20	5/56	1SBL137001R1122	AF09-30-22-11	3/38
1SBH137005R1471	NF71EK-14	3/219	1SBL111004R2032	AS12-30-32S-20	5/58	1SBL137001R1201	AF09-30-01-12	3/14
1SBH137005R1480	NF80EK-14	3/219	1SBL111004R2601	AS12-30-01S-26	5/56	1SBL137001R1210	AF09-30-10-12	3/14
1SBK104035R2800	DRAS09-28P	9/2	1SBL111004R2610	AS12-30-10S-26	5/56	1SBL137001R1222	AF09-30-22-12	3/38
1SBK104035R2900	DRAS09-29P	9/2	1SBL111004R2632	AS12-30-32S-26	5/58	1SBL137001R1301	AF09-30-01-13	3/14
1SBK104135R2600	DRAS09-26N	9/2	1SBL113001R8101	ASL12-30-01-81	5/9	1SBL137001R1310	AF09-30-10-13	3/14
1SBK104135R2700	DRAS09-27N	9/2	1SBL113001R8110	ASL12-30-10-81	5/9	1SBL137001R1322	AF09-30-22-13	3/38
1SBK104235R2000	DRAS09-20S	9/2	1SBL113001R8132	ASL12-30-32-81	5/11	1SBL137001R1401	AF09-30-01-14	3/14
1SBK104335R8100	DRASL09-81S	9/2	1SBL113004R8101	ASL12-30-01S-81	5/57	1SBL137001R1410	AF09-30-10-14	3/14
1SBK104335R8300	DRASL09-83S	9/2	1SBL113004R8110	ASL12-30-10S-81	5/57	1SBL137001R1422	AF09-30-22-14	3/38
1SBK114035R2800	DRAS12-28P	9/2	1SBL113004R8132	ASL12-30-32S-81	5/59	1SBL137005R1101	AF09-30-01K-11	3/90
1SBK114035R2900	DRAS12-29P	9/2	1SBL121001R2001	AS16-30-01-20	5/8	1SBL137005R1110	AF09-30-10K-11	3/90
1SBK114135R2600	DRAS12-26N	9/2	1SBL121001R2010	AS16-30-10-20	5/8	1SBL137005R1201	AF09-30-01K-12	3/90
1SBK114135R2700	DRAS12-27N	9/2	1SBL121001R2032	AS16-30-32-20	5/10	1SBL137005R1210	AF09-30-10K-12	3/90
1SBK114235R2000	DRAS12-20S	9/2	1SBL121001R2601	AS16-30-01-26	5/8	1SBL137005R1301	AF09-30-01K-13	3/90
1SBK114335R8100	DRASL12-81S	9/2	1SBL121001R2610	AS16-30-10-26	5/8	1SBL137005R1310	AF09-30-10K-13	3/90
1SBK114335R8300	DRASL12-83S	9/2	1SBL121001R2632	AS16-30-32-26	5/10	1SBL137005R1401	AF09-30-01K-14	3/90
1SBK124035R2800	DRAS16-28P	9/2	1SBL121004R2001	AS16-30-01S-20	5/56	1SBL137005R1410	AF09-30-10K-14	3/90
1SBK124035R2900	DRAS16-29P	9/2	1SBL121004R2010	AS16-30-10S-20	5/56	1SBL137082R1122	AFS09-30-22-11	3/114
1SBK124135R2600	DRAS16-26N	9/2	1SBL121004R2032	AS16-30-32S-20	5/58	1SBL137082R1322	AFS09-30-22-13	3/114
1SBK124135R2700	DRAS16-27N	9/2	1SBL121004R2601	AS16-30-01S-26	5/56	1SBL137201R1100	AF09-40-00-11	3/134
1SBK124235R2000	DRAS16-20S	9/2	1SBL121004R2610	AS16-30-10S-26	5/56	1SBL137201R1200	AF09-40-00-12	3/134
1SBK124335R8100	DRASL16-81S	9/2	1SBL121004R2632	AS16-30-32S-26	5/58	1SBL137201R1300	AF09-40-00-13	3/134
1SBK124335R8300	DRASL16-83S	9/2	1SBL123001R8101	ASL16-30-01-81	5/9	1SBL137201R1400	AF09-40-00-14	3/134
1SBK134037R1400	DRAF09-14P	9/8	1SBL123001R8110	ASL16-30-10-81	5/9	1SBL137501R1100	AF09-22-00-11	3/134
1SBK134137R1300	DRAF09-13N	9/8	1SBL123001R8132	ASL16-30-32-81	5/11	1SBL137501R1200	AF09-22-00-12	3/134
1SBK134237R1100	DRAF09-11S	9/8	1SBL123004R8101	ASL16-30-01S-81	5/57	1SBL137501R1300	AF09-22-00-13	3/134
1SBK134238R1100	DRAF09-11U	9/8	1SBL123004R8110	ASL16-30-10S-81	5/57	1SBL137501R1400	AF09-22-00-14	3/134
1SBK134238R1300	DRAF09-13U	9/8	1SBL123004R8132	ASL16-30-32S-81	5/59	1SBL156001R1110	AF12Z-30-10-11	12/6
1SBK134238R1400	DRAF09-14U	9/8	1SBL136001R1110	AF09Z-30-10-11	12/6	1SBL156001R2001	AF12Z-30-01-20	3/16
1SBK154037R1400	DRAF12-14P	9/8	1SBL136001R2001	AF09Z-30-01-20	3/16	1SBL156001R2010	AF12Z-30-10-20	3/16
1SBK154137R1300	DRAF12-13N	9/8	1SBL136001R2010	AF09Z-30-10-20	3/16	1SBL156001R2022	AF12Z-30-22-20	3/39
1SBK154237R1100	DRAF12-11S	9/8	1SBL136001R2022	AF09Z-30-22-20	3/39	1SBL156001R2101	AF12Z-30-01-21	3/16
1SBK154238R1100	DRAF12-11U	9/8	1SBL136001R2101	AF09Z-30-01-21	3/16	1SBL156001R2110	AF12Z-30-10-21	3/16
1SBK154238R1300	DRAF12-13U	9/8	1SBL136001R2110	AF09Z-30-10-21	3/16	1SBL156001R2122	AF12Z-30-22-21	3/39
1SBK154238R1400	DRAF12-14U	9/8	1SBL136001R2122	AF09Z-30-22-21	3/39	1SBL156001R2201	AF12Z-30-01-22	3/16
1SBK174037R1400	DRAF16-14P	9/8	1SBL136001R2201	AF09Z-30-01-22	3/16	1SBL156001R2210	AF12Z-30-10-22	3/16
1SBK174137R1300	DRAF16-13N	9/8	1SBL136001R2210	AF09Z-30-10-22	3/16	1SBL156001R2222	AF12Z-30-22-22	3/39
1SBK174237R1100	DRAF16-11S	9/8	1SBL136001R2222	AF09Z-30-22-22	3/39	1SBL156001R2301	AF12Z-30-01-23	3/16
1SBK174238R1100	DRAF16-11U	9/8	1SBL136001R2301	AF09Z-30-01-23	3/16	1SBL156001R2310	AF12Z-30-10-23	3/16
1SBK174238R1300	DRAF16-13U	9/8	1SBL136001R2310	AF09Z-30-10-23	3/16	1SBL156001R2322	AF12Z-30-22-23	3/39
1SBK174238R1400	DRAF16-14U	9/8	1SBL136001R2322	AF09Z-30-22-23	3/39	1SBL156001R3001	AF12Z-30-01-30	3/15
1SBL101001R2001	AS09-30-01-20	5/8	1SBL136001R3001	AF09Z-30-01-30	3/15	1SBL156001R3010	AF12Z-30-10-30	3/15
1SBL101001R2010	AS09-30-10-20	5/8	1SBL136001R3010	AF09Z-30-10-30	3/15	1SBL156005R2001	AF12Z-30-01K-20	3/92
1SBL101001R2032	AS09-30-32-20	5/10	1SBL136005R2001	AF09Z-30-01K-20	3/92	1SBL156005R2010	AF12Z-30-10K-20	3/92
1SBL101001R2601	AS09-30-01-26	5/8	1SBL136005R2010	AF09Z-30-10K-20	3/92	1SBL156005R2101	AF12Z-30-01K-21	3/92
1SBL101001R2610	AS09-30-10-26	5/8	1SBL136005R2101	AF09Z-30-01K-21	3/92	1SBL156005R2110	AF12Z-30-10K-21	3/92
1SBL101001R2632	AS09-30-32-26	5/10	1SBL136005R2110	AF09Z-30-10K-21	3/92	1SBL156005R2201	AF12Z-30-01K-22	3/92
1SBL101004R2001	AS09-30-01S-20	5/56	1SBL136005R2201	AF09Z-30-01K-22	3/92	1SBL156005R2210	AF12Z-30-10K-22	3/92
1SBL101004R2010	AS09-30-10S-20	5/56	1SBL136005R2210	AF09Z-30-10K-22	3/92	1SBL156005R2301	AF12Z-30-01K-23	3/92
1SBL101004R2032	AS09-30-32S-20	5/58	1SBL136005R2301	AF09Z-30-01K-23	3/92	1SBL156005R2310	AF12Z-30-10K-23	3/92



# Index

## Order code classification

Order code	Type	Page
1SBL156005R3001	AF12Z-30-01K-30	3/91
1SBL156005R3010	AF12Z-30-10K-30	3/91
1SBL156082R3022	AFS12Z-30-22-30	3/114
1SBL157001R1101	AF12-30-01-11	3/14
1SBL157001R1110	AF12-30-10-11	3/14
1SBL157001R1122	AF12-30-22-11	3/38
1SBL157001R1201	AF12-30-01-12	3/14
1SBL157001R1210	AF12-30-10-12	3/14
1SBL157001R1222	AF12-30-22-12	3/38
1SBL157001R1301	AF12-30-01-13	3/14
1SBL157001R1310	AF12-30-10-13	3/14
1SBL157001R1322	AF12-30-22-13	3/38
1SBL157001R1401	AF12-30-01-14	3/14
1SBL157001R1410	AF12-30-10-14	3/14
1SBL157001R1422	AF12-30-22-14	3/38
1SBL157005R1101	AF12-30-01K-11	3/90
1SBL157005R1110	AF12-30-10K-11	3/90
1SBL157005R1201	AF12-30-01K-12	3/90
1SBL157005R1210	AF12-30-10K-12	3/90
1SBL157005R1220	AF12-30-10K-12	3/90
1SBL157005R1301	AF12-30-01K-13	3/90
1SBL157005R1310	AF12-30-10K-13	3/90
1SBL157005R1320	AF12-30-10K-13	3/90
1SBL157005R1401	AF12-30-01K-14	3/90
1SBL157005R1410	AF12-30-10K-14	3/90
1SBL157082R1122	AFS12-30-22-11	3/114
1SBL157082R1322	AFS12-30-22-13	3/114
1SBL176001R1110	AF16Z-30-10-11	12/6
1SBL176001R2001	AF16Z-30-01-20	3/16
1SBL176001R2010	AF16Z-30-10-20	3/16
1SBL176001R2022	AF16Z-30-22-20	3/39
1SBL176001R2101	AF16Z-30-01-21	3/16
1SBL176001R2110	AF16Z-30-10-21	3/16
1SBL176001R2122	AF16Z-30-22-21	3/39
1SBL176001R2201	AF16Z-30-01-22	3/16
1SBL176001R2210	AF16Z-30-10-22	3/16
1SBL176001R2222	AF16Z-30-22-22	3/39
1SBL176001R2301	AF16Z-30-01-23	3/16
1SBL176001R2310	AF16Z-30-10-23	3/16
1SBL176001R2322	AF16Z-30-22-23	3/39
1SBL176001R3001	AF16Z-30-01-30	3/15
1SBL176001R3010	AF16Z-30-10-30	3/15
1SBL176005R2001	AF16Z-30-01K-20	3/92
1SBL176005R2010	AF16Z-30-10K-20	3/92
1SBL176005R2101	AF16Z-30-01K-21	3/92
1SBL176005R2110	AF16Z-30-10K-21	3/92
1SBL176005R2201	AF16Z-30-01K-22	3/92
1SBL176005R2210	AF16Z-30-10K-22	3/92
1SBL176005R2301	AF16Z-30-01K-23	3/92
1SBL176005R2310	AF16Z-30-10K-23	3/92
1SBL176005R3001	AF16Z-30-01K-30	3/91
1SBL176005R3010	AF16Z-30-10K-30	3/91
1SBL176082R3022	AFS16Z-30-22-30	3/114
1SBL176201R2000	AF16Z-40-00-20	3/136
1SBL176201R2100	AF16Z-40-00-21	3/136
1SBL176201R2200	AF16Z-40-00-22	3/136
1SBL176201R2300	AF16Z-40-00-23	3/136
1SBL176201R3000	AF16Z-40-00-30	3/135
1SBL176501R2000	AF16Z-22-00-20	3/136
1SBL176501R2100	AF16Z-22-00-21	3/136
1SBL176501R2200	AF16Z-22-00-22	3/136
1SBL176501R2300	AF16Z-22-00-23	3/136
1SBL176501R3000	AF16Z-22-00-30	3/135
1SBL177001R1101	AF16-30-01-11	3/14
1SBL177001R1110	AF16-30-10-11	3/14
1SBL177001R1122	AF16-30-22-11	3/38
1SBL177001R1201	AF16-30-01-12	3/14
1SBL177001R1210	AF16-30-10-12	3/14
1SBL177001R1222	AF16-30-22-12	3/38

Order code	Type	Page
1SBL177001R1301	AF16-30-01-13	3/14
1SBL177001R1310	AF16-30-10-13	3/14
1SBL177001R1322	AF16-30-22-13	3/38
1SBL177001R1401	AF16-30-01-14	3/14
1SBL177001R1410	AF16-30-10-14	3/14
1SBL177001R1422	AF16-30-22-14	3/38
1SBL177005R1101	AF16-30-01K-11	3/90
1SBL177005R1110	AF16-30-10K-11	3/90
1SBL177005R1201	AF16-30-01K-12	3/90
1SBL177005R1210	AF16-30-10K-12	3/90
1SBL177005R1301	AF16-30-01K-13	3/90
1SBL177005R1310	AF16-30-10K-13	3/90
1SBL177005R1401	AF16-30-01K-14	3/90
1SBL177005R1410	AF16-30-10K-14	3/90
1SBL177082R1122	AFS16-30-22-11	3/114
1SBL177082R1322	AFS16-30-22-13	3/114
1SBL177201R1100	AF16-40-00-11	3/134
1SBL177201R1200	AF16-40-00-12	3/134
1SBL177201R1300	AF16-40-00-13	3/134
1SBL177201R1400	AF16-40-00-14	3/134
1SBL177501R1100	AF16-22-00-11	3/134
1SBL177501R1200	AF16-22-00-12	3/134
1SBL177501R1300	AF16-22-00-13	3/134
1SBL177501R1400	AF16-22-00-14	3/134
1SBL181022R8010	UA16-30-10	3/200
1SBL181022R8110	UA16-30-10	3/200
1SBL181022R8310	UA16-30-10	3/200
1SBL181022R8410	UA16-30-10	3/200
1SBL181022R8510	UA16-30-10	3/200
1SBL181022R8610	UA16-30-10	3/200
1SBL181022R8810	UA16-30-10	3/200
1SBL181024R8010	UA16-30-10RA	3/194
1SBL181024R8110	UA16-30-10RA	3/194
1SBL181024R8410	UA16-30-10RA	3/194
1SBL181024R8510	UA16-30-10RA	3/194
1SBL181024R8610	UA16-30-10RA	3/194
1SBL181024R8810	UA16-30-10RA	3/194
1SBL236001R1100	AF26Z-30-00-11	12/6
1SBL236001R2000	AF26Z-30-00-20	3/16
1SBL236001R2011	AF26Z-30-11-20	3/25
1SBL236001R2022	AF26Z-30-22-20	3/39
1SBL236001R2100	AF26Z-30-00-21	3/16
1SBL236001R2111	AF26Z-30-11-21	3/25
1SBL236001R2122	AF26Z-30-22-21	3/39
1SBL236001R2200	AF26Z-30-00-22	3/16
1SBL236001R2211	AF26Z-30-11-22	3/25
1SBL236001R2222	AF26Z-30-22-22	3/39
1SBL236001R2300	AF26Z-30-00-23	3/16
1SBL236001R2311	AF26Z-30-11-23	3/25
1SBL236001R2322	AF26Z-30-22-23	3/39
1SBL236001R3000	AF26Z-30-00-30	3/15
1SBL236005R2000	AF26Z-30-00K-20	3/92
1SBL236005R2100	AF26Z-30-00K-21	3/92
1SBL236005R2200	AF26Z-30-00K-22	3/92
1SBL236005R2300	AF26Z-30-00K-23	3/92
1SBL236005R3000	AF26Z-30-00K-30	3/91
1SBL236082R3022	AFS26Z-30-22-30	3/114
1SBL236201R2000	AF26Z-40-00-20	3/136
1SBL236201R2100	AF26Z-40-00-21	3/136
1SBL236201R2200	AF26Z-40-00-22	3/136
1SBL236201R2300	AF26Z-40-00-23	3/136
1SBL236501R2000	AF26Z-22-00-20	3/136
1SBL236501R2100	AF26Z-22-00-21	3/136
1SBL236501R2200	AF26Z-22-00-22	3/136
1SBL236501R2300	AF26Z-22-00-23	3/136
1SBL237001R1100	AF26-30-00-11	3/14
1SBL237001R1111	AF26-30-11-11	3/24

Order code	Type	Page
1SBL237001R1122	AF26-30-22-11	3/38
1SBL237001R1200	AF26-30-00-12	3/14
1SBL237001R1211	AF26-30-11-12	3/24
1SBL237001R1222	AF26-30-22-12	3/38
1SBL237001R1300	AF26-30-00-13	3/14
1SBL237001R1311	AF26-30-11-13	3/24
1SBL237001R1322	AF26-30-22-13	3/38
1SBL237001R1400	AF26-30-00-14	3/14
1SBL237001R1411	AF26-30-11-14	3/24
1SBL237001R1422	AF26-30-22-14	3/38
1SBL237005R1100	AF26-30-00K-11	3/90
1SBL237005R1200	AF26-30-00K-12	3/90
1SBL237005R1300	AF26-30-00K-13	3/90
1SBL237005R1400	AF26-30-00K-14	3/90
1SBL237082R1122	AFS26-30-22-11	3/114
1SBL237082R1322	AFS26-30-22-13	3/114
1SBL237201R1100	AF26-40-00-11	3/134
1SBL237201R1200	AF26-40-00-12	3/134
1SBL237201R1300	AF26-40-00-13	3/134
1SBL237201R1400	AF26-40-00-14	3/134
1SBL237501R1100	AF26-22-00-11	3/134
1SBL237501R1200	AF26-22-00-12	3/134
1SBL237501R1300	AF26-22-00-13	3/134
1SBL237501R1400	AF26-22-00-14	3/134
1SBL241022R8010	UA26-30-10	3/200
1SBL241022R8110	UA26-30-10	3/200
1SBL241022R8310	UA26-30-10	3/200
1SBL241022R8410	UA26-30-10	3/200
1SBL241022R8510	UA26-30-10	3/200
1SBL241022R8610	UA26-30-10	3/200
1SBL241022R8810	UA26-30-10	3/200
1SBL241024R8010	UA26-30-10RA	3/194
1SBL241024R8110	UA26-30-10RA	3/194
1SBL241024R8410	UA26-30-10RA	3/194
1SBL241024R8510	UA26-30-10RA	3/194
1SBL241024R8610	UA26-30-10RA	3/194
1SBL241024R8810	UA26-30-10RA	3/194
1SBL276001R1100	AF30Z-30-00-11	12/6
1SBL276001R2000	AF30Z-30-00-20	3/16
1SBL276001R2011	AF30Z-30-11-20	3/25
1SBL276001R2022	AF30Z-30-22-20	3/39
1SBL276001R2100	AF30Z-30-00-21	3/16
1SBL276001R2111	AF30Z-30-11-21	3/25
1SBL276001R2122	AF30Z-30-22-21	3/39
1SBL276001R2200	AF30Z-30-00-22	3/16
1SBL276001R2211	AF30Z-30-11-22	3/25
1SBL276001R2222	AF30Z-30-22-22	3/39
1SBL276001R2300	AF30Z-30-00-23	3/16
1SBL276001R2311	AF30Z-30-11-23	3/25
1SBL276001R2322	AF30Z-30-22-23	3/39
1SBL276001R3000	AF30Z-30-00-30	3/15
1SBL276005R2000	AF30Z-30-00K-20	3/92
1SBL276005R2100	AF30Z-30-00K-21	3/92
1SBL276005R2200	AF30Z-30-00K-22	3/92
1SBL276005R2300	AF30Z-30-00K-23	3/92
1SBL276005R3000	AF30Z-30-00K-30	3/91
1SBL276082R3022	AFS30Z-30-22-30	3/114
1SBL277001R1100	AF30-30-00-11	3/14
1SBL277001R1111	AF30-30-11-11	3/24
1SBL277001R1122	AF30-30-22-11	3/38
1SBL277001R1200	AF30-30-00-12	3/14
1SBL277001R1211	AF30-30-11-12	3/24
1SBL277001R1222	AF30-30-22-12	3/38
1SBL277001R1300	AF30-30-00-13	3/14
1SBL277001R1311	AF30-30-11-13	3/24
1SBL277001R1322	AF30-30-22-13	3/38
1SBL277001R1400	AF30-30-00-14	3/14

# Index

## Order code classification

Order code	Type	Page	Order code	Type	Page	Order code	Type	Page
1SBL277001R1411	AF30-30-11-14	3/24	1SBL297201R1100	AF38-40-00-11	3/134	1SBL371022R8800	UA63-30-00	3/201
1SBL277001R1422	AF30-30-22-14	3/38	1SBL297201R1200	AF38-40-00-12	3/134	1SBL371024R8000	UA63-30-00RA	3/195
1SBL277005R1100	AF30-30-00K-11	3/90	1SBL297201R1300	AF38-40-00-13	3/134	1SBL371024R8100	UA63-30-00RA	3/195
1SBL277005R1200	AF30-30-00K-12	3/90	1SBL297201R1400	AF38-40-00-14	3/134	1SBL371024R8400	UA63-30-00RA	3/195
1SBL277005R1300	AF30-30-00K-13	3/90	1SBL297501R1100	AF38-22-00-11	3/134	1SBL371024R8500	UA63-30-00RA	3/195
1SBL277005R1400	AF30-30-00K-14	3/90	1SBL297501R1200	AF38-22-00-12	3/134	1SBL371024R8600	UA63-30-00RA	3/195
1SBL277082R1122	AFS30-30-22-11	3/114	1SBL297501R1300	AF38-22-00-13	3/134	1SBL371024R8800	UA63-30-00RA	3/195
1SBL277082R1322	AFS30-30-22-13	3/114	1SBL297501R1400	AF38-22-00-14	3/134	1SBL387001R1100	AF65-30-00-11	3/17
1SBL281022R8010	UA30-30-10	3/200	1SBL347001R1100	AF40-30-00-11	3/17	1SBL387001R1111	AF65-30-11-11	3/27
1SBL281022R8110	UA30-30-10	3/200	1SBL347001R1111	AF40-30-11-11	3/27	1SBL387001R1122	AF65-30-22-11	3/40
1SBL281022R8310	UA30-30-10	3/200	1SBL347001R1222	AF40-30-22-11	3/40	1SBL387001R1200	AF65-30-00-12	3/17
1SBL281022R8410	UA30-30-10	3/200	1SBL347001R1200	AF40-30-00-12	3/17	1SBL387001R1211	AF65-30-11-12	3/27
1SBL281022R8510	UA30-30-10	3/200	1SBL347001R1211	AF40-30-11-12	3/27	1SBL387001R1222	AF65-30-22-12	3/40
1SBL281022R8610	UA30-30-10	3/200	1SBL347001R1222	AF40-30-22-12	3/40	1SBL387001R1300	AF65-30-00-13	3/17
1SBL281022R8810	UA30-30-10	3/200	1SBL347001R1300	AF40-30-00-13	3/17	1SBL387001R1311	AF65-30-11-13	3/27
1SBL281024R8010	UA30-30-10RA	3/194	1SBL347001R1311	AF40-30-11-13	3/27	1SBL387001R1322	AF65-30-22-13	3/40
1SBL281024R8110	UA30-30-10RA	3/194	1SBL347001R1322	AF40-30-22-13	3/40	1SBL387001R1400	AF65-30-00-14	3/17
1SBL281024R8410	UA30-30-10RA	3/194	1SBL347001R1400	AF40-30-00-14	3/17	1SBL387001R1411	AF65-30-11-14	3/27
1SBL281024R8510	UA30-30-10RA	3/194	1SBL347001R1411	AF40-30-11-14	3/27	1SBL387001R1422	AF65-30-22-14	3/40
1SBL281024R8610	UA30-30-10RA	3/194	1SBL347001R1422	AF40-30-22-14	3/40	1SBL387082R1122	AFS65-30-22-11	3/115
1SBL281024R8810	UA30-30-10RA	3/194	1SBL347082R1122	AFS40-30-22-11	3/115	1SBL387082R1322	AFS65-30-22-13	3/115
1SBL296001R1100	AF38Z-30-00-11	12/36	1SBL347082R1322	AFS40-30-22-13	3/115	1SBL397001R1100	AF80-30-00-11	3/17
1SBL296001R2000	AF38Z-30-00-20	3/16	1SBL347201R1100	AF40-40-00-11	3/137	1SBL397001R1111	AF80-30-11-11	3/27
1SBL296001R2011	AF38Z-30-11-20	3/25	1SBL347201R1200	AF40-40-00-12	3/137	1SBL397001R1122	AF80-30-22-11	3/40
1SBL296001R2022	AF38Z-30-22-20	3/39	1SBL347201R1300	AF40-40-00-13	3/137	1SBL397001R1200	AF80-30-00-12	3/17
1SBL296001R2100	AF38Z-30-00-21	3/16	1SBL347201R1400	AF40-40-00-14	3/137	1SBL397001R1211	AF80-30-11-12	3/27
1SBL296001R2111	AF38Z-30-11-21	3/25	1SBL347501R1100	AF40-22-00-11	3/137	1SBL397001R1222	AF80-30-22-12	3/40
1SBL296001R2122	AF38Z-30-22-21	3/39	1SBL347501R1200	AF40-22-00-12	3/137	1SBL397001R1300	AF80-30-00-13	3/17
1SBL296001R2200	AF38Z-30-00-22	3/16	1SBL347501R1300	AF40-22-00-13	3/137	1SBL397001R1311	AF80-30-11-13	3/27
1SBL296001R2211	AF38Z-30-11-22	3/25	1SBL347501R1400	AF40-22-00-14	3/137	1SBL397001R1322	AF80-30-22-13	3/40
1SBL296001R2222	AF38Z-30-22-22	3/39	1SBL351022R8000	UA50-30-00	3/201	1SBL397001R1400	AF80-30-00-14	3/17
1SBL296001R2300	AF38Z-30-00-23	3/16	1SBL351022R8100	UA50-30-00	3/201	1SBL397001R1411	AF80-30-11-14	3/27
1SBL296001R2311	AF38Z-30-11-23	3/25	1SBL351022R8300	UA50-30-00	3/201	1SBL397001R1422	AF80-30-22-14	3/40
1SBL296001R2322	AF38Z-30-22-23	3/39	1SBL351022R8400	UA50-30-00	3/201	1SBL397082R1122	AFS80-30-22-11	3/115
1SBL296001R3000	AF38Z-30-00-30	3/15	1SBL351022R8500	UA50-30-00	3/201	1SBL397082R1322	AFS80-30-22-13	3/115
1SBL296005R2000	AF38Z-30-00K-20	3/92	1SBL351022R8600	UA50-30-00	3/201	1SBL397201R1100	AF80-40-00-11	3/137
1SBL296005R2100	AF38Z-30-00K-21	3/92	1SBL351022R8800	UA50-30-00	3/201	1SBL397201R1200	AF80-40-00-12	3/137
1SBL296005R2200	AF38Z-30-00K-22	3/92	1SBL351024R8000	UA50-30-00RA	3/195	1SBL397201R1300	AF80-40-00-13	3/137
1SBL296005R2300	AF38Z-30-00K-23	3/92	1SBL351024R8100	UA50-30-00RA	3/195	1SBL397201R1400	AF80-40-00-14	3/137
1SBL296005R3000	AF38Z-30-00K-30	3/91	1SBL351024R8400	UA50-30-00RA	3/195	1SBL397501R1100	AF80-22-00-11	3/137
1SBL296082R3022	AFS38Z-30-22-30	3/114	1SBL351024R8500	UA50-30-00RA	3/195	1SBL397501R1200	AF80-22-00-12	3/137
1SBL296201R2000	AF38Z-40-00-20	3/136	1SBL351024R8600	UA50-30-00RA	3/195	1SBL397501R1300	AF80-22-00-13	3/137
1SBL296201R2100	AF38Z-40-00-21	3/136	1SBL351024R8800	UA50-30-00RA	3/195	1SBL397501R1400	AF80-22-00-14	3/137
1SBL296201R2200	AF38Z-40-00-22	3/136	1SBL367001R1100	AF52-30-00-11	3/17	1SBL407001R1100	AF96-30-00-11	3/17
1SBL296201R2300	AF38Z-40-00-23	3/136	1SBL367001R1111	AF52-30-11-11	3/27	1SBL407001R1111	AF96-30-11-11	3/27
1SBL296501R2000	AF38Z-22-00-20	3/136	1SBL367001R1122	AF52-30-22-11	3/40	1SBL407001R1122	AF96-30-22-11	3/40
1SBL296501R2100	AF38Z-22-00-21	3/136	1SBL367001R1200	AF52-30-00-12	3/17	1SBL407001R1200	AF96-30-00-12	3/17
1SBL296501R2200	AF38Z-22-00-22	3/136	1SBL367001R1211	AF52-30-11-12	3/27	1SBL407001R1211	AF96-30-11-12	3/27
1SBL296501R2300	AF38Z-22-00-23	3/136	1SBL367001R1222	AF52-30-22-12	3/40	1SBL407001R1222	AF96-30-22-12	3/40
1SBL297001R1100	AF38-30-00-11	3/14	1SBL367001R1300	AF52-30-00-13	3/17	1SBL407001R1300	AF96-30-00-13	3/17
1SBL297001R1111	AF38-30-11-11	3/24	1SBL367001R1311	AF52-30-11-13	3/27	1SBL407001R1311	AF96-30-11-13	3/27
1SBL297001R1122	AF38-30-22-11	3/38	1SBL367001R1322	AF52-30-22-13	3/40	1SBL407001R1322	AF96-30-22-13	3/40
1SBL297001R1200	AF38-30-00-12	3/14	1SBL367001R1400	AF52-30-00-14	3/17	1SBL407001R1400	AF96-30-00-14	3/17
1SBL297001R1211	AF38-30-11-12	3/24	1SBL367001R1411	AF52-30-11-14	3/27	1SBL407001R1411	AF96-30-11-14	3/27
1SBL297001R1222	AF38-30-22-12	3/38	1SBL367001R1422	AF52-30-22-14	3/40	1SBL407001R1422	AF96-30-22-14	3/40
1SBL297001R1300	AF38-30-00-13	3/14	1SBL367082R1122	AF552-30-22-11	3/115	1SBL407082R1122	AFS96-30-22-11	3/115
1SBL297001R1311	AF38-30-11-13	3/24	1SBL367082R1322	AFS52-30-22-13	3/115	1SBL407082R1322	AFS96-30-22-13	3/115
1SBL297001R1322	AF38-30-22-13	3/38	1SBL367201R1100	AF52-40-00-11	3/137	1SBL411022R8000	UA75-30-00	3/201
1SBL297001R1400	AF38-30-00-14	3/14	1SBL367201R1200	AF52-40-00-12	3/137	1SBL411022R8100	UA75-30-00	3/201
1SBL297001R1411	AF38-30-11-14	3/24	1SBL367201R1300	AF52-40-00-13	3/137	1SBL411022R8300	UA75-30-00	3/201
1SBL297001R1422	AF38-30-22-14	3/38	1SBL367201R1400	AF52-40-00-14	3/137	1SBL411022R8400	UA75-30-00	3/201
1SBL297005R1100	AF38-30-00K-11	3/90	1SBL371022R8000	UA63-30-00	3/201	1SBL411022R8500	UA75-30-00	3/201
1SBL297005R1200	AF38-30-00K-12	3/90	1SBL371022R8100	UA63-30-00	3/201	1SBL411022R8600	UA75-30-00	3/201
1SBL297005R1300	AF38-30-00K-13	3/90	1SBL371022R8300	UA63-30-00	3/201	1SBL411022R8800	UA75-30-00	3/201
1SBL297005R1400	AF38-30-00K-14	3/90	1SBL371022R8400	UA63-30-00	3/201	1SBL411024R8000	UA75-30-00RA	3/195
1SBL297082R1122	AFS38-30-22-11	3/114	1SBL371022R8500	UA63-30-00	3/201	1SBL411024R8100	UA75-30-00RA	3/195
1SBL297082R1322	AFS38-30-22-13	3/114	1SBL371022R8600	UA63-30-00	3/201	1SBL411024R8400	UA75-30-00RA	3/195



# Index

## Order code classification

Order code	Type	Page	Order code	Type	Page	Order code	Type	Page
1SBL411024R8500	UA75-30-00RA	3/195	1SBN010110T1001	CA4-01-T	3/230	1SBN030210R1000	VE5-2	3/282
1SBL411024R8600	UA75-30-00RA	3/195	1SBN010110T1010	CA4-10-T	3/230	1SBN031005T1000	VM3	5/13
1SBL411024R8800	UA75-30-00RA	3/195	1SBN010111R1001	CC4-01	3/230		BER16C-3	12/65
1SBL411025R8000	GA75-10-00	3/178	1SBN010111R1010	CC4-10	3/230		BEY16C-3	12/69
1SBL411025R8011	GA75-10-11	3/178	1SBN010120R1011	CAL4-11	3/230	1SBN033405T1000	VM96-4	3/248
1SBL411025R8100	GA75-10-00	3/178	1SBN010120T1011	CAL4-11-T	3/230		BER96-4	12/8
1SBL411025R8111	GA75-10-11	3/178	1SBN010134R1011	CAL4-11K	3/232		BEA65-4	12/8
1SBL411025R8300	GA75-10-00	3/178	1SBN010140R1004	CA4-04E	3/230		BER65-4	12/37
1SBL411025R8311	GA75-10-11	3/178	1SBN010140R1022	CA4-22E	3/230		BEY96-4	12/85
1SBL411025R8400	GA75-10-00	3/178	1SBN010140R1031	CA4-31E	3/230		BEY65-4	12/85
1SBL411025R8411	GA75-10-11	3/178	1SBN010140R1040	CA4-40E	3/230	1SBN040100R1010	WA4-10	3/254
1SBL411025R8500	GA75-10-00	3/178	1SBN010140R1104	CA4-04M	3/230	1SBN040100R1011	WA4-11	3/254
1SBL411025R8511	GA75-10-11	3/178	1SBN010140R1113	CA4-13M	3/230	1SBN040100R1012	WA4-12	3/254
1SBL411025R8600	GA75-10-00	3/178	1SBN010140R1122	CA4-22M	3/230	1SBN040100R1013	WA4-13	3/254
1SBL411025R8611	GA75-10-11	3/178	1SBN010140R1131	CA4-31M	3/230	1SBN040100R1014	WA4-14	3/254
1SBL411025R8800	GA75-10-00	3/178	1SBN010140R1204	CA4-04N	3/230	1SBN040200R1011	WA4-96-11	3/254
1SBL411025R8811	GA75-10-11	3/178	1SBN010140R1213	CA4-13N	3/230	1SBN040200R1012	WA4-96-12	3/254
1SBL419025R8000	GAE75-10-00	3/179	1SBN010140R1222	CA4-22N	3/230	1SBN040200R1013	WA4-96-13	3/254
1SBL419025R8011	GAE75-10-11	3/179	1SBN010140R1231	CA4-31N	3/230	1SBN040200R1014	WA4-96-14	3/254
1SBL419025R8100	GAE75-10-00	3/179	1SBN010140R1240	CA4-40N	3/230	1SBN050010R1000	RV5/50	3/286
1SBL419025R8111	GAE75-10-11	3/179	1SBN010140R1322	CA4-22U	3/230	1SBN050010R1001	RV5/133	3/286
1SBL419025R8300	GAE75-10-00	3/179	1SBN010140R1331	CA4-31U	3/230	1SBN050010R1002	RV5/250	3/286
1SBL419025R8311	GAE75-10-11	3/179	1SBN010140R1340	CA4-40U	3/230	1SBN050010R1003	RV5/440	3/286
1SBL419025R8600	GAE75-10-00	3/179	1SBN010146R1022	CA4-22EK	3/232	1SBN050020R1000	RT5/32	3/286
1SBL419025R8611	GAE75-10-11	3/179	1SBN010146R1031	CA4-31EK	3/232	1SBN050020R1001	RT5/65	3/286
1SBL419025R8700	GAE75-10-00	3/179	1SBN010146R1040	CA4-40EK	3/232	1SBN050020R1002	RT5/90	3/286
1SBL419025R8711	GAE75-10-11	3/179	1SBN010146R1104	CA4-04MK	3/232	1SBN050020R1003	RT5/150	3/286
1SBL419025R8800	GAE75-10-00	3/179	1SBN010146R1113	CA4-13MK	3/232	1SBN050020R1004	RT5/264	3/286
1SBL419025R8811	GAE75-10-11	3/179	1SBN010146R1122	CA4-22MK	3/232	1SBN050100R1000	RC5-1/50	5/13
1SBL419025R8900	GAE75-10-00	3/179	1SBN010146R1131	CA4-31MK	3/232	1SBN050100R1001	RC5-1/133	5/13
1SBL419025R8911	GAE75-10-11	3/179	1SBN010146R1204	CA4-04NK	3/232	1SBN050100R1002	RC5-1/250	5/13
1SBN010010R1001	CA5-01	3/272	1SBN010146R1213	CA4-13NK	3/232	1SBN050100R1003	RC5-1/440	5/13
1SBN010010R1010	CA5-10	3/272	1SBN010146R1222	CA4-22NK	3/232	1SBN050200R1000	RC5-2/50	3/286
1SBN010011R1001	CC5-01	3/272	1SBN010146R1231	CA4-31NK	3/232	1SBN050200R1001	RC5-2/133	3/286
1SBN010011R1010	CC5-10	3/272	1SBN010146R1240	CA4-40NK	3/232	1SBN050200R1002	RC5-2/250	3/286
1SBN010013R1001	CB5-01	3/250	1SBN010151R1011	CAT4-11E	3/230	1SBN050200R1003	RC5-2/440	3/286
1SBN010013R1010	CB5-10	3/250	1SBN010151R1111	CAT4-11M	3/230	1SBN060100R1000	RA4	3/252
1SBN010015R1001	CE5-01D0.1	3/234	1SBN010151R1111	CAT4-11M	3/230	1SBN060100T1000	RA4-T	3/252
1SBN010015R1010	CE5-10D0.1	3/234	1SBN010151R1311	CAT4-11U	3/230	1SBN060300R1000	RA5-1	3/288
1SBN010016R1001	CE5-01W0.1	3/234	1SBN010160R1001	CA4-01K	3/232	1SBN060300T1000	RA5-1	3/288
1SBN010016R1010	CE5-10W0.1	3/234	1SBN010160R1010	CA4-10K	3/232	1SBN070156T1000	LDC4	3/256
1SBN010017R1001	CE5-01D2	3/234	1SBN010160T1001	CA4-01K-T	3/232	1SBN070159T1000	LDC4K	3/256
1SBN010017R1010	CE5-10D2	3/234	1SBN010160T1010	CA4-10K-T	3/232	1SBN071303T1000	LY16-4	3/261
1SBN010018R1001	CE5-01W2	3/234	1SBN011010T1001	CA3-01	5/13	1SBN071305R1000	LF16-4	3/261
1SBN010018R1010	CE5-10W2	3/234	1SBN011010T1010	CA3-10	5/13	1SBN071306R1000	LG16-4	3/261
1SBN010020R1011	CAL5-11	3/272		BER16C-3	12/65	1SBN072303T1000	LY38-4	3/261
1SBN010040R1004	CA5-04E	3/272		KM1: 1 x CA3-10	12/69	1SBN072304R1000	LH38-4	3/261
1SBN010040R1018	CA5-11/11E	3/272	1SBN011019T1001	CA3-01S	5/61	1SBN072305R1000	LF38-4	3/261
1SBN010040R1022	CA5-22E	3/272	1SBN011019T1010	CA3-10S	5/61	1SBN072308R1000	LD38-4	3/258
1SBN010040R1031	CA5-31E	3/272	1SBN020112R1000	TEF4-ON	3/245	1SBN073508R1000	LD75	3/292
1SBN010040R1040	CA5-40E	3/272		CT-ERS.21S	12/85	1SBN073552R1002	LK75-F	3/293
1SBN010040R1104	CA5-04M	3/272	1SBN020113R1000	TEF4S-ON	3/245	1SBN073552R1003	LK75-L	3/293
1SBN010040R1113	CA5-13M	3/272	1SBN020114R1000	TEF4-OFF	3/245	1SBN080906R1001	BEA7/325	4/49
1SBN010040R1118	CA5-11/11M	3/272	1SBN020115R1000	TEF4S-OFF	3/245	1SBN080906R1002	BEA7/132	4/49
1SBN010040R1122	CA5-22M	3/272	1SBN020312R1000	TEF5-ON	3/278	1SBN081006T1000	BEA16-3	5/13
1SBN010040R1131	CA5-31M	3/272	1SBN020314R1000	TEF5-OFF	3/278	1SBN081012R1000	BER16C-3	5/13
1SBN010110R1001	CA4-01	3/230	1SBN021012R1000	TEF3-ON	5/13	1SBN081018R2000	BEY16C-3	5/13
	BER96-4	12/8	1SBN020104R1000	TEF3-OFF	5/13	1SBN081020R1000	BEA16-3U	5/61
	BEA65-4	12/8,	1SBN030105T1000	VM4	3/248	1SBN081306T1000	BEA16-4	3/262
	BER65-4	12/37	1SBN030111R1000	VEM4	3/248	1SBN081311R1000	BER16-4	3/262
	KM1 : 1 x CA4-10	12/85		BEA38-4	12/8		BEA16-4	12/8
1SBN010110R1010	CA4-10	3/230		BEA16-4	12/8	1SBN081313R2000	BEY16-4	3/263
	BEA65-4	12/6		BEA26-4	12/9	1SBN081321T1000	BEA16-4K	3/264
	BEA38-4	12/6		BER38-4	12/37	1SBN082306T1000	BEA26-4	3/262
	BEA26-4	12/7		BER16-4	12/37	1SBN082306T2000	BEA38-4	3/262
	BER96-4	12/8,		BEY38-4	12/85	1SBN082311R1000	BER38-4	3/262
	BER65-4	12/37		BEY16-4	12/85		BEA38-4	12/8
	BER38-4	12/37		KM1 : 1 x CA4-10	12/85		BEA26-4	12/9
	KM1 : 1 x CA4-10	12/85	1SBN030113R1000	VEM4K	3/264	1SBN082321T2000	BEA38-4K	3/264
	KM1 : 1 x CA4-10	12/85						

# Index

## Order code classification

Order code	Type	Page	Order code	Type	Page	Order code	Type	Page
1SBN082713R2000	BEY38-4	3/263	1SFL427001R1111	AF116-30-11-11	3/29	1SFL431024R8100	UA95-30-00RA	3/196
1SBN083406R1000	BEA65-4	3/262	1SFL427001R1122	AF116-30-22-11	3/42	1SFL431024R8400	UA95-30-00RA	3/196
1SBN083411R1000	BER65-4	3/262	1SFL427001R1200	AF116-30-00-12	3/19	1SFL431024R8500	UA95-30-00RA	3/196
	BEA65-4	12/8	1SFL427001R1211	AF116-30-11-12	3/29	1SFL431024R8600	UA95-30-00RA	3/196
1SBN083413R2000	BEY65-4	3/263	1SFL427001R1222	AF116-30-22-12	3/42	1SFL431024R8800	UA95-30-00RA	3/196
1SBN083911R1000	BER96-4	3/262	1SFL427001R1300	AF116-30-00-13	3/19	1SFL447001R1100	AF140-30-00-11	3/19
1SBN083913R2000	BEY96-4	3/263	1SFL427001R1311	AF116-30-11-13	3/29	1SFL447001R1111	AF140-30-11-11	3/29
1SBN101035R1000	FR16AS-12VARS	9/2	1SFL427001R1322	AF116-30-22-13	3/42	1SFL447001R1122	AF140-30-22-11	3/42
1SBN101337R1000	FR16AF-12	9/9	1SFL427001R1400	AF116-30-00-14	3/19	1SFL447001R1200	AF140-30-00-12	3/19
1SBN101338R1000	FR16AF-12U	9/9	1SFL427001R1411	AF116-30-11-14	3/29	1SFL447001R1211	AF140-30-11-12	3/29
1SBN110000R1000	BA5-50	3/256	1SFL427001R1422	AF116-30-22-14	3/42	1SFL447001R1222	AF140-30-22-12	3/42
1SBN110108T1000	BX4	3/256	1SFL427001R3300	AF116-30-00-33	3/20	1SFL447001R1300	AF140-30-00-13	3/19
1SBN110109W1000	BX4-CA	3/256	1SFL427001R3311	AF116-30-11-33	3/30	1SFL447001R1311	AF140-30-11-13	3/29
1SBN110120W1000	BB4	3/248	1SFL427001R3322	AF116-30-22-33	3/43	1SFL447001R1322	AF140-30-22-13	3/42
1SBN110122T1000	BDT4	3/257	1SFL427001R3400	AF116-30-00-34	3/20	1SFL447001R1400	AF140-30-00-14	3/19
1SBN111020R1000	BB3	5/50	1SFL427001R3411	AF116-30-11-34	3/30	1SFL447001R1411	AF140-30-11-14	3/29
1SBN111403R1000	BP16	3/285	1SFL427001R3422	AF116-30-22-34	3/43	1SFL447001R1422	AF140-30-22-13	3/42
1SBN112303T1000	BP38-4	3/257	1SFL427002R1100	AF116-30-00B-11	3/19	1SFL447001R3300	AF140-30-00-33	3/20
1SBN113403T1000	BP65-4	3/257	1SFL427002R1111	AF116-30-11B-11	3/29	1SFL447001R3311	AF140-30-11-33	3/30
1SBN113405R1000	BRP65-4	3/262	1SFL427002R1122	AF116-30-22B-11	3/42	1SFL447001R3322	AF140-30-22-33	3/43
	BEA65-4	12/6	1SFL427002R1200	AF116-30-00B-12	3/19	1SFL447001R3400	AF140-30-00-34	3/20
1SBN113903T1000	BP96-4	3/257	1SFL427002R1211	AF116-30-11B-12	3/29	1SFL447001R3411	AF140-30-11-34	3/30
1SBN123401R1000	LT65-30	3/259	1SFL427002R1222	AF116-30-22B-12	3/42	1SFL447001R3422	AF140-30-22-34	3/43
1SBN123402R1000	LT52-40	3/259	1SFL427002R1300	AF116-30-00B-13	3/19	1SFL447002R1100	AF140-30-00B-11	3/19
1SBN123901R1000	LT96-30	3/259	1SFL427002R1311	AF116-30-11B-13	3/29	1SFL447002R1111	AF140-30-11B-11	3/29
1SBN123902R1000	LT80-40	3/259	1SFL427002R1322	AF116-30-22B-13	3/42	1SFL447002R1122	AF140-30-22B-11	3/42
1SBN151410R8006	ZA16	3/295	1SFL427002R1400	AF116-30-00B-14	3/19	1SFL447002R1200	AF140-30-00B-12	3/19
1SBN151410R8106	ZA16	3/295	1SFL427002R1411	AF116-30-11B-14	3/29	1SFL447002R1211	AF140-30-11B-12	3/29
1SBN151410R8406	ZA16	3/295	1SFL427002R1422	AF116-30-22B-14	3/42	1SFL447002R1222	AF140-30-22B-12	3/42
1SBN151410R8506	ZA16	3/295	1SFL427002R3300	AF116-30-00B-33	3/20	1SFL447002R1300	AF140-30-00B-13	3/19
1SBN151410R8606	ZA16	3/295	1SFL427002R3311	AF116-30-11B-33	3/30	1SFL447002R1311	AF140-30-11B-13	3/29
1SBN151410R8806	ZA16	3/295	1SFL427002R3322	AF116-30-22B-33	3/43	1SFL447002R1322	AF140-30-22B-13	3/42
1SBN152410R8006	ZA40	3/295	1SFL427002R3400	AF116-30-00B-34	3/20	1SFL447002R1400	AF140-30-00B-14	3/19
1SBN152410R8106	ZA40	3/295	1SFL427002R3411	AF116-30-11B-34	3/30	1SFL447002R1411	AF140-30-11B-14	3/29
1SBN152410R8406	ZA40	3/295	1SFL427002R3422	AF116-30-22B-34	3/43	1SFL447002R1422	AF140-30-22B-14	3/42
1SBN152410R8506	ZA40	3/295	1SFL427101R1100	AF116-40-00-11	3/139	1SFL447002R3300	AF140-30-00B-33	3/20
1SBN152410R8606	ZA40	3/295	1SFL427101R1111	AF116-40-11-11	3/142	1SFL447002R3311	AF140-30-11B-33	3/30
1SBN152410R8806	ZA40	3/295	1SFL427101R1122	AF116-40-22-11	3/145	1SFL447002R3322	AF140-30-22B-33	3/43
1SBN153510R8006	ZA75	3/295	1SFL427101R1200	AF116-40-00-12	3/139	1SFL447002R3400	AF140-30-00B-34	3/20
1SBN153510R8106	ZA75	3/295	1SFL427101R1211	AF116-40-11-12	3/142	1SFL447002R3411	AF140-30-11B-34	3/30
1SBN153510R8406	ZA75	3/295	1SFL427101R1222	AF116-40-22-12	3/145	1SFL447002R3422	AF140-30-22B-34	3/43
1SBN153510R8506	ZA75	3/295	1SFL427101R1300	AF116-40-00-13	3/139	1SFL447101R1100	AF140-40-00-11	3/139
1SBN153510R8606	ZA75	3/295	1SFL427101R1311	AF116-40-11-13	3/142	1SFL447101R1111	AF140-40-11-11	3/142
1SBN153510R8806	ZA75	3/295	1SFL427101R1322	AF116-40-22-13	3/145	1SFL447101R1122	AF140-40-22-11	3/145
1SBN163502R1000	ZLU50	3/295	1SFL427101R1400	AF116-40-00-14	3/139	1SFL447101R1200	AF140-40-00-12	3/139
1SBN163702R1000	ZLU63	3/295	1SFL427101R1411	AF116-40-11-14	3/142	1SFL447101R1211	AF140-40-11-12	3/142
1SBN164102R1000	ZLU75	3/295	1SFL427101R1422	AF116-40-22-14	3/145	1SFL447101R1222	AF140-40-22-12	3/145
1SCA101647R1001	OXS6X85	2/45	1SFL427102R1100	AF116-40-00B-11	3/139	1SFL447101R1300	AF140-40-00-13	3/139
1SCA101655R1001	OXS6X130	2/45	1SFL427102R1111	AF116-40-11B-11	3/142	1SFL447101R1311	AF140-40-11-13	3/142
1SCA101659R1001	OXS6X180	2/45	1SFL427102R1122	AF116-40-22B-11	3/145	1SFL447101R1322	AF140-40-22-13	3/145
1SCA108043R1001	OXS6X105	2/45	1SFL427102R1200	AF116-40-00B-12	3/139	1SFL447101R1400	AF140-40-00-14	3/139
1SDA054126R1	T45 320 PR221-I ln320	12/23	1SFL427102R1211	AF116-40-11B-12	3/142	1SFL447101R1411	AF140-40-11-14	3/142
1SDA054335R1	T55 400 PR221-I ln400	12/23	1SFL427102R1222	AF116-40-22B-12	3/145	1SFL447101R1422	AF140-40-22-14	3/145
1SDA054405R1	T55 630 PR221-I ln630	12/23	1SFL427102R1300	AF116-40-00B-13	3/139	1SFL447102R1100	AF140-40-00B-11	3/139
1SDA054527R1	T45 250 PR222MP ln200	12/21	1SFL427102R1311	AF116-40-11B-13	3/142	1SFL447102R1111	AF140-40-11B-11	3/142
1SDA054553R1	T55 400 PR222MP ln320	12/21	1SFL427102R1322	AF116-40-22B-13	3/145	1SFL447102R1122	AF140-40-22B-11	3/145
1SDA054554R1	T55 400 PR222MP ln400	12/21	1SFL427102R1400	AF116-40-00B-14	3/139	1SFL447102R1200	AF140-40-00B-12	3/139
1SDA054988R1	EN_DASH	3/70	1SFL427102R1411	AF116-40-11B-14	3/142	1SFL447102R1211	AF140-40-11B-12	3/142
1SDA055016R1	1SDA066917R1	3/70	1SFL427102R1422	AF116-40-22B-14	3/145	1SFL447102R1222	AF140-40-22B-12	3/145
1SDA055020R1	1SDA054988R1	3/70	1SFL431022R8000	UA95-30-00	3/202	1SFL447102R1300	AF140-40-00B-13	3/139
1SDA067355R1	Ekip M-LIU ln160	12/21	1SFL431022R8100	UA95-30-00	3/202	1SFL447102R1311	AF140-40-11B-13	3/142
1SDA068164R1	XT25 160	12/21	1SFL431022R8300	UA95-30-00	3/202	1SFL447102R1322	AF140-40-22B-13	3/145
1SDA068480R1	XT45 250 Ekip I ln250	12/23	1SFL431022R8400	UA95-30-00	3/202	1SFL447102R1400	AF140-40-00B-14	3/139
1SDA076530R1	XT25 160 MA 160	12/23	1SFL431022R8500	UA95-30-00	3/202	1SFL447102R1411	AF140-40-11B-14	3/142
1SFA616162R1014	KPR-101L	6/4	1SFL431022R8600	UA95-30-00	3/202	1SFL447102R1422	AF140-40-22B-14	3/145
1SFA739001R1001	EF1250DU-1250	6/41	1SFL431022R8800	UA95-30-00	3/202	1SFL451022R8000	UA110-30-00	3/202
1SFL427001R1100	AF116-30-00-11	3/19	1SFL431024R8000	UA95-30-00RA	3/196	1SFL451022R8100	UA110-30-00	3/202

# Index

## Order code classification

Order code	Type	Page	Order code	Type	Page	Order code	Type	Page
1SFL451022R8300	UA110-30-00	3/202	1SFL487102R1122	AF190-40-22-11	3/146	1SFL547102R1300	AF265-40-00-13	3/140
1SFL451022R8400	UA110-30-00	3/202	1SFL487102R1200	AF190-40-00-12	3/140	1SFL547102R1311	AF265-40-11-13	3/143
1SFL451022R8500	UA110-30-00	3/202	1SFL487102R1211	AF190-40-11-12	3/143	1SFL547102R1322	AF265-40-22-13	3/146
1SFL451022R8600	UA110-30-00	3/202	1SFL487102R1222	AF190-40-22-12	3/146	1SFL547102R1400	AF265-40-00-14	3/140
1SFL451022R8800	UA110-30-00	3/202	1SFL487102R1300	AF190-40-00-13	3/140	1SFL547102R1411	AF265-40-11-14	3/143
1SFL451024R8000	UA110-30-00RA	3/196	1SFL487102R1311	AF190-40-11-13	3/143	1SFL547102R1422	AF265-40-22-14	3/146
1SFL451024R8100	UA110-30-00RA	3/196	1SFL487102R1322	AF190-40-22-13	3/146	1SFL557025R6911	GAF300-10-11	3/180
1SFL451024R8400	UA110-30-00RA	3/196	1SFL487102R1400	AF190-40-00-14	3/140	1SFL557025R7011	GAF300-10-11	3/180
1SFL451024R8500	UA110-30-00RA	3/196	1SFL487102R1411	AF190-40-11-14	3/143	1SFL557025R7211	GAF300-10-11	3/180
1SFL451024R8600	UA110-30-00RA	3/196	1SFL487102R1422	AF190-40-22-14	3/146	1SFL577001R6811	AF400-30-11	3/34
1SFL451024R8800	UA110-30-00RA	3/196	1SFL497025R6911	GAF185-10-11	3/180	1SFL577001R6822	AF400-30-22	3/47
1SFL467001R1100	AF146-30-00-11	3/19	1SFL497025R7011	GAF185-10-11	3/180	1SFL577001R6911	AF400-30-11	3/34
1SFL467001R1111	AF146-30-11-11	3/29	1SFL497025R7211	GAF185-10-11	3/180	1SFL577001R6922	AF400-30-22	3/47
1SFL467001R1122	AF146-30-22-11	3/42	1SFL527002R1100	AF205-30-00-11	3/21	1SFL577001R7011	AF400-30-11	3/34
1SFL467001R1200	AF146-30-00-12	3/19	1SFL527002R1111	AF205-30-11-11	3/31	1SFL577001R7022	AF400-30-22	3/47
1SFL467001R1211	AF146-30-11-12	3/29	1SFL527002R1122	AF205-30-22-11	3/44	1SFL577001R7111	AF400-30-11	3/34
1SFL467001R1222	AF146-30-22-12	3/42	1SFL527002R1200	AF205-30-00-12	3/21	1SFL577001R7122	AF400-30-22	3/47
1SFL467001R1300	AF146-30-00-13	3/19	1SFL527002R1211	AF205-30-11-12	3/31	1SFL587002R1100	AF305-30-00-11	3/21
1SFL467001R1311	AF146-30-11-13	3/29	1SFL527002R1222	AF205-30-22-12	3/44	1SFL587002R1111	AF305-30-11-11	3/31
1SFL467001R1322	AF146-30-22-13	3/42	1SFL527002R1300	AF205-30-00-13	3/21	1SFL587002R1122	AF305-30-22-11	3/44
1SFL467001R1400	AF146-30-00-14	3/19	1SFL527002R1311	AF205-30-11-13	3/31	1SFL587002R1200	AF305-30-00-12	3/21
1SFL467001R1411	AF146-30-11-14	3/29	1SFL527002R1322	AF205-30-22-13	3/44	1SFL587002R1211	AF305-30-11-12	3/31
1SFL467001R1422	AF146-30-22-14	3/42	1SFL527002R1400	AF205-30-00-14	3/21	1SFL587002R1222	AF305-30-22-12	3/44
1SFL467001R3300	AF146-30-00-33	3/20	1SFL527002R1411	AF205-30-11-14	3/31	1SFL587002R1300	AF305-30-00-13	3/21
1SFL467001R3311	AF146-30-11-33	3/30	1SFL527002R1422	AF205-30-22-14	3/44	1SFL587002R1311	AF305-30-11-13	3/31
1SFL467001R3322	AF146-30-22-33	3/43	1SFL527002R3300	AF205-30-00-33	3/22	1SFL587002R1322	AF305-30-22-13	3/44
1SFL467001R3400	AF146-30-00-34	3/20	1SFL527002R3311	AF205-30-11-33	3/32	1SFL587002R1400	AF305-30-00-14	3/21
1SFL467001R3411	AF146-30-11-34	3/30	1SFL527002R3322	AF205-30-22-33	3/45	1SFL587002R1411	AF305-30-11-14	3/31
1SFL467001R3422	AF146-30-22-34	3/43	1SFL527002R3400	AF205-30-00-34	3/22	1SFL587002R1422	AF305-30-22-14	3/44
1SFL467002R1100	AF146-30-00B-11	3/19	1SFL527002R3411	AF205-30-11-34	3/32	1SFL587002R3300	AF305-30-00-33	3/22
1SFL467002R1111	AF146-30-11B-11	3/29	1SFL527002R3422	AF205-30-22-34	3/45	1SFL587002R3311	AF305-30-11-33	3/32
1SFL467002R1122	AF146-30-22B-11	3/42	1SFL527102R1100	AF205-40-00-11	3/140	1SFL587002R3322	AF305-30-22-33	3/45
1SFL467002R1200	AF146-30-00B-12	3/19	1SFL527102R1111	AF205-40-11-11	3/143	1SFL587002R3400	AF305-30-00-34	3/22
1SFL467002R1211	AF146-30-11B-12	3/29	1SFL527102R1122	AF205-40-22-11	3/146	1SFL587002R3411	AF305-30-11-34	3/32
1SFL467002R1222	AF146-30-22B-12	3/42	1SFL527102R1200	AF205-40-00-12	3/140	1SFL587002R3422	AF305-30-22-34	3/45
1SFL467002R1300	AF146-30-00B-13	3/19	1SFL527102R1211	AF205-40-11-12	3/143	1SFL587102R1100	AF305-40-00-11	3/140
1SFL467002R1311	AF146-30-11B-13	3/29	1SFL527102R1222	AF205-40-22-12	3/146	1SFL587102R1111	AF305-40-11-11	3/143
1SFL467002R1322	AF146-30-22B-13	3/42	1SFL527102R1300	AF205-40-00-13	3/140	1SFL587102R1122	AF305-40-22-11	3/146
1SFL467002R1400	AF146-30-00B-14	3/19	1SFL527102R1311	AF205-40-11-13	3/143	1SFL587102R1200	AF305-40-00-12	3/140
1SFL467002R1411	AF146-30-11B-14	3/29	1SFL527102R1322	AF205-40-22-13	3/146	1SFL587102R1211	AF305-40-11-12	3/143
1SFL467002R1422	AF146-30-22B-14	3/42	1SFL527102R1400	AF205-40-00-14	3/140	1SFL587102R1222	AF305-40-22-12	3/146
1SFL467002R3300	AF146-30-00B-33	3/20	1SFL527102R1411	AF205-40-11-14	3/143	1SFL587102R1300	AF305-40-00-13	3/140
1SFL467002R3311	AF146-30-11B-33	3/30	1SFL527102R1422	AF205-40-22-14	3/146	1SFL587102R1311	AF305-40-11-13	3/143
1SFL467002R3322	AF146-30-22B-33	3/43	1SFL547002R1100	AF265-30-00-11	3/21	1SFL587102R1322	AF305-40-22-13	3/146
1SFL467002R3400	AF146-30-00B-34	3/20	1SFL547002R1111	AF265-30-11-11	3/31	1SFL587102R1400	AF305-40-00-14	3/140
1SFL467002R3411	AF146-30-11B-34	3/30	1SFL547002R1122	AF265-30-22-11	3/44	1SFL587102R1411	AF305-40-11-14	3/143
1SFL467002R3422	AF146-30-22B-34	3/43	1SFL547002R1200	AF265-30-00-12	3/21	1SFL587102R1422	AF305-40-22-14	3/146
1SFL487002R1100	AF190-30-00-11	3/21	1SFL547002R1211	AF265-30-11-12	3/31	1SFL597001R6811	AF460-30-11	3/34
1SFL487002R1111	AF190-30-11-11	3/31	1SFL547002R1222	AF265-30-22-12	3/44	1SFL597001R6822	AF460-30-22	3/47
1SFL487002R1122	AF190-30-22-11	3/44	1SFL547002R1300	AF265-30-00-13	3/21	1SFL597001R6911	AF460-30-11	3/34
1SFL487002R1200	AF190-30-00-12	3/21	1SFL547002R1311	AF265-30-11-13	3/31	1SFL597001R6922	AF460-30-22	3/47
1SFL487002R1211	AF190-30-11-12	3/31	1SFL547002R1322	AF265-30-22-13	3/44	1SFL597001R7011	AF460-30-11	3/34
1SFL487002R1222	AF190-30-22-12	3/44	1SFL547002R1400	AF265-30-00-14	3/21	1SFL597001R7022	AF460-30-22	3/47
1SFL487002R1300	AF190-30-00-13	3/21	1SFL547002R1411	AF265-30-11-14	3/31	1SFL597001R7111	AF460-30-11	3/34
1SFL487002R1311	AF190-30-11-13	3/31	1SFL547002R1422	AF265-30-22-14	3/44	1SFL597001R7122	AF460-30-22	3/47
1SFL487002R1322	AF190-30-22-13	3/44	1SFL547002R3300	AF265-30-00-33	3/22	1SFL597025R6811	GAF460-10-11	3/181
1SFL487002R1400	AF190-30-00-14	3/21	1SFL547002R3311	AF265-30-11-33	3/32	1SFL597025R6911	GAF460-10-11	3/181
1SFL487002R1411	AF190-30-11-14	3/31	1SFL547002R3322	AF265-30-22-33	3/45	1SFL597025R7011	GAF460-10-11	3/181
1SFL487002R1422	AF190-30-22-14	3/44	1SFL547002R3400	AF265-30-00-34	3/22	1SFL597025R7111	GAF460-10-11	3/181
1SFL487002R3300	AF190-30-00-33	3/22	1SFL547002R3411	AF265-30-11-34	3/32	1SFL607002R1100	AF370-30-00-11	3/21
1SFL487002R3311	AF190-30-11-33	3/32	1SFL547002R3422	AF265-30-22-34	3/45	1SFL607002R1111	AF370-30-11-11	3/31
1SFL487002R3322	AF190-30-22-33	3/45	1SFL547102R1100	AF265-40-00-11	3/140	1SFL607002R1122	AF370-30-22-11	3/44
1SFL487002R3400	AF190-30-00-34	3/22	1SFL547102R1111	AF265-40-11-11	3/143	1SFL607002R1200	AF370-30-00-12	3/21
1SFL487002R3411	AF190-30-11-34	3/32	1SFL547102R1122	AF265-40-22-11	3/146	1SFL607002R1211	AF370-30-11-12	3/31
1SFL487002R3422	AF190-30-22-34	3/45	1SFL547102R1200	AF265-40-00-12	3/140	1SFL607002R1222	AF370-30-22-12	3/44
1SFL487102R1100	AF190-40-00-11	3/140	1SFL547102R1211	AF265-40-11-12	3/143	1SFL607002R1300	AF370-30-00-13	3/21
1SFL487102R1111	AF190-40-11-11	3/143	1SFL547102R1222	AF265-40-22-12	3/146	1SFL607002R1311	AF370-30-11-13	3/31

# Index

## Order code classification

Order code	Type	Page	Order code	Type	Page	Order code	Type	Page
15FL607002R1322	AF370-30-22-13	3/44	15FL707001R7011	AF2050-30-11	3/35	15FN084214R1000	BEP140-30	3/262
15FL607002R1400	AF370-30-00-14	3/21	15FL707001R7022	AF2050-30-22	3/48	15FN084214R2000	BEP140-40	3/262
15FL607002R1411	AF370-30-11-14	3/31	15FL707001R9101	AF2050T-30-11	3/36	15FN084413R1000	BEY140-4	3/263
15FL607002R1422	AF370-30-22-14	3/44	15FL707025R7011	GAF2050-10-11	3/182	15FN084806R1000	BEA205/XT4	3/265
15FL607002R3300	AF370-30-00-33	3/22	15FN010716R1001	CEL18-01	3/240	15FN084806R1001	BEA205/T4	3/265
15FL607002R3311	AF370-30-11-33	3/32	15FN010716R1010	CEL18-10	3/240	15FN084811R1000	BER205-4	3/262
15FL607002R3322	AF370-30-22-33	3/45	15FN010720R1011	CAL18-11	3/238	15FN084813R1000	BEY190-4	3/263
15FL607002R3400	AF370-30-00-34	3/22	15FN010720R3311	CAL18-11B	3/238	15FN084814R1000	BEP205-30	3/262
15FL607002R3411	AF370-30-11-34	3/32	15FN010820R1011	CAL19-11	3/238	15FN084814R2000	BEP205-40	3/262
15FL607002R3422	AF370-30-22-34	3/45	15FN010820R3311	CAL19-11B	3/238	15FN085213R1000	BEY205-4	3/263
15FL607102R1100	AF370-40-00-11	3/140	15FN010832R1001	CEL19-01	3/240	15FN085406R1000	BEA370/T5	3/265
15FL607102R1111	AF370-40-11-11	3/143	15FN010832R1010	CEL19-10	3/240	15FN085411R1000	BER370-4	3/262
15FL607102R1122	AF370-40-22-11	3/146	15FN030300R1000	VM19	3/248	15FN085413R1000	BEY265-4	3/263
15FL607102R1200	AF370-40-00-12	3/140		BER205-4	12/37	15FN085414R1000	BEP370-30	3/262
15FL607102R1211	AF370-40-11-12	3/143		BER140-4	12/37	15FN085414R2000	BEP370-40	3/262
15FL607102R1222	AF370-40-22-12	3/146		BER370-4	12/39	15FN085701R1000	BEM460-30	3/262
15FL607102R1300	AF370-40-00-13	3/140		BEY140-4	12/85	15FN085703R1000	BED460	3/263
15FL607102R1311	AF370-40-11-13	3/143		BEY370-4	12/87	15FN085704R1000	BES460	3/262
15FL607102R1322	AF370-40-22-13	3/146		BEY205-4	12/87	15FN085708R1000	BEF460/OESA400	3/265
15FL607102R1400	AF370-40-00-14	3/140	15FN034403R1000	VM140/190	3/248	15FN085709R1000	OESA460H/OESA400	3/265
15FL607102R1411	AF370-40-11-14	3/143		BEY190-4	12/85	15FN085813R1000	BEY370-4	3/263
15FL607102R1422	AF370-40-22-14	3/146	15FN035203R1000	VM205/265	3/248	15FN085903R1000	BED580	3/263
15FL617001R6811	AF580-30-11	3/34		BEY265-4	12/87	15FN085907R1000	BEA460H/T4	3/265
15FL617001R6822	AF580-30-22	3/47	15FN035403R1000	VM370/400	3/248	15FN086101R1000	BEM750-30	3/262
15FL617001R6911	AF580-30-11	3/34	15FN035700R1000	VM750H	3/248	15FN086103R1000	BED750	3/263
15FL617001R6922	AF580-30-22	3/47	15FN035701R1000	VM750V	3/248	15FN086104R1000	BES750	3/262
15FL617001R7011	AF580-30-11	3/34	15FN036503R1001	VM1650H	3/248	15FN086106R1000	BEA750/T6	3/265
15FL617001R7022	AF580-30-22	3/47	15FN074203R1000	LY140	3/261	15FN086106R1001	BEA750/T5	3/265
15FL617001R7111	AF580-30-11	3/34	15FN074207R1000	LW140	3/260	15FN086106R1002	BEA750D/T6	3/265
15FL617001R7122	AF580-30-22	3/47	15FN074208R1000	LD146-30	3/260	15FN086106R1003	BEA750D/T5	3/265
15FL637001R6811	AF750-30-11	3/34	15FN074208R2000	LD146-40	3/260	15FN086108R1000	BEF750/OESA800	3/265
15FL637001R6822	AF750-30-22	3/47	15FN074210R1000	LX140	3/260	15FN094200R1000	PR146-1	3/267
15FL637001R6911	AF750-30-11	3/34	15FN074211R1000	LL146-30	3/260	15FN094900R1000	PR210-1	3/267
15FL637001R6922	AF750-30-22	3/47	15FN074211R2000	LL146-40	3/260	15FN095100R1001	PR185-2	3/267
15FL637001R7011	AF750-30-11	3/34	15FN074307R1000	LW110	3/292	15FN095300R1000	PR300-1	3/267
15FL637001R7022	AF750-30-22	3/47	15FN074703R1000	LY185	3/261	15FN095300R1001	PR300-2	3/267
15FL637001R7111	AF750-30-11	3/34	15FN074712R1000	LP185	3/261	15FN095700R1000	PR460-1	3/267
15FL637001R7122	AF750-30-22	3/47	15FN074807R1000	LW205	3/260	15FN095700R1001	PR460-2	3/267
15FL637025R6811	GAF750-10-11	3/181	15FN074807R2000	LW205-40	3/260	15FN095700R1002	PR400-2	3/267
15FL637025R6911	GAF750-10-11	3/181	15FN074810R1000	LX205	3/260	15FN095701R1000	PN460-21	3/266
15FL637025R7011	GAF750-10-11	3/181	15FN074811R1000	LL205-30	3/260	15FN095703R1000	PN460-41	3/266
15FL637025R7111	GAF750-10-11	3/181	15FN074811R2000	LL205-40	3/260	15FN095705R1000	PN460-11	3/266
15FL647001R6811	AF1250-30-11	3/35	15FN075103R1000	LY300	3/261	15FN096100R1000	PR750-1	3/267
15FL647001R6822	AF1250-30-22	3/48	15FN075112R1000	LP300	3/261	15FN096100R1001	PR750-2	3/267
15FL647001R6911	AF1250-30-11	3/35	15FN075407R1000	LW370	3/260	15FN096100R1002	PR580-2	3/267
15FL647001R6922	AF1250-30-22	3/48	15FN075407R2000	LW370-40	3/260	15FN096101R1000	PN750-21	3/266
15FL647001R7011	AF1250-30-11	3/35	15FN075410R1000	LX370	3/260	15FN096103R1000	PN750-41	3/266
15FL647001R7022	AF1250-30-22	3/48	15FN075411R1000	LL370-30	3/260	15FN096105R1000	PN750-11	3/266
15FL647001R7111	AF1250-30-11	3/35	15FN075411R2000	LL370-40	3/260	15FN124203R1000	LT140-30L	3/259
15FL647001R7122	AF1250-30-22	3/48	15FN075703R1000	LY460	3/261	15FN124203R2000	LT140-40L	3/259
15FL647025R6811	GAF1250-10-11	3/182	15FN075707R1000	LW460	3/260	15FN124801R1000	LT205-30C	3/259
15FL647025R6911	GAF1250-10-11	3/182	15FN075710R1000	LX460	3/260	15FN124801R2000	LT205-40C	3/259
15FL647025R7011	GAF1250-10-11	3/182	15FN075712R1000	LP460	3/261	15FN124803R1000	LT205-30L	3/259
15FL647025R7111	GAF1250-10-11	3/182	15FN075716R1000	LE460	3/260	15FN124803R2000	LT205-40L	3/259
15FL657001R7011	AF1350-30-11	3/35	15FN076103R1000	LY750	3/261	15FN124804R1000	LT205-30Y	3/259
15FL657001R7022	AF1350-30-22	3/48	15FN076107R1000	LW750	3/260	15FN125401R1000	LT370-30C	3/259
15FL657001R9101	AF1350T-30-11	3/36	15FN076110R1000	LX750	3/260	15FN125401R2000	LT370-40C	3/259
15FL667001R7011	AF2650-30-11	3/35	15FN076112R1000	LP750	3/261	15FN125403R1000	LT370-30L	3/259
15FL667001R7022	AF2650-30-22	3/48	15FN076116R1000	LE750	3/260	15FN125403R2000	LT370-40L	3/259
15FL667001R9101	AF2650T-30-11	3/36	15FN076407R1000	LW1250	3/260	15FN125404R1000	LT370-30Y	3/259
15FL677001R7011	AF1650-30-11	3/35	15FN076412R1000	LP1250	3/294	15FN125406R1000	LT370-30D	3/259
15FL677001R7022	AF1650-30-22	3/48	15FN076512R1000	LP2050	3/294	15FN125701R1000	LT460-AC	3/259
15FL677001R9101	AF1650T-30-11	3/36	15FN084111R1000	BER140-4	12/37	15FN125703R1000	LT460-AL	3/259
15FL677025R7011	GAF1650-10-11	3/182	15FN084206R1000	BEA140/XT2	3/265	15FN126101R1000	LT750-AC	3/259
15FL687001R7011	AF2850-30-11	3/35	15FN084206R1001	BEA140/XT4	3/265	15FN126103R1000	LT750-AL	3/259
15FL687001R7022	AF2850-30-22	3/48	15FN084206R1002	BEA140/XT3	3/265	15FN154310R8006	ZA110	3/295
15FL687001R9101	AF2850T-30-11	3/36	15FN084211R1000	BER140-4	3/262	15FN154310R8106	ZA110	3/295

# Index

## Order code classification

Order code	Type	Page	Order code	Type	Page	Order code	Type	Page
1SFN154310R8406	ZA110	3/295	2CCS801901R0539	S801S-SCL32-SR	8/2	GJH1211001R8404	K6-40E-84	4/17
1SFN154310R8506	ZA110	3/295	2CCS801901R0599	S801S-SCL63-SR	8/2	GJH1211001R8405	K6-40E-85	4/17
1SFN154310R8606	ZA110	3/295	2CCS801901R0639	S801S-SCL100-SR	8/2	GJH1211003R0221	K6-22Z-F-01	4/37
1SFN154310R8806	ZA110	3/295	2CCS802901R0539	S802S-SCL32-SR	8/2	GJH1211003R0222	K6-22Z-F-02	4/37
1SFN155770R6806	ZAF460	3/269	2CCS802901R0599	S802S-SCL63-SR	8/2	GJH1211003R0223	K6-22Z-F-03	4/37
1SFN155770R6906	ZAF460	3/269	2CCS802901R0639	S802S-SCL100-SR	8/2	GJH1211003R0311	K6-31Z-F-01	4/37
1SFN155770R7006	ZAF460	3/269	2CCS803901R0539	S803S-SCL32-SR	8/2	GJH1211003R0312	K6-31Z-F-02	4/37
1SFN155770R7106	ZAF460	3/269	2CCS803901R0599	S803S-SCL63-SR	8/2	GJH1211003R0313	K6-31Z-F-03	4/37
1SFN156170R6806	ZAF750	3/269	2CCS803901R0639	S803S-SCL100-SR	8/2	GJH1211003R0401	K6-40E-F-01	4/37
1SFN156170R6906	ZAF750	3/269	2CCS803917R0539	S803W-SCL32-SR	8/2	GJH1211003R0402	K6-40E-F-02	4/37
1SFN156170R7006	ZAF750	3/269	2CCS803917R0599	S803W-SCL63-SR	8/2	GJH1211003R0403	K6-40E-F-03	4/37
1SFN156170R7106	ZAF750	3/269	2CCS803917R0639	S803W-SCL100-SR	8/2	GJH1211003R8220	K6-22Z-F-80	4/37
1SFN156570R7026	ZAF1650	3/269	2CCS803901R0539	S803S-SCL32-SR	8/2	GJH1211003R8224	K6-22Z-F-84	4/37
1SFN156670R7026	ZAF2650	3/269	2CCS803901R0599	S803S-SCL63-SR	8/2	GJH1211003R8225	K6-22Z-F-85	4/37
1SFN164302R1000	ZLU95	3/295	2CCS803901R0639	S803S-SCL100-SR	8/2	GJH1211003R8310	K6-31Z-F-80	4/37
1SFN164502R1000	ZLU110	3/295	2CCS801901R0639	S801S-SCL100-SR	8/2	GJH1211003R8314	K6-31Z-F-84	4/37
1SFN165703R1000	ZL400	3/269	2CCS801901R0539	S801S-SCL32-SR	8/2	GJH1211003R8315	K6-31Z-F-85	4/37
1SFN165710R1000	ZW460	3/269	2CCS801901R0599	S801S-SCL63-SR	8/2	GJH1211003R8400	K6-40E-F-80	4/37
1SFN165903R1000	ZL460	3/269	2CCS802901R0639	S802S-SCL100-SR	8/2	GJH1211003R8404	K6-40E-F-84	4/37
1SFN166103R1000	ZL580	3/269	2CCS802901R0539	S802S-SCL32-SR	8/2	GJH1211003R8405	K6-40E-F-85	4/37
1SFN166110R1000	ZW750	3/269	2CCS802901R0599	S802S-SCL63-SR	8/2	GJH1211009R0221	K6-22Z-P-01	4/27
1SFN166303R1000	ZL750	3/269	2CCS803917R0639	S803W-SCL100-SR	8/2	GJH1211009R0222	K6-22Z-P-02	4/27
1SFN166403R1000	ZL1250	3/269	2CCS803917R0539	S803W-SCL32-SR	8/2	GJH1211009R0223	K6-22Z-P-03	4/27
1SFN166503R1000	ZL1350	3/269	2CCS803917R0599	S803W-SCL63-SR	8/2	GJH1211009R0311	K6-31Z-P-01	4/27
1SFN166503R1001	ZL1350-1	3/269	5223351-AN	KWK1000	3/305	GJH1211009R0312	K6-31Z-P-02	4/27
1SFN166510R1001	ZW1650	3/269	5223351-Z	KWK550	3/305	GJH1211009R0313	K6-31Z-P-03	4/27
1SFN166521R1070	ZP1650	3/269	FPTN372726R1001	WB75-A	3/290	GJH1211009R0401	K6-40E-P-01	4/27
1SFN166603R1000	ZL2650	3/269	FPTN372726R1002	WB75-A	3/290	GJH1211009R0402	K6-40E-P-02	4/27
1SFN166610R1000	ZW2650	3/269	FPTN372726R1003	WB75-A	3/290	GJH1211009R0403	K6-40E-P-03	4/27
1SFN166621R1070	ZP2650	3/269	FPTN372726R1004	WB75-A	3/290	GJH1211009R8220	K6-22Z-P-80	4/27
1SFN166703R1000	ZL1650	3/269	FPTN372726R1005	WB75-A	3/290	GJH1211009R8224	K6-22Z-P-84	4/27
1SFN166703R1001	ZL1650-1	3/269	FPTN372726R1006	WB75-A	3/290	GJH1211009R8225	K6-22Z-P-85	4/27
1SFN167003R1000	ZL2050	3/269	FPTN372726R1007	WB75-A	3/290	GJH1211009R8310	K6-31Z-P-80	4/27
1SFN167003R1001	ZL2050-1	3/269	FPTN372726R1008	WB75-A	3/290	GJH1211009R8314	K6-31Z-P-84	4/27
1SFN170801R1001	RU19/120	3/268	GHC0110003R0001	C011-70	7/6	GJH1211009R8315	K6-31Z-P-85	4/27
1SFN170801R1002	RU19/240	3/268	GHC0110003R0002	C011-80	7/6	GJH1211009R8400	K6-40E-P-80	4/27
1SNA235156R2700	BA4	3/256	GHC0110003R0003	C011-90	7/6	GJH1211009R8404	K6-40E-P-84	4/27
1SNA235712R2400	HTP500-BA4	3/256	GHC0110003R0004	C011-100	7/6	GJH1211009R8405	K6-40E-P-85	4/27
1SNA360010R1500	SPRC 1	3/256	GHC0110003R0005	C011-110	7/6	GJH1213001R0221	KC6-22Z-01	4/18
1SVR550800R9300	CM-MSE	7/5	GHC0110003R0006	C011-120	7/6	GJH1213001R0223	KC6-22Z-03	4/18
1SVR550801R9300	CM-MSE	7/5	GHC0110003R0007	C011-130	7/6	GJH1213001R0224	KC6-22Z-04	4/18
1SVR550805R9300	CM-MSE	7/5	GHC0110003R0008	C011-150	7/6	GJH1213001R0225	KC6-22Z-05	4/18
1SVR730100R0300	CT-ERS.21S	12/85	GHC0110003R0009	C011-160	7/6	GJH1213001R0227	KC6-22Z-07	4/18
1SVR730210R3300	CT-SDS.22S	12/69	GHC0110003R0010	C011-170	7/6	GJH1213001R0311	KC6-31Z-01	4/18
1SVR730211R2300	CT-SDS.23S	12/69	GHC0110003R0011	C011-140	7/6	GJH1213001R0313	KC6-31Z-03	4/18
1SVR730700R0100	CM-MSS.12S	7/5	GHC0110033R0008	C011-3-150	7/6	GJH1213001R0314	KC6-31Z-04	4/18
1SVR730700R0200	CM-MSS.22S	7/5	GHV2501902R0002	RV-BC6/60	4/49	GJH1213001R0315	KC6-31Z-05	4/18
1SVR730700R2100	CM-MSS.13S	7/5	GHV2501903R0002	RV-BC6/250	4/49	GJH1213001R0317	KC6-31Z-07	4/18
1SVR730700R2200	CM-MSS.23S	7/5	GJF1101903R0001	SA1	2/41	GJH1213001R0401	KC6-40E-01	4/18
1SVR730712R0200	CM-MSS.32S	7/5	GJF1101903R0002	SA2	2/41	GJH1213001R0403	KC6-40E-03	4/18
1SVR730712R1200	CM-MSS.41S	7/5	GJF1101903R0003	SA3	2/41	GJH1213001R0404	KC6-40E-04	4/18
1SVR730712R1300	CM-MSS.51S	7/5	GJH1211001R0221	K6-22Z-01	4/17	GJH1213001R0405	KC6-40E-05	4/18
1SVR730712R1400	CM-MSS.31S	7/5	GJH1211001R0222	K6-22Z-02	4/17	GJH1213001R0407	KC6-40E-07	4/18
1SVR730712R2200	CM-MSS.33S	7/5	GJH1211001R0223	K6-22Z-03	4/17	GJH1213001R1226	KC6-22Z-16	4/18
1SVR730720R1400	CM-MSS.11S	7/5	GJH1211001R0311	K6-31Z-01	4/17	GJH1213001R1316	KC6-31Z-16	4/18
1SVR730722R1400	CM-MSS.21S	7/5	GJH1211001R0312	K6-31Z-02	4/17	GJH1213001R1406	KC6-40E-16	4/18
1SVR740700R0100	CM-MSS.12P	7/5	GJH1211001R0313	K6-31Z-03	4/17	GJH1213001R5311	KC6-31Z-2.4-51	4/19
1SVR740700R0200	CM-MSS.22P	7/5	GJH1211001R0401	K6-40E-01	4/17	GJH1213001R5401	KC6-40E-2.4-51	4/19
1SVR740700R2100	CM-MSS.13P	7/5	GJH1211001R0402	K6-40E-02	4/17	GJH1213001R7221	K6S-22Z-1.7-71	4/19
1SVR740700R2200	CM-MSS.23P	7/5	GJH1211001R0403	K6-40E-03	4/17	GJH1213001R7222	K6S-22Z-2.8-72	4/19
1SVR740712R0200	CM-MSS.32P	7/5	GJH1211001R8220	K6-22Z-80	4/17	GJH1213001R7311	K6S-31Z-1.7-71	4/19
1SVR740712R1200	CM-MSS.41P	7/5	GJH1211001R8224	K6-22Z-84	4/17	GJH1213001R7312	K6S-31Z-2.8-72	4/19
1SVR740712R1300	CM-MSS.51P	7/5	GJH1211001R8225	K6-22Z-85	4/17	GJH1213001R7401	K6S-40E-1.7-71	4/19
1SVR740712R1400	CM-MSS.31P	7/5	GJH1211001R8310	K6-31Z-80	4/17	GJH1213001R7402	K6S-40E-2.8-72	4/19
1SVR740712R2200	CM-MSS.33P	7/5	GJH1211001R8314	K6-31Z-84	4/17	GJH1213001R8311	KC6-31Z-1.4-81	4/19
1SVR740720R1400	CM-MSS.11P	7/5	GJH1211001R8315	K6-31Z-85	4/17	GJH1213001R8401	KC6-40E-1.4-81	4/19
1SVR740722R1400	CM-MSS.21P	7/5	GJH1211001R8400	K6-40E-80	4/17	GJH1213003R0221	KC6-22Z-F-01	4/38



# Index

## Order code classification

Order code	Type	Page	Order code	Type	Page	Order code	Type	Page
GJH1213003R0224	KC6-22Z-F-04	4/38	GJL1211001R0101	B6-30-10-01	4/8	GJL1211911R0011	VB6A-30-01-01	4/12
GJH1213003R0225	KC6-22Z-F-05	4/38	GJL1211001R0102	B6-30-10-02	4/8	GJL1211911R0012	VB6A-30-01-02	4/12
GJH1213003R0227	KC6-22Z-F-07	4/38	GJL1211001R0103	B6-30-10-03	4/8	GJL1211911R0013	VB6A-30-01-03	4/12
GJH1213003R0311	KC6-31Z-F-01	4/38	GJL1211001R8010	B6-30-01-80	4/8	GJL1211911R0101	VB6A-30-10-01	4/12
GJH1213003R0314	KC6-31Z-F-04	4/38	GJL1211001R8014	B6-30-01-84	4/8	GJL1211911R0102	VB6A-30-10-02	4/12
GJH1213003R0315	KC6-31Z-F-05	4/38	GJL1211001R8015	B6-30-01-85	4/8	GJL1211911R0103	VB6A-30-10-03	4/12
GJH1213003R0317	KC6-31Z-F-07	4/38	GJL1211003R8100	B6-30-10-80	4/8	GJL1211911R8010	VB6A-30-01-80	4/12
GJH1213003R0401	KC6-40E-F-01	4/38	GJL1211001R8104	B6-30-10-84	4/8	GJL1211911R8014	VB6A-30-01-84	4/12
GJH1213003R0404	KC6-40E-F-04	4/38	GJL1211001R8105	B6-30-10-85	4/8	GJL1211911R8015	VB6A-30-01-85	4/12
GJH1213003R0405	KC6-40E-F-05	4/38	GJL1211003R0011	B6-30-01-F-01	4/30	GJL1211911R8100	VB6A-30-10-80	4/12
GJH1213003R1226	KC6-22Z-F-16	4/38	GJL1211003R0012	B6-30-01-F-02	4/30	GJL1211911R8104	VB6A-30-10-84	4/12
GJH1213003R1316	KC6-31Z-F-16	4/38	GJL1211003R0013	B6-30-01-F-03	4/30	GJL1211911R8105	VB6A-30-10-85	4/12
GJH1213003R1406	KC6-40E-F-16	4/38	GJL1211003R0101	B6-30-10-F-01	4/30	GJL1211919R0011	VB6A-30-01-P-01	4/24
GJH1213003R5311	KC6-31Z-F-51	4/39	GJL1211003R0102	B6-30-10-F-02	4/30	GJL1211919R0012	VB6A-30-01-P-02	4/24
GJH1213003R5401	KC6-40E-F-51	4/39	GJL1211003R0103	B6-30-10-F-03	4/30	GJL1211919R0013	VB6A-30-01-P-03	4/24
GJH1213003R8311	KC6-31Z-F-1.4-81	4/39	GJL1211003R8010	B6-30-01-F-80	4/30	GJL1211919R0101	VB6A-30-10-P-01	4/24
GJH1213003R8401	KC6-40E-F-1.4-81	4/39	GJL1211003R8014	B6-30-01-F-84	4/30	GJL1211919R0102	VB6A-30-10-P-02	4/24
GJH1213009R0221	KC6-22Z-P-01	4/28	GJL1211003R8015	B6-30-01-F-85	4/30	GJL1211919R0103	VB6A-30-10-P-03	4/24
GJH1213009R0224	KC6-22Z-P-04	4/28	GJL1211003R8100	B6-30-10-F-80	4/30	GJL1211919R8010	VB6A-30-01-P-80	4/24
GJH1213009R0225	KC6-22Z-P-05	4/28	GJL1211003R8104	B6-30-10-F-84	4/30	GJL1211919R8014	VB6A-30-01-P-84	4/24
GJH1213009R0227	KC6-22Z-P-07	4/28	GJL1211003R8105	B6-30-10-F-85	4/30	GJL1211919R8015	VB6A-30-01-P-85	4/24
GJH1213009R0311	KC6-31Z-P-01	4/28	GJL1211009R0011	B6-30-01-P-01	4/20	GJL1211919R8100	VB6A-30-10-P-80	4/24
GJH1213009R0314	KC6-31Z-P-04	4/28	GJL1211009R0012	B6-30-01-P-02	4/20	GJL1211919R8104	VB6A-30-10-P-84	4/24
GJH1213009R0315	KC6-31Z-P-05	4/28	GJL1211009R0013	B6-30-01-P-03	4/20	GJL1211919R8105	VB6A-30-10-P-85	4/24
GJH1213009R0401	KC6-40E-P-01	4/28	GJL1211009R0101	B6-30-10-P-01	4/20	GJL1213001R0011	BC6-30-01-01	4/9
GJH1213009R0404	KC6-40E-P-04	4/28	GJL1211009R0102	B6-30-10-P-02	4/20	GJL1213001R0013	BC6-30-01-03	4/9
GJH1213009R0405	KC6-40E-P-05	4/28	GJL1211009R0103	B6-30-10-P-03	4/20	GJL1213001R0014	BC6-30-01-04	4/9
GJH1213009R0407	KC6-40E-P-07	4/28	GJL1211009R8010	B6-30-01-P-80	4/20	GJL1213001R0015	BC6-30-01-05	4/9
GJH1213009R1226	KC6-22Z-P-16	4/28	GJL1211009R8014	B6-30-01-P-84	4/20	GJL1213001R0017	BC6-30-01-07	4/9
GJH1213009R1316	KC6-31Z-P-16	4/28	GJL1211009R8015	B6-30-01-P-85	4/20	GJL1213001R0101	BC6-30-10-01	4/9
GJH1213009R1406	KC6-40E-P-16	4/28	GJL1211009R8100	B6-30-10-P-80	4/20	GJL1213001R0103	BC6-30-10-03	4/9
GJH1213009R5311	KC6-31Z-P-2.4-51	4/29	GJL1211009R8104	B6-30-10-P-84	4/20	GJL1213001R0104	BC6-30-10-04	4/9
GJH1213009R5401	KC6-40E-P-2.4-51	4/29	GJL1211009R8105	B6-30-10-P-85	4/20	GJL1213001R0105	BC6-30-10-05	4/9
GJH1213009R8311	KC6-31Z-P-1.4-81	4/29	GJL121201R0001	B6-40-00-01	4/15	GJL1213001R0107	BC6-30-10-07	4/9
GJH1213009R8401	KC6-40E-P-1.4-81	4/29	GJL121201R0002	B6-40-00-02	4/15	GJL1213001R0106	BC6-30-01-16	4/9
GJL1201317R0001	CA6-11K	4/50	GJL121201R0003	B6-40-00-03	4/15	GJL1213001R1106	BC6-30-10-16	4/9
GJL1201317R0002	CA6-11E	4/49	GJL121201R8000	B6-40-00-80	4/15	GJL1213001R5011	BC6-30-01-2.4-51	4/14
GJL1201317R0003	CA6-11M	4/49	GJL121201R8004	B6-40-00-84	4/15	GJL1213001R5101	BC6-30-10-2.4-51	4/14
GJL1201317R0004	CA6-11N	4/49	GJL1211501R0001	B6-22-00-01	4/15	GJL1213001R7011	B6S-30-01-1.7-71	4/14
GJL1201318R0001	CA6-11K-F	4/50	GJL1211501R0002	B6-22-00-02	4/15	GJL1213001R7012	B6S-30-01-2.8-72	4/14
GJL1201318R0002	CA6-11E-F	4/49	GJL1211501R0003	B6-22-00-03	4/15	GJL1213001R7101	B6S-30-01-1.7-71	4/14
GJL1201318R0003	CA6-11M-F	4/49	GJL1211501R8000	B6-22-00-80	4/15	GJL1213001R7102	B6S-30-10-2.8-72	4/14
GJL1201318R0004	CA6-11N-F	4/49	GJL1211501R8004	B6-22-00-84	4/15	GJL1213001R8011	BC6-30-01-1.4-81	4/14
GJL1201319R0001	CA6-11K-P	4/50	GJL1211901R0011	VB6-30-01-01	4/10	GJL1213001R8101	BC6-30-10-1.4-81	4/14
GJL1201319R0002	CA6-11E-P	4/49	GJL1211901R0012	VB6-30-01-02	4/10	GJL1213003R0011	BC6-30-01-F-01	4/31
GJL1201319R0003	CA6-11M-P	4/49	GJL1211901R0013	VB6-30-01-03	4/10	GJL1213003R0013	BC6-30-01-F-03	4/31
GJL1201319R0004	CA6-11N-P	4/49	GJL1211901R0101	VB6-30-10-01	4/10	GJL1213003R0014	BC6-30-01-F-04	4/31
GJL1201330R0001	CAF6-11K	4/50	GJL1211901R0102	VB6-30-10-02	4/10	GJL1213003R0015	BC6-30-01-F-05	4/31
GJL1201330R0002	CAF6-11E	4/49	GJL1211901R0103	VB6-30-10-03	4/10	GJL1213003R0017	BC6-30-01-F-07	4/31
GJL1201330R0003	CAF6-11M	4/49	GJL1211901R8010	VB6-30-01-80	4/10	GJL1213003R0101	BC6-30-10-F-01	4/31
GJL1201330R0004	CAF6-11N	4/49	GJL1211901R8014	VB6-30-01-84	4/10	GJL1213003R0103	BC6-30-10-F-03	4/31
GJL1201330R0005	CAF6-20K	4/50	GJL1211901R8015	VB6-30-01-85	4/10	GJL1213003R0104	BC6-30-10-F-04	4/31
GJL1201330R0006	CAF6-20E	4/49	GJL1211901R8100	VB6-30-10-80	4/10	GJL1213003R0105	BC6-30-10-F-05	4/31
GJL1201330R0007	CAF6-20M	4/49	GJL1211901R8104	VB6-30-10-84	4/10	GJL1213003R0107	BC6-30-10-F-07	4/31
GJL1201330R0008	CAF6-20N	4/49	GJL1211901R8105	VB6-30-10-85	4/10	GJL1213003R1016	BC6-30-01-F-16	4/31
GJL1201330R0009	CAF6-02K	4/50	GJL1211909R0011	VB6-30-01-P-01	4/22	GJL1213003R1106	BC6-30-10-F-16	4/31
GJL1201330R0010	CAF6-02E	4/49	GJL1211909R0012	VB6-30-01-P-02	4/22	GJL1213003R5011	BC6-30-01-F-2.4-51	4/36
GJL1201330R0011	CAF6-02M	4/49	GJL1211909R0013	VB6-30-01-P-03	4/22	GJL1213003R5101	BC6-30-10-F-2.4-51	4/36
GJL1201330R0012	CAF6-02N	4/49	GJL1211909R0101	VB6-30-10-P-01	4/22	GJL1213003R8011	BC6-30-01-F-1.4-81	4/36
GJL1201902R0001	LB6	4/49	GJL1211909R0102	VB6-30-10-P-02	4/22	GJL1213003R8101	BC6-30-10-F-1.4-81	4/36
GJL1201903R0001	LB6-CA	4/49	GJL1211909R0103	VB6-30-10-P-03	4/22	GJL1213009R0011	BC6-30-01-P-01	4/21
GJL1201906R0001	LT6-B	4/49	GJL1211909R8010	VB6-30-01-P-80	4/22	GJL1213009R0013	BC6-30-01-P-03	4/21
GJL1201907R0001	LP6	4/49	GJL1211909R8014	VB6-30-01-P-84	4/22	GJL1213009R0014	BC6-30-01-P-04	4/21
GJL1201908R0001	BSM6-30	4/49	GJL1211909R8015	VB6-30-01-P-85	4/22	GJL1213009R0015	BC6-30-01-P-05	4/21
GJL1211001R0011	B6-30-01-01	4/8	GJL1211909R8100	VB6-30-10-P-80	4/22	GJL1213009R0017	BC6-30-01-P-07	4/21
GJL1211001R0012	B6-30-01-02	4/8	GJL1211909R8104	VB6-30-10-P-84	4/22	GJL1213009R0101	BC6-30-10-P-01	4/21
GJL1211001R0013	B6-30-01-03	4/8	GJL1211909R8105	VB6-30-10-P-85	4/22	GJL1213009R0103	BC6-30-10-P-03	4/21

## Index

### Order code classification

Order code	Type	Page
GJL1213009R0104	BC6-30-10-P-04	4/21
GJL1213009R0105	BC6-30-10-P-05	4/21
GJL1213009R0107	BC6-30-10-P-07	4/21
GJL1213009R1016	BC6-30-01-P-16	4/21
GJL1213009R1106	BC6-30-10-P-16	4/21
GJL1213009R5011	BC6-30-01-P-2.4-51	4/26
GJL1213009R5101	BC6-30-10-P-2.4-51	4/26
GJL1213009R8011	BC6-30-01-P-1.4-81	4/26
GJL1213009R8101	BC6-30-10-P-1.4-81	4/26
GJL1213109R0101	BC6-21-10-P-01	4/21
GJL1213109R0103	BC6-21-10-P-03	4/21
GJL1213109R0104	BC6-21-10-P-04	4/21
GJL1213109R0105	BC6-21-10-P-05	4/21
GJL1213109R1106	BC6-21-10-P-16	4/21
GJL1213501R0001	BC6-22-00-01	4/16
GJL1213501R0002	BC6-22-00-02	4/16
GJL1213501R0003	BC6-22-00-03	4/16
GJL1213501R0004	BC6-22-00-04	4/16
GJL1213501R0005	BC6-22-00-05	4/16
GJL1213501R0007	BC6-22-00-07	4/16
GJL1213501R1006	BC6-22-00-16	4/16
GJL1213901R0011	VBC6-30-01-01	4/11
GJL1213901R0013	VBC6-30-01-03	4/11
GJL1213901R0014	VBC6-30-01-04	4/11
GJL1213901R0015	VBC6-30-01-05	4/11
GJL1213901R0017	VBC6-30-01-07	4/11
GJL1213901R0101	VBC6-30-10-01	4/11
GJL1213901R0103	VBC6-30-10-03	4/11
GJL1213901R0104	VBC6-30-10-04	4/11
GJL1213901R0105	VBC6-30-10-05	4/11
GJL1213901R0107	VBC6-30-10-07	4/11
GJL1213901R0106	VBC6-30-01-16	4/11
GJL1213901R1106	VBC6-30-10-16	4/11
GJL1213909R0011	VBC6-30-01-P-01	4/23
GJL1213909R0013	VBC6-30-01-P-03	4/23
GJL1213909R0014	VBC6-30-01-P-04	4/23
GJL1213909R0015	VBC6-30-01-P-05	4/23
GJL1213909R0016	VBC6-30-06-P-06	4/23
GJL1213909R0017	VBC6-30-01-P-07	4/23
GJL1213909R0101	VBC6-30-10-P-01	4/23
GJL1213909R0103	VBC6-30-10-P-03	4/23
GJL1213909R0104	VBC6-30-10-P-04	4/23
GJL1213909R0105	VBC6-30-10-P-05	4/23
GJL1213909R0106	VBC6-30-10-P-06	4/23
GJL1213909R0107	VBC6-30-10-P-07	4/23
GJL1213911R0011	VBC6A-30-01-01	4/13
GJL1213911R0013	VBC6A-30-01-03	4/13
GJL1213911R0014	VBC6A-30-01-04	4/13
GJL1213911R0015	VBC6A-30-01-05	4/13
GJL1213911R0017	VBC6A-30-01-07	4/13
GJL1213911R0101	VBC6A-30-10-01	4/13
GJL1213911R0103	VBC6A-30-10-03	4/13
GJL1213911R0104	VBC6A-30-10-04	4/13
GJL1213911R0105	VBC6A-30-10-05	4/13
GJL1213911R0107	VBC6A-30-10-07	4/13
GJL1213911R1016	VBC6A-30-01-16	4/13
GJL1213911R1106	VBC6A-30-10-16	4/13
GJL1311001R0011	B7-30-01-01	4/8
GJL1311001R0012	B7-30-01-02	4/8
GJL1311001R0013	B7-30-01-03	4/8
GJL1311001R0101	B7-30-10-01	4/8
GJL1311001R0102	B7-30-10-02	4/8
GJL1311001R0103	B7-30-10-03	4/8
GJL1311001R8010	B7-30-01-80	4/8
GJL1311001R8014	B7-30-01-84	4/8
GJL1311001R8015	B7-30-01-85	4/8
GJL1311001R8100	B7-30-10-80	4/8

Order code	Type	Page
GJL1311001R8104	B7-30-10-84	4/8
GJL1311001R8105	B7-30-10-85	4/8
GJL1311003R0011	B7-30-01-F-01	4/30
GJL1311003R0012	B7-30-01-F-02	4/30
GJL1311003R0013	B7-30-01-F-03	4/30
GJL1311003R0101	B7-30-10-F-01	4/30
GJL1311003R0102	B7-30-10-F-02	4/30
GJL1311003R0103	B7-30-10-F-03	4/30
GJL1311003R8010	B7-30-01-F-80	4/30
GJL1311003R8014	B7-30-01-F-84	4/30
GJL1311003R8015	B7-30-01-F-85	4/30
GJL1311003R8100	B7-30-10-F-80	4/30
GJL1311003R8104	B7-30-10-F-84	4/30
GJL1311003R8105	B7-30-10-F-85	4/30
GJL1311009R0011	B7-30-01-P-01	4/20
GJL1311009R0012	B7-30-01-P-02	4/20
GJL1311009R0013	B7-30-01-P-03	4/20
GJL1311009R0101	B7-30-10-P-01	4/20
GJL1311009R0102	B7-30-10-P-02	4/20
GJL1311009R0103	B7-30-10-P-03	4/20
GJL1311009R8010	B7-30-01-P-80	4/20
GJL1311009R8014	B7-30-01-P-84	4/20
GJL1311009R8015	B7-30-01-P-85	4/20
GJL1311009R8100	B7-30-10-P-80	4/20
GJL1311009R8104	B7-30-10-P-84	4/20
GJL1311009R8105	B7-30-10-P-85	4/20
GJL1311201R0001	B7-40-00-01	4/15
GJL1311201R0002	B7-40-00-02	4/15
GJL1311201R0003	B7-40-00-03	4/15
GJL1311201R0000	B7-40-00-80	4/15
GJL1311201R8004	B7-40-00-84	4/15
GJL1311501R0001	B7-22-00-01	4/15
GJL1311501R0002	B7-22-00-02	4/15
GJL1311501R0003	B7-22-00-03	4/15
GJL1311501R8000	B7-22-00-80	4/15
GJL1311501R8004	B7-22-00-84	4/15
GJL1311901R0011	VB7-30-01-01	4/10
GJL1311901R0012	VB7-30-01-02	4/10
GJL1311901R0013	VB7-30-01-03	4/10
GJL1311901R0101	VB7-30-10-01	4/10
GJL1311901R0102	VB7-30-10-02	4/10
GJL1311901R0103	VB7-30-10-03	4/10
GJL1311901R8010	VB7-30-01-80	4/10
GJL1311901R8014	VB7-30-01-84	4/10
GJL1311901R8015	VB7-30-01-85	4/10
GJL1311901R8100	VB7-30-10-80	4/10
GJL1311901R8104	VB7-30-10-84	4/10
GJL1311901R8105	VB7-30-10-85	4/10
GJL1311903R0011	VB7-30-01-F-01	4/32
GJL1311903R0012	VB7-30-01-F-02	4/32
GJL1311903R0013	VB7-30-01-F-03	4/32
GJL1311903R0101	VB7-30-10-F-01	4/32
GJL1311903R0102	VB7-30-10-F-02	4/32
GJL1311903R0103	VB7-30-10-F-03	4/32
GJL1311903R8010	VB7-30-01-F-80	4/32
GJL1311903R8014	VB7-30-01-F-84	4/32
GJL1311903R8015	VB7-30-01-F-85	4/32
GJL1311903R8100	VB7-30-10-F-80	4/32
GJL1311903R8104	VB7-30-10-F-84	4/32
GJL1311903R8105	VB7-30-10-F-85	4/32
GJL1311909R0011	VB7-30-01-P-01	4/22
GJL1311909R0012	VB7-30-01-P-02	4/22
GJL1311909R0013	VB7-30-01-P-03	4/22
GJL1311909R0101	VB7-30-10-P-01	4/22
GJL1311909R0102	VB7-30-10-P-02	4/22
GJL1311909R0103	VB7-30-10-P-03	4/22
GJL1311909R8010	VB7-30-01-P-80	4/22

Order code	Type	Page
GJL1311909R8014	VB7-30-01-P-84	4/22
GJL1311909R8015	VB7-30-01-P-85	4/22
GJL1311909R8100	VB7-30-10-P-80	4/22
GJL1311909R8104	VB7-30-10-P-84	4/22
GJL1311909R8105	VB7-30-10-P-85	4/22
GJL1311911R0011	VB7A-30-01-01	4/12
GJL1311911R0012	VB7A-30-01-02	4/12
GJL1311911R0013	VB7A-30-01-03	4/12
GJL1311911R0101	VB7A-30-10-01	4/12
GJL1311911R0102	VB7A-30-10-02	4/12
GJL1311911R0103	VB7A-30-10-03	4/12
GJL1311911R8010	VB7A-30-01-80	4/12
GJL1311911R8014	VB7A-30-01-84	4/12
GJL1311911R8015	VB7A-30-01-85	4/12
GJL1311911R8100	VB7A-30-10-80	4/12
GJL1311911R8104	VB7A-30-10-84	4/12
GJL1311911R8105	VB7A-30-10-85	4/12
GJL1311913R0011	VB7A-30-01-F-01	4/34
GJL1311913R0012	VB7A-30-01-F-02	4/34
GJL1311913R0013	VB7A-30-01-F-03	4/34
GJL1311913R0101	VB7A-30-10-F-01	4/34
GJL1311913R0102	VB7A-30-10-F-02	4/34
GJL1311913R0103	VB7A-30-10-F-03	4/34
GJL1311913R8010	VB7A-30-01-F-80	4/34
GJL1311913R8014	VB7A-30-01-F-84	4/34
GJL1311913R8015	VB7A-30-01-F-85	4/34
GJL1311913R8100	VB7A-30-10-F-80	4/34
GJL1311913R8104	VB7A-30-10-F-84	4/34
GJL1311913R8105	VB7A-30-10-F-85	4/34
GJL1311919R0011	VB7A-30-01-P-01	4/24
GJL1311919R0012	VB7A-30-01-P-02	4/24
GJL1311919R0013	VB7A-30-01-P-03	4/24
GJL1311919R0101	VB7A-30-10-P-01	4/24
GJL1311919R0102	VB7A-30-10-P-02	4/24
GJL1311919R0103	VB7A-30-10-P-03	4/24
GJL1311919R8010	VB7A-30-01-P-80	4/24
GJL1311919R8014	VB7A-30-01-P-84	4/24
GJL1311919R8015	VB7A-30-01-P-85	4/24
GJL1311919R8100	VB7A-30-10-P-80	4/24
GJL1311919R8104	VB7A-30-10-P-84	4/24
GJL1311919R8105	VB7A-30-10-P-85	4/24
GJL1313001R0011	BC7-30-01-01	4/9
GJL1313001R0013	BC7-30-01-03	4/9
GJL1313001R0014	BC7-30-01-04	4/9
GJL1313001R0015	BC7-30-01-05	4/9
GJL1313001R0017	BC7-30-01-07	4/9
GJL1313001R0101	BC7-30-10-01	4/9
GJL1313001R0104	BC7-30-10-04	4/9
GJL1313001R0105	BC7-30-10-05	4/9
GJL1313001R0107	BC7-30-10-07	4/9
GJL1313001R0106	BC7-30-01-16	4/9
GJL1313001R1103	BC7-30-10-03	4/9
GJL1313001R1106	BC7-30-10-16	4/9
GJL1313001R5011	BC7-30-01-2.4-51	4/14
GJL1313001R5101	BC7-30-10-2.4-51	4/14
GJL1313001R7011	B7S-30-01-1.7-71	4/14
GJL1313001R7012	B7S-30-01-2.8-72	4/14
GJL1313001R7101	B7S-30-10-1.7-71	4/14
GJL1313001R7102	B7S-30-10-2.8-72	4/14
GJL1313001R8011	BC7-30-01-1.4-81	4/14
GJL1313001R8101	BC7-30-10-1.4-81	4/14
GJL1313003R0011	BC7-30-01-F-01	4/31
GJL1313003R0013	BC7-30-01-F-03	4/31
GJL1313003R0014	BC7-30-01-F-04	4/31
GJL1313003R0015	BC7-30-01-F-05	4/31
GJL1313003R0017	BC7-30-01-F-07	4/31
GJL1313003R0101	BC7-30-10-F-01	4/31

# Index

## Order code classification

Order code	Type	Page
GJL1313003R0103	BC7-30-10-F-03	4/31
GJL1313003R0104	BC7-30-10-F-04	4/31
GJL1313003R0105	BC7-30-10-F-05	4/31
GJL1313003R0107	BC7-30-10-F-07	4/31
GJL1313003R1016	BC7-30-01-F-16	4/31
GJL1313003R1106	BC7-30-10-F-16	4/31
GJL1313003R5011	BC7-30-01-F-2.4-51	4/36
GJL1313003R5101	BC7-30-10-F-2.4-51	4/36
GJL1313003R8011	BC7-30-01-F-1.4-81	4/36
GJL1313003R8101	BC7-30-10-F-1.4-81	4/36
GJL1313009R0011	BC7-30-01-P-01	4/21
GJL1313009R0013	BC7-30-01-P-03	4/21
GJL1313009R0014	BC7-30-10-P-04	4/21
GJL1313009R0015	BC7-30-01-P-05	4/21
GJL1313009R0017	BC7-30-01-P-07	4/21
GJL1313009R0101	BC7-30-10-P-01	4/21
GJL1313009R0103	BC7-30-10-P-03	4/21
GJL1313009R0104	BC7-30-10-P-04	4/21
GJL1313009R0105	BC7-30-10-P-05	4/21
GJL1313009R0107	BC7-30-10-P-07	4/21
GJL1313009R1016	BC7-30-01-P-16	4/21
GJL1313009R1106	BC7-30-10-P-16	4/21
GJL1313009R5011	BC7-30-01-P-2.4-51	4/26
GJL1313009R5101	BC7-30-10-P-2.4-51	4/26
GJL1313009R8011	BC7-30-01-P-1.4-81	4/26
GJL1313009R8101	BC7-30-10-P-1.4-81	4/26
GJL1313901R0011	VBC7-30-01-01	4/11
GJL1313901R0013	VBC7-30-01-03	4/11
GJL1313901R0014	VBC7-30-01-04	4/11
GJL1313901R0015	VBC7-30-01-05	4/11
GJL1313901R0017	VBC7-30-01-07	4/11
GJL1313901R0101	VBC7-30-10-01	4/11
GJL1313901R0103	VBC7-30-10-03	4/11
GJL1313901R0104	VBC7-30-10-04	4/11
GJL1313901R0105	VBC7-30-10-05	4/11
GJL1313901R0107	VBC7-30-10-07	4/11
GJL1313901R0106	VBC7-30-01-16	4/11
GJL1313901R1106	VBC7-30-10-16	4/11
GJL1313903R0011	VBC7-30-01-F-01	4/33
GJL1313903R0013	VBC7-30-01-F-03	4/33
GJL1313903R0014	VBC7-30-01-F-04	4/33
GJL1313903R0015	VBC7-30-01-F-05	4/33
GJL1313903R0017	VBC7-30-01-F-07	4/33
GJL1313903R0101	VBC7-30-10-F-01	4/33
GJL1313903R0103	VBC7-30-10-F-03	4/33
GJL1313903R0104	VBC7-30-10-F-04	4/33
GJL1313903R0105	VBC7-30-10-F-05	4/33
GJL1313903R0107	VBC7-30-10-F-07	4/33
GJL1313903R1016	VBC7-30-01-F-16	4/33
GJL1313903R1106	VBC7-30-10-F-16	4/33
GJL1313909R0011	VBC7-30-01-P-01	4/23
GJL1313909R0013	VBC7-30-01-P-03	4/23
GJL1313909R0014	VBC7-30-01-P-04	4/23
GJL1313909R0015	VBC7-30-01-P-05	4/23
GJL1313909R0017	VBC7-30-01-P-07	4/23
GJL1313909R0101	VBC7-30-10-P-01	4/23
GJL1313909R0103	VBC7-30-10-P-03	4/23
GJL1313909R0104	VBC7-30-10-P-04	4/23
GJL1313909R0105	VBC7-30-10-P-05	4/23
GJL1313909R0107	VBC7-30-10-P-07	4/23
GJL1313909R1016	VBC7-30-01-P-16	4/23
GJL1313911R0011	VBC7A-30-01-01	4/13
GJL1313911R0013	VBC7A-30-01-03	4/13
GJL1313911R0014	VBC7A-30-01-04	4/13
GJL1313911R0015	VBC7A-30-01-05	4/13
GJL1313911R0016	VBC7A-30-01-16	4/13

Order code	Type	Page
GJL1313911R0017	VBC7A-30-01-07	4/13
GJL1313911R0101	VBC7A-30-10-01	4/13
GJL1313911R0103	VBC7A-30-10-03	4/13
GJL1313911R0104	VBC7A-30-10-04	4/13
GJL1313911R0105	VBC7A-30-10-05	4/13
GJL1313911R0107	VBC7A-30-10-07	4/13
GJL1313911R1106	VBC7A-30-10-16	4/13
GJL1313913R0011	VBC7A-30-01-F-01	4/35
GJL1313913R0013	VBC7A-30-01-F-03	4/35
GJL1313913R0014	VBC7A-30-01-F-04	4/35
GJL1313913R0015	VBC7A-30-01-F-05	4/35
GJL1313913R0017	VBC7A-30-01-F-07	4/35
GJL1313913R0101	VBC7A-30-10-F-01	4/35
GJL1313913R0103	VBC7A-30-10-F-03	4/35
GJL1313913R0104	VBC7A-30-10-F-04	4/35
GJL1313913R0105	VBC7A-30-10-F-05	4/35
GJL1313913R0107	VBC7A-30-10-F-07	4/35
GJL1313913R1016	VBC7A-30-01-F-16	4/35
GJL1313913R1106	VBC7A-30-10-F-16	4/35
GJL1313919R0011	VBC7A-30-01-P-01	4/25
GJL1313919R0013	VBC7A-30-01-P-03	4/25
GJL1313919R0014	VBC7A-30-01-P-04	4/25
GJL1313919R0015	VBC7A-30-01-P-05	4/25
GJL1313919R0017	VBC7A-30-01-P-07	4/25
GJL1313919R0101	VBC7A-30-10-P-01	4/25
GJL1313919R0103	VBC7A-30-10-P-03	4/25
GJL1313919R0104	VBC7A-30-10-P-04	4/25
GJL1313919R0106	VBC7A-30-01-P-16	4/25
GJL1313919R1106	VBC7A-30-10-P-16	4/25
GJL1317001R0011	B7D-30-01-01	4/9
GJL1317001R0015	B7D-30-01-05	4/9
GJL1317001R0101	B7D-30-10-01	4/9
GJL1317001R0105	B7D-30-10-05	4/9
GJL1317201R0001	B7D-40-00-01	4/16
GJL1317201R0005	B7D-40-00-05	4/16
SK178001-LB	LT550-EK	3/302
SK178001-MB	LT1000-EK	3/302
SK827041-AD	EK550-40-11	3/148
SK827041-AR	EK550-40-11	3/148
SK827041-DB	EK550-40-21	3/149
SK827041-DD	EK550-40-21	3/149
SK827041-DE	EK550-40-21	3/149
SK827041-DF	EK550-40-21	3/149
SK827041-DG	EK550-40-21	3/149
SK827041-DU	EK550-40-21	3/149
SK827041-EF	EK550-40-11	3/148
SK827041-EG	EK550-40-11	3/148
SK827041-EL	EK550-40-11	3/148
SK827041-EM	EK550-40-11	3/148
SK827043-AD	EK550-40-22	3/150
SK827043-AR	EK550-40-22	3/150
SK827043-EF	EK550-40-22	3/150
SK827043-EG	EK550-40-22	3/150
SK827043-EL	EK550-40-22	3/150
SK827043-EM	EK550-40-22	3/150
SK827044-AD	EK1000-40-11	3/148
SK827044-AR	EK1000-40-11	3/148
SK827044-DB	EK1000-40-21	3/149
SK827044-DC	EK1000-40-21	3/149
SK827044-DD	EK1000-40-21	3/149
SK827044-DE	EK1000-40-21	3/149
SK827044-DF	EK1000-40-21	3/149
SK827044-DG	EK1000-40-21	3/149
SK827044-DT	EK1000-40-21	3/149
SK827044-DU	EK1000-40-21	3/149

Order code	Type	Page
SK827044-EF	EK1000-40-11	3/148
SK827044-EG	EK1000-40-11	3/148
SK827044-EL	EK1000-40-11	3/148
SK827044-EM	EK1000-40-11	3/148
SK827045-AD	EK1000-40-22	3/150
SK827045-AR	EK1000-40-22	3/150
SK827045-EF	EK1000-40-22	3/150
SK827045-EG	EK1000-40-22	3/150
SK827045-EL	EK1000-40-22	3/150
SK827045-EM	EK1000-40-22	3/150
SK827045-EP	EK1000-40-22	3/150
SK827045-ER	EK1000-40-22	3/150
SK827204-B	KZK550	3/305
SK827204-F	KZK1000	3/305
SK828100-AD	KH800	3/306
SK828100-AR	KH800	3/306
SK828100-EF	KH800	3/306
SK828100-EG	KH800	3/306
SK828100-EL	KH800	3/306
SK828100-EM	KH800	3/306
SK828100-ER	KH800	3/306
SK828150-DB	KP800	3/306
SK828150-DE	KP800	3/306
SK828150-DF	KP800	3/306
SK828150-DU	KP800	3/306
SK829002-A	CAL16-11A	3/298
SK829002-B	CAL16-11B	3/152
SK829002-C	CAL16-11C	3/152
SK829002-D	CAL16-11D	3/152
SK829002-E	CCL16-11E	3/152
SK829007-C	RC-EH800/110	3/152
SK829007-D	RC-EH800/600	3/152
SK829070-F	VH800	3/152
SK829090-E	BSS550	3/152
SK829090-H	BSS1000	3/152
1SDA054988R1	1SDA055020R1	3/70
1SDA066917R1	1SDA055016R1	3/70
1SFN074709R1000,	1SCA022194R0890	3/163
2CCS801901R0539	412012	8/2
2CCS801901R0599	412036	8/2
2CCS801901R0639	411992	8/2
2CCS802901R0539	412074	8/2
2CCS802901R0599	412098	8/2
2CCS802901R0639	412050	8/2
2CCS803901R0539	411930	8/2
2CCS803901R0599	411947	8/2
2CCS803901R0639	411954	8/2
2CCS803917R0539	412319	8/2
2CCS803917R0599	412326	8/2
2CCS803917R0639	412302	8/2



# Index

## Type classification

Type	Order code	Page	Type	Order code	Page	Type	Order code	Page
AA1-110	1SAM201910R1002	2/36	AF116-30-00-11	1SFL427001R1100	3/19	AF12-30-01K-13	1SBL157005R1301	3/90
AA1-230	1SAM201910R1003	2/36	AF116-30-00-12	1SFL427001R1200	3/19	AF12-30-01K-14	1SBL157005R1401	3/90
AA1-24	1SAM201910R1001	2/36	AF116-30-00-13	1SFL427001R1300	3/19	AF12-30-10-11	1SBL157001R1110	3/14
AA1-400	1SAM201910R1004	2/36	AF116-30-00-14	1SFL427001R1400	3/19	AF12-30-10-12	1SBL157001R1210	3/14
AF09-22-00-11	1SBL137501R1100	3/134	AF116-30-00-33	1SFL427001R3300	3/20	AF12-30-10-13	1SBL157001R1310	3/14
AF09-22-00-12	1SBL137501R1200	3/134	AF116-30-00-34	1SFL427001R3400	3/20	AF12-30-10-14	1SBL157001R1410	3/14
AF09-22-00-13	1SBL137501R1300	3/134	AF116-30-00B-11	1SFL427002R1100	3/19	AF12-30-10K-11	1SBL157005R1110	3/90
AF09-22-00-14	1SBL137501R1400	3/134	AF116-30-00B-12	1SFL427002R1200	3/19	AF12-30-10K-12	1SBL157005R1210	3/90
AF09-30-01-11	1SBL137001R1101	3/14	AF116-30-00B-13	1SFL427002R1300	3/19	AF12-30-10K-13	1SBL157005R1310	3/90
AF09-30-01-12	1SBL137001R1201	3/14	AF116-30-00B-14	1SFL427002R1400	3/19	AF12-30-10K-14	1SBL157005R1410	3/90
AF09-30-01-13	1SBL137001R1301	3/14	AF116-30-00B-33	1SFL427002R3300	3/20	AF12-30-22-11	1SBL157001R1122	3/38
AF09-30-01-14	1SBL137001R1401	3/14	AF116-30-00B-34	1SFL427002R3400	3/20	AF12-30-22-12	1SBL157001R1222	3/38
AF09-30-01K-11	1SBL137005R1101	3/90	AF116-30-11-11	1SFL427001R1111	3/29	AF12-30-22-13	1SBL157001R1322	3/38
AF09-30-01K-12	1SBL137005R1201	3/90	AF116-30-11-11	1SFL427001R1111	12/85	AF12-30-22-14	1SBL157001R1422	3/38
AF09-30-01K-13	1SBL137005R1301	3/90	AF116-30-11-12	1SFL427001R1211	3/29	AF1250-30-11	1SFL647001R6811	3/35
AF09-30-01K-14	1SBL137005R1401	3/90	AF116-30-11-13	1SFL427001R1311	3/29		1SFL647001R6911	3/35
AF09-30-10-11	1SBL137001R1110	3/14	AF116-30-11-14	1SFL427001R1411	3/29		1SFL647001R7011	3/35
AF09-30-10-12	1SBL137001R1210	3/14	AF116-30-11-33	1SFL427001R3311	3/30		1SFL647001R7111	3/35
AF09-30-10-13	1SBL137001R1310	3/14	AF116-30-11-34	1SFL427001R3411	3/30	AF1250-30-22	1SFL647001R6822	3/48
AF09-30-10-14	1SBL137001R1410	3/14	AF116-30-11B-11	1SFL427002R1111	3/29		1SFL647001R6922	3/48
AF09-30-10K-11	1SBL137005R1110	3/90	AF116-30-11B-12	1SFL427002R1211	3/29		1SFL647001R7022	3/48
AF09-30-10K-12	1SBL137005R1210	3/90	AF116-30-11B-13	1SFL427002R1311	3/29		1SFL647001R7122	3/48
AF09-30-10K-13	1SBL137005R1310	3/90	AF116-30-11B-14	1SFL427002R1411	3/29	AF12Z-30-01-20	1SBL156001R2001	3/16
AF09-30-10K-14	1SBL137005R1410	3/90	AF116-30-11B-33	1SFL427002R3311	3/30	AF12Z-30-01-21	1SBL156001R2101	3/16
AF09-30-22-11	1SBL137001R1122	3/38	AF116-30-11B-34	1SFL427002R3411	3/30	AF12Z-30-01-22	1SBL156001R2201	3/16
AF09-30-22-12	1SBL137001R1222	3/38	AF116-30-22-11	1SFL427001R1222	3/42	AF12Z-30-01-23	1SBL156001R2301	3/16
AF09-30-22-13	1SBL137001R1322	3/38	AF116-30-22-12	1SFL427001R1322	3/42	AF12Z-30-01-30	1SBL156001R3001	3/15
AF09-30-22-14	1SBL137001R1422	3/38	AF116-30-22-13	1SFL427001R1322	3/42	AF12Z-30-01K-20	1SBL156005R2001	3/92
AF09-40-00-11	1SBL137201R1100	3/134	AF116-30-22-14	1SFL427001R1422	3/42	AF12Z-30-01K-21	1SBL156005R2101	3/92
AF09-40-00-12	1SBL137201R1200	3/134	AF116-30-22-33	1SFL427001R3322	3/43	AF12Z-30-01K-22	1SBL156005R2201	3/92
AF09-40-00-13	1SBL137201R1300	3/134	AF116-30-22-34	1SFL427001R3422	3/43	AF12Z-30-01K-23	1SBL156005R2301	3/92
AF09-40-00-14	1SBL137201R1400	3/134	AF116-30-22B-11	1SFL427002R1122	3/42	AF12Z-30-01K-30	1SBL156005R3001	3/91
AF09Z-22-00-20	1SBL136501R2000	3/136	AF116-30-22B-12	1SFL427002R1222	3/42	AF12Z-30-10-11	1SBL156001R1110	12/6
AF09Z-22-00-21	1SBL136501R2100	3/136	AF116-30-22B-13	1SFL427002R1322	3/42	AF12Z-30-10-20	1SBL156001R2010	3/16
AF09Z-22-00-22	1SBL136501R2200	3/136	AF116-30-22B-14	1SFL427002R1422	3/42	AF12Z-30-10-21	1SBL156001R2110	3/16
AF09Z-22-00-23	1SBL136501R2300	3/136	AF116-30-22B-33	1SFL427002R3322	3/43	AF12Z-30-10-22	1SBL156001R2210	3/16
AF09Z-22-00-30	1SBL136501R3000	3/135	AF116-30-22B-34	1SFL427002R3422	3/43	AF12Z-30-10-23	1SBL156001R2310	3/16
AF09Z-30-01-20	1SBL136001R2001	3/16	AF116-40-00-11	1SFL427101R1100	3/139	AF12Z-30-10-30	1SBL156001R3010	3/15
AF09Z-30-01-21	1SBL136001R2101	3/16	AF116-40-00-12	1SFL427101R1200	3/139	AF12Z-30-10K-20	1SBL156005R2010	3/92
AF09Z-30-01-22	1SBL136001R2201	3/16	AF116-40-00-13	1SFL427101R1300	3/139	AF12Z-30-10K-21	1SBL156005R2110	3/92
AF09Z-30-01-23	1SBL136001R2301	3/16	AF116-40-00-14	1SFL427101R1400	3/139	AF12Z-30-10K-22	1SBL156005R2210	3/92
AF09Z-30-01-30	1SBL136001R3001	3/15	AF116-40-00B-11	1SFL427102R1100	3/139	AF12Z-30-10K-23	1SBL156005R2310	3/92
AF09Z-30-01K-20	1SBL136005R2001	3/92	AF116-40-00B-12	1SFL427102R1200	3/139	AF12Z-30-10K-30	1SBL156005R3010	3/91
AF09Z-30-01K-21	1SBL136005R2101	3/92	AF116-40-00B-13	1SFL427102R1300	3/139	AF12Z-30-22-20	1SBL156001R2022	3/39
AF09Z-30-01K-22	1SBL136005R2201	3/92	AF116-40-00B-14	1SFL427102R1400	3/139	AF12Z-30-22-21	1SBL156001R2122	3/39
AF09Z-30-01K-23	1SBL136005R2301	3/92	AF116-40-11-11	1SFL427101R1111	3/142	AF12Z-30-22-22	1SBL156001R2222	3/39
AF09Z-30-01K-30	1SBL136005R3001	3/91	AF116-40-11-12	1SFL427101R1211	3/142	AF12Z-30-22-23	1SBL156001R2322	3/39
AF09Z-30-10-11	1SBL136001R1110	12/6	AF116-40-11-13	1SFL427101R1311	3/142	AF1350-30-11	1SFL657001R7011	3/35
AF09Z-30-10-20	1SBL136001R2010	3/16	AF116-40-11-14	1SFL427101R1411	3/142	AF1350-30-22	1SFL657001R7022	3/48
AF09Z-30-10-21	1SBL136001R2110	3/16	AF116-40-11B-11	1SFL427102R1111	3/142	AF1350T-30-11	1SFL657001R9101	3/36
AF09Z-30-10-22	1SBL136001R2210	3/16	AF116-40-11B-12	1SFL427102R1211	3/142	AF140-30-00-11	1SFL447001R1100	3/19
AF09Z-30-10-23	1SBL136001R2310	3/16	AF116-40-11B-13	1SFL427102R1311	3/142	AF140-30-00-12	1SFL447001R1200	3/19
AF09Z-30-10-30	1SBL136001R3010	3/15	AF116-40-11B-14	1SFL427102R1411	3/142	AF140-30-00-13	1SFL447001R1300	3/19
AF09Z-30-10K-20	1SBL136005R2010	3/92	AF116-40-22-11	1SFL427101R1122	3/145	AF140-30-00-14	1SFL447001R1400	3/19
AF09Z-30-10K-21	1SBL136005R2110	3/92	AF116-40-22-12	1SFL427101R1222	3/145	AF140-30-00-33	1SFL447001R3300	3/20
AF09Z-30-10K-22	1SBL136005R2210	3/92	AF116-40-22-13	1SFL427101R1322	3/145	AF140-30-00-34	1SFL447001R3400	3/20
AF09Z-30-10K-23	1SBL136005R2310	3/92	AF116-40-22-14	1SFL427101R1422	3/145	AF140-30-00B-11	1SFL447002R1100	3/19
AF09Z-30-10K-30	1SBL136005R3010	3/91	AF116-40-22B-11	1SFL427102R1122	3/145	AF140-30-00B-12	1SFL447002R1200	3/19
AF09Z-30-22-20	1SBL136001R2022	3/39	AF116-40-22B-12	1SFL427102R1222	3/145	AF140-30-00B-13	1SFL447002R1300	3/19
AF09Z-30-22-21	1SBL136001R2122	3/39	AF116-40-22B-13	1SFL427102R1322	3/145	AF140-30-00B-14	1SFL447002R1400	3/19
AF09Z-30-22-22	1SBL136001R2222	3/39	AF116-40-22B-14	1SFL427102R1422	3/145	AF140-30-00B-33	1SFL447002R3300	3/20
AF09Z-30-22-23	1SBL136001R2322	3/39	AF12-30-01-11	1SBL157001R1101	3/14	AF140-30-00B-34	1SFL447002R3400	3/20
AF09Z-40-00-20	1SBL136201R2000	3/136	AF12-30-01-12	1SBL157001R1201	3/14	AF140-30-11-11	1SFL447001R1111	3/29
AF09Z-40-00-21	1SBL136201R2100	3/136	AF12-30-01-13	1SBL157001R1301	3/14	AF140-30-11-12	1SFL447001R1211	3/29
AF09Z-40-00-22	1SBL136201R2200	3/136	AF12-30-01-14	1SBL157001R1401	3/14	AF140-30-11-13	1SFL447001R1311	3/29
AF09Z-40-00-23	1SBL136201R2300	3/136	AF12-30-01K-11	1SBL157005R1101	3/90	AF140-30-11-14	1SFL447001R1411	3/29
AF09Z-40-00-30	1SBL136201R3000	3/135	AF12-30-01K-12	1SBL157005R1201	3/90	AF140-30-11-33	1SFL447001R3311	3/30

# Index

## Type classification

Type	Order code	Page	Type	Order code	Page	Type	Order code	Page
AF140-30-11-34	1SFL447001R3411	3/30	AF146-30-22-11	1SFL467001R1122	3/42	AF16Z-30-10K-22	1SBL176005R2210	3/92
AF140-30-11B-11	1SFL447002R1111	3/29	AF146-30-22-12	1SFL467001R1222	3/42	AF16Z-30-10K-23	1SBL176005R2310	3/92
AF140-30-11B-12	1SFL447002R1211	3/29	AF146-30-22-13	1SFL467001R1322	3/42	AF16Z-30-10K-30	1SBL176005R3010	3/91
AF140-30-11B-13	1SFL447002R1311	3/29	AF146-30-22-14	1SFL467001R1422	3/42	AF16Z-30-22-20	1SBL176001R2022	3/39
AF140-30-11B-14	1SFL447002R1411	3/29	AF146-30-22-33	1SFL467001R3322	3/43	AF16Z-30-22-21	1SBL176001R2122	3/39
AF140-30-11B-33	1SFL447002R3311	3/30	AF146-30-22-34	1SFL467001R3422	3/43	AF16Z-30-22-22	1SBL176001R2222	3/39
AF140-30-11B-34	1SFL447002R3411	3/30	AF166-30-22B-11	1SFL467002R1122	3/42	AF16Z-30-22-23	1SBL176001R2322	3/39
AF140-30-22-11	1SFL447001R1122	3/42	AF146-30-22B-12	1SFL467002R1222	3/42	AF16Z-40-00-20	1SBL176201R2000	3/136
AF140-30-22-12	1SFL447001R1222	3/42	AF146-30-22B-13	1SFL467002R1322	3/42	AF16Z-40-00-21	1SBL176201R2100	3/136
AF140-30-22-13	1SFL447001R1322	3/42	AF146-30-22B-14	1SFL467002R1422	3/42	AF16Z-40-00-22	1SBL176201R2200	3/136
	1SFL447001R1422	3/42	AF146-30-22B-33	1SFL467002R3322	3/43	AF16Z-40-00-23	1SBL176201R2300	3/136
AF140-30-22-33	1SFL447001R3322	3/43	AF146-30-22B-34	1SFL467002R3422	3/43	AF16Z-40-00-30	1SBL176201R3000	3/135
AF140-30-22-34	1SFL447001R3422	3/43	AF16-22-00-11	1SBL177501R1100	3/134	AF190-30-00-11	1SFL487002R1100	3/21
AF140-30-22B-11	1SFL447002R1122	3/42	AF16-22-00-12	1SBL177501R1200	3/134	AF190-30-00-12	1SFL487002R1200	3/21
AF140-30-22B-12	1SFL447002R1222	3/42	AF16-22-00-13	1SBL177501R1300	3/134	AF190-30-00-13	1SFL487002R1300	3/21
AF140-30-22B-13	1SFL447002R1322	3/42	AF16-22-00-14	1SBL177501R1400	3/134	AF190-30-00-14	1SFL487002R1400	3/21
AF140-30-22B-14	1SFL447002R1422	3/42	AF16-30-01-11	1SBL177001R1101	3/14	AF190-30-00-33	1SFL487002R3300	3/22
AF140-30-22B-33	1SFL447002R3322	3/43	AF16-30-01-12	1SBL177001R1201	3/14	AF190-30-00-34	1SFL487002R3400	3/22
AF140-30-22B-34	1SFL447002R3422	3/43	AF16-30-01-13	1SBL177001R1301	3/14	AF190-30-11-11	1SFL487002R1111	3/31
AF140-40-00-11	1SFL447101R1100	3/139	AF16-30-01-14	1SBL177001R1401	3/14	AF190-30-11-12	1SFL487002R1211	3/31
AF140-40-00-12	1SFL447101R1200	3/139	AF16-30-01K-11	1SBL177005R1101	3/90	AF190-30-11-13	1SFL487002R1311	3/31
AF140-40-00-13	1SFL447101R1300	3/139	AF16-30-01K-12	1SBL177005R1201	3/90	AF190-30-11-14	1SFL487002R1411	3/31
AF140-40-00-14	1SFL447101R1400	3/139	AF16-30-01K-13	1SBL177005R1301	3/90	AF190-30-11-33	1SFL487002R3311	3/32
AF140-40-00B-11	1SFL447102R1100	3/139	AF16-30-01K-14	1SBL177005R1401	3/90	AF190-30-11-34	1SFL487002R3411	3/32
AF140-40-00B-12	1SFL447102R1200	3/139	AF16-30-10-11	1SBL177001R1110	3/14	AF190-30-22-11	1SFL487002R1122	3/44
AF140-40-00B-13	1SFL447102R1300	3/139	AF16-30-10-12	1SBL177001R1210	3/14	AF190-30-22-12	1SFL487002R1222	3/44
AF140-40-00B-14	1SFL447102R1400	3/139	AF16-30-10-13	1SBL177001R1310	3/14	AF190-30-22-13	1SFL487002R1322	3/44
AF140-40-11-11	1SFL447101R1111	3/142	AF16-30-10-14	1SBL177001R1410	3/14	AF190-30-22-14	1SFL487002R1422	3/44
AF140-40-11-12	1SFL447101R1211	3/142	AF16-30-10K-11	1SBL177005R1110	3/90	AF190-30-22-33	1SFL487002R3322	3/45
AF140-40-11-13	1SFL447101R1311	3/142	AF16-30-10K-12	1SBL177005R1210	3/90	AF190-30-22-34	1SFL487002R3422	3/45
AF140-40-11-14	1SFL447101R1411	3/142	AF16-30-10K-13	1SBL177005R1310	3/90	AF190-40-00-11	1SFL487102R1100	3/140
AF140-40-11B-11	1SFL447102R1111	3/142	AF16-30-10K-14	1SBL177005R1410	3/90	AF190-40-00-12	1SFL487102R1200	3/140
AF140-40-11B-12	1SFL447102R1211	3/142	AF16-30-22-11	1SBL177001R1122	3/38	AF190-40-00-13	1SFL487102R1300	3/140
AF140-40-11B-13	1SFL447102R1311	3/142	AF16-30-22-12	1SBL177001R1222	3/38	AF190-40-00-14	1SFL487102R1400	3/140
AF140-40-11B-14	1SFL447102R1411	3/142	AF16-30-22-13	1SBL177001R1322	3/38	AF190-40-11-11	1SFL487102R1111	3/143
AF140-40-22-11	1SFL447101R1122	3/145	AF16-30-22-14	1SBL177001R1422	3/38	AF190-40-11-12	1SFL487102R1211	3/143
AF140-40-22-12	1SFL447101R1222	3/145	AF16-40-00-11	1SBL177201R1100	3/134	AF190-40-11-13	1SFL487102R1311	3/143
AF140-40-22-13	1SFL447101R1322	3/145	AF16-40-00-12	1SBL177201R1200	3/134	AF190-40-11-14	1SFL487102R1411	3/143
AF140-40-22-14	1SFL447101R1422	3/145	AF16-40-00-13	1SBL177201R1300	3/134	AF190-40-22-11	1SFL487102R1122	3/146
AF140-40-22B-11	1SFL447102R1122	3/145	AF16-40-00-14	1SBL177201R1400	3/134	AF190-40-22-12	1SFL487102R1222	3/146
AF140-40-22B-12	1SFL447102R1222	3/145	AF1650-30-11	1SFL677001R7011	3/35	AF190-40-22-13	1SFL487102R1322	3/146
AF140-40-22B-13	1SFL447102R1322	3/145	AF1650-30-22	1SFL677001R7022	3/48	AF190-40-22-14	1SFL487102R1422	3/146
AF140-40-22B-14	1SFL447102R1422	3/145	AF1650T-30-11	1SFL677001R9101	3/36	AF2050-30-11	1SFL707001R7011	3/35
AF146-30-00-11	1SFL467001R1100	3/19	AF16Z-22-00-20	1SBL176501R2000	3/136	AF2050-30-22	1SFL707001R7022	3/48
AF146-30-00-12	1SFL467001R1200	3/19	AF16Z-22-00-21	1SBL176501R2100	3/136	AF2050T-30-11	1SFL707001R9101	3/36
AF146-30-00-13	1SFL467001R1300	3/19	AF16Z-22-00-22	1SBL176501R2200	3/136	AF205-30-00-11	1SFL527002R1100	3/21
AF146-30-00-14	1SFL467001R1400	3/19	AF16Z-22-00-23	1SBL176501R2300	3/136	AF205-30-00-12	1SFL527002R1200	3/21
AF146-30-00-33	1SFL467001R3300	3/20	AF16Z-22-00-30	1SBL176501R3000	3/135	AF205-30-00-13	1SFL527002R1300	3/21
AF146-30-00-34	1SFL467001R3400	3/20	AF16Z-30-01-20	1SBL176001R2001	3/16	AF205-30-00-14	1SFL527002R1400	3/21
AF146-30-00B-11	1SFL467002R1100	3/19	AF16Z-30-01-21	1SBL176001R2101	3/16	AF205-30-00-33	1SFL527002R3300	3/22
AF146-30-00B-12	1SFL467002R1200	3/19	AF16Z-30-01-22	1SBL176001R2201	3/16	AF205-30-00-34	1SFL527002R3400	3/22
AF146-30-00B-13	1SFL467002R1300	3/19	AF16Z-30-01-23	1SBL176001R2301	3/16	AF205-30-11-11	1SFL527002R1111	3/31
AF146-30-00B-14	1SFL467002R1400	3/19	AF16Z-30-01-30	1SBL176001R3001	3/15	AF205-30-11-12	1SFL527002R1211	3/31
AF146-30-00B-33	1SFL467002R3300	3/20	AF16Z-30-01K-20	1SBL176005R2001	3/92	AF205-30-11-13	1SFL527002R1311	3/31
AF146-30-00B-34	1SFL467002R3400	3/20	AF16Z-30-01K-21	1SBL176005R2101	3/92	AF205-30-11-14	1SFL527002R1411	3/31
AF146-30-11-11	1SFL467001R1111	3/29	AF16Z-30-01K-22	1SBL176005R2201	3/92	AF205-30-11-33	1SFL527002R3311	3/32
AF146-30-11-12	1SFL467001R1211	3/29	AF16Z-30-01K-23	1SBL176005R2301	3/92	AF205-30-11-34	1SFL527002R3411	3/32
AF146-30-11-13	1SFL467001R1311	3/29	AF16Z-30-01K-30	1SBL176005R3001	3/91	AF205-30-22-11	1SFL527002R1122	3/44
AF146-30-11-14	1SFL467001R1411	3/29	AF16Z-30-10-11	1SBL176001R1110	12/6	AF205-30-22-12	1SFL527002R1222	3/44
AF146-30-11-33	1SFL467001R3311	3/30				AF205-30-22-13	1SFL527002R1322	3/44
AF146-30-11-34	1SFL467001R3411	3/30	AF16Z-30-10-20	1SBL176001R2010	3/16	AF205-30-22-14	1SFL527002R1422	3/44
AF146-30-11B-11	1SFL467002R1111	3/29	AF16Z-30-10-21	1SBL176001R2110	3/16	AF205-30-22-33	1SFL527002R3322	3/45
AF146-30-11B-12	1SFL467002R1211	3/29	AF16Z-30-10-22	1SBL176001R2210	3/16	AF205-30-22-34	1SFL527002R3422	3/45
AF146-30-11B-13	1SFL467002R1311	3/29	AF16Z-30-10-23	1SBL176001R2310	3/16	AF205-40-00-11	1SFL527102R1100	3/140
AF146-30-11B-14	1SFL467002R1411	3/29	AF16Z-30-10-30	1SBL176001R3010	3/15	AF205-40-00-12	1SFL527102R1200	3/140
AF146-30-11B-33	1SFL467002R3311	3/30	AF16Z-30-10K-20	1SBL176005R2010	3/92	AF205-40-00-13	1SFL527102R1300	3/140
AF146-30-11B-34	1SFL467002R3411	3/30	AF16Z-30-10K-21	1SBL176005R2110	3/92	AF205-40-00-14	1SFL527102R1400	3/140

# Index

## Type classification

Type	Order code	Page
AF205-40-11-11	1SFL527102R1111	3/143
AF205-40-11-12	1SFL527102R1211	3/143
AF205-40-11-13	1SFL527102R1311	3/143
AF205-40-11-14	1SFL527102R1411	3/143
AF205-40-22-11	1SFL527102R1122	3/146
AF205-40-22-12	1SFL527102R1222	3/146
AF205-40-22-13	1SFL527102R1322	3/146
AF205-40-22-14	1SFL527102R1422	3/146
AF26-22-00-11	1SBL237501R1100	3/134
AF26-22-00-12	1SBL237501R1200	3/134
AF26-22-00-13	1SBL237501R1300	3/134
AF26-22-00-14	1SBL237501R1400	3/134
AF26-30-00-11	1SBL237001R1100	3/14
AF26-30-00-12	1SBL237001R1200	3/14
AF26-30-00-13	1SBL237001R1300	3/14
AF26-30-00-14	1SBL237001R1400	3/14
AF26-30-00K-11	1SBL237005R1100	3/90
AF26-30-00K-12	1SBL237005R1200	3/90
AF26-30-00K-13	1SBL237005R1300	3/90
AF26-30-00K-14	1SBL237005R1400	3/90
AF26-30-11-11	1SBL237001R1111	3/24
AF26-30-11-12	1SBL237001R1211	3/24
AF26-30-11-13	1SBL237001R1311	3/24
AF26-30-11-14	1SBL237001R1411	3/24
AF26-30-22-11	1SBL237001R1122	3/38
AF26-30-22-12	1SBL237001R1222	3/38
AF26-30-22-13	1SBL237001R1322	3/38
AF26-30-22-14	1SBL237001R1422	3/38
AF26-40-00-11	1SBL237201R1100	3/134
AF26-40-00-12	1SBL237201R1200	3/134
AF26-40-00-13	1SBL237201R1300	3/134
AF26-40-00-14	1SBL237201R1400	3/134
AF2650-30-11	1SFL667001R7011	3/35
AF2650-30-22	1SFL667001R7022	3/48
AF2650T-30-11	1SFL667001R9101	3/36
AF265-30-00-11	1SFL547002R1100	3/21
AF265-30-00-12	1SFL547002R1200	3/21
AF265-30-00-13	1SFL547002R1300	3/21
AF265-30-00-14	1SFL547002R1400	3/21
AF265-30-00-33	1SFL547002R3300	3/22
AF265-30-00-34	1SFL547002R3400	3/22
AF265-30-11-11	1SFL547002R1111	3/31
AF265-30-11-12	1SFL547002R1211	3/31
AF265-30-11-13	1SFL547002R1311	3/31
AF265-30-11-14	1SFL547002R1411	3/31
AF265-30-11-33	1SFL547002R3311	3/32
AF265-30-11-34	1SFL547002R3411	3/32
AF265-30-22-11	1SFL547002R1122	3/44
AF265-30-22-12	1SFL547002R1222	3/44
AF265-30-22-13	1SFL547002R1322	3/44
AF265-30-22-14	1SFL547002R1422	3/44
AF265-30-22-33	1SFL547002R3322	3/45
AF265-30-22-34	1SFL547002R3422	3/45
AF265-40-00-11	1SFL547102R1100	3/140
AF265-40-00-12	1SFL547102R1200	3/140
AF265-40-00-13	1SFL547102R1300	3/140
AF265-40-00-14	1SFL547102R1400	3/140
AF265-40-11-11	1SFL547102R1111	3/143
AF265-40-11-12	1SFL547102R1211	3/143
AF265-40-11-13	1SFL547102R1311	3/143
AF265-40-11-14	1SFL547102R1411	3/143
AF265-40-22-11	1SFL547102R1122	3/146
AF265-40-22-12	1SFL547102R1222	3/146
AF265-40-22-13	1SFL547102R1322	3/146
AF265-40-22-14	1SFL547102R1422	3/146
AF26Z-22-00-20	1SBL236501R2000	3/136
AF26Z-22-00-21	1SBL236501R2100	3/136

Type	Order code	Page
AF26Z-22-00-22	1SBL236501R2200	3/136
AF26Z-22-00-23	1SBL236501R2300	3/136
AF26Z-30-00-11	1SBL236001R1100	12/6
AF26Z-30-00-20	1SBL236001R2000	3/16
AF26Z-30-00-21	1SBL236001R2100	3/16
AF26Z-30-00-22	1SBL236001R2200	3/16
AF26Z-30-00-23	1SBL236001R2300	3/16
AF26Z-30-00-30	1SBL236001R3000	3/15
AF26Z-30-00K-20	1SBL236005R2000	3/92
AF26Z-30-00K-21	1SBL236005R2100	3/92
AF26Z-30-00K-22	1SBL236005R2200	3/92
AF26Z-30-00K-23	1SBL236005R2300	3/92
AF26Z-30-00K-30	1SBL236005R3000	3/91
AF26Z-30-11-20	1SBL236001R2011	3/25
AF26Z-30-11-21	1SBL236001R2111	3/25
AF26Z-30-11-22	1SBL236001R2211	3/25
AF26Z-30-11-23	1SBL236001R2311	3/25
AF26Z-30-22-20	1SBL236001R2022	3/39
AF26Z-30-22-21	1SBL236001R2122	3/39
AF26Z-30-22-22	1SBL236001R2222	3/39
AF26Z-30-22-23	1SBL236001R2322	3/39
AF26Z-40-00-20	1SBL236201R2000	3/136
AF26Z-40-00-21	1SBL236201R2100	3/136
AF26Z-40-00-22	1SBL236201R2200	3/136
AF26Z-40-00-23	1SBL236201R2300	3/136
AF2850-30-11	1SFL687001R7011	3/35
AF2850-30-22	1SFL687001R7022	3/48
AF2850T-30-11	1SFL687001R9101	3/36
AF30-30-00-11	1SBL277001R1100	3/14
AF30-30-00-12	1SBL277001R1200	3/14
AF30-30-00-13	1SBL277001R1300	3/14
AF30-30-00-14	1SBL277001R1400	3/14
AF30-30-00K-11	1SBL277005R1100	3/90
AF30-30-00K-12	1SBL277005R1200	3/90
AF30-30-00K-13	1SBL277005R1300	3/90
AF30-30-00K-14	1SBL277005R1400	3/90
AF30-30-11-11	1SBL277001R1111	3/24
AF30-30-11-12	1SBL277001R1211	3/24
AF30-30-11-13	1SBL277001R1311	3/24
AF30-30-11-14	1SBL277001R1411	3/24
AF30-30-22-11	1SBL277001R1122	3/38
AF30-30-22-12	1SBL277001R1222	3/38
AF30-30-22-13	1SBL277001R1322	3/38
AF30-30-22-14	1SBL277001R1422	3/38
AF305-30-00-11	1SFL587002R1100	3/21
AF305-30-00-12	1SFL587002R1200	3/21
AF305-30-00-13	1SFL587002R1300	3/21
AF305-30-00-14	1SFL587002R1400	3/21
AF305-30-00-33	1SFL587002R3300	3/22
AF305-30-00-34	1SFL587002R3400	3/22
AF305-30-11-11	1SFL587002R1111	3/31
AF305-30-11-12	1SFL587002R1211	3/31
AF305-30-11-13	1SFL587002R1311	3/31
AF305-30-11-14	1SFL587002R1411	3/31
AF305-30-11-33	1SFL587002R3311	3/32
AF305-30-11-34	1SFL587002R3411	3/32
AF305-30-22-11	1SFL587002R1122	3/44
AF305-30-22-12	1SFL587002R1222	3/44
AF305-30-22-13	1SFL587002R1322	3/44
AF305-30-22-33	1SFL587002R3322	3/44
AF305-30-22-34	1SFL587002R3422	3/44
AF305-40-00-11	1SFL587102R1100	3/140
AF305-40-00-12	1SFL587102R1200	3/140
AF305-40-00-13	1SFL587102R1300	3/140
AF305-40-00-14	1SFL587102R1400	3/140
AF305-40-11-11	1SFL587102R1111	3/143

Type	Order code	Page
AF305-40-11-12	1SFL587102R1211	3/143
AF305-40-11-13	1SFL587102R1311	3/143
AF305-40-11-14	1SFL587102R1411	3/143
AF305-40-22-11	1SFL587102R1122	3/146
AF305-40-22-12	1SFL587102R1222	3/146
AF305-40-22-13	1SFL587102R1322	3/146
AF305-40-22-14	1SFL587102R1422	3/146
AF30Z-30-00-11	1SBL276001R1100	12/6
AF30Z-30-00-20	1SBL276001R2000	3/16
AF30Z-30-00-21	1SBL276001R2100	3/16
AF30Z-30-00-22	1SBL276001R2200	3/16
AF30Z-30-00-23	1SBL276001R2300	3/16
AF30Z-30-00-30	1SBL276001R3000	3/15
AF30Z-30-00K-20	1SBL276005R2000	3/92
AF30Z-30-00K-21	1SBL276005R2100	3/92
AF30Z-30-00K-22	1SBL276005R2200	3/92
AF30Z-30-00K-23	1SBL276005R2300	3/92
AF30Z-30-00K-30	1SBL276005R3000	3/91
AF30Z-30-11-20	1SBL276001R2011	3/25
AF30Z-30-11-21	1SBL276001R2111	3/25
AF30Z-30-11-22	1SBL276001R2211	3/25
AF30Z-30-11-23	1SBL276001R2311	3/25
AF30Z-30-22-20	1SBL276001R2022	3/39
AF30Z-30-22-21	1SBL276001R2122	3/39
AF30Z-30-22-22	1SBL276001R2222	3/39
AF30Z-30-22-23	1SBL276001R2322	3/39
AF370-30-00-11	1SFL607002R1100	3/21
AF370-30-00-12	1SFL607002R1200	3/21
AF370-30-00-13	1SFL607002R1300	3/21
AF370-30-00-14	1SFL607002R1400	3/21
AF370-30-00-33	1SFL607002R3300	3/22
AF370-30-00-34	1SFL607002R3400	3/22
AF370-30-11-11	1SFL607002R1111	3/31
AF370-30-11-12	1SFL607002R1211	3/31
AF370-30-11-13	1SFL607002R1311	3/31
AF370-30-11-14	1SFL607002R1411	3/31
AF370-30-11-33	1SFL607002R3311	3/32
AF370-30-11-34	1SFL607002R3411	3/32
AF370-30-22-11	1SFL607002R1122	3/44
AF370-30-22-12	1SFL607002R1222	3/44
AF370-30-22-13	1SFL607002R1322	3/44
AF370-30-22-14	1SFL607002R1422	3/44
AF370-30-22-33	1SFL607002R3322	3/45
AF370-30-22-34	1SFL607002R3422	3/45
AF370-40-00-11	1SFL607102R1100	3/140
AF370-40-00-12	1SFL607102R1200	3/140
AF370-40-00-13	1SFL607102R1300	3/140
AF370-40-00-14	1SFL607102R1400	3/140
AF370-40-11-11	1SFL607102R1111	3/143
AF370-40-11-12	1SFL607102R1211	3/143
AF370-40-11-13	1SFL607102R1311	3/143
AF370-40-11-14	1SFL607102R1411	3/143
AF370-40-22-11	1SFL607102R1122	3/146
AF370-40-22-12	1SFL607102R1222	3/146
AF370-40-22-13	1SFL607102R1322	3/146
AF370-40-22-14	1SFL607102R1422	3/146
AF38-22-00-11	1SBL297501R1100	3/134
AF38-22-00-12	1SBL297501R1200	3/134
AF38-22-00-13	1SBL297501R1300	3/134
AF38-22-00-14	1SBL297501R1400	3/134
AF38-30-00-11	1SBL297001R1100	3/14
AF38-30-00-12	1SBL297001R1200	3/14
AF38-30-00-13	1SBL297001R1300	3/14
AF38-30-00-14	1SBL297001R1400	3/14
AF38-30-00K-11	1SBL297005R1100	3/90
AF38-30-00K-12	1SBL297005R1200	3/90
AF38-30-00K-13	1SBL297005R1300	3/90

# Index

## Type classification

Type	Order code	Page	Type	Order code	Page	Type	Order code	Page
AF38-30-00K-14	1SBL297005R1400	3/90	AF40-40-00-14	1SBL347201R1400	3/137	AF80-30-22-13	1SBL397001R1322	3/40
AF38-30-11-11	1SBL297001R1111	3/24	AF460-30-11	1SFL597001R6811	3/34	AF80-30-22-14	1SBL397001R1422	3/40
AF38-30-11-12	1SBL297001R1211	3/24		1SFL597001R6911	3/34	AF80-40-00-11	1SBL397201R1100	3/137
AF38-30-11-13	1SBL297001R1311	3/24		1SFL597001R7011	3/34	AF80-40-00-12	1SBL397201R1200	3/137
AF38-30-11-14	1SBL297001R1411	3/24		1SFL597001R7111	3/34	AF80-40-00-13	1SBL397201R1300	3/137
AF38-30-22-11	1SBL297001R1122	3/38	AF460-30-22	1SFL597001R6822	3/47	AF80-40-00-14	1SBL397201R1400	3/137
AF38-30-22-12	1SBL297001R1222	3/38		1SFL597001R6922	3/47	AF96-30-00-11	1SBL407001R1100	3/17
AF38-30-22-13	1SBL297001R1322	3/38		1SFL597001R7022	3/47	AF96-30-00-12	1SBL407001R1200	3/17
AF38-30-22-14	1SBL297001R1422	3/38		1SFL597001R7122	3/47	AF96-30-00-13	1SBL407001R1300	3/17
AF38-40-00-11	1SBL297201R1100	3/134	AF52-30-00-11	1SBL367001R1100	3/17	AF96-30-00-14	1SBL407001R1400	3/17
AF38-40-00-12	1SBL297201R1200	3/134	AF52-30-00-12	1SBL367001R1200	3/17	AF96-30-11-11	1SBL407001R1111	3/27
AF38-40-00-13	1SBL297201R1300	3/134	AF52-30-00-13	1SBL367001R1300	3/17	AF96-30-11-12	1SBL407001R1211	3/27
AF38-40-00-14	1SBL297201R1400	3/134	AF52-30-00-14	1SBL367001R1400	3/17	AF96-30-11-13	1SBL407001R1311	3/27
AF38Z-22-00-20	1SBL296501R2000	3/136	AF52-30-11-11	1SBL367001R1111	3/27	AF96-30-11-14	1SBL407001R1411	3/27
AF38Z-22-00-21	1SBL296501R2100	3/136	AF52-30-11-12	1SBL367001R1211	3/27	AF96-30-22-11	1SBL407001R1122	3/40
AF38Z-22-00-22	1SBL296501R2200	3/136	AF52-30-11-13	1SBL367001R1311	3/27	AF96-30-22-12	1SBL407001R1222	3/40
AF38Z-22-00-23	1SBL296501R2300	3/136	AF52-30-11-14	1SBL367001R1411	3/27	AF96-30-22-13	1SBL407001R1322	3/40
AF38Z-30-00-11	1SBL296001R1100	12/36	AF52-30-22-11	1SBL367001R1122	3/40	AF96-30-22-14	1SBL407001R1422	3/40
AF38Z-30-00-20	1SBL296001R2000	3/16	AF52-30-22-12	1SBL367001R1222	3/40	AFS09-30-22-11	1SBL137082R1122	3/114
AF38Z-30-00-21	1SBL296001R2100	3/16	AF52-30-22-13	1SBL367001R1322	3/40	AFS09-30-22-13	1SBL137082R1322	3/114
AF38Z-30-00-22	1SBL296001R2200	3/16	AF52-30-22-14	1SBL367001R1422	3/40	AFS09Z-30-22-30	1SBL136082R3022	3/114
AF38Z-30-00-23	1SBL296001R2300	3/16	AF52-40-00-11	1SBL367201R1100	3/137	AFS12-30-22-11	1SBL157082R1122	3/114
AF38Z-30-00-30	1SBL296001R3000	3/15	AF52-40-00-12	1SBL367201R1200	3/137	AFS12-30-22-13	1SBL157082R1322	3/114
AF38Z-30-00K-20	1SBL296005R2000	3/92	AF52-40-00-13	1SBL367201R1300	3/137	AFS12Z-30-22-30	1SBL156082R3022	3/114
AF38Z-30-00K-21	1SBL296005R2100	3/92	AF52-40-00-14	1SBL367201R1400	3/137	AFS16-30-22-11	1SBL177082R1122	3/114
AF38Z-30-00K-22	1SBL296005R2200	3/92	AF580-30-11	1SFL617001R6811	3/34	AFS16-30-22-13	1SBL177082R1322	3/114
AF38Z-30-00K-23	1SBL296005R2300	3/92		1SFL617001R6911	3/34	AFS16Z-30-22-30	1SBL176082R3022	3/114
AF38Z-30-00K-30	1SBL296005R3000	3/91		1SFL617001R7011	3/34	AFS26-30-22-11	1SBL237082R1122	3/114
				1SFL617001R7111	3/34	AFS26-30-22-13	1SBL237082R1322	3/114
AF38Z-30-11-20	1SBL296001R2011	3/25	AF580-30-22	1SFL617001R6822	3/47	AFS26Z-30-22-30	1SBL236082R3022	3/114
AF38Z-30-11-21	1SBL296001R2111	3/25		1SFL617001R6922	3/47	AFS30-30-22-11	1SBL277082R1122	3/114
AF38Z-30-11-22	1SBL296001R2211	3/25		1SFL617001R7022	3/47	AFS30-30-22-13	1SBL277082R1322	3/114
AF38Z-30-11-23	1SBL296001R2311	3/25		1SFL617001R7122	3/47	AFS30Z-30-22-30	1SBL276082R3022	3/114
AF38Z-30-22-20	1SBL296001R2022	3/39	AF65-30-00-11	1SBL387001R1100	3/17	AFS38-30-22-11	1SBL297082R1122	3/114
AF38Z-30-22-21	1SBL296001R2122	3/39	AF65-30-00-12	1SBL387001R1200	3/17	AFS38-30-22-13	1SBL297082R1322	3/114
AF38Z-30-22-22	1SBL296001R2222	3/39	AF65-30-00-13	1SBL387001R1300	3/17	AFS38Z-30-22-30	1SBL296082R3022	3/114
AF38Z-30-22-23	1SBL296001R2322	3/39	AF65-30-00-14	1SBL387001R1400	3/17	AFS40-30-22-11	1SBL347082R1122	3/115
AF38Z-40-00-20	1SBL296201R2000	3/136	AF65-30-11-11	1SBL387001R1111	3/27	AFS40-30-22-13	1SBL347082R1322	3/115
AF38Z-40-00-21	1SBL296201R2100	3/136	AF65-30-11-12	1SBL387001R1211	3/27	AFS52-30-22-11	1SBL367082R1122	3/115
AF38Z-40-00-22	1SBL296201R2200	3/136	AF65-30-11-13	1SBL387001R1311	3/27	AFS52-30-22-13	1SBL367082R1322	3/115
AF38Z-40-00-23	1SBL296201R2300	3/136	AF65-30-11-14	1SBL387001R1411	3/27	AFS65-30-22-11	1SBL387082R1122	3/115
AF400-30-11	1SFL577001R6811	3/34	AF65-30-22-11	1SBL387001R1122	3/40	AFS65-30-22-13	1SBL387082R1322	3/115
	1SFL577001R6911	3/34	AF65-30-22-12	1SBL387001R1222	3/40	AFS80-30-22-11	1SBL397082R1122	3/115
	1SFL577001R7011	3/34	AF65-30-22-13	1SBL387001R1322	3/40	AFS80-30-22-13	1SBL397082R1322	3/115
	1SFL577001R7111	3/34	AF65-30-22-14	1SBL387001R1422	3/40	AFS96-30-22-11	1SBL407082R1122	3/115
AF400-30-22	1SFL577001R6822	3/47	AF750-30-11	1SFL637001R6811	3/34	AFS96-30-22-13	1SBL407082R1322	3/115
	1SFL577001R6922	3/47		1SFL637001R6911	3/34	AI111.0	1SAJ613000R0101	11/10
	1SFL577001R7022	3/47		1SFL637001R7011	3/34	AS09-30-01-20	1SBL101001R2001	5/8
	1SFL577001R7122	3/47		1SFL637001R7111	3/34	AS09-30-01-26	1SBL101001R2601	5/8
AF40-22-00-11	1SBL347501R1100	3/137	AF750-30-22	1SFL637001R6822	3/47	AS09-30-01S-20	1SBL101004R2001	5/56
AF40-22-00-12	1SBL347501R1200	3/137		1SFL637001R6922	3/47	AS09-30-01S-26	1SBL101004R2601	5/56
AF40-22-00-13	1SBL347501R1300	3/137		1SFL637001R7022	3/47	AS09-30-10-20	1SBL101001R2010	5/8
AF40-22-00-14	1SBL347501R1400	3/137		1SFL637001R7122	3/47	AS09-30-10-26	1SBL101001R2610	5/8
AF40-30-00-11	1SBL347001R1100	3/17	AF80-22-00-11	1SBL397501R1100	3/137	AS09-30-10S-20	1SBL101004R2010	5/56
AF40-30-00-12	1SBL347001R1200	3/17	AF80-22-00-12	1SBL397501R1200	3/137	AS09-30-10S-26	1SBL101004R2610	5/56
AF40-30-00-13	1SBL347001R1300	3/17	AF80-22-00-13	1SBL397501R1300	3/137	AS09-30-32-20	1SBL101001R2032	5/10
AF40-30-00-14	1SBL347001R1400	3/17	AF80-22-00-14	1SBL397501R1400	3/137	AS09-30-32-26	1SBL101001R2632	5/10
AF40-30-11-11	1SBL347001R1111	3/27	AF80-30-00-11	1SBL397001R1100	3/17	AS09-30-32S-20	1SBL101004R2032	5/58
AF40-30-11-12	1SBL347001R1211	3/27	AF80-30-00-12	1SBL397001R1200	3/17	AS09-30-32S-26	1SBL101004R2632	5/58
AF40-30-11-13	1SBL347001R1311	3/27	AF80-30-00-13	1SBL397001R1300	3/17	AS12-30-01-20	1SBL111001R2001	5/8
AF40-30-11-14	1SBL347001R1411	3/27	AF80-30-00-14	1SBL397001R1400	3/17	AS12-30-01-26	1SBL111001R2601	5/8
AF40-30-22-11	1SBL347001R1122	3/40	AF80-30-11-11	1SBL397001R1111	3/27	AS12-30-01S-20	1SBL111004R2001	5/56
AF40-30-22-12	1SBL347001R1222	3/40	AF80-30-11-12	1SBL397001R1211	3/27	AS12-30-01S-26	1SBL111004R2601	5/56
AF40-30-22-13	1SBL347001R1322	3/40	AF80-30-11-13	1SBL397001R1311	3/27	AS12-30-10-20	1SBL111001R2010	5/8
AF40-30-22-14	1SBL347001R1422	3/40	AF80-30-11-14	1SBL397001R1411	3/27	AS12-30-10-26	1SBL111001R2610	5/8
AF40-40-00-11	1SBL347201R1100	3/137	AF80-30-22-11	1SBL397001R1122	3/40	AS12-30-10S-20	1SBL111004R2010	5/56
AF40-40-00-12	1SBL347201R1200	3/137	AF80-30-22-12	1SBL397001R1222	3/40	AS12-30-10S-26	1SBL111004R2610	5/56
AF40-40-00-13	1SBL347201R1300	3/137						

# Index

## Type classification

Type	Order code	Page	Type	Order code	Page	Type	Order code	Page
AS12-30-32-20	1SBL111001R2032	5/10	B6-30-10-F-84	GJL1211003R8104	4/30	B7D-40-00-01	GJL1317201R0001	4/16
AS12-30-32-26	1SBL111001R2632	5/10	B6-30-10-F-85	GJL1211003R8105	4/30	B7D-40-00-05	GJL1317201R0005	4/16
AS12-30-32S-20	1SBL111004R2032	5/58	B6-30-10-P-01	GJL1211009R0101	4/20	B7S-30-01-1.7-71	GJL1313001R7011	4/14
AS12-30-32S-26	1SBL111004R2632	5/58	B6-30-10-P-02	GJL1211009R0102	4/20	B7S-30-01-2.8-72	GJL1313001R7012	4/14
AS16-30-01-20	1SBL121001R2001	5/8	B6-30-10-P-03	GJL1211009R0103	4/20	B7S-30-10-1.7-71	GJL1313001R7101	4/14
AS16-30-01-26	1SBL121001R2601	5/8	B6-30-10-P-80	GJL1211009R8100	4/20	B7S-30-10-2.8-72	GJL1313001R7102	4/14
AS16-30-01S-20	1SBL121004R2001	5/56	B6-30-10-P-84	GJL1211009R8104	4/20	BA4	1SNA235156R2700	3/256
AS16-30-01S-26	1SBL121004R2601	5/56	B6-30-10-P-85	GJL1211009R8105	4/20	BA5-50	1SBN110000R1000	3/256
AS16-30-10-20	1SBL121001R2010	5/8	B6-40-00-01	GJL1211201R0001	4/15	BB3	1SBN111020R1000	5/50
AS16-30-10-26	1SBL121001R2610	5/8	B6-40-00-02	GJL1211201R0002	4/15	BB4	1SBN110120W1000	3/248
AS16-30-10S-20	1SBL121004R2010	5/56	B6-40-00-03	GJL1211201R0003	4/15	BC6-21-10-P-01	GJL1213109R0101	4/21
AS16-30-10S-26	1SBL121004R2610	5/56	B6-40-00-80	GJL1211201R8000	4/15	BC6-21-10-P-03	GJL1213109R0103	4/21
AS16-30-32-20	1SBL121001R2032	5/10	B6-40-00-84	GJL1211201R8004	4/15	BC6-21-10-P-04	GJL1213109R0104	4/21
AS16-30-32-26	1SBL121001R2632	5/10	B6S-30-01-1.7-71	GJL1213001R7011	4/14	BC6-21-10-P-05	GJL1213109R0105	4/21
AS16-30-32S-20	1SBL121004R2032	5/58	B6S-30-01-2.8-72	GJL1213001R7012	4/14	BC6-21-10-P-16	GJL1213109R1106	4/21
AS16-30-32S-26	1SBL121004R2632	5/58	B6S-30-10-1.7-71	GJL1213001R7101	4/14	BC6-22-00-01	GJL1213501R0001	4/16
ASL09-30-01-81	1SBL103001R8101	5/9	B6S-30-10-2.8-72	GJL1213001R7102	4/14	BC6-22-00-02	GJL1213501R0002	4/16
ASL09-30-01S-81	1SBL103004R8101	5/57	B7-22-00-01	GJL1311501R0001	4/15	BC6-22-00-03	GJL1213501R0003	4/16
ASL09-30-10-81	1SBL103001R8110	5/9	B7-22-00-02	GJL1311501R0002	4/15	BC6-22-00-04	GJL1213501R0004	4/16
ASL09-30-10S-81	1SBL103004R8110	5/57	B7-22-00-03	GJL1311501R0003	4/15	BC6-22-00-05	GJL1213501R0005	4/16
ASL09-30-32-81	1SBL103001R8132	5/11	B7-22-00-80	GJL1311501R8000	4/15	BC6-22-00-07	GJL1213501R0007	4/16
ASL09-30-32S-81	1SBL103004R8132	5/59	B7-22-00-84	GJL1311501R8004	4/15	BC6-22-00-16	GJL1213501R1006	4/16
ASL12-30-01-81	1SBL113001R8101	5/9	B7-30-01-01	GJL1311001R0011	4/8	BC6-30-01-01	GJL1213001R0011	4/9
ASL12-30-01S-81	1SBL113004R8101	5/57	B7-30-01-02	GJL1311001R0012	4/8	BC6-30-01-03	GJL1213001R0013	4/9
ASL12-30-10-81	1SBL113001R8110	5/9	B7-30-01-03	GJL1311001R0013	4/8	BC6-30-01-04	GJL1213001R0014	4/9
ASL12-30-10S-81	1SBL113004R8110	5/57	B7-30-01-80	GJL1311001R8010	4/8	BC6-30-01-05	GJL1213001R0015	4/9
ASL12-30-32-81	1SBL113001R8132	5/11	B7-30-01-84	GJL1311001R8014	4/8	BC6-30-01-07	GJL1213001R0017	4/9
ASL12-30-32S-81	1SBL113004R8132	5/59	B7-30-01-85	GJL1311001R8015	4/8	BC6-30-01-1.4-81	GJL1213001R8011	4/14
ASL16-30-01-81	1SBL123001R8101	5/9	B7-30-01-F-01	GJL1311003R0011	4/30	BC6-30-01-16	GJL1213001R1016	4/9
ASL16-30-01S-81	1SBL123004R8101	5/57	B7-30-01-F-02	GJL1311003R0012	4/30	BC6-30-01-2.4-51	GJL1213001R5011	4/14
ASL16-30-10-81	1SBL123001R8110	5/9	B7-30-01-F-03	GJL1311003R0013	4/30	BC6-30-01-F-01	GJL1213003R0011	4/31
ASL16-30-10S-81	1SBL123004R8110	5/57	B7-30-01-F-80	GJL1311003R8010	4/30	BC6-30-01-F-03	GJL1213003R0013	4/31
ASL16-30-32-81	1SBL123001R8132	5/11	B7-30-01-F-84	GJL1311003R8014	4/30	BC6-30-01-F-04	GJL1213003R0014	4/31
ASL16-30-32S-81	1SBL123004R8132	5/59	B7-30-01-F-85	GJL1311003R8015	4/30	BC6-30-01-F-05	GJL1213003R0015	4/31
B6-22-00-01	GJL1211501R0001	4/15	B7-30-01-P-01	GJL1311009R0011	4/20	BC6-30-01-F-07	GJL1213003R0017	4/31
B6-22-00-02	GJL1211501R0002	4/15	B7-30-01-P-02	GJL1311009R0012	4/20	BC6-30-01-F-1.4-81	GJL1213003R8011	4/36
B6-22-00-03	GJL1211501R0003	4/15	B7-30-01-P-03	GJL1311009R0013	4/20	BC6-30-01-F-16	GJL1213003R1016	4/31
B6-22-00-80	GJL1211501R8000	4/15	B7-30-01-P-80	GJL1311009R8010	4/20	BC6-30-01-F-2.4-51	GJL1213003R5011	4/36
B6-22-00-84	GJL1211501R8004	4/15	B7-30-01-P-84	GJL1311009R8014	4/20	BC6-30-01-P-01	GJL1213009R0011	4/21
B6-30-01-01	GJL1211001R0011	4/8	B7-30-01-P-85	GJL1311009R8015	4/20	BC6-30-01-P-03	GJL1213009R0013	4/21
B6-30-01-02	GJL1211001R0012	4/8	B7-30-10-01	GJL1311001R0101	4/8	BC6-30-01-P-04	GJL1213009R0014	4/21
B6-30-01-03	GJL1211001R0013	4/8	B7-30-10-02	GJL1311001R0102	4/8	BC6-30-01-P-05	GJL1213009R0015	4/21
B6-30-01-80	GJL1211001R8010	4/8	B7-30-10-03	GJL1311001R0103	4/8	BC6-30-01-P-07	GJL1213009R0017	4/21
B6-30-01-84	GJL1211001R8014	4/8	B7-30-10-80	GJL1311001R8100	4/8	BC6-30-01-P-1.4-81	GJL1213009R8011	4/26
B6-30-01-85	GJL1211001R8015	4/8	B7-30-10-84	GJL1311001R8104	4/8	BC6-30-01-P-16	GJL1213009R1016	4/21
B6-30-01-F-01	GJL1211003R0011	4/30	B7-30-10-85	GJL1311001R8105	4/8	BC6-30-01-P-2.4-51	GJL1213009R5011	4/26
B6-30-01-F-02	GJL1211003R0012	4/30	B7-30-10-F-01	GJL1311003R0101	4/30	BC6-30-10-01	GJL1213001R0101	4/9
B6-30-01-F-03	GJL1211003R0013	4/30	B7-30-10-F-02	GJL1311003R0102	4/30	BC6-30-10-03	GJL1213001R0103	4/9
B6-30-01-F-80	GJL1211003R8010	4/30	B7-30-10-F-03	GJL1311003R0103	4/30	BC6-30-10-04	GJL1213001R0104	4/9
B6-30-01-F-84	GJL1211003R8014	4/30	B7-30-10-F-80	GJL1311003R8100	4/30	BC6-30-10-05	GJL1213001R0105	4/9
B6-30-01-F-85	GJL1211003R8015	4/30	B7-30-10-F-84	GJL1311003R8104	4/30	BC6-30-10-07	GJL1213001R0107	4/9
B6-30-01-P-01	GJL1211009R0011	4/20	B7-30-10-F-85	GJL1311003R8105	4/30	BC6-30-10-1.4-81	GJL1213001R8101	4/14
B6-30-01-P-02	GJL1211009R0012	4/20	B7-30-10-P-01	GJL1311009R0101	4/20	BC6-30-10-16	GJL1213001R1106	4/9
B6-30-01-P-03	GJL1211009R0013	4/20	B7-30-10-P-02	GJL1311009R0102	4/20	BC6-30-10-2.4-51	GJL1213001R5101	4/14
B6-30-01-P-80	GJL1211009R8010	4/20	B7-30-10-P-03	GJL1311009R0103	4/20	BC6-30-10-F-01	GJL1213003R0101	4/31
B6-30-01-P-84	GJL1211009R8014	4/20	B7-30-10-P-80	GJL1311009R8100	4/20	BC6-30-10-F-03	GJL1213003R0103	4/31
B6-30-01-P-85	GJL1211009R8015	4/20	B7-30-10-P-84	GJL1311009R8104	4/20	BC6-30-10-F-04	GJL1213003R0104	4/31
B6-30-10-01	GJL1211001R0101	4/8	B7-30-10-P-85	GJL1311009R8105	4/20	BC6-30-10-F-05	GJL1213003R0105	4/31
B6-30-10-02	GJL1211001R0102	4/8	B7-40-00-01	GJL1311201R0001	4/15	BC6-30-10-F-07	GJL1213003R0107	4/31
B6-30-10-03	GJL1211001R0103	4/8	B7-40-00-02	GJL1311201R0002	4/15	BC6-30-10-F-1.4-81	GJL1213003R8101	4/36
B6-30-10-80	GJL1211001R8100	4/8	B7-40-00-03	GJL1311201R0003	4/15	BC6-30-10-F-16	GJL1213003R1106	4/31
B6-30-10-84	GJL1211001R8104	4/8	B7-40-00-80	GJL1311201R8000	4/15	BC6-30-10-F-2.4-51	GJL1213003R5101	4/36
B6-30-10-85	GJL1211001R8105	4/8	B7-40-00-84	GJL1311201R8004	4/15	BC6-30-10-P-01	GJL1213009R0101	4/21
B6-30-10-F-01	GJL1211003R0101	4/30	B7D-30-01-01	GJL1317001R0011	4/9	BC6-30-10-P-03	GJL1213009R0103	4/21
B6-30-10-F-02	GJL1211003R0102	4/30	B7D-30-01-05	GJL1317001R0015	4/9	BC6-30-10-P-04	GJL1213009R0104	4/21
B6-30-10-F-03	GJL1211003R0103	4/30	B7D-30-10-01	GJL1317001R0101	4/9	BC6-30-10-P-05	GJL1213009R0105	4/21
B6-30-10-F-80	GJL1211003R8100	4/30	B7D-30-10-05	GJL1317001R0105	4/9	BC6-30-10-P-07	GJL1213009R0107	4/21



# Index

## Type classification

Type	Order code	Page	Type	Order code	Page	Type	Order code	Page
BC6-30-10-P-1.4-81	GJL1213009R8101	4/26	BEA370/T5	15FN085406R1000	3/265	BEY265-4	15FN035203R1000	12/87
BC6-30-10-P-16	GJL1213009R1106	4/21	BEA38-4	15BN010110R1010	12/6		15FN085413R1000	3/263
BC6-30-10-P-2.4-51	GJL1213009R5101	4/26		15BN030111R1000	12/8	BEY370-4	15FN030300R1000	12/87
BC7-30-01-01	GJL1313001R0011	4/9		15BN082306T2000	3/262		15FN085813R1000	3/263
BC7-30-01-03	GJL1313001R0013	4/9		15BN082311R1000	12/8	BEY38-4	15BN030111R1000	12/85
BC7-30-01-04	GJL1313001R0014	4/9	BEA38-4K	15BN082321T2000	3/264		15BN082713R2000	3/263
BC7-30-01-05	GJL1313001R0015	4/9	BEA460H/T4	15FN085907R1000	3/265	BEY65-4	15BN033405T1000	12/85
BC7-30-01-07	GJL1313001R0017	4/9	BEA65-4	15BN010110R1001	12/8		15BN083413R2000	3/263
BC7-30-01-1.4-81	GJL1313001R8011	4/14		15BN010110R1010	12/6	BEY96-4	15BN033405T1000	12/85
BC7-30-01-16	GJL1313001R1016	4/9		15BN033405T1000	12/8		15BN083913R2000	3/263
BC7-30-01-2.4-51	GJL1313001R5011	4/14		15BN083406R1000	3/262	BP16	15BN111403R1000	3/285
BC7-30-01-F-01	GJL1313003R0011	4/31		15BN083411R1000	12/8	BP38-4	15BN112303T1000	3/257
BC7-30-01-F-03	GJL1313003R0013	4/31		15BN113405R1000	12/6	BP65-4	15BN113403T1000	3/257
BC7-30-01-F-04	GJL1313003R0014	4/31	BEA7/132	15BN085906R1002	4/49	BP96-4	15BN113903T1000	3/257
BC7-30-01-F-05	GJL1313003R0015	4/31	BEA7/325	15BN080906R1001	4/49	BPR65-4	15BN113405R1000	3/262
BC7-30-01-F-07	GJL1313003R0017	4/31	BEA750/T5	15FN086106R1001	3/265	BS1-3	15AM201908R1001	2/41
BC7-30-01-F-1.4-81	GJL1313003R8011	4/36	BEA750/T6	15FN086106R1000	3/265	BS2-3	15AM401921R1001	2/42
BC7-30-01-F-16	GJL1313003R1016	4/31	BEA750D/T5	15FN086106R1003	3/265	B5M6-30	GJL1201908R0001	4/49
BC7-30-01-F-2.4-51	GJL1313003R5011	4/36	BEA750D/T6	15FN086106R1002	3/265	B5S1000	SK829090-H	3/152
BC7-30-01-P-01	GJL1313009R0011	4/21	BED460	15FN085703R1000	3/263	B5S550	SK829090-E	3/152
BC7-30-01-P-03	GJL1313009R0013	4/21	BED580	15FN085903R1000	3/263	BX4	15BN110108T1000	3/256
BC7-30-01-P-04	GJL1313009R0014	4/21	BED750	15FN086103R1000	3/263	BX4-CA	15BN110109W1000	3/256
BC7-30-01-P-05	GJL1313009R0015	4/21	BEF460/OESA400	15FN085708R1000	3/265	C011-100	GHC0110003R0004	7/6
BC7-30-01-P-07	GJL1313009R0017	4/21	BEF750/OESA800	15FN086108R1000	3/265	C011-110	GHC0110003R0005	7/6
BC7-30-01-P-1.4-81	GJL1313009R8011	4/26	BEM460-30	15FN085701R1000	3/262	C011-120	GHC0110003R0006	7/6
BC7-30-01-P-16	GJL1313009R1016	4/21	BEM750-30	15FN086101R1000	3/262	C011-130	GHC0110003R0007	7/6
BC7-30-01-P-2.4-51	GJL1313009R5011	4/26	BEP140-30	15FN084214R1000	3/262	C011-140	GHC0110003R0011	7/6
BC7-30-10-01	GJL1313001R0101	4/9	BEP140-40	15FN084214R2000	3/262	C011-150	GHC0110003R0008	7/6
BC7-30-10-03	GJL1313001R1103	4/9	BEP205-30	15FN084814R1000	3/262	C011-160	GHC0110003R0009	7/6
BC7-30-10-04	GJL1313001R0104	4/9	BEP205-40	15FN084814R2000	3/262	C011-170	GHC0110003R0010	7/6
BC7-30-10-05	GJL1313001R0105	4/9	BEP370-30	15FN085414R1000	3/262	C011-3-150	GHC0110033R0008	7/6
BC7-30-10-07	GJL1313001R0107	4/9	BEP370-40	15FN085414R2000	3/262	C011-70	GHC0110003R0001	7/6
BC7-30-10-1.4-81	GJL1313001R8101	4/14	BER140-4	15FN030300R1000	12/37	C011-80	GHC0110003R0002	7/6
BC7-30-10-16	GJL1313001R1106	4/9		15FN084111R1000	12/37	C011-90	GHC0110003R0003	7/6
BC7-30-10-2.4-51	GJL1313001R5101	4/14		15FN084211R1000	3/262	CA3-01	15BN011010T1001	5/13
BC7-30-10-F-01	GJL1313003R0101	4/31	BER16-4	15BN030111R1000	12/37	CA3-01S	15BN011019T1001	5/61
BC7-30-10-F-03	GJL1313003R0103	4/31		15BN081311R1000	3/262	CA3-10	15BN011010T1010	5/13
BC7-30-10-F-04	GJL1313003R0104	4/31	BER16C-3	15BN011010T1010	12/65	CA3-10S	15BN011019T1010	5/61
BC7-30-10-F-05	GJL1313003R0105	4/31		15BN031005T1000	12/65	CA4-01	15BN010110R1001	3/230
BC7-30-10-F-07	GJL1313003R0107	4/31		15BN081012R1000	5/13	CA4-01K	15BN010160R1001	3/232
BC7-30-10-F-1.4-81	GJL1313003R8101	4/36	BER205-4	15FN030300R1000	12/37	CA4-01K-T	15BN010160T1001	3/232
BC7-30-10-F-16	GJL1313003R1106	4/31		15FN084811R1000	3/262	CA4-01-T	15BN010110T1001	3/230
BC7-30-10-F-2.4-51	GJL1313003R5101	4/36	BER370-4	15FN030300R1000	12/39	CA4-04E	15BN010140R1004	3/230
BC7-30-10-P-01	GJL1313009R0101	4/21		15FN085411R1000	3/262	CA4-04M	15BN010140R1104	3/230
BC7-30-10-P-03	GJL1313009R0103	4/21	BER38-4	15BN010110R1010	12/37	CA4-04MK	15BN010146R1104	3/232
BC7-30-10-P-04	GJL1313009R0104	4/21		15BN030111R1000	12/37	CA4-04N	15BN010140R1204	3/230
BC7-30-10-P-05	GJL1313009R0105	4/21		15BN082311R1000	3/262	CA4-04NK	15BN010146R1204	3/232
BC7-30-10-P-07	GJL1313009R0107	4/21	BER65-4	15BN010110R1001	12/37	CA4-10	15BN010110R1010	3/230
BC7-30-10-P-1.4-81	GJL1313009R8101	4/26		15BN010110R1010	12/37	CA4-10K	15BN010160R1010	3/232
BC7-30-10-P-16	GJL1313009R1106	4/21		15BN033405T1000	12/37	CA4-10K-T	15BN010160T1010	3/232
BC7-30-10-P-2.4-51	GJL1313009R5101	4/26		15BN083411R1000	3/262	CA4-10-T	15BN010110T1010	3/230
BDT4	15BN110122T1000	3/257	BER96-4	15BN010110R1001	12/8	CA4-13M	15BN010140R1113	3/230
BEA140/XT2	15FN084206R1000	3/265		15BN010110R1010	12/8	CA4-13MK	15BN010146R1113	3/232
BEA140/XT3	15FN084206R1002	3/265		15BN033405T1000	12/8	CA4-13N	15BN010140R1213	3/230
BEA140/XT4	15FN084206R1001	3/265		15BN083911R1000	3/262	CA4-13NK	15BN010146R1213	3/232
BEA16-3	15BN081006T1000	5/13	BES460	15FN085704R1000	3/262	CA4-22E	15BN010140R1022	3/230
BEA16-3U	15BN081020R1000	5/61	BES750	15FN086104R1000	3/262	CA4-22EK	15BN010146R1022	3/232
BEA16-4	15BN030111R1000	12/8	BEY140-4	15FN030300R1000	12/85	CA4-22M	15BN010140R1122	3/230
	15BN081306T1000	3/262		15FN084413R1000	3/263	CA4-22MK	15BN010146R1122	3/232
	15BN081311R1000	12/8	BEY16-4	15BN030111R1000	12/85	CA4-22N	15BN010140R1222	3/230
BEA16-4K	15BN081321T1000	3/264		15BN081313R2000	3/263	CA4-22NK	15BN010146R1222	3/232
BEA205/T4	15FN084806R1001	3/265	BEY16C-3	15BN031005T1000	12/69	CA4-22U	15BN010140R1322	3/230
BEA205/XT4	15FN084806R1000	3/265		15BN081018R2000	5/13	CA4-31E	15BN010140R1031	3/230
BEA26-4	15BN010110R1010	12/7	BEY190-4	15FN034403R1000	12/85	CA4-31EK	15BN010146R1031	3/232
	15BN030111R1000	12/9		15FN084813R1000	3/263	CA4-31M	15BN010140R1131	3/230
	15BN082306T1000	3/262	BEY205-4	15FN030300R1000	12/87	CA4-31MK	15BN010146R1131	3/232
	15BN082311R1000	12/9		15FN085213R1000	3/263	CA4-31N	15BN010140R1231	3/230

# Index

## Type classification

Type	Order code	Page	Type	Order code	Page	Type	Order code	Page
CA4-31NK	1SBN010146R1231	3/232	CDP23.150	1SAJ929230R0015	11/14	DRAF09-11U	1SBK134238R1100	9/8
CA4-31U	1SBN010140R1331	3/230	CDP23.300	1SAJ929230R0030	11/14	DRAF09-13N	1SBK134137R1300	9/8
CA4-40E	1SBN010140R1040	3/230	CDP24.150	1SAJ929240R0015	11/12	DRAF09-13U	1SBK134238R1300	9/8
CA4-40EK	1SBN010146R1040	3/232	CE5-01D0.1	1SBN010015R1001	3/234	DRAF09-14P	1SBK134037R1400	9/8
CA4-40N	1SBN010140R1240	3/230	CE5-01D2	1SBN010017R1001	3/234	DRAF09-14U	1SBK134238R1400	9/8
CA4-40NK	1SBN010146R1240	3/232	CE5-01W0.1	1SBN010016R1001	3/234	DRAF12-11S	1SBK154237R1100	9/8
CA4-40U	1SBN010140R1340	3/230	CE5-01W2	1SBN010018R1001	3/234	DRAF12-11U	1SBK154238R1100	9/8
CA5-01	1SBN010010R1001	3/272	CE5-10D0.1	1SBN010015R1010	3/234	DRAF12-13N	1SBK154137R1300	9/8
CA5-04E	1SBN010040R1004	3/272	CE5-10D2	1SBN010017R1010	3/234	DRAF12-13U	1SBK154238R1300	9/8
CA5-04M	1SBN010040R1104	3/272	CE5-10W0.1	1SBN010016R1010	3/234	DRAF12-14P	1SBK154037R1400	9/8
CA5-10	1SBN010010R1010	3/272	CE5-10W2	1SBN010018R1010	3/234	DRAF12-14U	1SBK154238R1400	9/8
CA5-11/11E	1SBN010040R1018	3/272	CEL18-01	1SBN010716R1001	3/240	DRAF16-11S	1SBK174237R1100	9/8
CA5-11/11M	1SBN010040R1118	3/272	CEL18-10	1SBN010716R1010	3/240	DRAF16-11U	1SBK174238R1100	9/8
CA5-13M	1SBN010040R1113	3/272	CEL19-01	1SBN010832R1001	3/240	DRAF16-13N	1SBK174137R1300	9/8
CA5-22E	1SBN010040R1022	3/272	CEL19-10	1SBN010832R1010	3/240	DRAF16-13U	1SBK174238R1300	9/8
CA5-22M	1SBN010040R1122	3/272	CEM11-FBP.120	1SAJ929200R0120	11/16	DRAF16-14P	1SBK174037R1400	9/8
CA5-31E	1SBN010040R1031	3/272	CEM11-FBP.20	1SAJ929200R0020	11/16	DRAF16-14U	1SBK174238R1400	9/8
CA5-31M	1SBN010040R1131	3/272	CEM11-FBP.35	1SAJ929200R0035	11/16	DRAS09-20S	1SBK104235R2000	9/2
CA5-40E	1SBN010040R1040	3/272	CEM11-FBP.60	1SAJ929200R0060	11/16	DRAS09-26N	1SBK104135R2600	9/2
CA6-11E	GJL1201317R0002	4/49	CK1-02	1SAM301901R1003	2/35	DRAS09-27N	1SBK104135R2700	9/2
CA6-11E-F	GJL1201318R0002	4/49	CK1-11	1SAM301901R1001	2/35	DRAS09-28P	1SBK104035R2800	9/2
CA6-11E-P	GJL1201319R0002	4/49	CK1-20	1SAM301901R1002	2/35	DRAS09-29P	1SBK104035R2900	9/2
CA6-11K	GJL1201317R0001	4/50	CM-MSE	1SVR550800R9300	7/5	DRAS12-20S	1SBK114235R2000	9/2
CA6-11K-F	GJL1201318R0001	4/50		1SVR550801R9300	7/5	DRAS12-26N	1SBK114135R2600	9/2
CA6-11K-P	GJL1201319R0001	4/50		1SVR550805R9300	7/5	DRAS12-27N	1SBK114135R2700	9/2
CA6-11M	GJL1201317R0003	4/49	CM-MSS.11P	1SVR740720R1400	7/5	DRAS12-28P	1SBK114035R2800	9/2
CA6-11M-F	GJL1201318R0003	4/49	CM-MSS.11S	1SVR730720R1400	7/5	DRAS12-29P	1SBK114035R2900	9/2
CA6-11M-P	GJL1201319R0003	4/49	CM-MSS.12P	1SVR740700R0100	7/5	DRAS16-20S	1SBK124235R2000	9/2
CA6-11N	GJL1201317R0004	4/49	CM-MSS.12S	1SVR730700R0100	7/5	DRAS16-26N	1SBK124135R2600	9/2
CA6-11N-F	GJL1201318R0004	4/49	CM-MSS.13P	1SVR740700R2100	7/5	DRAS16-27N	1SBK124035R2700	9/2
CA6-11N-P	GJL1201319R0004	4/49	CM-MSS.13S	1SVR730700R2100	7/5	DRAS16-28P	1SBK124035R2800	9/2
CAF6-02E	GJL1201330R0010	4/49	CM-MSS.21P	1SVR740722R1400	7/5	DRAS16-29P	1SBK124035R2900	9/2
CAF6-02K	GJL1201330R0009	4/50	CM-MSS.21S	1SVR730722R1400	7/5	DRASL09-81S	1SBK104335R8100	9/2
CAF6-02M	GJL1201330R0011	4/49	CM-MSS.22P	1SVR740700R0200	7/5	DRASL09-83S	1SBK104335R8300	9/2
CAF6-02N	GJL1201330R0012	4/49	CM-MSS.22S	1SVR730700R0200	7/5	DRASL12-81S	1SBK114335R8100	9/2
CAF6-11E	GJL1201330R0002	4/49	CM-MSS.23P	1SVR740700R2200	7/5	DRASL12-83S	1SBK114335R8300	9/2
CAF6-11K	GJL1201330R0001	4/50	CM-MSS.23S	1SVR730700R2200	7/5	DRASL16-81S	1SBK124335R8100	9/2
CAF6-11M	GJL1201330R0003	4/49	CM-MSS.31P	1SVR740712R1400	7/5	DRASL16-83S	1SBK124335R8300	9/2
CAF6-11N	GJL1201330R0004	4/49	CM-MSS.31S	1SVR730712R1400	7/5	DRS-F-01	1SAX101911R1001	6/9
CAF6-20E	GJL1201330R0006	4/49	CM-MSS.32P	1SVR740712R0200	7/5	DRS-F-02	1SAX101911R1002	6/9
CAF6-20K	GJL1201330R0005	4/50	CM-MSS.32S	1SVR740712R0200	7/5	DRS-F-03	1SAX101911R1003	6/9
CAF6-20M	GJL1201330R0007	4/49	CM-MSS.33P	1SVR740712R2200	7/5	DRS-F-04	1SAX101911R1004	6/9
CAF6-20N	GJL1201330R0008	4/49	CM-MSS.33S	1SVR730712R2200	7/5	DT500/AF460-L	1SAX701902R1001	6/41
CAL16-11A	SK829002-A	3/298	CM-MSS.41P	1SVR740712R1200	7/5	DT500/AF460-S	1SAX701902R1011	6/41
CAL16-11B	SK829002-B	3/152	CM-MSS.41S	1SVR730712R1200	7/5	DT800/AF750-L	1SAX801902R1001	6/41
CAL16-11C	SK829002-C	3/152	CM-MSS.51P	1SVR740712R1300	7/5	DT800/AF750-S	1SAX801902R1011	6/41
CAL16-11D	SK829002-D	3/152	CM-MSS.51S	1SVR730712R1300	7/5	DX111-FBP.0	1SAJ611000R0101	11/10
CAL18-11	1SBN010720R1011	3/238	CT4L185R/4	1SAJ929500R0185	11/16	E16DU-0.32	1SAX111001R1101	6/29
CAL18-11B	1SBN010720R3311	3/238	CT4L310R/4	1SAJ929500R0310	11/16	E16DU-1.0	1SAX111001R1102	6/29
CAL19-11	1SBN010820R1011	3/238	CT5L500R/4	1SAJ929501R0500	11/16	E16DU-18.9	1SAX111001R1105	6/29
CAL19-11B	1SBN010820R3311	3/238	CT5L850R/4	1SAJ929501R0850	11/16	E16DU-2.7	1SAX111001R1103	6/29
CAL4-11	1SBN010120R1011	3/230	CT-ERS.21S	1SBN020112R1000	12/85	E16DU-6.3	1SAX111001R1104	6/29
CAL4-11K	1SBN010134R1011	3/232		1SVR730100R0300	12/85	EF1250DU-1250	1SFA739001R1001	6/41
CAL4-11T	1SBN010120T1011	3/230	CT-SDS.22S	1SVR730210R3300	12/69	EF146-150	1SAX351001R1101	6/33
CAL5-11	1SBN010020R1011	3/272	CT-SDS.23S	1SVR730211R2300	12/69	EF19-0.32	1SAX121001R1101	6/29
CAT4-11E	1SBN010151R1011	3/230	DB16	1SAZ701901R0001	6/4	EF19-1.0	1SAX121001R1102	6/29
CAT4-11M	1SBN010151R1111	3/230	DB16E	1SAX101110R0001	6/29	EF19-18.9	1SAX111001R1105	12/38
CAT4-11U	1SBN010151R1311	3/230	DB19EF	1SAX101910R1001	6/29		1SAX121001R1105	6/29
CB5-01	1SBN010013R1001	3/250	DB200	1SAZ401110R0001	6/25	EF19-2.7	1SAX121001R1103	6/29
CB5-10	1SBN010013R1010	3/250	DB42	1SAZ701902R0001	6/9	EF19-6.3	1SAX121001R1104	6/29
CC4-01	1SBN010111R1001	3/230	DB45EF	1SAX201910R0001	6/29	EF205-110	1SAX531001R1101	12/38
CC4-10	1SBN010111R1010	3/230	DB65	1SAZ801901R1001	6/13	EF205-210	1SAX531001R1101	6/37
CC5-01	1SBN010011R1001	3/272	DB96	1SAZ901901R1001	6/17	EF370-380	1SAX611001R1101	6/37
CC5-10	1SBN010011R1010	3/272	DMS132-G	1SAM201912R1010	2/44	EF45-30	1SAX211001R1101	12/38
CCL16-11E	SK829002-E	3/152	DMS132-Y	1SAM201912R1011	2/44		1SAX221001R1101	6/29
CCL16-11E	SK829002-E	3/298	DNP31.0	1SAJ231000R0001	11/11	EF45-45	1SAX211001R1102	12/38
CDP18.150	1SAJ929180R0015	11/12	DRAF09-11S	1SBK134237R1100	9/8		1SAX221001R1102	6/29
						EF460-500	1SAX721001R1101	6/41

# Index

## Type classification

Type	Order code	Page	Type	Order code	Page	Type	Order code	Page
EF65-56	1SAX331001R1102	6/33	GAE75-10-00	1SBL419025R8000	3/179	K6-22Z-03	GJH1211001R0223	4/17
EF65-70	1SAX331001R1101	6/33		1SBL419025R8100	3/179	K6-22Z-80	GJH1211001R8220	4/17
EF750-800	1SAX821001R1101	6/41		1SBL419025R8300	3/179	K6-22Z-84	GJH1211001R8224	4/17
EF96-100	1SAX341001R1101	6/33		1SBL419025R8600	3/179	K6-22Z-85	GJH1211001R8225	4/17
EF96-56	1SAX341001R1102	6/33		1SBL419025R8700	3/179	K6-22Z-F-01	GJH1211003R0221	4/37
EIU32.0	1SAJ262000R0100	11/13		1SBL419025R8800	3/179	K6-22Z-F-02	GJH1211003R0222	4/37
EK1000-40-11	SK827044-AD	3/148		1SBL419025R8900	3/179	K6-22Z-F-03	GJH1211003R0223	4/37
	SK827044-AR	3/148	GAE75-10-11	1SBL419025R8011	3/179	K6-22Z-F-80	GJH1211003R8220	4/37
	SK827044-EF	3/148		1SBL419025R8111	3/179	K6-22Z-F-84	GJH1211003R8224	4/37
	SK827044-EG	3/148		1SBL419025R8311	3/179	K6-22Z-F-85	GJH1211003R8225	4/37
	SK827044-EL	3/148		1SBL419025R8611	3/179	K6-22Z-P-01	GJH1211009R0221	4/27
	SK827044-EM	3/148		1SBL419025R8711	3/179	K6-22Z-P-02	GJH1211009R0222	4/27
EK1000-40-21	SK827044-DB	3/149		1SBL419025R8811	3/179	K6-22Z-P-03	GJH1211009R0223	4/27
	SK827044-DC	3/149		1SBL419025R8911	3/179	K6-22Z-P-80	GJH1211009R8220	4/27
	SK827044-DD	3/149	GAF1250-10-11	1SFL647025R6811	3/182	K6-22Z-P-84	GJH1211009R8224	4/27
	SK827044-DE	3/149		1SFL647025R6911	3/182	K6-22Z-P-85	GJH1211009R8225	4/27
	SK827044-DF	3/149		1SFL647025R7011	3/182	K6-31Z-01	GJH1211001R0311	4/17
	SK827044-DG	3/149		1SFL647025R7111	3/182	K6-31Z-02	GJH1211001R0312	4/17
	SK827044-DT	3/149	GAF1650-10-11	1SFL677025R7011	3/182	K6-31Z-03	GJH1211001R0313	4/17
	SK827044-DU	3/149	GAF185-10-11	1SFL497025R6911	3/180	K6-31Z-80	GJH1211001R8310	4/17
EK1000-40-22	SK827045-AD	3/150		1SFL497025R7011	3/180	K6-31Z-84	GJH1211001R8314	4/17
	SK827045-AR	3/150	GAF185-10-11	1SFL497025R7211	3/180	K6-31Z-85	GJH1211001R8315	4/17
	SK827045-EF	3/150	GAF2050-10-11	1SFL707025R7011	3/182	K6-31Z-F-01	GJH1211003R0311	4/37
	SK827045-EG	3/150	GAF300-10-11	1SFL557025R6911	3/180	K6-31Z-F-02	GJH1211003R0312	4/37
	SK827045-EL	3/150		1SFL557025R7011	3/180	K6-31Z-F-03	GJH1211003R0313	4/37
	SK827045-EM	3/150	GAF300-10-11	1SFL557025R7211	3/180	K6-31Z-F-80	GJH1211003R8310	4/37
	SK827045-EP	3/150	GAF460-10-11	1SFL597025R6911	3/181	K6-31Z-F-84	GJH1211003R8314	4/37
	SK827045-ER	3/150		1SFL597025R7011	3/181	K6-31Z-F-85	GJH1211003R8315	4/37
EK550-40-11	SK827041-AD	3/148		1SFL597025R7111	3/181	K6-31Z-P-01	GJH1211009R0311	4/27
	SK827041-AR	3/148	GAF460-10-11	1SFL597025R6811	3/181	K6-31Z-P-02	GJH1211009R0312	4/27
	SK827041-EF	3/148	GAF750-10-11	1SFL637025R6911	3/181	K6-31Z-P-03	GJH1211009R0313	4/27
	SK827041-EG	3/148		1SFL637025R7011	3/181	K6-31Z-P-80	GJH1211009R8310	4/27
	SK827041-EL	3/148		1SFL637025R7111	3/181	K6-31Z-P-84	GJH1211009R8314	4/27
	SK827041-EM	3/148	GAF750-10-11	1SFL637025R6811	3/181	K6-31Z-P-85	GJH1211009R8315	4/27
EK550-40-21	SK827041-DB	3/149	HF0.6-DOL-24VDC	1SAT112000R1011	10/8	K6-40E-01	GJH1211001R0401	4/17
	SK827041-DD	3/149	HF0.6-DOLE-24VDC	1SAT113000R1011	10/8	K6-40E-02	GJH1211001R0402	4/17
	SK827041-DE	3/149	HF0.6-ROL-24VDC	1SAT115000R1011	10/9	K6-40E-03	GJH1211001R0403	4/17
	SK827041-DF	3/149	HF0.6-ROLE-24VDC	1SAT116000R1011	10/9	K6-40E-80	GJH1211001R8400	4/17
	SK827041-DG	3/149	HF2.4-DOL-24VDC	1SAT122000R1011	10/8	K6-40E-84	GJH1211001R8404	4/17
	SK827041-DU	3/149	HF2.4-DOLE-24VDC	1SAT123000R1011	10/8	K6-40E-85	GJH1211001R8405	4/17
EK550-40-22	SK827043-AD	3/150	HF2.4-ROL-24VDC	1SAT125000R1011	10/9	K6-40E-F-01	GJH1211003R0401	4/37
	SK827043-AR	3/150	HF2.4-ROLE-24VDC	1SAT126000R1011	10/9	K6-40E-F-02	GJH1211003R0402	4/37
	SK827043-EF	3/150	HF9-DOL-24VDC	1SAT142000R1011	10/8	K6-40E-F-03	GJH1211003R0403	4/37
	SK827043-EG	3/150	HF9-DOLE-24VDC	1SAT143000R1011	10/8	K6-40E-F-80	GJH1211003R8400	4/37
	SK827043-EL	3/150	HF9-R-24VDC	1SAT144000R1011	10/9	K6-40E-F-84	GJH1211003R8404	4/37
	SK827043-EM	3/150	HF9-ROL-24VDC	1SAT145000R1011	10/9	K6-40E-F-85	GJH1211003R8405	4/37
Ekip M-LiU In160	1SDA067355R1	12/21	HF9-ROLE-24VDC	1SAT146000R1011	10/9	K6-40E-P-01	GJH1211009R0401	4/27
ETHTB-FBP.4	1SAJ329200R0001	11/14	HK1-02	1SAM201902R1003	2/35	K6-40E-P-02	GJH1211009R0402	4/27
ETHTB-FBP.50	1SAJ329200R0002	11/14	HK1-02K	1SAM201902R1203	2/37	K6-40E-P-03	GJH1211009R0403	4/27
FR16AF-12	1SBN101337R1000	9/9	HK1-11	1SAM201902R1001	2/35	K6-40E-P-80	GJH1211009R8400	4/27
FR16AF-12U	1SBN101338R1000	9/9	HK1-11K	1SAM201902R1201	2/37	K6-40E-P-84	GJH1211009R8404	4/27
FR16AS-12VARS	1SBN101035R1000	9/2	HK1-20	1SAM201902R1002	2/35	K6-40E-P-85	GJH1211009R8405	4/27
FS116	1SAM201909R1001	2/41	HK1-20K	1SAM201902R1202	2/37	K6S-22Z-1.7-71	GJH1213001R7221	4/19
GA75-10-00	1SBL411025R8000	3/178	HK1-20L	1SAM201902R1004	2/35	K6S-22Z-2.8-72	GJH1213001R7222	4/19
	1SBL411025R8100	3/178	HK1-20LK	1SAM201902R1204	2/37	K6S-31Z-1.7-71	GJH1213001R7311	4/19
	1SBL411025R8300	3/178	HKF1-01	1SAM201901R1004	2/35	K6S-31Z-2.8-72	GJH1213001R7312	4/19
	1SBL411025R8400	3/178	HKF1-10	1SAM201901R1003	2/35	K6S-40E-1.7-71	GJH1213001R7401	4/19
	1SBL411025R8500	3/178	HKF1-11	1SAM201901R1001	2/35	K6S-40E-2.8-72	GJH1213001R7402	4/19
	1SBL411025R8600	3/178	HKF1-11K	1SAM201901R1201	2/37	KA165	1SAM401922R1001	2/42
	1SBL411025R8800	3/178	HKF1-20	1SAM201901R1002	2/35	KC6-22Z-01	GJH1213001R0221	4/18
GA75-10-11	1SBL411025R8011	3/178	HKF1-20K	1SAM201901R1202	2/37	KC6-22Z-03	GJH1213001R0223	4/18
	1SBL411025R8111	3/178	HTP500-BA4	1SNA235712R2400	3/256	KC6-22Z-04	GJH1213001R0224	4/18
	1SBL411025R8311	3/178	IB132-G	1SAM201911R1010	2/44	KC6-22Z-05	GJH1213001R0225	4/18
	1SBL411025R8411	3/178	IB132-Y	1SAM201911R1011	2/44	KC6-22Z-07	GJH1213001R0227	4/18
	1SBL411025R8511	3/178	IOIO-CAB.030	1SAJ692000R0001	11/10	KC6-22Z-16	GJH1213001R1226	4/18
	1SBL411025R8611	3/178	K6-22Z-01	GJH1211001R0221	4/17	KC6-22Z-F-01	GJH1213003R0221	4/38
	1SBL411025R8811	3/178	K6-22Z-02	GJH1211001R0222	4/17	KC6-22Z-F-04	GJH1213003R0224	4/38



# Index

## Type classification

Type	Order code	Page
KC6-22Z-F-05	GJH1213003R0225	4/38
KC6-22Z-F-07	GJH1213003R0227	4/38
KC6-22Z-F-16	GJH1213003R1226	4/38
KC6-22Z-P-01	GJH1213009R0221	4/28
KC6-22Z-P-04	GJH1213009R0224	4/28
KC6-22Z-P-05	GJH1213009R0225	4/28
KC6-22Z-P-07	GJH1213009R0227	4/28
KC6-22Z-P-16	GJH1213009R1226	4/28
KC6-31Z-01	GJH1213001R0311	4/18
KC6-31Z-03	GJH1213001R0313	4/18
KC6-31Z-04	GJH1213001R0314	4/18
KC6-31Z-05	GJH1213001R0315	4/18
KC6-31Z-07	GJH1213001R0317	4/18
KC6-31Z-1.4-81	GJH1213001R8311	4/19
KC6-31Z-16	GJH1213001R1316	4/18
KC6-31Z-2.4-51	GJH1213001R5311	4/19
KC6-31Z-F-01	GJH1213003R0311	4/38
KC6-31Z-F-04	GJH1213003R0314	4/38
KC6-31Z-F-05	GJH1213003R0315	4/38
KC6-31Z-F-07	GJH1213003R0317	4/38
KC6-31Z-F-1.4-81	GJH1213003R8311	4/39
KC6-31Z-F-16	GJH1213003R1316	4/38
KC6-31Z-F-51	GJH1213003R5311	4/39
KC6-31Z-P-01	GJH1213009R0311	4/28
KC6-31Z-P-04	GJH1213009R0314	4/28
KC6-31Z-P-05	GJH1213009R0315	4/28
KC6-31Z-P-1.4-81	GJH1213009R8311	4/29
KC6-31Z-P-16	GJH1213009R1316	4/28
KC6-31Z-P-2.4-51	GJH1213009R5311	4/29
KC6-40E-01	GJH1213001R0401	4/18
KC6-40E-03	GJH1213001R0403	4/18
KC6-40E-04	GJH1213001R0404	4/18
KC6-40E-05	GJH1213001R0405	4/18
KC6-40E-07	GJH1213001R0407	4/18
KC6-40E-1.4-81	GJH1213001R8401	4/19
KC6-40E-16	GJH1213001R1406	4/18
KC6-40E-2.4-51	GJH1213001R5401	4/19
KC6-40E-F-01	GJH1213003R0401	4/38
KC6-40E-F-04	GJH1213003R0404	4/38
KC6-40E-F-05	GJH1213003R0405	4/38
KC6-40E-F-1.4-81	GJH1213003R8401	4/39
KC6-40E-F-16	GJH1213003R1406	4/38
KC6-40E-F-51	GJH1213003R5401	4/39
KC6-40E-P-01	GJH1213009R0401	4/28
KC6-40E-P-04	GJH1213009R0404	4/28
KC6-40E-P-05	GJH1213009R0405	4/28
KC6-40E-P-07	GJH1213009R0407	4/28
KC6-40E-P-1.4-81	GJH1213009R8401	4/29
KC6-40E-P-16	GJH1213009R1406	4/28
KC6-40E-P-2.4-51	GJH1213009R5401	4/29
KH800	SK828100-AD	3/306
	SK828100-AR	3/306
	SK828100-EF	3/306
	SK828100-EG	3/306
	SK828100-EL	3/306
	SK828100-EM	3/306
	SK828100-ER	3/306
KM1 : 1 x CA4-10	15BN010110R1010	12/85
KM1 : 1 x CA4-10	15BN010110R1001	12/85
	15BN010110R1010	12/85
KM1: 1 x CA3-10	15BN011010T1010	12/69
KP800	SK828150-DB	3/306
	SK828150-DE	3/306
	SK828150-DF	3/306
	SK828150-DU	3/306
KPR-101L	15FA616162R1014	6/4
KWK1000	5223351-AN	3/305

Type	Order code	Page
KWK550	5223351-Z	3/305
KZK1000	SK827204-F	3/305
KZK550	SK827204-B	3/305
LB6	GJL1201902R0001	4/49
LB6-CA	GJL1201903R0001	4/49
LD146-30	15FN074208R1000	3/260
LD146-40	15FN074208R2000	3/260
LD38-4	15BN072308R1000	3/258
LD75	15BN073508R1000	3/292
LDC4	15BN070156T1000	3/256
LDC4K	15BN070159T1000	3/256
LE460	15FN075716R1000	3/260
LE750	15FN076116R1000	3/260
LF16-4	15BN071305R1000	3/261
LF38-4	15BN072305R1000	3/261
LG16-4	15BN071306R1000	3/261
LH38-4	15BN072304R1000	3/261
LK75-F	15BN073552R1002	3/293
LK75-L	15BN073552R1003	3/293
LL146-30	15FN074211R1000	3/260
LL146-40	15FN074211R2000	3/260
LL205-30	15FN074811R1000	3/260
LL205-40	15FN074811R2000	3/260
LL370-30	15FN075411R1000	3/260
LL370-40	15FN075411R2000	3/260
LP1250	15FN076412R1000	3/294
LP185	15FN074712R1000	3/261
LP2050	15FN076512R1000	3/294
LP300	15FN075112R1000	3/261
LP460	15FN075712R1000	3/261
LP6	GJL1201907R0001	4/49
LP750	15FN076112R1000	3/261
LT1000-EK	SK178001-MB	3/302
LT140-30L	15FN124203R1000	3/259
LT140-40L	15FN124203R2000	3/259
LT200/A	1SAZ401901R1001	6/25
LT200E	1SAX501904R0001	6/37
LT205-30C	15FN124801R1000	3/259
LT205-30L	15FN124803R1000	3/259
LT205-30Y	15FN124804R1000	3/259
LT205-40C	15FN124801R2000	3/259
LT205-40L	15FN124803R2000	3/259
LT320E	1SAX601904R0001	6/37
LT370-30C	15FN125401R1000	3/259
LT370-30D	15FN125406R1000	3/259
LT370-30L	15FN125403R1000	3/259
LT370-30Y	15FN125404R1000	3/259
LT370-40C	15FN125401R2000	3/259
LT370-40L	15FN125403R2000	3/259
LT460-AC	15FN125701R1000	3/259
LT460-AL	15FN125703R1000	3/259
LT460EF	1SAX701904R0002	6/41
LT52-40	15BN123402R1000	3/259
LT550-EK	SK178001-LB	3/302
LT65-30	15BN123401R1000	3/259
LT6-B	GJL1201906R0001	4/49
LT750-AC	15FN126101R1000	3/259
LT750-AL	15FN126103R1000	3/259
LT750EF	1SAX801904R0002	6/41
LT80-40	15BN123902R1000	3/259
LT96-30	15BN123901R1000	3/259
LW110	15FN074307R1000	3/292
LW1250	15FN076407R1000	3/260
LW140	15FN074207R1000	3/260
LW205	15FN074807R1000	3/260
LW205-40	15FN074807R2000	3/260
LW370	15FN075407R1000	3/260

Type	Order code	Page
LW370-40	15FN075407R2000	3/260
LW460	15FN075707R1000	3/260
LW750	15FN076107R1000	3/260
LX140	15FN074210R1000	3/260
LX205	15FN074810R1000	3/260
LX370	15FN075410R1000	3/260
LX460	15FN075710R1000	3/260
LX750	15FN076110R1000	3/260
LY140	15FN074203R1000	3/261
LY16-4	15BN071303T1000	3/261
LY185	15FN074703R1000	3/261
LY300	15FN075103R1000	3/261
LY38-4	15BN072303T1000	3/261
LY460	15FN075703R1000	3/261
LY750	15FN076103R1000	3/261
MO132-0.16	1SAM360000R1001	2/14
MO132-0.25	1SAM360000R1002	2/14
MO132-0.4	1SAM360000R1003	2/14
MO132-0.63	1SAM360000R1004	2/14
MO132-1.0	1SAM360000R1005	2/14
MO132-1.6	1SAM360000R1006	2/14
MO132-10	1SAM360000R1010	2/14
MO132-12	1SAM360000R1012	2/14
MO132-16	1SAM360000R1011	2/14
MO132-2.5	1SAM360000R1007	2/14
MO132-20	1SAM360000R1013	2/14
MO132-25	1SAM360000R1014	2/14
MO132-32	1SAM360000R1015	2/14
MO132-4.0	1SAM360000R1008	2/14
MO132-6.3	1SAM360000R1009	2/14
MO165-16	1SAM461000R1011	2/15
MO165-20	1SAM461000R1012	2/15
MO165-25	1SAM461000R1013	2/15
MO165-32	1SAM461000R1014	2/15
MO165-42	1SAM461000R1015	2/15
MO165-54	1SAM461000R1016	2/15
MO165-65	1SAM461000R1017	2/15
MO165-73	1SAM461000R1018	2/15
MO165-80	1SAM461000R1019	2/15
MRP31.0	1SAJ251000R0001	11/11
MS116-0.16	1SAM250000R1001	2/10
MS116-0.16-HKF1-11	1SAM250005R1001	2/10
MS116-0.25	1SAM250000R1002	2/10
MS116-0.25-HKF1-11	1SAM250005R1002	2/10
MS116-0.4	1SAM250000R1003	2/10
MS116-0.4-HKF1-11	1SAM250005R1003	2/10
MS116-0.63	1SAM250000R1004	2/10
MS116-0.63-HKF1-11	1SAM250005R1004	2/10
MS116-1.0	1SAM250000R1005	2/10
MS116-1.0-HKF1-11	1SAM250005R1005	2/10
MS116-1.6	1SAM250000R1006	2/10
MS116-1.6-HKF1-11	1SAM250005R1006	2/10
MS116-10	1SAM250000R1010	2/10
MS116-10.0-HKF1-11	1SAM250005R1010	2/10
MS116-12	1SAM250000R1012	2/10
MS116-12.0-HKF1-11	1SAM250005R1012	2/10
MS116-16	1SAM250000R1011	2/10
MS116-16.0-HKF1-11	1SAM250005R1011	2/10
MS116-2.5	1SAM250000R1007	2/10
MS116-2.5-HKF1-11	1SAM250005R1007	2/10
MS116-20	1SAM250000R1013	2/10
MS116-20-HKF1-11	1SAM250005R1013	2/10
MS116-25	1SAM250000R1014	2/10
MS116-25-HKF1-11	1SAM250005R1014	2/10
MS116-32	1SAM250000R1015	2/10
MS116-32-HKF1-11	1SAM250005R1015	2/10
MS116-4.0	1SAM250000R1008	2/10

# Index

## Type classification

Type	Order code	Page	Type	Order code	Page	Type	Order code	Page
MS116-4.0-HKF1-11	1SAM250005R1008	2/10	MS132-4.0K	1SAM350010R1008	2/12	NF51/11-14	1SBH137001R1459	3/212
MS116-6.3	1SAM250000R1009	2/10	MS132-4.0KT	1SAM340010R1008	2/30	NF53E-11	1SBH137001R1153	3/212
MS116-6.3-HKF1-11	1SAM250005R1009	2/10	MS132-4.0T	1SAM340000R1008	2/29	NF53E-12	1SBH137001R1253	3/212
MS132-0.16	1SAM350000R1001	2/11	MS132-6.3	1SAM350000R1009	2/11	NF53E-13	1SBH137001R1353	3/212
MS132-0.16-HKF1-11	1SAM350005R1001	2/11	MS132-6.3-HKF1-11	1SAM350005R1009	2/11	NF53E-14	1SBH137001R1453	3/212
MS132-0.16K	1SAM350010R1001	2/12	MS132-6.3K	1SAM350010R1009	2/12	NF53EK-11	1SBH137005R1153	3/219
MS132-0.16KT	1SAM340010R1001	2/30	MS132-6.3KT	1SAM340010R1009	2/30	NF53EK-12	1SBH137005R1253	3/219
MS132-0.16T	1SAM340000R1001	2/29	MS132-6.3T	1SAM340000R1009	2/29	NF53EK-13	1SBH137005R1353	3/219
MS132-0.25	1SAM350000R1002	2/11	MS165-16	1SAM451000R1011	2/13	NF53EK-14	1SBH137005R1453	3/219
MS132-0.25-HKF1-11	1SAM350005R1002	2/11	MS165-20	1SAM451000R1012	2/13	NF62E-11	1SBH137001R1162	3/212
MS132-0.25K	1SAM350010R1002	2/12	MS165-25	1SAM451000R1013	2/13	NF62E-12	1SBH137001R1262	3/212
MS132-0.25KT	1SAM340010R1002	2/30	MS165-32	1SAM451000R1014	2/13	NF62E-13	1SBH137001R1362	3/212
MS132-0.25T	1SAM340000R1002	2/29	MS165-42	1SAM451000R1015	2/13	NF62E-14	1SBH137001R1462	3/212
MS132-0.4	1SAM350000R1003	2/11	MS165-54	1SAM451000R1016	2/13	NF62EK-11	1SBH137005R1162	3/219
MS132-0.4-HKF1-11	1SAM350005R1003	2/11	MS165-65	1SAM451000R1017	2/13	NF62EK-12	1SBH137005R1262	3/219
MS132-0.4K	1SAM350010R1003	2/12	MS165-73	1SAM451000R1018	2/13	NF62EK-13	1SBH137005R1362	3/219
MS132-0.4KT	1SAM340010R1003	2/30	MS165-80	1SAM451000R1019	2/13	NF62EK-14	1SBH137005R1462	3/219
MS132-0.4T	1SAM340000R1003	2/29	MS495-75	1SAM550000R1008	12/6	NF71E-11	1SBH137001R1171	3/212
MS132-0.63	1SAM350000R1004	2/11	MS495-90	1SAM550000R1009	12/6	NF71E-12	1SBH137001R1271	3/212
MS132-0.63-HKF1-11	1SAM350005R1004	2/11	MSAH1	1SAM201909R1021	2/45	NF71E-13	1SBH137001R1371	3/212
MS132-0.63K	1SAM350010R1004	2/12	MSH-AR	1SAM201920R1000	2/45	NF71E-14	1SBH137001R1471	3/212
MS132-0.63KT	1SAM340010R1004	2/30	MSHD-LB	1SAM201920R1001	2/45	NF71EK-11	1SBH137005R1171	3/219
MS132-0.63T	1SAM340000R1004	2/29	MSHD-LTB	1SAM201920R1011	2/45	NF71EK-12	1SBH137005R1271	3/219
MS132-1.0	1SAM350000R1005	2/11	MSHD-LTY	1SAM201920R1012	2/45	NF71EK-13	1SBH137005R1371	3/219
MS132-1.0-HKF1-11	1SAM350005R1005	2/11	MSHD-LY	1SAM201920R1002	2/45	NF71EK-14	1SBH137005R1471	3/219
MS132-1.0K	1SAM350010R1005	2/12	MSMN	1SAM101923R0002	2/45	NF80E-11	1SBH137001R1180	3/212
MS132-1.0KT	1SAM340010R1005	2/30	MSMNO	1SAM101923R0012	2/45	NF80E-12	1SBH137001R1280	3/212
MS132-1.0T	1SAM340000R1005	2/29	MTQ22-FBP.0	1SAJ260000R0100	11/13	NF80E-13	1SBH137001R1380	3/212
MS132-1.6	1SAM350000R1006	2/11	NF22E-11	1SBH137001R1122	3/208	NF80E-14	1SBH137001R1480	3/212
MS132-1.6-HKF1-11	1SAM350005R1006	2/11	NF22E-12	1SBH137001R1222	3/208	NF80EK-11	1SBH137005R1180	3/219
MS132-1.6K	1SAM350010R1006	2/12	NF22E-13	1SBH137001R1322	3/208	NF80EK-12	1SBH137005R1280	3/219
MS132-1.6KT	1SAM340010R1006	2/30	NF22E-14	1SBH137001R1422	3/208	NF80EK-13	1SBH137005R1380	3/219
MS132-1.6T	1SAM340000R1006	2/29	NF22EK-11	1SBH137005R1122	3/219	NF80EK-14	1SBH137005R1480	3/219
MS132-10	1SAM350000R1010	2/11	NF22EK-12	1SBH137005R1222	3/219	NFZ22E-20	1SBH136001R2022	3/210
MS132-10.0-HKF1-11	1SAM350005R1010	2/11	NF22EK-13	1SBH137005R1322	3/219	NFZ22E-21	1SBH136001R2122	3/210
MS132-10K	1SAM350010R1010	2/12	NF22EK-14	1SBH137005R1422	3/219	NFZ22E-22	1SBH136001R2222	3/210
MS132-10KT	1SAM340010R1010	2/30	NF31E-11	1SBH137001R1131	3/208	NFZ22E-23	1SBH136001R2322	3/210
MS132-10T	1SAM340000R1010	2/29	NF31E-12	1SBH137001R1231	3/208	NFZ22E-30	1SBH136001R3022	3/209
MS132-12	1SAM350000R1012	2/11	NF31E-13	1SBH137001R1331	3/208	NFZ22EK-20	1SBH136005R2022	3/221
MS132-12.0-HKF1-11	1SAM350005R1012	2/11	NF31E-14	1SBH137001R1431	3/208	NFZ22EK-21	1SBH136005R2122	3/221
MS132-12T	1SAM340000R1012	2/29	NF31EK-11	1SBH137005R1131	3/219	NFZ22EK-22	1SBH136005R2222	3/221
MS132-16	1SAM350000R1011	2/11	NF31EK-12	1SBH137005R1231	3/219	NFZ22EK-23	1SBH136005R2322	3/221
MS132-16.0-HKF1-11	1SAM350005R1011	2/11	NF31EK-13	1SBH137005R1331	3/219	NFZ22EK-30	1SBH136005R3022	3/220
MS132-16-HKF1-20	1SAM350006R1011	2/11	NF31EK-14	1SBH137005R1431	3/219	NFZ31E-20	1SBH136001R2031	3/210
MS132-16K	1SAM350010R1011	2/12	NF33/11-11	1SBH137001R1139	3/212	NFZ31E-21	1SBH136001R2131	3/210
MS132-16KT	1SAM340010R1011	2/30	NF33/11-12	1SBH137001R1239	3/212	NFZ31E-22	1SBH136001R2231	3/210
MS132-16T	1SAM340000R1011	2/29	NF33/11-13	1SBH137001R1339	3/212	NFZ31E-23	1SBH136001R2331	3/210
MS132-2.5	1SAM350000R1007	2/11	NF33/11-14	1SBH137001R1439	3/212	NFZ31E-30	1SBH136001R3031	3/209
MS132-2.5-HKF1-11	1SAM350005R1007	2/11	NF40E-11	1SBH137001R1140	3/208	NFZ31EK-20	1SBH136005R2031	3/221
MS132-2.5K	1SAM350010R1007	2/12	NF40E-12	1SBH137001R1240	3/208	NFZ31EK-21	1SBH136005R2131	3/221
MS132-2.5KT	1SAM340010R1007	2/30	NF40E-13	1SBH137001R1340	3/208	NFZ31EK-22	1SBH136005R2231	3/221
MS132-2.5T	1SAM340000R1007	2/29	NF40E-14	1SBH137001R1440	3/208	NFZ31EK-23	1SBH136005R2331	3/221
MS132-20	1SAM350000R1013	2/11	NF40EK-11	1SBH137005R1140	3/219	NFZ31EK-30	1SBH136005R3031	3/220
MS132-20-HKF1-11	1SAM350005R1013	2/11	NF40EK-12	1SBH137005R1240	3/219	NFZ33/11-20	1SBH136001R2039	3/214
MS132-20K	1SAM350010R1013	2/12	NF40EK-13	1SBH137005R1340	3/219	NFZ33/11-21	1SBH136001R2139	3/214
MS132-20KT	1SAM340010R1013	2/30	NF40EK-14	1SBH137005R1440	3/219	NFZ33/11-22	1SBH136001R2239	3/214
MS132-20T	1SAM340000R1013	2/29	NF44E-11	1SBH137001R1144	3/212	NFZ33/11-23	1SBH136001R2339	3/214
MS132-25	1SAM350000R1014	2/11	NF44E-12	1SBH137001R1244	3/212	NFZ40E-20	1SBH136001R2040	3/210
MS132-25-HKF1-11	1SAM350005R1014	2/11	NF44E-13	1SBH137001R1344	3/212	NFZ40E-21	1SBH136001R2140	3/210
MS132-25K	1SAM350010R1014	2/12	NF44E-14	1SBH137001R1444	3/212	NFZ40E-22	1SBH136001R2240	3/210
MS132-25KT	1SAM340010R1014	2/30	NF44EK-11	1SBH137005R1144	3/219	NFZ40E-23	1SBH136001R2340	3/210
MS132-25T	1SAM340000R1014	2/29	NF44EK-12	1SBH137005R1244	3/219	NFZ40E-30	1SBH136001R3040	3/209
MS132-32	1SAM350000R1015	2/11	NF44EK-13	1SBH137005R1344	3/219	NFZ40EK-20	1SBH136005R2040	3/221
MS132-32-HKF1-11	1SAM350005R1015	2/11	NF44EK-14	1SBH137005R1444	3/219	NFZ40EK-21	1SBH136005R2140	3/221
MS132-32K	1SAM350010R1015	2/12	NF51/11-11	1SBH137001R1159	3/212	NFZ40EK-22	1SBH136005R2240	3/221
MS132-4.0	1SAM350000R1008	2/11	NF51/11-12	1SBH137001R1259	3/212	NFZ40EK-23	1SBH136005R2340	3/221
MS132-4.0-HKF1-11	1SAM350005R1008	2/11	NF51/11-13	1SBH137001R1359	3/212	NFZ40EK-30	1SBH136005R3040	3/220

# Index

## Type classification

Type	Order code	Page	Type	Order code	Page	Type	Order code	Page
NFZ44E-20	1SBH136001R2044	3/214	NS44E-26	1SBH101001R2644	5/30	PS1-3-1-100	1SAM201916R1113	2/41
NFZ44E-21	1SBH136001R2144	3/214	NS44ES-20	1SBH101004R2044	5/73	PS1-3-1-65	1SAM201906R1113	2/41
NFZ44E-22	1SBH136001R2244	3/214	NS44ES-26	1SBH101004R2644	5/73	PS1-3-2-100	1SAM201916R1123	2/41
NFZ44E-23	1SBH136001R2344	3/214	NS53E-20	1SBH101001R2053	5/30	PS1-3-2-65	1SAM201906R1123	2/41
NFZ44E-30	1SBH136001R3044	3/213	NS53E-26	1SBH101001R2653	5/30	PS1-4-0-100	1SAM201916R1104	2/41
NFZ44EK-20	1SBH136005R2044	3/221	NS53ES-20	1SBH101004R2053	5/73	PS1-4-0-65	1SAM201906R1104	2/41
NFZ44EK-21	1SBH136005R2144	3/221	NS53ES-26	1SBH101004R2653	5/73	PS1-4-1-100	1SAM201916R1114	2/41
NFZ44EK-22	1SBH136005R2244	3/221	NS62E-20	1SBH101001R2062	5/30	PS1-4-1-65	1SAM201906R1114	2/41
NFZ44EK-23	1SBH136005R2344	3/221	NS62E-26	1SBH101001R2662	5/30	PS1-4-2-65	1SAM201906R1124	2/41
NFZ44EK-30	1SBH136005R3044	3/220	NS62ES-20	1SBH101004R2062	5/73	PS1-5-0-100	1SAM201916R1105	2/41
NFZ51/11-20	1SBH136001R2059	3/214	NS62ES-26	1SBH101004R2662	5/73	PS1-5-0-65	1SAM201906R1105	2/41
NFZ51/11-21	1SBH136001R2159	3/214	NS71E-20	1SBH101001R2071	5/30	PS1-5-1-100	1SAM201916R1115	2/41
NFZ51/11-22	1SBH136001R2259	3/214	NS71E-26	1SBH101001R2671	5/30	PS1-5-1-65	1SAM201906R1115	2/41
NFZ51/11-23	1SBH136001R2359	3/214	NS71ES-20	1SBH101004R2071	5/73	PS1-5-2-65	1SAM201906R1125	2/41
NFZ53E-20	1SBH136001R2053	3/214	NS71ES-26	1SBH101004R2671	5/73	PS2-2-0-125	1SAM401920R1002	2/42
NFZ53E-21	1SBH136001R2153	3/214	NS80E-20	1SBH101001R2080	5/30	PS2-2-2-125	1SAM401920R1022	2/42
NFZ53E-22	1SBH136001R2253	3/214	NS80E-26	1SBH101001R2680	5/30	PS2-3-0-125	1SAM401920R1003	2/42
NFZ53E-23	1SBH136001R2353	3/214	NS80ES-20	1SBH101004R2080	5/73	PS2-3-2-125	1SAM401920R1023	2/42
NFZ53E-30	1SBH136001R3053	3/213	NS80ES-26	1SBH101004R2680	5/73	PS2-4-0-125	1SAM401920R1004	2/42
NFZ53EK-20	1SBH136005R2053	3/221	NSL22E-81	1SBH103001R8122	5/31	PS2-4-2-125	1SAM401920R1024	2/42
NFZ53EK-21	1SBH136005R2153	3/221	NSL22ES-81	1SBH103004R8122	5/74	RA4	1SBN060100R1000	3/252
NFZ53EK-22	1SBH136005R2253	3/221	NSL31E-81	1SBH103001R8131	5/31	RA4-T	1SBN060100T1000	3/252
NFZ53EK-23	1SBH136005R2353	3/221	NSL31ES-81	1SBH103004R8131	5/74	RA5-1	1SBN060300R1000	3/288
NFZ53EK-30	1SBH136005R3053	3/220	NSL40E-81	1SBH103001R8140	5/31		1SBN060300T1000	3/288
NFZ62E-20	1SBH136001R2062	3/214	NSL40ES-81	1SBH103004R8140	5/74	CM-MSE	1SVR550800R9300	7/10
NFZ62E-21	1SBH136001R2162	3/214	NSL44E-81	1SBH103001R8144	5/31		1SVR550801R9300	7/10
NFZ62E-22	1SBH136001R2262	3/214	NSL44ES-81	1SBH103004R8144	5/74		1SVR550805R9300	7/10
NFZ62E-23	1SBH136001R2362	3/214	NSL53E-81	1SBH103001R8153	5/31	RC5-1/133	1SBN050100R1001	5/13
NFZ62E-30	1SBH136001R3062	3/213	NSL53ES-81	1SBH103004R8153	5/74	RC5-1/250	1SBN050100R1002	5/13
NFZ62EK-20	1SBH136005R2062	3/221	NSL62E-81	1SBH103001R8162	5/31	RC5-1/440	1SBN050100R1003	5/13
NFZ62EK-21	1SBH136005R2162	3/221	NSL62ES-81	1SBH103004R8162	5/74	RC5-1/50	1SBN050100R1000	5/13
NFZ62EK-22	1SBH136005R2262	3/221	NSL71E-81	1SBH103001R8171	5/31	RC5-2/133	1SBN050200R1001	3/286
NFZ62EK-23	1SBH136005R2362	3/221	NSL71ES-81	1SBH103004R8171	5/74	RC5-2/250	1SBN050200R1002	3/286
NFZ62EK-30	1SBH136005R3062	3/220	NSL80E-81	1SBH103001R8180	5/31	RC5-2/440	1SBN050200R1003	3/286
NFZ71E-20	1SBH136001R2071	3/214	NSL80ES-81	1SBH103004R8180	5/74	RC5-2/50	1SBN050200R1000	3/286
NFZ71E-21	1SBH136001R2171	3/214	OESA460H/OESA400	1SFN085709R1000	3/265	RC-EH800/110	SK829007-C	3/152
NFZ71E-22	1SBH136001R2271	3/214	OXS6X105	1SCA108043R1001	2/45	RC-EH800/600	SK829007-D	3/152
NFZ71E-23	1SBH136001R2371	3/214	OXS6X130	1SCA101655R1001	2/45	RT5/150	1SBN050020R1003	3/286
NFZ71E-30	1SBH136001R3071	3/213	OXS6X180	1SCA101659R1001	2/45	RT5/264	1SBN050020R1004	3/286
NFZ71EK-20	1SBH136005R2071	3/221	OXS6X85	1SCA101647R1001	2/45	RT5/32	1SBN050020R1000	3/286
NFZ71EK-21	1SBH136005R2171	3/221	PB1-1-32	1SAM201914R1001	2/41	RT5/65	1SBN050020R1001	3/286
NFZ71EK-22	1SBH136005R2271	3/221	PBDTM-FBP.0	1SAJ924012R0006	11/15	RT5/90	1SBN050020R1002	3/286
NFZ71EK-23	1SBH136005R2371	3/221	PDP32.0	1SAJ242000R0001	11/11	RU19/120	1SFN170801R1001	3/268
NFZ71EK-30	1SBH136005R3071	3/220	PDR31.0	1SAJ243000R0001	11/11	RU19/240	1SFN170801R1002	3/268
NFZ80E-20	1SBH136001R2080	3/214	PN460-11	1SFN095705R1000	3/266	RV5/133	1SBN050010R1001	3/286
NFZ80E-21	1SBH136001R2180	3/214	PN460-21	1SFN095701R1000	3/266	RV5/250	1SBN050010R1002	3/286
NFZ80E-22	1SBH136001R2280	3/214	PN460-41	1SFN095703R1000	3/266	RV5/440	1SBN050010R1003	3/286
NFZ80E-23	1SBH136001R2380	3/214	PN750-11	1SFN096105R1000	3/266	RV5/50	1SBN050010R1000	3/286
NFZ80E-30	1SBH136001R3080	3/213	PN750-21	1SFN096101R1000	3/266	RV-BC6/250	GHV2501903R0002	4/49
NFZ80EK-20	1SBH136005R2080	3/221	PN750-41	1SFN096103R1000	3/266	RV-BC6/60	GHV2501902R0002	4/49
NFZ80EK-21	1SBH136005R2180	3/221	PNQ22-FBP.0	1SAJ261000R0100	11/13	S1-M1-25	1SAM201907R1101	2/41
NFZ80EK-22	1SBH136005R2280	3/221	PR146-1	1SFN094200R1000	3/267	S1-M2-25	1SAM201907R1102	2/41
NFZ80EK-23	1SBH136005R2380	3/221	PR185-2	1SFN095100R1001	3/267	S1-M3-25	1SAM201907R1103	2/41
NFZ80EK-30	1SBH136005R3080	3/220	PR210-1	1SFN094900R1000	3/267	S1-M3-35	1SAM201913R1103	2/41
NS22E-20	1SBH101001R2022	5/30	PR300-1	1SFN095300R1000	3/267	S1-PB1-25	1SAM201914R1002	2/41
NS22E-26	1SBH101001R2622	5/30	PR300-2	1SFN095300R1001	3/267	S801S-SCL100-SR	2CCS801901R0639	8/2
NS22ES-20	1SBH101004R2022	5/73	PR400-2	1SFN095700R1002	3/267	S801S-SCL32-SR	2CCS801901R0539	8/2
NS22ES-26	1SBH101004R2622	5/73	PR460-1	1SFN095700R1000	3/267	S801S-SCL63-SR	2CCS801901R0599	8/2
NS31E-20	1SBH101001R2031	5/30	PR460-2	1SFN095700R1001	3/267	S802S-SCL100-SR	2CCS802901R0639	8/2
NS31E-26	1SBH101001R2631	5/30	PR580-2	1SFN096100R1002	3/267	S802S-SCL32-SR	2CCS802901R0539	8/2
NS31ES-20	1SBH101004R2031	5/73	PR750-1	1SFN096100R1000	3/267	S802S-SCL63-SR	2CCS802901R0599	8/2
NS31ES-26	1SBH101004R2631	5/73	PR750-2	1SFN096100R1001	3/267	S803S-SCL100-SR	2CCS803901R0639	8/2
NS40E-20	1SBH101001R2040	5/30	PS1-2-0-65	1SAM201906R1102	2/41	S803S-SCL32-SR	2CCS803901R0539	8/2
NS40E-26	1SBH101001R2640	5/30	PS1-2-1-65	1SAM201906R1112	2/41	S803S-SCL63-SR	2CCS803901R0599	8/2
NS40ES-20	1SBH101004R2040	5/73	PS1-2-2-65	1SAM201906R1122	2/41	S803W-SCL100-SR	2CCS803917R0639	8/2
NS40ES-26	1SBH101004R2640	5/73	PS1-3-0-100	1SAM201916R1103	2/41	S803W-SCL32-SR	2CCS803917R0539	8/2
NS44E-20	1SBH101001R2044	5/30	PS1-3-0-65	1SAM201906R1103	2/41	S803W-SCL63-SR	2CCS803917R0599	8/2

# Index

## Type classification

Type	Order code	Page	Type	Order code	Page	Type	Order code	Page
SA1	GJF1101903R0001	2/41	TF140DU-90-V1000	1SAZ431301R1001	6/21	UA16-30-10	1SBL181022R8010	3/200
SA2	GJF1101903R0002	2/41	TF42-0.13	1SAZ721201R1005	6/8		1SBL181022R8110	3/200
SA3	GJF1101903R0003	2/41	TF42-0.17	1SAZ721201R1008	6/8		1SBL181022R8310	3/200
SK1-02	1SAM201903R1003	2/35	TF42-0.23	1SAZ721201R1009	6/8		1SBL181022R8410	3/200
SK1-02K	1SAM201903R1203	2/37	TF42-0.31	1SAZ721201R1013	6/8		1SBL181022R8510	3/200
SK1-11	1SAM201903R1001	2/35	TF42-0.41	1SAZ721201R1014	6/8		1SBL181022R8610	3/200
SK1-11K	1SAM201903R1201	2/37	TF42-0.55	1SAZ721201R1017	6/8		1SBL181022R8810	3/200
SK1-20	1SAM201903R1002	2/35	TF42-0.74	1SAZ721201R1021	6/8	UA16-30-10RA	1SBL181024R8010	3/194
SK1-20K	1SAM201903R1202	2/37	TF42-1.0	1SAZ721201R1023	6/8		1SBL181024R8110	3/194
SMK3.0	1SAJ929600R0001	11/12	TF42-1.3	1SAZ721201R1025	6/8		1SBL181024R8410	3/194
SMK3-X1.10	1SAJ929620R0001	11/12	TF42-1.7	1SAZ721201R1028	6/8		1SBL181024R8510	3/194
SMK3-X2.10	1SAJ929610R0001	11/12	TF42-10	1SAZ711201R1043	12/36		1SBL181024R8610	3/194
SPRC 1	1SNA360010R1500	3/256		1SAZ721201R1043	6/8		1SBL181024R8810	3/194
T16-0.13	1SAZ711201R1005	6/4	TF42-13	1SAZ711201R1045	12/36	UA26-30-10	1SBL241022R8010	3/200
T16-0.17	1SAZ711201R1008	6/4		1SAZ721201R1045	6/8		1SBL241022R8110	3/200
T16-0.23	1SAZ711201R1009	6/4	TF42-16	1SAZ711201R1047	12/36		1SBL241022R8310	3/200
T16-0.31	1SAZ711201R1013	6/4		1SAZ721201R1047	6/8		1SBL241022R8410	3/200
T16-0.41	1SAZ711201R1014	6/4	TF42-2.3	1SAZ721201R1031	6/8		1SBL241022R8510	3/200
T16-0.55	1SAZ711201R1017	6/4	TF42-20	1SAZ721201R1049	6/8		1SBL241022R8610	3/200
T16-0.74	1SAZ711201R1021	6/4	TF42-24	1SAZ711201R1051	12/36		1SBL241022R8810	3/200
T16-1.0	1SAZ711201R1023	6/4		1SAZ721201R1051	6/8	UA26-30-10RA	1SBL241024R8010	3/194
T16-1.3	1SAZ711201R1025	6/4	TF42-29	1SAZ721201R1052	6/8		1SBL241024R8110	3/194
T16-1.7	1SAZ711201R1028	6/4	TF42-3.1	1SAZ721201R1033	6/8		1SBL241024R8410	3/194
T16-10	1SAZ711201R1043	6/4	TF42-35	1SAZ711201R1053	12/36		1SBL241024R8510	3/194
T16-13	1SAZ711201R1045	6/4		1SAZ721201R1053	6/8		1SBL241024R8610	3/194
T16-16	1SAZ711201R1047	6/4	TF42-38	1SAZ711201R1055	12/36		1SBL241024R8810	3/194
T16-2.3	1SAZ711201R1031	6/4		1SAZ721201R1055	6/8	UA30-30-10	1SBL281022R8010	3/200
T16-3.1	1SAZ711201R1033	6/4	TF42-4.2	1SAZ721201R1035	6/8		1SBL281022R8110	3/200
T16-4.2	1SAZ711201R1035	6/4	TF42-5.7	1SAZ721201R1038	6/8		1SBL281022R8310	3/200
T16-5.7	1SAZ711201R1038	6/4	TF42-7.6	1SAZ721201R1040	6/8		1SBL281022R8410	3/200
T16-7.6	1SAZ711201R1040	6/4	TF65-28	1SAZ811201R1001	6/13		1SBL281022R8510	3/200
T4S 250 PR222MP In200	1SDA054527R1	12/21	TF65-33	1SAZ811201R1002	6/13		1SBL281022R8610	3/200
T4S 320 PR221-I In320	1SDA054126R1	12/23	TF65-40	1SAZ811201R1003	6/13		1SBL281022R8810	3/200
T5S 400 PR221-I In400	1SDA054335R1	12/23	TF65-47	1SAZ811201R1004	6/13	UA30-30-10RA	1SBL281024R8010	3/194
T5S 400 PR222MP In320	1SDA054553R1	12/21	TF65-53	1SAZ811201R1005	6/13		1SBL281024R8110	3/194
T5S 400 PR222MP In400	1SDA054554R1	12/21	TF65-60	1SAZ811201R1006	6/13		1SBL281024R8410	3/194
T5S 630 PR221-I In630	1SDA054405R1	12/23	TF65-67	1SAZ811201R1007	6/13		1SBL281024R8510	3/194
TA200DU-110	1SAZ421201R1002	6/25	TF96-51	1SAZ911201R1001	6/17		1SBL281024R8610	3/194
TA200DU-110-V1000	1SAZ421301R1002	6/25	TF96-60	1SAZ911201R1002	6/17		1SBL281024R8810	3/194
TA200DU-135	1SAZ421201R1003	6/25	TF96-68	1SAZ911201R1003	6/17	UA50-30-00	1SBL351022R8000	3/201
TA200DU-135-V1000	1SAZ421301R1003	6/25	TF96-78	1SAZ911201R1004	6/17		1SBL351022R8100	3/201
TA200DU-150	1SAZ421201R1004	6/25	TF96-87	1SAZ911201R1005	6/17		1SBL351022R8300	3/201
TA200DU-150-V1000	1SAZ421301R1004	6/25	TF96-96	1SAZ911201R1006	6/17		1SBL351022R8400	3/201
TA200DU-175	1SAZ411201R1005	12/36	UA110-30-00	1SFL451022R8000	3/202		1SBL351022R8500	3/201
	1SAZ421201R1005	6/25		1SFL451022R8100	3/202		1SBL351022R8600	3/201
TA200DU-175-V1000	1SAZ421301R1005	6/25		1SFL451022R8300	3/202		1SBL351022R8800	3/201
TA200DU-200	1SAZ411201R1006	12/36		1SFL451022R8400	3/202	UA50-30-00RA	1SBL351024R8000	3/195
	1SAZ421201R1006	6/25		1SFL451022R8500	3/202		1SBL351024R8100	3/195
TA200DU-200-V1000	1SAZ421301R1006	6/25		1SFL451022R8600	3/202		1SBL351024R8400	3/195
TA200DU-90	1SAZ421201R1001	6/25		1SFL451022R8800	3/202		1SBL351024R8500	3/195
TA200DU-90-V1000	1SAZ421301R1001	6/25	UA110-30-00RA	1SFL451024R8000	3/196		1SBL351024R8600	3/195
TEF3-OFF	1SBN021014R1000	5/13		1SFL451024R8100	3/196		1SBL351024R8800	3/195
TEF3-ON	1SBN021012R1000	5/13		1SFL451024R8400	3/196	UA63-30-00	1SBL371022R8000	3/201
TEF4-OFF	1SBN020114R1000	3/245		1SFL451024R8500	3/196		1SBL371022R8100	3/201
TEF4-ON	1SBN020112R1000	3/245		1SFL451024R8600	3/196		1SBL371022R8300	3/201
TEF4S-OFF	1SBN020115R1000	3/245		1SFL451024R8800	3/196		1SBL371022R8400	3/201
TEF4S-ON	1SBN020113R1000	3/245	UA1-110	1SAM201904R1004	2/36		1SBL371022R8500	3/201
TEF5-OFF	1SBN020314R1000	3/278	UA1-20	1SAM201904R1010	2/36		1SBL371022R8600	3/201
TEF5-ON	1SBN020312R1000	3/278	UA1-208	1SAM201904R1008	2/36		1SBL371022R8800	3/201
TF140DU-110	1SAZ431201R1002	6/21	UA1-230	1SAM201904R1005	2/36	UA63-30-00RA	1SBL371024R8000	3/195
TF140DU-110-V1000	1SAZ431301R1002	6/21	UA1-24	1SAM201904R1001	2/36		1SBL371024R8100	3/195
TF140DU-135	1SAZ431201R1003	6/21	UA1-400	1SAM201904R1006	2/36		1SBL371024R8400	3/195
TF140DU-135-V1000	1SAZ431301R1003	6/21	UA1-415	1SAM201904R1007	2/36		1SBL371024R8500	3/195
TF140DU-142	1SAZ431201R1004	6/21	UA1-48	1SAM201904R1002	2/36		1SBL371024R8600	3/195
TF140DU-142-V1000	1SAZ431301R1004	6/21	UA1-575	1SAM201904R1009	2/36		1SBL371024R8800	3/195
TF140DU-90	1SAZ431201R1001	6/21	UA1-60	1SAM201904R1003	2/36			

# Index

## Type classification

Type	Order code	Page
UA75-30-00	1SBL411022R8000	3/201
	1SBL411022R8100	3/201
	1SBL411022R8300	3/201
	1SBL411022R8400	3/201
	1SBL411022R8500	3/201
	1SBL411022R8600	3/201
	1SBL411022R8800	3/201
UA75-30-00RA	1SBL411024R8000	3/195
	1SBL411024R8100	3/195
	1SBL411024R8400	3/195
	1SBL411024R8500	3/195
	1SBL411024R8600	3/195
	1SBL411024R8800	3/195
UA95-30-00	1SFL431022R8000	3/202
	1SFL431022R8100	3/202
	1SFL431022R8300	3/202
	1SFL431022R8400	3/202
	1SFL431022R8500	3/202
	1SFL431022R8600	3/202
	1SFL431022R8800	3/202
UA95-30-00RA	1SFL431024R8000	3/196
	1SFL431024R8100	3/196
	1SFL431024R8400	3/196
	1SFL431024R8500	3/196
	1SFL431024R8600	3/196
	1SFL431024R8800	3/196
UMC100.3 DC	1SAJ530000R0100	11/8
UMC100.3 DC EX	1SAJ530000R0200	11/8
UMC100.3 DC EX Coated	1SAJ530000R0210	11/8
UMC100.3 UC	1SAJ530000R1100	11/8
UMC100.3 UC EX	1SAJ530000R1200	11/8
UMC100.3 UC EX Coated	1SAJ530000R1210	11/8
UMC100-PAN	1SAJ590000R0103	11/9
UMC100-PAN CAP	1SAJ510005R0001	11/9
UMCIO-CAB.030	1SAJ3691000R0001	11/10
UMCPAN-CAB.070	1SAJ510003R0002	11/9
UMCPAN-CAB.150	1SAJ510004R0002	11/9
UMCPAN-CAB.300	1SAJ510002R0002	11/9
UMCTB.1	1SAJ929160R0002	11/10
UMCTB-FBP.0	1SAJ929160R0001	11/10
UTF21-FBP.0	1SAJ929400R0002	11/15
UTP22-FBP.0	1SAJ924013R0001	11/15
VB6-30-01-01	GJL1211901R0011	4/10
VB6-30-01-02	GJL1211901R0012	4/10
VB6-30-01-03	GJL1211901R0013	4/10
VB6-30-01-80	GJL1211901R8010	4/10
VB6-30-01-84	GJL1211901R8014	4/10
VB6-30-01-85	GJL1211901R8015	4/10
VB6-30-01-P-01	GJL1211909R0011	4/22
VB6-30-01-P-02	GJL1211909R0012	4/22
VB6-30-01-P-03	GJL1211909R0013	4/22
VB6-30-01-P-80	GJL1211909R8010	4/22
VB6-30-01-P-84	GJL1211909R8014	4/22
VB6-30-01-P-85	GJL1211909R8015	4/22
VB6-30-10-01	GJL1211901R0101	4/10
VB6-30-10-02	GJL1211901R0102	4/10
VB6-30-10-03	GJL1211901R0103	4/10
VB6-30-10-80	GJL1211901R8100	4/10
VB6-30-10-84	GJL1211901R8104	4/10
VB6-30-10-85	GJL1211901R8105	4/10
VB6-30-10-P-01	GJL1211909R0101	4/22
VB6-30-10-P-02	GJL1211909R0102	4/22
VB6-30-10-P-03	GJL1211909R0103	4/22
VB6-30-10-P-80	GJL1211909R8100	4/22
VB6-30-10-P-84	GJL1211909R8104	4/22
VB6-30-10-P-85	GJL1211909R8105	4/22
VB6A-30-01-01	GJL1211911R0011	4/12

Type	Order code	Page
VB6A-30-01-02	GJL1211911R0012	4/12
VB6A-30-01-03	GJL1211911R0013	4/12
VB6A-30-01-80	GJL1211911R8010	4/12
VB6A-30-01-84	GJL1211911R8014	4/12
VB6A-30-01-85	GJL1211911R8015	4/12
VB6A-30-01-P-01	GJL1211919R0011	4/24
VB6A-30-01-P-02	GJL1211919R0012	4/24
VB6A-30-01-P-03	GJL1211919R0013	4/24
VB6A-30-01-P-80	GJL1211919R8010	4/24
VB6A-30-01-P-84	GJL1211919R8014	4/24
VB6A-30-01-P-85	GJL1211919R8015	4/24
VB6A-30-10-01	GJL1211911R0101	4/12
VB6A-30-10-02	GJL1211911R0102	4/12
VB6A-30-10-03	GJL1211911R0103	4/12
VB6A-30-10-80	GJL1211911R8100	4/12
VB6A-30-10-84	GJL1211911R8104	4/12
VB6A-30-10-85	GJL1211911R8105	4/12
VB6A-30-10-P-01	GJL1211919R0101	4/24
VB6A-30-10-P-02	GJL1211919R0102	4/24
VB6A-30-10-P-03	GJL1211919R0103	4/24
VB6A-30-10-P-80	GJL1211919R8100	4/24
VB6A-30-10-P-84	GJL1211919R8104	4/24
VB6A-30-10-P-85	GJL1211919R8105	4/24
VB7-30-01-01	GJL1311901R0011	4/10
VB7-30-01-02	GJL1311901R0012	4/10
VB7-30-01-03	GJL1311901R0013	4/10
VB7-30-01-80	GJL1311901R8010	4/10
VB7-30-01-84	GJL1311901R8014	4/10
VB7-30-01-85	GJL1311901R8015	4/10
VB7-30-01-F-01	GJL1311903R0011	4/32
VB7-30-01-F-02	GJL1311903R0012	4/32
VB7-30-01-F-03	GJL1311903R0013	4/32
VB7-30-01-F-80	GJL1311903R8010	4/32
VB7-30-01-F-84	GJL1311903R8014	4/32
VB7-30-01-F-85	GJL1311903R8015	4/32
VB7-30-01-P-01	GJL1311909R0011	4/22
VB7-30-01-P-02	GJL1311909R0012	4/22
VB7-30-01-P-03	GJL1311909R0013	4/22
VB7-30-01-P-80	GJL1311909R8010	4/22
VB7-30-01-P-84	GJL1311909R8014	4/22
VB7-30-01-P-85	GJL1311909R8015	4/22
VB7-30-10-01	GJL1311901R0101	4/10
VB7-30-10-02	GJL1311901R0102	4/10
VB7-30-10-03	GJL1311901R0103	4/10
VB7-30-10-80	GJL1311901R8100	4/10
VB7-30-10-84	GJL1311901R8104	4/10
VB7-30-10-85	GJL1311901R8105	4/10
VB7-30-10-F-01	GJL1311903R0101	4/32
VB7-30-10-F-02	GJL1311903R0102	4/32
VB7-30-10-F-03	GJL1311903R0103	4/32
VB7-30-10-F-80	GJL1311903R8100	4/32
VB7-30-10-F-84	GJL1311903R8104	4/32
VB7-30-10-F-85	GJL1311903R8105	4/32
VB7-30-10-P-01	GJL1311909R0101	4/22
VB7-30-10-P-02	GJL1311909R0102	4/22
VB7-30-10-P-03	GJL1311909R0103	4/22
VB7-30-10-P-80	GJL1311909R8100	4/22
VB7-30-10-P-84	GJL1311909R8104	4/22
VB7-30-10-P-85	GJL1311909R8105	4/22
VB7A-30-01-01	GJL1311911R0011	4/12
VB7A-30-01-02	GJL1311911R0012	4/12
VB7A-30-01-03	GJL1311911R0013	4/12
VB7A-30-01-80	GJL1311911R8010	4/12
VB7A-30-01-84	GJL1311911R8014	4/12
VB7A-30-01-85	GJL1311911R8015	4/12
VB7A-30-01-F-01	GJL1311913R0011	4/34
VB7A-30-01-F-02	GJL1311913R0012	4/34

Type	Order code	Page
VB7A-30-01-F-03	GJL1311913R0013	4/34
VB7A-30-01-F-80	GJL1311913R8010	4/34
VB7A-30-01-F-84	GJL1311913R8014	4/34
VB7A-30-01-F-85	GJL1311913R8015	4/34
VB7A-30-01-P-01	GJL1311919R0011	4/24
VB7A-30-01-P-02	GJL1311919R0012	4/24
VB7A-30-01-P-03	GJL1311919R0013	4/24
VB7A-30-01-P-80	GJL1311919R8010	4/24
VB7A-30-01-P-84	GJL1311919R8014	4/24
VB7A-30-01-P-85	GJL1311919R8015	4/24
VB7A-30-10-01	GJL1311911R0101	4/12
VB7A-30-10-02	GJL1311911R0102	4/12
VB7A-30-10-03	GJL1311911R0103	4/12
VB7A-30-10-80	GJL1311911R8100	4/12
VB7A-30-10-84	GJL1311911R8104	4/12
VB7A-30-10-85	GJL1311911R8105	4/12
VB7A-30-10-F-01	GJL1311913R0101	4/34
VB7A-30-10-F-02	GJL1311913R0102	4/34
VB7A-30-10-F-03	GJL1311913R0103	4/34
VB7A-30-10-F-80	GJL1311913R8100	4/34
VB7A-30-10-F-84	GJL1311913R8104	4/34
VB7A-30-10-F-85	GJL1311913R8105	4/34
VB7A-30-10-P-01	GJL1311919R0101	4/24
VB7A-30-10-P-02	GJL1311919R0102	4/24
VB7A-30-10-P-03	GJL1311919R0103	4/24
VB7A-30-10-P-80	GJL1311919R8100	4/24
VB7A-30-10-P-84	GJL1311919R8104	4/24
VB7A-30-10-P-85	GJL1311919R8105	4/24
VBC6-30-01-01	GJL1213901R0011	4/11
VBC6-30-01-03	GJL1213901R0013	4/11
VBC6-30-01-04	GJL1213901R0014	4/11
VBC6-30-01-05	GJL1213901R0015	4/11
VBC6-30-01-07	GJL1213901R0017	4/11
VBC6-30-01-16	GJL1213901R0106	4/11
VBC6-30-01-P-01	GJL1213909R0011	4/23
VBC6-30-01-P-03	GJL1213909R0013	4/23
VBC6-30-01-P-04	GJL1213909R0014	4/23
VBC6-30-01-P-05	GJL1213909R0015	4/23
VBC6-30-01-P-07	GJL1213909R0017	4/23
VBC6-30-01-P-16	GJL1213909R0106	4/23
VBC6-30-10-03	GJL1213901R0103	4/11
VBC6-30-10-04	GJL1213901R0104	4/11
VBC6-30-10-05	GJL1213901R0105	4/11
VBC6-30-10-07	GJL1213901R0107	4/11
VBC6-30-10-16	GJL1213901R1106	4/11
VBC6-30-10-P-01	GJL1213909R0101	4/23
VBC6-30-10-P-03	GJL1213909R0103	4/23
VBC6-30-10-P-04	GJL1213909R0104	4/23
VBC6-30-10-P-05	GJL1213909R0105	4/23
VBC6-30-10-P-06	GJL1213909R0106	4/23
VBC6-30-10-P-07	GJL1213909R0107	4/23
VBC6A-30-01-01	GJL1213911R0011	4/13
VBC6A-30-01-03	GJL1213911R0013	4/13
VBC6A-30-01-04	GJL1213911R0014	4/13
VBC6A-30-01-05	GJL1213911R0015	4/13
VBC6A-30-01-07	GJL1213911R0017	4/13
VBC6A-30-01-16	GJL1213911R0106	4/13
VBC6A-30-10-01	GJL1213911R0101	4/13
VBC6A-30-10-03	GJL1213911R0103	4/13
VBC6A-30-10-04	GJL1213911R0104	4/13
VBC6A-30-10-05	GJL1213911R0105	4/13
VBC6A-30-10-07	GJL1213911R0107	4/13
VBC6A-30-10-16	GJL1213911R1106	4/13
VBC7-30-01-01	GJL1313901R0011	4/11
VBC7-30-01-03	GJL1313901R0013	4/11
VBC7-30-01-04	GJL1313901R0014	4/11



# Index

## Type classification

Type	Order code	Page	Type	Order code	Page	Type	Order code	Page
VBC7-30-01-05	GJL1313901R0015	4/11	VBC7A-30-10-P-07	GJL1313919R0107	4/25	ZAF1650	1SFN156570R7026	3/269
VBC7-30-01-07	GJL1313901R0017	4/11	VBC7A-30-10-P-16	GJL1313919R1106	4/25	ZAF2650	1SFN156670R7026	3/269
VBC7-30-01-16	GJL1313901R1016	4/11	VE5-2	1SBN030210R1000	3/282	ZAF460	1SFN155770R6806	3/269
VBC7-30-01-F-01	GJL1313903R0011	4/33	VEM4	1SBN030111R1000	3/248		1SFN155770R6906	3/269
VBC7-30-01-F-03	GJL1313903R0013	4/33	VEM4K	1SBN030113R1000	3/264		1SFN155770R7006	3/269
VBC7-30-01-F-04	GJL1313903R0014	4/33	VH800	SK829070-F	3/152		1SFN155770R7106	3/269
VBC7-30-01-F-05	GJL1313903R0015	4/33	VI150-FBP.0	1SAJ650000R0100	11/10	ZAF750	1SFN156170R6806	3/269
VBC7-30-01-F-07	GJL1313903R0017	4/33	VI155-FBP.0	1SAJ655000R0100	11/10		1SFN156170R6906	3/269
VBC7-30-01-F-16	GJL1313903R1016	4/33	VM140/190	1SFN034403R1000	3/248		1SFN156170R7006	3/269
VBC7-30-01-P-01	GJL1313909R0011	4/23	VM1650H	1SFN036503R1001	3/248		1SFN156170R7106	3/269
VBC7-30-01-P-03	GJL1313909R0013	4/23	VM19	1SFN030300R1000	3/248	ZL1250	1SFN166403R1000	3/269
VBC7-30-01-P-04	GJL1313909R0014	4/23	VM205/265	1SFN035203R1000	3/248	ZL1350	1SFN166503R1000	3/269
VBC7-30-01-P-05	GJL1313909R0015	4/23	VM3	1SBN031005T1000	5/13	ZL1350-1	1SFN166503R1001	3/269
VBC7-30-01-P-07	GJL1313909R0017	4/23	VM370/400	1SFN035403R1000	3/248	ZL1650	1SFN166703R1000	3/269
VBC7-30-01-P-16	GJL1313909R1016	4/23	VM4	1SBN030105T1000	3/248	ZL1650-1	1SFN166703R1001	3/269
VBC7-30-10-01	GJL1313901R0101	4/11	VM750H	1SFN035700R1000	3/248	ZL2050	1SFN167003R1000	3/269
VBC7-30-10-03	GJL1313901R0103	4/11	VM750V	1SFN035701R1000	3/248	ZL2050-1	1SFN167003R1001	3/269
VBC7-30-10-04	GJL1313901R0104	4/11	VM96-4	1SBN033405T1000	3/248	ZL2650	1SFN166603R1000	3/269
VBC7-30-10-05	GJL1313901R0105	4/11	WA4-10	1SBN040100R1010	3/254	ZL400	1SFN165703R1000	3/269
VBC7-30-10-07	GJL1313901R0107	4/11	WA4-11	1SBN040100R1011	3/254	ZL460	1SFN165903R1000	3/269
VBC7-30-10-16	GJL1313901R1106	4/11	WA4-12	1SBN040100R1012	3/254	ZL580	1SFN166103R1000	3/269
VBC7-30-10-F-01	GJL1313903R0101	4/33	WA4-13	1SBN040100R1013	3/254	ZL750	1SFN166303R1000	3/269
VBC7-30-10-F-03	GJL1313903R0103	4/33	WA4-14	1SBN040100R1014	3/254	ZLU110	1SFN164502R1000	3/295
VBC7-30-10-F-04	GJL1313903R0104	4/33	WA4-96-11	1SBN040200R1011	3/254	ZLU50	1SBN163502R1000	3/295
VBC7-30-10-F-05	GJL1313903R0105	4/33	WA4-96-12	1SBN040200R1012	3/254	ZLU63	1SBN163702R1000	3/295
VBC7-30-10-F-07	GJL1313903R0107	4/33	WA4-96-13	1SBN040200R1013	3/254	ZLU75	1SBN164102R1000	3/295
VBC7-30-10-F-16	GJL1313903R1106	4/33	WA4-96-14	1SBN040200R1014	3/254	ZLU95	1SFN164302R1000	3/295
VBC7-30-10-P-01	GJL1313909R0101	4/23	WB75-A	FPTN372726R1001	3/290	ZP1650	1SFN166521R1070	3/269
VBC7-30-10-P-03	GJL1313909R0103	4/23		FPTN372726R1002	3/290	ZP2650	1SFN166621R1070	3/269
VBC7-30-10-P-04	GJL1313909R0104	4/23		FPTN372726R1003	3/290	ZW1650	1SFN166510R1001	3/269
VBC7-30-10-P-05	GJL1313909R0105	4/23		FPTN372726R1004	3/290	ZW2650	1SFN166610R1000	3/269
VBC7-30-10-P-07	GJL1313909R0107	4/23		FPTN372726R1005	3/290	ZW460	1SFN165710R1000	3/269
VBC7-30-10-P-16	GJL1313909R1106	4/23		FPTN372726R1006	3/290	ZW750	1SFN166110R1000	3/269
VBC7A-30-01-01	GJL1313911R0011	4/13		FPTN372726R1007	3/290			
VBC7A-30-01-03	GJL1313911R0013	4/13		FPTN372726R1008	3/290			
VBC7A-30-01-04	GJL1313911R0014	4/13	WRB-1000	1SAZ701903R1013	6/44			
VBC7A-30-01-05	GJL1313911R0015	4/13	WRB-400	1SAZ701903R1011	6/44			
VBC7A-30-01-07	GJL1313911R0017	4/13	WRB-600	1SAZ701903R1012	6/44			
VBC7A-30-01-16	GJL1313911R0016	4/13	WRBG	1SAZ701903R1030	6/44			
VBC7A-30-01-F-01	GJL1313913R0011	4/35	WRH-F	1SAZ701903R1001	6/44			
VBC7A-30-01-F-03	GJL1313913R0013	4/35	XT25 160	1SDA068164R1	12/21			
VBC7A-30-01-F-04	GJL1313913R0014	4/35	XT25 160 MA 160	1SDA076530R1	12/23			
VBC7A-30-01-F-05	GJL1313913R0015	4/35	XT45 250 Ekip I In250	1SDA068480R1	12/23			
VBC7A-30-01-F-07	GJL1313913R0017	4/35	ZA110	1SFN154310R8006	3/295			
VBC7A-30-01-F-16	GJL1313913R1016	4/35		1SFN154310R8106	3/295			
VBC7A-30-01-P-01	GJL1313919R0011	4/25		1SFN154310R8406	3/295			
VBC7A-30-01-P-03	GJL1313919R0013	4/25		1SFN154310R8506	3/295			
VBC7A-30-01-P-04	GJL1313919R0014	4/25		1SFN154310R8606	3/295			
VBC7A-30-01-P-05	GJL1313919R0015	4/25		1SFN154310R8806	3/295			
VBC7A-30-01-P-07	GJL1313919R0017	4/25	ZA16	1SBN151410R8006	3/295			
VBC7A-30-01-P-16	GJL1313919R1016	4/25		1SBN151410R8106	3/295			
VBC7A-30-10-01	GJL1313911R0101	4/13		1SBN151410R8406	3/295			
VBC7A-30-10-03	GJL1313911R0103	4/13		1SBN151410R8506	3/295			
VBC7A-30-10-04	GJL1313911R0104	4/13		1SBN151410R8606	3/295			
VBC7A-30-10-05	GJL1313911R0105	4/13		1SBN151410R8806	3/295			
VBC7A-30-10-07	GJL1313911R0107	4/13	ZA40	1SBN152410R8006	3/295			
VBC7A-30-10-16	GJL1313911R1106	4/13		1SBN152410R8106	3/295			
VBC7A-30-10-F-01	GJL1313913R0101	4/35		1SBN152410R8406	3/295			
VBC7A-30-10-F-03	GJL1313913R0103	4/35		1SBN152410R8506	3/295			
VBC7A-30-10-F-04	GJL1313913R0104	4/35		1SBN152410R8606	3/295			
VBC7A-30-10-F-05	GJL1313913R0105	4/35		1SBN152410R8806	3/295			
VBC7A-30-10-F-07	GJL1313913R0107	4/35	ZA75	1SBN153510R8006	3/295			
VBC7A-30-10-F-16	GJL1313913R1106	4/35		1SBN153510R8106	3/295			
VBC7A-30-10-P-01	GJL1313919R0101	4/25		1SBN153510R8406	3/295			
VBC7A-30-10-P-03	GJL1313919R0103	4/25		1SBN153510R8506	3/295			
VBC7A-30-10-P-04	GJL1313919R0104	4/25		1SBN153510R8606	3/295			
VBC7A-30-10-P-05	GJL1313919R0105	4/25		1SBN153510R8806	3/295			

# Marketing material

http://new.abb.com/low-voltage/products/motor-protection

**ABB** HOME • OFFERINGS • LOW VOLTAGE PRODUCTS • MOTOR PROTECTION AND CONTROL GLOBAL SITE ▼

## Motor protection and control

To keep it running, you need Control

ABB's motor protection and control offering is among the widest on the market. From system integrator, OEM, engineering consultant and distributor to panel builder and industrial end-user, our comprehensive range of motor starting solutions, products and services delivers the certainty of consistent quality and performance.



Are you looking for support or purchase information?  
 ↓ Contact us

### Highlights



**New ABB motor starting solution introduces tool-free, push-in wiring**



**Motor starting solution with Push-in Spring terminals**



**ABB launches all-new range of hum-free installation contactors**



**ABB invests \$11m in new test lab for low-voltage power solutions**

### Our offering

 <p><b>Starting solutions</b> Motor starting solution with Push-In Spring terminals → Link</p>	 <p><b>Starting solutions</b> Get the perfect match → Link</p>	 <p><b>Manual motor starters</b> A complete motor protection concept → Link</p>	 <p><b>Transformer protection</b> Fuseless protection on the primary side → Link</p>	 <p><b>3-pole contactors and overload relays</b> For motor starting and power switching → Link</p>	 <p><b>4-pole contactors</b> For power switching → Link</p>
 <p><b>Contactor relays</b> For switching control and auxiliary circuits → Link</p>	 <p><b>Contactors for capacitor switching</b> Withstand unlimited peak current → Link</p>	 <p><b>Contactors for DC switching</b> For a compact and efficient way of DC switching → Link</p>	 <p><b>Contactors and motor protection for railway applications</b> Meeting the most stringent standards and requirements → Link</p>	 <p><b>Contactors for safety applications</b> Help make your system safer → Link</p>	 <p><b>Installation contactors</b> Hum-free control → Link</p>
 <p><b>Electronic Compact Starters</b> High performance with innovative hybrid starters → Link</p>	 <p><b>ABB is ready to support IE3 high-efficiency motors!</b> ABB control and protection solutions for energy efficiency motors</p>	 <p><b>Service</b> Full range of Products and Services for entire equipment life cycle</p>			

### Products and documents

Documents Tools

#### Downloads for Contactors

You now see 2 files within All files (2539) → Advanced search → Documents in all languages

Show all (2539)

Popular documents (2) >

Advertisement (35)

 <p><b>DNN/GL-certificate, Contactors, AF116-30...AF370-30 and AF116-40...AF370-40</b> Summary: No summary available Certificate - English - 2019-01-15 - 0,30 MB <span>PDF</span></p>
 <p><b>1SBC101008N0201 Push-In Spring Technical presentation</b> Summary: Technical presentation of Push-in Spring technology</p>

Videos, prints, technical presentations and more

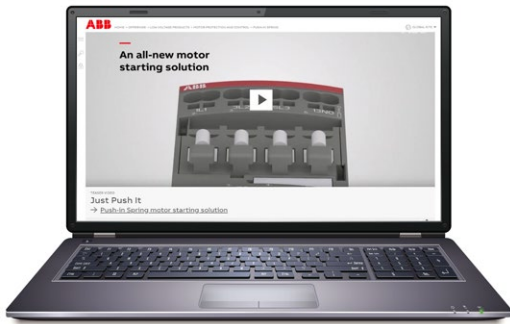

Main online tools

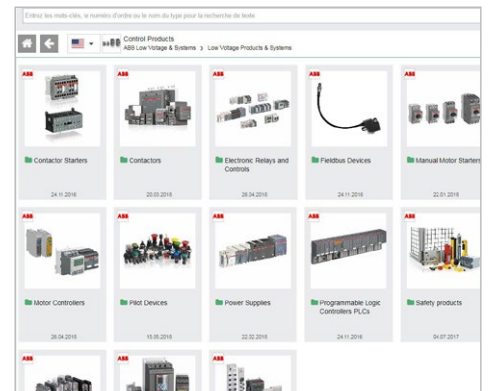
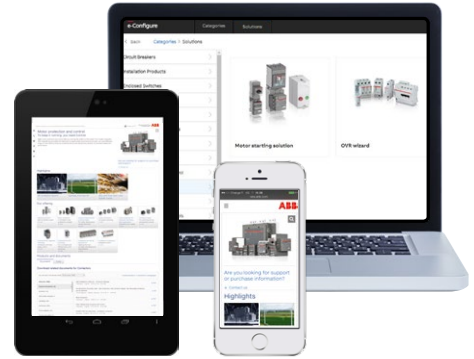

Cadenas portal: Download 2D or 3D files according to your needs (STEP, IGES...)

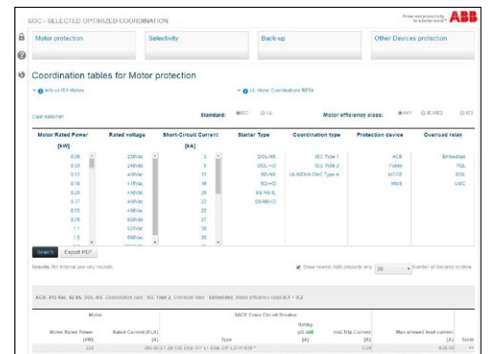

Select Optimized Coordination tables SOC

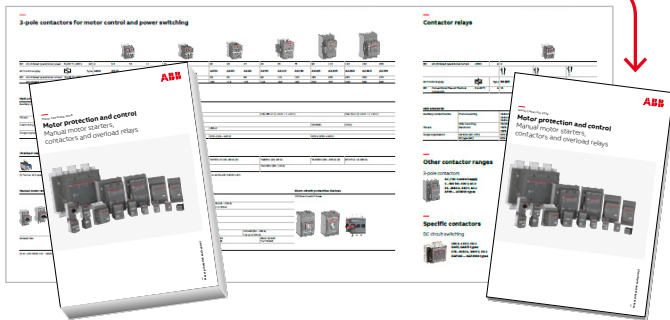

Main catalog : 1SBC100214C0201



For direct product details information, use product type or order code, ex: [www.abb.com/productdetails/AF09-30-10-13](http://www.abb.com/productdetails/AF09-30-10-13) or [www.abb.com/productdetails/1SBL137001R1310](http://www.abb.com/productdetails/1SBL137001R1310)





—  
**ABB France**  
**Electrification Products Division**  
**Low Voltage Products and Systems**  
3, rue Jean Perrin  
F-69687 Chassieu cedex / France

—  
**ABB STOTZ-KONTAKT GmbH**  
**Electrification Products Division**  
**Low Voltage Products and Systems**  
Eppelheimer Straße 82  
D-69123 Heidelberg / Germany

—  
**ABB AB**  
**Electrification Products Division**  
**Low Voltage Products and Systems**  
Protection & Connection  
SE-721 61 Västerås / Sweden

**You can find the address of your local sales organization  
on the ABB home page**



<http://new.abb.com/low-voltage/products/motor-protection>



<http://www.abb.com/lowvoltage>

We reserve the right to make technical changes or modify the contents of this document without prior notice. ABB does not accept any responsibility whatsoever for potential errors or possible lack of information in this document.

We reserve all rights in this document and in the subject matter and illustrations contained therein. Any reproduction, disclosure to third parties or utilization of its contents – in whole or in parts – is forbidden without prior written consent of ABB.

Copyright© 2019 ABB - All rights reserved

Courtesy of Steven Engineering, Inc - (800) 258-9200 - [sales@steveneng.com](mailto:sales@steveneng.com) - [www.stevenengineering.com](http://www.stevenengineering.com)