

Speed Controller with Uni One-touch Fitting AS Series

New-stand male threads for piping that reduces the screw-in time by 1/3.

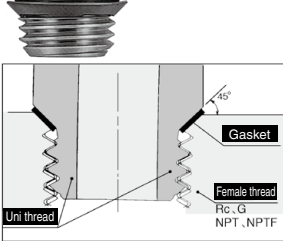

Shape of Uni thread ridge

Use of the chamfered surface of the female thread as the seat surface and adoption of gaskets made by laminating NBR on both surfaces of stainless steel plates achieve secure sealing regardless of the difference of diameters due to the female thread type, deviations due to the tolerance, or the size of the chamfered corner.

(Any standard chamfered female thread can be used.)

A ridge shape has been created as a Uni thread for common applications for Rc, G, NPT and NPTF.

The male thread for piping drastically cuts piping man-hours.

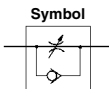

Flow Direction Symbols on Body

	Meter-out type	Meter-in type
Indication symbol		
Symbol		

Model

Model		Connection thread Uni thread	Applicable tubing O.D.													
Elbow type	Universal type		Metric size						Inch size							
			3.2	4	6	8	10	12	1/8"	5/32"	3/16"	1/4"	5/16"	3/8"	1/2"	
AS22□1F-U01	AS23□1F-U01	1/8	●	●	●	●	●	●	●	●	●	●	●	●	●	●
AS22□1F-U02	AS23□1F-U02	1/4	●	●	●	●	●	●	●	●	●	●	●	●	●	●
AS32□1F-U02	AS33□1F-U02	1/4		●	●	●	●	●	●	●	●	●	●	●	●	●
AS32□1F-U03	AS33□1F-U03	3/8		●	●	●	●	●	●	●	●	●	●	●	●	●
AS42□1F-U04	AS43□1F-U04	1/2						●	●	●	●	●	●	●	●	●

Note 1) □ = Elbow type only

Note 2) □ indicates the control type ("0" for meter-out and "1" for meter-in).

Note 3) Meter-out and meter-in types can be visually differentiated by the lock nut.

The lock nut on the meter-out type is zinc chromated (the round lock nut is electroless nickel plated), while that on the meter-in type is black zinc chromate plated.

Note 4) Models marked with "●" are nickel plated as standard.

Note 5) The elbow type is electroless nickel plated as standard. (N specifications)

Specifications

Fluid	Air
Max. operating pressure	1 MPa
Min. operating pressure	0.1 MPa
Proof pressure	1.5 MPa
Ambient and fluid temperature	-5 to 60°C (No freezing)
Applicable tubing material ⁽¹⁾	Nylon, Soft-nylon, Polyurethane
Mounting thread	Uni-thread
Thread seal	Gasket
Option	Round lock nut, Electroless nickel plated ⁽²⁾

Note 1) Use caution regarding the max. operating pressure when soft nylon or polyurethane tubing is used. (Refer to pages 464 and 465 for details.)

Note 2) Brass parts are all electroless nickel plated.

Flow Rate and Sonic Conductance

Model		AS22□1F-U01 AS23□1F-U02	AS22□1F-U02 AS23□1F-U02	AS32□1F AS33□1F	AS42□1F-U04 AS43□1F-U04
Tubing O.D.	Metric size	φ3.2, φ4	φ6, φ8, φ4	φ6, φ8, φ10, φ12	φ10, φ12
	Inch size	1/8", 5/32"	3/16", 1/4", 5/16"	1/4", 5/16", 3/8"	3/8", 1/2"
Controlled flow Free flow	Flow rate (L/min (ANR))	180 230	260 390	460 660 790 920	1580 1710
	Sonic conductance dm ³ /(s·bar)	0.5 0.64	0.72 1.1	1.3 1.8 2.2 2.6	4.4 4.8
Critical pressure ratio	Controlled flow	0.25	0.3	0.25	0.25
	Free flow	0.2	0.3	0.2	0.3

Note) Flow rate values are measured at 0.5 MPa and 20°C.

How to Order

AS 2 2 1 1F - U02 - 06 [] - [] - []

Body size

2	1/8, 1/4 standard
3	3/8 standard
4	1/2 standard

Type

2	Elbow
3	Universal

Control type

0	Meter-out
1	Meter-in

With One-touch fitting

Lock nut option

NH	Hexagon lock nut
J	Round lock nut

Made to Order

X260 Antistatic type
Refer to page 635 for details.

Option

NH	None
N	Electroless nickel plated

Applicable tubing O.D. (Note)

Metric size	Inch size
23	ø3.2 ^a
04	ø4
06	ø6
08	ø8
10	ø10
12	ø12
	13

Note) For applicable tubing O.D. selection, refer to the Model on page 630.
* Use ø1/8" tube.

Bore size

U01	Uni 1/8
U02	Uni 1/4
U03	Uni 3/8
U04	Uni 1/2

AS-F

TMH

ASD

AS

AS-FE

KE

AS-FG

AS-FP

AS-FM

AS-D

AS-T

ASP

ASN

AQ

ASV

AK

VCHC

ASR
ASQ

Needle Valve/Flow Rate Characteristics

Note) The flow rate characteristics are representative values.

AS2201F-U01, AS2211F-U01
AS2301F-U01, AS2311F-U01

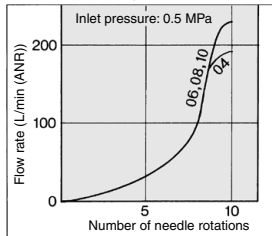

AS2201F-U02, AS2211F-U02
AS2301F-U02, AS2311F-U02

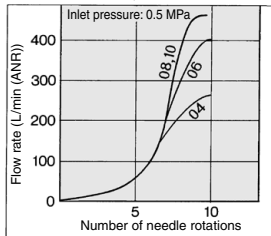

AS3201F, AS3211F
AS3301F, AS3311F

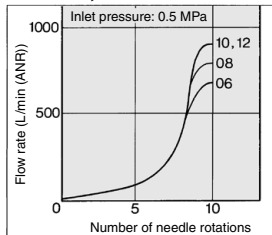

AS4201F, AS4211F
AS4301F, AS4311F

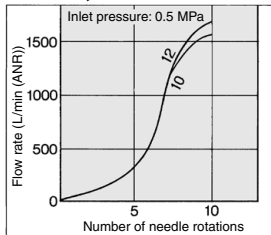

AS Series

Construction/Component Parts

Elbow type Meter-out type

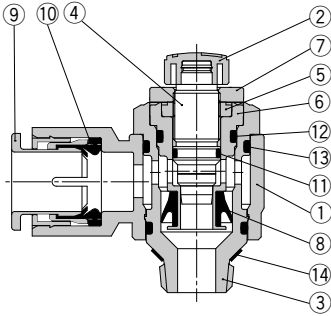

Meter-in type

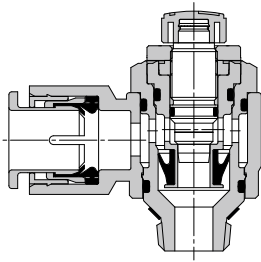

Universal type Meter-out type

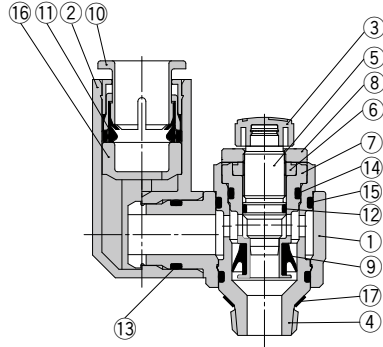

Meter-in type

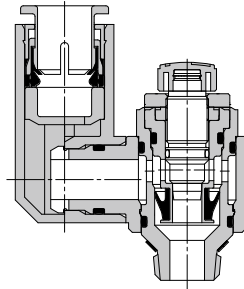

Component Parts: Elbow Type

No.	Description	Material	Note
1	Body A	PBT	
2	Handle	PBT	
3	Body B	Brass	Electroless nickel plated
4	Needle	Brass	Electroless nickel plated
5	Needle guide	Brass	Electroless nickel plated
6	Seat ring	Brass	(1)
7	Lock nut	Steel (2)	Meter-out Zinc chromate plated (3) Meter-in Black zinc chromate plated
8	U seal	HNBR	
9	Cassette	—	
10	Seal	NBR	
11	O-ring	NBR	
12	O-ring	NBR	
13	O-ring	NBR	
14	Gasket	NBR, Stainless steel	

Note 1) Only AS22□1F-U01 and AS32□1F-U02 are electroless nickel plated.
 Note 2) The material of the lock nut option-J (round type) is brass. However, note that only the AS22□1F uses steel.
 Note 3) The surface treatment of the lock nut option-J (round type) is electroless nickel plated.

Component Parts: Universal Type

No.	Description	Material	Note
1	Body A	PBT	
2	Elbow body	PBT	
3	Handle	PBT	
4	Body B	Brass	Electroless nickel plated
5	Needle	Brass	Electroless nickel plated
6	Needle guide	Brass	Electroless nickel plated
7	Seat ring	Brass	(1)
8	Lock nut	Steel (2)	Meter-out Zinc chromate plated (3) Meter-in Black zinc chromate plated
9	U seal	HNBR	
10	Cassette	—	
11	Seal	NBR	
12	O-ring	NBR	
13	O-ring	NBR	
14	O-ring	NBR	
15	O-ring	NBR	
16	Spacer	—	
17	Gasket	NBR, Stainless steel	

Note 1) Only AS22□1F-U01 and AS32□1F-U02 are electroless nickel plated.
 Note 2) The material of the lock nut option-J (round type) is brass. However, note that only the AS23□1F uses steel.
 Note 3) The surface treatment of the lock nut option-J (round type) is electroless nickel plated.

Speed Controller with Uni One-touch Fitting AS Series



Elbow Type/Metric Size

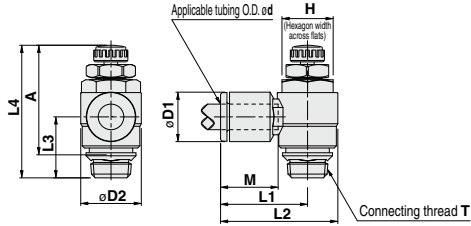

Model	Applicable tubing O.D. ϕ d	T Uni thread	H	ϕ D1	ϕ D2	L1	L2	L3	L4 (1)		A (2)		M	Weight (g)
									Max.	Min.	Max.	Min.		
AS22□1F-U01-23	3.2	1/8	12	7.8	14.2	20.8	27.9	14.3	36.1	31.1	30.5	25.5	14.5	17
AS22□1F-U01-04	4			8.9		21.1	28.2						17	
AS22□1F-U01-06	6			11.0		22.5	29.6						15.5	
AS22□1F-U01-08	8			15.2		25.3	32.4						18.5	
AS22□1F-U01-10	10		18.5	33.1	40.2	15.0						21	21	
AS22□1F-U02-04	4	1/4	17	8.9	18.5	23.3	32.5	17.2	39.4	34.4	32.0	26.6	14.5	32
AS22□1F-U02-06	6			11.0		23.9	33.1						15.5	
AS22□1F-U02-08	8			15.2		27.2	36.4						18.5	
AS22□1F-U02-10	10			18.5		35.3	44.5						21	
AS32□1F-U02-06	6	1/4	19	11.0	23.0	26.4	37.9	20.3	45.9	40.9	38.1	33.1	17	53
AS32□1F-U02-08	8			15.2		29.5	41.0						18.5	
AS32□1F-U02-10	10			18.5		31.8	43.3						21	
AS32□1F-U02-12	12			20.9		32.8	44.3						22	
AS32□1F-U03-06	6	3/8	19	11.0	23.0	26.4	37.9	19.4	45.0	40.0	37.6	32.6	17	53
AS32□1F-U03-08	8			15.2		29.5	41.0						18.5	
AS32□1F-U03-10	10			18.5		31.8	43.3						21	
AS32□1F-U03-12	12			20.9		32.8	44.3						22	
AS42□1F-U04-10	10	1/2	24	18.5	28.6	33.6	47.9	22.4	54.6	47.1	44.5	37.0	21	94
AS42□1F-U04-12	12			21.7		35.2	49.5						22	95

Note 1) Reference dimensions
Note 2) Reference dimensions of Uni thread after installation.

Universal Type/Metric Size

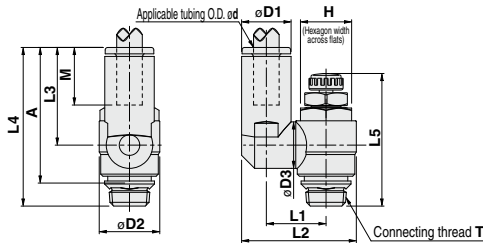

Model	Applicable tubing O.D. ϕ d	T Uni thread	H	ϕ D1	ϕ D2	ϕ D3	L1	L2	L3	L4	L5 (1)		A (2)		M	Weight (g)				
											Max.	Min.	Max.	Min.						
AS23□1F-U01-23	3.2	1/8	12	7.8	14.2	9.3	13.4	24.8	18.9	33.2	36.1	31.1	30.5	25.5	14.5	17				
AS23□1F-U01-04	4			8.9											21.1	28.2	17			
AS23□1F-U01-06	6			11.0											22.5	29.6	15.5			
AS23□1F-U01-08	8			15.2											25.3	32.4	18.5			
AS23□1F-U01-10	10		18.5	33.1	40.2	15.0								21	21					
AS23□1F-U02-04	4	1/4	17	8.9	18.5	12.9	10.9	16.7	31.4	20.6	37.8	39.4	34.4	32.0	26.6	14.5	32			
AS23□1F-U02-06	6			11.0												18.3	35.2	24.4	40.8	15.5
AS23□1F-U02-08	8			15.2												19.6	38.1	26.8	43.2	18.5
AS23□1F-U02-10	10			18.5												19.9	35.9	20.6	42.5	21
AS33□1F-U02-06	6	1/4	19	11.0	23.0	16.2	22.5	43.3	28.3	48.6	45.9	40.9	38.1	33.1	17	54				
AS33□1F-U02-08	8			15.2											20.6	39.7	24.4	43.7	18.5	
AS33□1F-U02-10	10			18.5											22.5	43.3	28.3	47.7	21	
AS33□1F-U02-12	12			20.9											23.5	45.5	29.3	49.6	22	
AS33□1F-U03-06	6	3/8	19	11.0	23.0	16.2	10.9	18.9	35.9	20.6	41.6	45.0	40.0	37.6	32.6	17	54			
AS33□1F-U03-08	8			15.2												20.6	39.7	24.4	42.8	18.5
AS33□1F-U03-10	10			18.5												22.5	43.3	28.3	47.7	21
AS33□1F-U03-12	12			20.9												23.5	45.5	29.3	48.7	22
AS43□1F-U04-10	10	1/2	24	18.5	28.6	16.2	16.2	25.3	48.9	28.3	50.7	54.6	47.1	44.5	37.0	21	98			
AS43□1F-U04-12	12			20.9												19.4	26.8	51.6	30.8	53.2

Note 1) Reference dimensions
Note 2) Reference dimensions of Uni thread after installation.



AS-F

TMH

ASD

AS

AS-FE

KE

AS-FG

AS-FP

AS-FM

AS-D

AS-T

ASP

ASN

AQ

ASV

AK

VCHC

ASR
ASQ

AS Series



Elbow Type/Inch Size

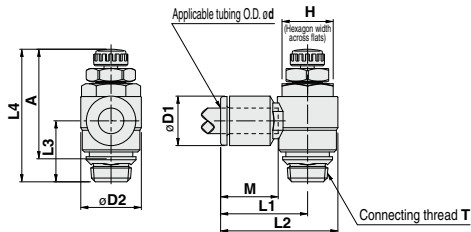

Model	Applicable tubing O.D. ϕd	T Uni thread	H	$\phi D1$	$\phi D2$	L1	L2	L3	L4 (1)		A (2)		M	Weight (g)
									Max.	Min.	Max.	Min.		
AS22□1F-U01-01	1/4"	1/8	12	7.8	14.2	20.8	27.9	14.3	36.1	31.1	30.5	25.5	14.5	17
AS22□1F-U01-03	5/32"			8.9		21.1	28.2						17	
AS22□1F-U01-05	3/16"			11.4		23.1	30.2						16.5	
AS22□1F-U01-07	1/4"	1/4	17	13.2	18.5	23.9	31.0	17.2	39.4	34.4	32.0	26.6	17	19
AS22□1F-U01-09	5/16"			15.2		25.3	32.4						18.5	
AS22□1F-U02-03	5/16"			8.9		23.3	32.5						14.5	
AS22□1F-U02-05	3/8"	1/4	17	11.4	23.0	24.9	34.2	19	45.9	40.9	38.1	33.1	16.5	33
AS22□1F-U02-07	1/4"			13.2		25.2	34.5						17	
AS22□1F-U02-09	5/16"			15.2		27.2	36.4						18.5	
AS22□1F-U02-11	3/8"	1/4	19	17.9	23.0	35.3	44.5	19.4	54.6	47.1	44.5	37.0	21	36
AS32□1F-U02-07	1/4"			13.2		27.8	39.3						17	
AS32□1F-U02-09	5/16"			15.2		29.5	41.0						18.5	
AS32□1F-U02-11	3/8"	3/8	19	17.9	23.0	31.8	43.3	22.4	54.6	47.1	44.5	37.0	21	57
AS32□1F-U03-07	1/4"			13.2		27.8	39.3						17	
AS32□1F-U03-09	5/16"			15.2		29.5	41.0						18.5	
AS32□1F-U03-11	3/8"	1/2	24	17.9	18.6	31.8	43.3	22.4	54.6	47.1	44.5	37.0	21	57
AS42□1F-U04-11	3/8"			17.9		33.6	47.9						21	
AS42□1F-U04-13	1/2"			21.4		35.2	49.5						22	

Note 1) Reference dimensions
 Note 2) Reference dimensions of Uni thread after installation.



Universal Type/Inch Size

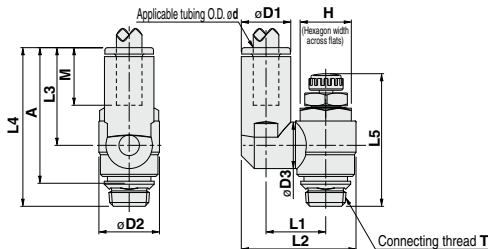

Model	Applicable tubing O.D. ϕd	T Uni thread	H	$\phi D1$	$\phi D2$	$\phi D3$	L1	L2	L3	L4	L5 (1)		A (2)		M	Weight (g)				
											Max.	Min.	Max.	Min.						
AS23□1F-U01-01	1/4"	1/8	12	7.8	14.2	9.3	13.4	24.8	18.9	33.2	36.1	31.1	30.5	25.5	14.5	17				
AS23□1F-U01-03	5/32"			8.9											10.3	14.2	27.0	21.5	35.9	17
AS23□1F-U01-05	3/16"			11.4											12.9	16.2	30.9	24.7	38.2	16.5
AS23□1F-U01-07	1/4"	1/4	17	13.2	18.5	11.4	17.4	33.2	22.3	39.5	39.4	34.4	32.0	26.6	17	20				
AS23□1F-U01-09	5/16"			15.2											12.9	16.2	30.9	24.7	38.2	18.5
AS23□1F-U02-03	5/16"			8.9											9.3	15.6	29.2	18.9	36.1	14.5
AS23□1F-U02-05	3/8"	1/4	17	11.4	23.0	10.3	16.4	31.1	21.5	38.8	45.9	40.9	38.1	33.1	16.5	34				
AS23□1F-U02-07	1/4"			13.2											11.4	17.4	33.2	22.3	39.5	17
AS23□1F-U02-09	5/16"			15.2											12.9	16.2	30.9	24.7	38.2	18.5
AS23□1F-U02-11	3/8"	1/4	19	17.9	23.0	11.4	19.6	37.7	22.3	44.2	45.9	40.9	38.1	33.1	21	56				
AS33□1F-U02-07	1/4"			13.2											12.9	20.6	39.7	24.4	43.7	17
AS33□1F-U02-09	5/16"			15.2											12.9	20.6	39.7	24.4	43.7	18.5
AS33□1F-U02-11	3/8"	1/2	24	17.9	28.6	16.2	22.5	42.9	28.3	47.7	54.6	47.1	44.5	37.0	21	61				
AS33□1F-U03-07	1/4"			13.2											11.4	19.6	37.7	22.3	43.3	17
AS33□1F-U03-09	5/16"			15.2											12.9	20.6	39.7	24.4	42.8	18.5
AS33□1F-U03-11	3/8"	1/2	24	17.9	28.6	16.2	22.5	42.9	28.3	47.7	54.6	47.1	44.5	37.0	21	61				
AS43□1F-U04-11	3/8"			17.9											16.2	25.3	48.6	28.3	50.7	21.1
AS43□1F-U04-13	1/2"			21.7											19.4	26.8	52.5	30.8	53.2	22

Note 1) Reference dimensions
 Note 2) Reference dimensions of Uni thread after installation.



Antistatic Type

X260

Model

Model	Applicable tubing O.D.			
	Metric size			
	4	6	8	10
AS22□1F-U01	●	●	●	●
AS22□1F-U02	●	●	●	●
AS32□1F-U03		●	●	

Note 1) Electroless nickel plated

How to Order

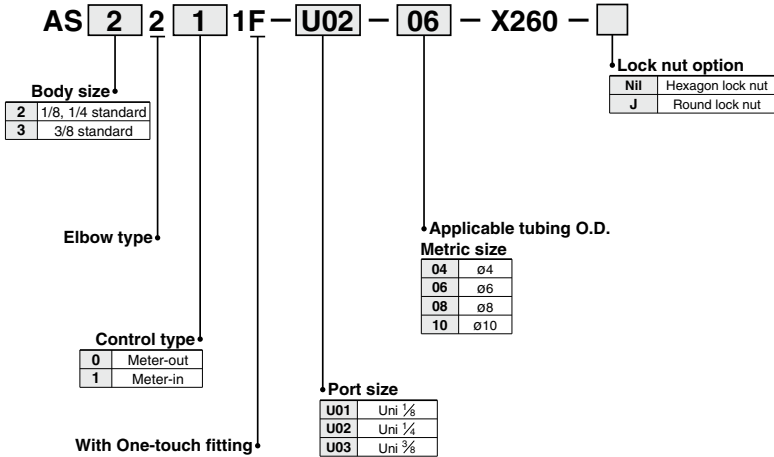

AS-F

TMH

ASD

AS

AS-FE

KE

AS-FG

AS-FP

AS-FM

AS-D

AS-T

ASP

ASN

AQ

ASV

AK

VCHC

ASR

ASQ