

# SECTION U

## Table of Contents



Hubbell Trench Duct Series



Hubbell Wall Duct Series

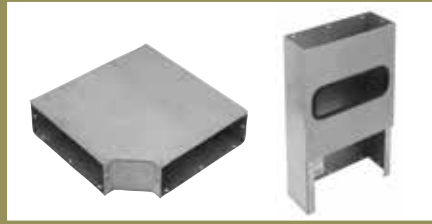

Hubbell Underfloor Duct Series



Hubbell Trench Duct Series	Page
Features and Benefits	U-3
Trench Duct Series and Fittings	U-4
Additional Trench Duct Fittings	U-5
Hubbell Wall Duct Series	
Features and Benefits	U-6
Wall Duct Series and Fittings	U-7
Wall Duct Fittings	U-8
Additional Wall Duct Fittings	U-9

Hubbell Underfloor Duct Series	Page
Features and Benefits	U-10
Conventional, Flush and Blank Profiles	U-11
Technical Information and Wire Fill Capacity Chart	U-12
Raceway Fittings	U-13
Raceway Junction Boxes and Accessories	U-14
Junction Box Dimensions	U-15
Raceway Activation Kits	U-16

# Trench and Wall Duct Products

## Products at a Glance

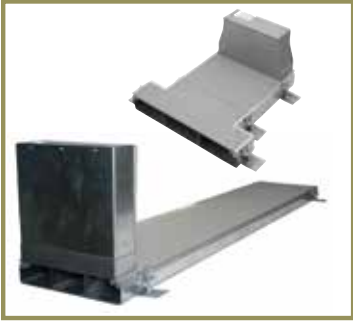

### Hubbell Trench Duct Series

The Hubbell Trench system is an in-floor wire management system that meets today's high capacity wiring needs that require multiple circuit separation. Trench duct is commonly used as a feeder system for medical wall duct when installing radiology equipment such as X-Ray and MRI machines.



### Hubbell Wall Duct Series

The Hubbell Wall Duct is available in either flush or surface mount and a combination will usually be required on any job. Vertical runs in the walls are usually flush mounted with horizontal runs on walls and all duct in ceiling plenum are typically surface type.



### Hubbell Underfloor Duct Series

The Hubbell Underfloor Duct system is an in-slab wire management product for delivering power, voice and data services for applications that include retail facilities, open office workstations, fitness centers, casinos, medical facilities and libraries.

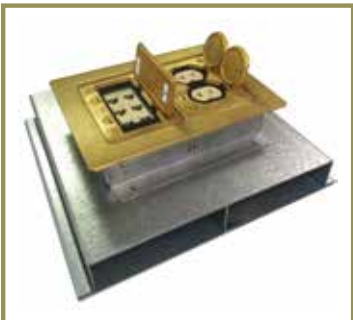

### Underfloor Duct Raceway Activation Kits

- Available in brass and brushed aluminum to meet aesthetic requirements
- Available in one, two and three-gang options
- ScrubShield® Complies with UL514A scrub water requirements
- Flanged design may be used in tile, wood, carpet, terrazzo and bare concrete applications
- Uniform look when used in same areas where Hubbell floor boxes are installed

# Trench and Wall Duct Products

## Features and Benefits

### A high capacity trench system for in-floor wire management.

The Hubbell Trench system is an in-floor wire management system that meets today's high capacity wiring needs that require multiple circuit separation. Trench duct is commonly used as a feeder system for medical wall duct when installing radiology equipment such as X-Ray and MRI machines. Trench duct is also used as a stand alone system for commercial and retail applications where ease of access and high capacity are crucial variables.



### Multiple compartments provide more capacity than conventional ducts.

The Hubbell Trench system provides more capacity than conventional conduits and ducts. It features a single, high-capacity duct with multi-compartments for easy placement of additional wiring.

It's open top design allows wiring to be laid in the duct instead of being pulled, eliminating the need for junction boxes.

Removable covers are 1/4" thick and lock into the track of the trench. Internal dividers and/or support strips increase load capacity of heavy-duty cover. These removable covers allow free access to wiring and can be placed anywhere along the duct for easy wire exit relocation.

- High capacity design supports large wiring for single and multiple service requirements
- Open top design allows wire to be easily laid in duct
- Cover plates are removable and adjust horizontally to any point along the duct. Custom lengths of trench and fittings are available. Provided in either galvanized G90 steel or nonferrous aluminum.
- Multiple compartment options allows for multiple circuit and low voltage separation
- Innovative duct support assembly allows for pre-pour leveling
- Packaging and labeling by project floor and room is available

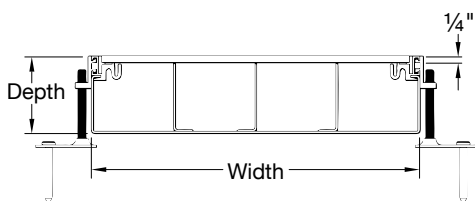

### Trench Duct Range of Offering

Trench Product	Depth 1/2" Increments	Width	Compartments	Cover Plate
OKA = Trench	A = 2"	9	1C = 1 Compartment	1/4 = 1/4" thick
OKB = Pull Box	B = 2 1/2"	12	2C = 2 Compartment	
OKC = Exit Cover	C = 3"	18	3C = 3 Compartment	
OKE = End Cap	D = 3 1/2"	24	4C = 4 Compartment	
OKL = Horizontal L	E = 4"	(Other Widths Avail.)		
OKR = Vertical Riser	J = 6"			
OKT = T Junction Box	N = 8"			
OKX = X Junction Box	(Other Depths Available)			

Note: For Aluminum Trench Duct or Fittings, add "AL" suffix to catalog number.

# Trench and Wall Duct Products

## Hubbell Trench Duct Series and Fittings

### Ordering Information Notes:

1. Common use sizes are listed below. Contact factory for other configurations or see page U-3 for Range of Offering table.
2. Trench Duct part numbers are for reference only. All Trench Duct orders are lot billed with a generic TW prefix project specific part numbers. Please contact your local Hubbell Territory Manager for all Hubbell Duct quotations.

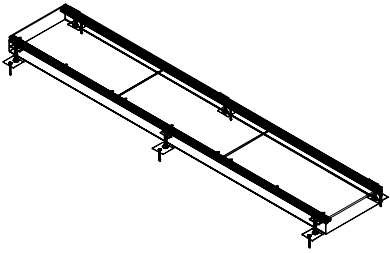
Trench Duct	Description	Trench Depth	Cover Width	No. of Compartments	Catalog Number	
	<b>Straight Section</b>	2½"	9"	1	<b>OKA/B9-1C-1/4</b>	
	Manufactured in standard 6' lengths with factory installed dividers.	3"	9"	2	<b>OKA/C9-2C-1/4</b>	
	Provided with (3) leveling feet/couplers on each side, (3) 24" long cover plates and (3) cover plate joint protectors.	2½"	12"	2	<b>OKA/B12-2C-1/4</b>	
		3"	12"	3	<b>OKA/C12-3C-1/4</b>	
		2½"	18"	3	<b>OKA/B18-3C-1/4</b>	
		3"	18"	4	<b>OKA/C18-4C-1/4</b>	
		2½"	24"	3	<b>OKA/B24-3C-1/4</b>	
	3"	24"	4	<b>OKA/C24-4C-1/4</b>		

Note: For Aluminum Trench Duct or Fittings, add "AL" suffix to catalog number.

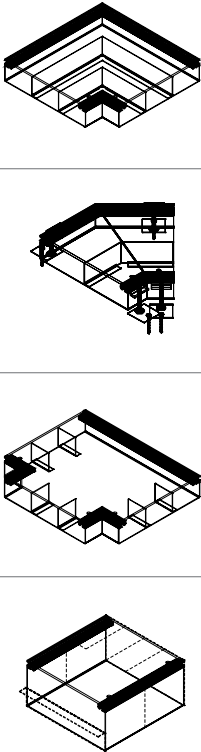
Fittings	Description	Outside Cover	No. of Compartments	Catalog Number	
	<b>Horizontal "L" Fitting</b>	12" x 12"	1	<b>OKL/B9-1C</b>	
	Manufactured with a single cover and matching internal partitions to form a 90° horizontal "L".	12" x 12"	2	<b>OKL/C9-2C</b>	
	Includes cover plate joint protectors and leveling feet.	15" x 15"	2	<b>OKL/B12-2C</b>	
		15" x 15"	3	<b>OKL/C12-3C</b>	
		21" x 21"	3	<b>OKL/B18-3C</b>	
		21" x 21"	4	<b>OKL/C18-4C</b>	
		27" x 27"	3	<b>OKL/B24-3C</b>	
		27" x 27"	4	<b>OKL/C24-4C</b>	
	<b>Horizontal 45° Elbow Fitting</b>	45°	1	<b>OKL/B9-1Cx45</b>	
	Manufactured with a split cover plate and matching internal partitions to form a 45° Mitered "L".	45°	2	<b>OKL/C9-2Cx45</b>	
	Other angles available. Includes cover plate joint protectors and leveling feet.	45°	2	<b>OKL/B12-2Cx45</b>	
		45°	3	<b>OKL/C12-3Cx45</b>	
		45°	3	<b>OKL/B18-3Cx45</b>	
		45°	4	<b>OKL/C18-4Cx45</b>	
		45°	3	<b>OKL/B24-3Cx45</b>	
		45°	4	<b>OKL/C24-4Cx45</b>	
	<b>Single Level "T" Junction Fitting</b>	15" x 12"	1	<b>OKT/B9-1C</b>	
Manufactured with matching internal partitions and crossovers to isolate power and communications.	15" x 12"	2	<b>OKT/C9-2C</b>		
Includes cover plate joint protectors and leveling feet.	18" x 15"	2	<b>OKT/B12-2C</b>		
	18" x 15"	3	<b>OKT/C12-3C</b>		
	24" x 21"	3	<b>OKT/B18-3C</b>		
	24" x 21"	4	<b>OKT/C18-4C</b>		
	30" x 27"	3	<b>OKT/B24-3C</b>		
	30" x 27"	4	<b>OKT/C24-4C</b>		
<b>Pull Box</b>	9" x 12"	1	<b>OKB/B9-1C</b>		
Manufactured to attach to trench section replacing end cap. Divided into compartments as shown.	9" x 12"	2	<b>OKB/C9-2C</b>		
Additional depth permits attachment of large conduits. Box is field punched for conduits. Standard depth is 6".	12" x 12"	2	<b>OKB/B12-2C</b>		
	12" x 12"	3	<b>OKB/C12-3C</b>		
	18" x 12"	3	<b>OKB/B18-3C</b>		
	18" x 12"	4	<b>OKB/C18-4C</b>		
	24" x 12"	3	<b>OKB/B24-3C</b>		
	24" x 12"	4	<b>OKB/C24-4C</b>		

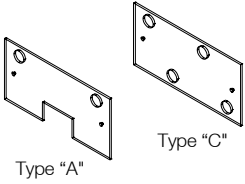

Exit Cover Fittings	Description	Trench Width	Max Size Conduit	Catalog Number	
	<b>Exit Cover</b>	9"	¾"	<b>OKC/9-3/4A</b>	
	Designed to provide exit and feed for Trench Duct. Conduit openings are provided for power and communication exit or feed using conventional fittings or service fittings. Cable Exit Cap (OKSK) is for communication cable only. Exit fittings cover may be spaced anywhere along the length of the trench. All exit fitting covers are 6" long.	12"	¾"	<b>OKC/12-3/4A</b>	
		18"	¾"	<b>OKC/18-3/4A</b>	
		24"	¾"	<b>OKC/24-3/4A</b>	
		9"	¾"	<b>OKC/9-3/4C</b>	
		12"	¾"	<b>OKC/12-3/4C</b>	
		18"	¾"	<b>OKC/18-3/4C</b>	
		24"	¾"	<b>OKC/24-3/4C</b>	
	<b>Cable Exit Cap</b>	All	—	<b>OKSK</b>	
Fits opening in Type "A" Exit Cover. Provides outlet for communication cable. Debris barrier included. Cable Exit Cap constructed from die cast aluminum. For use with Type "A" exit covers only.					

# Trench and Wall Duct Products

## Hubbell Trench Duct Fittings

### Ordering Information Notes:

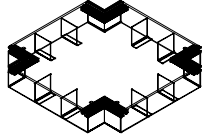
1. Common use sizes are listed below. Contact factory for other configurations or see page U-3 for Range of Offering table.
2. Trench Duct part numbers are for reference only. All Trench Duct orders are lot billed with a generic TW prefix project specific part numbers. Please contact your local Hubbell Territory Manager for all Hubbell Duct quotations.

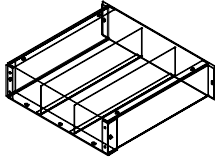
Fittings	Description	Outside Cover	No. of Compartments	Catalog Number	
	<b>Single Level "X" Junction Fitting</b>	Manufactured with matching internal partitions and crossovers to isolate power and communications. Includes cover plate joint protectors and leveling feet.	15" x 15" 15" x 15" 18" x 18" 18" x 18" 24" x 24" 24" x 24" 30" x 30" 30" x 30"	1 2 2 3 3 4 3 4	
Fittings	Description	Fits Trench Dim. (Width x Depth)	Max Trade Size Conduit	Catalog Number	
	<b>End Cap</b>	Fits over end of trench run to close trench and prevent foreign material from entering. End cap may be drilled to accept conduit.	9" x 2½" 9" x 3" 12" x 2½" 12" x 3" 18" x 2½" 18" x 3" 24" x 2½" 24" x 3"	¾" 1" ¾" 1" ¾" 1" ¾" 1"	
Fittings	Description	Fits Trench Width	No. of Compartments	Catalog Number	
	<b>Vertical Riser Fitting (Straight)</b>	Manufactured to transition from trench duct to a panel, pull box or to conduit. Mounts on trench in place of cover. Partitioned to separate cells and flanged to attach to a pull box or panel. Removable front cover and top cover. Includes OWW trench-to-wall duct adapter. Standard height above finish floor — 12". Standard depth — 3½". Available in a sweep version (replace OKR with OKSWR)	9" 9" 12" 12" 18" 18" 24" 24"	1 2 2 3 3 4 3 4	

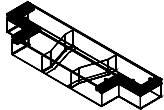
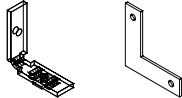
Additional Fittings	Description	Trench Width #1	Trench Width #2	Catalog Number	
	<b>Reducer Fitting</b>	Manufactured to transition from a wide trench duct width to a narrower trench duct width.	9" 12" 18" 24"	6" 9" 12" 18"	
Additional Fittings	Description	Horizontal Angle	Vertical Angle	Catalog Number	
	<b>Fastening Angles</b>	Accessories to join trench sections for field fabrication of horizontal and vertical assemblies.	—	—	

Trench Duct Accessories	Description	Accessory Type	Catalog Number
	Permits 1" of pre-pour vertical adjustment and couples sections together. "x" represents screw height (max. 6") and height of trench. Additional vertical adjustment is available by increasing the length of screw "x".	Single Leveling Foot Assembly	<b>OK/F-x</b>
	Provides a 1½" wide surface (with gasket) for cover plate joints. "x" represents trench width.	Single Cover Plate Joint Protector	<b>OK/DSD-x</b>
	Separates trench duct compartments. "x" represents trench depth (see catalog number system).	Divider	<b>OKP/x</b>
Provided with 5/16" x 18 bolts on 6" or 12" centers for increased cover plate weight loading capability.	Support Stud Strip	<b>Consult Factory</b>	

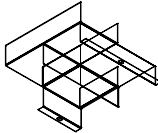
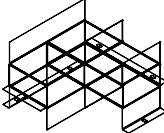
Tunnel Fittings	Description	No. of Compartments	"T" Unit Fitting Type	"X" Unit Fitting Type
	<b>Tunnels</b>	Factory installed inside of multi-compartment "T" and "X" units to maintain separation of services. May be ordered separately and field installed.	2, 3, or 4	<b>Consult Factory</b>
				

# Trench and Wall Duct Products

## Features and Benefits

The Hubbell Wall Duct is a UL Listed metal raceway system designed for the enclosure of wiring of MRI or X-Ray equipment in medical applications. The system provides complete lay-in wiring capability in order to accommodate the large cables and connectors used in today's installations.

Hubbell Wall Duct is available in either flush or surface mount and a combination will usually be required on any job. Vertical runs in the walls are usually flush mounted with horizontal runs on walls and all duct in ceiling plenum are typically surface type.

Wall Duct is available in ferrous steel and non-ferrous aluminum versions.



- Lay in wiring accommodates large cables and connectors to connect equipment
- Corrosion resistant galvanized A60 steel or non ferrous aluminum versions
- Flush (primarily wall) and Surface (primarily ceiling) mount provides flexibility to address specific equipment placement and unique room design requirements
- Hubbell Wall Duct is utilized with Hubbell Trench Duct
- Packaging and labeling by project floor and room is available



## Wall Duct Range of Offering

Wall Duct Product		Depth ½" Increments	Width	Cover Style
<b>OWA</b> = Wall Duct	<b>OWI</b> = Internal Elbow	<b>A</b> = 2"	<b>6</b>	<b>S</b> = Surface
<b>OWB</b> = Adapter	<b>OWL</b> = External Elbow	<b>B</b> = 2½"	<b>10</b>	<b>F</b> = Flush
<b>OWC</b> = Coupling	<b>OWP</b> = Partition	<b>C</b> = 3"	<b>12</b>	
<b>OWD</b> = Reducer Coupling	<b>OWR</b> = Vertical Riser	<b>D</b> = 3½"	<b>18</b>	
<b>OWE</b> = End Closure	<b>OWT</b> = T Unit	<b>E</b> = 4"	(Other	
<b>OWF</b> = Cabinet Connector	<b>OWV</b> = Trench to Wall Duct Adapter	<b>J</b> = 6"	Widths	
<b>OWH</b> = Horizontal Elbow	<b>OWX</b> = X Unit	<b>N</b> = 8"	Available)	
		(Other Depths Available)		

Note: For Aluminum Wall Duct or Fittings, add "AL" suffix to catalog number.

# Trench and Wall Duct Products

## Hubbell Wall Duct Series and Fittings

### Ordering Information Notes:

1. Common use sizes are listed below. Contact factory for other configurations or see page U-6 for Range of Offering table.
2. Wall Duct part numbers are for reference only. All Wall Duct orders are lot billed with a generic TW prefix project specific part numbers. Please contact your local Hubbell Territory Manager for all Hubbell Duct quotations.

Wall Duct	Description	Overall Depth	Body Width	Cover Width	Flush Catalog Number	Cover Width	Surface Catalog Number
	<b>Wall and Ceiling Duct</b>	3½"	9 <sup>13</sup> / <sub>16</sub> "	12"	<b>OWA/D10F</b>	10"	<b>OWA/D10S</b>
	Manufactured in standard 60" lengths with two 30" long cover plates.	3½"	11 <sup>13</sup> / <sub>16</sub> "	14"	<b>OWA/D12F</b>	12"	<b>OWA/D12S</b>
	Provided with one coupling and necessary screws.	3½"	17 <sup>13</sup> / <sub>16</sub> "	20"	<b>OWA/D18F</b>	18"	<b>OWA/D18S</b>

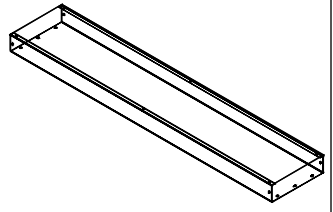

Note: For Aluminum Wall Duct or Fittings, add "AL" suffix to catalog number.

Elbow Fittings	Description	Overall Depth	Body Width	Cover Width	Flush Catalog Number	Cover Width	Surface Catalog Number
	<b>Internal Elbow</b>	3½"	9 <sup>13</sup> / <sub>16</sub> "	12"	<b>OWI/D10F</b>	10"	<b>OWI/D10S</b>
	Forms a sharp 90° Internal "L".	3½"	11 <sup>13</sup> / <sub>16</sub> "	14"	<b>OWI/D12F</b>	12"	<b>OWI/D12S</b>
	Provided with one cover plate, one coupling and necessary screws.	3½"	17 <sup>13</sup> / <sub>16</sub> "	20"	<b>OWI/D18F</b>	18"	<b>OWI/D18S</b>
	<b>Internal Elbow, Sweep</b>	3½"	9 <sup>13</sup> / <sub>16</sub> "	12"	<b>OWSWI/D10F</b>	10"	<b>OWSWI/D10S</b>
	Forms a chamfered 90° Internal "L" for increased cable bend radius.	3½"	11 <sup>13</sup> / <sub>16</sub> "	14"	<b>OWSWI/D12F</b>	12"	<b>OWSWI/D12S</b>
	Provided with one cover plate, one coupling and necessary screws.	3½"	17 <sup>13</sup> / <sub>16</sub> "	20"	<b>OWSWI/D18F</b>	18"	<b>OWSWI/D18S</b>
	<b>Internal 45° Elbow</b>	3½"	9 <sup>13</sup> / <sub>16</sub> "	12"	<b>OWI45/D10F</b>	10"	<b>OWI45/D10S</b>
Forms a 45° Vertical "L".	3½"	11 <sup>13</sup> / <sub>16</sub> "	14"	<b>OWI45/D12F</b>	12"	<b>OWI45/D12S</b>	
Provided with one cover plate, one coupling and necessary screws.	3½"	17 <sup>13</sup> / <sub>16</sub> "	20"	<b>OWI45/D18F</b>	18"	<b>OWI45/D18S</b>	
<b>Horizontal Elbow</b>	3½"	9 <sup>13</sup> / <sub>16</sub> "	12"	<b>OWH/D10F</b>	10"	<b>OWH/D10S</b>	
Forms a 90° Horizontal "L".	3½"	11 <sup>13</sup> / <sub>16</sub> "	14"	<b>OWH/D12F</b>	12"	<b>OWH/D12S</b>	
Provided with one cover plate, one coupling and necessary screws. Corner divider "OWCP" ordered separately.	3½"	17 <sup>13</sup> / <sub>16</sub> "	20"	<b>OWH/D18F</b>	18"	<b>OWH/D18S</b>	
<b>Horizontal 45° Elbow</b>	3½"	9 <sup>13</sup> / <sub>16</sub> "	12"	<b>OWH45/D10F</b>	10"	<b>OWH45/D10S</b>	
Forms a 45° Horizontal "L".	3½"	11 <sup>13</sup> / <sub>16</sub> "	14"	<b>OWH45/D12F</b>	12"	<b>OWH45/D12S</b>	
Provided with one cover plate, one coupling and necessary screws.	3½"	17 <sup>13</sup> / <sub>16</sub> "	20"	<b>OWH45/D18F</b>	18"	<b>OWH45/D18S</b>	
<b>External Elbow</b>	3½"	9 <sup>13</sup> / <sub>16</sub> "	12"	<b>OWL/D10F</b>	10"	<b>OWL/D10S</b>	
Forms a sharp 90° External "L".	3½"	11 <sup>13</sup> / <sub>16</sub> "	14"	<b>OWL/D12F</b>	12"	<b>OWL/D12S</b>	
Provided with two cover plates, one coupling and necessary screws.	3½"	17 <sup>13</sup> / <sub>16</sub> "	20"	<b>OWL/D18F</b>	18"	<b>OWL/D18S</b>	

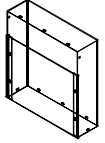
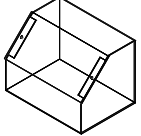
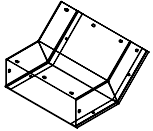
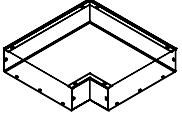
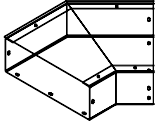
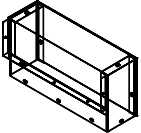
Note: Images shown are surface mount.

# Trench and Wall Duct Products

## Hubbell Wall Duct Fittings

### Ordering Information Notes:

1. Common use sizes are listed below. Contact factory for other configurations or see page U-6 for Range of Offering table.
2. Wall Duct part numbers are for reference only. All Wall Duct orders are lot billed with a generic TW prefix project specific part numbers. Please contact your local Hubbell Territory Manager for all Hubbell Duct quotations.

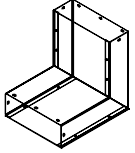
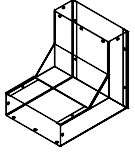
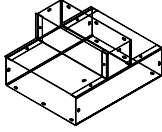
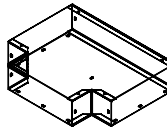
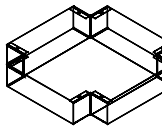
	Description	Overall Depth	Body Width	Cover Width	Flush Catalog Number	Cover Width	Surface Catalog Number		
Internal / External Elbows	<b>Internal / External Elbow</b>	3½"	9 <sup>13</sup> / <sub>16</sub> "	12"	—	10"	<b>SPOWI/D10S</b>		
	Transitions from surface wall duct to surface style ceiling duct. Flush wall duct to surface style ceiling duct available upon request. Provided with two cover plates, one coupling and necessary screws.	3½"	11 <sup>13</sup> / <sub>16</sub> "	14"	—	12"	<b>SPOWI/D12S</b>		
		3½"	17 <sup>13</sup> / <sub>16</sub> "	20"	—	18"	<b>SPOWI/D18S</b>		
	Internal / External Elbow, Sweep	<b>Internal / External Elbow, Sweep</b>	3½"	9 <sup>13</sup> / <sub>16</sub> "	12"	—	10"	<b>SPOWSWI/D10S</b>	
		Transitions from surface wall duct to surface style ceiling duct. Flush wall duct to surface style ceiling duct available upon request. Provided with two cover plates, one coupling and necessary screws.	3½"	11 <sup>13</sup> / <sub>16</sub> "	14"	—	12"	<b>SPOWSWI/D12S</b>	
			3½"	17 <sup>13</sup> / <sub>16</sub> "	20"	—	18"	<b>SPOWSWI/D18S</b>	
"T" Units	<b>Vertical "T" Unit</b>	3½"	9 <sup>13</sup> / <sub>16</sub> "	12"	<b>OWVT/D10F</b>	10"	<b>OWVT/D10S</b>		
	Forms a 90° Vertical "T". Provided with three cover plates, two couplings and necessary screws.	3½"	11 <sup>13</sup> / <sub>16</sub> "	14"	<b>OWVT/D12F</b>	12"	<b>OWVT/D12S</b>		
		3½"	17 <sup>13</sup> / <sub>16</sub> "	20"	<b>OWVT/D18F</b>	18"	<b>OWVT/D18S</b>		
"T" Units	<b>Horizontal "T" Unit</b>	3½"	9 <sup>13</sup> / <sub>16</sub> "	12"	<b>OWT/D10F</b>	10"	<b>OWT/D10S</b>		
	Forms a 90° Horizontal "T". Provided with one cover plate, one coupling and necessary screws. Tunnels are ordered separately.	3½"	11 <sup>13</sup> / <sub>16</sub> "	14"	<b>OWT/D12F</b>	12"	<b>OWT/D12S</b>		
		3½"	17 <sup>13</sup> / <sub>16</sub> "	20"	<b>OWT/D18F</b>	18"	<b>OWT/D18S</b>		
"X" Unit	<b>"X" Unit</b>	3½"	9 <sup>13</sup> / <sub>16</sub> "	12"	<b>OWX/D10F</b>	10"	<b>OWX/D10S</b>		
	Forms intersection of four perpendicular ducts. Provided with one cover plate, two coupling and necessary screws. Tunnels are ordered separately.	3½"	11 <sup>13</sup> / <sub>16</sub> "	14"	<b>OWX/D12F</b>	12"	<b>OWX/D12S</b>		
		3½"	17 <sup>13</sup> / <sub>16</sub> "	20"	<b>OWX/D18F</b>	18"	<b>OWX/D18S</b>		

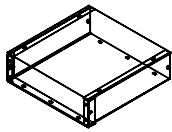
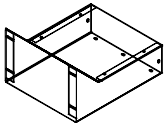
	Description	For Trench Width	For Wall Duct (Width x Depth)	Flush Catalog Number	Surface Catalog Number		
Vertical Riser Fittings	<b>Vertical Riser Fitting, Straight</b>	10"	10" x 3½"	<b>OWR/D10F</b>	<b>OWR/D10S</b>		
	Transitions from trench duct to a vertical run of wall duct. Mounts on trench in place of cover. Removable front cover. Standard height above finish floor — 12" (7" for OWR/D12x10). Standard depth — 3½". Provided with one coupling and necessary screws.	12"	12" x 3½"	<b>OWR/D12F</b>	<b>OWR/D12S</b>		
		18"	18" x 3½"	<b>OWR/D18F</b>	<b>OWR/D18S</b>		
		12"	10" x 3½"	<b>OWR/D12-10F</b>	<b>OWR/D12-10S</b>		
	Vertical Riser Fitting, Sweep	<b>Vertical Riser Fitting, Sweep</b>	10"	10" x 3½"	<b>OOWSWR/D10F</b>	<b>OOWSWR/D10S</b>	
		Transitions from trench duct to a vertical run of wall duct. Mounts on trench in place of cover. Removable front cover. Standard height above finish floor — 12". Standard depth — 3½". Provided with one coupling and necessary screws.	12"	12" x 3½"	<b>OOWSWR/D12F</b>	<b>OOWSWR/D12S</b>	
		18"	18" x 3½"	<b>OOWSWR/D18F</b>	<b>OOWSWR/D18S</b>		
		12"	10" x 3½"	<b>OOWSWR/D12-10F</b>	<b>OOWSWR/D12-10S</b>		

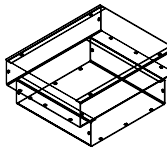
	Description	Overall Depth	Flush Wall Duct Body Width	Surface Cover Width	Catalog Number	
Adapter Fitting	<b>Flush to Surface Adapter</b>	3½"	9 <sup>13</sup> / <sub>16</sub> "	10"	<b>OWB/D10-10</b>	
	Transitions from flush wall duct to perpendicular surface wall duct. Provided with one cover plate, two couplings and necessary screws.	3½"	11 <sup>13</sup> / <sub>16</sub> "	18"	<b>OWB/D12-18</b>	
		3½"	17 <sup>13</sup> / <sub>16</sub> "	12"	<b>OWB/D18-12</b>	
		3½"	17 <sup>13</sup> / <sub>16</sub> "	18"	<b>OWB/D18-18</b>	



# Trench and Wall Duct Products

## Hubbell Wall Duct Fittings

### Ordering Information Notes:

1. Common use sizes are listed below. Contact factory for other configurations or see page U-6 for Range of Offering table.
2. Wall Duct part numbers are for reference only. All Wall Duct orders are lot billed with a generic TW prefix project specific part numbers. Please contact your local Hubbell Territory Manager for all Hubbell Duct quotations.

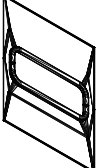
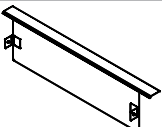
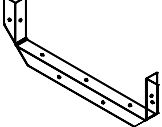
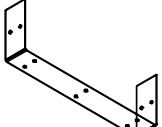
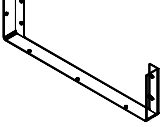
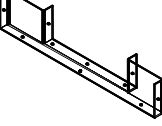
Additional Fittings	Description	Overall Depth	Cover Width	Flush Catalog Number	Cover Width	Surface Catalog Number	
	<b>Split Cover Plate</b> Provides wire egress from raceway. Provided with assembly screws and grommet material.	—	12"	<b>OWSC/10F</b>	10"	<b>OWSC/10S</b>	
		—	14"	<b>OWSC/12F</b>	12"	<b>OWSC/12S</b>	
		—	20"	<b>OWSC/18F</b>	18"	<b>OWSC/18S</b>	
	<b>End Cap</b> Closes off end of wall duct. Screws provided.	3½"	12"	<b>OWE/D10F</b>	10"	<b>OWE/D10S</b>	
		3½"	14"	<b>OWE/D12F</b>	12"	<b>OWE/D12S</b>	
		3½"	20"	<b>OWE/D18F</b>	18"	<b>OWE/D18S</b>	
<b>Cabinet Connector</b> Connects wall duct to enclosures. Designed to be positioned around outside surface of duct and secured with screws from inside of duct. Screws provided.	3½"	12"	<b>OWF/D10</b>	10"	<b>OWF/D10</b>		
	3½"	14"	<b>OWF/D12</b>	12"	<b>OWF/D12</b>		
	3½"	20"	<b>OWF/D18</b>	18"	<b>OWF/D18</b>		
<b>Coupling</b> Joins surface or flush wall duct sections together. Designed to be positioned around outside surface of duct and secured with screws from inside of duct. Screws provided.	3½"	12"	<b>OWC/D10</b>	10"	<b>OWC/D10</b>		
	3½"	14"	<b>OWC/D12</b>	12"	<b>OWC/D12</b>		
	3½"	20"	<b>OWC/D18</b>	18"	<b>OWC/D18</b>		
<b>Trench to Wall Duct Adapter</b> Transitions from trench duct to a vertical run of wall duct when not using the OWR series Vertical Riser. Mounts on trench in place of cover. Provided with necessary screws.	3½"	12"	<b>OWV/D10</b>	10"	<b>OWV/D10</b>		
	3½"	14"	<b>OWV/D12</b>	12"	<b>OWV/D12</b>		
	3½"	20"	<b>OWV/D18</b>	18"	<b>OWV/D18</b>		
<b>Reducer Coupling</b> Joins two sizes of surface or flush wall duct sections together. Designed to be positioned around outside surface of duct and secured with screws from inside of duct. Screws provided.	3½"	20" to 12"	<b>OWD/D (18-10)</b>	18" to 10"	<b>OWD/D (18-10)</b>		
	3½"	20" to 14"	<b>OWD/D (18-12)</b>	18" to 12"	<b>OWD/D (18-12)</b>		

Note: Grommet material is available to cover field cut openings in Wall Duct. Outside dimensions of grommet is ¼" x 5/16" and is made from SBR rubber. Catalog number GROM-xx ("xx" represents length in feet).

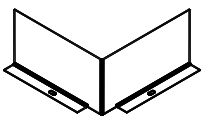
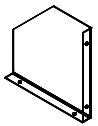
Partitions Fittings	Description	For Overall Raceway Depth	For Fitting Style		
			Straight (Length 60")	Horizontal "L"	Internal Sweep Elbow
<b>Internal Duct Partitions</b> Divides raceway and fittings into compartments. Screws provided.		3½"	<b>OWP/D</b>	<b>OWCP/D</b>	<b>OWSWP/D</b>
					

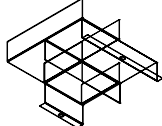
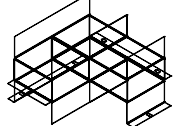
Tunnel Fittings	Description	No. of Compartments	"T" Unit Fitting Type		"X" Unit Fitting Type	
			Consult Factory		Consult Factory	
<b>Tunnels</b> Field installed inside of multi-compartment "T" and "X" units to maintain separation of services. May be factory installed.		2, 3, or 4	<b>Consult Factory</b>		<b>Consult Factory</b>	
						

# Underfloor Duct Products

## Features and Benefits

Open Offices



Casinos



Retail



Fitness



Retrofit



## Multi-Compartment Underfloor Duct Saves Time and Money in Your In-Slab Wire Management System

The Hubbell Underfloor Duct system is an in-slab wire management product for delivering power, voice and data services for applications that include retail facilities, open office workstations, fitness centers, casinos, medical facilities and libraries. This system is uniquely designed with multiple compartments, allowing unlimited design options and cost savings in labor and materials from other single-compartment systems. Matched with our strong national distribution and complete technical/application support, the Hubbell Underfloor Duct System is the perfect solution for your underfloor wire management needs.

### Key Features and Benefits

- Eight duct profiles available to accommodate numerous in-slab wire management for power and communications.
- One-piece design multi-compartment duct, drastically reducing installation and material costs.
- Standard insert heights ranging from 1 to 3 inches (other heights available).
- Inclusive tile trim in square-top junction boxes, providing the installer the on-site option of using the trim or leaving it recessed.
- Combination duct coupler/support, reducing material and labor costs using the same part to join raceway sections together and to support/level the duct.
- Activation inserts are pre-assembled to the duct, or the inserts can be purchased separately for field installation only where you need them.
- Heavy duty junction boxes are available for areas requiring high-concentrated floor loads.
- Meets or exceeds UL 884 specifications, assuring a fully UL Listed system from one manufacturer.

### Flush Insert Duct Benefits

- Provides an aesthetic wire management solution for delivering power and communications services.
- Unique multi-gang flush inserts with removable voltage dividers provide the flexibility of installing multiple gangs of the same service at each insert location.
- Individual gangs can be activated as needed - keeps costs down.
- Activation trims accept standard Hubbell floor box covers for power and data, available in aluminum and brass.

### Ordering Information Note:

Floor Duct part numbers are for reference only. All Floor Duct orders are lot billed with a generic FD prefix project specific part numbers. Please contact your local Hubbell Territory Manager for all Hubbell Duct quotations.

## Conventional, Flush and Blank Underfloor Duct Profiles

### Ordering Information Note:

Floor Duct part numbers are for reference only. All Floor Duct orders are lot billed with a generic FD prefix project specific part numbers. Please contact your local Hubbell Territory Manager for all Hubbell Duct quotations.

- All duct comes in standard 10 ft. lengths
- 14 gauge, G90 galvanized steel
- 2 Inch IPS (Iron Pipe Size) round inserts are die-cast zinc
- Rectangular inserts are 14 gauge, G90 galvanized steel

### Catalog Number System

	SP202F	-	2	-	12	
	Profile		Insert Height		Insert Spacing	
Round Insert Duct and Blank Duct	201		B = Blank		12 = 12"	
	201W		1 = 1" (201 only)		24 = 24"	
	202		15 = 1 1/2"		(consult factory for special preset spacing)	
	202W		2 = 2"			
	203		25 = 1 1/2"			
	204		3 = 3**		n/a for Blank Duct	
Flush Insert Duct	201F		1 = 1" (201F only)		12 = 12"	
	201WF		15 = 1 1/2***		24 = 24"	
	202F		2 = 2"		(consult factory for special preset spacing)	
	202WF		25 = 2 1/2"			
	203F		3 = 3**			

Note: \*Consult factory for heights greater than 3".  
\*\* 1 1/2" min. required for duplex receptacles.

### Dimensions

#### 201 & 201F

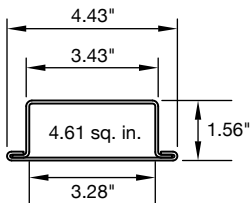

#### 201W & 201WF

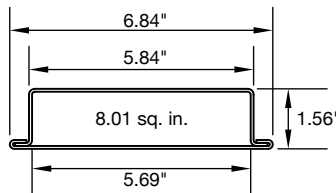

#### 202 & 202F

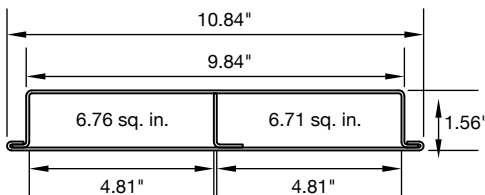

#### 203

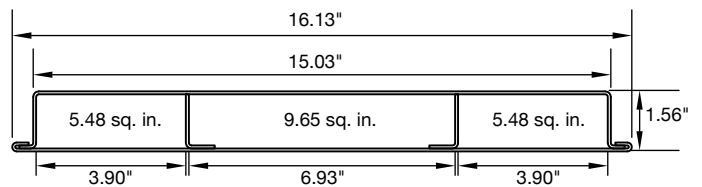

#### SP202 & SP202F

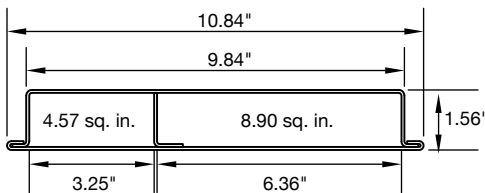

#### 203F



#### 202W & 202WF

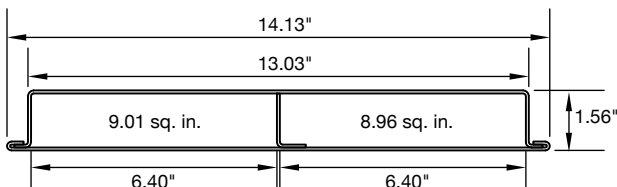

#### 204

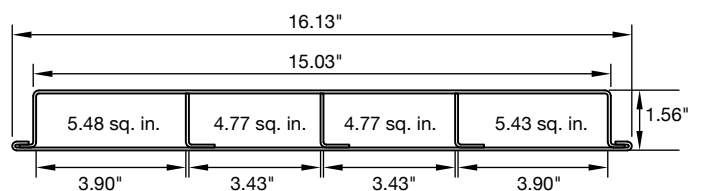

## Technical Information and Wire Fill Capacity Chart

### Ordering Information Note:

Floor Duct part numbers are for reference only. All Floor Duct orders are lot billed with a generic FD prefix project specific part numbers. Please contact your local Hubbell Territory Manager for all Hubbell Duct quotations.

Cable Type	Size	Approx. Dia. (in.)	Approx. Area (sq in.)	201		202		SP202		202W		203			203F			204				
				201F	201WF	202F		SP202F		202WF												
				Channel	A	A	A	B	A	B	A	B	A	B	C	A	B	C	A	B	C	D
Power (THHN)	14 AWG	0.111	0.0097	190	331	279	277	188	367	372	370	226	398	226	341	170	341	226	197	197	224	
	12 AWG	0.130	0.0133	138	241	203	202	137	268	271	270	165	290	165	248	124	248	165	143	143	163	
	10 AWG	0.164	0.0211	87	151	128	127	86	168	170	169	103	182	103	156	78	156	103	90	90	102	
	8 AWG	0.216	0.0366	50	87	73	73	49	97	98	97	59	105	59	90	44	90	59	52	52	59	
Coax Cables	RG-6/U	0.270	0.0573	32	55	47	46	31	62	62	62	38	67	38	57	28	57	38	33	33	37	
	RG-6/UQ	0.298	0.0697	26	45	38	38	26	51	51	51	31	55	31	47	23	47	31	27	27	31	
LAN Cables	Cat 5e	0.210	0.0346	53	92	78	77	52	102	104	103	63	111	63	95	47	95	63	55	55	62	
	Cat 6	0.250	0.0491	37	65	55	54	37	72	73	73	44	78	44	67	33	67	44	38	38	44	
	Cat 6A	0.350	0.0962	19	33	28	27	18	37	37	37	22	40	22	34	17	34	22	19	19	22	
Fiber Optic Distribution Cables	2-6 Strand	0.190	0.0284	65	113	95	94	64	125	127	126	77	136	77	116	58	116	77	67	67	76	
	8-12 Strand	0.230	0.0415	44	77	65	64	43	85	86	86	52	92	52	79	39	79	52	45	45	52	
	16-24 Strand	0.350	0.0962	19	33	28	27	18	37	37	37	22	40	22	34	17	34	22	19	19	22	

Note: Cable quantities shown in this chart are based on a 40% wire fill capacity. Sizes of COAX, LAN and Fiber Optic cables are provided for example only. Consult cable manufacturer's specification for exact cable sizes.

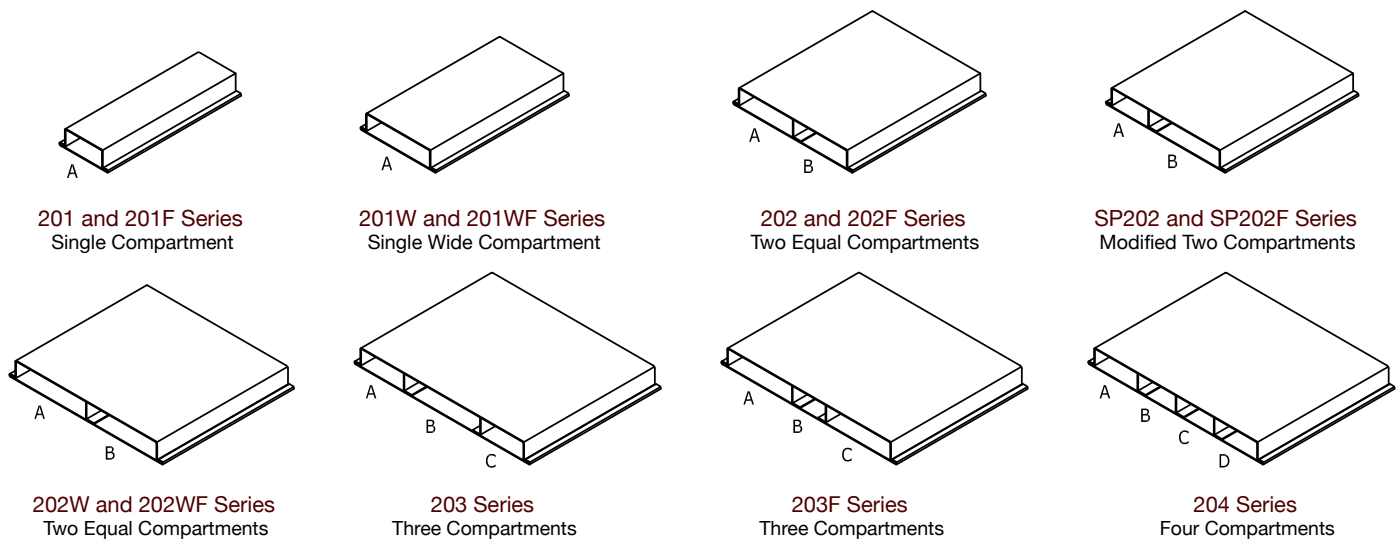

### Applicable Codes & Standards

- TIA/EIA 569-C "Commercial Building Standard for Telecommunications Pathways and Spaces"
- NEC Article 390 "Underfloor Raceways"
- Ampacity derating rules of NEC Article 310.15 (B)(3) applies to conductors installed in Underfloor Raceways and Trench Duct
- UL Standard UL 884 "Underfloor Raceways and Fittings"
- UL Listed E75939 (Underfloor Raceway) & E304554 (Underfloor raceway Fittings)

## Underfloor Duct Raceway Fittings

### Ordering Information Note:

Floor Duct part numbers are for reference only. All Floor Duct orders are lot billed with a generic FD prefix project specific part numbers. Please contact your local Hubbell Territory Manager for all Hubbell Duct quotations.

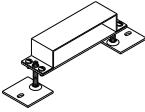
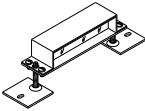
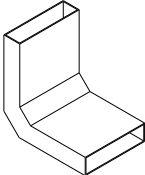
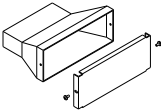
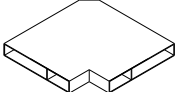
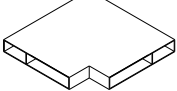
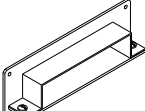
			Flush Insert Duct						Conventional Duct										
			201F	201WF	202F	SP202F	202WF	203F	201	201W	202	SP202	202W	203	204				
Coupler Support		Couples duct sections together and supports the duct. To be used every 5 feet of duct run.	201-DCS	●															
			201W-DCS		●														
			202-DCS			●	●												
			202W-DCS					●						●					
			203-DCS							●					●	●			
End Cap Support		Supports and closes unused duct ends.	201-ECS	●															
			201W-ECS		●														
			202-ECS			●	●												
			202W-ECS					●						●					
			203-ECS							●					●	●			
Vertical Riser		Transitions from duct embedded in concrete floor to vertical duct or may be used for direct connection to a Universal Conduit Adapter (UCA). Coupler / Supports (DCS) are required to attach to duct and UCA.	201-VEL	●															
			201W-VEL		●														
			202-VEL			●													
			SP202-VEL				●							●					
			202W-VEL					●							●				
			203-VEL													●			
			203F-VEL								●								
204-VEL															●				
Universal Conduit Adapter		Transitions from duct to conduit. A blank 14 gauge steel plate is provided for field punched conduit openings. For use with up to 2 1/2" trade size conduits. Consult factory for larger conduit accommodations. (may also be inserted directly into Junction Boxes)	201-UCA	●															
			201W-UCA		●														
			202-UCA			●													
			SP202-UCA				●							●					
			202W-UCA					●							●				
			203-UCA													●			
			203F-UCA									●							
204-UCA															●				
Horizontal 90 Degree Elbow	 SP202-HB90-NIR  SP202-HB90-NOR	Provides a horizontal 90 degree turn in floor duct. No hand access provided. Consult factory for other angles.  SP202-HB90's must be specified either with the Narrow Compartment located at the inside radius (-NIR) or at the outside radius (-NOR) as shown in illustration.	201-HB90	●															
			201W-HB90		●														
			202-HB90			●													
			SP202-HB90-NIR				●							●					
			SP202-HB90-NOR					●							●				
			202W-HB90					●								●			
			203-HB90														●		
203F-HB90															●				
204-HB90																●			
Cabinet Connector		Provides a means for connecting duct to an electrical cabinet	201-DCC	●															
			201W-DCC		●														
			202-DCC			●	●												
			202W-DCC					●							●				
			203-DCC							●						●	●		

## Underfloor Duct Raceway Junction Boxes and Accessories

### Ordering Information Note:

**Floor Duct part numbers are for reference only. All Floor Duct orders are not billed with a generic FD prefix project specific part numbers. Please contact your local Hubbell Territory Manager for all Hubbell Duct quotations.**

x = Preset Insert Height  
 1 = 1" (201 & 201F Only)  
 15 = 1 1/2" (min. required for duplex recept.)  
 2 = 2"  
 25 = 2 1/2"  
 3 = 3" (consult factory for heights greater than 3")

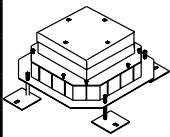
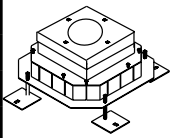
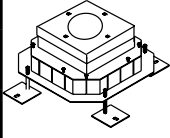
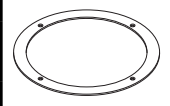
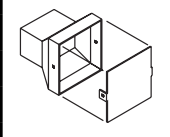
<b>Junction Box Square Access</b>  <p>For providing square opening access at intersections of Feeder Duct and Distribution Duct</p>	<b>201-JB-x</b> <b>201W-JB-x</b> <b>202-JB-x</b> <b>SP202-JB-x</b> <b>202W-JB-x</b> <b>203-JB-x</b> <b>203F-JB-x</b> <b>204-JB-x</b>
	<b>201-JB-x-RCB*</b> <b>201W-JB-x-RCB*</b> <b>202-JB-x-RCB*</b> <b>SP202-JB-x-RCB*</b> <b>202W-JB-x-RCB*</b> <b>203-JB-x-RCB*</b> <b>203F-JB-x-RCB*</b> <b>204-JB-x-RCB*</b>
	<b>202-JB-x-HD-ADJ</b> <b>SP202-JB-x-HD-ADJ</b> <b>202W-JB-x-HD-ADJ</b>
	<b>RD-BRASS*-202-ADJ</b> <b>RD-BRASS*-SP202-ADJ</b> <b>RD-BRASS*-202W-ADJ</b>
	<b>JB-CCA</b> <b>JB-CCA-1/2</b> <b>JB-CCA-3/4</b> <b>JB-CCA-1</b> <b>JB-CCA-1-1/2</b> <b>JB-CCA-2</b>
	Same as above except cover plates are 3/8" thick and after-pour height adjustable. Carpet Rings and Closure Caps must be ordered separately. Duct Entrance Cap - <b>HDJBDC</b> Corner Cap - <b>HDJBCC</b>
	1/8" thick Carpet Trim for Heavy Duty Junction Boxes. *Available in Stainless Steel. To order replace BRASS with SS
<b>Junction Box Round Access</b>  <p>For providing round opening access at intersections of Feeder Duct and Distribution Duct. Provided with Brass or Stainless Steel Carpet Ring</p> <p>*Available in Stainless Steel. To order replace B with SS</p>	<b>201-JB-x-RCB*</b> <b>201W-JB-x-RCB*</b> <b>202-JB-x-RCB*</b> <b>SP202-JB-x-RCB*</b> <b>202W-JB-x-RCB*</b> <b>203-JB-x-RCB*</b> <b>203F-JB-x-RCB*</b> <b>204-JB-x-RCB*</b>
<b>Junction Box Heavy Duty Round Access</b>  <p>Same as above except cover plates are 3/8" thick and after-pour height adjustable. Carpet Rings and Closure Caps must be ordered separately. Duct Entrance Cap - <b>HDJBDC</b>                  Corner Cap - <b>HDJBCC</b></p>	<b>202-JB-x-HD-ADJ</b> <b>SP202-JB-x-HD-ADJ</b> <b>202W-JB-x-HD-ADJ</b>
<b>Carpet Ring for Heavy Duty Junction Boxes</b>  <p>1/8" thick Carpet Trim for Heavy Duty Junction Boxes.                  *Available in Stainless Steel. To order replace BRASS with SS</p>	<b>RD-BRASS*-202-ADJ</b> <b>RD-BRASS*-SP202-ADJ</b> <b>RD-BRASS*-202W-ADJ</b>
<b>Junction Box Corner Conduit Adapter</b>  <p>Provides attachment point for conduit to each corner of all junction boxes. JB-CCA is provided with 14 gauge steel plate for field punched conduit opening. All other adapters are factory punched.</p>	<b>JB-CCA</b> <b>JB-CCA-1/2</b> <b>JB-CCA-3/4</b> <b>JB-CCA-1</b> <b>JB-CCA-1-1/2</b> <b>JB-CCA-2</b>

Flush Insert Duct						Conventional Duct						
201F	201WF	202F	SP202F	202WF	203F	201	201W	202	SP202	202W	203	204
●						●						
	●						●					
		●						●				
			●						●			
				●						●		
					●						●	
												●

### Hubbell Trench Duct is commonly used as a feeder system for Underfloor Duct Raceway systems.



Factory assembled Trench/Underfloor duct intersect units allow unrestricted capacity by the elimination of tunnels. Side mounted Underfloor duct is available for shallow concrete pours. Consult factory for details.

- High capacity design supports large cables for single and multiple service requirements.
- Open top design allows cables to be easily laid in duct.
- Cover plates are removable and adjust horizontally to any point along the duct.
- Custom lengths of trench and fittings are available.
- Multiple compartments allow complete separation of services.
- Innovative duct support assembly allows for pre-pour leveling and acts as a splice for duct sections.

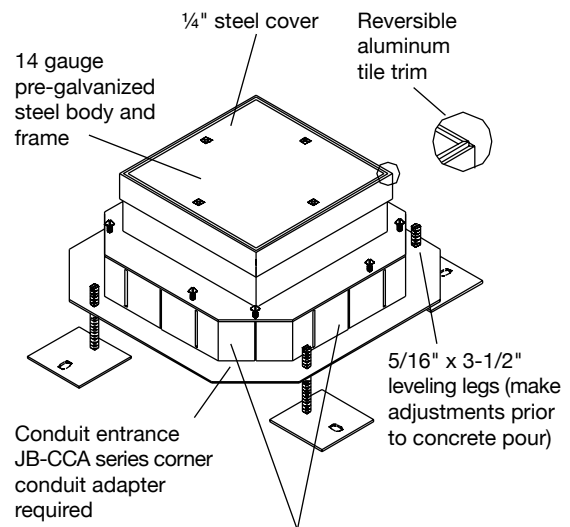

Removable pry-out sections for corner conduit adapters and duct entrances. Additional blanking plates not required for unused junction box entrances. Blanking plates must be ordered separately for heavy duty junction boxes.

## Underfloor Duct Junction Box Dimensions

### Ordering Information Note:

Floor Duct part numbers are for reference only. All Floor Duct orders are lot billed with a generic FD prefix project specific part numbers. Please contact your local Hubbell Territory Manager for all Hubbell Duct quotations.

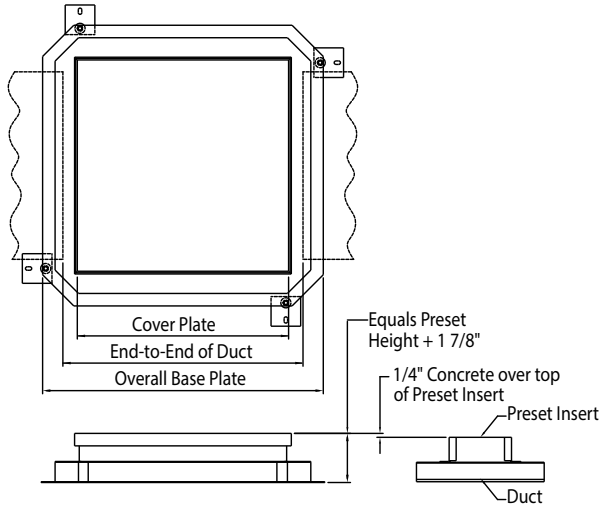

Junction Box Catalog Number	Cover Plate	End-To-End Of Duct	Overall Base Plate
201-JB-x 201-JB-x-RCx	6 5/16"	8"	10 1/2"
201W-JB-x 201W-JB-x-RCx	12 9/16"	14 1/2"	17 13/16"
202-JB-x 202-JB-x-RCx			
SP202-JB-x SP202-JB-x-RCx			
202W-JB-x 202W-JB-x-RCx	17"	19 5/8"	22 11/16"
203-JB-x 203-JB-x-RCx			
203F-JB-x 203F-JB-x-RCx			
204-JB-x 204-JB-x-RCx			
202-JB-x-HD-ADJ SP202-JB-x-HD-ADJ 202W-JB-x-HD-ADJ	Consult Factory For Dimensions		

## Underfloor Duct Raceway Aftersets and Marker Caps

Flush Insert Duct		Description	Catalog Number		
Afterset Insert		Provides means to add activation inserts in the field where needed prior to concrete pour. 14 gauge steel.	1-Gang	1 1/2" Insert Height	<b>DAIFA-1G-15</b>
				2" Insert Height	<b>DAIFA-1G-2</b>
				3" Insert Height	<b>DAIFA-1G-3</b>
			2-Gang	1 1/2" Insert Height	<b>DAIFA-2G-15</b>
				2" Insert Height	<b>DAIFA-2G-2</b>
				3" Insert Height	<b>DAIFA-2G-3</b>
			3-Gang	1 1/2" Insert Height	<b>DAIFA-3G-15</b>
				2" Insert Height	<b>DAIFA-3G-2</b>
				3" Insert Height	<b>DAIFA-3G-3</b>
Marker Cap		Marker caps are used in place of standard insert caps in (a) each insert adjacent to junction box, (b) inserts on each side of a permanent wall, and (c) the last insert in each run of duct.	Insert Marker Cap:		
			Zinc Screw	<b>FA-DMC-Z</b>	
			Brass Screw	<b>FA-DMC-B</b>	
Compartment Cover		Used for abandoning preset opening (one per gang). 18 gauge steel,	Blank Cover	<b>FA-MC</b>	

Round Insert Duct		Description	Catalog Number	
Afterset Insert		Provides means to add activation inserts in the field where needed prior to or after concrete pour. Zinc die cast.	1" Insert Height	<b>DAI-1</b>
			2" Insert Height	<b>DAI-2</b>
			3" Insert Height	<b>DAI-3</b>
			4" Insert Height	<b>DAI-4</b>
Marker Cap		Marker caps are used in place of standard insert caps in (a) each insert adjacent to junction box, (b) inserts on each side of a permanent wall, and (c) the last insert in each run of duct.	Insert Marker Cap:	
			Zinc Screw	<b>DMC-Z</b>
			Brass Screw	<b>DMC-B</b>
Reducing Bushing		Reduces threaded 2" IPS insert opening to either 3/4" NPT or 1" NPT threaded opening for attachment of conduit fitting or pedestal fitting chase nipple.	2" to 3/4"	<b>RB-162</b>
			2" to 1"	<b>RB-163</b>

## Underfloor Duct Raceway Activation Kits

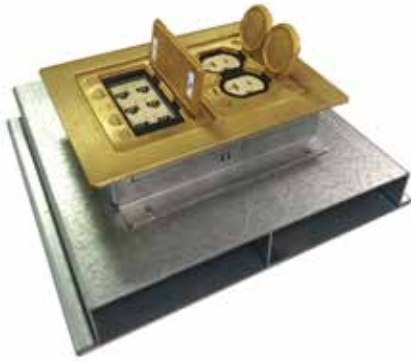

- Available in brass and brushed aluminum to meet aesthetic requirements
- Available in one, two and three-gang options
- ScrubShield® Complies with UL514A scrub water requirements
- Flanged design may be used in tile, wood, carpet, terrazzo and bare concrete applications
- Uniform look when used in same areas where Hubbell floor boxes are installed

		<b>Flush Insert Underfloor Duct</b>		1-Gang 6" x 4.85"	2-Gang 6" x 8.13"	3-Gang 6" x 11.34"	
<b>Flanges</b>	Flanges are provided with adapter plates and accessories required for installing to rectangular Underfloor Duct preset inserts and aftersets.	Brass	<b>SB3083W-UFD</b>	<b>SB3084W-UFD</b>	<b>SB3085W-UFD</b>		
		Aluminum	<b>SA3083W-UFD</b>	<b>SA3084W-UFD</b>	<b>SA3085W-UFD</b>		
<b>Covers</b>	All Covers 4.15" x 2.99"		Duplex Flap	Duplex Screw	Style Line Decorator Opening	Combination 2 1/8" x 3/4"	
		Brass	<b>S3825</b>	<b>S3625</b>	<b>S3826</b>	<b>S2425</b>	
		Aluminum	<b>SA3825</b>	<b>SA3625</b>	<b>SA3826</b>	<b>SA2425</b>	
			Combination 2 1/8" x 1"	2 1/8" Single Receptacle	2 3/8" Single Receptacle	Blank	
		Brass	<b>S2625</b>	<b>S2825</b>	<b>S3425</b>	<b>S3813</b>	
		Aluminum	<b>SA2625</b>	—	—	<b>SA3813</b>	

		<b>Round Insert Underfloor Duct</b>						
<b>Housing</b>	Die-cast aluminum frame, brushed aluminum housing, chase nipple, without plates	1" Chase Nipple	<b>SC3099A</b>					
		3/4" Chase Nipple	<b>SC3098A</b>					
<b>Plates</b>	Duplex Receptacle	Single Receptacle 1.39" (35.3 mm) opening	Style Line Decorator	Blank	Telephone bushing 1 in. I.D. and (2) 3/8" KO for coax	Furniture Feed aluminum plate with 3/4" trade size KO	Furniture Feed aluminum plate, blank	
		<b>SS309D</b>	<b>SS309S</b>	<b>SS309DS</b>	<b>SS309B</b>	<b>SS309T</b>	<b>SS309SF</b>	<b>SS309BF</b>