

Annex to the
technical catalog



Tmax T8

Low voltage molded case
circuit breaker up to 3000 A

UL 489 and CSA C22.2 Standard



1SDC210026D0201 – 2008 Edition



The ABB logo, consisting of the letters 'ABB' in a bold, red, sans-serif font.



Tmax T8

Index

Main characteristics.....	3
Protection trip units	5
Accessories.....	7
Characteristic curves and technical information	14
Wiring diagrams	21
Overall dimensions	30
Ordering codes.....	35

Main characteristics

The Tmax family, conforming to the UL 489 and CSA C22.2 No. 5.1 Standards, is enriched with the Tmax T8 size, which allows 3000 A to be reached. Also available in the 1600 A, 2000 A and 2500 A frames, Tmax T8 is equipped with the same electronic trip units as Tmax T7, thereby guaranteeing extremely high performances able to satisfy all installation requirements. Adequately sized for the performances offered (W=16.8 / D=11.2 / H=15.0 in). Tmax T8 is able to interrupt the following short-circuit currents: 125 kA@480 V and 100 kA@600 V.



Main characteristics

General characteristics

The Tmax T8 size has both circuit breakers and molded case switches (MCS). The following tables show the main characteristics of these ranges.

Circuit breakers for power distribution

			Tmax T8
Frame size		[A]	1600/2000/2500/3000
Number of poles		[No]	3/4
Rated voltage	(AC) 50-60 Hz	[V]	600
	(DC)	[V]	-
Test voltage (1 min) 50-60 Hz		[V]	3000
Interrupting ratings		[kA rms]	V
	240 V AC	[kA rms]	125
	480 V AC	[kA rms]	125
	600 V AC	[kA rms]	100
Trip units	Electronic	PR232/P-T8	■
		PR331/P	■
		PR332/P	■
Dimensions fixed version (3p)	H	[in-mm]	15.0 - 382
	W	[in-mm]	16.8 - 427
	D	[in-mm]	11.2 - 282
Mechanical life		[operations]	15000
Weight (fixed 3p)	1600/2000/2500 A	[lbs]	161
	3000 A	[lbs]	236

Molded case switches (MCS)

The Tmax T8 MCS are derived from the corresponding circuit breakers, of which they keep the overall dimensions, the versions, the fixing systems and the possibility of mounting accessories unchanged. This version only differs from the circuit breakers in the absence of the protection trip units. All molded case switches comply with the UL 489 and CSA C22.2 Standards and are self-protected.

			Tmax T8V-D
Rating		[A]	2000/2500/3000
Poles		[No]	3/4
Magnetic override		[A]	40000
Rated voltage	AC (50-60 Hz)	[V]	600
	DC	[V]	-

Protection trip units

Electronic trip units

The Tmax T8 circuit breakers can be equipped with the same protection trip units as those available on the Tmax T7 circuit breaker, except for the PR231 which is not provided on T8. The protection trip units available are therefore:

- PR232/P-T8
- PR331/P
- PR332/P

For further details, please consult the technical catalogue: "Tmax – Low Voltage moulded-case circuit-breakers up to 1600 A" (code 1SDC210023D0203).



SACE PR232/P-T8



SACE PR331/P



SACE PR332/P

Interchangeability

Tmax T8 circuit breakers can be equipped either with PR232/P-T8, PR331/P and PR332/P trip units. Thanks to their simplicity to change the rating plug, the end customer can change the In of the circuit breaker extremely rapidly.

Trip units

Circuit breakers	PR232/P-T8						PR331/P						PR332/P					
	1000	1200	1600	2000	2500	3000	1000	1200	1600	2000	2500	3000	1000	1200	1600	2000	2500	3000
T8 1600	▲	▲	■				▲	▲	■				▲	▲	■			
T8 2000	▲	▲	▲	■			▲	▲	▲	■			▲	▲	▲	■		
T8 2500	▲	▲	▲	▲	■		▲	▲	▲	▲	■		▲	▲	▲	▲	■	
T8 3000	▲	▲	▲	▲	▲	■	▲	▲	▲	▲	▲	■	▲	▲	▲	▲	▲	■

- = complete circuit breaker already coded
- ▲ = circuit breaker to be assembled (rating plug extracode to be added)

Protection trip units

Range of application of the alternating current circuit breakers

AC	Trip unit	Range [A]
T8	PR232/P-T8	1000...3000
	PR331/P	1000...3000
	PR332/P	1000...3000

Rating plug

Circuit breaker	Rated current I _n	1000	1200	1600	2000	2500	3000
T8	1600	■	■	■			
	2000	■	■	■	■		
	2500	■	■	■	■	■	
	3000	■	■	■	■	■	■

Accessories

Tmax T8 can be fitted with a complete range of accessories, which allows the user to deal with different plant requirements. From the viewpoint of the request for standardization on the market, Tmax T8 is able to offer most of its accessories in common with other circuit breaker sizes. The various types of accessories which can equip Tmax T8 are given below.

Connection terminals

For each type of terminal, the tables below summarize the information needed to make the connections.

Front terminals - F

Allow connection of busbars or cables terminated with cable terminals

Type	Version	Pieces	Busbars/cable terminals (in-mm)			Tightening [lbin-Nm]	Phase separators
			W	D	Ø		
T8 2000	F	3	3.94 - 100	0.2 - 5	4 x 0.59 - 15	625 - 70	R
T8 2500	F	4	3.94 - 100	0.2 - 5	4 x 0.59 - 15	625 - 70	R

Note: Tightening is referred to the cables/busbars on the terminal.

Rear vertical terminals - VR

Allow connection of busbars at the rear

Type	Version	Pieces	Busbars/cable terminals (in-mm)			Tightening [lbin-Nm]	Phase separators
			W	D	Ø		
T8 2000	F	3	3.94 - 100	0.2 - 5	4 x 0.59 - 15	625 - 70	R
T8 2500	F	4	3.94 - 100	0.2 - 5	4 x 0.59 - 15	625 - 70	R
T8 3000	F	4	3.94 - 100	0.2 - 5	4 x 0.71 - 18	890 - 100	R

Note: Tightening is referred to the cables/busbars on the terminal.

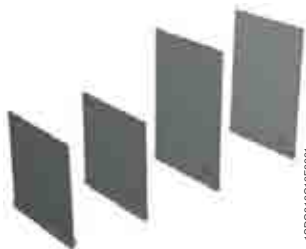

Phase separating partitions

These allow the insulation characteristics between the phases at the connections to be increased. They are mounted from the front, even with the circuit breaker already installed.

Two versions are available for Tmax circuit breakers:

- 3.94" (100 mm) high
- 7.87" (200 mm) high.

Accessories



1SDC200131F0001

YO



1SDC200132F0001

YC



1SDC200135F0001

Shunt trip/closing coil (YO/YC) and second shunt trip (YO2)

UL Listed

According to the installation position, these devices allow remote opening or closing control of the apparatus. They can be supplied either by means of impulses with a minimum duration of 100 ms, or permanently. In the latter case, the following conditions must be checked:

- when a shunt trip is supplied, wait 30 ms before giving a closing command;
- when a closing coil is supplied to carry out circuit breaker reclosing after opening, it is necessary to momentarily de-energize the shunt closing coil (the circuit breaker operating mechanism is, in fact, fitted with the anti-pumping device).

Operation of the releases is guaranteed for a voltage between 70% / 85% (YO/YC) and 110% of the rated power supply voltage U_n , both in alternating and in direct current.

For the installations where it is necessary to have extremely high safety of the circuit breaker remote opening command, it is possible to equip T8 with a second shunt trip. This device is fitted with a special support to hold it, but can in any case hold the standard closing coil and shunt trip. The seat of the second shunt trip is the one of the undervoltage release, which is therefore incompatible. The special support including the second shunt trip is installed in place of the standard support. The technical characteristics of the second shunt trip are the same as those of the standard shunt trip.

Version	Absorbed power on inrush Tmax T8	
	AC [VA]	DC [W]
24 V DC		200
30 V AC/DC	200	200
48 V AC/DC	200	200
60 V AC/DC	200	200
110-120 V AC/DC	200	200
120-127 V AC/DC	200	200
220-240 V AC/DC	200	200
240-250 V AC/DC	200	200
380-400 V AC	200	
440 V AC	200	
Opening time (YO-YO2) [ms]	≤ 60	≤ 60
Closign time (YC) [ms]	≤ 80	≤ 80

SOR Test Unit

The SOR control and monitoring Test Unit allows correct functionality of the shunt trips which can be mounted on Tmax T8 to be verified in order to guarantee high reliability of the circuit breaker opening command.

For further details, please consult the technical catalogue: "Tmax – Low Voltage moulded-case circuit-breakers up to 1600 A" (code 1SDC210023D0203).



1SDC200139F0001

YU

Undervoltage release (YU) UL Listed

The undervoltage release carries out circuit breaker opening in the case of notable lowering or lack of power supply voltage of the latter. The power supply of the release is branched on the supply side of the circuit breaker or from an independent source and circuit breaker closing is only possible with the release supplied (the lock on closing is made mechanically).

The release can operate either in direct or alternating current. Circuit breaker opening takes place with release power supply voltage values equal to 35–70% U_n , whereas circuit breaker closing is possible with release power supply voltage within the 85–110% U_n range. It can be fitted with a contact signaling the undervoltage release is de-energized.

Version	Power consumption during permanent operation Tmax T8	
	AC [VA]	DC [W]
24 V DC		5
30 V AC/DC	5	5
48 V AC/DC	5	5
60 V AC/DC	5	5
110-120 V AC/DC	5	5
120-127 V AC/DC	5	5
220-240 V AC/DC	5	5
240-250 V AC/DC	5	5
380-400 V AC	5	
440 V AC	5	
Opening time [ms]	30	30



1SDC200139F0001

Time-delay device for undervoltage release

The undervoltage release can be combined with an external electronic time-delay device mounted outside the circuit breaker. It allows circuit breaker opening to be delayed in the case of lowering or lack of power supply voltage of the release itself, according to established and adjustable delays, so as to avoid undesired trips caused by temporary malfunctions.

The time-delay device must be used with an undervoltage release with the same operating voltage.

Circuit breaker	Power supply [V AC/DC]
T8	24...30
	48
	60
	110...125
	220...250
Adjustable opening time [s]	0.5 - 1 - 1.5 - 2 - 3

Accessories

Electric signals

UL Listed

The Tmax T8 circuit breaker can be fitted with a complete range of auxiliary contacts able to take the information about its state of operation outside the circuit breaker. These auxiliary contacts are available for use both in direct and in alternating current at different voltages.

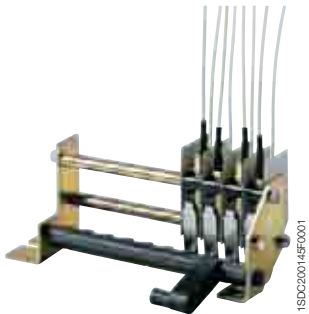

Auxiliary status contacts

These are auxiliary contacts on changeover for signaling circuit breaker open or closed and are available in the following two combinations:

- 4 open/closed contacts for PR232 and PR331
- 4 open/closed contacts for PR332 (4 contacts on changeover + 1 contact dedicated to trip unit)

The auxiliary contacts are available with rated voltage of 400 V or for lower rated voltages at 24 V (digital signals).

The auxiliary contacts for PR332 are always supplied with automatic circuit breakers.

Bell alarm

This allows visual signaling (mechanical) and remote signaling (electrical) in the case of circuit breaker open following overcurrent release operation by means of advance of the release operation pushbutton. The circuit breaker can only be closed again by resetting the pushbutton in its normal position.



Contact signaling undervoltage release de-energized (Aux. contact YU)

The undervoltage releases can be fitted with a contact (at choice normally closed or open) for signaling undervoltage release energized for remote signaling of the state of the undervoltage release.



1SDC210N19F001



1SDC210D22F001



1SDC200108F001

Trip reset

This is an electronic contact which allows remote resetting of the circuit breaker following operation of the overcurrent releases. It is available with three power supply voltages: 24...30 V AC/DC, 110...130 V AC/DC and 200...240 V AC/DC.

Mechanical operation counter

This device is connected to the operating mechanism by means of a simple lever device. It indicates the number of mechanical operations of the circuit breaker. The indication is visible from the outside on the front of the circuit breaker.

Spring charging motor UL Listed

This automatically recharges the circuit breaker operating mechanism closing springs. This operation is done automatically immediately after circuit breaker closing.

When there is no power supply voltage, or during maintenance work, the closing springs can in any case be charged manually by means of the special operating mechanism lever. This is always provided with a limit contact and microswitch for signaling closing springs charged.

	AC [V]	DC [V]
Rated voltage, U_n	24...30	24...30
	48...60	48...60
	100...130	100...130
	220...250	220...250
Operating voltage [% U_n]	85...110	85...110
Power consumption on inrush	500 VA	500 W
Inrush time [s]	0.2	0.2
Charging time [s]	4-5	4-5

Accessories

Padlock in the open position

This allows the circuit breaker to be locked in the open position by means of padlocks, with up to a maximum of 3 padlocks (not supplied), with 4 mm \varnothing .

Key lock in the open position

This allows the circuit breaker to be locked in the open position by means of a circular lock with different keys (for an individual circuit breaker) or with the same keys (for several circuit breakers). In the latter case, up to four different key numbers are available.

Transparent protection for pushbutton – TCP

A transparent protection for the circuit breaker opening and closing pushbuttons is available on Tmax T8. The operations on the circuit breaker are therefore prohibited except by means of a special tool.

IP54 Door protection (NEMA 3/S/13)

This is made by means of a transparent plastic cover which completely protects the front of the circuit breaker and allows IP54 degree of protection to be obtained. Mounted on hinges, it is provided with a key lock.

Accessories for protection trip units

The majority of the accessories for the protection trip units which equip the Tmax T8 circuit breakers are in common with those available for the Tmax T7 size and therefore have the same characteristics and possibility of being fitted with accessories.

For further details, please consult the technical catalogue: “Tmax – Low Voltage moulded-case circuit-breakers up to 1600 A” (code 1SDC210023D0203).

The list of the modules and accessories which can be combined with the protection trip units for Tmax T8 is given below:

- PR330/V-T8 (optional on PR332/P)
- PR330/D-M (optional on PR332/P)
- PR330/R Actuation unit
- BT030 Wireless communication unit
- PR030/B Power supply unit
- HMI030 Interface from front of switchgear
- PR021/K Signaling unit
- PR010/T Programming and test unit.



1SDC200169F0001



1SDC200167F0001



1SDC200169F0001



1SDC200169F0001

**Rating plug
(UL file: E116596)**

Available on the electronic trip units which can be mounted on Tmax T8, it must be applied onto the front of the trip unit itself and provides information about the current sensor setting. It is therefore no longer necessary to change the circuit breaker current sensors, but simply to replace the rating plug modify the rated current of the circuit breaker.

Type of circuit breaker	Rated current Iu	1000	1200	1600	2000	2500	3000
T8	1600	■	■	■			
	2000	■	■	■	■		
	2500	■	■	■	■	■	
	3000	■	■	■	■	■	■

Current sensor for external neutral

This is applied onto the external neutral conductor and makes it possible to have the G protection against earth faults with three-pole circuit breakers and external neutral. The current sensor must be connected directly to the terminal box. This combination is not possible with the PR232-T8 electronic trip unit.

T8 [A]
1000...3000

Characteristic curves and technical information

Trip curves

T8 1600/2000/2500/3000 – PR232/P-T8

Functions L-S-I

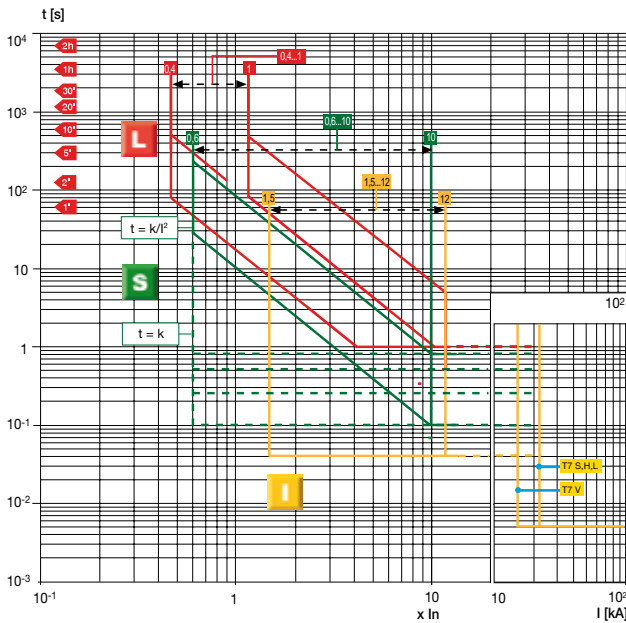

T8 1600/2000/2500/3000 – PR331/P

Functions L-S-I

Note: For T8 In = 3000 A ⇒ I_{g,max} = 12 x In

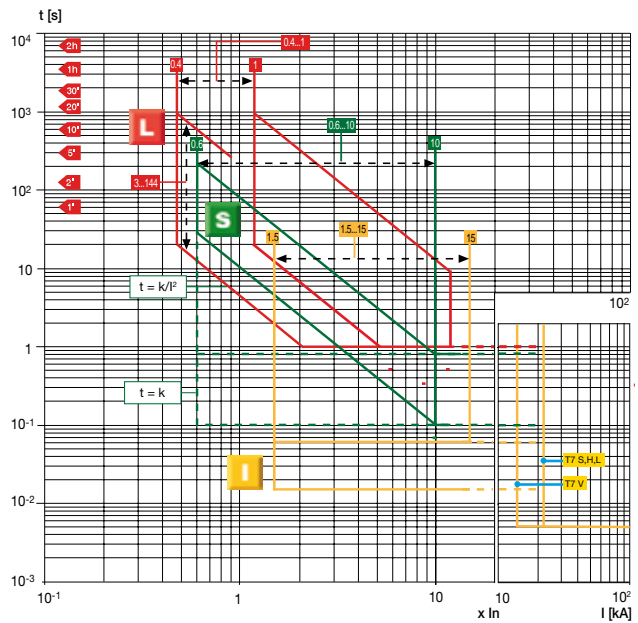

T8 1600/2000/2500/3000 – PR331/P

Function G

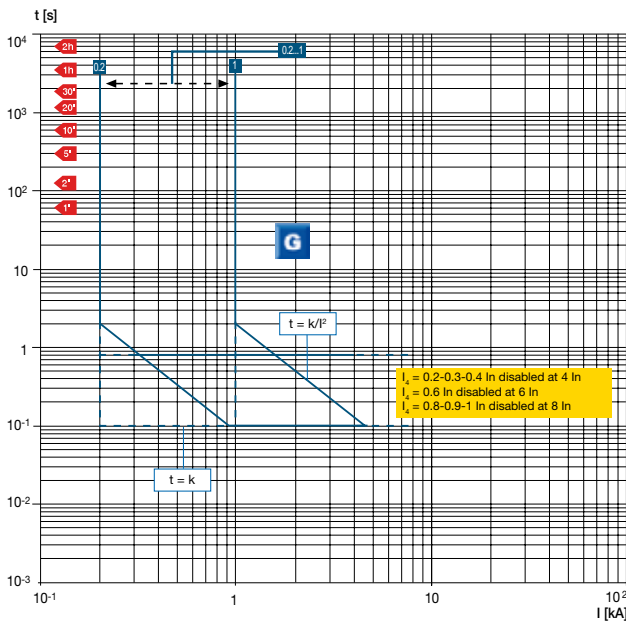

T8 1600/2000/2500/3000 – PR332/P

L-I Functions

Note: For T8 In = 3000 A ⇒ I_{g,max} = 12 x In

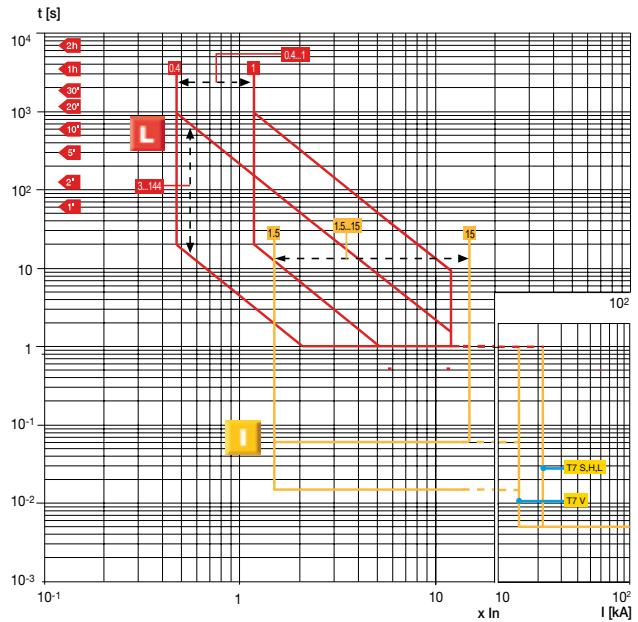

T8 1600/2000/2500/3000 – PR332/P

L-S-I Functions

Note: For T8 In = 3000 A ⇒ I_gmax = 12 x In

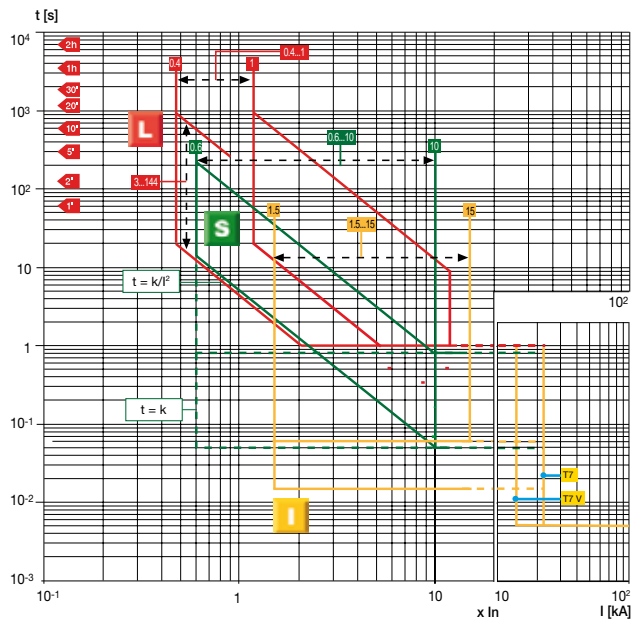

T8 1600/2000/2500/3000 – PR332/P

G Function

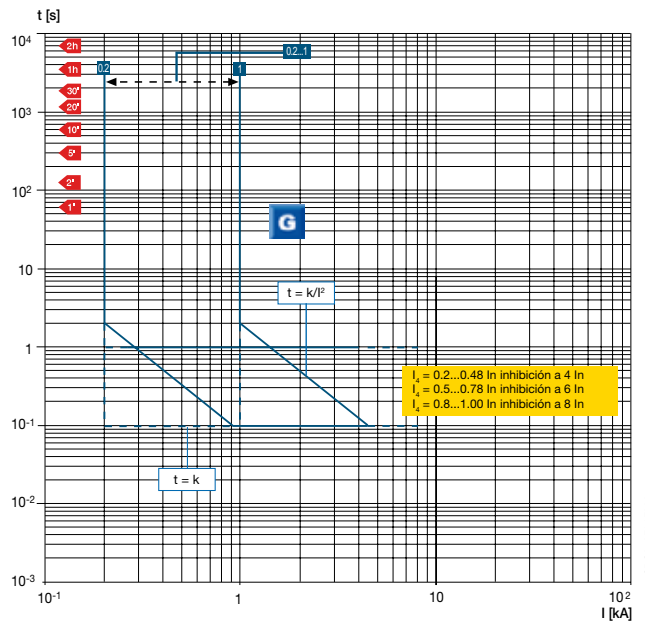

T8 1600/2000/2500/3000 – PR332/P

U Function

k = 0.14 α = 0.02

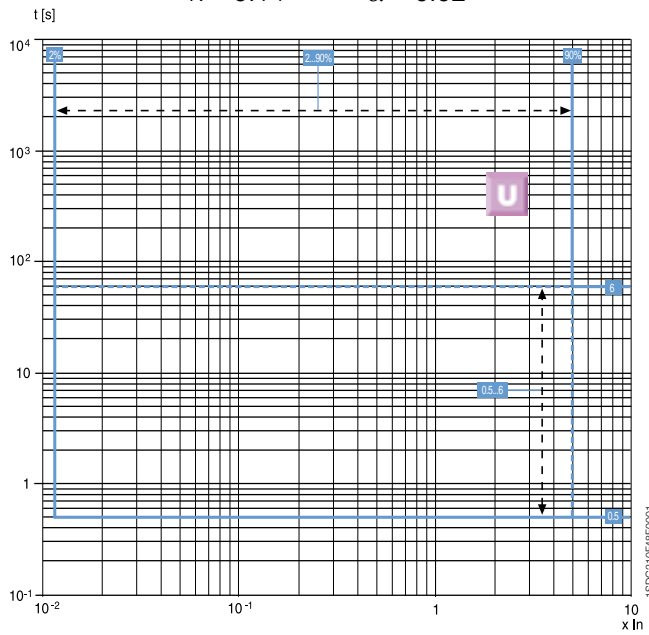

T8 1600/2000/2500/3000 PR332/P with PR330/V-T8

UV Function

k = 13.5 α = 1

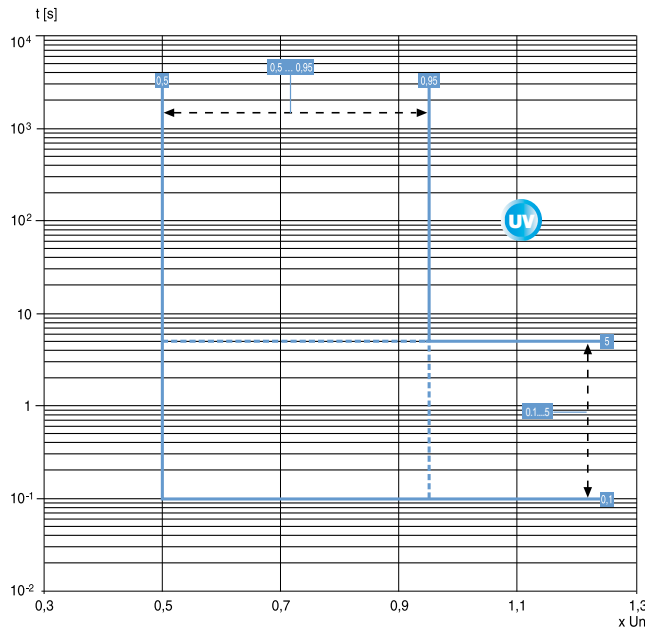

Characteristic curves and technical information

Trip curves

T8 1600/2000/2500/3000 PR332/P with PR330/V-T8

OV Function

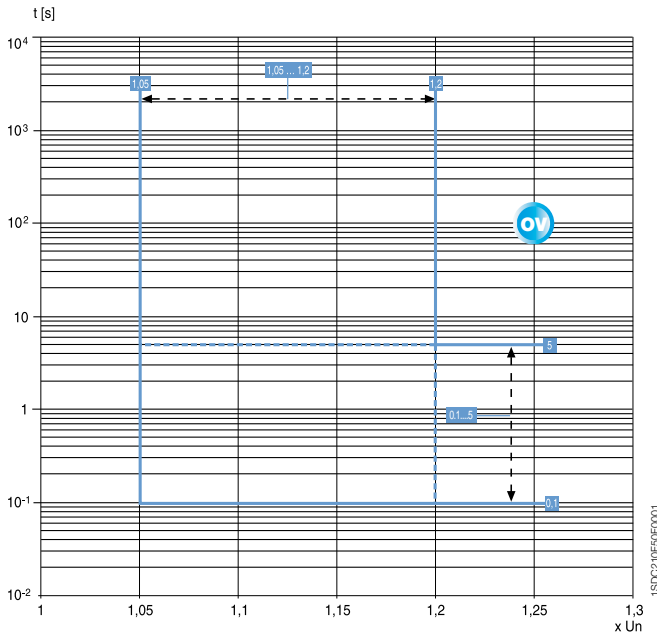

T8 1600/2000/2500/3000 PR332/P with PR330/V-T8

RV Function

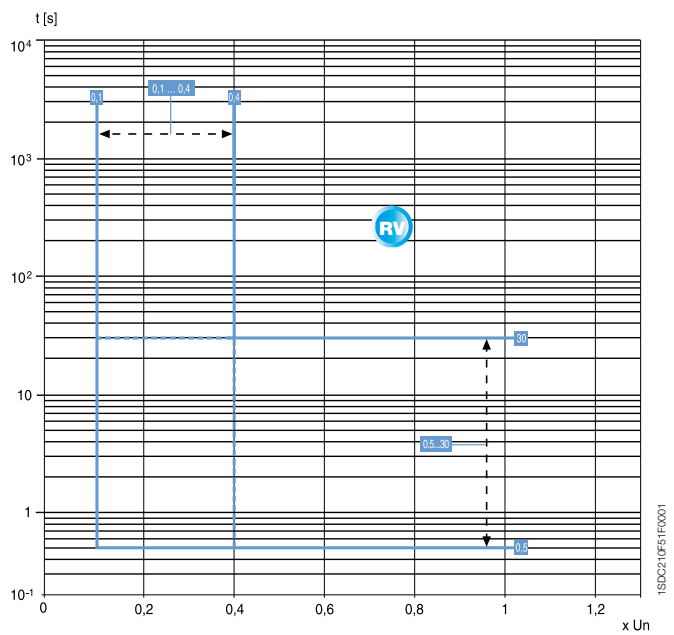

T8 1600/2000/2500/3000 PR332/P with PR330/V-T8

RP Function

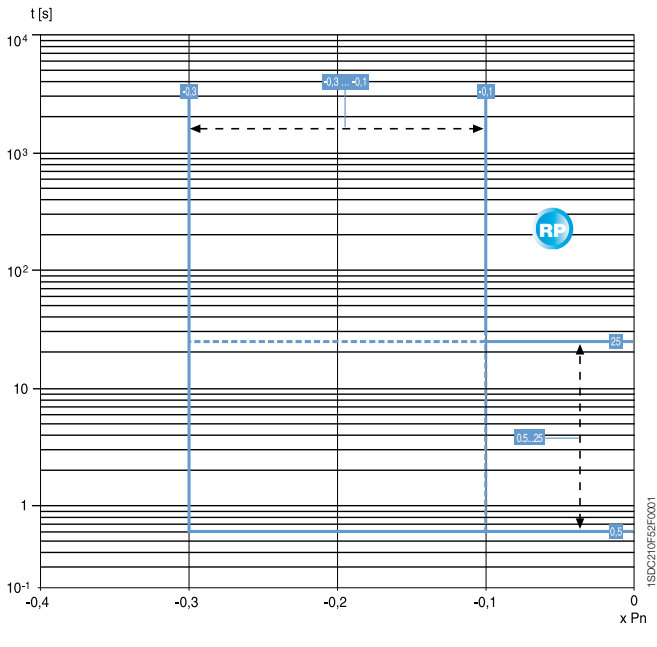

Characteristic curves and technical information

Specific let-through energy curves

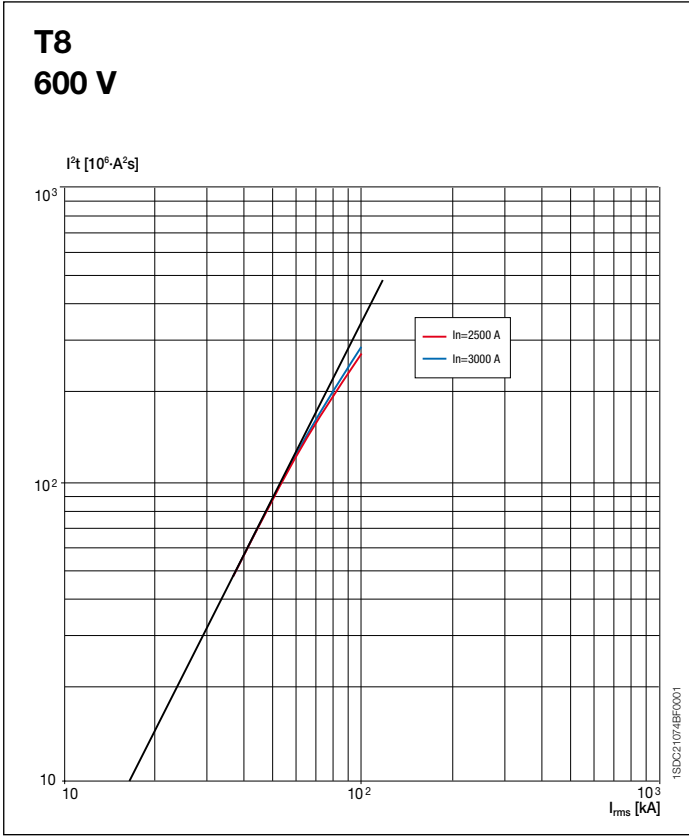
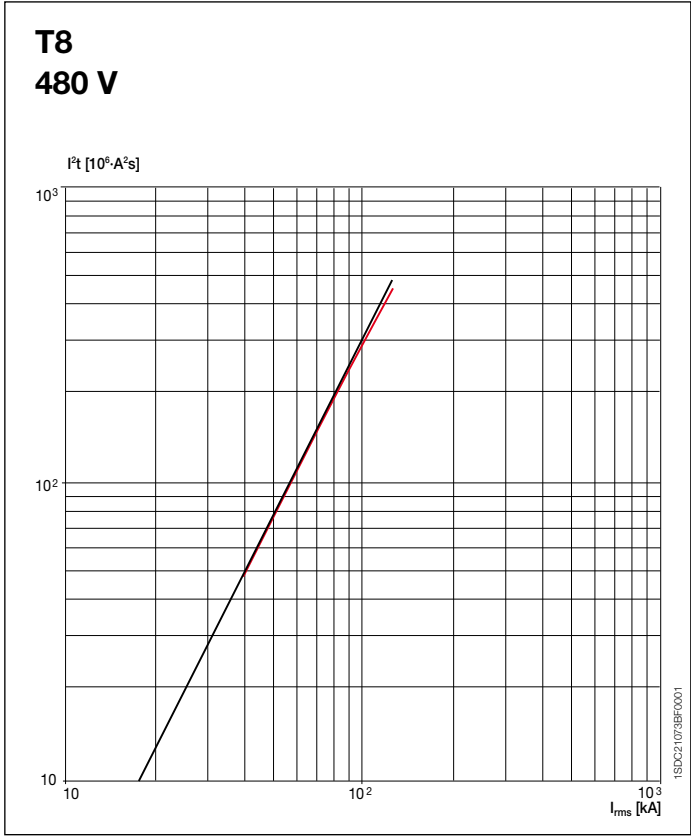

Characteristic curves and technical information

Limitation curves

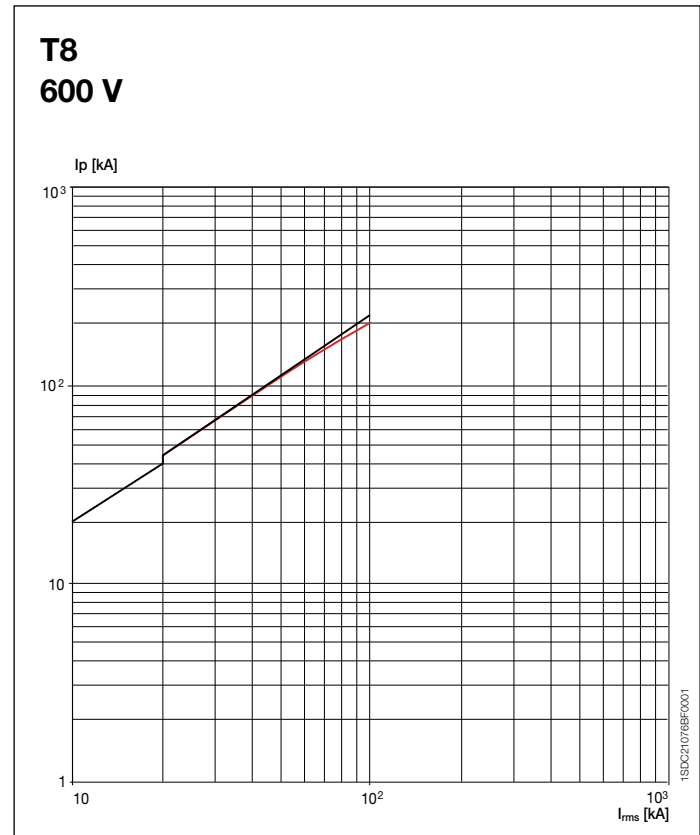
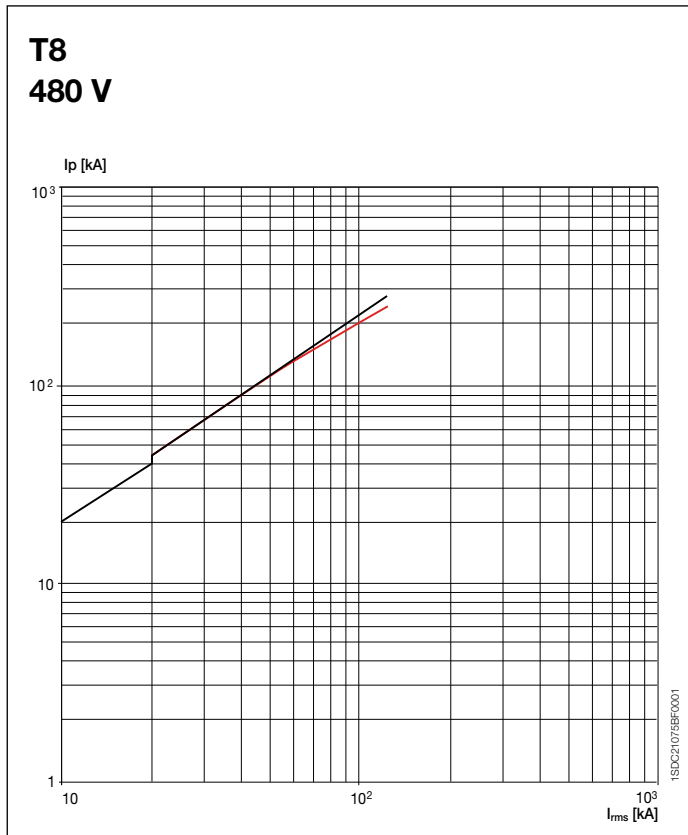

Characteristic curves and technical information

Temperature performances
Circuit breakers with electronic trip units

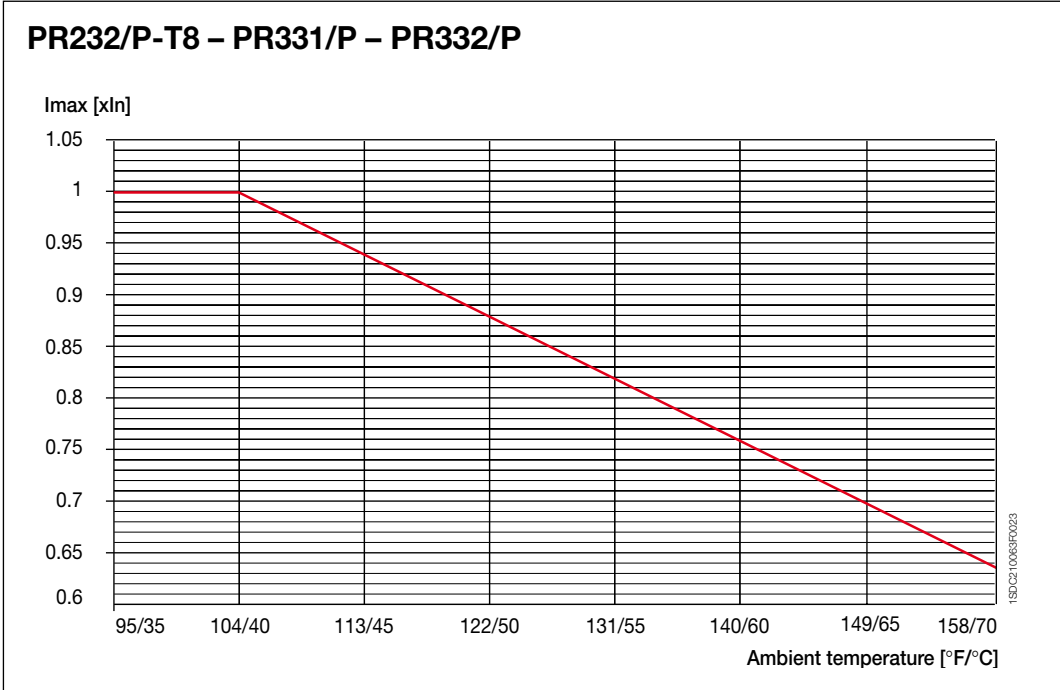

Characteristic curves and technical information

Power losses

Power [W/pole]	In [A]	T8
PR232-T8	1600	30
PR331	2000	46
PR332	2500	73
	3000	117

Wiring diagrams

Information for reading - Circuit breakers T8

Warning

Before installing the circuit breaker, carefully read notes F and O on the circuit diagrams.

Operating status shown

The circuit diagram is for the following conditions:

- circuit breaker in open position
- circuits de-energized
- trip units not tripped
- motor operating mechanism with springs discharged.

Versions

The control circuits are fitted between terminals XV (connectors X12-X13-X14-X15 are not supplied).

Molded case switches (MCS)

With this version, the applications indicated in figures 13, 14, 41A, 42A, 43A, 44A, 45A, 62A cannot be provided.

Version with PR232/P-T8 electronic trip unit

With this version, the applications indicated in figures 41A, 42A, 43A, 44A, 45A, 62A cannot be provided.

Version with PR331/P electronic trip unit

With this version, the applications indicated in figures 42A, 43A, 44A, 45A cannot be provided.

Version with PR332/P electronic trip unit

With this version, the applications indicated in figure 41A cannot be provided.

Caption

- = Circuit diagram figure number
- * = See note indicated by letter
- A1 = Circuit breaker accessories
- A4 = Example switchgear and connections for control and signaling, outside the circuit breaker
- A13 = PR021/K signaling unit (outside the circuit breaker)
- A19 = PR330/R actuation unit
- AY = SOR TEST UNIT Test/monitoring Unit (see note R)
- D = Electronic time-delay device of the undervoltage release, outside the circuit breaker
- K51 = PR232/P-T8, PR331/P, PR332/P type electronic trip unit with the following protection functions:
 - L overload protection with inverse long time-delay trip - setting I_1
 - S short-circuit protection with inverse or definite short time-delay trip - setting I_2
 - I short-circuit protection with instantaneous time-delay trip - setting I_3
 - G ground fault protection with inverse short time-delay trip - setting I_4
- K51/1...8 = Contacts of the PR021/K signaling unit
- K51/GZin (DBin) = Zone selectivity: input for protection G or "reverse" direction input for protection D (only with Uaux. and PR332/P trip unit)
- K51/GZout (DBout) = Zone selectivity: output for protection G or "reverse" direction output for protection D (only with and PR332/P trip unit)
- K51/SZin (DFin) = Zone selectivity: input for protection S or "direct" input for protection D (only with Uaux. and PR332/P trip unit)
- K51/SZout (DFout) = Zone selectivity: output for protection S or "direct" output for protection D (only with Uaux. and PR332/P trip unit)

Wiring diagrams

Information for reading - Circuit breakers T8

K51/YC	= Closing control from PR332/P electronic trip unit with communication module PR330/D-M and PR330/R actuation unit
K51/YO	= Opening control from PR332/P electronic trip unit with communication module PR330/D-M and PR330/R actuation unit
M	= Motor for charging the closing springs
Q	= Circuit breaker
Q/1...5	= Circuit breaker auxiliary contacts
S33M/1...3	= Limit contacts for spring-charging motor
S43	= Switch for setting remote/local control
S51	= Contact for electrical signaling of circuit breaker open due to tripping of the over-current trip unit. The circuit breaker may be closed only after pressing the reset pushbutton, or after energizing the coil for electrical reset (if available)
S51/P1	= Programmable contact (as default it signals overload present - start)
SC	= Pushbutton or contact for closing the circuit breaker
SO	= Pushbutton or contact for opening the circuit breaker
SO1	= Pushbutton or contact for opening the circuit breaker with delayed trip
SO2	= Pushbutton or contact for opening the circuit breaker with instantaneous trip
SR	= Pushbutton or contact for electrical circuit breaker reset
SRTC	= Contact for electrical signaling of circuit breaker open, with springs charged and ready to close
SY	= Contact for electrical signaling of circuit breaker open due to trip units tripped, YO, YO1, YO2, YU (tripped position) only for circuit breakers with direct control
TI/L1	= Current transformer located on phase L1
TI/L2	= Current transformer located on phase L2
TI/L3	= Current transformer located on phase L3
Uaux.	= Auxiliary power supply voltage (see note F)
UI/L1	= Current sensor (Rogowski coil) located on phase L1
UI/L2	= Current sensor (Rogowski coil) located on phase L2
UI/L3	= Current sensor (Rogowski coil) located on phase L3
UI/N	= Current sensor (Rogowski coil) located on neutral
UI/0	= Current sensor (Rogowski coil) located on the conductor connecting to ground the star point of the MV/LV transformer (see note G)
W1	= Serial interface with control system (external bus): EIA RS485 interface (see note E)
W2	= Serial interface with the accessories of PR331/P and PR332/P trip units (internal bus)
XB1...XB7	= Connectors for the accessories of the circuit breaker
XF	= Delivery terminal box for the position contacts of the draw out circuit breaker (located on the cradle of the circuit breaker)
XO	= Connector for YO1 release
XR1 – XR2	= Connector for power circuits of PR232/P-T8, PR331/P, and PR332/P trip units
XR5 – XR13	= Connector for power circuits of PR332/P trip unit
XV	= Delivery terminal box for the auxiliary circuits
YC	= Closing coil
YO	= Shunt trip
YO1	= Overcurrent shunt trip (trip coil)
YO2	= Second shunt trip (see note Q)
YR	= Coil to electrically reset the circuit breaker
YU	= Undervoltage release (see notes B, C and Q)

Description of figures

- Fig. 1 = Motor circuit to charge the closing springs.
- Fig. 2 = Circuit of closing coil.
- Fig. 4 = Shunt trip.
- Fig. 6 = Instantaneous undervoltage release (see notes B, C and Q).
- Fig. 7 = Undervoltage release with electronic time-delay device, outside the circuit breaker (see notes B and Q).
- Fig. 8 = Second shunt trip (see note Q).
- Fig. 11 = Contact for electrical signaling of springs charged or discharged.
- Fig. 12 = Contact for electrical signaling of circuit breaker open, with springs charged, and ready to close.
- Fig. 13 = Contact for electrical signaling of circuit breaker open due to tripping of the overcurrent release. The circuit breaker may be closed only after pressing the reset pushbutton, or after energizing the coil for electronic reset (if available).
- Fig. 14 = Electrical reset control.
- Fig. 21 = Circuit breaker auxiliary contacts (for circuit breakers with manual control only).
- Fig. 41A = Auxiliary circuits of PR331/P trip unit (see note F).
- Fig. 42A = Auxiliary circuits of PR332/P trip units (see notes F and N).
- Fig. 43A = Circuits of the measuring module PR330/V-T8 of the PR332/P trip units internally connected to the circuit breaker (optional).
- Fig. 44A = Circuits of the measuring module PR330/V-T8 of the PR332/P trip units externally connected to the circuit breaker (optional; see note O).
- Fig. 45A = Circuits of the PR332/P trip unit with communication module PR330/D-M connected to PR330/V actuation unit (see notes E, F and N).
- Fig. 46A = Circuits of the PR332/P trip unit PR330/V-T8 measuring module connected internally to the three-pole circuit breaker with external neutral conductor (optional)
- Fig. 61A = SOR TEST UNIT Test/monitoring unit (see note R).
- Fig. 62A = Circuits of the PR021/K signalling module (outside the circuit breaker).

Incompatibilities

The circuits indicated in the following figures cannot be supplied simultaneously on the same circuit breaker:

- 6 - 7 - 8
- 13 - 14
- 41A - 42A - 45A
- 43A - 44A - 46A

Notes

- A) The circuit breaker is only fitted with the accessories specified in the ABB order acknowledgement. Please contact your local sales organization.
- B) The undervoltage release is supplied for operation using a power supply branched on the supply side of the circuit breaker or from an independent source. The circuit breaker can only close when the trip unit is energized (there is a mechanical lock on closing).
- E) For the EIA RS485 serial interface connection see document ITSCE - RH0298 regarding MODBUS communication.
- F) The auxiliary voltage Uaux allows actuation of all operations of the PR331/P and PR332/P trip units. Having requested a Uaux insulated from ground, one must use "galvanically separated converters" in compliance with IEC 60950 (UL 1950) or equivalent standards that ensure a common mode current or leakage current (see IEC 478/1, CEI 22/3) not greater than 3.5 mA, IEC 60364-41 and CEI 64-8.

Wiring diagrams

Information for reading - Circuit breakers T8

- G) Ground fault protection is available with the PR332/P trip units by means of a current sensor located on the conductor connecting to ground the star center of the MV/LV transformer. The connections between terminals 1 and 2 (or 3) of current transformer UI/O and poles T7 and T8 of the X (or XV) connector must be made with a two pole shielded and stranded cable (type BELDEN 8762/8772), no more than 15 m long. The shield must be grounded on the circuit breaker side and current sensor side.
- N) With PR332/P trip units, the connections to the zone discrimination inputs and outputs must be made with a two-pole shielded and stranded cable (type BELDEN 8762/8772), no more than 300 m long. The shield must be grounded on the discrimination input side.
- O) Systems with rated voltage greater than 690V require the use of an insulation voltage transformer to connect to the busbars.
- P) With PR332/P trip units with communication module PR330/R, the power supply for coils YO and YC must not be taken from the main power supply. The coils can be controlled directly from contacts K51/YO and K51/ YC with maximum voltages of 110-120 V DC and 240-250 V AC.
- Q) The second shunt trip may be installed as an alternative to the undervoltage release.
- R) The SOR TEST UNIT + shunt trip (YO) is guaranteed to operate starting at 75% of the U_{aux} of the shunt trip itself.
While the YO power supply contact is closing (short-circuit on terminals 4 and 5), the SOR TEST UNIT is unable to detect the opening coil status. Consequently:
 - for continuously powered opening coil, the TEST FAILED and ALARM signals will be activated
 - if the coil opening command is of the pulsing type, the TEST FAILED signal may appear at the same time. In this case, the TEST FAILED signal is actually an alarm signal only if it remains lit for more than 20s.
- S) The connection cable shield must only be grounded on the circuit breaker side.
- T) The connections between the TO toroidal transformer and the poles of the X13 (or XV) connector of the circuit breaker must be made using a four-pole shielded cable with paired braided conductors (BELDEN 9696 paired type), with a length of not more than 15 m. The shield must be grounded on the circuit breaker side.

Wiring diagrams

Graphic diagram symbols (IEC 60617 and CEI 3-14...3-26 Standards)

	Thermal effect		Connection of conductors		Position switch (limit switch), break contact		Differential current relay
	Electromagnetic effect		Terminal		Position switch (limit switch) change-over break before make contact		Phase-failure detection relay in a three-phase system
	Delay		Plug and socket (male and female)		Contactor (contact open in the unoperated position)		Locked-rotor detection relay operating by current sensing
	Mechanical connection (link)		Resistor (general symbol)		Circuit breaker disconnect with automatic trip unit		Lamp, general symbol
	Manually operated control (general case)		Temperature dependent resistor		Switch-disconnector (on-load isolating switch)		Mechanical interlock between two devices
	Operated by turning		Motor (general symbol)		Operating device (general symbol)		Operated by electric motor
	Operated by pushing		Induction motor, three-phase, squirrel cage		Thermal relay		Motor with series energization
	Operated by key		Current transformer		Instantaneous overcurrent or rate-of-rise relay		Screen, shield (it may be drawn in any convenient shape)
	Operated by cam		Current transformer with four threaded winding and with one permanent winding with one tapping		Overcurrent relay with adjustable short time-lag characteristic		Equipotentiality
	Hearth, ground (general symbol)		Make contact		Overcurrent relay with inverse short time-lag characteristic		Voltage transformer
	Converter with galvanic separator		Break contact		Overcurrent relay with inverse long time-lag characteristic		Winding of three-phase transformer, connection star
	Conductors in a screened cable, two conductors shown		Change-over break before make contact		Earth fault overcurrent relay with inverse short time-lag characteristic		Current sensing element
	Twisted conductors, two conductors shown		Position switch (limit switch), make contact		Phase-balance current relay		

Wiring diagrams

Wiring diagram of the T8 circuit breakers

Operating status

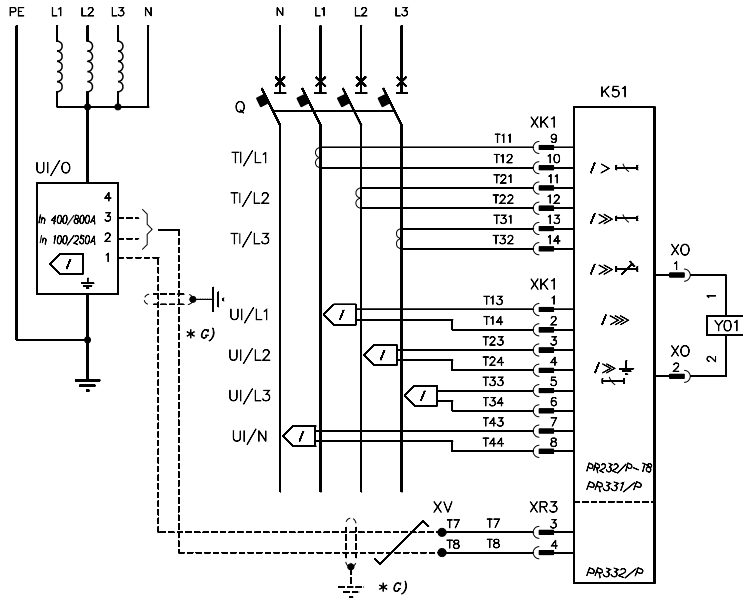

Four-pole circuit breaker with PR232/P-T8, PR331/P, or PR332/P electronic trip unit

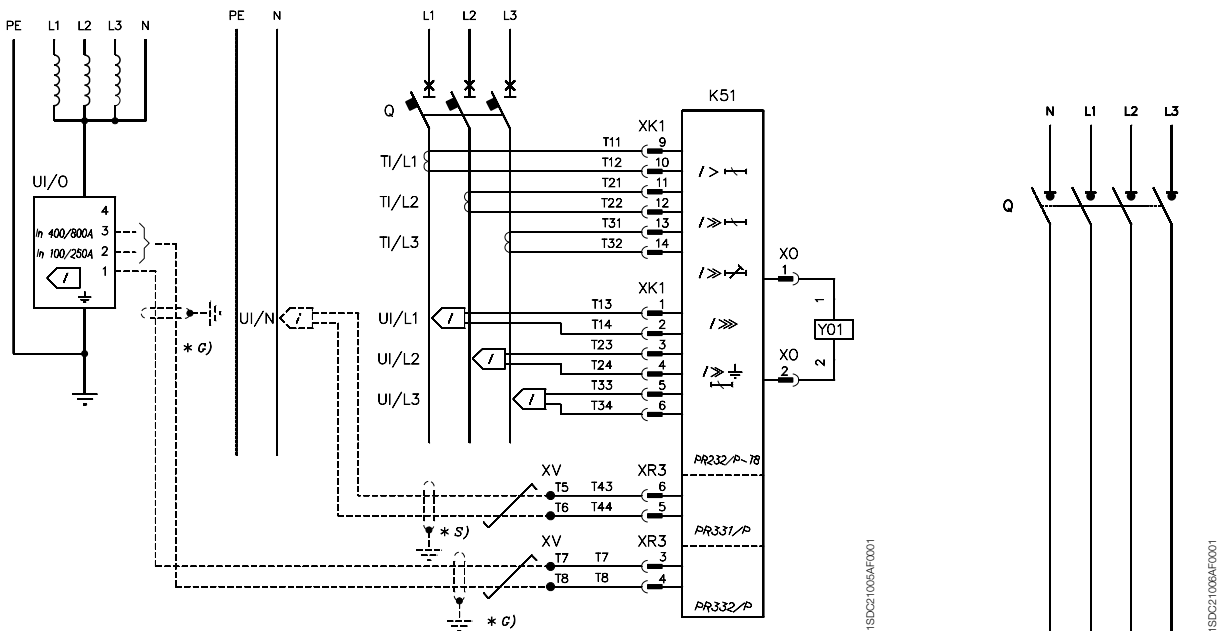

Three-pole circuit breaker with PR232/P-T8, PR331/P or PR332/P electronic trip unit

Three or four-pole MCS

Wiring diagrams

Electrical accessories for T8

Motor operator, shunt trip, closing coil and undervoltage release

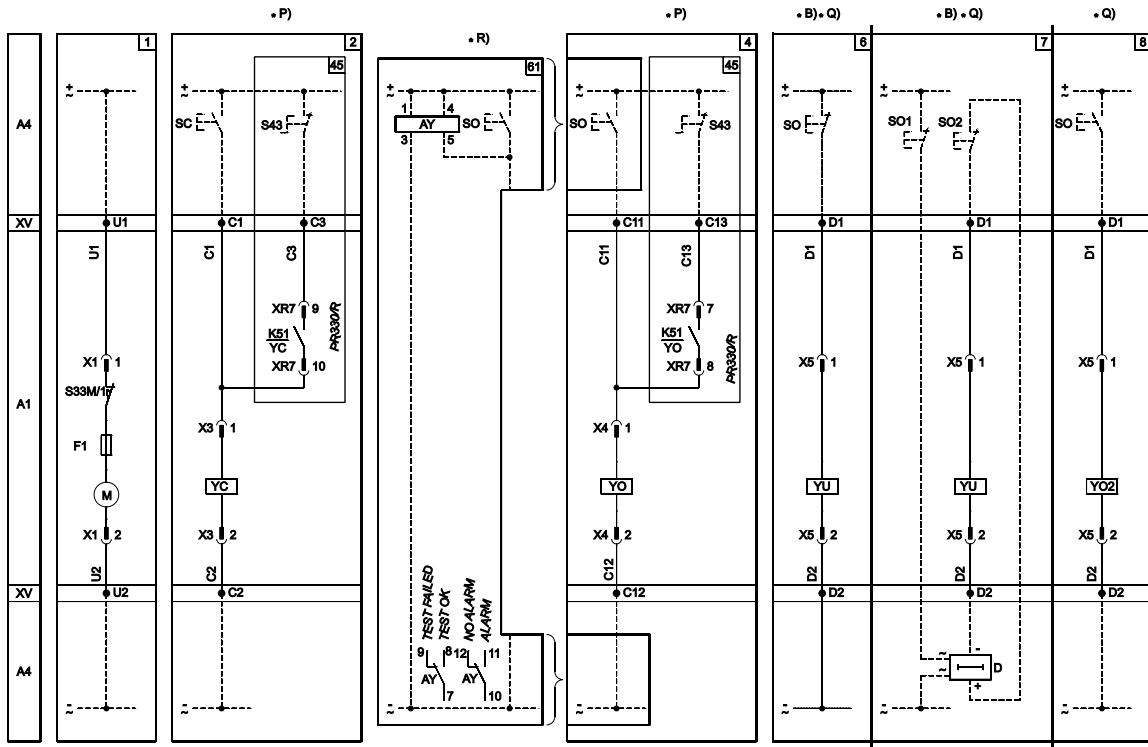

1SDC21007AF0001

Signalling contacts

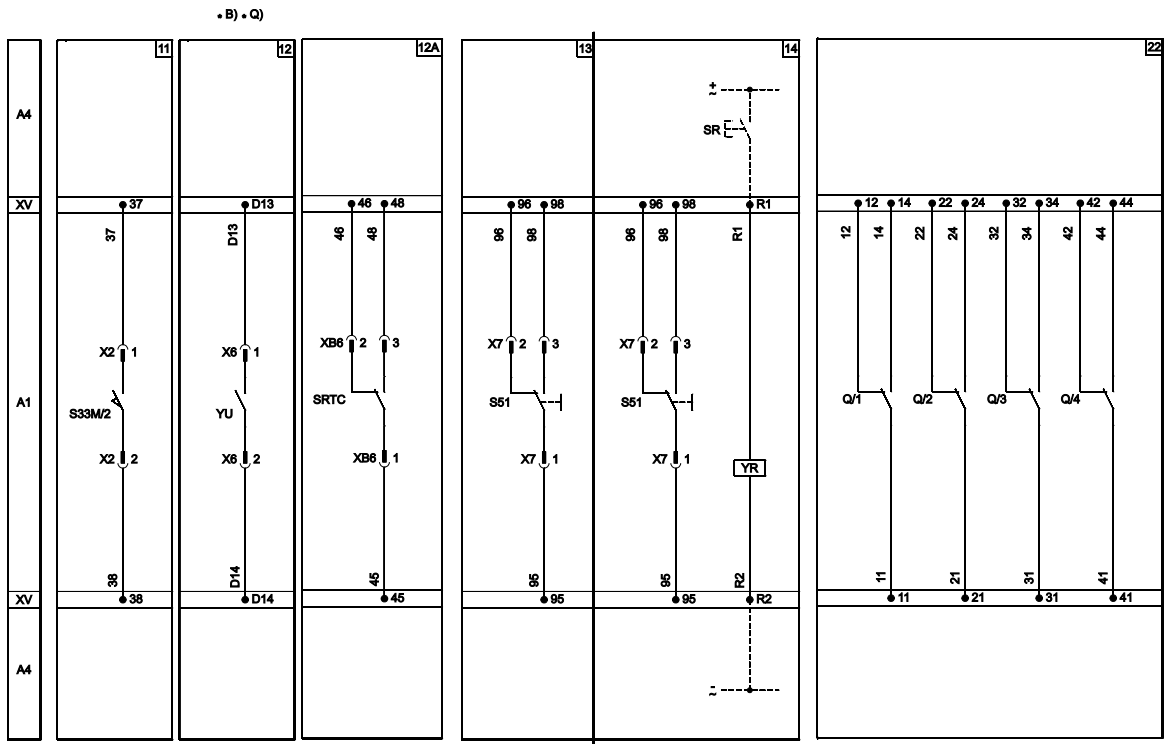

1SDC21008AF0001

Wiring diagrams

Auxiliary circuits for trip units

Auxiliary circuits of the PR331 and PR332 trip units

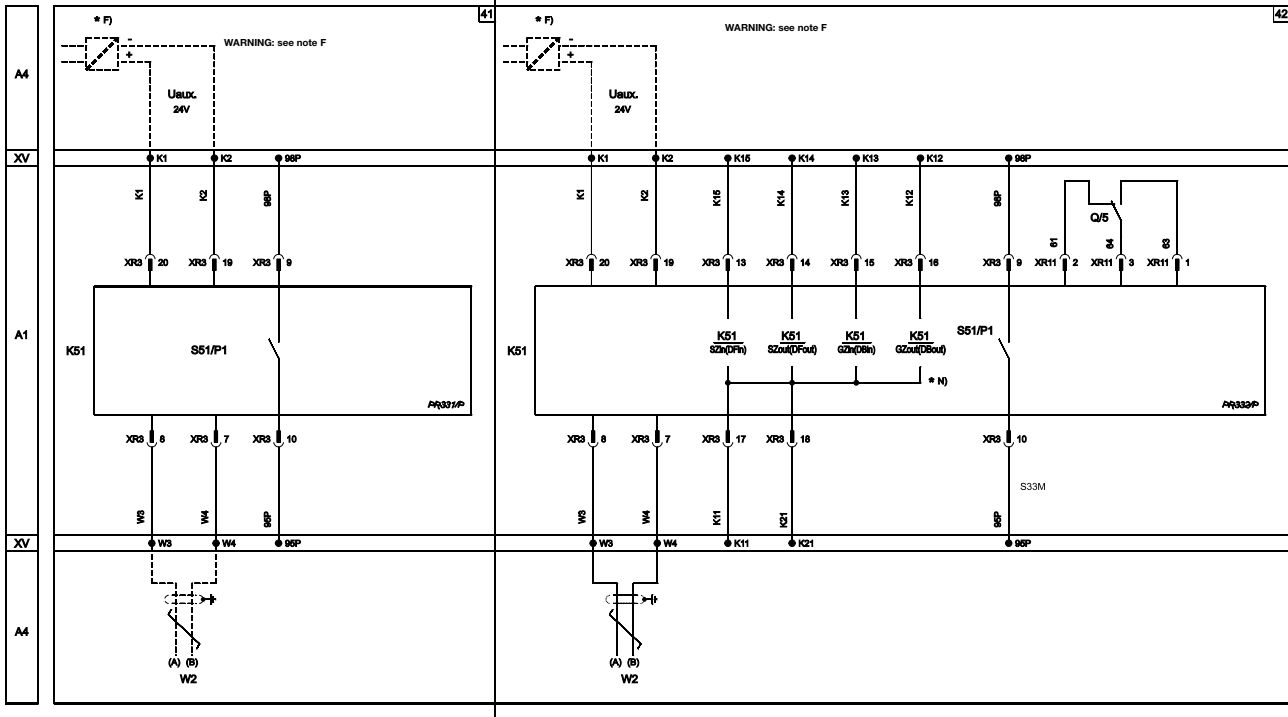

1SDC21009AF0001

Measuring module PR330/V-T8

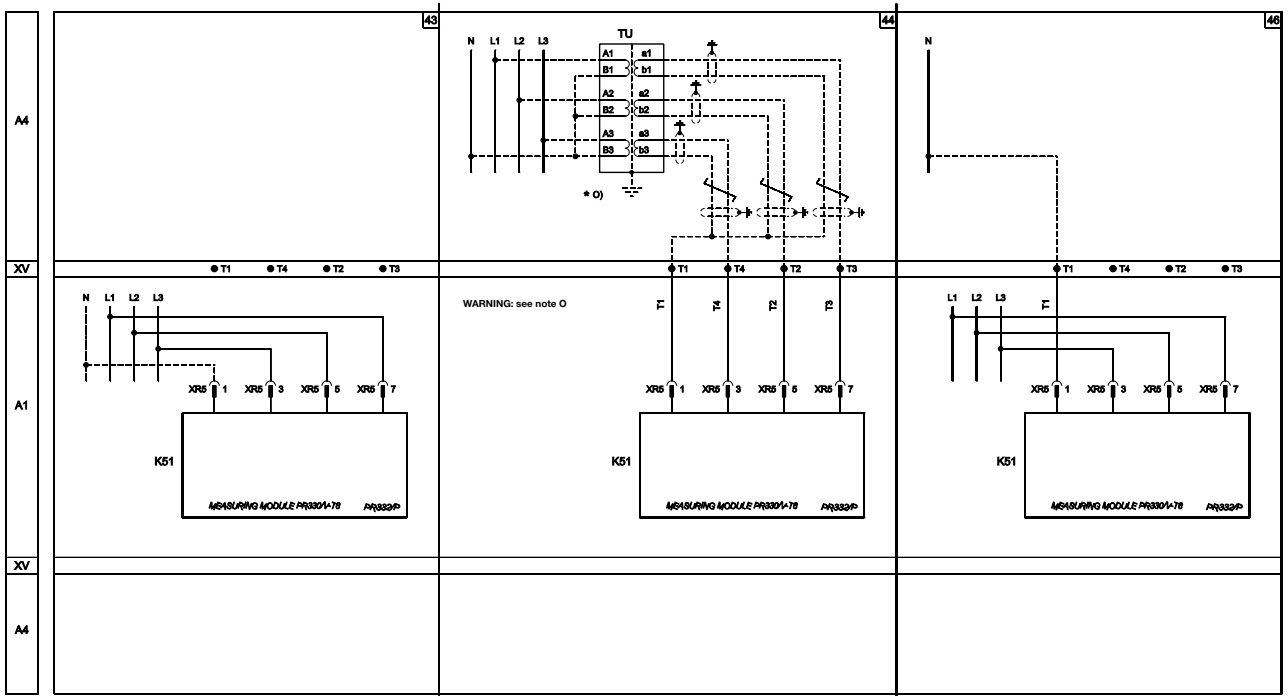

1SDC21010AF0001

Auxiliary circuits of the PR332 trip unit with communication module PR330/D-M connected to actuation unit PR330/R

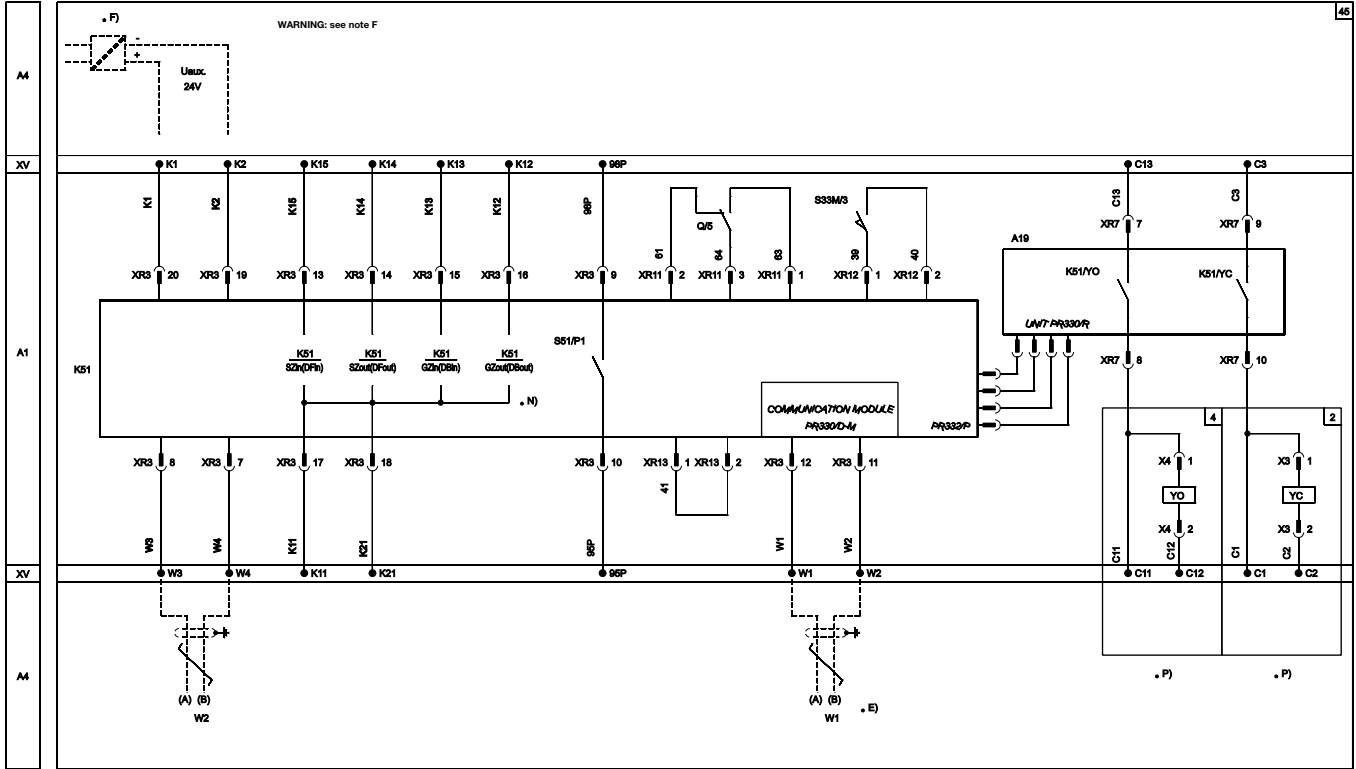

1SDC21011AF0001

PR021/K signaling unit

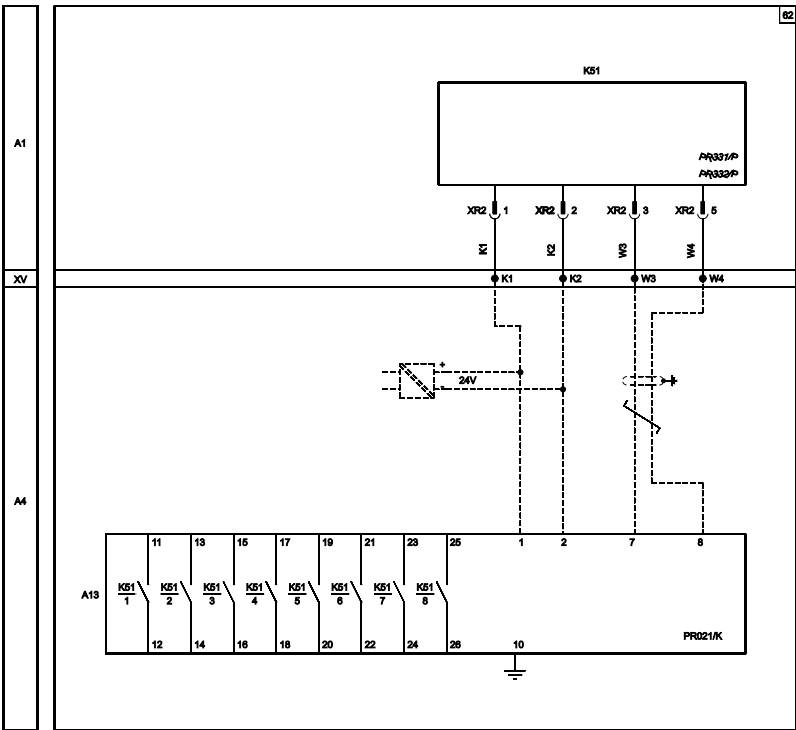

1SDC21012AF0001

Overall dimensions

Fixed circuit breaker - 1600/2000/2500 A

Front terminals - F

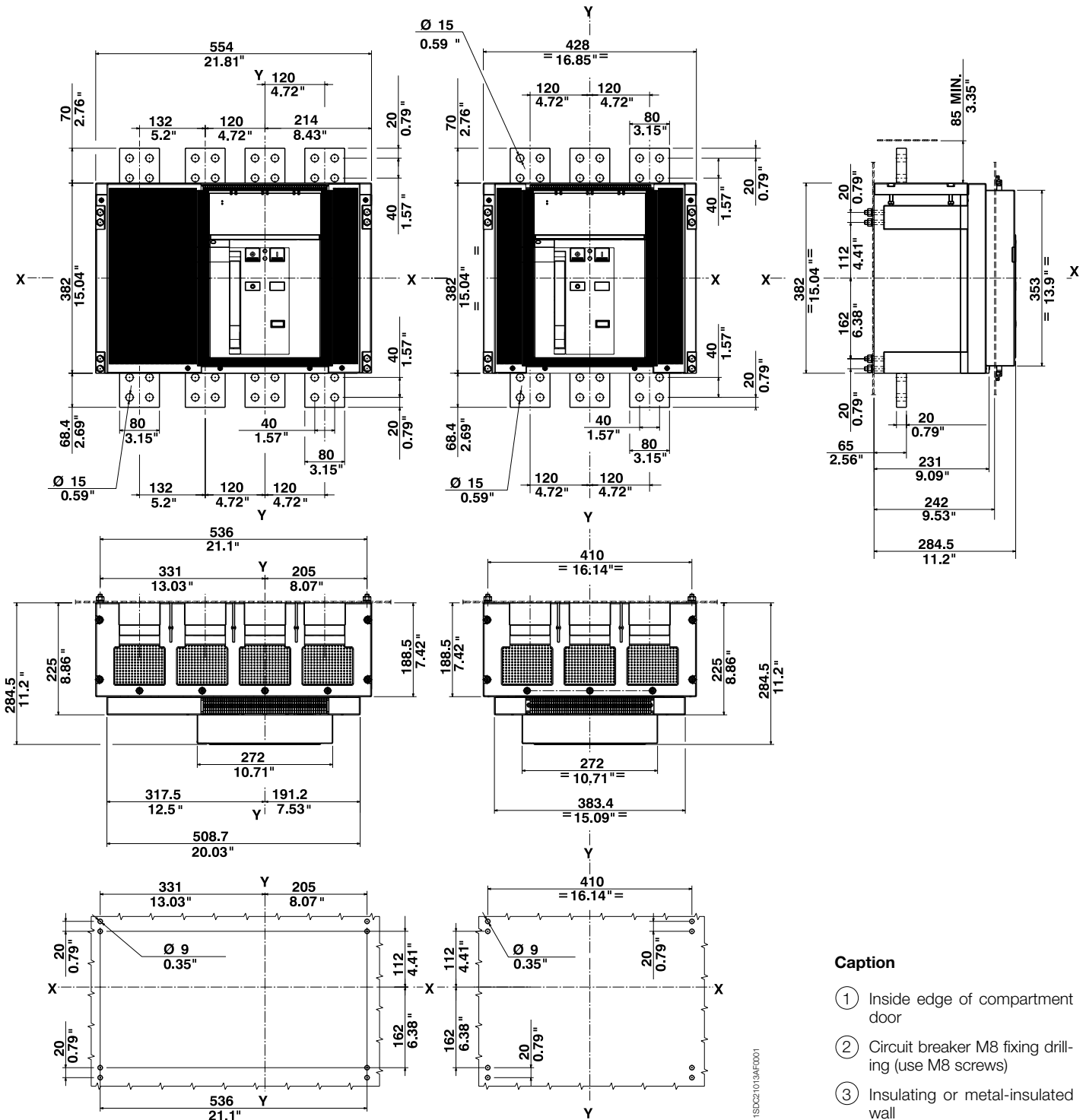

Fixed circuit breaker - 1600/2000/2500 A

Rear vertical terminals – VR

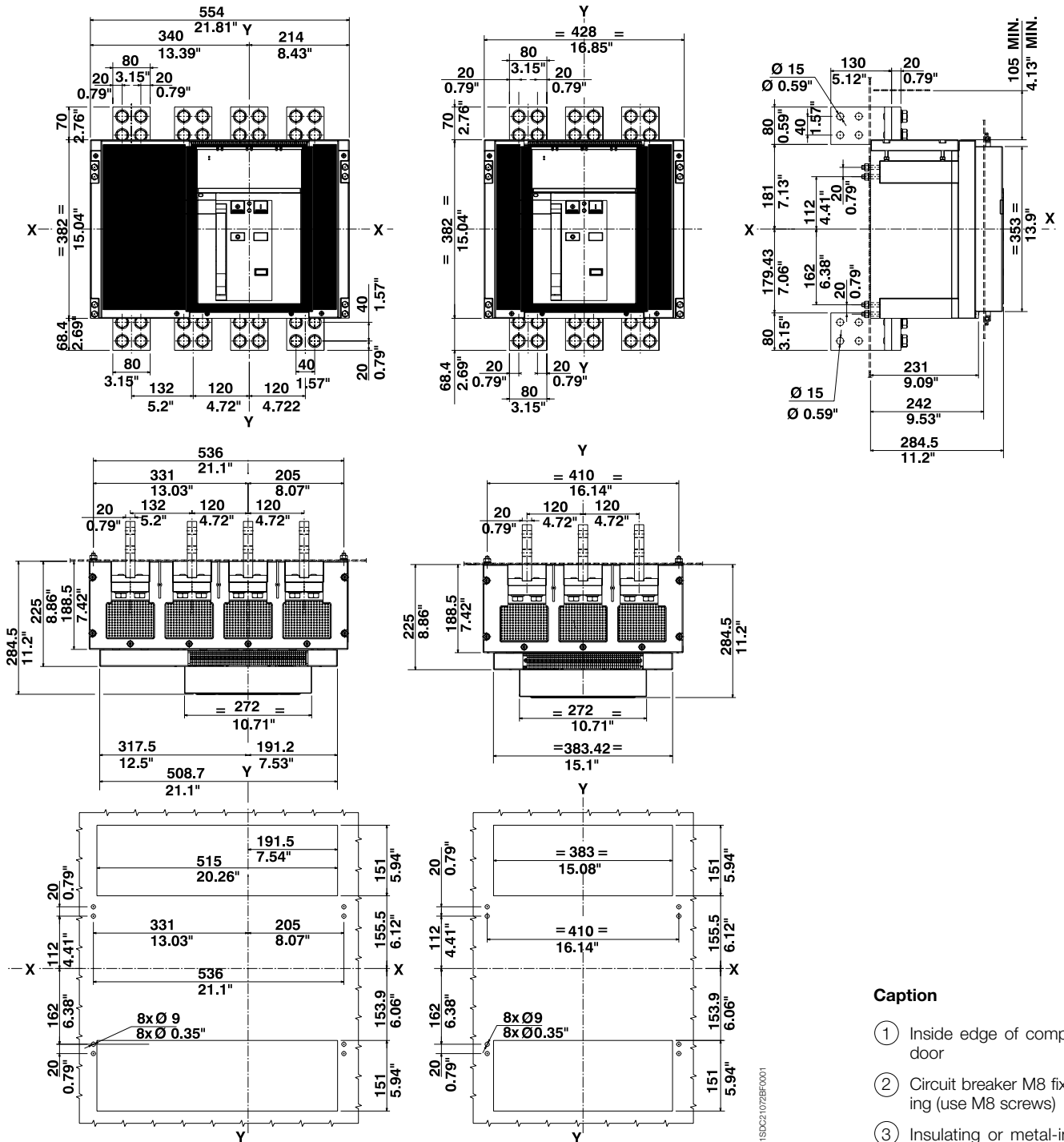

Caption

- ① Inside edge of compartment door
- ② Circuit breaker M8 fixing drilling (use M8 screws)
- ③ Insulating or metal-insulated wall

1SDC2107BFC001

Overall dimensions

Fixed circuit breaker - 3000 A

Rear vertical terminals - VR

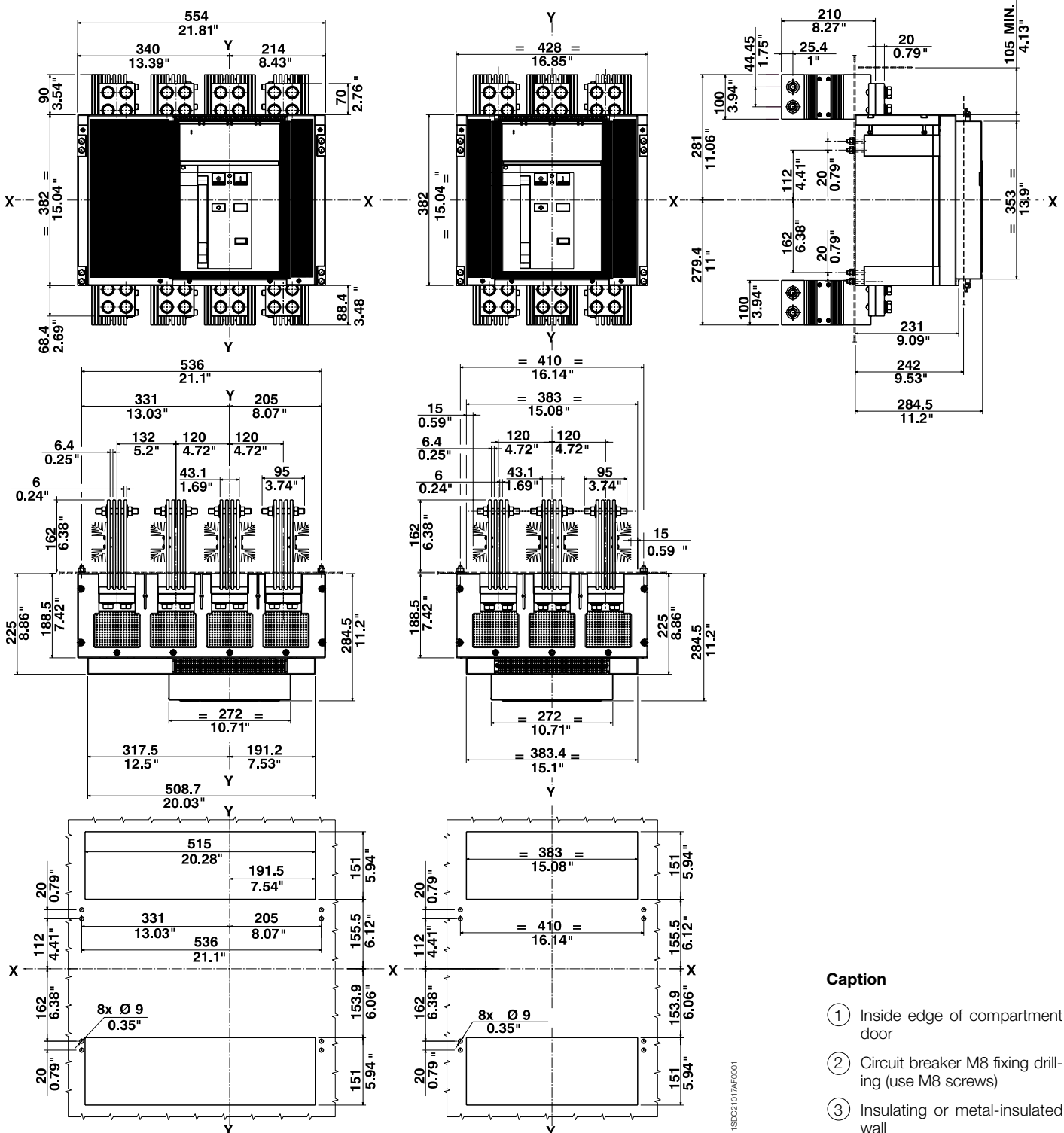

Caption

- ① Inside edge of compartment door
- ② Circuit breaker M8 fixing drilling (use M8 screws)
- ③ Insulating or metal-insulated wall

1SDC21017AF0001

Compartment door drilling

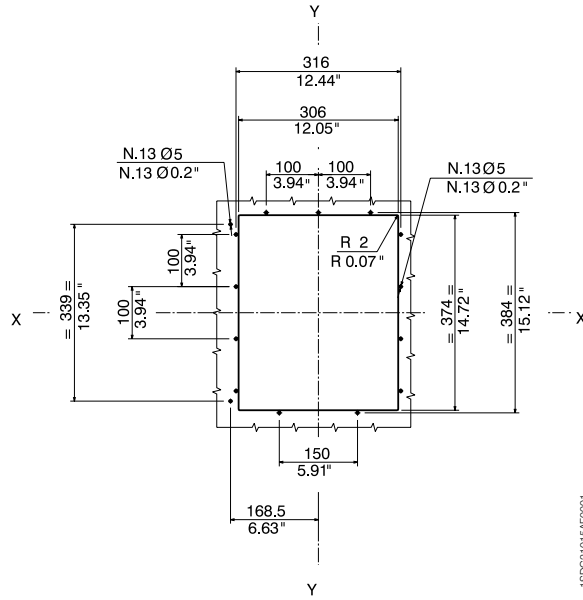

Overall dimensions

Distances to be respected

Insulation distances for installation in metallic cubicle

	A [mm - in]	B [mm - in]	C [mm - in]
T8	200 - 7.87	30 - 1.18	120 - 4.72

① For $U_b \geq 440$ V: distance A \Rightarrow 100 mm (3.94 inches)

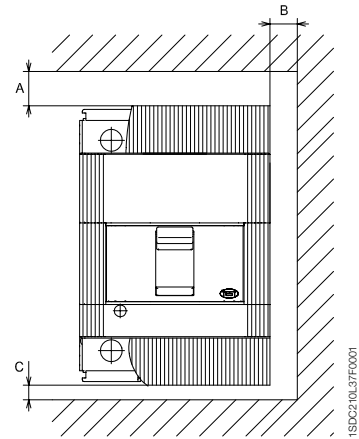

Minimum centre distance between two circuit breakers side by side or superimposed

For assembly side by side or superimposed, check that the connection busbars or cables do not reduce the air insulation distance

Minimum centre distance for two circuit breakers side by side

	Circuit breaker width [mm - in]		Centre distance I [mm - in]	
	3 Poles	4 Poles	3 Poles	4 Poles
T8	427 - 16.81	553 - 21.77	456 - 17.95	582 - 22.91

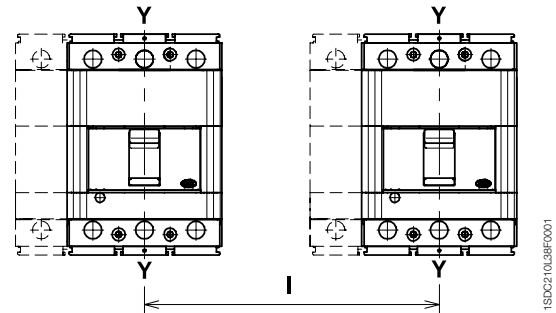

Minimum centre distance for superimposed circuit breakers

	H [mm - in]
T8	300 - 11.81

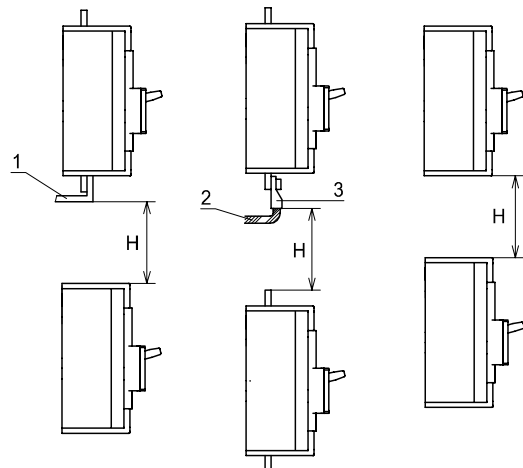

Caption

- ① Connection - not insulated
- ② Insulated cable
- ③ Cable terminal

Note: The dimensions shown apply for operating voltage U_b up to 690 V. The dimensions to be respected must be added to the maximum dimensions of the various different versions of the circuit breakers, including the terminals.

Ordering codes

Power distribution circuit breakers



T8 1600 – Fixed (F) – I_u (40 °C) = 1600 A - 3 Poles - Front terminals (F)

<i>Electronic trip unit</i>	In	I _{cu} (480 V)	1SDA R1	
			V	
			125 kA	
PR232/P-T8 LSI	1600		065856	
PR331/P LSIG	1600		065857	
PR332/P LI	1600		065858	
PR332/P LSI	1600		065859	
PR332/P LSIG	1600		065860	

T8 1600 – Fixed (F) – I_u (40 °C) = 1600 A - 4 Poles - Front terminals (F)

<i>Electronic trip unit</i>	In	I _{cu} (480 V)	1SDA R1	
			V	
			125 kA	
PR232/P-T8 LSI	1600		065861	
PR331/P LSIG	1600		065862	
PR332/P LI	1600		065863	
PR332/P LSI	1600		065864	
PR332/P LSIG	1600		065865	

T8 2000 – Fixed (F) – I_u (40 °C) = 2000 A - 3 Poles - Front terminals (F)

<i>Electronic trip unit</i>	In	I _{cu} (480 V)	1SDA R1	
			V	
			125 kA	
PR232/P-T8 LSI	2000		065876	
PR331/P LSIG	2000		065877	
PR332/P LI	2000		065878	
PR332/P LSI	2000		065879	
PR332/P LSIG	2000		065880	

T8 2000 – Fixed (F) – I_u (40 °C) = 2000 A - 4 Poles - Front terminals (F)

<i>Electronic trip unit</i>	In	I _{cu} (480 V)	1SDA R1	
			V	
			125 kA	
PR232/P-T8 LSI	2000		065881	
PR331/P LSIG	2000		065882	
PR332/P LI	2000		065883	
PR332/P LSI	2000		065884	
PR332/P LSIG	2000		065885	

Ordering codes

Power distribution circuit breakers

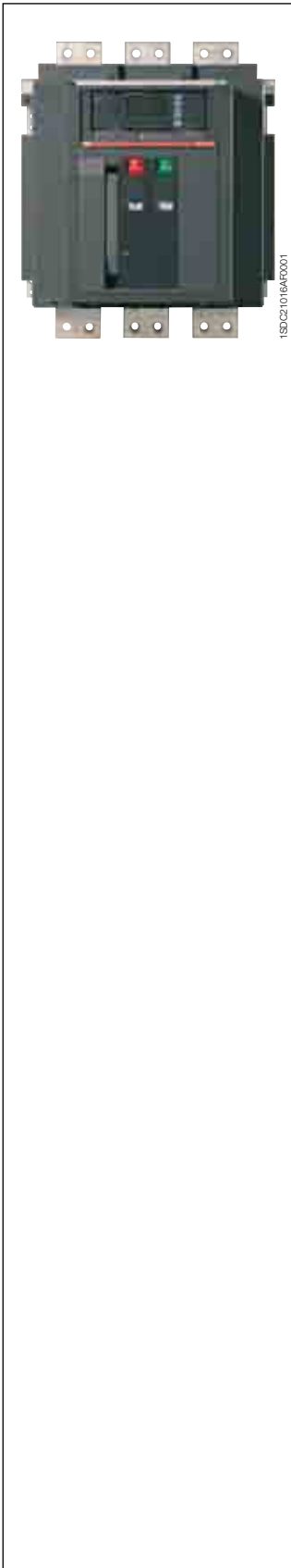

T8 2500 – Fixed (F) – I_n (40 °C) = 2500 A - **3 Poles** - Front terminals (F)

<i>Electronic trip unit</i>	In	Icu (480 V)	1SDA R1	
			V	
PR232/P-T8 LSI	2500		125 kA	
PR331/P LSI	2500		065886	
PR332/P LI	2500		065887	
PR332/P LSI	2500		065888	
PR332/P LSI	2500		065889	
PR332/P LSI	2500		065890	

T8 2500 – Fixed (F) – I_n (40 °C) = 2500 A - **4 Poles** - Front terminals (F)

<i>Electronic trip unit</i>	In	Icu (480 V)	1SDA R1	
			V	
PR232/P-T8 LSI	2500		125 kA	
PR331/P LSI	2500		065891	
PR332/P LI	2500		065892	
PR332/P LSI	2500		065893	
PR332/P LSI	2500		065894	
PR332/P LSI	2500		065895	

T8 3000 – Fixed (VR) – I_n (40 °C) = 3000 A - **3 Poles** - Rear vertical terminals (VR)

<i>Electronic trip unit</i>	In	Icu (480 V)	1SDA R1	
			V	
PR232/P-T8 LSI	3000		125 kA	
PR331/P LSI	3000		065866	
PR332/P LI	3000		065867	
PR332/P LSI	3000		065868	
PR332/P LSI	3000		065869	
PR332/P LSI	3000		065870	

T8 3000 – Fixed (VR) – I_n (40 °C) = 3000 A - **4 Poles** - Rear vertical terminals (VR)

<i>Electronic trip unit</i>	In	Icu (480 V)	1SDA R1	
			V	
PR232/P-T8 LSI	3000		125 kA	
PR331/P LSI	3000		065871	
PR332/P LI	3000		065872	
PR332/P LSI	3000		065873	
PR332/P LSI	3000		065874	
PR332/P LSI	3000		065875	

Ordering codes

Molded case switches

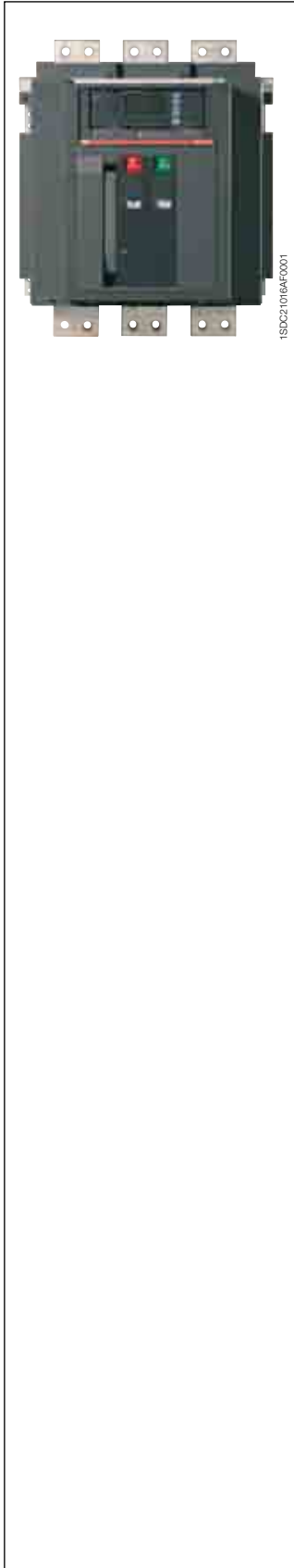

1SDC21016AF001

T8V-D 2000 – Fixed (F) – Iu (40 °C) = 2000 A - **4 Poles** - Front terminals (F)

		1SDA R1	
		3 Poles	4 Poles
	Icw	40 kA	40 kA
		065896	065897

Note: Ask ABB for availability.

T8V-D 2500 – Fixed (F) – Iu (40 °C) = 2500 A - **4 Poles** - Front terminals (F)

		1SDA R1	
		3 Poles	4 Poles
	Icw	40 kA	40 kA
		065898	065899

Note: Ask ABB for availability.

T8V-D 3000 – Fixed (VR) – Iu (40 °C) = 3000 A - Rear vertical terminals (VR)

		1SDA R1	
		3 Poles	4 Poles
	Icw	40 kA	40 kA
		065900	065901

Note: Ask ABB for availability.

Ordering codes

Loose trip units



1SDC210855F0001

Electronic trip unit

PR232/P-T8 LSI

PR331/P LSIG

PR332/P LI

PR332/P LSI

PR332/P LSIG

1SDA.....R1

065828

065829

065830

065831

065832

Note: The loose trip units for T8 are supplied without rating plug.

Ordering codes

Accessories



1SDC200131F0001

Service releases

Shunt trip (YO)

	1SDA.....R1
24 V DC	038286
30 V AC / DC	038287
48 V AC / DC	038288
60 V AC / DC	038289
110...120 V AC / DC	038290
120...127 V AC / DC	038291
220...240 V AC / DC	038292
240...250 V AC / DC	038293
380...400 V AC	038294
440 V AC	038295

Second shunt trip (YO2)

	1SDA.....R1
24 V DC	050157
30 V AC / DC	050158
48 V AC / DC	050159
60 V AC / DC	050160
110...120 V AC / DC	050161
120...127 V AC / DC	050162
220...240 V AC / DC	050163
240...250 V AC / DC	050164
380...400 V AC	050165
440 V AC	050166



1SDC200135F0001

SOR Test Unit

	1SDA.....R1
T8	050228



1SDC200132F0001

Closing coil (YC)

	1SDA.....R1
24 V DC	038296
30 V AC / DC	038297
48 V AC / DC	038298
60 V AC / DC	038299
110...120 V AC / DC	038300
120...127 V AC / DC	038301
220...240 V AC / DC	038302
240...250 V AC / DC	038303
380...400 V AC	038304
440 V AC	038305

Ordering codes

Accessories



1SDC200138F0001



1SDC200138F0001

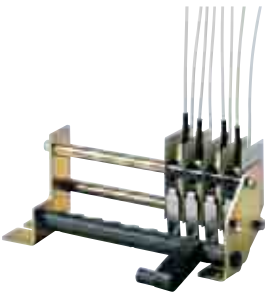

1SDC200145F0001



1SDC210NF9F0001

Undervoltage release (YU)

	1SDA.....R1
24 V DC	038306
30 V AC / DC	038307
48 V AC / DC	038308
60 V AC / DC	038309
110...120 V AC / DC	038310
120...127 V AC / DC	038311
220...240 V AC / DC	038312
240...250 V AC / DC	038313
380...400 V AC	038314
440 V AC	038315

Time-delay device for undervoltage release (D)

	1SDA.....R1
24...30 V AC / DC	038316
48 V AC / DC	038317
60 V AC / DC	038318
110...127 V AC / DC	038319
220...250 V AC / DC	038320

Electric signals

Auxiliary contacts

	1SDA.....R1
4 open/closed auxiliary contacts for PR232-T8/PR331	065971
4 open/closed auxiliary contacts for PR332 ⁽¹⁾	065819
4 open/closed auxiliary contacts V<24V for PR232-T8/PR331	065972
4 open/closed auxiliary contacts V<24V for PR332 ⁽¹⁾	065820
Bell alarm	058260
Contact signaling undervoltage release de-energized - NC	038341
Contact signaling undervoltage release de-energized - NO	038340

⁽¹⁾ **Note:** Always supplied with automatic circuit breakers.

Trip reset

	1SDA.....R1
Trip reset 24-30 V AC/DC	058263
Trip reset 110-130 V AC/DC	058262
Trip reset 200-240 V AC/DC	058261



1SDC21002F0001

1SDC200139F0001

1SDC200159F0001

1SDC200157F0001

1SDC200166F0001

1SDC2100139F0001

Mechanical signals

	1SDA.....R1
Mechanical operation counter	038345

Spring charging motor

	1SDA.....R1
Spring charging motor 24...30 V AC/DC	038321
Spring charging motor 48...60 V AC/DC	038322
Spring charging motor 100...130 V AC/DC	038323
Spring charging motor 220...250 V AC/DC	038324

Locks

	1SDA.....R1
Padlock	038351
Key lock - different keys	065998
Key lock - same keys (N. 20005)	065999
Key lock - same keys (N. 20006)	066000
Key lock - same keys (N. 20007)	066001
Key lock - same keys (N. 20008)	066002

Transparent protections

	1SDA.....R1
Transparent protection for pushbuttons	038343
Protection for door IP54	038344

Separating partitions

	1SDA.....R1
PB100 low (H=100 mm) - 2 pieces - 3p	066028
PB100 low (H=100 mm) - 3 pieces - 4p	066029
PB200 high (H=200 mm) - 2 pieces - 3p	066030
PB200 high (H=200 mm) - 3 pieces - 4p	066031

Note: For top terminals only.

Ordering codes

Accessories

Rear vertical terminals - VR

	1SDA.....R1	
	6 pieces	8 pieces
VR T8 2000 - 2500	046578	046579

Accessories for protection trip units

Modules for protection trip units PR331-PR332

	1SDA.....R1	
PR330/V-T8 - Voltage measuring module 3p	065834 ⁽¹⁾	
PR330/V-T8 - Voltage measuring module 4p	065973 ⁽¹⁾	
PR330/D-M - Communication module (Modbus RTU)	063145 ⁽¹⁾	
PR330/R - Actuation module	065821 ⁽¹⁾	
BT030 - External wireless communication module	058259	
PR030B - Power supply unit	058258	

⁽¹⁾ **Note:** Ask ABB for availability.

Current sensor for external neutral

	1SDA.....R1	
Current sensor for external neutral 1000 A...3000 A	065845	

Note: Ask ABB for availability.

Rating plug

	1SDA.....R1	
In = 1000 A	065983	
In = 1200 A	063851	
In = 1600 A	065987	
In = 2000 A	065988	
In = 2500 A	065989	
In = 3000 A	065837	

Extra code rating plug

	1SDA.....R1	
In = 1000 A	065986	
In = 1200 A	063584	
In = 1600 A	065990	
In = 2000 A	065991	
In = 2500 A	065992	

External units for protection trip units

	1SDA.....R1	
PR010/T - Test and configuration unit	048964	
PR021/K - Signaling unit	059146	
HMI030 - Switchgear interface	063143	

Spare parts

Flanges for compartment door

	1SDA.....R1
Flange for compartment door	065855



Due to possible developments of standards as well as of materials, the characteristics and dimensions specified in the present catalogue may only be considered binding after confirmation by ABB SACE.

1SDC210026D0201 - 10/2008
Printed in Italy
Tipografia

ABB SACE

A division of ABB S.p.A.

L.V. Breakers

Via Baioni, 35

24123 Bergamo, Italy

Tel.: +39 035.395.111 - Telefax: +39 035.395.306-433

<http://www.abb.com>