



PRODUCT RANGE

Precision. Motion Control. Technology.



Cone Drive is a world leader in precision motion control technology.

We work with our customers every step of the way – from design specs to the final solution – to create highly precise, highly specific products that keep our customers’ technology at the forefront of their industry. Cone Drive offers engineering support, unique solutions, and innovative technology across a breadth of markets and products to drive your company forward.



TABLE OF CONTENTS

PRODUCT RANGE

INTRO

THE CONE DRIVE ADVANTAGE	4-5
ONLINE CONFIGURATOR	6-8
SERVICE CENTER	9
PRODUCT RANGE	10-11

NEMA DRIVEN POWER

SERIES HP	12
SERIES HP-A	13
SERIES B	14
SERIES RG	15
SERIES F (STAINLESS STEEL)	16
STAINLESS STEEL MOTORS	17

SERVO DRIVEN POWER

SERIES W	18
SERIES HP	19
SERIES S	20
SERIES RG	21
SERIES FS (STAINLESS STEEL)	22

GEARSETS

HARMONIC SOLUTIONS

PLANETARIES

SLEWING SOLUTIONS

CUSTOMIZABLE SOLUTIONS

The Double-Enveloping Worm

A better choice for so many reasons.

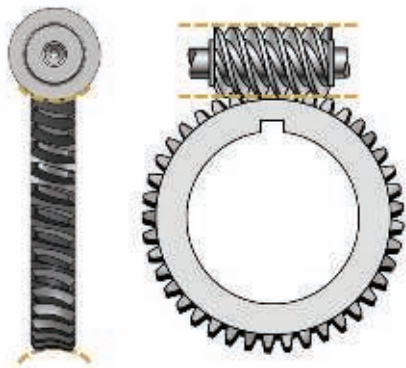

STANDARD CYLINDRICAL GEAR

Total load is concentrated to only one or two teeth

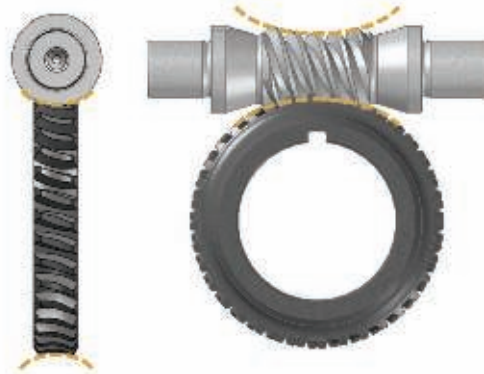

CONE DRIVE DOUBLE-ENVELOPING GEAR

Total load is distributed to more teeth along a greater surface area

CONE DRIVE DOUBLE-ENVELOPING TECHNOLOGY

In 1925, Samuel I. Cone developed a method to machine the double-enveloping worm gear. With Cone Drive's double-enveloping technology, the worm 'hugs' the gear creating greater surface contact, higher load capacity, lower contact stress, and greater shock capacity. This gives you the flexibility to decrease the size of a worm drive gearbox to save space or increase the motor to get more power.

EFFICIENCY WITH A POWERFUL DESIGN

Greater surface area contact means the load is distributed across more teeth allowing the worm gear reducer to run cooler, quieter, and more efficiently. Cone Drive worms are through hardened to further provide additional strength. An efficient design without sacrificing power means cost savings with no loss of performance.

SERVICE FACTOR SAVINGS

Cone Drive worm drive gearboxes allow you to maintain service factor levels in a smaller package. The ability to down size equates to space savings in your system and cost savings in your pocket. We publish ratings you can rely on, Cone Drive tests their ratings in accordance with the American Gear Manufacturers Association (AGMA) standards.

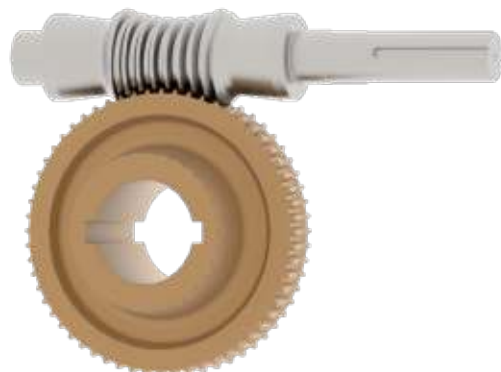

PRODUCT VARIETY

Cone Drive worm gearboxes cover a diverse spectrum of markets. We offer a wide range of hollow output bore options, including industry leading large bore sizes. If you are looking for a solution to a gearing application, Cone Drive has the answer and the product range to back it up.

LET'S TALK BEARINGS

We use two heavy duty roller bearings to provide dual support for the worm. The additional support increases the longevity of the worm gearbox which means less down time. Heavy duty bearings are used on the output shafts, which is excellent for applications that require high overhung loads. This not only simplifies the design, but lowers your cost.

WORM DRIVE GEARBOXES WITH POWER AND ACCURACY

The inherent accuracy and torsional stiffness of double-enveloping worm gearing keeps the deflection and torsional displacement low, which is exactly what you need for your most critical timing and indexing applications. For even further control, Cone Drive worm gears provide you with exact ratios, eliminating the problems posed by fractional units. We offer solutions with standard, low, and zero backlash worm gearsets.

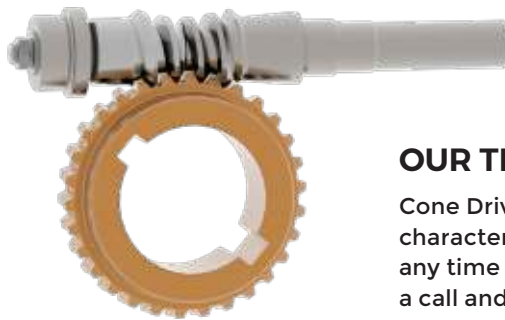

CUSTOM IS OUR SPECIALTY

Our experienced team of customer service representatives, application engineers, design engineers and manufacturing engineers are ready and willing to take on a challenge. Let us put our expertise to work and develop a solution customized to fit your needs. We can design and manufacture any type of worm drive gearbox application that you require.

CONE DRIVE QUALITY

- **QUALITY ENGINEERING:** We will design the right gearbox for your application and build it with the finest materials and components.
- **QUALITY MANUFACTURING:** We operate with a strict attention to detail and manufacture to exact tolerances and dimensions. Your gearbox will be built with precision and accuracy.
- **QUALITY SERVICE:** When you need assistance with installation, Cone Drive will be there to support you. We are fully committed to offering you service before and after the sale.

WE HAVE STOOD THE TEST OF TIME

For nearly 100 years, we have been making quality, durable worm gears. Our double-enveloping worm gearboxes drive equipment in mining, steel, aerospace, automotive, printing, packaging, and solar power world-wide. When you choose Cone Drive, you have the confidence of knowing that our many years of experience are behind every unit that we build.

OUR TEAM

Cone Drive has a team of highly qualified, high character individuals to help if you have questions at any time throughout the purchasing process. Give us a call and we will offer dedicated, personal support to help get you started and identify what product will best fit your application.



Configure Your Cone Drive Product Online

www.ConeTools.com

Cone Drive's Product Configurator provides multiple tools and resources to offer guidance throughout your product selection process.

The screenshot displays the Cone Drive website's product configurator interface, organized into several sections:

- NEMA DRIVEN: RIGHT ANGLE WORM GEARBOX SOLUTIONS**
 - GETTING STARTED: COMPARE NEMA DRIVEN PRODUCT SPECIFICATIONS
 - NEMA COMPETITOR INTERCHANGE: INTERCHANGE COMPETITOR UNIT WITH SERIES B OR SERIES E
 - Series HP: CONFIGURE
 - Series RG: CONFIGURE
 - Series HP-A: CONFIGURE
 - Series B: CONFIGURE
 - Series F Stainless Steel: CONFIGURE
- SERVO DRIVEN: RIGHT ANGLE WORM GEARBOX SOLUTIONS**
 - GETTING STARTED: COMPARE SERVO DRIVEN PRODUCT SPECIFICATIONS
 - SERVO SELECTOR: BUILD GEARBOX BASED ON SERVO MOTOR SELECTION
 - Series W: CONFIGURE
 - Series RG: CONFIGURE
 - Series HP: CONFIGURE
 - Series S: CONFIGURE
 - Series FS Stainless Steel: CONFIGURE
- INLINE SOLUTIONS**
 - Harmonic Solutions: CONFIGURE
 - Planetary Drives: CONFIGURE
- SLEWING SOLUTIONS**
 - Slew Drives: CONFIGURE
 - Slew Bearings: CONFIGURE
- NEED ASSISTANCE?**
 - Toll Free: 1-888-994-2663
 - International Tel: +1-231-946-8410
 - Customizations and IEC motor adaptations available
 - Contact sales@conedrive.com for additional information regarding your specific application needs.

Available Tools

View comparison chart of high level specs for NEMA driven products

View comparison chart of high level specs for Servo driven products



GETTING STARTED:
COMPARE NEMA DRIVEN PRODUCT SPECIFICATIONS

Product	Series HP	Series HP-A	Series B	Series RC	Series F
Size	130-220 mm	102-220 mm	133-154 mm	14-22 mm	23-76 mm
Construction	Cast Iron	Cast Iron	Aluminum	Cast Iron	316 Stainless Steel
Ratio	61-34,000	61-703	61-6,000	61-6,000	61-6,000
Output Torque (Constant Speed)	~ 2,900 (lb-in)	~ 883 (lb-in)	~ 6,370 (lb-in)	~ 10,883 (lb-in)	~ 1,950 (lb-in)
Shock Load Capacity	High	High	Medium	High	Medium
IP Rating	N/A	N/A	IP 55	IP 55	IP 65
Warranty	5 Year	5 Year	2 Year	5 Year	5 Year

GETTING STARTED:
COMPARE SERVO DRIVEN PRODUCT SPECIFICATIONS

Product	Series W	Series HP	Series S	Series RC	Series FS
Size	38-20 mm	51-80 mm	133-154 mm	13-22 mm	23-76 mm
Construction	Aluminum	Cast Iron	Aluminum	Cast Iron	316 Stainless Steel
Nominal Backlash Range	0-24 arcmin	0-25 arcmin	0-40 arcmin	4-27 arcmin	4-27 arcmin
Ratio	61-603	61-703	61-401	61-401	61-603
Output Torque (Constant Speed)	~ 12,900 (lb-in)	~ 9,100 (lb-in)	~ 6,370 (lb-in)	~ 10,883 (lb-in)	~ 6,380 (lb-in)
Output Torque (Acceleration)	~ 8,700 (lb-in)	~ 12,000 (lb-in)	~ 7,540 (lb-in)	~ 11,700 (lb-in)	~ 6,380 (lb-in)
IP Rating	IP 65	IP 65	IP 55	IP 55	IP 65
Warranty	5 Year	5 Year	2 Year	5 Year	5 Year

Select a Cone Drive replacement for competitor unit

Filter available Cone Drive units by servo motor selection



NEMA COMPETITOR INTERCHANGE:
INTERCHANGE COMPETITOR UNIT WITH SERIES B OR SERIES F

Competitor Interchange Tool

Select in Name

To determine the interchange, select your Boston model number from the drop down boxes.

Reducer BMMW Part:

Output Shaft Style:

Input Shaft Style:

Shaft Mounting Attachment:

Substrator:

Brakes or Taps:

Went:

Oil Seal:

Motor Flange:

Output Shaft:

Mounting Position:

Output Size:

Input Speed:

Reducer BMMW Part:

Output Shaft Style:

Input Shaft Style:

Shaft Mounting Attachment:

Substrator:

Brakes or Taps:

Went:

Oil Seal:

Motor Flange:

Output Shaft:

Mounting Position:

Output Size:

Input Speed:

Available:

Ratio:

Output Shaft:

Motor Flange:

Mounting Position:

Output Size:

Input Speed:

SERVO SELECTOR:
BUILD GEARBOX BASED ON SERVO MOTOR SELECTION

Servo Selector

Brand: [Select]

Model: [Select]

Reducer Selection

Selected Reducers:

Reducer Size

Selected Reducer Size: [Select] Selected Ratio: [Select] Selected Input Speed: [Select]

Reducer Features

Specifications and 3D

Build a Gearbox to Fit Your Specific Needs

CONFIGURE

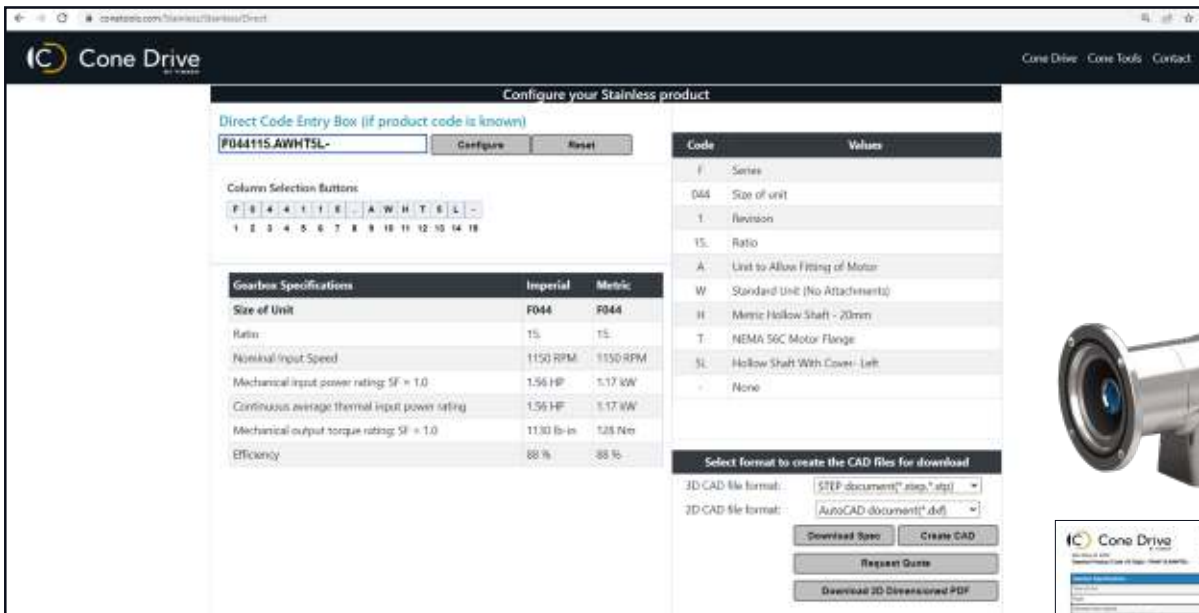
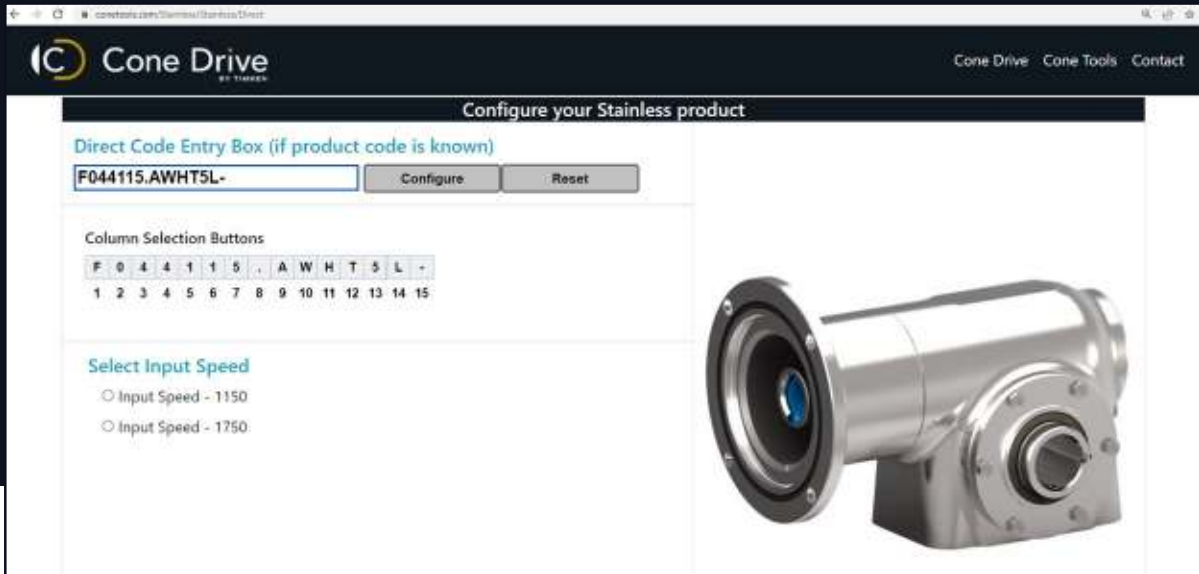

Download specifications, models, and submit your customized unit to Cone Drive for a quote.



Cone Drive **Service Center**

Whether you are interested in a partial or complete rebuild, extended service contract, or on-site service, we are ready to answer your call. Rebuild it with the people who know it best. It doesn't matter if your gearbox has been in service for 5 years or 25 years, we will rebuild it with Cone Drive approved parts and workmanship that you have come to trust.

SERVICES WE PROVIDE

- Remanufacturing and Repair
- Preventative Maintenance Plans
- Video Scope Inspection
- Inspection Reports
- Oil Analysis
- Technical Assistance
- Spare Parts Sales
- Rebuilds with Warranty
- Reverse Engineering & Manufacture
- Field Service



FIND MORE INFORMATION AT www.ConeTools.com

SERVICE CENTER

— C A P A B I L I T I E S —

- Storage maintenance of customer transmissions
- Complete test facility, with bearing & sump temperature monitoring
- Inspection and reverse engineering services, using the latest technology provided by the FARO Edge portable CMM





(Page 12)



(Page 13)



(Page 14)



(Page 15)



(Page 16)

PRODUCT	SERIES HP	SERIES HP-A	SERIES B	SERIES RC	SERIES F
Size	1.50 - 28 in	100 - 200 mm	1.33 - 3.54 in	1.5 - 3.5 in	39 - 76 mm
Construction	Cast Iron	Cast Iron	Aluminum	Cast Iron	316 Stainless Steel
Ratio	5:1 - 343,000:1	5:1 - 70:1	5:1 - 3,600:1	5:1-600:1	5:1 - 600:1
Output Torque (Constant Speed)	2,900,000 lb-in	88,100 lb-in	6,370 lb-in	10,800 lb-in	5,950 lb-in
Shock Load Capacity	High	High	Moderate	High	Moderate
IP Rating	N/A	N/A	IP 55	IP 65	IP 69k
Warranty	5 Year	5 Year	2 year	5 year	5 Year

ADDITIONAL PRECISION PRODUCTS



GEARSETS

(Page 23)



HARMONIC SOLUTIONS

(Page 24)



IN-LINE PLANETARIES

(Page 25)



(Page 18)



(Page 19)



(Page 20)



(Page 21)



(Page 22)

PRODUCT	SERIES W	SERIES HP	SERIES S	SERIES RC	SERIES FS
Size	38-89 mm	3.0-8.0 in	1.33-3.54 in	1.5-3.5 in	39-76 mm
Construction	Aluminum	Cast Iron	Aluminum	Cast Iron	316 Stainless Steel
Nominal Backlash	0-24 arcmin	2-35 arcmin	12-41 arcmin	4-27 arcmin	4-27 arcmin
Ratio	5:1-60:1	5:1-70:1	5:1-60:1	5:1-60:1	5:1-60:1
Output Torque (ConstantSpeed)	≤ 10,800 lb-in	≤ 97,100 lb-in	≤ 6,370 lb-in	≤ 10,800 lb-in	≤ 5,950 lb-in
Output Torque (Acceleration)	≤ 11,700 lb-in	≤ 121,000 lb-in	≤ 7,540 lb-in	≤ 11,700 lb-in	≤ 6,380 lb-in
IP Rating	IP 65	N/A	IP 55	IP 65	IP 69k
Warranty	5 year	5 Year	2 year	5 year	5 Year



SLEWING SOLUTIONS

(Page 26)



SOLAR & SATELLITE TRACKING

(Page 27)



DUODRIVES

(Page 27)

NEMA DRIVEN POWER SERIES HP

Cone Drive's Series HP is designed with high torque in mind. Our industry leading right angle, double-enveloping worm gear technology is perfect for applications that require extremely high torque and precision in a quiet, compact package. Since 1935, the Cone Drive Series HP has been excelling at meeting our customers' high power needs.

FOOD & BEVERAGE | PACKAGING | METALS & MINING | OIL & GAS | PAPER & PULP

MADE IN
USA

HIGH POWER

- Double-enveloping worm gearing supported with two input bearings
- Low or standard backlash
- Vented, cast iron construction
- Triple reductions can produce almost 3 million lb-in of torque
- Wide range of sizes
- Best in class lead times
- 5 year warranty



CONFIGURE & DOWNLOAD YOUR MODEL AT www.ConeTools.com

SERIES HP

— S P E C I F I C A T I O N S —

Center Distance: 1.50 thru 28 in

Ratio: 5:1 thru 343,000:1

Reductions: Single, double, triple

Output Torque (ConstantSpeed): $\leq 2,900,000$ lb-in

Orientation: Worm over gear, worm under gear, vertical gearshaft

Input Shaft: Single or double extended

Output Shaft: Solid (single or double extended), hollow

Cooling: Fan or water cooled

Configurations: Reducer, NEMA flange, D-Flange motor (helical worm)

NEMA DRIVEN POWER SERIES HP-A

The Series HP-A gearbox features the high performance and dependability of Cone Drive's double enveloping worm gearing in a metric, universal housing. Offering features ideal for the processing and material handling markets, the Cone Drive Series HP-A gearbox provides high torque in a compact package.

FOOD & BEVERAGE | PACKAGING | METALS & MINING | OIL & GAS | PAPER & PULP

MADE IN
USA

ALTERNATIVE METRIC DESIGN

- Double-enveloping worm gearing supported with two input bearings
- Low or standard backlash
- Cast iron construction
- Universal housing with optional drywell feature
- Competitive OEM pricing
- Best in class lead times
- 5 year warranty

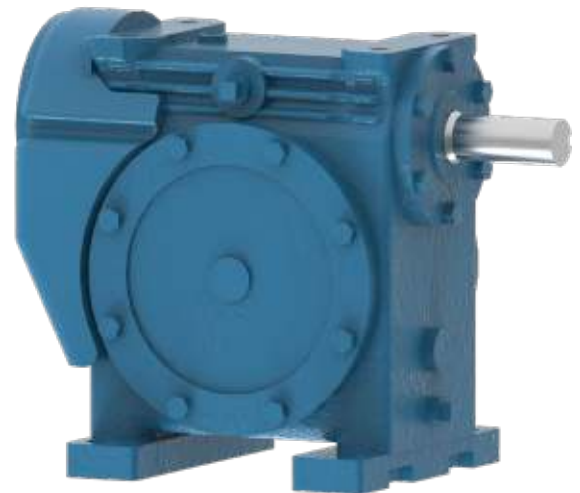

CONFIGURE & DOWNLOAD YOUR MODEL AT www.ConeTools.com

SERIES HP-A

— S P E C I F I C A T I O N S —

Center Distance: 100 thru 200 mm

Ratio: 5:1 thru 70:1

Reductions: Single

Output Torque (ConstantSpeed): $\leq 88,100$ lb-in

Orientation: Worm over gear, worm under gear, vertical gearshaft

Input Shaft: Inch or metric, single or double extended

Output Shaft: Inch or metric, solid (single or double extended), hollow

Additional Options: Fan cooled, double oil seals, viton seals, drywell feature

NEMA DRIVEN POWER SERIES B

The Series B gearbox is a highly flexible and economical right angle gearing solution. Directly interchangeable with competitor reducers, the Series B features a lightweight aluminum housing which provides improved thermal performance. No other reducers offer the flexibility, performance, and reliability that you expect from Cone Drive.

PACKAGING | PLASTICS & RUBBER | STEEL | CONVEYOR | PULP & PAPER

MADE IN
USA

ADAPTABLE POWER

- Conex proprietary worm gearing supported with two input bearings
- Lightweight, aluminum construction
- Non-fretting motor connection
- USDA white epoxy paint available
- Optional washdown design
- Best in class lead times
- 2 year warranty



CONFIGURE & DOWNLOAD YOUR MODEL AT www.ConeTools.com

SERIES B

— S P E C I F I C A T I O N S —

Center Distance: 1.33 thru 3.54 in

Ratio: 5:1 thru 3,600:1

Reductions: Single or double

Output Torque (ConstantSpeed): $\leq 6,370$ lb-in

Available Versions: Optional horizontal or vertical base, output bracket, torque arm

Input Shaft: Solid, single extended

Output Shaft: Solid (single or double extended), hollow

Lubricant: Factory filled with synthetic lubricant

I.P. Rating: IP 55

NEMA DRIVEN POWER SERIES RG

The Series RG gearbox is an adaptable solution for mid range power applications. Available with single or double reduction, the Series RG is designed with Cone Drive's double-enveloping worm gear technology and offers multiple output options. Tapered roller output bearings provide the capacity required to handle heavy overhung loads.

PACKAGING | PLASTICS & RUBBER | STEEL | CONVEYOR | PULP & PAPER

MADE IN
USA

RUGGED PERFORMER

- Double-enveloping worm gearing supported with two input bearings
- Low or standard backlash
- Cast iron construction
- High efficiency double reduction in single right angle configuration
- White epoxy or stainless steel paint available
- Best in class lead times
- 5 year warranty



CONFIGURE & DOWNLOAD YOUR MODEL AT www.ConeTools.com

SERIES RG

— S P E C I F I C A T I O N S —

Center Distance: 1.5 thru 3.5 in

Ratio: 5:1 thru 600:1

Reductions: Single or double

Output Torque (ConstantSpeed): $\leq 10,800$ lb-in

Motor Connection: Integrated spider coupling (single reduction), Non-fretting bushing (double reduction)

Input Shaft: Single or double extended

Output Shaft: Inch or metric, solid (single or double extended), hollow, shrink disc, mounting flange

Lubricant: Factory filled with synthetic lubricant

I.P. Rating: IP 65

NEMA DRIVEN POWER SERIES F STAINLESS STEEL

The Series F Stainless Steel gearbox provides you Cone Drive's gearing technology in a stainless steel package. The smooth contours of the housing allow fluids to wick away preventing bacteria from forming on the surface. When your application demands strict hygienic performance, look no further than Cone Drive's stainless steel Series F gearbox.

FOOD & BEVERAGE | PACKAGING | PHARMACEUTICAL | MEAT & DAIRY | MIXERS

MADE IN
USA

STAINLESS STEEL TORQUE

- Double-enveloping worm gearing supported with two input bearings
- Low or standard backlash
- 316 stainless steel adapter and housing
- Adheres to strict NSF and A3 hygienic standards and carries an ingress protection rating of IP69k
- High efficiency double reduction in single right angle configuration
- Optional torque arm, flange, or side mounting available
- Best in class lead times
- 5 year warranty



CONFIGURE & DOWNLOAD YOUR MODEL AT www.ConeTools.com

SERIES F

— S P E C I F I C A T I O N S —

Center Distance: 39 thru 76 mm

Ratio: 5:1 thru 600:1

Reductions: Single or double

Output Torque (ConstantSpeed): $\leq 5,950$ lb-in

Motor Connection: Non-fretting bushing

Input Shaft: Single or double extended

Output Shaft: Inch or metric, solid (single or double extended), hollow, shrink disc

Lubricant: Factory filled with food grade lubricant

I.P. Rating: IP 69K

NEMA DRIVEN POWER MOTORS

In addition to ordering your Series F Stainless Steel gearbox, Cone Drive offers the convenience of bundling a stainless steel motor with your purchase. TECO-Westinghouse motors are specifically designed for the rugged and demanding environments required for washdown applications.



FOOD & BEVERAGE | PACKAGING | PHARMACEUTICAL | MEAT & DAIRY | MIXERS

STAINLESS STEEL POWER

HP	FRAME	PART NUMBER	
		FAN COOLED	NON VENTED
0.5	56C	WFPV0/54C	WFNV0/54C
0.75	56C	WFPV0/74C	WFNV0/74C
1	56C	WFPV0014C	WFNV0014C
1.5	56C	WFPV1/54C	WFNV1/54C
2	56C	WFPV0024C	WFNV0024C
3	182TC	WPV0034C	WNV0034C
5	184TC	WPV0054C	-



CONFIGURE & DOWNLOAD YOUR MODEL AT www.ConeTools.com

NON VENTED & FAN COOLED

— SPECIFICATIONS —

Frame Sizes: 56C, 182/184TC

Horsepower: 0.5 - 5.0 hp

Voltage: 230/460 V

Style: C-Face, Non Footed

Phase: 3 Phase

Ingress Protection: IP 66

SERVO DRIVEN POWER SERIES W

The Series W is Cone Drive's highest precision right angle solution. The Series W has a compact, anodized aluminum housing. The design offers high torsional rigidity and is capable of speeds of up to 6,000 rpm. Quiet and smooth running, the Series W features Cone Drive's double enveloping worm gear technology with optional zero backlash.

PACKAGING | FOOD & BEVERAGE | SATELLITE COMMUNICATION | AUTOMATION & ROBOTICS

MADE IN
USA

ULTIMATE PRECISION

- Double-enveloping worm gearing supported with two input bearings
- Zero, low, or standard backlash
- Aluminum housing
- Angular contact ball bearings (worm shaft)
- Zero backlash bellows style coupling
- Best in class lead times
- 5 year warranty



CONFIGURE & DOWNLOAD YOUR MODEL AT www.ConeTools.com

SERIES W

— S P E C I F I C A T I O N S —

Center Distance: 38 thru 89 mm

Ratio: 5:1 thru 60:1

Nominal Backlash: 0 - 24 arcmin

Output Torque (ConstantSpeed): $\leq 10,800$ lb-in

Output Torque (Acceleration): $\leq 11,700$ lb-in

Input Shaft: Single or double extended

Output Shaft: Solid (single or double extended), Hollow, Shrink Disc

Lubricant: Factory filled with synthetic lubricant

I.P. Rating: IP 65

SERVO DRIVEN POWER SERIES HP

The Series HP - Servo gearbox is designed with power and precision in mind. Cone Drive's industry leading right angle, double-enveloping gearboxes are made for applications that require high torque and motion control in a quiet, compact package. The Series HP - Servo is ready to deliver the performance and accuracy you need.

FOOD & BEVERAGE | PACKAGING | AUTOMATION & ROBOTICS | AEROSPACE | DEFENSE

MADE IN
USA

HIGH POWER PRECISION

- Double-enveloping worm gearing supported with two input bearings
- Low or standard backlash
- Vented, cast iron housing
- Bellows or jaw style coupling
- Best in class lead times
- 5 year warranty



CONFIGURE & DOWNLOAD YOUR MODEL AT www.ConeTools.com

SERIES HP

— SPECIFICATIONS —

Center Distance: 3.0 thru 8.0 in

Ratio: 5:1 thru 70:1

Nominal Backlash: 2 - 35 arcmin

Output Torque (ConstantSpeed): $\leq 97,100$ lb-in

Output Torque (Acceleration): $\leq 121,000$ lb-in

Input Shaft: Single or double extended

Output Shaft: Solid (single or double extended), Hollow, Shrink Disc

Cooling: Optional fan cooling



SERVO DRIVEN POWER SERIES S

The Series S gearbox is highly a flexible and economical servo reducer. Directly interchangeable with the competition, the Series S features a lightweight, aluminum housing which provides improved thermal performance. No other gearboxes offer the flexibility, performance, and reliability that you have come to expect from Cone Drive.

PACKAGING | AUTOMATION & ROBOTICS | CONVEYOR | SATELLITE COMMUNICATION

MADE IN
USA

ADAPTABLE PRECISION

- Conex proprietary worm gearing supported with two input bearings
- Lightweight, aluminum construction
- USDA white epoxy paint available
- Optional washdown design
- Best in class lead times
- 2 year warranty



CONFIGURE & DOWNLOAD YOUR MODEL AT www.ConeTools.com

SERIES S

— S P E C I F I C A T I O N S —

Center Distance: 1.33 thru 3.54 in

Ratio: 5:1 thru 60:1

Nominal Backlash: 12 - 41 arcmin

Output Torque (ConstantSpeed): $\leq 6,370$ lb-in

Output Torque (Acceleration): $\leq 7,540$ lb-in

Input Shaft: Solid, single extended

Output Shaft: Inch or metric, solid (single or double extended), hollow

Lubricant: Factory filled with synthetic lubricant

I.P. Rating: IP 55

SERVO DRIVEN POWER

SERIES RG

The Series RG-Servo gearbox is an adaptable solution for your motion control needs. Designed for various servo motors, the Series RG-Servo provides you with Cone Drive's double-enveloping worm gear technology and offers multiple output options. Tapered roller output bearings provide the capacity required to handle heavy overhung loads.

PACKAGING | AUTOMATION & ROBOTICS | CONVEYOR | SATELLITE COMMUNICATION

MADE IN
USA

POWERFUL PRECISION

- Double-enveloping worm gearing supported with two input bearings
- Low or standard backlash
- Cast iron construction
- White epoxy or stainless steel paint available
- Competitive pricing
- Best in class lead times
- 5 year warranty



CONFIGURE & DOWNLOAD YOUR MODEL AT www.ConeTools.com

SERIES RG

— SPECIFICATIONS —

Center Distance: 1.5 thru 3.5 in

Ratio: 5:1 thru 60:1

Nominal Backlash: 4 - 27 arcmin

Output Torque (ConstantSpeed): $\leq 10,800$ lb-in

Output Torque (Acceleration): $\leq 11,700$ lb-in

Input Shaft: Single or double extended

Output Shaft: Inch or metric, solid (single or double extended), hollow, shrink disc, mounting flange

Lubricant: Factory filled with synthetic lubricant

I.P. Rating: IP 65

SERVO DRIVEN POWER

SERIES FS STAINLESS STEEL

The Series FS Stainless Steel-Servo gearbox provides servo motion control in a stainless steel package. The smooth contours of the housing allow fluids to wick away preventing bacteria from forming on the surface. When your application demands strict hygienic performance, look no further than Cone Drive's Series F Stainless Steel gearbox.

FOOD & BEVERAGE | PACKAGING | PHARMACEUTICAL | MEAT & DAIRY | MIXERS

MADE IN
USA

HYGIENIC PRECISION

- Double-enveloping worm gearing supported with two input bearings
- Low or standard backlash
- 316 stainless steel adapter and housing
- Adheres to strict NSF and A3 hygienic standards and carries an ingress protection rating of IP69k
- Optional torque arm, flange, or side mounting available
- Best in class lead times
- 5 year warranty



CONFIGURE & DOWNLOAD YOUR MODEL AT www.ConeTools.com

SERIES FS

— S P E C I F I C A T I O N S —

Center Distance: 39 thru 76 mm

Ratio: 5:1 thru 60:1

Nominal Backlash: 4 - 27 arcmin

Output Torque (ConstantSpeed): < 5,950 lb-in

Output Torque (Acceleration): < 6,380 lb-in

Input Shaft: Single or double extended

Output Shaft: Inch or metric, solid (single or double extended), hollow, shrink disc

Lubricant: Factory filled with food grade lubricant

I.P. Rating: IP 69K

GEARSETS

Since 1925, customers have been trusting Cone Drive's double-enveloping worm gearing to provide the power and precision required for various applications. For customers who would like the additional performance of a Cone Drive gear set while maintaining their current housing, Cone Drive can manufacture a gear set to fit into most any application.

FOOD & PACKAGING | AEROSPACE & DEFENSE | PHARMACEUTICAL & MEDICAL | OIL & GAS

MADE IN
USA

TRUSTED SINCE 1925

- Zero, low, or standard backlash available
- Supplied as matched sets
- Wide range of exact ratios and sizes
- Adaptable to a multitude of customer specific applications
- Custom ratios available upon request
- Competitive lead times
- 1 year warranty



CONFIGURE & DOWNLOAD YOUR MODEL AT www.ConeTools.com

GEARSETS

— SPECIFICATIONS —

Center Distance: 1.5 thru 36 in

Ratio: 5:1 thru 70:1

Gear Materials: Tin + aluminum bronze, ductile iron, steel aluminum, Torlon®

Worm Materials: Hardened Steel + Nitride, Stainless Steel

Modified Output Configuration: Keyways, splines

Custom Design Options: Custom center distance, custom ratios

Special Ratios: Up to 200:1 single stage (size dependent), sector gears

CONE DRIVE HARMONIC SOLUTIONS®

Cone Drive's harmonic gearing is zero to low backlash by design. It provides high transmission accuracy and can support a high ratio reduction in a single stage with low inertia. The highly accurate, torque dense design makes harmonic gearing the perfect solution for ultimate precision motion control applications.

AUTOMATION & ROBOTICS | MEDICAL | SATELLITE COMMUNICATION | MILITARY & DEFENSE

MADE IN
USA

ULTIMATE PRECISION

- Ring, cup, and hat styles available
- Component sets and gearheads
- Low to zero backlash
- High transmission accuracy
- Customizations available upon request
- Manufactured and assembled in controlled environment
- Competitive lead times
- 1 year warranty



CONFIGURE & DOWNLOAD YOUR MODEL AT www.ConeTools.com

HARMONIC SOLUTIONS

— S P E C I F I C A T I O N S —

Sizes: 11 thru 32

Ratio: 50:1 thru 160:1

Nominal Backlash: ≤ 1 mRad

Continuous Output Torque: ≤ 172 Nm

Peak Output Torque: ≤ 824 Nm

Standard Input Options: Keyed or set screws (including Oldman style coupling)

Custom Input Options: Throughbore, solid input, dowel pins, tapped holes, piloted stepper/servo motor ready, special materials and coatings

Configurations: Component gearset or gearhead, sealed, throughbore, lightweight, and other options available

Custom solutions for your applications.

PLANETARY SERIES

Cone Drive's planetary gearing offers an inline solution to satisfy the most demanding automation application needs. The compact design and universal housing make planetary gearing ideal for multiple applications. The precision bearings and planetary gearing provides high torque density while maintaining positional performance.

SATELLITE COMMUNICATION | PACKAGING | AUTOMATION & ROBOTICS | AEROSPACE

INLINE PRECISION

- Multiple versions available (P_{S-Type}, P_{N-Type}, LE, LS)
- Quiet operation
- Ratios to 10:1 in a single stage
- Low backlash
- High efficiency
- Stainless steel option
- Competitive interchanges available
- Best in class lead times
- 5 year warranty



CONFIGURE & DOWNLOAD YOUR MODEL AT www.ConeTools.com

PLANETARY SERIES

— S P E C I F I C A T I O N S —

Case Size: 50 thru 240

Ratio: 3:1 thru 100:1

Nominal Backlash: 3 - 14 arcmin

Output Torque (ConstantSpeed): $\leq 2,400$ Nm

Output Torque (Acceleration): $\leq 3,700$ Nm

Input Shaft: Fits servo or stepper motors

Output Shaft: Solid shaft (smooth or keyed)

Lubricant: Factory filled with synthetic grease

I.P. Rating: IP 54, IP 55, IP 65, IP 66

SLEWING SOLUTIONS

Cone Drive's slewing technology provides a large ratio in a single stage of gearing. The slew bearing and gears are assembled into a low profile, self-retaining, and ready-to-install housing optimized for weight and performance. Our highly adaptable slew gearing feature strong shock resistance, long life performance and smooth rotation.

CONSTRUCTION EQUIPMENT

| AERIAL LIFTS

| AERIAL WORK PLATFORMS

LOW PROFILE POWER

- Select sizes available from stock
- Low profile
- Sealed drive options available
- Capable of combined tilting, radial, and axial loads
- Strong shock resistance
- Long life performance
- Competitive lead times
- 2 year warranty



CONFIGURE & DOWNLOAD YOUR MODEL AT www.ConeTools.com

SLEWING SOLUTIONS

— SPECIFICATIONS —

BEARINGS

Ball Pitch Diameter: 4.8 thru 31.5 in

Styles: No teeth, internal teeth (flanged only), external teeth

Moment Loads (flanged): $\leq 56,500$ lb-ft

Moment Loads: $\leq 443,000$ lb-ft

DRIVES

Sizes: 7 thru 25 in

Housing Options: Open, closed, high strength

Output Torque: $\leq 44,220$ lb-ft

Holding Torque: $\leq 116,535$ lb-ft

Overturning Moment: $\leq 228,644$ lb-ft

CUSTOM IS OUR SPECIALTY

Cone Drive isn't intimidated by custom designs. Each of our products can be tailored to fit your specific needs. Our manufacturing expertise ensures we will meet the competitive lead times you require. We can reverse engineer our gearing to fit inside existing housings. Let our team of skilled engineers develop a solution for you today.



SOLAR DRIVE



DUODRIVE



DUAL AXIS DRIVE



HARMONIC ACTUATOR



TRACKER DRIVE

Every product we offer can be customized to meet your needs. Contact our Application Engineers to get your solution started.

T O O L S & C O N T A C T S

WWW.CONEDRIVE.COM

- Product Information
- Catalogs & Literature

WWW.CONETOOLS.COM

- Product Configurator

CUSTOMER SERVICE: orders@conedrive.com

APPLICATION ENGINEERING: ae@conedrive.com

SERVICE CENTER: servicecenter@conedrive.com



GLOBAL LOCATIONS

NORTH AMERICA | EUROPE | ASIA



+1 888 994 2663 | orders@conedrive.com | conedrive.com | conetools.com

Courtesy of Steven Engineering, Inc - (800) 258-9200 - sales@steveneng.com - www.stevenengineering.com

08162022