



UNIDRIVE M ACCESSORIES

Operator Interfaces, Interconnect Components,
and Hardware/Power Options

CONTROL TECHNIQUES™

Nidec
All for dreams

Contents

Control Accessories

Operator Interfaces.....	3
Interconnect Components.....	6
Motion Synchronization Accessories.....	10
Logic and I/O Power Supplies.....	11

Power Accessories

Line and Load Reactors.....	12
Isolation Transformers.....	19
Drive EMC Filters.....	20
Dynamic Braking Resistors.....	22
Hardware Options.....	26

Operator Interfaces

CTVue — Graphical Human Machine Interface

Control Techniques offers a complete range of HMI (Human Machine Interface) display panels. CTVue Configurator software is complimentary and makes programming these HMIs quick and intuitive. The CTVue Configurator software includes built-in communication drivers and predefined drive parameters to speed integration with all Control Techniques drive lines. The broad hardware offering also ensures there is a CTVue HMI that balances price and functionality.

The 4.3-inch (304KE) HMI is designed for applications where available mounting space is at a premium. The smallest touchscreen in the CTVue family, just over 5 inches wide and 4 inches tall, the 304KE boasts a bright TFT (thin film transistor) display with full 32 K-color support.

For small and economical displays, the 303M offers a 3.2-inch monochrome graphical LCD display. The 303M is full featured with one Ethernet, one RS485, two RS232, and one Compact Flash port.

For medium-size displays, the 306A and 308A graphical touchscreens provide larger screens for enhanced display of graphics. The 306 and 308 versions include Ethernet, one RS485, two RS232, and one Compact Flash port and are available with color or monochrome graphical display.

For large displays, the 310C and 315C graphical color touchscreens provide the most graphical display area while offering all the connectivity and features of the 306 and 308 series plus a USB host port and option for an additional Ethernet port. Super-bright NEMA 4X outdoor versions are also available.

All of the CTVue HMIs have a Compact Flash port which allows for storage and transfer of data from a variety of external data sources using a standard Compact Flash card (order separately).

Key Features

- Integrated Control Techniques drivers
- Remote web and FTP access
- Powerful protocol converter

- USB programming port
- Alarming and data logging
- Bright TFT color display offerings
- Complimentary, simple-to-use, programming software
- Flexible Compact Flash slot
- Security user levels/passwords
- Available front faceplate customization
- For use in hazardous locations
- 24 Vdc operation

CTVUE-304KE



- 4.3-inch, 480 x 272, Graphic Touch Display, TFT, 32 K-color display
- Ethernet, RS485 and RS232 port
- 128 MB onboard flash memory

CTVUE-303M



- 3.2-inch, 128 x 64, LCD, monochrome display
- Ethernet, RS485
- 8 x customizable function keys
- Compact Flash slot
- 4 MB non-volatile flash memory
- USB host port

CTVUE-306A



- 5.7-inch, 320 x 240, Graphic Touch Display, TFT, 256-color
- Ethernet, RS485 and RS232 port
- Compact Flash slot
- 4/8 MB non-volatile flash memory
- Four programmable soft keys
- USB host port

CTVUE-308A



- 8.4-inch, 640 x 480, Graphic Touch Display, TFT, 32 K-color display
- Ethernet, RS485 and RS232 port
- Compact Flash slot
- 32 MB non-volatile flash memory
- Six programmable soft keys
- USB host port



Easily create your customized machine interface with Complimentary CTVue configurator software.

Operator Interfaces

CTVUE-310C



- 10.4-inch, 640 x 480, Graphic Color Touch, TFT, 32 K-color display
- Ethernet, RS232, RS485 port
- Compact Flash slot
- 32 MB non-volatile flash memory
- Outdoor version available
- USB host port

CTVUE-315C



- 15-inch, 1024 x 768, Graphic Color Touch, TFT, 32 K-color display
- Ethernet, RS485, and RS232 port
- Compact Flash slot
- 64 MB non-volatile flash memory
- USB host port

When mounted using the supplied gasket, all panels have a rating of IP66 / NEMA 4X.

Order Code	Description	Dimensions H x W x D (in)
CTVUE-304KE	4.3", 480 x 272, TFT, 32 k-color touchscreen - with RS232, RS485, Ethernet	4 x 5 x 1.5
CTVUE-303M	3.2", 128 x 64, LCD, monochrome display - with Ethernet, RS485, RS232, Compact Flash	5.9 x 7.5 x 2.1
CTVUE-306A	5.7", 320 x 240, TFT, 256-color touchscreen - with Ethernet, RS485, RS232	7.1 x 8.8 x 2.3
CTVUE-308A	8.4", 640 x 480, TFT, 32 k-color touchscreen - with (1) Ethernet, isolated comms RS485, RS232	8.2 x 10.3 x 2.2
CTVUE-310C	10.4", 640 x 480, TFT, 32 k-color touchscreen - with (1) Ethernet, isolated comms RS485, RS232	9.5 x 12.9 x 2.2
CTVUE-315C	15", 1024 x 768, TFT, 32 k-color touchscreen - with (1) Ethernet, RS485, RS232	13 x 16 x 2.8
CTVUE-CF1000	1 GB industrial Compact Flash memory	
CTVUE-CF2000	2 GB Industrial Compact Flash memory	
CTVUE-CONFIG-CD	Complimentary programming software CD	
CTVUE-USB	USB Programming cable PC to CTVue	
CTVUE-EP-485-xxx*	RS485 cable; RJ45 to RJ45	
UM-LCD-485-xxx*	RS485 cable for multidrop; RJ45 to RJ45	
CT-USB-CABLE	Modbus RTU (RS485) to USB conversion	
CTVUE-R500	RS232 / RS485 communications option card	
CTVUE-CN00	CANopen communications option card	
CTVUE-PBDP	PROFIBUS DP communications option card	
CTVUE-DN00	DeviceNet communications option card	
CTVUE-PRO-4K	Serial Port cable for programming CTVUE-304KE	
CTVUE-ADK-485	DB9-pin connector to RJ45 adaptor (for use with CTVUE-EP-485 cables)	
CTVUE-USB-4K	USB to RS232 converter cable includes CTVUE-PRO-4K cable	

* Standard cable lengths: 5, 15, 25 ft (-005) (-015) (-025)

CTVue Connectivity and Functionality

The CTVue touchscreens are easy to set up and connect to your application.

Connection to the Serial Port

The operator interface is connected directly to the RJ45 connection on the serial port of the drive. RS485 is a multi-drop Modbus RTU protocol and may be connected to multiple drives if required.

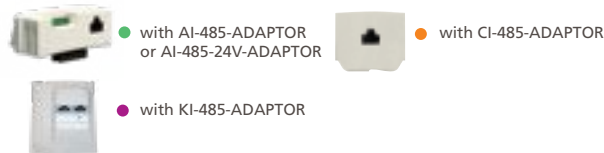
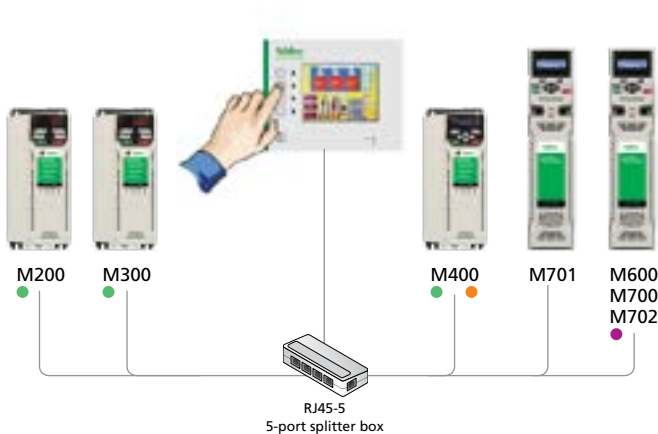

Connecting via Ethernet

The Unidrive M700, Unidrive M702, SI-ETHERNET, and MCI210 option modules allow the operator interface to be connected to the drive using Modbus TCP/IP.

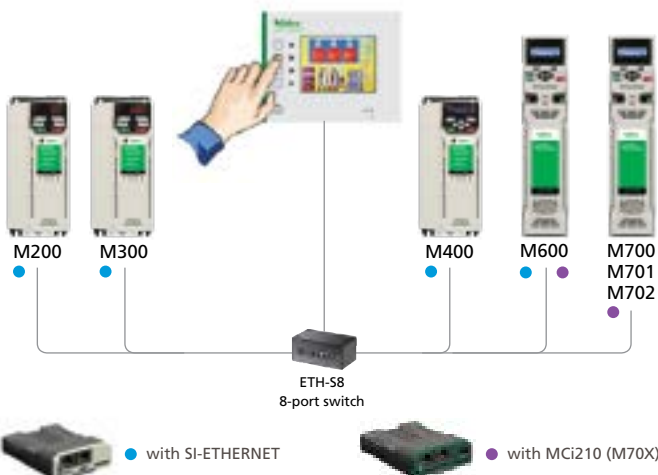

CTVue Specifications	
Power Input	24 Vdc
Temperature	32 to 122 °F (0 to 50 °C)
Environmental	IP66 / NEMA 4X, for use in hazardous locations:*
	Class I, Division 2, Groups A,B,C and D
	Class II, Division 2, Groups F and G
Operating Humidity	80% relative maximum from 32 to 122 °F (0 to 50 °C)

*see website for individual data sheets



Interconnect Components

Operator Interface Single-drop Cables

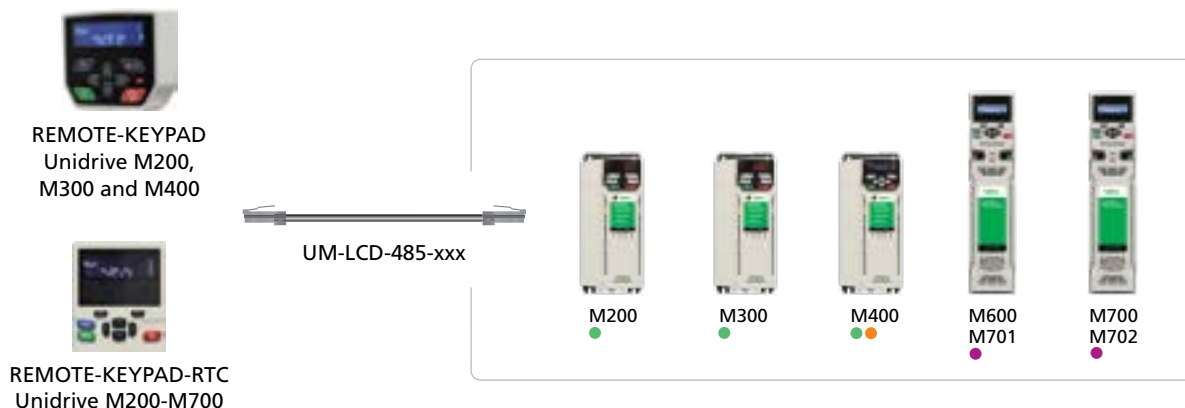
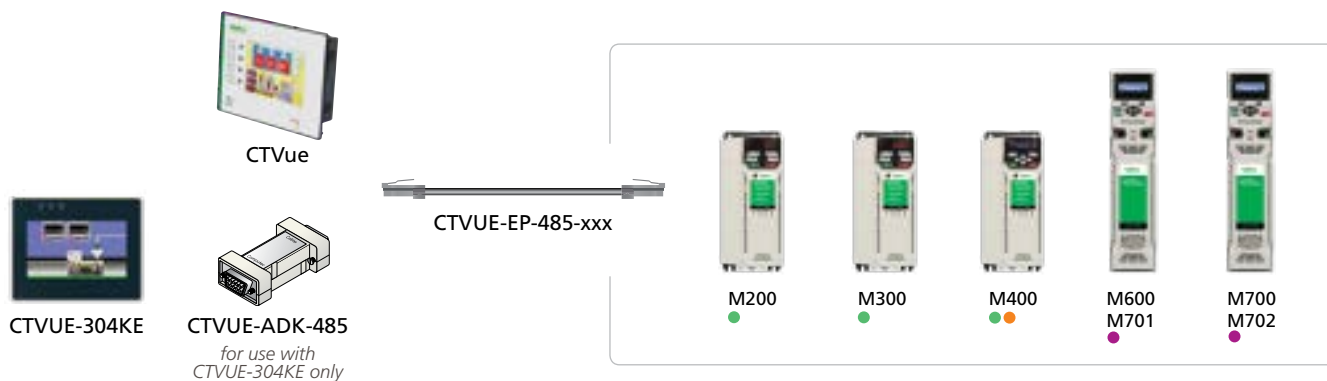

See the Unidrive M Options brochure for keypad options



CTVUE-EP-485-xxx
RS485 cable; RJ45 to RJ45

UM-LCD-485-xxx
RS485 cable with RJ45 connector on both ends for LCD Keypad and Unidrive M

xxx = length in feet (330 ft maximum length)

CTVUE-ADK-485
RS485 DB9pin to RJ45 adaptor is used with the CTVUE-304KE and appropriate drive RS485 cable

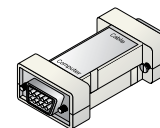

Operator Interface Multi-drop Cables

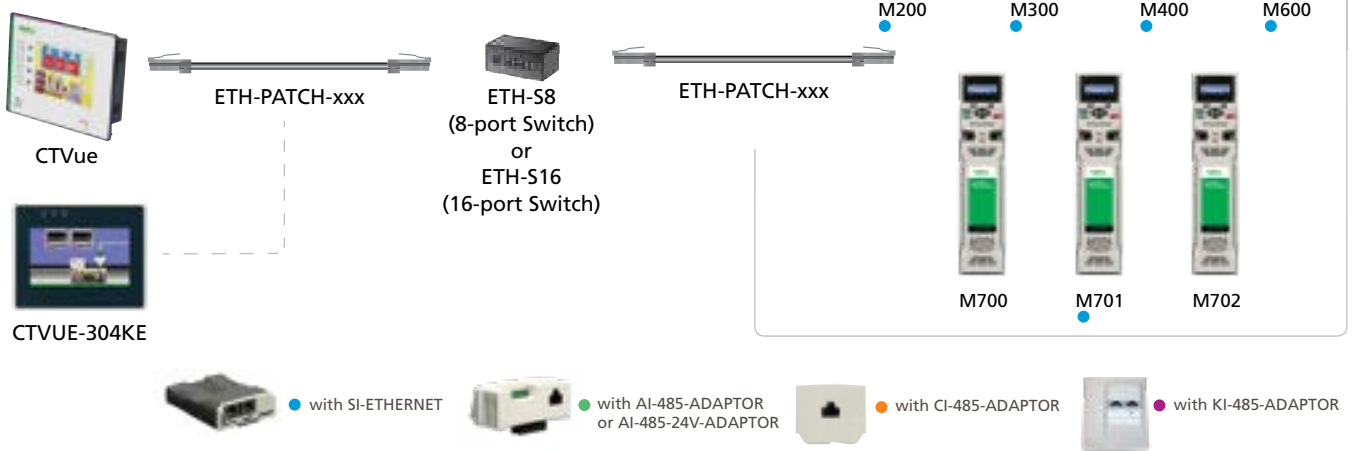
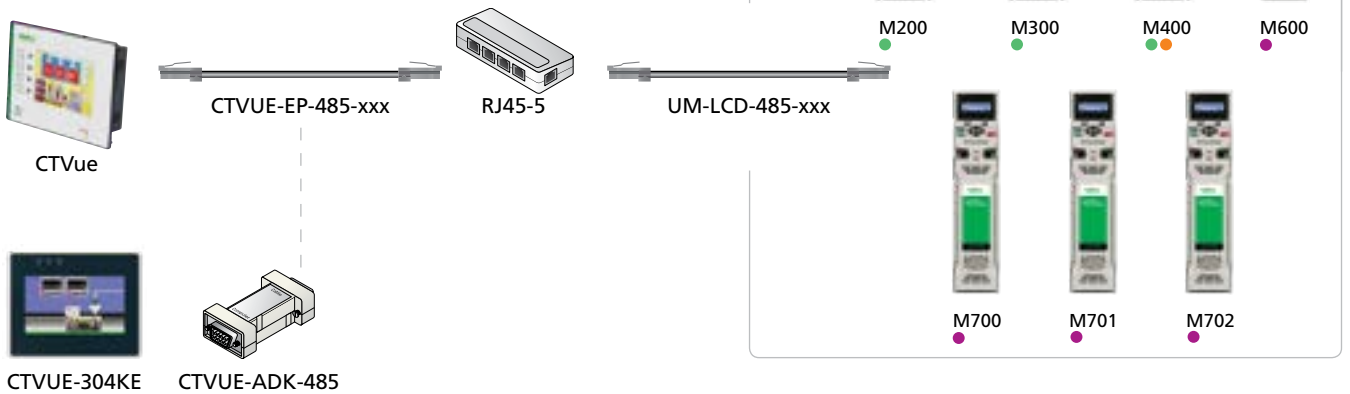

CTVUE-EP-485-xxx
RS485 cable; RJ45 to RJ45

UM-LCD-485-xxx
RS485 cable for multi-drop; RJ45 connector on both ends

ETH-PATCH-xxx
RJ45 Ethernet patch cable; wires dressed at both ends

xxx = length in feet (330 ft maximum length)

Interconnect Components

Operator Interface Software Cables

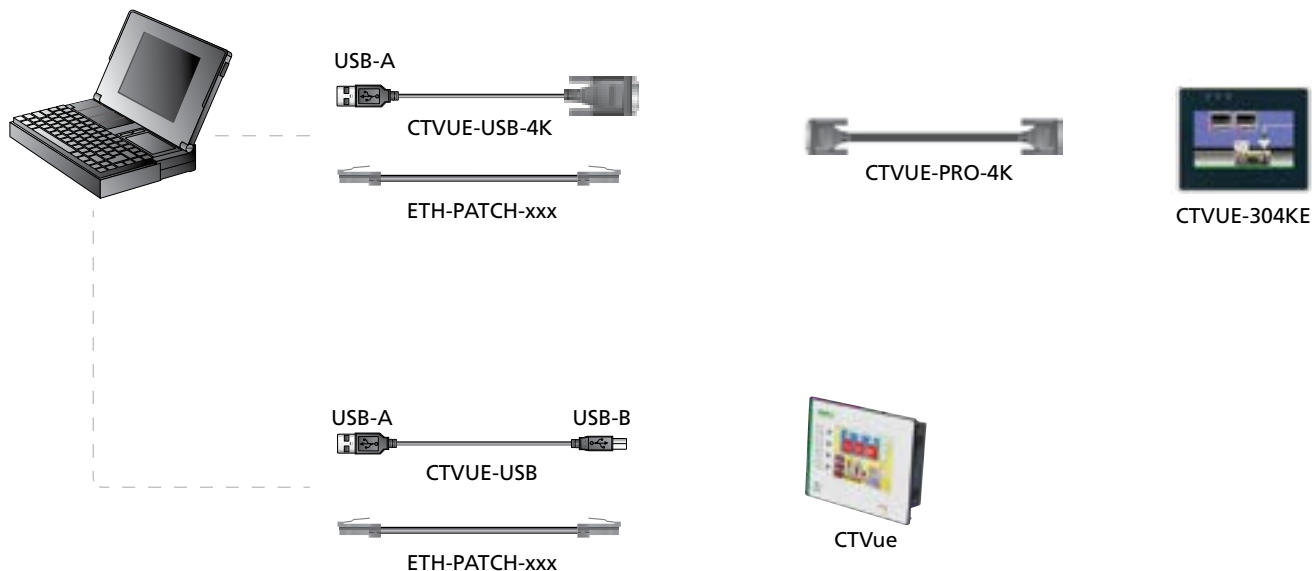

CT-USB-CABLE

Connects the Modbus port on the drive (RS485) directly to the USB port on your PC; USB to RS485 conversion



RJ45-5

RJ45 Splitter; accepts one RJ45 connector of input and 4 RJ45 connectors for output

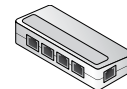

CTVUE-USB

CTVue USB programming cable: USB Connectors on both ends; USB-A on drive side and USB-B on panel side



CTVUE-USB-4K

USB to RS232 converter for programming CTVUE-304KE; this order code includes CTVUE-PRO-4K cable



UM-LCD-485-xxx

RS485 cable for multi-drop: RJ45 connector on both ends



CTVUE-PRO-4K

Serial port cable for convenient connection to CTVUE-304KE to PC.



xxx = length in feet (330 ft maximum length)

Software Interface Single or Multi-drop Cables

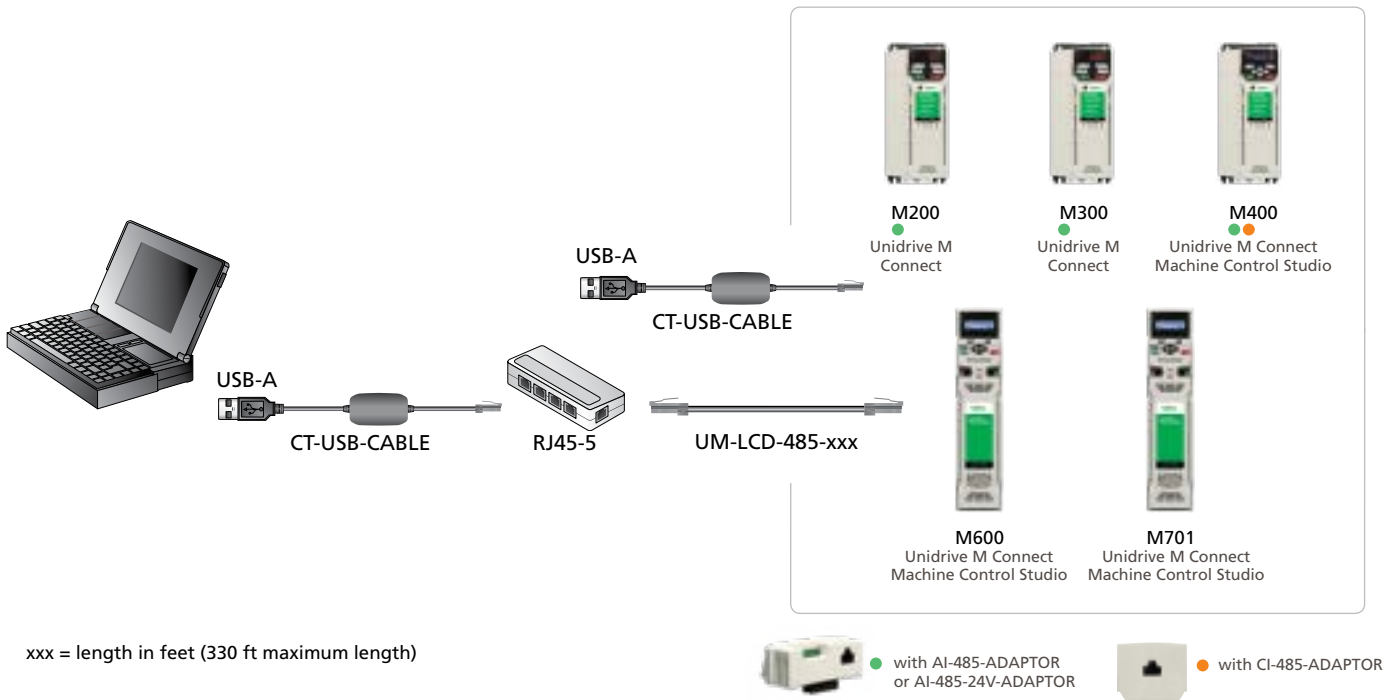

Software Interface with Ethernet

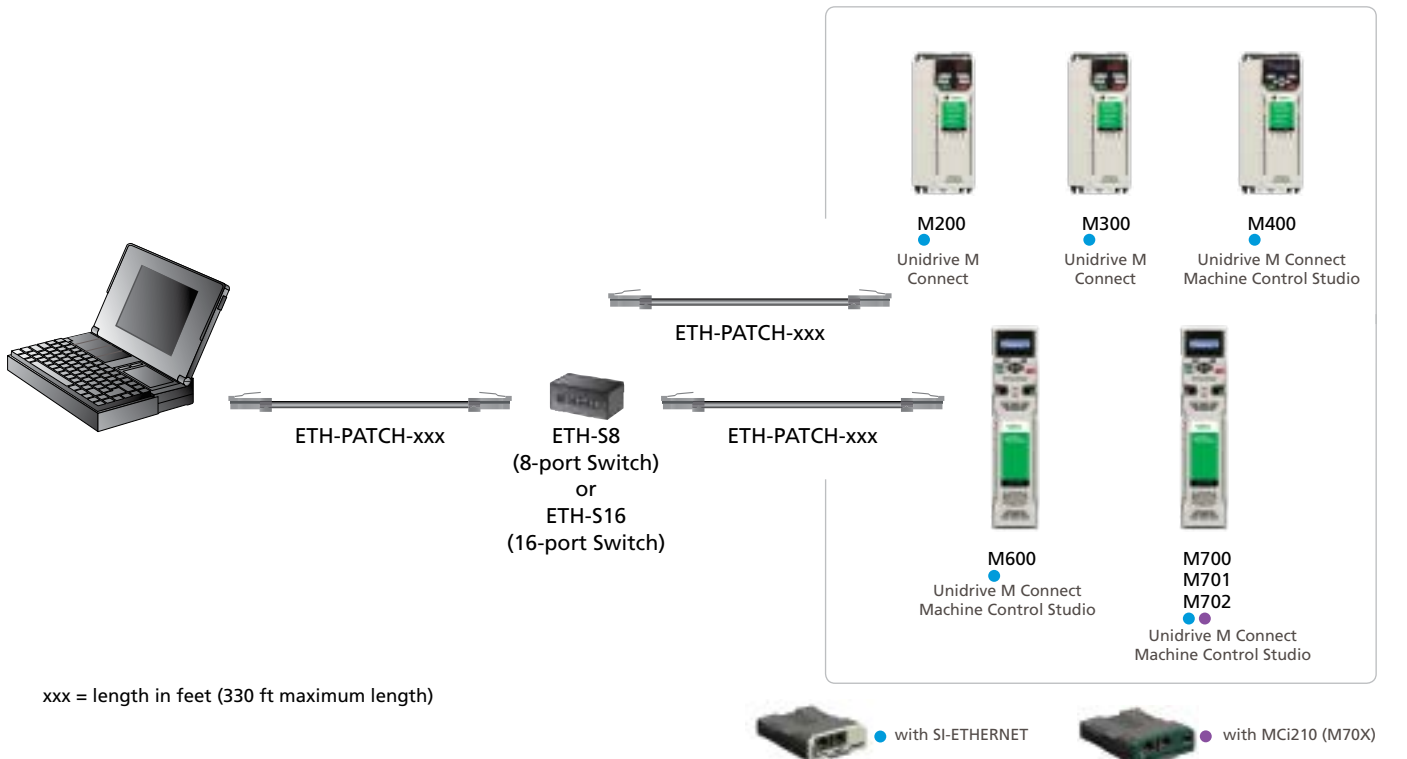

Motion Synchronization Components

Control Techniques' hardware provides easy configuration of motion synchronization. Pre-configured cables are available for connection from a master synchronization encoder to drive connections. Unidrive M700 increases flexibility and reduces system costs through simultaneously connecting up to three high-performance encoder channels as standard. The drive can interface with a feedback encoder, reference encoder and provide one simulated encoder output.

- Two universal encoder input channels
 - Support for standard incremental and SinCos encoders, including those with absolute signals.
 - Support for communications based on encoders with up to 4 Mb rate and line compensations to support long cable lengths up to 100 m. Includes EnDat 2.2, HIPERFAC®, and SSI.

Using the preconfigured cables, 1.5-axis synchronization is easily achieved.

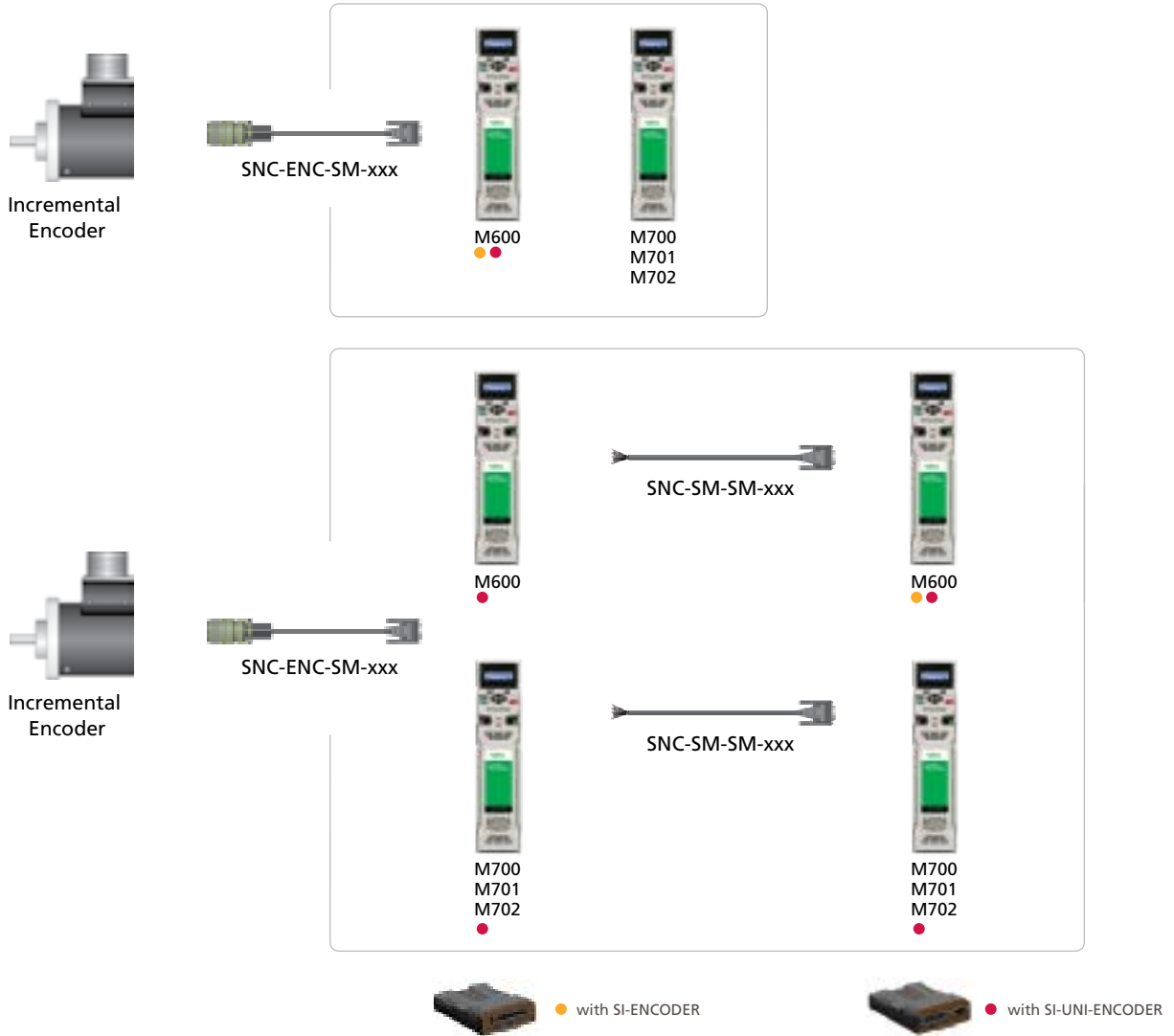

SNC-ENC-SM -010, -025, -050
 Sync cable to SI-UNI-ENCODER,
 Encoder connector to D15P connector
 SCSLD to SI-UNI-ENCODER or SI-ENCODER

SNC-SM-SM-xxx
 SI-UNI-ENCODER output to SI-UNI-ENCODER.
 DB15 connector on one end, flying leads on the other

xxx = length in feet (330 ft maximum length)

Encoder Order Codes

Description	Side Connection Order Code	End Connection Order Code
Synchronization Encoder 3000 Line (12000 ppr Quadrature)	SCSLD-4R	SCSLD-4
Synchronization Encoder 2500 Line (10000 ppr Quadrature)	SCSLD-3R	SCSLD-3
Synchronization Encoder 1000 Line (4000 ppr Quadrature)	SCSLD-2R	SCSLD-2

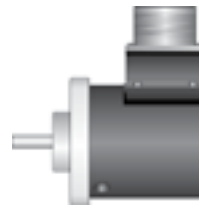

Side Connector



End Connector

Encoder Breakout Boards

SM-ETC

Encoder feedback connector breakout board (DB15)

Encoder Specifications

Supply Voltage	+5 Vdc
Current	Line drives with ZR=+5 Vdc @ 5m A
Frequency	Up to 200 kHz
Outputs	Analog - differential peak-to-peak amplitude of 2.5 Vdc
Operating Temp.	32 to 158 °F (0 to 70 °C)

*see website for individual data sheets

Logic and I/O Power Supplies

MLP-002-00

2.1 Amp, +24 Vdc, universal input 90 to 264 Vac

MLP-005-00

5 Amp, +24 Vdc, universal input 90 to 264 Vac

MLP-010-00

10 Amp, +24 Vdc, universal input 90 to 264 Vac

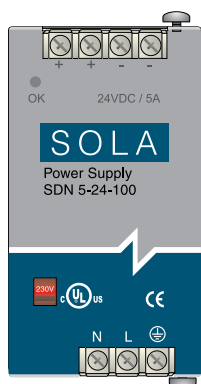

Line and Load Reactors

Line and Load Reactors

Line reactors (sometimes called “line chokes”) are a common power accessory for electronic variable speed drives. These components add an extra margin of protection for AC drives from supply transients.

Line reactors are strongly recommended for installation with AC drives that do not have built-in inductors. Refer to the built-in inductor columns in the following tables.

Load reactors are used on the output of AC drives to reduce the effects of high motor wiring capacitance and to “soften” the dV/dt (rate of change of voltage) applied to the motor windings.

Reactors in AC drive applications:

- Help reduce harmonic distortion of the input line current
- Improve input line current balance
- Reduce nuisance drive over-voltage trips caused by transient voltage spikes and power line notches
- Protect input rectifiers from in-rush current caused by sudden power line surges and sags
- Extend the life of the DC bus capacitor bank by reducing the internal heating caused by ripple current
- Protect motor windings from long lead effects when used on the drive output



Line and Load Reactor Specifications	
Voltage	690 Vac maximum
Ambient Temperature	104 °F (40 °C)
Overload	200% for 10 seconds 150% for 1 minute
Approvals	CE UL508 CSA C22.2

Order Code

xx - x - xxxxA - x

LR = Line/Load Reactor

L = Low Impedance
M = Medium Impedance
H = High Impedance

Current Rating

A = Amps

C = Open Chassis
E = Enclosed NEMA 1

Input Line Reactors - 115 Vac & 230 Vac



115 Vac, Single Phase 50/60 Hz							
Drive	Built-in Inductor	Amps	Inductance (μH)	Watts Loss	Chassis Mount		
					Order Code	Dimensions H x W x D (in)	Weight (lbs)
Maaa-01100017	No	21	530	38.3	LRL0021A-C	5.3 x 4.4 x 3.3	4.2
Maaa-01100024	No	28	390	48.2	LRL0028A-C	5.3 x 4.4 x 3.5	5.1
Maaa-02100042	No	55	270	67	LRL0055A-C	6 x 7.2 x 4	18
Maaa-02100056	No	65	190	87	LRL0065A-C	6 x 7.2 x 4	18

230 Vac, Single Phase 50/60 Hz							
Drive	Built-in Inductor	Amps	Inductance (μH)	Watts Loss	Chassis Mount		
					Order Code	Dimensions H x W x D (in)	Weight (lbs)
Maaa-01200017	No	4.8	2300	13.8	LRL004A8-C	3.7 x 4.5 x 1.5	1.7
Maaa-01200024	No	7.6	1500	19.2	LRL007A6-C	3.7 x 4.5 x 1.5	1.8
Maaa-01200033	No	11	1000	26.8	LRL0011A-C	5 x 4.4 x 2.8	2.7
Maaa-01200042	No	11	1000	26.8	LRL0011A-C	5 x 4.4 x 2.8	2.7
Maaa-02200024	No	7.6	1500	19.2	LRL007A6-C	3.7 x 4.5 x 1.5	1.8
Maaa-02200033	No	11	1000	26.8	LRL0011A-C	5 x 4.4 x 2.8	2.7
Maaa-02200042	No	11	1000	26.8	LRL0011A-C	5 x 4.4 x 2.8	2.7
Maaa-02200056	No	21	530	38.3	LRL0021A-C	5.3 x 4.4 x 3.3	4.2
Maaa-02200075	No	21	530	38.3	LRL0021A-C	5.3 x 4.4 x 3.3	4.2
Maaa-03200100	No	28	390	48.2	LRL0028A-C	5.3 x 4.4 x 3.5	5.1
Maaa-04200133	Yes	28	390	48.2	LRL0028A-C	5.3 x 4.4 x 3.5	5.1

230 Vac, 3 Phase 50/60 Hz										
Drive	Built-in Inductor	Amps	Inductance (μH)	Watts Loss	Chassis Mount			NEMA 1 Enclosed		
					Order Code	Dimensions H x W x D (in)	Weight (lbs)	Order Code	Dimensions H x W x D (in)	Weight (lbs)
Maaa-02200024	No	4.8	2300	13.8	LRL004A8-C	3.7 x 4.5 x 1.5	1.7	LRL004A8-E	8 x 8 x 6	8.7
Maaa-02200033	No	7.6	1500	19.2	LRL007A6-C	3.7 x 4.5 x 1.5	1.8	LRL007A6-E	8 x 8 x 6	8.8
Maaa-02200042	No	7.6	1500	19.2	LRL007A6-C	3.7 x 4.5 x 1.5	1.8	LRL007A6-E	8 x 8 x 6	8.8
Maaa-02200056	No	14	790	32.7	LRL0014A-C	5.3 x 4.4 x 2.8	2.8	LRL0014A-E	8 x 8 x 6	9.8
Maaa-02200075	No	14	790	32.7	LRL0014A-C	5.3 x 4.4 x 2.8	2.8	LRL0014A-E	8 x 8 x 6	9.8
Maaa-03200100	No	21	530	38.3	LRL0021A-C	5.3 x 4.4 x 3.3	4.2	LRL0021A-E	13.3 x 13.2 x 13.1	22.2
Maaa-04200133	Yes	21	530	38.3	LRL0021A-C	5.3 x 4.4 x 3.3	4.2	LRL0021A-E	13.3 x 13.2 x 13.1	22.2
Maaa-04200176	Yes	28	390	48.2	LRL0028A-C	5.3 x 4.4 x 3.5	5.1	LRL0028A-E	13.3 x 13.2 x 13.1	23.1
Mbbb-03200050	No	11	1000	26.8	LRL0011A-C	5 x 4.4 x 2.8	2.7	LRL0011A-E	8 x 8 x 6	9.7
Mbbb-03200066	No	14	790	32.7	LRL0014A-C	5.3 x 4.4 x 2.8	2.8	LRL0014A-E	8 x 8 x 6	9.8
Mbbb-03200080	No	21	530	38.3	LRL0021A-C	5.3 x 4.4 x 3.3	4.2	LRL0021A-E	13.3 x 13.2 x 13.1	22.2
Mbbb-03200106	No	21	530	38.3	LRL0021A-C	5.3 x 4.4 x 3.3	4.2	LRL0021A-E	13.3 x 13.2 x 13.1	22.2
Mbbb-04200137	Yes	21	530	38.3	LRL0021A-C	5.3 x 4.4 x 3.3	4.2	LRL0021A-E	13.3 x 13.2 x 13.1	22.2
Mbbb-04200185	Yes	28	390	48.2	LRL0028A-C	5.3 x 4.4 x 3.5	5.1	LRL0028A-E	13.3 x 13.2 x 13.1	23.1
Mccc-05200250	Yes	35	400	49	LRL0035A-C	6 x 6 x 3.5	10	LRL0035A-E	13.3 x 13.2 x 13.1	28
Mccc-06200330	Yes	55	270	67	LRL0055A-C	6 x 7.2 x 4	18	LRL0055A-E	13.3 x 13.2 x 13.1	36
Mccc-06200440	Yes	65	190	87	LRL0065A-C	6 x 7.2 x 4	18	LRL0065A-E	13.3 x 13.2 x 13.1	36
Mccc-07200610	Yes	83	170	119	LRL0083A-C	6 x 7.2 x 4.3	19	LRL0083A-E	13.3 x 13.2 x 13.1	37
Mccc-07200750	Yes	104	120	94	LRL0104A-C	6 x 7.2 x 6.5	22	LRL0104A-E	13.3 x 13.2 x 13.1	40
Mccc-07200830	Yes	130	95	132	LRL0130A-C	7.5 x 9.3 x 6.8	26	LRL0130A-E	13.3 x 13.2 x 13.1	44
Mccc-08201160	Yes	160	80	110	LRL0160A-C	7.5 x 9.3 x 6.8	34	LRL0160A-E	13.3 x 13.2 x 13.1	52
Mccc-08201320	Yes	200	60	159	LRL0200A-C	7.5 x 9.3 x 7	34	LRL0200A-E	24 x 16.9 x 18.4	61
Mddd-09201760A	Yes	250	50	275	LRL0250A-C	7.5 x 9.5 x 7.5	35	LRL0250A-E	24 x 16.9 x 18.4	62
Mddd-09201760E	No	250	50	275	LRL0250A-C	7.5 x 9.5 x 7.5	35	LRL0250A-E	24 x 16.9 x 18.4	62
Mddd-09202190A	Yes	322	50	300	LRL0322A-C	7.5 x 9.3 x 9	57	LRL0322A-E	24 x 16.9 x 18.4	84
Mddd-09202190E	No	322	50	300	LRL0322A-C	7.5 x 9.3 x 9	57	LRL0322A-E	24 x 16.9 x 18.4	84
Meee-10202830	No	414	33	333	LRL0414A-C	8.8 x 9 x 9.5	78	LRL0414A-E	47 x 26.5 x 24.9	222
Meee-10203000	No	414	33	333	LRL0414A-C	8.8 x 9 x 9.5	78	LRL0414A-E	47 x 26.5 x 24.9	222

aaa = Unidrive M100, M101, M200, M201, M300, HS30, M400

bbb = Unidrive M600, M700, M701, M702, HS70, HS71, HS72

ccc = Unidrive M200, M201, M300, M400, M600, M700, M701, M702, HS70, HS71, HS72

ddd = Unidrive M200, M201, M300, M400, M600, M700, M701, M702

eee = Unidrive M600, M700, M701, M702

Line reactors are recommended for AC drives that do not include a built-in inductor.

For drive modules that include DC or AC inductors built-in, the line reactors above provide additional impedance.

For drive modules that include DC or AC inductors built-in, the line reactors above provide additional impedance.

Output Load Reactors - 230 Vac

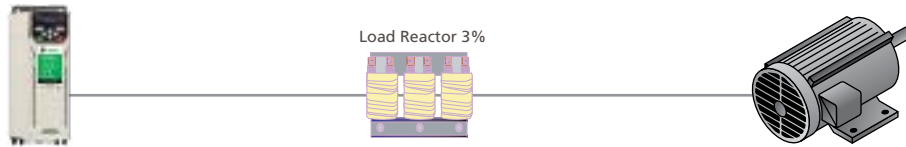

230 Vac 3 Phase									
Drive	Amps	Inductance (µH)	Watts Loss	Chassis Mount			NEMA 1 Enclosed		
				Order Code	Dimensions H x W x D (in)	Weight (lbs)	Order Code	Dimensions H x W x D (in)	Weight (lbs)
Maaa-01100017	3.4	3200	12.3	LRL003A4-C	3.7 x 4.5 x 1.5	1.6	LRL003A4-E	8 x 8 x 6	8.6
Maaa-01100024	3.4	3200	12.3	LRL003A4-C	3.7 x 4.5 x 1.5	1.6	LRL003A4-E	8 x 8 x 6	8.6
Maaa-01200017	3.4	3200	12.3	LRL003A4-C	3.7 x 4.5 x 1.5	1.6	LRL003A4-E	8 x 8 x 6	8.6
Maaa-01200024	3.4	3200	12.3	LRL003A4-C	3.7 x 4.5 x 1.5	1.6	LRL003A4-E	8 x 8 x 6	8.6
Maaa-01200033	4.8	2300	13.8	LRL004A8-C	3.7 x 4.5 x 1.5	1.7	LRL004A8-E	8 x 8 x 6	8.7
Maaa-01200042	7.6	1500	19.2	LRL007A6-C	3.7 x 4.5 x 1.5	1.8	LRL007A6-E	8 x 8 x 6	8.8
Maaa-02100042	7.6	1500	19.2	LRL007A6-C	3.7 x 4.5 x 1.5	1.8	LRL007A6-E	8 x 8 x 6	8.8
Maaa-02100056	7.6	1500	19.2	LRL007A6-C	3.7 x 4.5 x 1.5	1.8	LRL007A6-E	8 x 8 x 6	8.8
Maaa-02200024	3.4	3200	12.3	LRL003A4-C	3.7 x 4.5 x 1.5	1.6	LRL003A4-E	8 x 8 x 6	8.6
Maaa-02200033	4.8	2300	13.8	LRL004A8-C	3.7 x 4.5 x 1.5	1.7	LRL004A8-E	8 x 8 x 6	8.7
Maaa-02200042	7.6	1500	19.2	LRL007A6-C	3.7 x 4.5 x 1.5	1.8	LRL007A6-E	8 x 8 x 6	8.8
Maaa-02200056	7.6	1500	19.2	LRL007A6-C	3.7 x 4.5 x 1.5	1.8	LRL007A6-E	8 x 8 x 6	8.8
Maaa-02200075	11	1000	26.8	LRL0011A-C	5 x 4.4 x 2.8	2.7	LRL0011A-E	8 x 8 x 6	9.7
Maaa-03200100	14	790	32.7	LRL0014A-C	5.3 x 4.4 x 2.8	2.8	LRL0014A-E	8 x 8 x 6	9.8
Maaa-04200133	21	530	38.3	LRL0021A-C	5.3 x 4.4 x 3.3	4.2	LRL0021A-E	13.3 x 13.2 x 13.1	22.2
Maaa-04200176	28	390	48.2	LRL0028A-C	5.3 x 4.4 x 3.5	5.1	LRL0028A-E	13.3 x 13.2 x 13.1	23.1
Mbbb-03200050	11	1000	26.8	LRL0011A-C	5 x 4.4 x 2.8	2.7	LRL0011A-E	8 x 8 x 6	9.7
Mbbb-03200066	11	1000	26.8	LRL0011A-C	5 x 4.4 x 2.8	2.7	LRL0011A-E	8 x 8 x 6	9.7
Mbbb-03200080	14	790	32.7	LRL0014A-C	5.3 x 4.4 x 2.8	2.8	LRL0014A-E	8 x 8 x 6	9.8
Mbbb-03200106	21	530	38.3	LRL0021A-C	5.3 x 4.4 x 3.3	4.2	LRL0021A-E	13.3 x 13.2 x 13.1	22.2
Mbbb-04200137	28	390	48.2	LRL0028A-C	5.3 x 4.4 x 3.5	5.1	LRL0028A-E	13.3 x 13.2 x 13.1	23.1
Mbbb-04200185	35	400	49	LRL0035A-C	6 x 6 x 3.5	10	LRL0035A-E	13.3 x 13.2 x 13.1	28
Mccc-05200250	46	300	77	LRL0046A-C	6 x 7.2 x 3.8	13	LRL0046A-E	13.3 x 13.2 x 13.1	31
Mccc-06200330	65	190	87	LRL0065A-C	6 x 7.2 x 4	18	LRL0065A-E	13.3 x 13.2 x 13.1	36
Mccc-06200440	83	170	119	LRL0083A-C	6 x 7.2 x 4.3	19	LRL0083A-E	13.3 x 13.2 x 13.1	37
Mccc-07200610	104	120	94	LRL0104A-C	6 x 7.2 x 6.5	22	LRL0104A-E	13.3 x 13.2 x 13.1	40
Mccc-07200750	130	95	132	LRL0130A-C	7.5 x 9.3 x 6.8	26	LRL0130A-E	13.3 x 13.2 x 13.1	44
Mccc-07200830	160	80	110	LRL0160A-C	7.5 x 9.3 x 6.8	34	LRL0160A-E	13.3 x 13.2 x 13.1	52
Mccc-08201160	200	60	159	LRL0200A-C	7.5 x 9.3 x 7	34	LRL0200A-E	24 x 16.9 x 18.4	61
Mccc-08201320	250	50	275	LRL0250A-C	7.5 x 9.5 x 7.5	35	LRL0250A-E	24 x 16.9 x 18.4	62
Mddd-09201760	322	50	300	LRL0322A-C	7.5 x 9.3 x 9	57	LRL0322A-E	24 x 16.9 x 18.4	84
Mddd-09202190	414	33	333	LRL0414A-C	8.8 x 9 x 9.5	78	LRL0414A-E	47 x 26.5 x 24.9	222
Meee-10202830	515	25	314	LRL0515A-C	8.8 x 9 x 9.5	81	LRL0515A-E	47 x 26.5 x 24.9	225
Meee-10203000	515	25	314	LRL0515A-C	8.8 x 9 x 9.5	81	LRL0515A-E	47 x 26.5 x 24.9	225

aaa = Unidrive M100, M101, M200, M201, M300, HS30, M400
 bbb = Unidrive M600, M700, M701, M702, HS70, HS71, HS72
 ccc = Unidrive M200, M201, M300, M400, M600, M700, M701, M702, HS70, HS71, HS72
 ddd = Unidrive M200, M201, M300, M400, M600, M700, M701, M702
 eee = Unidrive M600, M700, M701, M702

Consult factory for different percentage impedance and NEMA 3R outdoor enclosure options.



Input Line Reactors - 460 Vac

Line Reactor 3%

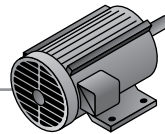
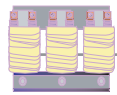

460 Vac, 3 Phase 50/60 Hz												
Drive	Built-in Inductor	Amps	Inductance (µH)	Watts Loss	Chassis Mount				NEMA 1 Enclosed			
					Order Code	List Price	Dimensions H x W x D (in)	Weight (lbs)	Order Code	List Price	Dimensions H x W x D (in)	Weight (lbs)
Maaa-02400013	No	3.4	11000	26.5	LRH003A4-C	\$98	3.7 x 4.5 x 1.5	1.6	LRH003A4-E	\$220	8 x 8.1 x 6.1	8.6
Maaa-02400018	No	3.4	6800	19.6	LRM003A4-C	\$59	3.7 x 4.5 x 1.5	1.6	LRM003A4-E	\$190	8 x 8 x 6	8.6
Maaa-02400023	No	4.8	7700	37.5	LRH004A8-C	\$98	5 x 4.4 x 2.8	2.8	LRH004A8-E	\$225	8 x 8.1 x 6.1	8.6
Maaa-02400032	No	7.6	4800	47.8	LRH007A6-C	\$91	5 x 4.4 x 3.1	4.1	LRH007A6-E	\$295	8 x 8 x 6	11.1
Maaa-02400041	No	7.6	3000	37.2	LRM007A6-C	\$79	5 x 4.4 x 2.8	2.8	LRM007A6-E	\$205	8 x 8 x 6	9.8
Maaa-03400056	No	11	2100	40.9	LRM0011A-C	\$106	5 x 4.4 x 3.1	4.2	LRM0011A-E	\$280	8 x 8 x 6	11.2
Maaa-03400073	No	11	2100	40.9	LRM0011A-C	\$106	5 x 4.4 x 3.1	4.2	LRM0011A-E	\$280	8 x 8 x 6	11.2
Maaa-03400094	No	14	1600	48.2	LRM0014A-C	\$133	5 x 4.4 x 3.1	4.3	LRM0014A-E	\$315	8 x 8 x 6	11.3
Maaa-04400135	Yes	14	1600	48.2	LRM0014A-C	\$133	5 x 4.4 x 3.1	4.3	LRM0014A-E	\$315	8 x 8 x 6	11.3
Maaa-04400170	Yes	21	1100	57.4	LRM0021A-C	\$148	6.1 x 6 x 2.6	7.2	LRM0021A-E	\$315	13.3 x 13.2 x 13.1	25.2
Mbbb-03400025	No	7.6	4800	47.8	LRH007A6-C	\$91	5 x 4.4 x 3.1	4.1	LRH007A6-E	\$295	8 x 8 x 6	11.1
Mbbb-03400031	No	7.6	3000	37.2	LRM007A6-C	\$79	5 x 4.4 x 2.8	2.8	LRM007A6-E	\$205	8 x 8 x 6	9.8
Mbbb-03400045	No	11	2100	40.9	LRM0011A-C	\$106	5 x 4.4 x 3.1	4.2	LRM0011A-E	\$280	8 x 8 x 6	11.2
Mbbb-03400062	No	14	1600	48.2	LRM0014A-C	\$133	5 x 4.4 x 3.1	4.3	LRM0014A-E	\$315	8 x 8 x 6	11.3
Mbbb-03400078	Yes	14	1600	48.2	LRM0014A-C	\$133	5 x 4.4 x 3.1	4.3	LRM0014A-E	\$315	8 x 8 x 6	11.3
Mbbb-03400100	Yes	21	1100	57.4	LRM0021A-C	\$148	6.1 x 6 x 2.6	7.2	LRM0021A-E	\$315	13.3 x 13.2 x 13.1	25.2
Mbbb-04400150	Yes	21	1100	57.4	LRM0021A-C	\$148	6.1 x 6 x 2.6	7.2	LRM0021A-E	\$315	13.3 x 13.2 x 13.1	25.2
Mbbb-04400172	Yes	28	820	68.8	LRM0028A-C	\$138	6.1 x 6 x 3.3	9	LRM0028A-E	\$295	13.3 x 13.2 x 13.1	28.4
Mccc-05400270	Yes	35	710	102	LRM0035A-C	\$170	6 x 7.2 x 3.8	13	LRM0035A-E	\$315	13.3 x 13.2 x 13.1	31
Mccc-05400300	Yes	35	710	102	LRM0035A-C	\$170	6 x 7.2 x 3.8	13	LRM0035A-E	\$315	13.3 x 13.2 x 13.1	31
Mccc-06400350	Yes	46	550	99	LRM0046A-C	\$235	6 x 7.2 x 4.3	17	LRM0046A-E	\$400	13.3 x 13.2 x 13.1	35
Mccc-06400420	Yes	46	550	99	LRM0046A-C	\$235	6 x 7.2 x 4.3	17	LRM0046A-E	\$400	13.3 x 13.2 x 13.1	35
Mccc-06400470	Yes	65	380	105	LRM0065A-C	\$355	6 x 7.2 x 4.3	22	LRM0065A-E	\$505	13.3 x 13.2 x 13.1	40
Mccc-07400660	Yes	83	290	155	LRM0083A-C	\$355	7 x 9 x 6.5	26	LRM0083A-E	\$505	13.3 x 13.2 x 13.1	44
Mccc-07400770	Yes	104	230	200	LRM0104A-C	\$385	7 x 9 x 7	28	LRM0104A-E	\$540	13.3 x 13.2 x 13.1	46
Mccc-07401000	Yes	130	180	197	LRM0130A-C	\$480	7.5 x 9.3 x 6.8	37	LRM0130A-E	\$690	13.3 x 13.2 x 13.1	55
Mccc-08401340	Yes	160	155	195	LRM0160A-C	\$665	7.5 x 9.3 x 8.3	49	LRM0160A-E	\$940	13.3 x 13.2 x 13.1	67
Mccc-08401570	Yes	200	115	224	LRM0200A-C	\$505	7.5 x 9.3 x 8.3	49	LRM0200A-E	\$850	24 x 16.9 x 18.4	82
Mddd-09402000A	Yes	250	95	284	LRM0250A-C	\$890	7.5 x 9.3 x 8.5	55	LRM0250A-E	\$1,155	24 x 16.9 x 18.4	82
Mddd-09402000E	No	250	95	284	LRM0250A-C	\$890	7.5 x 9.3 x 8.5	55	LRM0250A-E	\$1,155	24 x 16.9 x 18.4	82
Mddd-09402240A	Yes	322	70	383	LRM0322A-C	\$925	8.8 x 10.8 x 8.5	76	LRM0322A-E	\$1,625	47 x 26.5 x 24.9	220
Mddd-09402240E	No	322	70	383	LRM0322A-C	\$925	8.8 x 10.8 x 8.5	76	LRM0322A-E	\$1,625	47 x 26.5 x 24.9	220
Meee-10402700	No	322	70	383	LRM0322A-C	\$925	8.8 x 10.8 x 8.5	76	LRM0322A-E	\$1,625	47 x 26.5 x 24.9	220
Meee-10403200	No	414	66	531	LRM0414A-C	\$1,610	8.8 x 9 x 11.5	98	LRM0414A-E	\$2,000	47 x 26.5 x 24.9	242
Meee-11403770	No	515	50	496	LRM0515A-C	\$1,805	8.8 x 9 x 12	118	LRM0515A-E	\$2,640	47 x 26.5 x 24.9	262
Meee-11404170	No	515	50	496	LRM0515A-C	\$1,805	8.8 x 9 x 12	118	LRM0515A-E	\$2,640	47 x 26.5 x 24.9	262
Meee-11404640	No	515	50	496	LRM0515A-C	\$1,805	8.8 x 9 x 12	118	LRM0515A-E	\$2,640	47 x 26.5 x 24.9	262

aaa = Unidrive M100, M101, M200, M201, M300, HS30, M400
 bbb = Unidrive M600, M700, M701, M702, HS70, HS71, HS72
 ccc = Unidrive M200, M201, M300, M400, M600, M700, M701, M702, HS70, HS71, HS72
 ddd = Unidrive M200, M201, M300, M400, M600, M700, M701, M702
 eee = Unidrive M600, M700, M701, M702

Line reactors are recommended for AC drives that do not include a built-in inductor.
 For drive modules that include DC or AC inductors built-in, the line reactors above provide additional impedance.



Output Load Reactors - 460 Vac



Load Reactor 1.5%

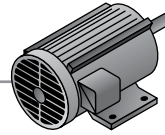
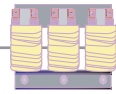

460 Vac, 3 Phase									
Drive	Amps	Inductance (µH)	Watts Loss	Chassis Mount			NEMA 1 Enclosed		
				Order Code	Dimensions H x W x D (in)	Weight (lbs)	Order Code	Dimensions H x W x D (in)	Weight (lbs)
Maaa-02400013	2.1	11000	14.3	LRM002A1-C	3.7 x 4.5 x 1.5	1.6	LRM002A1-E	8 x 8 x 6	8.6
Maaa-02400018	3.4	6800	19.6	LRM003A4-C	3.7 x 4.5 x 1.5	1.6	LRM003A4-E	8 x 8 x 6	8.6
Maaa-02400023	3.4	6800	19.6	LRM003A4-C	3.7 x 4.5 x 1.5	1.6	LRM003A4-E	8 x 8 x 6	8.6
Maaa-02400032	4.8	4800	23	LRM004A8-C	3.7 x 4.5 x 1.5	1.8	LRM003A4-E	8 x 8 x 6	8.6
Maaa-02400041	7.6	3000	37.2	LRM007A6-C	5 x 4.4 x 2.8	2.8	LRM007A6-E	8 x 8 x 6	9.8
Maaa-03400056	7.6	1500	19.2	LRL007A6-C	3.7 x 4.5 x 1.5	1.8	LRL007A6-E	8 x 8 x 6	8.8
Maaa-03400073	11	2100	40.9	LRM0011A-C	5 x 4.4 x 3.1	4.2	LRM0011A-E	8 x 8 x 6	11.2
Maaa-03400094	14	1600	48.2	LRM0014A-C	5 x 4.4 x 3.1	4.3	LRM0014A-E	8 x 8 x 6	11.3
Maaa-04400135	21	1100	57.4	LRM0021A-C	6.1 x 6 x 2.6	7.2	LRM0021A-E	13.3 x 13.2 x 13.1	25.2
Maaa-04400170	21	530	38.3	LRL0021A-C	5.3 x 4.4 x 3.3	4.2	LRL0021A-E	13.3 x 13.2 x 13.1	22.2
Mbbb-03400025	4.8	4800	23	LRM004A8-C	3.7 x 4.5 x 1.5	1.8	LRM003A4-E	8 x 8 x 6	8.6
Mbbb-03400031	7.6	3000	37.2	LRM007A6-C	5 x 4.4 x 2.8	2.8	LRM007A6-E	8 x 8 x 6	9.8
Mbbb-03400045	11	2100	40.9	LRM0011A-C	5 x 4.4 x 3.1	4.2	LRM0011A-E	8 x 8 x 6	11.2
Mbbb-03400062	11	2100	40.9	LRM0011A-C	5 x 4.4 x 3.1	4.2	LRM0011A-E	8 x 8 x 6	11.2
Mbbb-03400078	14	1600	48.2	LRM0014A-C	5 x 4.4 x 3.1	4.3	LRM0014A-E	8 x 8 x 6	11.3
Mbbb-03400100	21	1100	57.4	LRM0021A-C	6.1 x 6 x 2.6	7.2	LRM0021A-E	13.3 x 13.2 x 13.1	25.2
Mbbb-04400150	28	820	68.8	LRM0028A-C	6.1 x 6 x 3.3	9	LRM0028A-E	13.3 x 13.2 x 13.1	28.4
Mbbb-04400172	35	710	102	LRM0035A-C	6 x 7.2 x 3.8	13	LRM0035A-E	13.3 x 13.2 x 13.1	31
Mccc-05400270	46	300	77	LRL0046A-C	6 x 7.2 x 3.8	13	LRL0046A-E	13.3 x 13.2 x 13.1	31
Mccc-05400300	46	300	77	LRL0046A-C	6 x 7.2 x 3.8	13	LRL0046A-E	13.3 x 13.2 x 13.1	31
Mccc-06400350	55	270	67	LRL0055A-C	6 x 7.2 x 4	18	LRL0055A-E	13.3 x 13.2 x 13.1	36
Mccc-06400420	65	190	87	LRL0065A-C	6 x 7.2 x 4	18	LRL0065A-E	13.3 x 13.2 x 13.1	36
Mccc-06400470	83	170	119	LRL0083A-C	6 x 7.2 x 4.3	19	LRL0083A-E	13.3 x 13.2 x 13.1	37
Mccc-07400660	104	120	94	LRL0104A-C	6 x 7.2 x 6.5	22	LRL0104A-E	13.3 x 13.2 x 13.1	40
Mccc-07400770	130	95	132	LRL0130A-C	7.5 x 9.3 x 6.8	26	LRL0130A-E	13.3 x 13.2 x 13.1	44
Mccc-07401000	160	80	110	LRL0160A-C	7.5 x 9.3 x 6.8	34	LRL0160A-E	13.3 x 13.2 x 13.1	52
Mccc-08401340	200	60	159	LRL0200A-C	7.5 x 9.3 x 7	34	LRL0200A-E	24 x 16.9 x 18.4	61
Mccc-08401570	250	50	275	LRL0250A-C	7.5 x 9.5 x 7.5	35	LRL0250A-E	24 x 16.9 x 18.4	62
Mddd-09402000	322	50	300	LRL0322A-C	7.5 x 9.3 x 9	57	LRL0322A-E	24 x 16.9 x 18.4	84
Mddd-09402240	414	33	333	LRL0414A-C	8.8 x 9 x 9.5	78	LRL0414A-E	47 x 26.5 x 24.9	222
Meee-10402700	414	33	333	LRL0414A-C	8.8 x 9 x 9.5	78	LRL0414A-E	47 x 26.5 x 24.9	222
Meee-10403200	515	25	314	LRL0515A-C	8.8 x 9 x 9.5	81	LRL0515A-E	47 x 26.5 x 24.9	225
Meee-11403770	515	25	314	LRL0515A-C	8.8 x 9 x 9.5	81	LRL0515A-E	47 x 26.5 x 24.9	225
Meee-11404170	515	25	314	LRL0515A-C	8.8 x 9 x 9.5	81	LRL0515A-E	47 x 26.5 x 24.9	225
Meee-11404640	515	25	314	LRL0515A-C	8.8 x 9 x 9.5	81	LRL0515A-E	47 x 26.5 x 24.9	225

aaa = Unidrive M100, M101, M200, M201, M300, HS30, M400
 bbb = Unidrive M600, M700, M701, M702, HS70, HS71, HS72
 ccc = Unidrive M200, M201, M300, M400, M600, M700, M701, M702, HS70, HS71, HS72
 ddd = Unidrive M200, M201, M300, M400, M600, M700, M701, M702
 eee = Unidrive M600, M700, M701, M702

Consult factory for different percentage impedance and NEMA 3R outdoor enclosure options.



Input Line Reactors - 575 Vac & 690 Vac



575 Vac, 3 Phase 50/60 Hz										
Drive	Built-in Inductor	Amps	Inductance (μH)	Watts Loss	Chassis Mount			NEMA 1 Enclosed		
					Order Code	Dimensions H x W x D (in)	Weight (lbs)	Order Code	Dimensions H x W x D (in)	Weight (lbs)
Mccc-05500030	Yes	4.8	7700	37.5	LRH004A8-C	5 x 4.4 x 2.8	2.8	LRH004A8-E	8 x 8.1 x 6.1	8.6
Mccc-05500040	Yes	7.6	4800	47.8	LRH007A6-C	5 x 4.4 x 3.1	4.1	LRH007A6-E	8 x 8 x 6	11.1
Mccc-05500069	Yes	11	2100	40.9	LRM0011A-C	5 x 4.4 x 3.1	4.2	LRM0011A-E	8 x 8 x 6	11.2
Mccc-06500100	Yes	14	2600	60.6	LRH0014A-C	5.8 x 6 x 2.9	7.1	LRH0014A-E	8 x 8.1 x 6.1	12.3
Mccc-06500150	Yes	21	1800	73.5	LRH0021A-C	6.1 x 6 x 3.3	10	LRH0021A-E	13.3 x 13.2 x 13.1	28
Mccc-06500190	Yes	28	1300	93.8	LRH0028A-C	6.1 x 6 x 3.3	10.4	LRH0028A-E	13.3 x 13.2 x 13.1	28.4
Mccc-06500230	Yes	35	1200	121	LRH0035A-C	6 x 7.2 x 4.3	18	LRH0035A-E	13.3 x 13.2 x 13.1	27
Mccc-06500290	Yes	46	550	99	LRM0046A-C	6 x 7.2 x 4.3	17	LRM0046A-E	13.3 x 13.2 x 13.1	35
Mccc-06500350	Yes	55	480	109	LRM0055A-C	6 x 7.2 x 4.3	20	LRM0055A-E	13.3 x 13.2 x 13.1	38
Mccc-07500440	Yes	46	550	99	LRM0046A-C	6 x 7.2 x 4.3	17	LRM0046A-E	13.3 x 13.2 x 13.1	35
Mccc-07500550	Yes	65	380	105	LRM0065A-C	6 x 7.2 x 4.3	22	LRM0065A-E	13.3 x 13.2 x 13.1	40
Mccc-08500630	Yes	83	290	155	LRM0083A-C	7 x 9 x 6.5	26	LRM0083A-E	13.3 x 13.2 x 13.1	44
Mccc-08500860	Yes	104	230	200	LRM0104A-C	7 x 9 x 7	28	LRM0104A-E	13.3 x 13.2 x 13.1	46
Mddd-09501040A	Yes	130	180	197	LRM0130A-C	7.5 x 9.3 x 6.8	37	LRM0130A-E	13.3 x 13.2 x 13.1	55
Mddd-09501040E	No	130	180	197	LRM0130A-C	7.5 x 9.3 x 6.8	37	LRM0130A-E	13.3 x 13.2 x 13.1	55
Mddd-09501310A	Yes	160	155	195	LRM0160A-C	7.5 x 9.3 x 8.3	49	LRM0160A-E	13.3 x 13.2 x 13.1	67
Mddd-09501310E	No	160	155	195	LRM0160A-C	7.5 x 9.3 x 8.3	49	LRM0160A-E	13.3 x 13.2 x 13.1	67
Meee-10501520	No	250	95	284	LRM0250A-C	7.5 x 9.3 x 8.5	55	LRM0250A-E	24 x 16.9 x 18.4	82
Meee-10501900	No	250	95	284	LRM0250A-C	7.5 x 9.3 x 8.5	55	LRM0250A-E	24 x 16.9 x 18.4	82
Meee-11502000	No	250	95	284	LRM0250A-C	7.5 x 9.3 x 8.5	55	LRM0250A-E	24 x 16.9 x 18.4	82
Meee-11502540	No	322	70	383	LRM0322A-C	8.8 x 10.8 x 8.5	76	LRM0322A-E	47 x 26.5 x 24.9	220
Meee-11502850	No	322	70	383	LRM0322A-C	8.8 x 10.8 x 8.5	76	LRM0322A-E	47 x 26.5 x 24.9	220

690 Vac, 3 Phase 50/60 Hz										
Drive	Built-in Inductor	Amps	Inductance (μH)	Watts Loss	Chassis Mount			NEMA 1 Enclosed		
					Order Code	Dimensions H x W x D (in)	Weight (lbs)	Order Code	Dimensions H x W x D (in)	Weight (lbs)
Mccc-07600190	Yes	21	1800	73.5	LRH0021A-C	6.1 x 6 x 3.3	10	LRH0021A-E	13.3 x 13.2 x 13.1	28
Mccc-07600240	Yes	28	1300	93.8	LRH0028A-C	6.1 x 6 x 3.3	10.4	LRH0028A-E	13.3 x 13.2 x 13.1	28.4
Mccc-07600290	Yes	35	1200	121	LRH0035A-C	6 x 7.2 x 4.3	18	LRH0035A-E	13.3 x 13.2 x 13.1	27
Mccc-07600380	Yes	46	980	179	LRH0046A-C	8.3 x 9 x 4.8	24	LRH0046A-E	13.3 x 13.2 x 13.1	35
Mccc-07600440	Yes	46	980	179	LRH0046A-C	8.3 x 9 x 4.8	24	LRH0046A-E	13.3 x 13.2 x 13.1	35
Mccc-07600540	Yes	65	640	214	LRH0065A-C	7 x 9 x 6.5	26	LRH0065A-E	13.3 x 13.2 x 13.1	40
Mccc-08600630	Yes	83	510	197	LRH0083A-C	7 x 9 x 6.8	35	LRH0083A-E	13.3 x 13.2 x 13.1	44
Mccc-08600860	Yes	104	375	208	LRH0104A-C	7 x 7.3 x 7.3	41	LRH0104A-E	13.3 x 13.2 x 13.1	46
Mddd-09601040A	Yes	130	300	197	LRH0130A-C	7.5 x 9.3 x 8.3	52	LRH0130A-E	13.3 x 13.2 x 13.1	55
Mddd-09601040E	No	130	300	197	LRH0130A-C	7.5 x 9.3 x 8.3	52	LRH0130A-E	13.3 x 13.2 x 13.1	55
Mddd-09601310A	Yes	160	260	309	LRH0160A-C	7.5 x 9.3 x 8.3	53	LRH0160A-E	24 x 17.1 x 18.4	67
Mddd-09601310E	No	160	260	309	LRH0160A-C	7.5 x 9.3 x 8.3	53	LRH0160A-E	24 x 17.1 x 18.4	67
Meee-10601500	No	200	200	293	LRH0200A-C	8.3 x 10.8 x 9	75	LRM0200A-E	24 x 16.9 x 18.4	82
Meee-10601780	No	200	200	293	LRH0200A-C	8.3 x 10.8 x 9	75	LRM0200A-E	24 x 16.9 x 18.4	82
Meee-11602100	No	250	160	402	LRH0250A-C	7.5 x 9.3 x 8.5	93	LRH0250A-E	24 x 16.9 x 18.4	120
Meee-11602380	No	322	130	494	LRH0322A-C	8.8 x 10.8 x 8.5	108	LRH0322A-E	47 x 26.5 x 24.9	252
Meee-11602630	No	322	130	494	LRH0322A-C	8.8 x 10.8 x 8.5	108	LRH0322A-E	47 x 26.5 x 24.9	252

ccc = Unidrive M200, M201, M300, M400, M600, M700, M701, M702, HS70, HS71, HS72

ddd = Unidrive M200, M201, M300, M400, M600, M700, M701, M702

eee = Unidrive M600, M700, M701, M702

Line reactors are recommended for AC drives that do not include a built-in inductor. For drive modules that include DC or AC inductors built-in, the line reactors above provide additional impedance. Consult factory for different percentage impedance and NEMA 3R outdoor enclosure options.



Output Load Reactors - 575 Vac & 690 Vac

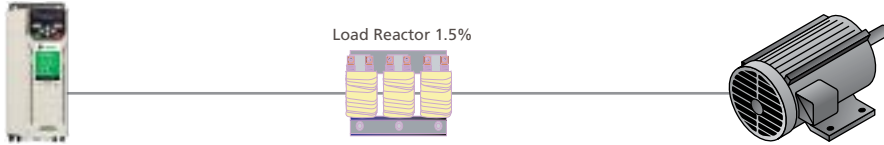

575 Vac, 3 Phase									
Drive	Amps	Inductance (µH)	Watts Loss	Chassis Mount			NEMA 1 Enclosed		
				Order Code	Dimensions H x W x D (in)	Weight (lbs)	Order Code	Dimensions H x W x D (in)	Weight (lbs)
Mccc-05500030	7.6	4800	47.8	LRH007A6-C	5 x 4.4 x 3.1	4.1	LRH007A6-E	8 x 8 x 6	11.1
Mccc-05500040	11	2100	40.9	LRM0011A-C	5 x 4.4 x 3.1	4.2	LRM0011A-E	8 x 8 x 6	11.2
Mccc-05500069	14	1600	48.2	LRM0014A-C	5 x 4.4 x 3.1	4.3	LRM0014A-E	8 x 8 x 6	11.3
Mccc-06500100	21	1800	73.5	LRH0021A-C	5 x 4.4 x 3.1	4.3	LRH0021A-E	13.3 x 13.2 x 13.1	28
Mccc-06500150	28	820	68.8	LRM0028A-C	5 x 4.4 x 3.1	4.3	LRM0028A-E	13.3 x 13.2 x 13.1	28.4
Mccc-06500190	28	820	68.8	LRM0028A-C	5 x 4.4 x 3.1	4.3	LRM0028A-E	13.3 x 13.2 x 13.1	28.4
Mccc-06500230	35	400	49	LRL0035A-C	5 x 4.4 x 3.1	4.3	LRL0035A-E	13.3 x 13.2 x 13.1	28
Mccc-06500290	46	300	77	LRL0046A-C	5 x 4.4 x 3.1	4.3	LRL0046A-E	13.3 x 13.2 x 13.1	31
Mccc-06500350	55	270	67	LRL0055A-C	5 x 4.4 x 3.1	4.3	LRL0055A-E	13.3 x 13.2 x 13.1	36
Mccc-07500440	83	290	155	LRM0083A-C	5 x 4.4 x 3.1	4.3	LRM0083A-E	13.3 x 13.2 x 13.1	44
Mccc-07500550	104	230	200	LRM0104A-C	5 x 4.4 x 3.1	4.3	LRM0104A-E	13.3 x 13.2 x 13.1	46
Mccc-08500630	130	180	197	LRM0130A-C	5 x 4.4 x 3.1	4.3	LRM0130A-E	13.3 x 13.2 x 13.1	55
Mccc-08500860	160	155	195	LRM0160A-C	5 x 4.4 x 3.1	4.3	LRM0160A-E	13.3 x 13.2 x 13.1	67
Mddd-09501040	160	80	110	LRL0160A-C	7.5 x 9.3 x 6.8	34	LRL0160A-E	13.3 x 13.2 x 13.1	52
Mddd-09501310	200	115	224	LRM0200A-C	7.5 x 9.3 x 8.3	49	LRM0200A-E	24 x 16.9 x 18.4	82
Meee-10501520	250	95	284	LRM0250A-C	7.5 x 9.3 x 8.5	55	LRM0250A-E	24 x 16.9 x 18.4	82
Meee-10501900	250	95	284	LRM0250A-C	7.5 x 9.3 x 8.5	55	LRM0250A-E	24 x 16.9 x 18.4	82
Meee-11502000	250	95	284	LRM0250A-C	7.5 x 9.3 x 8.5	55	LRM0250A-E	24 x 16.9 x 18.4	82
Meee-11502540	322	70	383	LRM0322A-C	8.8 x 10.8 x 8.5	76	LRM0322A-E	47 x 26.5 x 24.9	220
Meee-11502850	322	70	383	LRM0322A-C	8.8 x 10.8 x 8.5	76	LRM0322A-E	47 x 26.5 x 24.9	220

690 Vac, 3 Phase									
Drive	Amps	Inductance (µH)	Watts Loss	Chassis Mount			NEMA 1 Enclosed		
				Order Code	Dimensions H x W x D (in)	Weight (lbs)	Order Code	Dimensions H x W x D (in)	Weight (lbs)
Mccc-07600190	35	710	102	LRM0035A-C	6 x 7.2 x 3.8	13	LRM0035A-E	13.3 x 13.2 x 13.1	31
Mccc-07600240	46	550	99	LRM0046A-C	6 x 7.2 x 4.3	17	LRM0046A-E	13.3 x 13.2 x 13.1	35
Mccc-07600290	46	550	99	LRM0046A-C	6 x 7.2 x 4.3	17	LRM0046A-E	13.3 x 13.2 x 13.1	35
Mccc-07600380	65	380	105	LRM0065A-C	6 x 7.2 x 4.3	22	LRM0065A-E	13.3 x 13.2 x 13.1	40
Mccc-07600440	65	380	105	LRM0065A-C	6 x 7.2 x 4.3	22	LRM0065A-E	13.3 x 13.2 x 13.1	40
Mccc-07600540	104	230	200	LRM0104A-C	7 x 9 x 7	28	LRM0104A-E	13.3 x 13.2 x 13.1	46
Mccc-08600630	130	180	197	LRM0130A-C	7.5 x 9.3 x 6.8	37	LRM0130A-E	13.3 x 13.2 x 13.1	55
Mccc-08600860	160	155	195	LRM0160A-C	7.5 x 9.3 x 8.3	49	LRM0160A-E	13.3 x 13.2 x 13.1	67
Mddd-09601040	160	155	195	LRM0160A-C	7.5 x 9.3 x 8.3	49	LRM0160A-E	13.3 x 13.2 x 13.1	67
Mddd-09601310	200	115	224	LRM0200A-C	7.5 x 9.3 x 8.3	49	LRM0200A-E	24 x 16.9 x 18.4	82
Meee-10601500	250	95	284	LRM0250A-C	7.5 x 9.3 x 8.5	55	LRM0250A-E	24 x 16.9 x 18.4	82
Meee-10601780	250	95	284	LRM0250A-C	7.5 x 9.3 x 8.5	55	LRM0250A-E	24 x 16.9 x 18.4	82
Meee-11602100	250	95	284	LRM0250A-C	7.5 x 9.3 x 8.5	55	LRM0250A-E	24 x 16.9 x 18.4	82
Meee-11602380	322	70	383	LRM0322A-C	8.8 x 10.8 x 8.5	76	LRM0322A-E	47 x 26.5 x 24.9	220
Meee-11602630	322	70	383	LRM0322A-C	8.8 x 10.8 x 8.5	76	LRM0322A-E	47 x 26.5 x 24.9	220

ccc = Unidrive M200, M201, M300, M400, M600, M700, M701, M702, HS70, HS71, HS72
ddd = Unidrive M200, M201, M300, M400, M600, M700, M701, M702
eee = Unidrive M600, M700, M701, M702

Consult factory for different percentage impedance and NEMA 3R outdoor enclosure options.



Isolation Transformers

Drive isolation transformers add an extra margin of protection for AC drives. They are sized to the drive kVA requirements and are designed to withstand the mechanical stress of current reversals and short circuits associated with power semiconductor type AC drives.

- Three-coil, delta-wye configuration with fully rated NEMA 1 enclosure
- $\pm 5\%$ fully rated taps on primary winding
- Ambient temperature: 104 °F (40 °C)
- Standards: ANSI C89.2, NEMA ST-20, UL506, UL1561

Features:

- Provide electrical isolation between the incoming line and the drive electronics
- Convert input line voltage to standard drive input voltages
- Minimize line disturbances caused by SCR power converters
- Reduce power line harmonics caused by drives
- Protect the motor controller by reducing available short circuit potential. This may be a UL requirement in installations with high levels of short circuit potential



Size	Wt. (lbs)	HP	kVA	Primary Voltage	Secondary Voltage		
					230 Vac	460 Vac	
A	150	5	7.5	230	8812-0007-1	8812-0007-2	
				460	8812-0007-3	8812-0007-4	
	160	7.5	11	230	8812-0011-1	8812-0011-2	
				460	8812-0011-3	8812-0011-4	
	170	10	14	230	8812-0014-1	8812-0014-2	
				460	8812-0014-3	8812-0014-4	
B	240	15	20	230	8812-0020-1	8812-0020-2	
				460	8812-0020-3	8812-0020-4	
	300	20	27	230	8812-0027-1	8812-0027-2	
				460	8812-0027-3	8812-0027-4	
	330	25	34	230	8812-0034-1	8812-0034-2	
				460	8812-0034-3	8812-0034-4	
	350	30	40	230	8812-0040-1	8812-0040-2	
				460	8812-0040-3	8812-0040-4	
	430	40	51	230	8812-0051-1	8812-0051-2	
				460	8812-0051-3	8812-0051-4	
	C	530	50	63	230	8812-0063-1	8812-0063-2
					460	8812-0063-3	8812-0063-4
580		60	75	230	8812-0075-1	8812-0075-2	
				460	8812-0075-3	8812-0075-4	
630		75	93	230	8812-0093-1	8812-0093-2	
				460	8812-0093-3	8812-0093-4	
730	100	118	230	8812-0118-1	8812-0118-2		
			460	8812-0118-3	8812-0118-4		
D	830	125	145	230	8812-0145-1	8812-0145-2	
				460	8812-0145-3	8812-0145-4	
	930	150	175	230	8812-0175-1	8812-0175-2	
				460	8812-0175-3	8812-0175-4	
	1350	200	220	230	8812-0220-1	8812-0220-2	
				460	8812-0220-3	8812-0220-4	
E	1500	250	275	230	8812-0275-1	8812-0275-2	
				460	8812-0275-3	8812-0275-4	
	1700	300	330	230	8812-0330-1	8812-0330-2	
460				8812-0330-3	8812-0330-4		
F	2100	400	440	460		8812-0440-4	
	2350	500	550	460		8812-0550-4	

Order Code

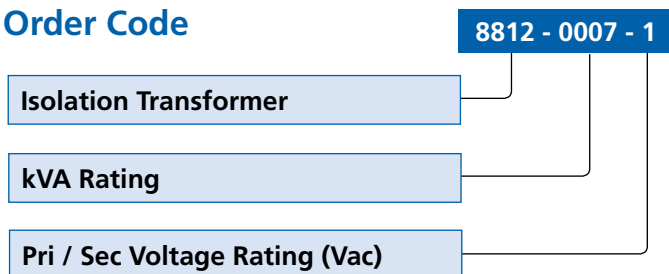

Size	Dimensions H x W x D (in)
A	21.5 x 19.4 x 20.2
B	28.8 x 23.9 x 25
C	38 x 26 x 25
D	41 x 32 x 29.5
E	51.5 x 39.5 x 34
F	59 x 48.5 x 38.4

Drive EMC Filters

Electromagnetic Compatibility Filters

EMC filters are used to minimize high-frequency power supply line disturbances caused by drives that may interfere with proper operation of sensitive electronic equipment. These specific filters have been assessed for conformance with the EMC directive by testing with the appropriate Control Techniques' brand drives.

EMC data sheets are available for digital drive products. These data sheets list the applicable harmonic standards and give recommended installation techniques and further information on EMC behavior in typical situations.

All Control Techniques' AC drives include internal EMC filters. The filters listed in the following tables are used in addition to the standard onboard filter to provide additional interference reduction. Refer to the specific drive EMC data sheets for details of levels of compliance with IEC standards.

Filter Types

- Low Leakage: low leakage filters limit the leakage current to ground. The length of the motor cable is severely restricted when these filters are applied.
- Standard: standard filters are designed for use in industrial or residential applications with longer motor lead lengths.



EMC (RFI) Filters

115 Vac, Single Phase

Frame	Type	Order Code	Product Compatibility					
			M100	M200-M300	HS30	M400	M600-M700	HS70
1	Standard	4200-1000	Y	Y	Y	Y		
1	Low leakage	4200-1001	Y	Y	Y	Y		
2	Standard	4200-2000	Y	Y	Y	Y		

230 Vac, Single Phase

Frame	Type	Order Code	Product Compatibility					
			M100	M200-M300	HS30	M400	M600-M700	HS70
1	Standard	4200-1000	Y	Y	Y	Y		
1	Low leakage	4200-1001	Y	Y	Y	Y		
2	Standard	4200-2001	Y	Y	Y	Y		
2	Low leakage	4200-2002	Y	Y	Y	Y		
3	Standard	4200-3000	Y	Y	Y	Y		
3	Low leakage	4200-3001	Y	Y	Y	Y		
4	Standard	4200-4000	Y	Y	Y	Y		
4	Low leakage	4200-4001	Y	Y	Y	Y		

230 Vac, 3 Phase

Frame	Type	Order Code	Product Compatibility					
			M100	M200-M300	HS30	M400	M600-M700	HS70
1	Standard	4200-1000	Y	Y	Y	Y		
2	Low leakage	4200-2004	Y	Y	Y	Y		
3	Standard	4200-3004	Y	Y	Y	Y		
3	Low leakage	4200-3005	Y	Y	Y	Y		
3	Standard	4200-3230					Y	Y
4	Standard	4200-4002	Y	Y	Y	Y		
4	Low leakage	4200-4003	Y	Y	Y	Y		
4	Standard	4200-0272					Y	Y
5	Standard	4200-0312		Y		Y	Y	Y
6	Standard	4200-2300		Y		Y	Y	Y
7	Standard	4200-1132		Y		Y	Y	Y
8	Standard	4200-1972		Y		Y	Y	Y
9A	Standard	4200-3021		Y		Y	Y	Y
9E/T & 10	Standard	4200-4460		Y		Y	Y	Y

460 Vac, 3 Phase

Frame	Type	Order Code	Product Compatibility					
			M100	M200-M300	HS30	M400	M600-M700	HS70
1	Standard	4200-1000	Y	Y	Y	Y		
2	Low leakage	4200-2006	Y	Y	Y	Y		
3	Standard	4200-3008	Y	Y	Y	Y		
3	Low leakage	4200-3009	Y	Y	Y	Y		
3	Standard	4200-3480					Y	Y
4	Standard	4200-4004	Y	Y	Y	Y		
4	Low leakage	4200-4005	Y	Y	Y	Y		
4	Standard	4200-0252					Y	Y
5	Standard	4200-0402		Y		Y	Y	Y
6	Standard	4200-4800		Y		Y	Y	Y
7	Standard	4200-1132		Y		Y	Y	Y
8	Standard	4200-1972		Y		Y	Y	Y
9A	Standard	4200-3021		Y		Y	Y	Y
9E/T & 10	Standard	4200-4460		Y		Y	Y	Y
11	Standard	4200-0400					Y	Y

575 Vac and 690 Vac, 3 Phase

Frame	Type	Order Code	Product Compatibility					
			M100	M200-M300	HS30	M400	M600-M700	HS70
1	Standard	4200-1000	Y	Y	Y	Y		
6	Standard	4200-3690		Y		Y	Y	Y
7	Standard	4200-0672		Y		Y	Y	Y
8	Standard	4200-1662		Y		Y	Y	Y
9A	Standard	4200-1660		Y		Y	Y	Y
9E/T & 10	Standard	4200-2210		Y		Y	Y	Y
11	Standard	4200-0690					Y	Y

* 690 Vac and 575 Vac

Dynamic Braking Resistors

Dynamic Braking (DB)

The DC bus voltage level of an AC drive increases while the motor is re-generating (i.e. ramping to a stop). Dynamic braking resistors provide a means of rapidly stopping a rotating motor and load while maintaining an acceptable bus voltage level. The kinetic energy stored in the spinning mass is converted into electrical energy and quickly dissipated as heat through a resistor.

Dynamic Braking for AC Drives

AC drives provide a constant torque stopping profile when a dynamic brake resistor is applied across the DC bus circuit. Dynamic braking can be employed under a stop command or anytime a decrease in motor speed is commanded, provided the AC drive is enabled and programmed for ramp stop (fast ramp mode).

Two types of dynamic braking kits are available for Control Techniques' AC Drives. The E-stop duty kits are rated for light start/stop or deceleration duty cycles.

The cyclic duty kits are intended for heavy duty applications that need the capability to dissipate regenerated energy on a more continuous or repetitive basis such as downhill conveyors, hoists, feeders and dynamometers.



Galvanized NEMA 1 with normally closed thermostat

E-Stop Duty

E-stop duty DB resistors are designed for absorbing energy generated by infrequent motor stops or deceleration.

These kits are designed to meet or exceed NEMA standard 7-15-1970, which states "DB resistors will not exceed their rated temperature rise when the drive is braked from maximum speed to standstill three times in rapid succession with a load inertia equal to or less than the motor inertia." They are designed to provide 150% braking torque for 1800 rpm base speed motors.

DB Resistors for AC Drives

Unidrive M drives are equipped with built-in dynamic braking transistors. Simply select the proper braking resistor needed for the size of drive and duty cycle. Other mounting arrangements and enclosures are available on request.

The brake circuit must include an external thermal protection device connected (as shown in the circuit diagram) unless the resistor has built-in protection.

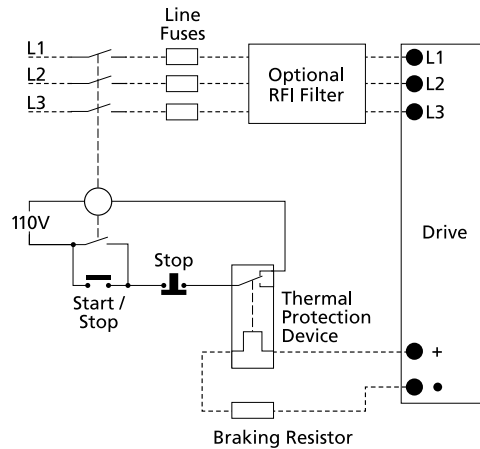

Cyclic Duty

The standard packages listed below are NEMA 1 rated and include built-in junction box, terminal strip, normally closed thermal contact (klixon switch) and resistors pre-wired with high-temperature Teflon wire.

These heavy-duty kits have been designed to provide dynamic braking for cyclic and continuous braking applications. There are three levels available: 10%, 25% and 50%. These levels refer to the continuous allowable braking level (i.e. 25% refers to 25% of rated motor braking torque) or the maximum allowable duty cycle rates with maximum specified "on-time" limitations (refer to illustration below).

$$\text{Duty Cycle} = \frac{\text{On Time} (\leq \text{max "on" time})}{\text{On Time} + \text{Off Time}}$$

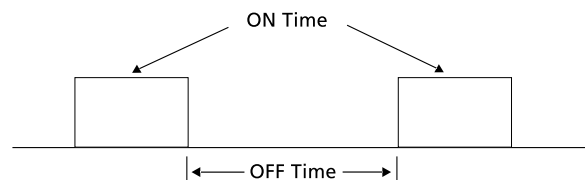

Dynamic Braking Resistors

Dynamic Braking Resistors - 230 Vac Galvanized NEMA 1 Enclosed

Drives	Heavy Duty HP	E-Stop Duty Panel Mounted No Thermostat		E-Stop Duty - NEMA 1 Normally Closed Thermostat		10% Duty Rated Normally Closed Thermostat		25% Duty Rated Normally Closed Thermostat		50% Duty Rated Normally Closed Thermostat	
		Order Code	Dims. H x W x D (in)	Order Code	Dims. H x W x D (in)	Order Code	Dims. H x W x D (in)	Order Code	Dims. H x W x D (in)	Order Code	Dims. H x W x D (in)
Maaa-01100017	0.33	DBR-1500-00300-P	10 x 3 x 3	DBR-1500-00300-ENC	5 x 14 x 4	DBR-1500-00300-ENC	5 x 14 x 4	DBR-1500-00300-ENC	5 x 14 x 4	DBR-1500-00300-ENC	5 x 14 x 4
Maaa-01100024	0.5	DBR-1500-00300-P	10 x 3 x 3	DBR-1500-00300-ENC	5 x 14 x 4	DBR-1500-00300-ENC	5 x 14 x 4	DBR-1500-00300-ENC	5 x 14 x 4	DBR-1500-00300-ENC	5 x 14 x 4
Maaa-02100042	1	DBR-1500-00300-P	10 x 3 x 3	DBR-1500-00300-ENC	5 x 14 x 4	DBR-1500-00300-ENC	5 x 14 x 4	DBR-1500-00300-ENC	5 x 14 x 4	DBR-1500-00600-ENC	5 x 14 x 4
Maaa-02100056	1.5	DBR-1500-00300-P	10 x 3 x 3	DBR-1500-00300-ENC	5 x 14 x 4	DBR-1500-00300-ENC	5 x 14 x 4	DBR-1500-00300-ENC	5 x 14 x 4	DBR-1500-00600-ENC	5 x 14 x 4
Maaa-01200017	0.33	DBR-1500-00300-P	10 x 3 x 3	DBR-1500-00300-ENC	5 x 14 x 4	DBR-1500-00300-ENC	5 x 14 x 4	DBR-1500-00300-ENC	5 x 14 x 4	DBR-1500-00300-ENC	5 x 14 x 4
Maaa-01200024	0.5	DBR-1500-00300-P	10 x 3 x 3	DBR-1500-00300-ENC	5 x 14 x 4	DBR-1500-00300-ENC	5 x 14 x 4	DBR-1500-00300-ENC	5 x 14 x 4	DBR-1500-00300-ENC	5 x 14 x 4
Maaa-01200033	0.75	DBR-1500-00300-P	10 x 3 x 3	DBR-1500-00300-ENC	5 x 14 x 4	DBR-1500-00300-ENC	5 x 14 x 4	DBR-1500-00300-ENC	5 x 14 x 4	DBR-1500-00300-ENC	5 x 14 x 4
Maaa-01200042	1	DBR-1500-00300-P	10 x 3 x 3	DBR-1500-00300-ENC	5 x 14 x 4	DBR-1500-00300-ENC	5 x 14 x 4	DBR-1500-00300-ENC	5 x 14 x 4	DBR-1500-00600-ENC	5 x 14 x 4
Maaa-02200024	0.5	DBR-0800-00300-P	10 x 3 x 3	DBR-0800-00300-ENC	5 x 14 x 4	DBR-0800-00300-ENC	5 x 14 x 4	DBR-0800-00300-ENC	5 x 14 x 4	DBR-0800-00300-ENC	5 x 14 x 4
Maaa-02200033	0.75	DBR-0800-00300-P	10 x 3 x 3	DBR-0800-00300-ENC	5 x 14 x 4	DBR-0800-00300-ENC	5 x 14 x 4	DBR-0800-00300-ENC	5 x 14 x 4	DBR-0800-00600-ENC	5 x 14 x 4
Maaa-02200042	1	DBR-0800-00300-P	10 x 3 x 3	DBR-0800-00300-ENC	5 x 14 x 4	DBR-0800-00300-ENC	5 x 14 x 4	DBR-0800-00300-ENC	5 x 14 x 4	DBR-0800-00600-ENC	5 x 14 x 4
Maaa-02200056	1.5	DBR-0800-00300-P	10 x 3 x 3	DBR-0800-00300-ENC	5 x 14 x 4	DBR-0800-00300-ENC	5 x 14 x 4	DBR-0800-00300-ENC	5 x 14 x 4	DBR-0800-00600-ENC	5 x 14 x 4
Maaa-02200075	2	DBR-0800-00300-P	10 x 3 x 3	DBR-0800-00300-ENC	5 x 14 x 4	DBR-0800-00300-ENC	5 x 14 x 4	DBR-0800-00600-ENC	5 x 14 x 7	DBR-0800-01500-ENC	5 x 14 x 13
Maaa-03200100	3	DBR-0800-00300-P	10 x 3 x 3	DBR-0500-00300-ENC	5 x 14 x 4	DBR-0500-00300-ENC	5 x 14 x 4	DBR-0500-01500-ENC	5 x 14 x 13	DBR-0500-01000-ENC	14 x 13 x 5
Maaa-04200133	3	DBR-0300-00400-P	12 x 3 x 1.5	DBR-0300-00400-ENC	5 x 14 x 4	DBR-0300-00600-ENC	5 x 14 x 7	DBR-0300-01500-ENC	5 x 14 x 4	DBR-0300-01500-ENC	5 x 14 x 4
Maaa-04200176	5	DBR-0300-00400-P	12 x 3 x 1.5	DBR-0200-00400-ENC	5 x 14 x 4	DBR-0200-00600-ENC	5 x 14 x 7	DBR-0200-01500-ENC	5 x 14 x 13	DBR-0200-03000-ENC	5 x 28 x 13
Mbbb-03200050	1	DBR-0500-00300-P	9 x 3 x 1.5	DBR-0500-00300-ENC	5 x 14 x 4	DBR-0500-00300-ENC	5 x 14 x 4	DBR-0500-00500-ENC	5 x 14 x 7	DBR-0500-01500-ENC	5 x 14 x 13
Mbbb-03200066	1.5	DBR-0500-00300-P	9 x 3 x 1.5	DBR-0500-00300-ENC	5 x 14 x 4	DBR-0500-00300-ENC	5 x 14 x 4	DBR-0500-00500-ENC	5 x 14 x 7	DBR-0500-01500-ENC	5 x 14 x 13
Mbbb-03200080	2	DBR-0500-00300-P	9 x 3 x 1.5	DBR-0500-00300-ENC	5 x 14 x 4	DBR-0500-00300-ENC	5 x 14 x 4	DBR-0500-00500-ENC	5 x 14 x 7	DBR-0500-01500-ENC	5 x 14 x 13
Mbbb-03200106	3	DBR-0500-00300-P	9 x 3 x 1.5	DBR-0400-00300-ENC	5 x 14 x 4	DBR-0400-00300-ENC	5 x 14 x 4	DBR-0350-01500-ENC	5 x 14 x 13	DBR-0350-01500-ENC	5 x 14 x 13
Mbbb-04200137	3	DBR-0300-00400-P	12 x 3 x 1.5	DBR-0200-00400-ENC	5 x 14 x 4	DBR-0200-00600-ENC	5 x 14 x 7	DBR-0200-01500-ENC	5 x 14 x 13	DBR-0200-01500-ENC	5 x 14 x 13
Mbbb-04200185	5	DBR-0300-00400-P	12 x 3 x 1.5	DBR-0200-00400-ENC	5 x 14 x 4	DBR-0200-00600-ENC	5 x 14 x 7	DBR-0200-01500-ENC	5 x 14 x 13	DBR-0200-03000-ENC	5 x 28 x 13
Mccc-05200250	7.5	DBR-0300-00400-P	12 x 3 x 1.5	DBR-0200-00400-ENC	5 x 14 x 4	DBR-0200-00600-ENC	5 x 14 x 7	DBR-0200-01500-ENC	5 x 14 x 13	DBR-0200-03000-ENC	5 x 28 x 13
Mccc-06200330	10			DBR-0100-00600-ENC	5 x 14 x 7	DBR-0100-00900-ENC	5 x 14 x 10	DBR-0100-03000-ENC	5 x 21 x 13	DBR-0100-04500-ENC	5 x 28 x 13
Mccc-06200440	15			DBR-0100-00600-ENC	5 x 14 x 7	DBR-0100-01200-ENC	5 x 14 x 10	DBR-0100-03000-ENC	5 x 21 x 13	DBR-0100-06000-ENC	7 x 29 x 18
Mccc-07200610	20			DBR-0055-02000-ENC	5 x 14 x 13	DBR-0055-02000-ENC	5 x 14 x 13	DBR-0055-04500-ENC	5 x 28 x 13	DBR-0055-09000-ENC	7 x 29 x 18
Mccc-07200750	25			DBR-0055-02000-ENC	5 x 14 x 13	DBR-0055-03000-ENC	5 x 21 x 13	DBR-0055-06000-ENC	7 x 29 x 18	DBR-0055-09000-ENC	7 x 29 x 18
Mccc-07200830	30			DBR-0055-02000-ENC	5 x 14 x 13	DBR-0055-03000-ENC	5 x 21 x 13	DBR-0055-06000-ENC	7 x 29 x 18	DBR-0055-12000-ENC	14 x 29 x 18
Mccc-08201160	40			DBR-0055-02000-ENC	5 x 14 x 13	DBR-0055-03000-ENC	5 x 21 x 13	DBR-0055-09000-ENC	7 x 29 x 18	DBR-0055-18000-ENC	14 x 29 x 18
Mccc-08201320	50			DBR-0055-02000-ENC	5 x 14 x 13	DBR-0055-04500-ENC	5 x 28 x 13	DBR-0055-12000-ENC	14 x 29 x 18	DBR-0055-18000-ENC	14 x 29 x 18
Mddd-09201760	60			DBR-0016-03000-ENC	5 x 21 x 10	DBR-0016-06000-ENC	5 x 28 x 13	DBR-0016-21000-ENC	16 x 29 x 18	DBR-0016-21000-ENC	23 x 29 x 18
Mddd-09202190	75			DBR-0016-03000-ENC	5 x 21 x 10	DBR-0016-06000-ENC	5 x 28 x 13	DBR-0016-15000-ENC	16 x 29 x 18	DBR-0016-27000-ENC	37 x 29 x 18
Meee-10202830	100			DBR-0022-05500-ENC	5 x 28 x 13	DBR-0022-12000-ENC	9 x 29 x 18	DBR-0022-21000-ENC	23 x 29 x 18	DBR-0022-48000-ENC	37 x 29 x 18
Meee-10203000	125			DBR-0022-05500-ENC	5 x 28 x 13	DBR-0022-12000-ENC	16 x 29 x 18	DBR-0022-27000-ENC	23 x 29 x 18	DBR-0022-48000-ENC	36 x 29 x 28

aaa = Unidrive M100, M101, M200, M201, M300, H530, M400
 bbb = Unidrive M600, M700, M701, M702, H570, H571, H572
 ccc = Unidrive M200, M201, M300, M400, M600, M700, M701, M702, H570, H571, H572
 ddd = Unidrive M200, M201, M300, M400, M600, M700, M701, M702
 eee = Unidrive M600, M700, M701, M702

Example: DBR-0400-00500-ENC is a 40.0 Ohm, 500 W Resistor, E = NEMA 1 Enclosure and NC = Normally Closed Thermostat
 Standard resistor assemblies are not UL recognized. Consult factory for UL versions.

Dynamic Braking Resistors

Dynamic Braking Resistors - 460 Vac Galvanized NEMA 1 Enclosed

Drives	Heavy Duty HP	E-Stop Duty Panel Mounted No Thermostat		E-Stop Duty - NEMA 1 Normally Closed Thermostat		10% Duty Rated Normally Closed Thermostat		25% Duty Rated Normally Closed Thermostat		50% Duty Rated Normally Closed Thermostat	
		Order Code	Dims. H x W x D (in)	Order Code	Dims. H x W x D (in)	Order Code	Dims. H x W x D (in)	Order Code	Dims. H x W x D (in)	Order Code	Dims. H x W x D (in)
Maaa-02400013	0.5	DBR-3000-00300-P	10 x 3 x 3	DBR-3000-00300-ENC	5 x 14 x 4	DBR-3000-00300-ENC	5 x 14 x 4	DBR-3000-00300-ENC	5 x 14 x 4	DBR-3000-00300-ENC	5 x 14 x 4
Maaa-02400018	0.75	DBR-3000-00300-P	10 x 3 x 3	DBR-3000-00300-ENC	5 x 14 x 4	DBR-3000-00300-ENC	5 x 14 x 4	DBR-3000-00300-ENC	5 x 14 x 4	DBR-3000-00300-ENC	5 x 14 x 4
Maaa-02400023	1	DBR-3000-00300-P	10 x 3 x 3	DBR-3000-00300-ENC	5 x 14 x 4	DBR-3000-00300-ENC	5 x 14 x 4	DBR-3000-00300-ENC	5 x 14 x 4	DBR-3000-00800-ENC	5 x 14 x 10
Maaa-02400032	1.5	DBR-3000-00300-P	10 x 3 x 3	DBR-3000-00300-ENC	5 x 14 x 4	DBR-3000-00300-ENC	5 x 14 x 4	DBR-3000-00300-ENC	5 x 14 x 4	DBR-3000-00800-ENC	5 x 14 x 10
Maaa-02400041	2	DBR-3000-00300-P	10 x 3 x 3	DBR-3000-00300-ENC	5 x 14 x 4	DBR-3000-00300-ENC	5 x 14 x 4	DBR-3000-00800-ENC	5 x 14 x 10	DBR-3000-00800-ENC	5 x 14 x 10
Maaa-03400056	3	DBR-1200-00300-P	9 x 3 x 1.5	DBR-1200-00300-ENC	5 x 14 x 4	DBR-1200-00300-ENC	5 x 14 x 4	DBR-1200-01500-ENC	5 x 14 x 13	DBR-1200-01500-ENC	5 x 14 x 13
Maaa-03400073	3	DBR-1200-00300-P	9 x 3 x 1.5	DBR-1200-00300-ENC	5 x 14 x 4	DBR-1200-00300-ENC	5 x 14 x 4	DBR-1200-01500-ENC	5 x 14 x 13	DBR-1200-01500-ENC	5 x 14 x 13
Maaa-03400094	5	DBR-1200-00300-P	9 x 3 x 1.5	DBR-1200-00300-ENC	5 x 14 x 7	DBR-1200-00800-ENC	5 x 14 x 7	DBR-1200-01500-ENC	5 x 14 x 13	DBR-1200-03000-ENC	5 x 13 x 21.1
Maaa-04400135	7.5	DBR-0600-00400-P	12 x 3 x 1.5	DBR-0600-00400-ENC	5 x 14 x 4	DBR-0600-01000-ENC	5 x 14 x 10	DBR-0600-01500-ENC	5 x 14 x 13	DBR-0600-03000-ENC	5 x 28 x 13
Maaa-04400170	10	DBR-0600-00400-P	12 x 3 x 1.5	DBR-0600-00400-ENC	5 x 14 x 4	DBR-0600-01000-ENC	5 x 14 x 10	DBR-0600-03000-ENC	5 x 28 x 13	DBR-0600-04500-ENC	7 x 29 x 18
Mbbb-03400025	1	DBR-0800-00300-P	10 x 3 x 3	DBR-0800-00300-ENC	5 x 14 x 4	DBR-0800-00300-ENC	5 x 14 x 4	DBR-0800-00600-ENC	5 x 14 x 7	DBR-0800-00600-ENC	5 x 14 x 7
Mbbb-03400031	1.5	DBR-0800-00300-P	10 x 3 x 3	DBR-0800-00300-ENC	5 x 14 x 4	DBR-0800-00300-ENC	5 x 14 x 4	DBR-0800-00600-ENC	5 x 14 x 7	DBR-0800-00600-ENC	5 x 14 x 7
Mbbb-03400045	2	DBR-0800-00300-P	10 x 3 x 3	DBR-0800-00300-ENC	5 x 14 x 4	DBR-0800-00300-ENC	5 x 14 x 4	DBR-0800-00600-ENC	5 x 14 x 7	DBR-0800-01500-ENC	5 x 14 x 13
Mbbb-03400062	3	DBR-0800-00300-P	10 x 3 x 3	DBR-0800-00300-ENC	5 x 14 x 4	DBR-0800-00300-ENC	5 x 14 x 4	DBR-0800-00600-ENC	5 x 14 x 7	DBR-0800-01500-ENC	5 x 14 x 13
Mbbb-03400078	5	DBR-0600-00400-P	12 x 3 x 1.5	DBR-0600-00400-ENC	5 x 14 x 4	DBR-0600-00600-ENC	5 x 14 x 7	DBR-0600-01500-ENC	5 x 14 x 13	DBR-0600-01500-ENC	5 x 14 x 13
Mbbb-03400100	5	DBR-0600-00400-P	12 x 3 x 1.5	DBR-0600-00400-ENC	5 x 14 x 4	DBR-0600-00600-ENC	5 x 14 x 7	DBR-0600-01500-ENC	5 x 14 x 13	DBR-0600-03000-ENC	5 x 28 x 13
Mbbb-04400150	10			DBR-0400-00500-ENC	5 x 14 x 7	DBR-0400-01000-ENC	5 x 14 x 10	DBR-0400-01500-ENC	5 x 14 x 13	DBR-0400-03000-ENC	5 x 21 x 13
Mbbb-04400172	10			DBR-0400-00500-ENC	5 x 14 x 7	DBR-0400-01000-ENC	5 x 14 x 10	DBR-0400-03000-ENC	5 x 21 x 13	DBR-0400-04500-ENC	5 x 28 x 13
Mccc-05400270	20			DBR-0400-01000-ENC	5 x 14 x 10	DBR-0400-01500-ENC	5 x 14 x 13	DBR-0400-03000-ENC	5 x 21 x 13	DBR-0400-06000-ENC	9 x 28 x 18
Mccc-05400300	20			DBR-0240-01500-ENC	5 x 14 x 13	DBR-0240-01500-ENC	5 x 14 x 13	DBR-0240-04500-ENC	7 x 29 x 18	DBR-0240-09000-ENC	7 x 29 x 18
Mccc-06400350	25			DBR-0200-01500-ENC	5 x 14 x 13	DBR-0200-01500-ENC	5 x 14 x 13	DBR-0200-04500-ENC	7 x 29 x 18	DBR-0200-09000-ENC	7 x 29 x 18
Mccc-06400420	30			DBR-0200-01500-ENC	5 x 14 x 13	DBR-0200-03000-ENC	5 x 28 x 13	DBR-0200-06000-ENC	7 x 29 x 18	DBR-0200-09000-ENC	7 x 29 x 18
Mccc-06400470	30			DBR-0200-01500-ENC	5 x 14 x 13	DBR-0200-03000-ENC	5 x 28 x 13	DBR-0200-06000-ENC	7 x 29 x 18	DBR-0200-12000-ENC	14 x 29 x 18
Mccc-07400660	50			DBR-0120-03000-ENC	5 x 21 x 13	DBR-0120-03000-ENC	5 x 21 x 13	DBR-0120-09000-ENC	7 x 29 x 18	DBR-0120-18000-ENC	14 x 29 x 18
Mccc-07400770	60			DBR-0120-03000-ENC	5 x 21 x 13	DBR-0120-03000-ENC	5 x 28 x 13	DBR-0120-12000-ENC	14 x 29 x 18	DBR-0120-18000-ENC	14 x 29 x 18
Mccc-07401000	75			DBR-0100-03000-ENC	5 x 21 x 13	DBR-0100-06000-ENC	7 x 29 x 18	DBR-0100-12000-ENC	14 x 29 x 18	DBR-0100-24000-ENC	14 x 29 x 18
Mccc-08401340	100			DBR-0100-04500-ENC	5 x 28 x 13	DBR-0100-06000-ENC	7 x 29 x 18	DBR-0100-18000-ENC	14 x 29 x 18	DBR-0100-36000-ENC	21 x 29 x 18
Mccc-08401570	125			DBR-0100-06000-ENC	7 x 29 x 18	DBR-0100-09000-ENC	7 x 29 x 18	DBR-0100-24000-ENC	14 x 29 x 18	DBR-0100-36000-ENC	21 x 29 x 18
Mddd-09402000	150			DBR-0055-06000-ENC	7 x 29 x 18	DBR-0055-12000-ENC	14 x 29 x 18	DBR-0055-24000-ENC	14 x 29 x 18	DBR-0055-50000-ENC	28 x 29 x 18
Mddd-09402240	150			DBR-0055-09000-ENC	7 x 29 x 18	DBR-0055-12000-ENC	14 x 29 x 18	DBR-0055-24000-ENC	14 x 29 x 18	DBR-0055-50000-ENC	28 x 29 x 18
Meee-10402700	200			DBR-0055-12000-ENC	14 x 29 x 18	DBR-0055-18000-ENC	14 x 29 x 18	DBR-0055-36000-ENC	21 x 29 x 18	DBR-0055-60000-ENC	35 x 29 x 18
Meee-10403200	250			DBR-0055-12000-ENC	14 x 29 x 18	DBR-0055-24000-ENC	14 x 29 x 18				
Meee-11403770	300			DBR-0022-12000-ENC	16 x 29 x 18	DBR-0022-18000-ENC	16 x 29 x 18				
Meee-11404170	350			DBR-0022-12000-ENC	16 x 29 x 18	DBR-0022-21000-ENC	30 x 29 x 18				
Meee-11404640	400			DBR-0016-15000-ENC	16 x 29 x 18	DBR-0016-27000-ENC	37 x 29 x 18				
											N/A

aaa = Unidrive M100, M101, M200, M201, M300, H530, M400
 bbb = Unidrive M600, M700, M701, M702, H570, H571, H572
 ccc = Unidrive M200, M201, M300, M400, M600, M700, M701, M702, H570, H571, H572
 ddd = Unidrive M200, M201, M300, M400, M600, M700, M701, M702
 eee = Unidrive M600, M700, M701, M702

Example: DBR-0400-00500-ENC is a 40.0 Ohm, 500 W Resistor, E = NEMA 1 Enclosure and NC = Normally Closed Thermostat
 Standard resistor assemblies are not UL recognized. Consult factory for UL versions.

Dynamic Braking Resistors

Dynamic Braking Resistors - 575 Vac

Galvanized NEMA 1 Enclosed

Drives	Heavy Duty HP	E-Stop Duty - NEMA 1 Normally Closed Thermostat		10% Duty Rated Normally Closed Thermostat		25% Duty Rated Normally Closed Thermostat		50% Duty Rated Normally Closed Thermostat	
		Order Code	Dims. H x W x D (in)	Order Code	Dims. H x W x D (in)	Order Code	Dims. H x W x D (in)	Order Code	Dims. H x W x D (in)
Mccc-05500030	2	DBR-1200-00300-ENC	5 x 14 x 4	DBR-1200-00300-ENC	5 x 14 x 4	DBR-1200-00800-ENC	5 x 14 x 7	DBR-1200-00800-ENC	5 x 14 x 7
Mccc-05500040	3	DBR-1200-00300-ENC	5 x 14 x 4	DBR-1200-00300-ENC	5 x 14 x 4	DBR-1200-00800-ENC	5 x 14 x 7	DBR-1200-01500-ENC	5 x 14 x 13
Mccc-05500069	5	DBR-1200-00300-ENC	5 x 14 x 4	DBR-1200-00800-ENC	5 x 14 x 7	DBR-1200-01500-ENC	5 x 14 x 13	DBR-1200-01500-ENC	5 x 14 x 13
Mccc-06500100	7.5	DBR-0800-00300-ENC	5 x 14 x 4	DBR-0800-00600-ENC	5 x 14 x 7	DBR-0800-01500-ENC	5 x 14 x 13	DBR-0600-03000-ENC	5 x 28 x 13
Mccc-06500150	10	DBR-0600-00400-ENC	5 x 14 x 4	DBR-0600-01500-ENC	5 x 14 x 13	DBR-0600-03000-ENC	5 x 28 x 13	DBR-0400-04500-ENC	5 x 28 x 13
Mccc-06500190	15	DBR-0400-00500-ENC	5 x 14 x 7	DBR-0400-01500-ENC	5 x 14 x 13	DBR-0400-03000-ENC	5 x 21 x 13	DBR-0400-06000-ENC	9 x 28 x 18
Mccc-06500230	20	DBR-0200-01500-ENC	5 x 14 x 13	DBR-0200-01500-ENC	5 x 14 x 13	DBR-0200-04500-ENC	7 x 29 x 18	DBR-0200-09000-ENC	7 x 29 x 18
Mccc-06500290	25	DBR-0200-01500-ENC	5 x 14 x 13	DBR-0200-03000-ENC	5 x 28 x 13	DBR-0200-04500-ENC	7 x 29 x 18	DBR-0200-09000-ENC	7 x 29 x 18
Mccc-06500350	30	DBR-0150-01500-ENC	5 x 14 x 13	DBR-0150-03000-ENC	5 x 21 x 13	DBR-0150-06000-ENC	7 x 29 x 18	DBR-0150-12000-ENC	14 x 29 x 18
Mccc-07500440	40	DBR-0150-01500-ENC	5 x 14 x 13	DBR-0150-03000-ENC	5 x 21 x 13	DBR-0150-06000-ENC	7 x 29 x 18	DBR-0150-12000-ENC	14 x 29 x 18
Mccc-07500550	50	DBR-0150-03000-ENC	5 x 21 x 13	DBR-0150-03000-ENC	5 x 21 x 13	DBR-0150-09000-ENC	7 x 29 x 18	DBR-0150-18000-ENC	14 x 29 x 18
Mccc-08500630	60	DBR-0150-03000-ENC	5 x 21 x 13	DBR-0150-04500-ENC	5 x 28 x 13	DBR-0150-12000-ENC	14 x 29 x 18	DBR-0150-18000-ENC	14 x 29 x 18
Mccc-08500860	75	DBR-0150-03000-ENC	5 x 21 x 13	DBR-0150-06000-ENC	7 x 29 x 18	DBR-0150-12000-ENC	14 x 29 x 18	DBR-0150-24000-ENC	21 x 29 x 18
Mddd-09501040	100	DBR-0120-04500-ENC	5 x 28 x 13	DBR-0120-06000-ENC	7 x 29 x 18	DBR-0120-18000-ENC	14 x 29 x 18	DBR-0120-36000-ENC	21 x 29 x 18
Mddd-09501310	125	DBR-0120-04500-ENC	5 x 28 x 13	DBR-0120-09000-ENC	7 x 29 x 18	DBR-0120-24000-ENC	14 x 29 x 18	DBR-0120-36000-ENC	21 x 29 x 18
Meee-10501520	150	DBR-0055-06000-ENC	7 x 29 x 18	DBR-0055-12000-ENC	14 x 29 x 18				
Meee-10501900	200	DBR-0055-06000-ENC	7 x 29 x 18	DBR-0055-18000-ENC	14 x 29 x 18				
Meee-11502000	200	DBR-0022-12000-ENC	16 x 29 x 18	DBR-0022-21000-ENC	30 x 29 x 18			N/A	
Meee-11502540	250	DBR-0022-12000-ENC	16 x 29 x 18	DBR-0022-21000-ENC	30 x 29 x 18				
Meee-11502850	300	DBR-0022-12000-ENC	16 x 29 x 18	DBR-0022-27000-ENC	37 x 29 x 18				

ccc = Unidrive M200, M201, M300, M400, M600, M700, M701, M702, HS70, HS71, HS72
ddd = Unidrive M200, M201, M300, M400, M600, M700, M701, M702
eee = Unidrive M600, M700, M701, M702

Example: DBR-0200-00600-ENC is a 20.0 Ohm, 600 W Resistor,
E = NEMA 1 Enclosure and NC = Normally Closed Thermostat
Standard resistor assemblies are not UL recognized.
Consult factory for UL versions.

Dynamic Braking Resistors

UL Recognized

Description	UL Recognized Continuous 100%	Order Code	Dimensions H x W x D (in)			Weight (lbs)	
300 W, 20 Ohm	250W	1220-0003020	2.4	8.5	1.2	1.5	
300 W, 50 Ohm		1220-0003050	2.4	8.5	1.2	1.5	
300 W, 68 Ohm		1220-0003068	2.4	8.5	1.2	1.5	
300 W, 80 Ohm		1220-0003080	2.4	8.5	1.2	1.5	
300 W, 100 Ohm		1220-0003100	2.4	8.5	1.2	1.5	
300 W, 135 Ohm		1220-0003135	2.4	8.5	1.2	1.5	
300 W, 270 Ohm		1220-0003270	2.4	8.5	1.2	1.5	
500 W, 20 Ohm	400W	1220-0005020	2.4	13.3	1.2	2.4	
500 W, 50 Ohm		1220-0005050	2.4	13.3	1.2	2.4	
500 W, 68 Ohm		1220-0005068	2.4	13.3	1.2	2.4	
500 W, 80 Ohm		1220-0005080	2.4	13.3	1.2	2.4	
500 W, 100 Ohm		1220-0005100	2.4	13.3	1.2	2.4	
500 W, 270 Ohm		1220-0005270	2.4	13.3	1.2	2.4	
1000 W, 20 Ohm		500W	1220-0010020	5.6	14.3	4.9	4.0
1000 W, 40 Ohm	1220-0010040		5.6	14.3	4.9	4.0	
1000 W, 50 Ohm	1220-0010050		5.6	14.3	4.9	4.0	
1000 W, 80 Ohm	1220-0010080		5.6	14.3	4.9	4.0	
1000 W, 100 Ohm	1220-0010100		5.6	14.3	4.9	4.0	
1500 W, 20 Ohm	1125W		1220-0015020	5.6	17.3	4.9	4.9
1500 W, 40 Ohm			1220-0015040	5.6	17.3	4.9	4.9
1500 W, 50 Ohm		1220-0015050	5.6	17.3	4.9	4.9	
1500 W, 100 Ohm	1700W	1220-0015100	5.6	17.3	4.9	4.9	
2000 W, 20 Ohm		1220-0020020	5.6	14.3	7.3	6.6	
2000 W, 40 Ohm		1220-0020040	5.6	14.3	7.3	6.6	
2000 W, 50 Ohm		1220-0020050	5.6	14.3	7.3	6.6	
2000 W, 100 Ohm		1220-0020100	5.6	14.3	7.3	6.6	
4500 W, 9 Ohm		2250W	1220-0045009	5.6	17.3	12.2	11.9
4500 W, 20 Ohm			1220-0045020	5.6	17.3	12.2	11.9
4500 W, 40 Ohm	1220-0045040		5.6	17.3	12.2	11.9	
6000 W, 9 Ohm	3000W	1220-0060009	5.6	17.3	14.6	15.4	
6000 W, 20 Ohm		1220-0060020	5.6	17.3	14.6	15.4	
6000 W, 40 Ohm		1220-0060040	5.6	17.3	14.6	15.4	

Hardware Options

NEMA 1 Conduit Kits

Description	Order Code	Product Compatibility		
		M100, HS30	M200-M400	M600, M700, HS70
NEMA 1 Conduit Kit for Unidrive M100-M400, HS30 - Size 1	C-BOX-OF1	Y	Y	
NEMA 1 Conduit Kit for Unidrive M100-M400, HS30 - Size 2	C-BOX-OF2	Y	Y	
NEMA 1 Conduit Kit for Unidrive M100-M400, HS30 - Size 3	C-BOX-OF3	Y	Y	
NEMA 1 Conduit Kit for Unidrive M100-M400, HS30 - Size 4	C-BOX-OF4	Y	Y	
NEMA 1 Conduit Kit for Unidrive M600-M702, HS70-HS72 - Size 3 and 4	C-BOX-GF3-4			Y
NEMA 1 Conduit Kit for Unidrive M - Size 5	C-BOX-F5		Y	Y
NEMA 1 Conduit Kit for Unidrive M - Size 6	C-BOX-F6		Y	Y
NEMA 1 Conduit Kit for Unidrive M - Size 7	C-BOX-F7		Y	Y
NEMA 1 Conduit Kit for Unidrive M - Size 8	C-BOX-F8		Y	Y
NEMA 1 Conduit Kit for Unidrive M - Size 9 & 10	C-BOX-F9-10		Y	Y
NEMA 1 Conduit Kit for Unidrive M - Size 11	C-BOX-F11			Y

Through Hole Panel Mount Kits (IP65 for Frames 3-8, IP55 for Frames 9-11)

Description	Order Code	Product Compatibility	
		M200-M400	M600, M700, HS70
Through Hole Mount Kit for Unidrive M600-M702, HS70-HS72 - Size 3	THM-KIT-F3		Y
Through Hole Mount Kit for Unidrive M600-M702, HS70-HS72 - Size 4	THM-KIT-F4		Y
Through Hole Mount Kit for Unidrive M - Size 5	THM-KIT-F5	Y	Y
Through Hole Mount Kit for Unidrive M - Size 6	THM-KIT-F6	Y	Y
Through Hole Mount Kit for Unidrive M - Size 7	THM-KIT-F7	Y	Y
Through Hole Mount Kit for Unidrive M - Size 8	THM-KIT-F8	Y	Y
Through Hole Mount Kit for Unidrive M - Size 9A	THM-KIT-F9	Y	Y
Through Hole Mount Kit for Unidrive M - Size 9E & 10E	THM-KIT-F9E-F10E	Y	Y
Through Hole Mount Kit for Unidrive M - Size 9T & 10T	THM-KIT-F9T-F10T	Y	Y
Through Hole Mount Kit for Unidrive M - Size 11	THM-KIT-F11		Y
Through Hole Mount Kit for Unidrive M Modular Rectifier - Size 10R	THM-KIT-F9R-F10R		Y
Through Hole Mount Kit for Unidrive M Modular Inverter - Size 9D & 10D	THM-KIT-F9D-F10D		Y
Through Hole Mount Kit for Unidrive M Modular Rectifier - Size 11R	THM-KIT-F11R		Y
Through Hole Mount Kit for Unidrive M Modular Inverter - Size 11D	THM-KIT-F11D		Y

Tile Mount Kits (Order REMOTE-KEYPAD-RTC and UM-LCD-485-xxx* Cable Separately)

Description	Order Code	Product Compatibility	
		M200-M400	M600, M700, HS70
Tile Mount Kit for Unidrive M600-M702, HS70-HS72 - Size 3	TILEM-KIT-F3		Y
Tile Mount Kit for Unidrive M600-M702, HS70-HS72 - Size 4	TILEM-KIT-F4		Y
Tile Mount Kit for Unidrive M - Size 5	TILEM-KIT-F5	Y	Y

*xxx = length in feet (330 ft maximum length)

DC Paralleling Kits

Description	Order Code	Product Compatibility	
		M200- M400	M600, M700, HS70
DC Paralleling Kit Unidrive M600-M702, HS70-HS72 Frame 3	DCP-KIT-F3		Y
DC Paralleling Kit Unidrive M600-M702, HS70-HS72 Frame 4	DCP-KIT-F4		Y
DC Paralleling Kit Unidrive M Frame 5	DCP-KIT-F5	Y**	Y
DC Paralleling Kit Unidrive M Frame 6	DCP-KIT-F6	Y**	Y
DC Paralleling Kit Unidrive M Frame 6 to frames 3, 4 & 5 vw(valid for M200-M400 frames 5-6, M600-M702 frames 3-6)	DCP-KIT-F6-TO-F3-5	Y**	Y

**Can only be paralleled with an M600-M702 mounted to the left of an M200-M400.

Hardware Options

Connector Options

Description	Order Code	Product Compatibility
		M600, M700, HS70
I/O Commissioning Adaptor for Unidrive M600-M702, HS70-HS72	3000-0009	Y
3-Way Power Connector Kit for M600-M702, HS70-HS72 for Frames 3 & 4	3470-0064	Y
Encoder P1 & P2 Splitter Cable, 1 ft Length	UM-YCABLE-001	Y

Retrofit Kits for Unidrive M or Unidrive SP

Description	Order Code	Product Compatibility		
		M100, HS30	M200-M400	M600, M700, HS70
Frame 3 Retrofit Panel Mounting Kit for Unidrive M100-M400, HS30	3470-0097	Y	Y	
Frame 4 Retrofit Panel Mounting Kit for Unidrive M100-M400, HS30	3470-0101	Y	Y	
Frame 4 Retrofit Panel Mounting Kit for Unidrive M600-M702, HS70-HS72	3470-0062			Y
Frame 5 Retrofit Panel Mounting Kit	3470-0066		Y	Y
Frame 6 Retrofit Panel Mounting Kit	3470-0074		Y	Y
Frame 7 Retrofit Panel Mounting Kit	3470-0078		Y	Y
Frame 8 Retrofit Panel Mounting Kit	3470-0087		Y	Y
Frame 9A, 9E, 10 Retrofit Panel Mounting Kit	3470-0118		Y	Y

Cable Grommet Kits

Description	Order Code	Product Compatibility	
		M200-M400	M600, M700, HS70
Frame 7 Cable Grommet Kit	3470-0086	Y	Y
Frame 8 Cable Grommet Kit, Single	3470-0089	Y	Y
Frame 8 Cable Grommet Kit, Dual Header	3470-0090	Y	Y
Frame 9A, 9E, 9T, 10, 11 Cable Grommet Kit	3470-0107	Y	Y

Heatsink Mount Dynamic Braking Resistors

Description	Order Code	Product Compatibility	
		M200-M400	M600, M700, HS70
M600-M702, HS70-HS72 Frame 3 Heatsink Mount DB Resistor, 75 Ohm, 50 W	UM-HEATSINK-F3		Y
M600-M702, HS70-HS72 Frame 4 & 5 Heatsink Mount DB Resistor, 37.5 Ohm, 100 W	UM-HEATSINK-F4-5	Frame size 5 only	Y

Heatsink and Auxiliary Replacement Fans

Description	Order Code	Product Compatibility		
		M100, HS30	M200-M400	M600, M700, HS70
M100-M400, HS30 Fan Replacement Kit Fr 1	3470-0092	Y	Y	
M100-M400, HS30 Fan Replacement Kit Fr 2	3470-0095	Y	Y	
M100-M400, HS30 Fan Replacement Kit Fr 3	3470-0099	Y	Y	
M100-M400, HS30 Fan Replacement Kit Fr 4	3470-0103	Y	Y	
M600-M702, HS70 Fan Replacement Fr 3	3251-0029			Y
M600-M702, HS70 Fan Replacement Fr 4	3251-0245			Y
M200-M702, HS70 Fan Replacement Fr 5	3251-0245		Y	Y
M200-M702, HS70 Fan Replacement Fr 6	3251-0030		Y	Y
M200-M702, HS70 Fan Replacement Fr 7	3251-8247		Y	Y
M200-M702, HS70 Fan Replacement Fr 8	3251-8240		Y	Y
M200-M702 Fan Replacement Fr 9, 10, 11	3251-1750		Y	Y
Aux Fan Replacement Fr 7	3251-0041		Y	Y
Aux Fan Replacement Fr 8	3251-0091		Y	Y
Aux Fan Replacement Fr 9 & 10 (All voltage models), Fr 11 (575 V and 690 V models)	3251-0042		Y	Y
Aux Fan Replacement Fr 11 (400 V models)	3251-1202			Y
Rectifier Fan Replacement Fr 10	3251-8241			Y
Rectifier Fan Replacement Fr 11	3251-0030			Y

CONTROL TECHNIQUES™

www.controltechniques.com

Connect with us at:

[Twitter.com/Nidec_CTA](https://twitter.com/Nidec_CTA)

[Facebook.com/NidecCTA](https://facebook.com/NidecCTA)

[Youtube.com/nideccontroltechniques-americas](https://youtube.com/nideccontroltechniques-americas)

[Linkedin.com/company/control-techniques](https://linkedin.com/company/control-techniques)

Theautomationengineer.com (blog)



©2018 Control Techniques a Nidec Motor Corporation business. The information contained in this brochure is for guidance only and does not form part of any contract. The accuracy cannot be guaranteed as Control Techniques has an ongoing process of development and reserves the right to change the specifications of its products without notice. Unidrive and Control Techniques are registered marks of Nidec Control Techniques Limited in the USA.

Control Techniques
7078 Shady Oak Road Eden Prairie, MN 55344-3505 USA